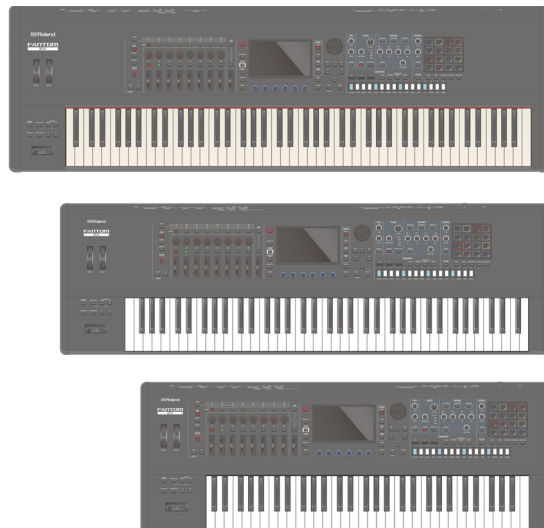


# FANTOM 6 EX

# FANTOM 7 EX

# FANTOM 8 EX

Owner's Manual FANTOM EX Ver.1.0



English

日本語

Deutsch

Français

Italiano

Español

Português

Nederlands

## Contents

<b>USING THE UNIT SAFELY</b> .....	<b>2</b>	<b>Editing</b> .....	<b>14</b>
<b>IMPORTANT NOTES</b> .....	<b>4</b>	Editing a zone .....	14
<b>Panel descriptions</b> .....	<b>5</b>	Editing a tone .....	14
Top panel .....	5	Editing the effects .....	14
Rear panel (connecting the external equipment) .....	7	Saving a scene or tone .....	15
<b>Introduction</b> .....	<b>8</b>	Recalling scenes in the order of songs (scene chain) .....	15
Turning on the power .....	8	<b>Sampler</b> .....	<b>16</b>
Turning off the power .....	8	Playing a sample by pressing a pad .....	16
Making the power automatically turn off after a time (Auto Off) .....	8	Playing a sample continuously (hold) .....	16
Basic operation .....	9	Switching banks .....	16
An overview of this unit .....	11	Moving/copying samples .....	16
Units of sound .....	11	Sampling .....	17
<b>Performing</b> .....	<b>12</b>	<b>Sequencer</b> .....	<b>18</b>
Selecting a sound (SCENE/TONE) .....	12	How the sequencer is structured .....	18
Layering zones (layer) .....	12	Playing the sequencer .....	18
Dividing the keyboard into two regions (split) .....	12	Recording a pattern .....	19
Raising/lowering the key range in semitones (transpose) .....	12	Creating a group .....	21
Raising/lowering the key range in octaves (octave) .....	12	Creating a song .....	21
Playing arpeggios .....	12	<b>Control</b> .....	<b>22</b>
Playing chords (chord memory) .....	13	Performing live with a plug-in synthesizer .....	22
Selecting/playing rhythm patterns .....	13	Connecting to your computer .....	22
Changing the tempo .....	13	USB driver settings .....	22
Using the sliders and control knobs .....	13	Controlling an external MIDI device (EXT MIDI OUT) .....	22
Using the analog filter .....	13	Using USB audio .....	22
Simultaneously modifying the volume of multiple zones (motional pad) .....	13	Setting the ZONE INT/EXT button (zone int/ext control) .....	23
		Controlling an analog synthesizer (CV/GATE OUT) .....	23
		<b>Settings</b> .....	<b>24</b>
		Detailed function settings (menu) .....	24
		Backing up user data (backup/restore) .....	24
		Returning to the factory settings (factory reset) .....	24
		Main specifications .....	24

### Owner's Manual (this document)

Read this first. It explains the basic things you need to know in order to use the FANTOM.

### PDF Manual (download from the Web)

- **Reference Manual (English)**  
This explains all functions of the FANTOM.
- **Parameter Guide (English)**  
This explains all parameters of the FANTOM.
- **MIDI Implementation (English)**  
This is detailed information about MIDI messages.

### To obtain the PDF manual

1. Enter the following URL in your computer.  
<http://www.roland.com/manuals/>





2. Choose "FANTOM-6EX", "FANTOM-7EX", or "FANTOM-8EX"




# USING THE UNIT SAFELY

## INSTRUCTIONS FOR THE PREVENTION OF FIRE, ELECTRIC SHOCK, OR INJURY TO PERSONS

### About ⚠ WARNING and ⚠ CAUTION Notices

 <b>WARNING</b>	Used for instructions intended to alert the user to the risk of death or severe injury should the unit be used improperly.
 <b>CAUTION</b>	Used for instructions intended to alert the user to the risk of injury or material damage should the unit be used improperly. * Material damage refers to damage or other adverse effects caused with respect to the home and all its furnishings, as well to domestic animals or pets.

### About the Symbols

	The ⚠ symbol alerts the user to important instructions or warnings. The specific meaning of the symbol is determined by the design contained within the triangle. In the case of the symbol at left, it is used for general cautions, warnings, or alerts to danger.
	The ⚡ symbol alerts the user to items that must never be carried out (are forbidden). The specific thing that must not be done is indicated by the design contained within the circle. In the case of the symbol at left, it means that the unit must never be disassembled.
	The Ⓢ symbol alerts the user to things that must be carried out. The specific thing that must be done is indicated by the design contained within the circle. In the case of the symbol at left, it means that the power-cord plug must be unplugged from the outlet.

## ALWAYS OBSERVE THE FOLLOWING

### WARNING

#### Make sure that the power cord is grounded

Connect mains plug of this model to a mains socket outlet with a protective earthing connection.



#### To completely turn off power to the unit, pull out the plug from the outlet

Even with the power switch turned off, this unit is not completely separated from its main source of power. When the power needs to be completely turned off, turn off the power switch on the unit, then pull out the plug from the outlet. For this reason, the outlet into which you choose to connect the power cord's plug should be one that is within easy reach and readily accessible.



#### Concerning the Auto Off function

The power to this unit will be turned off automatically after a predetermined amount of time has passed since it was last used for playing music, or its buttons or controls were operated (Auto Off function). If you do not want the power to be turned off automatically, disengage the Auto Off function (p. 8).



#### Do not disassemble or modify by yourself

Do not carry out anything unless you are instructed to do so in the owner's manual. Otherwise, you risk causing malfunction.



#### Do not repair or replace parts by yourself

Be sure to contact your dealer, a Roland service center, or an official Roland dealer.

For a list of Roland service centers and official Roland dealers, refer to the Roland website.



### WARNING

#### Do not use or store in the following types of locations

- Subject to temperature extremes (e.g., direct sunlight in an enclosed vehicle, near a heating duct, on top of heat-generating equipment); or are
- Damp (e.g., baths, washrooms, on wet floors); or are
- Exposed to steam or smoke; or are
- Subject to salt exposure; or are
- Exposed to rain; or are
- Dusty or sandy; or are
- Subject to high levels of vibration and shakiness; or are
- Placed in a poorly ventilated location.



#### Use only the stand that is recommended

This unit should be used only with a stand that is recommended by Roland.



#### Do not place in a location that is unstable

When using the unit with a stand recommended by Roland, the stand must be carefully placed so it is level and sure to remain stable. If not using a stand, you still need to make sure that any location you choose for placing the unit provides a level surface that will properly support the unit, and keep it from wobbling.



#### Precautions regarding placement of this unit on a stand

Be sure to follow the instructions in the Owner's Manual carefully when placing this unit on a stand (\*2).

If it is not set up properly, you risk creating an unstable situation which could lead to the unit falling or the stand toppling, and may result in injury.



#### Connect the power cord to an outlet of the correct voltage

The unit should be connected to a power supply only of the type described as marked on the rear side of unit.



### WARNING

#### Use only the supplied power cord

Use only the attached power cord. Also, the supplied power cord must not be used with any other device.



#### Do not bend the power cord or place heavy objects on it

Otherwise, fire or electric shock may result.



#### Avoid extended use at high volume

Use of the unit at high volume for extended periods of time may cause hearing loss. If you ever experience any hearing loss or ringing in the ears, you should immediately stop using the unit and consult a specialized physician.



#### Do not allow foreign objects or liquids to enter unit; never place containers with liquid on unit

Do not place containers containing liquid (e.g., flower vases) on this product. Never allow foreign objects (e.g., flammable objects, coins, wires) or liquids (e.g., water or juice) to enter this product. Doing so may cause short circuits, faulty operation, or other malfunctions.



#### Turn off the unit if an abnormality or malfunction occurs

In the following cases, immediately turn off the power, remove the power cord from the outlet, and contact your dealer, a Roland service center, or an official Roland dealer for service.



- The power cord has been damaged; or
- If smoke or unusual odor occurs; or
- Objects have fallen into, or liquid has been spilled onto the unit; or
- The unit has been exposed to rain (or otherwise has become wet); or
- The unit does not appear to operate normally or exhibits a marked change in performance.

For a list of Roland service centers and official Roland dealers, refer to the Roland website.

**WARNING**

**Be cautious to protect children from injury**

Always make sure that an adult is on hand to provide supervision and guidance when using the unit in places where children are present, or when a child will be using the unit.



**Do not drop or subject to strong impact**

Otherwise, you risk causing damage or malfunction.



**Do not share an outlet with an unreasonable number of other devices**

Otherwise, you risk overheating or fire.



**Do not use overseas**

Before using the unit in overseas, consult with your retailer, the nearest Roland service center, or an authorized Roland distributor.



For a list of Roland service centers and official Roland dealers, refer to the Roland website.

**Don't place burning objects on the unit**

Don't place any burning object (such as a candle) on the unit.



**Be aware of weather conditions**

Use the apparatus in moderate climates.



**CAUTION**

**Use only the specified stand(s)**

This unit is designed to be used in combination with specific stands (\*1) manufactured by Roland. If used in combination with other stands, you risk sustaining injuries as the result of this product dropping down or toppling over due to a lack of stability.



**Evaluate safety issues before using stands**

Even if you observe the cautions given in the owner's manual, certain types of handling may allow this product to fall from the stand, or cause the stand to overturn. Please be mindful of any safety issues before using this product.



**When disconnecting the power cord, grasp it by the plug**

To prevent conductor damage, always grasp the power cord by its plug when disconnecting it.



**Periodically clean the power plug**

An accumulation of dust or foreign objects between the power plug and the power outlet can lead to fire or electric shock.



At regular intervals, be sure to pull out the power plug, and using a dry cloth, wipe away any dust or foreign objects that may have accumulated.

**Disconnect the power plug whenever the unit will not be used for an extended period of time**

Fire may result in the unlikely event that a breakdown occurs.



**Route all power cords and cables in such a way as to prevent them from getting entangled**

Injury could result if someone were to trip on a cable and cause the unit to fall or topple.



**Avoid climbing on top of the unit, or placing heavy objects on it**

Otherwise, you risk injury as the result of the unit toppling over or dropping down.



**Never connect/disconnect a power plug if your hands are wet**

Otherwise, you could receive an electric shock.



**Disconnect all cords/cables before moving the unit**

Before moving the unit, disconnect the power plug from the outlet, and pull out all cords from external devices.



**CAUTION**

**Cautions when moving this unit**

If you need to move the instrument, take note of the precautions listed below. At least two persons are required to safely lift and move the unit. It should be handled carefully, all the while keeping it level. Make sure to have a firm grip, to protect yourself from injury and the instrument from damage.



- Disconnect the power cord.
- Disconnect all cords coming from external devices.

**Before cleaning the unit, disconnect the power plug from the outlet**

If the power plug is not removed from the outlet, you risk receiving an electric shock.



**Whenever there is a threat of lightning, disconnect the power plug from the outlet**

If the power plug is not removed from the outlet, you risk causing malfunction or receiving an electric shock.



**Precautions concerning use of phantom power supply**

Always turn the phantom power off when connecting any device other than condenser microphones that require phantom power. You risk causing damage if you mistakenly supply phantom power to dynamic microphones, audio playback devices, or other devices that don't require such power. Be sure to check the specifications of any microphone you intend to use by referring to the manual that came with it.



(This instrument's phantom power: 48 V DC, 10 mA Max)

English

日本語

Deutsch

Français

Italiano

Español

Português

Nederlands

\*1 FANTOM-6EX, FANTOM-7EX: KS-10Z / KS-12, FANTOM-8EX: KS-10Z / KS-12 / KS-G8B  
 \*2 For details on how to place this unit on a stand, refer to "Reference Manual" (PDF).

# IMPORTANT NOTES

## Power Supply

- Do not connect this unit to same electrical outlet that is being used by an electrical appliance that is controlled by an inverter or a motor (such as a refrigerator, washing machine, microwave oven, or air conditioner). Depending on the way in which the electrical appliance is used, power supply noise may cause this unit to malfunction or may produce audible noise. If it is not practical to use a separate electrical outlet, connect a power supply noise filter between this unit and the electrical outlet.

## Placement

- Using the unit near power amplifiers (or other equipment containing large power transformers) may induce hum. To alleviate the problem, change the orientation of this unit; or move it farther away from the source of interference.
- This unit may interfere with radio and television reception. Do not use this unit in the vicinity of such receivers.
- Noise may be produced if wireless communications devices, such as cell phones, are operated in the vicinity of this unit. Such noise could occur when receiving or initiating a call, or while conversing. Should you experience such problems, you should relocate such wireless devices so they are at a greater distance from this unit, or switch them off.
- When moved from one location to another where the temperature and/or humidity is very different, water droplets (condensation) may form inside the unit. Damage or malfunction may result if you attempt to use the unit in this condition. Therefore, before using the unit, you must allow it to stand for several hours, until the condensation has completely evaporated.
- Do not allow objects to remain on top of the keyboard. This can be the cause of malfunction, such as keys ceasing to produce sound.
- Depending on the material and temperature of the surface on which you place the unit, its rubber feet may discolor or mar the surface.
- Do not place containers or anything else containing liquid on top of this unit. Also, whenever any liquid has been spilled on the surface of this unit, be sure to promptly wipe it away using a soft, dry cloth.

## Maintenance

- Never use benzene, thinners, alcohol or solvents of any kind, to avoid the possibility of discoloration and/or deformation.

## Care of the Keyboard

FANTOM-8EX only

- Do not write on the keyboard with any pen or other implement, and do not stamp or place any marking on the instrument. Ink will seep into the surface lines and become unremovable.
- Do not affix stickers on the keyboard. You may be unable to remove stickers that use strong adhesives, and the adhesive may cause discoloration.
- To remove stubborn dirt, use a commercially available keyboard cleaner that does not contain abrasives. Start by wiping lightly. If the dirt does not come off, wipe using gradually increasing amounts of pressure while taking care not to scratch the keys.

## Repairs and Data

- Before sending the unit away for repairs, be sure to make a backup of the data stored within it; or you may prefer to write down the needed information. Although we will do our utmost to preserve the data stored in your unit when we carry out repairs, in some cases, such as when the memory section is physically damaged, restoration of the stored content may be impossible. Roland assumes no liability concerning the restoration of any stored content that has been lost.

## Additional Precautions

- Any data stored within the unit can be lost as the result of equipment failure, incorrect operation, etc. To protect yourself against the irretrievable loss of data, be sure to make a backup of the data stored within it; or you may prefer to write down the needed information.
- Roland assumes no liability concerning the restoration of any stored content that has been lost.
- Use a reasonable amount of care when using the unit's buttons, sliders, or other controls; and when using its jacks and connectors. Rough handling can lead to malfunctions.
- Never strike or apply strong pressure to the display.
- When disconnecting all cables, grasp the connector itself—never pull on the cable. This way you will avoid causing shorts, or damage to the cable's internal elements.
- A small amount of heat will radiate from the unit during normal operation.
- To avoid disturbing others nearby, try to keep the unit's volume at reasonable levels.
- The sound of keys being struck and vibrations produced by playing an instrument can be transmitted through a floor or wall to an unexpected extent. Please take care not to cause annoyance to others nearby.
- When disposing of the packing carton or cushioning material in which this unit was packed, you must observe the waste disposal regulations that apply to your locality.
- Do not use connection cables that contain a built-in resistor.

## Using External Memories

- Please observe the following precautions when handling external memory devices. Also, make sure to carefully observe all the precautions that were supplied with the external memory device.
  - Do not remove the device while reading/writing is in progress.
  - To prevent damage from static electricity, discharge all static electricity from your person before handling the device.

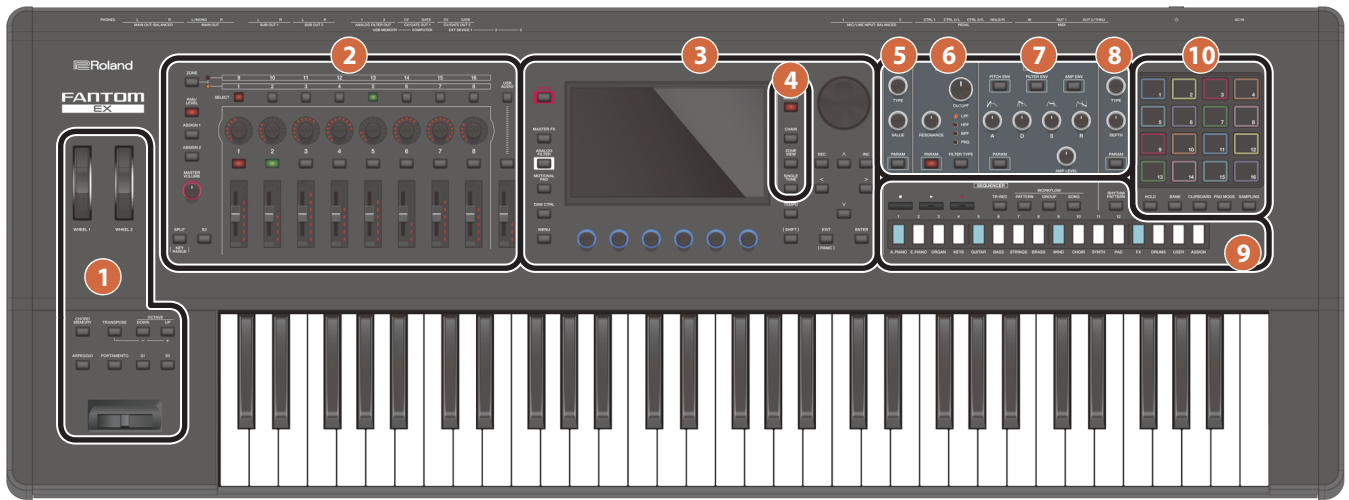
## Intellectual Property Right

- It is forbidden by law to make an audio recording, video recording, copy or revision of a third party's copyrighted work (musical work, video work, broadcast, live performance, or other work), whether in whole or in part, and distribute, sell, lease, perform or broadcast it without the permission of the copyright owner.
- Do not use this product for purposes that could infringe on a copyright held by a third party. We assume no responsibility whatsoever with regard to any infringements of third-party copyrights arising through your use of this product.
- The copyright of content in this product (the sound waveform data, style data, accompaniment patterns, phrase data, audio loops and image data) is reserved by Roland Corporation.
- Purchasers of this product are permitted to utilize said content (except song data such as Demo Songs) for the creating, performing, recording and distributing original musical works.
- Purchasers of this product are NOT permitted to extract said content in original or modified form, for the purpose of distributing recorded medium of said content or making them available on a computer network.
- ASIO is a trademark and software of Steinberg Media Technologies GmbH.
- This product is using the open source license (GPL/LGPL) software. You have the right to acquire, modify and distribute the source code for this open source license software. You can obtain the open source license source code used in this product by downloading it from the following website: <https://www.roland.com/support/>
- This product contains eParts integrated software platform of eSQL Co., Ltd. eParts is a trademark of eSQL Co., Ltd. in Japan.
- This Product uses the Source Code of µT-Kernel under T-License 2.0 granted by the T-Engine Forum ([www.tron.org](http://www.tron.org)).
- Roland, SuperNATURAL are either registered trademarks or trademarks of Roland Corporation in the United States and/or other countries.
- Company names and product names appearing in this document are registered trademarks or trademarks of their respective owners.
- Apple Logic Pro X, Garage Band, and Mainstage are either registered trademarks or trademarks of Apple Inc.



# Panel descriptions

## Top panel



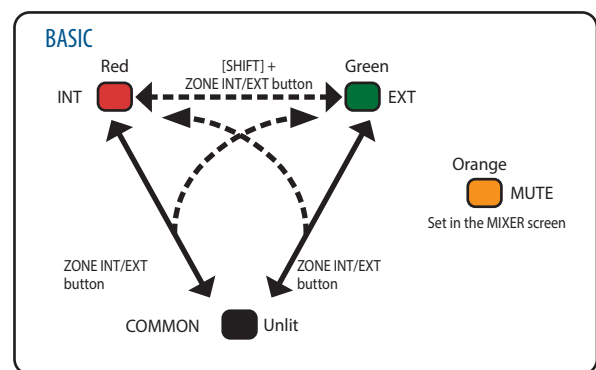
### 1 Controller section

Controller	Explanation
WHEEL1 WHEEL2	You can assign various parameters or functions to these wheels. To use the assigned function, move a wheel while you perform. If you operate the controller while holding down the [SHIFT] button, the setting screen appears.
[CHORD MEMORY] button	Turns the chord memory function on/off.
[TRANPOSE] button	Hold down this button and use the OCTAVE [DOWN] [UP] buttons to raise or lower the pitch range in semitone steps.
OCTAVE [DOWN] [UP] buttons	Raise or lower the pitch range in steps of an octave.
[ARPEGGIO] button	Turns the arpeggiator on/off.
[PORTAMENTO] button	Turns the portamento on/off.
[S1] [S2] buttons	Various parameters or functions can be assigned to these buttons. Hold down the [SHIFT] button and press one of these buttons to access a screen that lets you assign a function.
Pitch bend/Modulation lever	Varies the pitch or applies vibrato.

### 2 Zone section

Controller	Explanation
[ZONE 1-8/9-16] button	Switches the zones that you're operating.
[PAN/LEVEL] button	If you press the button to make it light, control knobs [1]-[8] adjust the pan of each zone, and sliders [1]-[8] adjust the volume of each zone.
[ASSIGN1] button [ASSIGN2] button	Assign other functions to sliders [1]-[8] and control knobs [1]-[8]. ASSIGN1 assigns parameters that you set for a scene, and ASSIGN2 assigns parameters that you edit in system settings. Hold down the [SHIFT] button and press one of these buttons to access a screen that lets you assign a function.
[MASTER VOLUME] knob	Adjusts the volume that is output from the MAIN OUT jacks and the PHONES jack.
[SPLIT/KEY RANGE] button	Turns the split function on/off. If you hold down the [SHIFT] button and press this button, the key range setting screen appears.
[S3] button	Various parameters or functions can be assigned to these buttons. Hold down the [SHIFT] button and press one of these buttons to access a screen that lets you assign a function.
ZONE SELECT buttons [1]-[8]	Select the zone that you want to control (the current zone). The selected zone becomes the current zone.
CONTROL knobs [1]-[8]	Various parameters or functions can be assigned to these knobs. The parameters that can be controlled depend on the function select buttons located at the left.
ZONE INT/EXT buttons [1]-[8]	Specify whether the applicable zone does sound or does not sound when you play the keyboard. In conjunction with the current zone, this determines how the internal sound engine (external sound module) produces sound.

Controller	Explanation	
Button status	When the applicable zone is the current zone	When the applicable zone is not the current zone
Unlit (COMMON)	The internal sound engine and the external sound module both produce sound when you play the keyboard.	Neither the internal sound engine nor the external sound module produce sound when you play the keyboard. You can use the internal sequencer or MIDI data from an external device to play the internal sound engine.
Lit red (INT)	The internal sound engine produces sound when you play the keyboard.	Only if the ZONE INT/EXT button of another current zone is on (lit red or green), the internal sound engine produces sound when you play the keyboard.
Lit green (EXT)	The external sound module produces sound when you play the keyboard.	Only if the ZONE INT/EXT button of another current zone is on (lit red or green), the external sound module produces sound when you play the keyboard.
Lit orange (MUTE)	The sound engine is muted. The internal sound engine does not produce sound.	



If you change the Zone Int/Ext Control setting on the SYSTEM screen to "ADVANCED", you can make the LEDs light up yellow (both the internal sound engine and external sound module play).

For details, refer to "Setting the ZONE INT/EXT button (zone int/ext control)" (p. 23).

Sliders [1]-[8]	Various parameters or functions can be assigned to these sliders. The parameters that can be controlled depend on the function select buttons located at the left.
[USB AUDIO] SELECT button	The USB AUDIO setting screen appears.

Controller	Explanation				
[USB AUDIO] IN/OUT button	Switches the function of the USB AUDIO slider between input and output, or turns the USB AUDIO function off (Unlit). Press the [USB AUDIO] IN/OUT button while holding down the [SHIFT] button to switch between red (lit) and green (lit). <table border="1" style="margin-left: 20px;"> <tr> <td>Lit red</td> <td>USB Audio Output Level</td> </tr> <tr> <td>Lit green</td> <td>USB Audio Input Level</td> </tr> </table>	Lit red	USB Audio Output Level	Lit green	USB Audio Input Level
Lit red	USB Audio Output Level				
Lit green	USB Audio Input Level				
[USB AUDIO] slider	Adjusts the input level and output level of USB AUDIO.				

### 3 Common section

Controller	Explanation
[WRITE] button	The WRITE screen appears. Saves a scene or tone.
[MASTER FX] button	The TFX ZOOM EDIT screen appears. If you hold down the [SHIFT] button and press this button, the MASTER FX routing screen appears.
[ANALOG FILTER] button	Accesses the analog filter screen.
[MOTIONAL PAD] button	The MOTIONAL PAD screen appears.
[DAW CTRL] button	Lets you use this unit as a DAW controller.
[MENU] button	The MENU screen appears.
Display	Shows various information depending on operation.
FUNCTION knobs [E1]–[E6]	These modify the parameter values that are shown at the bottom of the screen, and execute the functions. You can turn as well as press these knobs.
[TEMPO] button	The TEMPO screen appears. You can set the tempo by repeatedly pressing the button at the desired interval.
[SHIFT] button	Accesses the corresponding edit screen when pressed together with another button.
[VALUE] dial	Changes a value. If you hold down the [SHIFT] button and turn the dial, the value changes more greatly.
[DEC] [INC] buttons	Changes a value. If you press one of these buttons while holding down the other, the value changes more rapidly. If you press one of these buttons while holding down the [SHIFT] button, the value changes more greatly.
Cursor [▲] [▼] [◀] [▶] buttons	Move the cursor position up/down/left/right. These buttons also switch between screens.
[EXIT] button	This button returns to the previous screen or closes the open window.
[ENTER] button	Used to confirm a value, execute an operation, or view lists or other items.

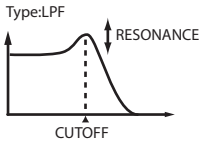
### 4 Scene section

Controller	Explanation
[SCENE SELECT] button	The SCENE SELECT screen appears. Here you can select a scene.
[SCENE CHAIN] button	The SCENE CHAIN screen appears. This lets you recall scenes in a specified order.
[ZONE VIEW] button	The ZONE VIEW screen appears. Here you can check the state of each zone.
[SINGLE TONE] button	Recalls a piano sound to zone 1. Zones other than 1 are turned off. <p><b>NOTE</b></p> Note that when you press this button, unsaved scene settings are lost.

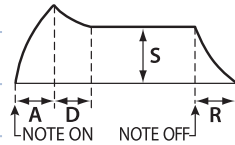
### 5 OSC (Oscillator) section

Controller	Explanation
[TYPE] knob	Specifies the OSC type.
[VALUE] knob	Lets you make OSC-related settings.
[PARAM] button	Accesses the OSC setting screen of the TONE EDIT ZOOM screen.

### 6 FILTER section

Controller	Explanation
[CUTOFF] knob	Specifies the cutoff frequency of filter. 
[RESONANCE] knob	Specifies the resonance of filter.
[FILTER TYPE] button	Specifies the type of filter.
[PARAM] button	Accesses the FILTER setting screen of the TONE EDIT ZOOM screen.

### 7 ENV/AMP section

Controller	Explanation
[PITCH ENV] button	Use the [A] [D] [S] [R] knobs to edit the pitch envelope (time-varying change in pitch).
[FILTER ENV] button	Use the [A] [D] [S] [R] knobs to edit the filter envelope (time-varying change in cutoff frequency).
[AMP ENV] button	Use the [A] [D] [S] [R] knobs to edit the amp envelope (time-varying change in volume).
[A] knob	Specifies the attack time of the envelope. 
[D] knob	Specifies the decay time of the envelope.
[S] knob	Specifies the sustain level of the envelope.
[R] knob	Specifies the release time of the envelope.
[AMP LEVEL] knob	Adjusts the volume.
[PARAM] button	The TONE EDIT screen is shown according to the selection state of the [PITCH ENV], [FILTER ENV] and [AMP ENV] buttons.

### 8 EFFECTS section

Controller	Explanation
[TYPE] knob	Specifies the MFX TYPE of the selected zone.
[DEPTH] knob	Specifies the MFX DEPTH of the selected zone.
[PARAM] button	Accesses the MFX screen of EFFECTS EDIT.

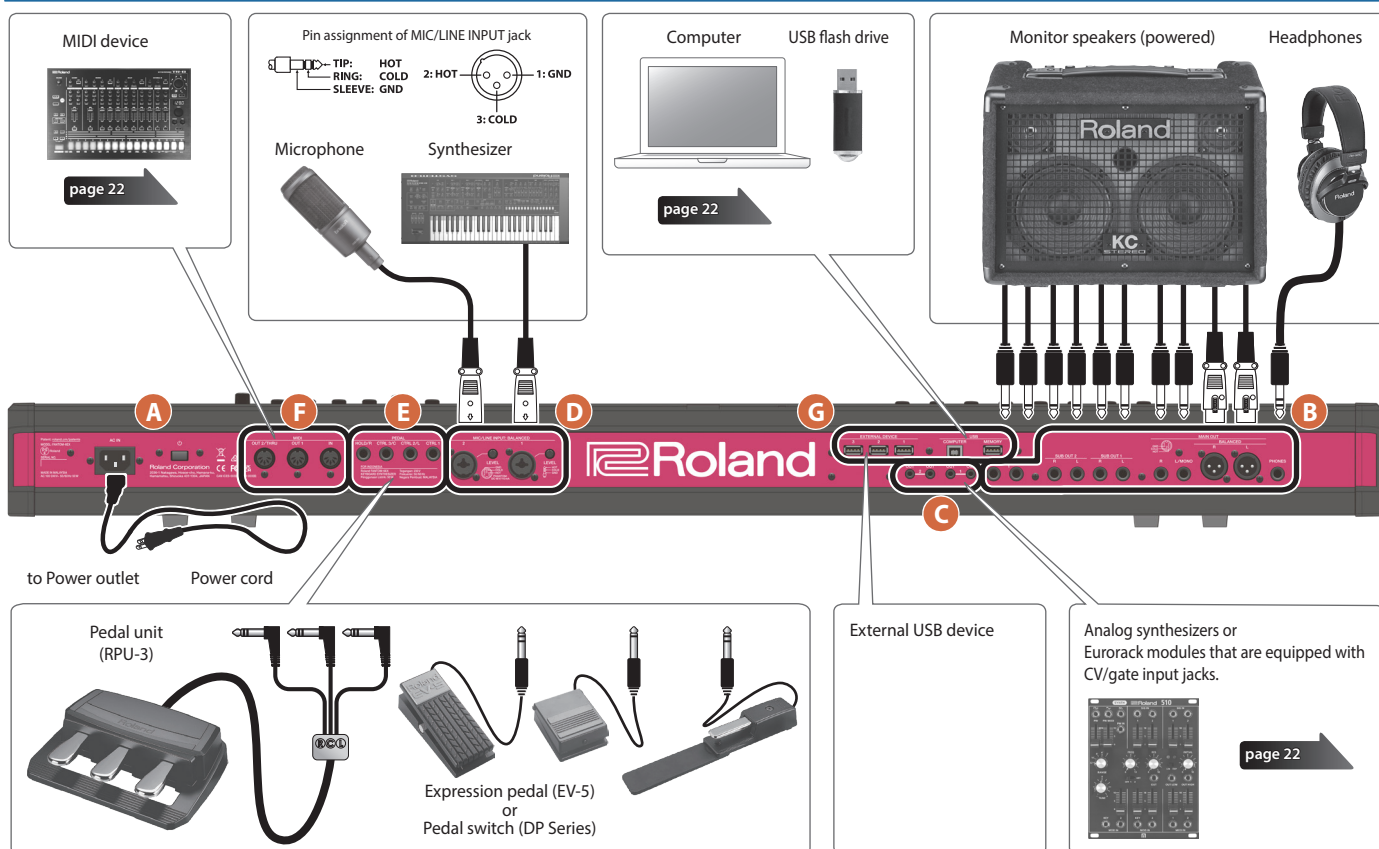
### 9 Sequencer section

Controller	Explanation
TONE CATEGORY buttons [1]–[16]	Select tones in each category. Depending on the situation, these buttons are also used for other things such as TR-REC input or as a selector for the SCENE CHAIN function.
[■] STOP button	Stops pattern playback or recording, or stops playback of the group or song.
[▶] PLAY button	Plays the pattern, group, or song.
[●] REC button	Enters the record-standby condition.
[TR-REC] button	Enables TR-REC. (p. 20)
[PATTERN] button	The PATTERN screen appears.
[GROUP] button	The GROUP screen appears.
[SONG] button	The SONG screen appears.
[RHYTHM PATTERN] button	The RHYTHM PATTERN screen appears.

### 10 Pad section

Controller	Explanation
[HOLD] button	Turns hold on/off (allowing the sound to continue even after you release the pad).
[BANK] button	Switches the pad bank.
[CLIP BOARD] button	Lets you move or copy a sample from one pad to another.
[PAD MODE] button	Specifies the functions that are assigned to the pads. Hold down the [SHIFT] button and press this button to access the edit screen for the currently selected pad mode and related screens.
[SAMPLING] button	Lets you sample.
Pads [1]–[16]	Play the samples assigned to each pad. You can make pad mode settings to assign various functions to the pads.

## Rear panel (connecting the external equipment)



\* To prevent malfunction and equipment failure, always turn down the volume, and turn off all the units before making any connections.

### A Power Supply

Controller	Explanation
[POWER] switch	This turns the power on/off.
AC IN jack	Connect the included power cord to this connector. • To prevent malfunction and equipment failure, always turn down the volume, and turn off all the units before making any connections.

### B OUTPUT jack

Controller	Explanation
PHONES jack	A set of headphones can be connected to this jack. Even if headphones are connected, an audio signal is sent from the OUTPUT jacks and BALANCED OUT jacks.
MAIN OUT jack (L, R) (Balanced)	These are balanced output jacks for audio signals. Connect them to your mixer. 1: GND — 2: HOT — 3: COLD • Pin assignment of MAIN OUT jack
MAIN OUT jack (L/MONO, R)	These are output jacks for audio signals. Connect them to your amp. If you're outputting in mono, connect the L/MONO jack.
SUB OUT 1 jack (L, R)	These are output jacks for sub-out audio.
SUB OUT 2 jack (L, R)	
ANALOG FILTER OUT jack (1, 2)	These output the sound that has passed through the analog filter section.

### C CV/GATE jacks

Controller	Explanation
GATE OUT jack (1, 2)	These jacks output note-on/off. They output +5 V. Depending on the settings, GATE OUT 2 can also be used as CV OUT.
CV OUT jack (1, 2)	These jacks output pitch. If you've specified a transpose or octave shift setting, the voltage changes according to the setting. These jacks support OCT/V (Hz/V is not supported).

### D INPUT jack

Controller	Explanation
MIC/LINE INPUT jacks (1, 2) (Balanced)	Connect a mic, audio device, or external synthesizer etc. to these jacks. To input the sound signal from an external device connected to the MIC/LINE INPUT jacks, you must set AUDIO IN to "ON" (this is set to "OFF" when you turn this instrument on). From [MENU] → <EFFECTS EDIT> → <AUDIO IN> tab, press the [F1] (AUDIO IN) knob to turn this "ON". The MIC/LINE INPUT jacks support XLR-type and TRS-type plugs. The XLR-type connections support 48 V phantom power, allowing you to connect condenser mics that use phantom power (phantom power supply: DC 48 V, 10 mA Max). Stereo input via a TRS plug is not supported.
LEVEL knob (1, 2)	Adjusts the input level of the MIC INPUT jack. MAX MIN

### E FOOT PEDAL jack

Controller	Explanation
PEDAL jack (CTRL 1, CTRL 2/L, CTRL 3/C, HOLD/R)	If you connect a pedal switch (sold separately: DP series) to the HOLD/R jack, you can use it as a damper pedal. You can also assign various functions to the pedals that are connected to the CTRL 1, CTRL 2/L, and CTRL 3/C jacks. • Use only the specified expression pedal. By connecting any other expression pedals, you risk causing malfunction and/or damage to the unit.

### F MIDI jack

Controller	Explanation
MIDI connectors (IN, OUT 1, OUT 2/THRU)	Used for connecting external MIDI devices and for transmission of MIDI messages. The OUT 2/THRU connector's function can be switched to operate either as MIDI THRU or as MIDI OUT.

English

日本語

Deutsch

Français

Italiano

Español

Português

Nederlands

## G USB port

Controller	Explanation
USB MEMORY port	Use a commercially available USB flash drive. However, we cannot guarantee that all commercially available USB flash drives will work.
USB COMPUTER port	Connect this to your computer to transfer performance data and audio signals. <ul style="list-style-type: none"> <li>Do not use a USB cable that is designed only for charging a device. Charge-only cables cannot transmit data.</li> </ul>
EXT DEVICE jack (1, 2, 3)	Connect these to an external USB MIDI device.

# Introduction

## Turning on the power

\* Once everything is properly connected, be sure to follow the procedure below to turn on their power. If you turn on equipment in the wrong order, you risk causing malfunction or equipment failure.

### 1. Minimize the volume of this unit.

Also completely turn down the volume of any connected external devices.

### 2. Press the [⏻] switch.

The unit is turned on, and the display's backlighting comes on.

### 3. Turn on the power to connected external devices.

### 4. Adjust the volume of the connected external devices.

### 5. Adjust the volume of this unit.

## Turning off the power

### 1. Minimize the volume of this unit.

Also completely turn down the volume of any connected external devices.

### 2. Turn off the power of the connected external devices.

### 3. Press the [⏻] switch.

The unit is turned off.

\* Before turning the unit on/off, always be sure to turn the volume down. Even with the volume turned down, you might hear some sound when switching the unit on/off. However, this is normal and does not indicate a malfunction.

\* If you need to turn off the power completely, first turn off the unit, then unplug the power cord from the power outlet. Refer to **"To completely turn off power to the unit, pull out the plug from the outlet"** (p. 2).

## Making the power automatically turn off after a time (Auto Off)

The power to this unit will be turned off automatically after a predetermined amount of time has passed since it was last used for playing music, or its buttons or controls were operated (Auto Off function).



**If you do not want the power to be turned off automatically, disengage the Auto Off function.**

### NOTE

- Unsaved data is lost when the power turns off. Any data that you want to keep must be saved in advance.
- To restore power, turn the power on again.

## Changing the Auto Off setting

### 1. Press the [MENU] button.

The MENU screen appears.

### 2. Touch <SYSTEM>.

The SYSTEM screen appears.

### 3. Touch <GENERAL>.

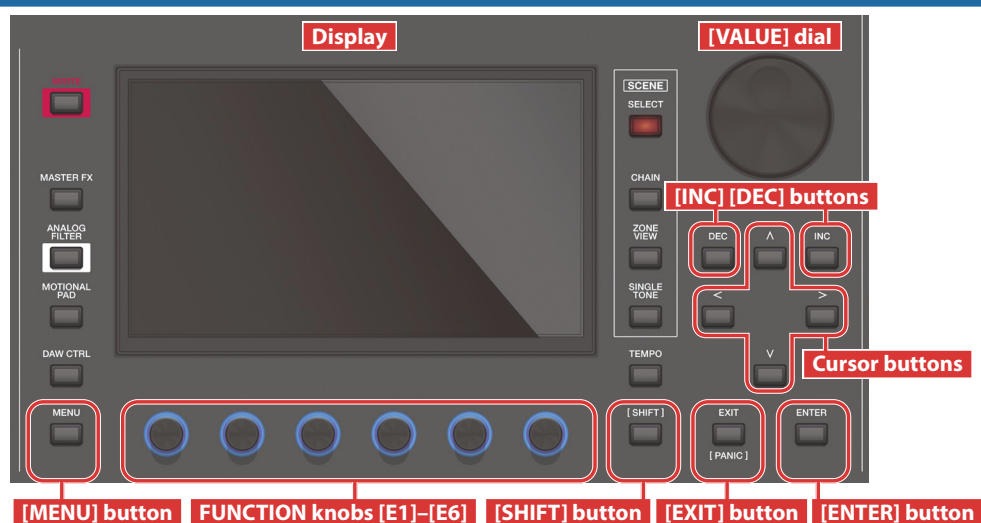
### 4. Select "Auto Off" and change the setting.

Parameter	Value	Explanation
Auto Off	Off	The power will not turn off automatically.
	30 min	The power will automatically turn off if no operation is performed for 30 minutes.
	240 min (default)	The power will automatically turn off if no operation is performed for 240 minutes (four hours).

### 5. If you want to store the auto-off setting, press the [WRITE] button in the System screen.



## Basic operation



## Editing a value

Use the following methods to modify a setting's value.

**[INC] [DEC] buttons**

Press the [INC] button to increase the value; press the [DEC] button to decrease the value.

Purpose	Operation
Modifying a value continuously	Hold down the [DEC] button or [INC] button.
Modifying a value rapidly	Hold down the [INC] button and press the [DEC] button. Hold down the [DEC] button and press the [INC] button.
Modifying a value more greatly	Hold down the [SHIFT] button and press the [DEC] button. Hold down the [SHIFT] button and press the [INC] button.

**[VALUE] dial**

Turn the dial clockwise to increase the value, or counter-clockwise to decrease the value.

Purpose	Operation
Modifying a value more greatly	Hold down the [SHIFT] button and turn the [VALUE] dial.

**Display (Touch panel)**

You can directly touch or drag an on/off icon, knob icon, or slider icon in the screen to switch a setting on/off or to edit a value.

**NUMERIC window**

If you hold down the [SHIFT] button and press the [ENTER] button, the numeric window appears. This is a convenient way to directly enter a numeric parameter value from the touch panel.

**NOTE**

Some parameters don't support numeric input.

## Moving the cursor

Multiple setting items (parameters) or selection items are shown in a single screen or window. To edit them using the [INC] / [DEC] buttons or the [VALUE] dial, move the cursor to the location of the item you want to edit.

Use the following methods to move the cursor.

**Cursor [▲] [▼] [◀] [▶] buttons**

Press a cursor button to move the cursor in the corresponding direction.

Purpose	Operation
Moving the cursor continuously	Hold down the cursor button.
Moving the cursor rapidly	While continuing to hold down one cursor button, hold down the cursor button of the opposite direction.

**Display (Touch panel)**

By directly touching a parameter value, knob icon, or slider icon in the screen, you can move the cursor to that location.

**NOTE**

Some icons do not move the cursor.

## Confirming or canceling the value

**[ENTER] button**

Use this button to confirm a value or execute an operation. When you move the cursor to a tone or parameter and press the [ENTER] button, a list appears, allowing you to change the setting.

**[EXIT] button**

This button returns to the previous screen, or closes the open window.

**Display (Touch panel)**

The <OK> or <SELECT> that are shown a confirmation screen have the same function as the [ENTER] button, and <EXIT> have the same function as the [EXIT] button.

**[SHIFT] button**

This is used in conjunction with other buttons.

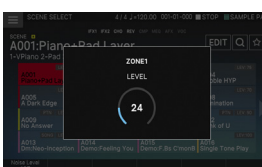
By holding down the [SHIFT] button and pressing another button, you can move to the related edit screen for the button that you pressed (shortcut).

## FUNCTION knobs [E1]–[E6]

These knobs perform the functions that are assigned to them in each screen, such as editing parameters or scrolling lists or tabs.

By pressing a knob, you can edit a value with a button-like operation.

## Knob and slider operations



When you use a knob or slider to edit a setting, the edited parameter and its value are shown in a popup screen.

The popup screen closes automatically after a time.

Some parameters don't show a popup screen.

**[MENU] button**

Allows you to make detailed settings for a function, or system settings. You can also access the menu screen by touching the <≡> icon located in the upper left of the SCENE SELECT screen.

## Operating procedures in this manual

On this unit, operations such as "editing a value", "moving the cursor", "setting/cancelling a value", or "moving to a screen" can be performed on multiple ways, as explained earlier. (For example, "button operations", "touch panel operations", "dial operations", etc.)

To avoid making the subsequent explanations in this manual unnecessarily complex, we will not always describe all of these methods, but may simply provide an abbreviated explanation such as "move the cursor to \* and edit the value". In actual operation, you may use any of the above methods as is convenient for you.

### Operations in the display

This unit's display is a touch panel; you can perform various operations by directly touching the display. There are many screens, but here we explain the typical screen operations.

- A light touch with your finger is sufficient to operate the touch panel. The touch panel might be damaged if you press it strongly, or if you press it with a hard object. Do not use excessive force, and use only your finger to operate it.
- Text enclosed in [ ] indicates buttons shown in the panel. Text enclosed in < > indicates buttons or knobs shown in the screen.

### SCENE SELECT screen

Touch to open the menu.

Touch to move to each function screen.

Switches to the next (previous) page.

Touch to select a scene.

Porta Time 73 LFO1 Rate 1/8 LFO1 Amp Depth 0 LFO2 Rate 1/8 LFO2 Amp Depth 0 Filter Env Depth +49

This shows information about the parameters that you can control using knobs [E1]–[E6].

### TONE EDIT screen

Switches to the PRO EDIT screen.

Touch to turn a switch on/off or to select.

Touch to move to each function screen.

Touch to switch between tabs. Swipe to scroll.

Touch to select a parameter.

Touch to move the cursor. Drag to edit a value.

This shows information about the parameters that you can control using knobs [E1]–[E6].

### ZONE VIEW screen

Touch to move the cursor.

Touch to turn a switch on/off.

Touch to open the list.

001:Stage Grand 120  
142:Frost Bite 70  
158:PWM Basic Pad 55  
442:Syn Vox 1 45

### MENU screen

Returns to the screen of the next-higher level.

Touch to move between screens.

TONE EDIT ARPEGGIO  
EFFECTS EDIT CHORD MEMORY  
ZONE EDIT FILE UTILITY  
SCENE EDIT UTILITY  
MIXER  
SYSTEM

### RENAME screen

Touch to enter characters.

Presets Scene 1

1 2 3 4 5 6 7 8 0  
q w e r t y u i o p  
a s d f g h j k l '  
Shift z x c v b n m [ ]  
!@#\$ Space < > Back Space Clear All

CANCEL OK

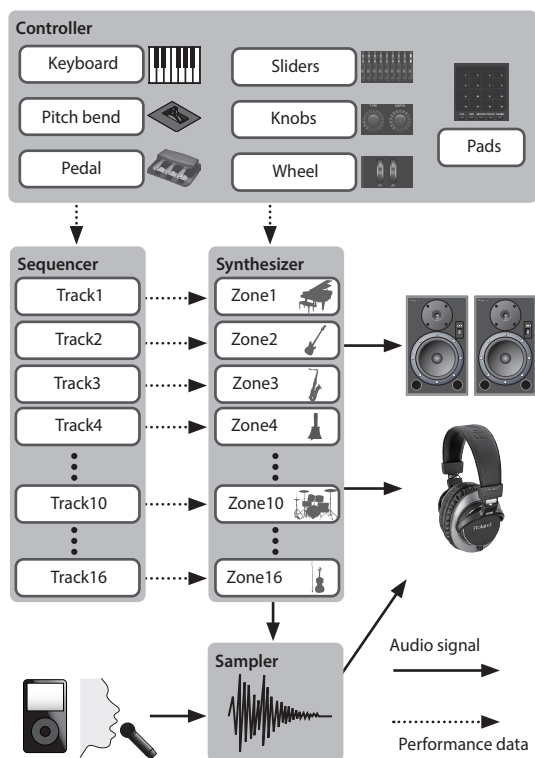
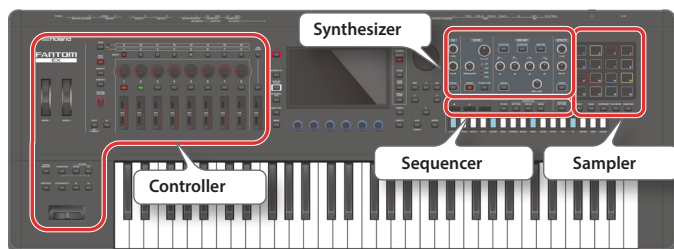
Touch to cancel. Touch to confirm.

### MEMO

If you lose track of which screen you're in, you can return to the SCENE SELECT screen by pressing the [EXIT] button several times or by pressing the [SCENE SELECT] button.

## An overview of this unit

Broadly speaking, this unit consists of four sections: controller, synthesizer, sequencer, and sampler.



### Controller

This includes the keyboard, pads, pitch bend/modulation lever, wheels, panel knobs, sliders, and pedals connected to the rear panel. When you perform a performance operation such as pressing or releasing a key or pressing the damper pedal, the operation is converted into a MIDI message and transmitted to the sound engine and to an external MIDI device.

### Synthesizer

This is the section that generates and modifies sound. In response to the performance data from the controller, it produces an audio signal that is output from the OUTPUT jacks and the PHONE jack.

### Sequencer

This lets you create patterns using a 16-track MIDI sequencer. Tones of the 16 zones in the scene can be recorded directly using the 16 tracks. Realtime recording, step recording, and TR-REC are provided. You can combine patterns to create groups, and place groups in the desired order to create a song.

#### Pattern

This is a unit of sequence data that records performance data for an individual tone. There can be up to eight patterns in one track. You can record up to 64 measures in one pattern.

#### Group

This records a combination of patterns for each track. You can create up to 16 groups in one scene.

#### Song

By placing groups in the desired order you can create a "song" that records that order. You can create one song in one scene.

### Sampler

The sampler section lets you audio-record (sample) the sound of your keyboard performance or the input sound from an audio device or mic. The recorded sample can be played by pressing a pad.

### Sample

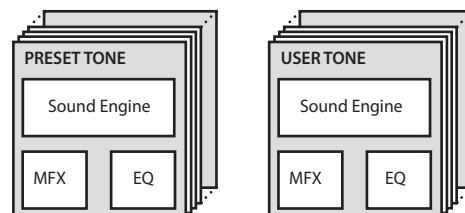
This is a piece of sampled sound. For each sample, you can specify looping and other settings, and assign it to a pad.

## Units of sound

### ZONE

A "tone" is the smallest unit of sound on this unit.

A tone consists of the combination of sound engine and effects (MFX+EQ). Use the tone category buttons [1]–[16] to select tones by their category.



You can edit a tone and then save it as a user tone.

Some tones are "drum kits" which provide a collection of percussion instrument sounds.

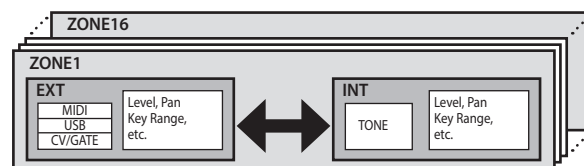
In a drum kit, different percussion instrument sounds are heard depending on the key (note number) that you play.

### ZONE

This is a container for playing a tone.

To play a tone, you assign it to a zone. For each zone, you can specify whether it is connected to the keyboard, and make settings such as its key range, volume, pan, and controller reception.

There are 16 zones; by combining zones you can create sounds that consist of multiple tones, or create foundational performance (sound) settings for each song. You can also use specific zones to control an external sound module (EXT ZONE) instead of the internal sound engine.



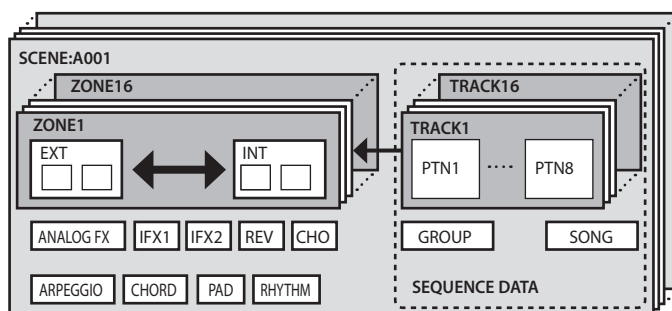
### SCENE

A scene contains a favorite performing state, including settings for each zone (tone, MFX, volume, etc.), settings common to all zones (Reverb, Chorus, IFX, Analog Filter, etc.), and sequence data for each zone.

You can store an idea for a song or phrase as a scene, and manage scenes by switching them for each song.

You can freely recall saved scenes in the SCENE SELECT screen that appears after startup.

By using the SCENE CHAIN function you can place and recall scenes in the order of the songs that you'll be playing live, or collect frequently-used scenes for easy recall. (p. 15)



# Performing

## Selecting a sound (SCENE/TONE)

### Selecting a scene

#### 1. Press the [SCENE SELECT] button.

The SCENE SELECT screen appears.



#### 2. Touch a scene icon in the screen to select the desired scene.

The icon of the selected scene is colored.



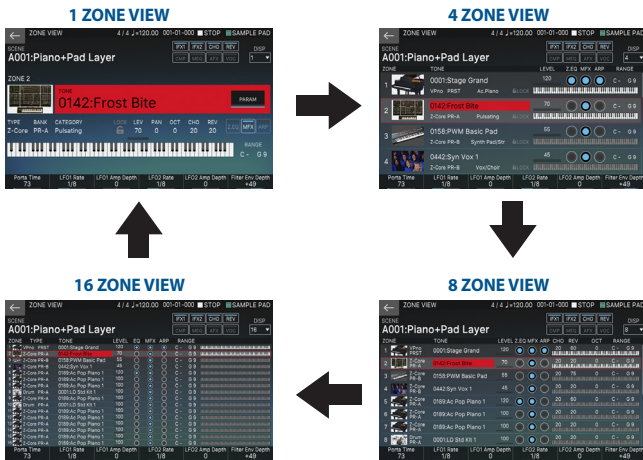
Sixteen scene icons are arranged in the screen as a 4 x 4 grid, and you can select one of these scenes. By touching the ◀ (▶) icon located at the left or right edge of the screen, you can choose from the previous (or next) 16 scenes.

### Selecting a tone

#### 1. Press the [ZONE VIEW] button.

The ZONE VIEW screen appears.

Each time you press the [ZONE VIEW] button, the VIEW number (the number of zones shown simultaneously) is switched.



#### 2. Press a ZONE SELECT button [1]–[8] to select the zone that you want to control.

To select zones 9–16, use the [ZONE 1-8/9-16] button to switch groups, and then press a ZONE SELECT [1]–[8] button.

#### 3. Press a tone category button [1]–[16] to select the type (category) of tone.

#### 4. Move the cursor to the tone name (number), and use the [VALUE] dial or the [INC]/[DEC] buttons to select a tone.



- When the cursor is located at the tone name (number), pressing the [ENTER] button displays the "TONE LIST".

### Layering zones (layer)

- Press the ZONE INT/EXT button of the zones that you want to layer, making them light red.
- Of the zones that are lit, press the ZONE SELECT button of one zone to specify it as the current zone.

When you play the keyboard, the zones lit red are sounded as layers.

#### NOTE

Zones whose ZONE INT/EXT button is lit green are controlling an external MIDI sound module. To switch to the internal sound engine, hold down the [SHIFT] button and press the corresponding ZONE [INT/EXT] button to make the button light red (INT setting).

### Dividing the keyboard into two regions (split)

- Press the [SPLIT] button to make it light.
- To cancel split, press the [SPLIT] button to make it go dark.

When you cancel split, the high and low regions (KEY RANGE) are reset, and return to the layer state.

### Changing the keyboard's split point

- While holding down the [SPLIT] button, press the key that is to become the new split point.

The split point is shown.

When you release the [SPLIT] button, the previous display will reappear. The split-point key is included in the ZONE 1 section.

#### MEMO

- If you want to change the tone of the upper key range, press ZONE SELECT [1]; if you want to change the tone of the lower key range, press ZONE SELECT [4]. Then select a tone.
- By using the KEY RANGE function you can freely specify the key range for each zone.

### Raising/lowering the key range in semitones (transpose)

- Hold down the [TRANPOSE] button and press the OCTAVE [DOWN] button or [UP] button.
- You can change this setting in a range of -5+6 semitones.
  - To return to the original setting, hold down the [TRANPOSE] button and press the OCTAVE [DOWN] button and [UP] button simultaneously.

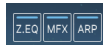
### Raising/lowering the key range in octaves (octave)

- Press the OCTAVE [DOWN] button or [UP] button.
- You can change this setting for a maximum of ±3 octaves.
  - To restore the original setting, press the OCTAVE [DOWN] button and [UP] button simultaneously.

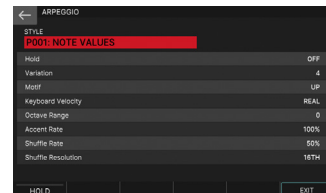
### Playing arpeggios

The arpeggiator is a function that automatically produces an arpeggio based on the keys that you press.

- In ZONE VIEW, turn ARP "ON" for the applicable zone.



- Press the [ARPEGGIO] button to make it light.



- Play a chord on the keyboard.

According to the notes of the chord you play, an arpeggio starts playing for zones that are on.

- Move the cursor to "STYLE" and change the style.

The arpeggio performance changes according to the selected style.

- To turn off this function, press the [ARPEGGIO] button once again to make it go dark.

#### MEMO

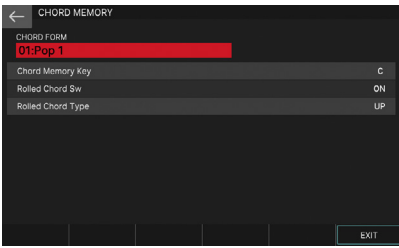
By using this in conjunction with the chord memory function, you can easily play a variety of arpeggio sounds using just one finger.



## Playing chords (chord memory)

Chord memory is a function that sounds a pre-registered chord form when you play a single note on the keyboard.

1. Press the [CHORD MEMORY] button to make it light.



2. Play the keyboard.

A chord sounds according to the currently selected chord form.

3. Move the cursor to "CHORD FORM" and change the chord form.

The way in which the chord plays will change.

4. To turn off this function, press the [CHORD MEMORY] button once again to make it go dark.

## Selecting/playing rhythm patterns

This unit lets you perform while a rhythm pattern plays.

1. Press the [RHYTHM PATTERN] button.

The RHYTHM PATTERN screen appears.



2. Move the cursor to "RHYTHM GROUP".
3. Use the [VALUE] dial to select a rhythm group.
4. Touch <Intro>--<Ending> to select the rhythm pattern that you want to play.

The rhythm pattern plays.

### MEMO

To stop, touch the icon of the rhythm pattern that's playing.

## Changing the tempo

1. Press the [TEMPO] button to access the TEMPO screen.
2. Use the [VALUE] dial to change the tempo.

### MEMO

You can specify the tempo by pressing the [TEMPO] button at the desired timing (tap tempo). Press three times or more at quarter-note intervals of the desired tempo.

## Using the sliders and control knobs

1. Use the [ZONE 1-8/9-16] button to switch the zones (ZONE1-ZONE8/ZONE9-ZONE16) that you want to control.
2. Press a function select button to select the parameter that you want to control.

Button	Explanation
[PAN/LEVEL] button	The control knobs adjust the pan of each zone, and the sliders adjust the volume of each zone.
[ASSIGN1] button [ASSIGN2] button	You can use the control knobs and sliders to adjust the parameters that are assigned in advance to the scene or the system. ASSIGN1 lets you adjust the parameters that are assigned for each scene. ASSIGN2 lets you assign the parameters that are assigned for the system.

3. Move the control knobs and sliders.

The sound changes according to the assigned function (such as pan or volume).

### MEMO

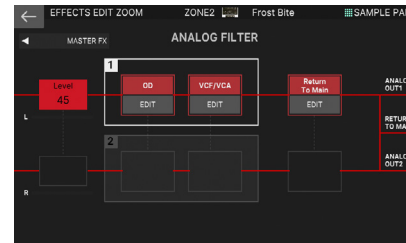
You can hold down the [SHIFT] button and press the [ASSIGN1] or [ASSIGN2] button to access the edit screen for assigning parameters. For details, refer to "Reference Manual" (PDF).

## Using the analog filter

This unit is equipped with an analog filter, providing a wide range of sound-design potential.

1. Press the [ANALOG FILTER] button.

The Analog Filter screen appears.



2. Touch <EDIT>.

The ANALOG FILTER edit screen appears.



3. Move the cursor to the desired parameter, and edit the value.

Section	Explanation
OVERDRIVE	Adjusts the amount of distortion.
FILTER	This is an analog filter with five types.

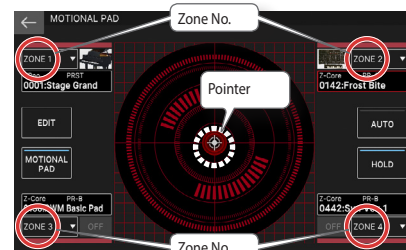
## Simultaneously modifying the volume of multiple zones (motional pad)

The MOTIONAL PAD function lets you simultaneously modify the volume of four zones by dragging in the screen. By using the motional pad function, you can produce diverse tonal changes with a single finger.

1. Press the [MOTIONAL PAD] button.

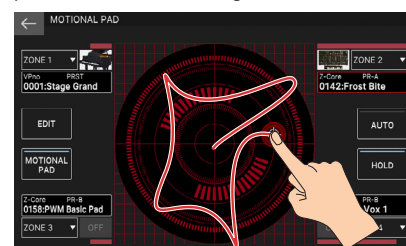
The MOTIONAL PAD screen appears.

The numbers of the zones being used with the motional pad function are shown in the zone number areas at the four corners of the screen. If an applicable zone is off, press the ZONE INT/EXT button [1]-[8] to turn the zone on.



2. Drag the circle (pointer) in the center of the screen to change its position.

The volume balance of the four zones changes according to the position of the pointer, and the sound changes in real time.



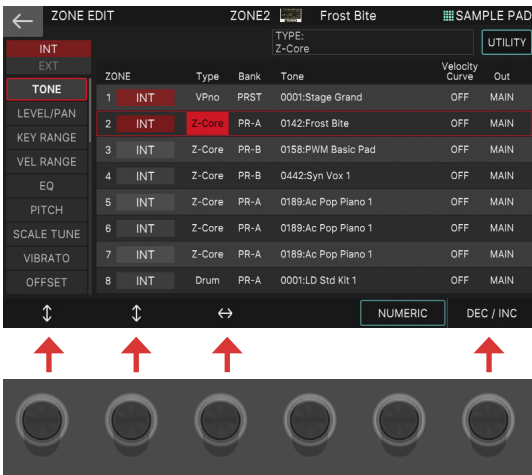


# Editing

## Editing a zone

There are 16 zones, and you can specify settings such as volume (Level), equalizer (EQ), and key range (KBD) for each zone.

1. Select a scene.
2. Press the [MENU] button.  
The MENU screen appears.
3. Touch <ZONE EDIT>.  
The ZONE EDIT screen appears.
4. Press a ZONE SELECT button [1]–[8] to select the zone that you want to control.  
To select a zone 9–16, use the [ZONE 1-8/9-16] button to switch the group, and then press a [1]–[8] button.
5. Move the cursor to the desired parameter, and edit the value.



You can use knobs [E1]–[E6] to scroll between tabs, move the cursor, and directly edit parameters.

### NOTE

Changes that you make to the zone settings are temporary. If you turn off the power or select another zone, the changes are lost. If you want to keep the edited settings, save the scene (p. 15).

### MEMO

For details on the parameters, refer to “Parameter Guide” (PDF).

## Editing a tone

Here’s how to edit a tone.

1. As described in the procedure “Selecting a Tone” (p. 12), select the tone that you want to edit.
2. Press the [MENU] button.  
The MENU screen appears.
3. Touch <TONE EDIT>.  
The TONE EDIT ZOOM screen appears.



4. Move the cursor to the desired parameter, and edit the value.

You can use knobs [E1]–[E6] to scroll between tabs and directly edit parameters.

### MEMO

- You can switch between tabs to edit a variety of parameter values.
- For more detailed editing, use the TONE EDIT PRO screen. For details, refer to “Reference Manual” (PDF).
- For details on the tone parameters, refer to “Parameter Guide” (PDF).
- In addition to editing in the TONE EDIT ZOOM screen, you can also edit a tone directly by using the knobs and buttons of the OSC section, FILTER section, and ENV/AMP section located at the right of the panel (p. 5).

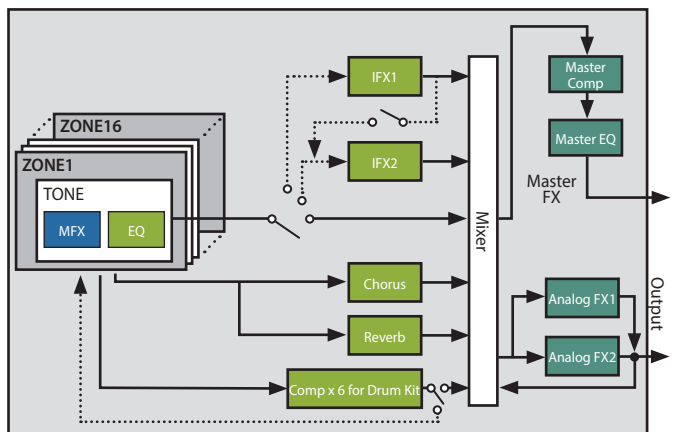


### NOTE

Changes that you make to the tone settings are temporary. If you turn off the power or select another tone, the changes are lost. If you want to keep the edited settings, save the tone (p. 15).

## Editing the effects

This unit is equipped with a variety of effects, including an effect for each tone (MFX), effects that can be specified for each scene (IFX1, IFX2, Chorus, Reverb), and effects that can be specified for the system (Master FX).



■ TONE parameter    ■ SCENE parameter    ■ SYSTEM parameter

## Editing the tone's effect (MFX)

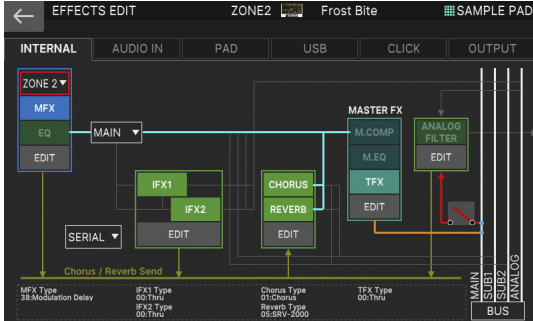
Here's how to edit the tone's effect (MFX).

### 1. Press the [MENU] button.

The MENU screen appears.

### 2. Touch <EFFECTS EDIT>.

The EFFECTS EDIT screen appears.



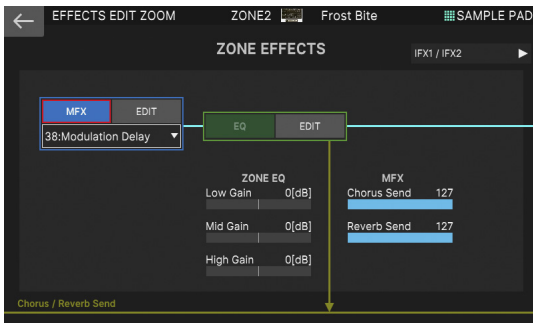
## Turning the MFX on/off

### 1. In the screen, touch <MFX> to turn it on/off.

## Editing the MFX parameters

### 1. In the MFX section, touch <EDIT>.

The EFFECTS EDIT (ZOOM) screen appears.



### 2. In the MFX section, touch <EDIT>.

The MFX EDIT ZOOM screen for MFX appears.



### 3. Move the cursor to the desired parameter, and edit the value.

You can use the knobs [E1]–[E6] to move the cursor or edit parameters directly.

## NOTE

The edits that you make to the effect settings are temporary. They will be lost if you turn off the power or select another scene or tone. If you want to keep the changes you made, save the tone, scene, or system settings respectively.

## MEMO

- In addition to editing the effect settings in the screen, you can also edit using the knobs and buttons of the EFFECTS section located in the right side of the panel (p. 5).
- For details on the parameters, refer to "Parameter Guide" (PDF).

## Saving a scene or tone

The edited zone and tone settings, and the recorded data, are temporary. They will be lost if you turn off the power or select another scene or tone. If you want to keep your edited settings or recorded data, save them as follows.

## NOTE

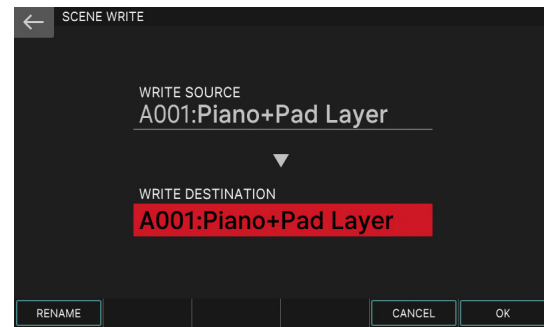
When you save, the data previously located in the save-destination is overwritten.

### 1. Press the [WRITE] button.

The WRITE MENU screen appears.

### 2. Touch the item that you want to save.

For example, if you touch <SCENE>, the SCENE WRITE screen appears.



### 3. If you want to change the name, touch <Rename> and edit the name.

After changing the name, touch <OK> to close the window.

### 4. Use the [VALUE] dial or the [DEC][INC] buttons to select the save-destination.

### 5. Touch <OK>.

A confirmation message appears. To cancel, touch <CANCEL>.

### 6. Touch <OK>.

The data is saved.

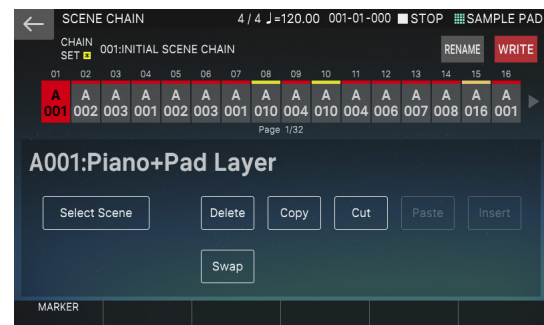
## Recalling scenes in the order of songs (scene chain)

Use the SCENE CHAIN function when you want to recall scenes in the order of the songs that you'll be playing live.

A scene chain lets you specify the desired order of the scenes that you'll be using, without changing the numbers of the scenes themselves. The order of scenes can be saved as a chain set, and by switching the chain set you can change the order of the scenes.

### 1. Press the [SCENE CHAIN] button.

The SCENE CHAIN screen appears.



### 2. Touch the "CHAIN SET" name and switch chain sets.

A chain set lets you register the order of scenes. This is a convenient way to arrange sounds in the order in which you'll be playing them. Hold down the [SHIFT] button and press the [▲] [▼] cursor buttons to edit the chain set settings.

### 3. Press a tone category button [1]–[16] to select a scene.

The 16 scenes arranged horizontally in the screen correspond to tone category buttons [1]–[16].

- You can also select a scene by directly touching a scene icon in the screen.
- By touching the ◀ (▶) icon located at the left or right edge of the scene icons, you can select the previous (or next) 16 scenes.

# Sampler

This unit lets you audio-record (sample) your keyboard or the input sound from an audio device or mic. The recorded sample can be played by pressing a pad.

## Playing a sample by pressing a pad

Here we explain how you can use pads [1]–[16] to play sounds that you sampled. (Sample Pad function)

In advance, select "SAMPLE PAD" as the pad function as described in "Assigning Convenient Functions to the Pads (PAD MODE)" (p. 16).

### 1. Press a pad [1]–[16].



A sample plays.

You can press multiple pads to play them simultaneously.

## Playing a sample continuously (hold)

### 1. While you hold down a pad, press the [HOLD] button.



The sample continues playing even after you release the pad. To stop the sample, press the pad once again.

### NOTE

The [HOLD] button is only enabled for sample data whose GATE parameter is set to "ON".

## Switching banks

The samples are assigned to four banks in units of 16 samples. When you switch banks, the samples assigned to each pad will also switch.

### 1. Press the [BANK] button.



### 2. Press a pad [1]–[4] to select a bank.

#### If you experience stuck notes!

Press the [HOLD] button four times in rapid succession. This stops all sounds that are being played by the pads.

## Moving/copying samples

You can move or copy a sample to another pad.

## Moving a sample

### 1. Hold down the pad of the sample that you want to move, and press the [CLIP BOARD] button.



### 2. Hold down the [CLIP BOARD] button, and press the move-destination pad.

The sample is moved.

- \* If there is a sample in the move-destination pad, the message "Overwrite?" appears. Press the [ENTER] button to overwrite, or press the [EXIT] button to cancel.

## Copying a sample

### 1. Hold down the pad of the sample that you want to copy and the [SHIFT] button; then press the [CLIP BOARD] button.

### 2. Hold down the [CLIP BOARD] button and press the copy-destination pad.

The sample is copied.

- \* If there is a sample in the copy-destination pad, the message "Overwrite?" appears. Press the [ENTER] button to overwrite, or press the [EXIT] button to cancel.

### Assigning convenient functions to the pads (PAD MODE)

In addition to playing samples or selecting scenes, you can assign various convenient functions to the pads.

#### 1. Press the [PAD MODE] button.

#### 2. Press a pad [1]–[16] button to select a function.

A setting screen appears according to the function you select.

### MEMO

For details on each function, refer to "Reference Manual" (PDF).

## Sampling

This unit lets you create a sample by sampling the following sounds.

- Keyboard performance
- Input from the MIC/LINE INPUT jacks 1, 2 (audio device, microphone)
- Audio input from the USB COMPUTER port

### 1. As necessary, connect the device (audio device or mic) that you want to sample to the MIC/LINE INPUT jacks 1 and 2.

#### MEMO

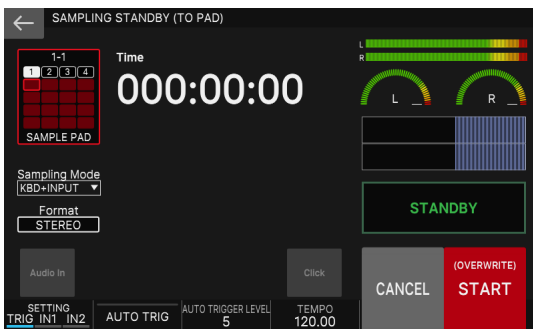
If you want to sample an audio device in stereo, connect the left channel to MIC/LINE INPUT jack 1 and the right channel to MIC/LINE INPUT jack 2.

### 2. Press the [SAMPLING] button.

The SAMPLING MENU screen appears.

### 3. Touch the <To Pad> button.

The SAMPLING STANDBY (TO PAD) screen appears.



### 4. Note that the <SAMPLE PAD> button shows the bank and number of the sample pad to which the sound will be sampled.

### 5. If you want to change the bank and number of the sample pad, touch the <SAMPLE PAD> button.

In the SAMPLING DESTINATION (PAD) screen, specify the sample bank and number that you want to change.

#### MEMO

If the pad you're sampling already contains a sample, the message "Overwrite OK?" appears. Press the [ENTER] button to overwrite, or press the [EXIT] button to cancel.

### 6. Touch <Sampling Mode> to select the sampling mode.

Parameter	Explanation
KBD+INPUT	The keyboard performance together with the audio input from the MIC/LINE INPUT jacks 1 and 2 and the audio input from the USB COMPUTER port will be sampled.
KBD	The keyboard performance is sampled.
INPUT	The audio input from the MIC/LINE INPUT jacks 1 and 2 and the audio input from the USB COMPUTER port will be sampled.

### 7. Adjust the sampling volume.

Adjust the volume as high as possible without letting the level meter reach full scale.

Device to sample	Explanation
Audio device	Adjust the rear panel LEVEL knobs 1 and 2, and the audio device.
Microphone	Adjust the rear panel LEVEL knobs 1 and 2.
USB COMPUTER	Adjust the USB Audio Input Level (p. 22).



### 8. Make settings for sampling.

Touch an on-screen parameter to turn it on/off, or select a parameter and use the [VALUE] dial to edit its value.

Parameter	Value	Explanation
Format	MONO	Samples the sound as a single waveform. Choose this if you're using one mic and sampling in mono. If you're inputting in stereo, the L and R sounds are mixed and sampled.
	STEREO	Samples the sound of L and R as two waveforms. Choose this if you're sampling in stereo from a source such as an audio device.
AUTO TRIGGER LEVEL	0-15	If Auto Trig is "ON", sampling starts when a signal that exceeds this setting is input.
AUTO TRIGGER	OFF, ON	If this is "ON", sampling starts when a signal that exceeds the AUTO TRIGGER LEVEL setting is input. If this is "OFF", sampling starts immediately when you touch <START>.

### 9. Produce sound on the device that's connected to this unit, and touch <START> at the moment that you want to start sampling.

During sampling, the screen indicates "NOW SAMPLING"

If AUTO TRIGGER is set "OFF" in step 7

Sampling starts when you touch <START>. Produce sound on the device that's connected to this unit.

If AUTO TRIGGER is set "ON" in step 7

Produce sound on the device that's connected to this unit; sampling starts when the input signal exceeds the setting specified by AUTO TRIGGER LEVEL.

### 10. When you want to stop sampling, touch <STOP>.

Sampling stops, and the sample is saved to the sample destination pad.

#### MEMO

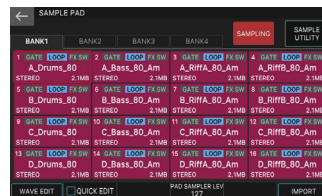
- The sampled data is saved in this unit's sample memory.
- Audio data from your computer can be loaded as samples. For details, refer to "Reference Manual" (PDF).

### Deleting a sample (delete)

Here's how to delete a sample.

### 1. Hold down the [SHIFT] button and press the [PAD MODE] button.

The SAMPLE PAD screen appears.



### 2. Press a pad to select the sample that you want to delete.

### 3. Touch <SAMPLE UTILITY>.

### 4. Touch <DELETE>.

A confirmation message appears. To cancel, touch <CANCEL>.

### 5. Touch <OK>.

The sample is deleted.

### Setting the input volume (input setting)

Here's how to specify the input volume of the device connected to the MIC/LINE INPUT jacks 1 and 2.

### 1. In the SAMPLING STANDBY screen (p. 17), touch <INPUT SETTING>.

### 2. Move the cursor to the desired parameter, and edit the value.

#### MEMO

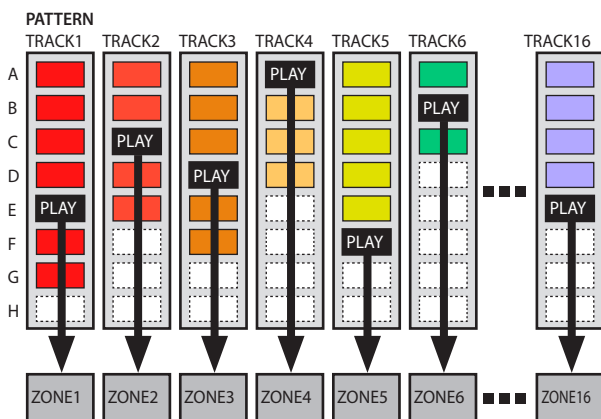
For the input volume of the device connected to the USB COMPUTER port, see "Adjusting the USB Audio Input" (p. 22).

# Sequencer

## How the sequencer is structured

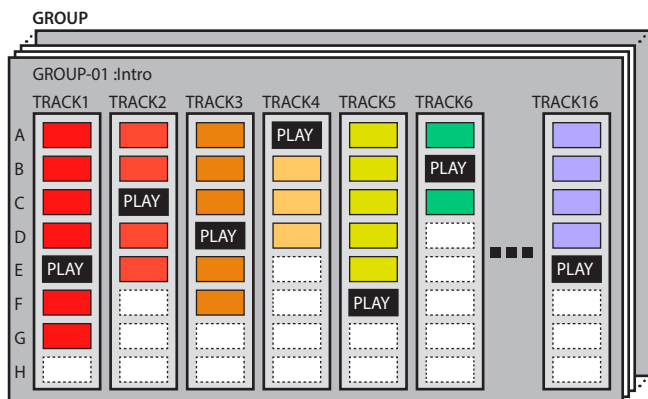
### Pattern

This unit's sequencer lets you record and play back using 16 tracks which correspond to the zones. Each track can have up to eight patterns, and these variations are called patterns. For each track, you can switch the variation during playback. Each pattern can be up to 64 measures long, and will play as a loop of the length that is specified for each pattern.



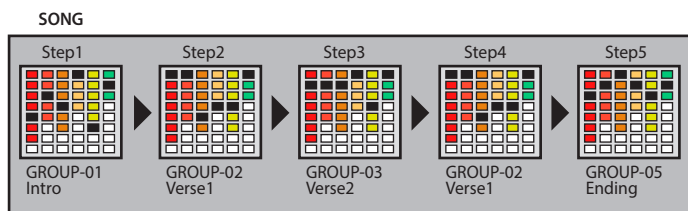
### Group

The combination of patterns created for each track is called a group. You can create groups such as "Intro", "Verse", or "Fill" corresponding to each section of your song.



### Song

The groups you create can be arranged into an order that's called a song. You can specify looping (LOOP) for individual groups and for the entire song.



### MEMO

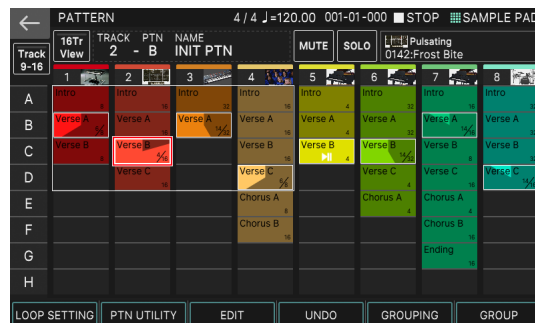
Patterns, groups, and songs are all saved for each scene.

## Playing the sequencer

### Playing pattern

1. Select a scene.
2. Press the [PATTERN] button.

The PATTERN screen appears.



A box in which a phrase is recorded (pattern box) is shown in color. If you long-touch a track's pattern box that's already recorded, the pattern box is shown highlighted. This means that it's in play-standby mode, and will play when you press the [PLAY] button. Only one pattern box for each track can be in play-standby mode.

- Empty
- Intro (Color Selectable)
- Intro (Loop Sw OFF)
- Intro (Play Standby)
- Intro (Playing)

3. Press the [▶PLAY] button.

Each track's pattern that's in play-standby mode will play.

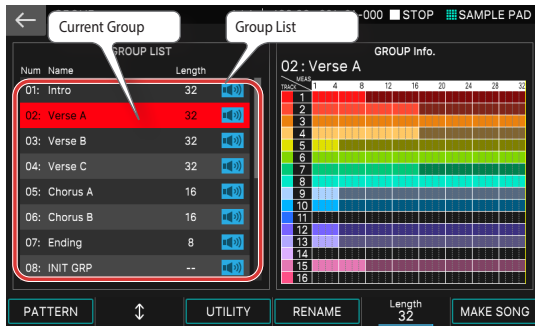
- If you touch a pattern box that's not playing, the pattern you touch is played.
  - By directly touching a colored pattern box in the screen, you can switch patterns for each track.
4. If you press the [■STOP] button, pattern playback stops for all tracks.
    - If you touch a pattern box that's playing, only the pattern that you touched stops.
    - If you switch or stop/start patterns while another pattern is playing, the change automatically happens at measure boundaries of the other playing pattern.



### Playing group

1. Select a scene.
2. Press the [GROUP] button.

The GROUP screen appears.



- The currently selected group (current group) is indicated by the cursor.
- At the right of the screen is shown the pattern length for each track in the current group, and you can use knob [E5] to specify the number of measures for the group.

3. Press the [▶PLAY] button.
4. Press the [■STOP] button to stop playback.
5. To select a different group, directly touch the group name to select it.

You can also use the [E2] knob to make a selection.

### Playing song

1. Select a scene.
2. Press the [SONG] button.

The SONG screen appears.



A succession of boxes called group boxes is shown, each with a number indicating the playback order. Within each group box is shown information such as the group number, group name, and the number of times it will loop. Nothing is shown in an empty group box.

3. Press the [▶PLAY] button.
4. Press the [■STOP] button to stop playback.

### Recording a pattern

There are three ways to record a pattern.

<b>Realtime recording (Realtime REC)</b>	Create a pattern by recording your keyboard performance and controller operations just as you perform them.
<b>Step recording (Step Rec)</b>	Create a pattern by successively recording your keyboard performance one step at a time.
<b>TR-REC</b>	This method lets you place notes of each instrument on the steps at which you want them to be heard. This method is suitable for creating drum patterns.

Before you record, it's a good idea to delete the existing pattern as follows.

1. Select a scene.
- NOTE**  
If you create a pattern, and then switch to another scene or turn off the power without saving the scene, the data you created will be lost.
2. Press the [PATTERN] button.
3. Touch <PTN UTILITY>.

The PATTERN screen appears.  
The PATTERN UTILITY screen appears.

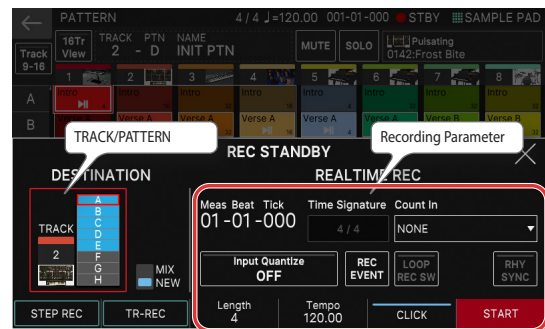
4. Touch <DELETE>.
5. Touch <DELETE ALL>.
6. To execute, touch <OK>.

The DELETE MENU screen appears.  
A confirmation message appears. To cancel, touch <CANCEL>.

**NOTE**  
All patterns are deleted.  
Deleted patterns cannot be recovered.

### Realtime recording (realtime REC)

1. Press the [●REC] button.
  2. Make settings for recording.
- The REC STANDBY screen appears.  
Directly touch various parameters in the screen to select them, or use the [VALUE] dial to edit the value.



Recording Parameter	Explanation
Count In	Adds a count-in when recording starts. Specify this before you start recording (while stopped).
Time Signature	Specifies the time signature. This can be specified when all patterns are empty.
Input Quantize	Specifies the quantization that is applied during recording.
RHY SYNC	Specifies whether the currently selected rhythm pattern automatically plays back and is recorded when you start recording (ON) or is not recorded (OFF).
LOOP REC SW	ON: Continue recording even after you've recorded the measures specified by the Length setting. OFF: Transition from recording to playback when you've recorded the measures specified by the Length setting.
REC EVENT	Selects the performance data that will be recorded during realtime recording.
CLICK	Turns the click (metronome) on/off.
Tempo	Specifies the tempo.
Length	Specifies the length of the pattern.
NEW/MIX	Specifies whether to make a new recording or to overdub-record.

Since touching <TRACK/PATTERN> will take you to the PATTERN screen, use this screen to select the track (1–16) and pattern (A–H) that will be recorded. When you change the recording-destination track, the zone played by the track moves in tandem. (Example) Track 2: Zone 2 (Bass)→Track 10: Zone 10 (Drum)  
After selecting a track and pattern in the PATTERN screen, press the [REC] button once again.

3. Press the [▶PLAY] button to start recording.
  4. Play the keyboard.
  5. Press the [■STOP] button to stop recording.
- You can also start recording by touching <START>.  
Knob and controller operations are also recorded.  
When you've finished recording, you can repeat steps 1–5 as necessary to record pattern variations on the same track or to record another track. If you're creating groups or a song as described in the next section, it's a good idea to divide the recording into several tracks and create several patterns so that you can distinguish them.

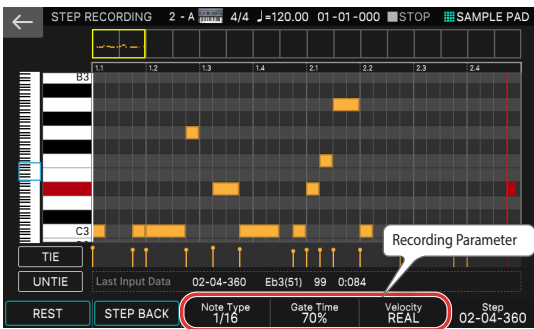
### Step recording (step REC)

1. Press the [●REC] button.  
The REC STANDBY screen appears.
2. In <TRACK/PATTERN>, note the track that you'll be recording.



Since touching <TRACK/PATTERN> will take you to the PATTERN screen, use this screen to select the track (1–16) and pattern (A–H) that will be recorded. When you change the recording-destination track, the zone played by the track moves in tandem. (Example) Track 2: Zone 2 (Bass)→Track 10: Zone 10 (Drum)  
After selecting a track and pattern in the PATTERN screen, press the [REC] button once again.

3. Touch <STEP REC>.  
The STEP RECORDING screen appears.
4. Specify the settings of the note that you will input.  
Set the various recording parameters in the screen.



Recording Parameter	Explanation
Note Type	Selects the rhythmic value of the notes that you input.
Gate Time	Specifies the gate time.
Velocity	Specifies the velocity.

5. Play a key once.  
The note is recorded in step 1, and the step position in the screen automatically advances by the length of the step time. You can record a chord by playing multiple notes.
6. Repeat steps 4–5 to record each step.
7. Press the [EXIT] button to end recording.

#### MEMO

- If you want to enter a rest, touch <REST>.
- To delete the data from a step, touch <STEP BACK>.
- To enter a tie, touch <TIE>.
- If you want to cancel the previously-entered tie, touch <UNTIE>.
- If you want to change the measure position at which you're recording, use knob [E6].
- By using the keyboard scroll bar at the left edge of the screen, you can move the displayed range of notes up or down.
- By using the piano roll type scroll bar at the top of the screen, you can move the displayed area through the measures.

### TR-REC

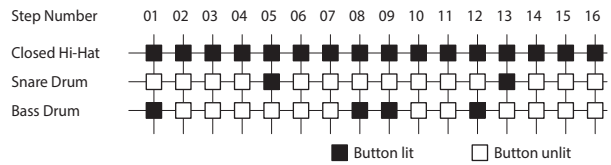
#### What is TR-REC?

TR-REC is the method of using the TONE CATEGORY buttons [1]–[16] to specify the timing at which each instrument will sound. TR-REC is available any time the phrase is playing or stopped. You can use it while listening to a rhythm that you yourself created. For example to create the drum pattern shown in figure 1, you would make the settings shown in figure 2.

FIGURE 1

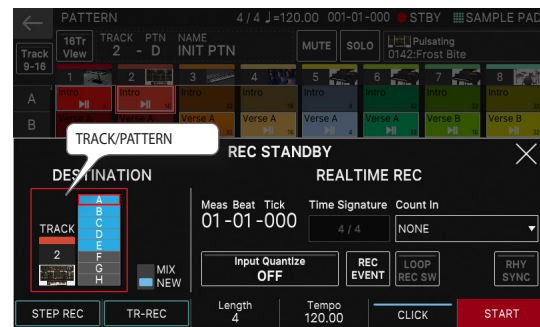


FIGURE 2



For the Drum part, playing an instrument on the keyboard makes the TONE CATEGORY buttons [1]–[16] light or go dark to indicate the steps on which that instrument will sound. Pressing one of the TONE CATEGORY buttons [1]–[16] switches it between lit and unlit, changing whether the instrument will or will not sound on that step.

1. Press the [●REC] button.  
The REC STANDBY screen appears.
2. In <TRACK/PATTERN>, note the track that you'll be recording.



Since touching <TRACK/PATTERN> will take you to the PATTERN screen, use this screen to select the track (1–16) and pattern (A–H) that will be recorded. After selecting a track and pattern in the PATTERN screen, press the [REC] button once again.

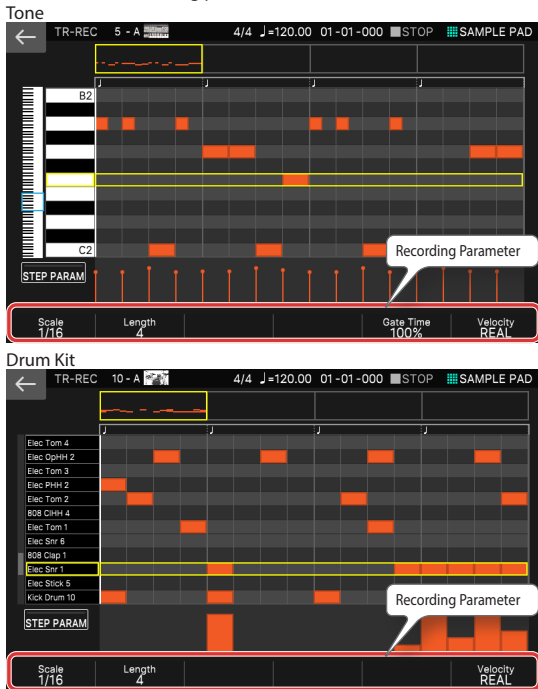
3. Touch <TR-REC>.  
The TR-REC screen appears. The [TR-REC] button is lit, and tone category buttons [1]–[16] change to operating as the TR-REC step buttons.

#### MEMO

You can also select the TR-REC function by pressing the [TR-REC] button instead of the [●REC] button.

#### 4. Make TR-REC settings.

Set the various recording parameters in the screen.

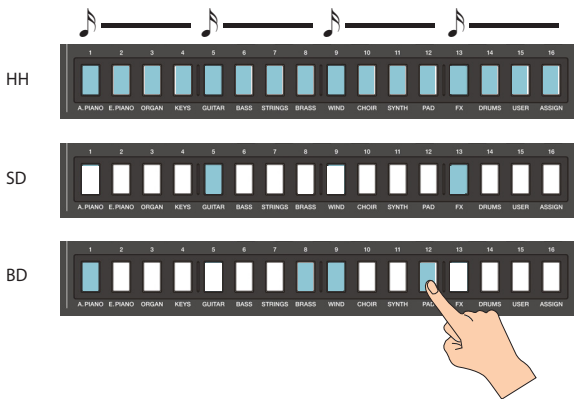


Recording Parameter	Explanation
Scale	Specifies the length of one step.
Gate	Specifies the gate time.
Velocity	Specifies the velocity.

#### 5. Use the keyboard to specify the instrument that you want to record (only for a drum kit).

The instrument changes when you press a key of a different pitch. For tones other than a drum kit, use the keyboard to specify the pitch that you want to input.

#### 6. Press the tone category buttons [1]–[16] to illuminate the steps at which you want a note to play.



Notes are entered at the corresponding step locations in the screen. To delete a note, press a lit tone category button [1]–[16] to make it go dark. You can also press the [▶]PLAY button and enter notes while the pattern plays.

#### 7. Press the lit [TR-REC] button to stop recording.

##### MEMO

- You can't select the TR-REC state during realtime recording or step recording.
- You can hold down the [SHIFT] button and press a tone category button [1]–[4] to change the measure or beat location. (Depending on the scale setting, use the [SHIFT] button + tone category buttons [1]–[8]).
- Scroll the keyboard (instrument) area in the left side of the screen to move the display area up or down.
- Use the piano-roll type scroll bar in the upper part of the screen to move the display area through the measures.

#### Creating a group

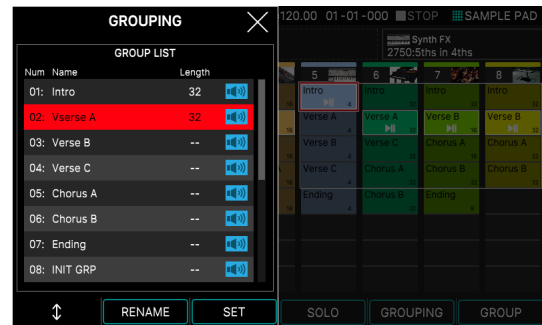
##### 1. Press the [PATTERN] button.

The PATTERN screen appears.

##### 2. Here's how to select patterns for each track to specify their combination.

##### 3. Touch <GROUPING>

The GROUP LIST appears.



##### 4. Move the cursor to the number that you want to specify.

##### 5. Touch <SET>.

A confirmation message appears. To cancel, touch <CANCEL>.

##### 6. To execute, touch <OK>.

The current combination of patterns for each track is registered as a group.

##### 7. As necessary, repeat steps 2–6 to create groups.

You can touch <RENAME> and assign a name to the group that you create.

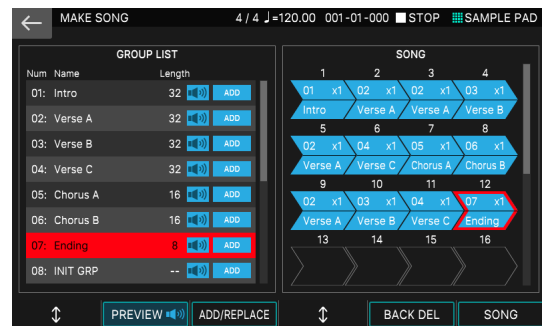
#### Creating a song

##### 1. Press the [GROUP] button.

The GROUP screen appears.

##### 2. Touch <MAKE SONG>.

The MAKE SONG screen appears.



##### 3. In the GROUP LIST located at the left side of the screen, touch <ADD> for the group that you want to play back first.

The group you touch is added to the SONG field at the right, and the input position advances by one.

##### MEMO

- If you touch <ADD/REPLACE> and use REPLACE to input, the group at the input position is replaced.
- A maximum of 32 groups can be input.
- If you touch <BACK DEL>, the group at the input position is deleted, and the input position returns by one.

##### 4. Repeat step 3 as necessary to create your song.

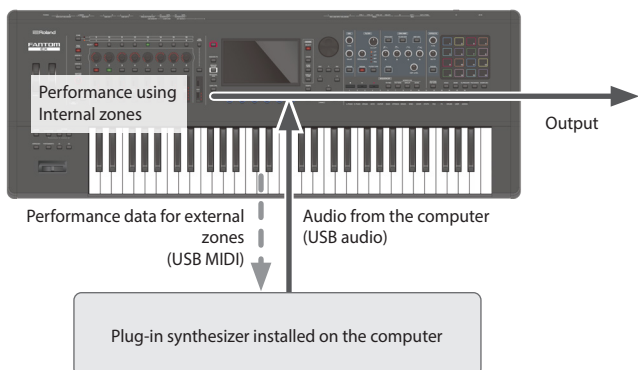
##### NOTE

If after creating a group or song, you switch to another scene or turn off the power without saving the scene, the data you created is lost.

# Control

## Performing live with a plug-in synthesizer

Here's how you can use the FANTOM to play a plug-in synthesizer that's installed on your computer.



## Connecting to your computer

The USB driver is software that transfers data between your computer software and this unit. You must install the USB driver in order to use this unit connected to your computer.

### MEMO

For details on downloading and installing the USB driver, refer to the Roland website.

<http://www.roland.com/support/>

## USB driver settings

Here's how to specify the USB driver that's used when connecting to your computer.

1. Press the [MENU] button.
2. Touch <SYSTEM>.
3. Touch <GENERAL> tab.
4. Set the "USB Driver" parameter to "VENDOR".

Parameter	Value	Explanation
USB Driver	VENDOR	Choose this if you want to use a USB driver downloaded from the Roland website.
	GENERIC	Choose this if you want to use the standard USB driver that was included with your computer. <ul style="list-style-type: none"> <li>• Only MIDI is available.</li> </ul>

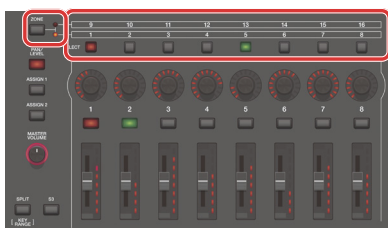
5. Press the [WRITE] button to save the SYSTEM settings.
6. Turn this unit's power off, and then on again.

## Controlling an external MIDI device (EXT MIDI OUT)

This unit's knob operations and keyboard performance can be transmitted as MIDI messages from the MIDI OUT connector and from USB MIDI OUT. Keyboard data can be output from the CV/GATE OUT jacks as CV/GATE signals. By setting a specific zone to "EXT", you can use that zone for controlling an external MIDI device.

1. Press the ZONE SELECT button of the zone that you want to use for MIDI output.

To select zones 9–16, use the [ZONE 1-8/9-16] button to switch groups, and then press a ZONE SELECT [1]–[8] button.



2. Press the ZONE INT/EXT button of the selected zone to make it light green.

If it's not green, hold down the [SHIFT] button and press the corresponding ZONE INT/EXT button to make it light green (EXT setting).

If it is lit green (EXT setting), MIDI messages are output.

If the ZONE INT/EXT buttons of multiple zones are lit, these settings in conjunction with the zones specified by the ZONE SELECT button (current zone) determine whether MIDI is output to an external sound module (p. 12).

Button status	When the applicable zone is the current zone	When the applicable zone is not the current zone
Unlit (COMMON)	The internal sound engine and the external sound module both produce sound when you play the keyboard.	Neither the internal sound engine nor the external sound module produce sound when you play the keyboard. You can use the internal sequencer or MIDI data from an external device to play the internal sound engine.
Lit red (INT)	The internal sound engine produces sound when you play the keyboard.	Only if the ZONE INT/EXT button of another current zone is on (lit red or green), the internal sound engine produces sound when you play the keyboard.
Lit green (EXT)	The external sound module produces sound when you play the keyboard.	Only if the ZONE INT/EXT button of another current zone is on (lit red or green), the external sound module produces sound when you play the keyboard.
Lit orange (MUTE)	The sound engine is muted. The internal sound engine does not produce sound. If the immediately previous state was lit green, the external sound module produces sound.	

3. As desired, press the [PAN/LEVEL] button, the [ASSIGN 1] button, or the [ASSIGN 2] button.
4. When you operate control knobs [1]–[8] and sliders [1]–[8], MIDI messages are output according to the buttons you pressed in step 3.

### MEMO

- You can make detailed settings in ZONE EDIT (p. 14).
- The settings you make can be saved as scene settings. "Saving a Scene" (p. 15)

## Using USB audio

### Adjusting the USB audio input

Here's how to make settings for audio that's input from a USB-connected computer.

1. Press the [USB AUDIO SELECT] button.
 

The USB AUDIO menu appears.
2. Use the cursor to select "USB Audio Input Switch", and use the [VALUE] dial to turn the setting "ON".
 

Audio input from the connected device turns on.
3. Use the cursor to select "USB Audio Input Volume", and use the [VALUE] dial to adjust the input level.

### MEMO

If "USB Audio In/Out Select" is set to IN, you can also use the [USB AUDIO] slider to adjust the value.

### Adjusting the USB audio output

Here's how to output the FANTOM's audio to a USB-connected computer.

1. Press the [USB AUDIO SELECT] button.
 

The USB AUDIO menu appears.
2. Use the cursor to select "USB Audio Output Switch", and use the [VALUE] dial to turn the setting "ON".
 

Audio output to the connected device turns on.
3. Use the cursor to select "USB Audio Output Volume", and use the [VALUE] dial to adjust the output level.

### MEMO

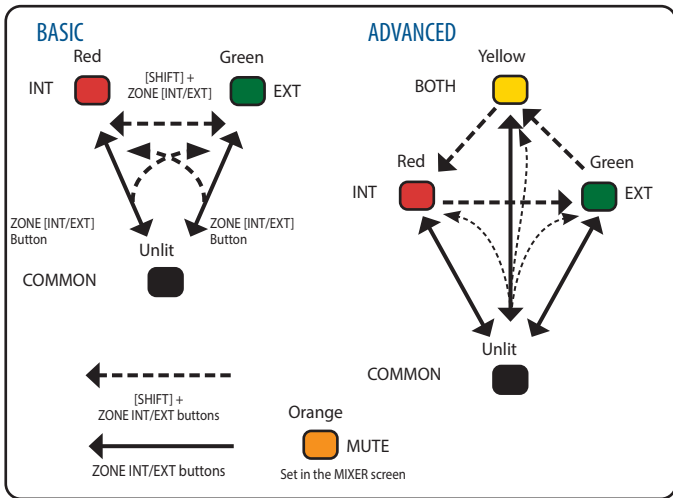
If "USB Audio In/Out Select" is set to OUT, you can also use the [USB AUDIO] slider to adjust the value.

### Setting the ZONE INT/EXT button (zone int/ext control)

Here's how to set how the ZONE INT/EXT button works.

1. Press the [MENU] button.
2. Touch <SYSTEM>.
3. Select the Zone Int/Ext Control parameter, and edit the setting.

Parameter	Value	Explanation
Zone Int/Ext Control	BASIC	Each ZONE INT/EXT button works as before.
	ADVANCED	The following states are now available for each ZONE INT/EXT button when you push them: unlit, red (INT), green (EXT), orange (MUTE) and yellow (BOTH). For the yellow (BOTH) state, both the internal sound engine and the external sound module play.



### Controlling an analog synthesizer (CV/GATE OUT)

You can connect an analog synthesizer equipped with CV/GATE input jacks, and control its note on/off or pitch.

Jack	Explanation
GATE OUT 1 jack GATE OUT 2 jack	These jacks output note on/off. Outputs +5 V.
CV OUT 1 jack CV OUT 2 jack	These jacks output pitch. If you've made transpose or octave shift settings, this voltage changes accordingly. These jacks support OCT/V (it does not support Hz/V).

**MEMO**

GATE OUT2 can be changed to CV OUT. For details, refer to "Reference Manual" (PDF).

### BASIC and ADVANCED usage examples

**MEMO**

The ZONE [SELECT] button lights up red for BASIC, and green for ADVANCED.

	BASIC	ADVANCED
Differences between BASIC and ADVANCED	For BASIC, the zone that plays is switched according to the current zone.	For ADVANCED, the sound plays without regard to the current zone when the zone switch is ON. When all zone switches are OFF, the current zone plays.
■ □ □ ZONE SELECT □ □ □ ZONE SW	Both the internal sound engine for zone 1 and the external sound module play.	Both the internal sound engine for zone 1 and the external sound module play.
■ □ □ ZONE SELECT □ ■ ■ ZONE SW	Switching with ZONE SELECT makes it useful for changing tones.	The zone 2 and 3 internal sound engines are layered.
□ ■ □ ZONE SELECT □ ■ ■ ZONE SW	The zone 2 and 3 internal sound engines are layered.	
■ □ □ ZONE SELECT □ ■ ■ ZONE SW	Both the internal sound engine for zone 1 and the external sound module play.	The zone 2 and 3 external sound modules are layered.
□ ■ □ ZONE SELECT □ ■ ■ ZONE SW	The zone 2 and 3 external sound modules are layered.	
■ □ □ ZONE SW	– (The LEDs do not light up yellow with the BASIC setting.)	The internal sound engine and the external sound module both produce sound when you play the keyboard.



# Settings

## Detailed function settings (menu)

### 1. Press the [MENU] button.

The MENU screen appears.

### 2. Touch the desired menu item in the screen.

### 3. Edit the settings of the selected menu.

#### MEMO

For details on the contents of each menu item, refer to "Reference Manual" (PDF).

Menu	Explanation
TONE EDIT	Edit a tone (p. 14).
EFFECTS EDIT	Edit the effects (p. 14).
ZONE EDIT	Edit a zone (p. 14).
SCENE EDIT	Make settings for an entire scene (p. 12).
MIXER	Adjust the pan and the volume balance.
SYSTEM	Make overall settings for the entire this unit.
UTILITY	Back up data or initialize this unit (p. 24).

## Backing up user data (backup/restore)

Here's how all settings stored in this unit's internal memory can be saved to an USB flash drive (backed up), or written back into internal memory (restored).

## Saving data to USB flash drive (BACKUP)

#### NOTE

If you back up using the same file name as backup data that already exists on the USB flash drive, the existing data will be overwritten. Assign a different name if you want to make a new backup.

### 1. Press the [MENU] button.

The MENU screen appears.

### 2. Touch <UTILITY>.

The UTILITY screen appears.

### 3. Touch <BACKUP>.

### 4. If you want to rename the backup file, touch <RENAME> and assign a name (p. 10).

After editing the name, touch <OK> to close the window.

### 5. Touch <OK>.

A confirmation message appears.  
To cancel, touch <CANCEL>.

### 6. To execute, touch <OK>.

#### NOTE

Never turn off the power or remove the USB flash drives while the screen indicates "working..".

## Restoring saved data from USB flash drive (RESTORE)

#### NOTE

When you execute the restore operation, all settings currently saved in this unit will be lost. If you want to keep the current settings, back them up using a different name.

### 1. In the UTILITY screen, touch <RESTORE>.

### 2. Touch the file that you want to restore, and then touch <RESTORE>.

A confirmation message appears.  
To cancel, touch <CANCEL>.

### 3. To execute, touch <OK>.

#### NOTE

Never turn off the power or remove the USB flash drives while the screen indicates "working..".

### 4. Turn the power off, and then on again (p. 8).

## Returning to the factory settings (factory reset)

Here's how you can restore this unit's settings to their factory-set condition (factory reset).

#### NOTE

When you execute the Factory Reset operation, all data in this unit will be lost. If there is any data that you want to keep, back it up to an USB flash drive.

### 1. In the MENU screen, touch <UTILITY>.

### 2. Touch <FACTORY RESET>.

A confirmation message appears.  
To cancel, touch <CANCEL>.

### 3. To execute, touch <OK>.

#### NOTE

Never turn off the power while the factory reset is in progress.

## Main specifications

	FANTOM-6EX	FANTOM-7EX	FANTOM-8EX
Keyboard	61 Keys semi-weighted keyboard and channel aftertouch	76 Keys semi-weighted keyboard and channel aftertouch	88 Keys PHA-50 Wood and Plastic Hybrid Structure and channel aftertouch
Power Supply	AC 117-240 V		
Current Draw	50W		
Dimensions	1,084 (W) x 403 (D) x 106 (H) mm 42-11/16 (W) x 15-7/8 (D) x 4-3/16 (H) inches	1,296 (W) x 403 (D) x 106 (H) mm 51-1/16 (W) x 15-7/8 (D) x 4-3/16 (H) inches	1,432 (W) x 439 (D) x 153 (H) mm 56-7/16 (W) x 17-5/16 (D) x 6-1/16 (H) inches
Weight	15.3 kg 33 lbs 12 oz	17.7 kg 39 lbs 1 oz	27.7 kg 61 lbs 2 oz
Accessories	Owner's Manual Power Cord		
	Keyboard stand: KS-10Z, KS-12	Keyboard stand: KS-10Z, KS-12	Keyboard stand: KS-G8B, KS-10Z, KS-12
Options	Pedal Switch: DP series, RPU-3 Expression Pedal: EV-5 USB flash drive (*1) <small>*1 Use a commercially available USB flash drive. However, we cannot guarantee that all commercially available USB flash drives will work.</small>		

\* This document explains the specifications of the product at the time that the document was issued. For the latest information, refer to the Roland website.

\* Please be aware that in some countries or regions, it might not be possible to use Roland Cloud at this time.

For details on how to place this unit on a stand, refer to "Reference Manual" (PDF).