

360 Systems®

INSTANT REPLAY 3



DIGITAL AUDIO RECORDER-PLAYER

Model DR-1000

OPERATIONS MANUAL

Version 9-23-2022

Warning Symbols

THE FOLLOWING WARNING SYMBOLS ARE USED ON THE PRODUCT IN THIS MANUAL:



ENGLISH	ATTENTION: REFER TO OWNER'S MANUAL FOR IMPORTANT INFORMATION.
FRANÇAIS	ATTENTION: VEUILLEZ VOUS RÉFÉRER AU MODE D'EMPLOI POUR UNE INFORMATION IMPORTANTE.
ITALIANO	ATTENZIONE: FATE RIFERIMENTO AL MANUALE PER INFORMAZIONI IMPORTANTI.
ESPAÑOL	ATENCIÓN: FAVOR DE REFERIR AL MANUAL DE OPERACION POR INFORMACION IMPORTANTE.



ENGLISH	WARNING: ELECTRICAL SHOCK HAZARD.
FRANÇAIS	AVERTISSEMENT: DANGER DE CHOC ÉLECTRIQUE.
ITALIANO	AVVERTIMENTO: PERICOLO DI SHOCK ELETTRICO.
ESPAÑOL	ADVERTENCIA: PELIGRO DE CHOQUE ELECTRICO.

Safety Compliance

Instant Replay 3 complies with the following safety standards:

EN 62368-1:2014 – Audio/video, information and communication technology equipment – Part 1: Safety requirements (IEC 62368-1:2014, modified)

EN 62368-1:2014 AC:2015 – Audio/video, information and communication technology equipment – Part 1: Safety requirements – corrigendum 1: 2015.

EN 62368-1:2014 – Audio/video, information and communication technology equipment – Part 1: Safety requirements

EU Declaration of Conformity

Type of Equipment:

Professional Use Audio Equipment.

Conforms to the Following Emissions and Immunity Standards:

European Standards EN55032:2015/ All: 2020

EN61000-3-3:2013, EN61000-3-2:2014 and EN55035:2017/ All: 2020

The specification EN 55035:2017/All: 2020 is a product family EMC standard which references the following specifications:

IEC 61000-4-2:2008, IEC 61000-4-3:2006 + A1: 2007 & A2:2010, IEC 61000-4-4:2012, IEC 61000-4-5:2014, IEC 61000-4-6:2013, IEC 61000-4-8:2009, IEC 61000-4-11:2004

FCC Compliance

This equipment complies with part 15, subpart B of the FCC rules for class A equipment. These limits are designed to provide reasonable protection against harmful interference when the equipment is operated in a commercial environment. This equipment generates, uses and can radiate radio frequency energy and if not installed and used in accordance with the owner's manual, may cause interference to radio communications. Operation of this equipment in a residential area is likely to cause interference in which case the user will be required to correct the interference at his own expense.

This device will accept any interference received, including interference that may cause undesired operation. The user is cautioned that changes made to the equipment without the approval of the manufacturer could void the user's authority to operate this equipment. It is suggested that only shielded and grounded cables be used to ensure compliance with FCC rules.

Company Address & Shipping Information

Freight and mail may be sent to 360 Systems at the following address. **Please** call or email for a **Return Material Authorization (RMA) number** before shipping equipment or parts.

360 Systems
Customer Service
3281 Grande Vista Drive
Newbury Park, CA 91320 USA
RMA# < your number here >

Telephone (818) 991-0360, 8:00 AM to 5:00 PM, Pacific Time. Fax: (818) 991-1360
Email: support@360systems.com Visit our web site at www.360systems.com

Product Registration

Important: As the owner of new capital equipment, you will want to take advantage of product information, enhancements, upgrades, or notifications issued by 360 Systems. Please visit 360systems.com/support/register or send in your Name, Company Name, Address, Phone Number, Email, Model and Serial Number to support@360systems.com so 360 Systems may remain in contact with you. Mail or fax it to 360 Systems offices in the USA at the address provided below.

Product Improvements and Upgrades

360 Systems reserves the right to make changes and/or improvements to its products without incurring any obligation to incorporate such changes or improvements in units previously sold. Certain features mentioned in this document may not be present in all models. This product is not offered for sale in all countries.

Trademarks and Patents

360 Systems, 360 Systems Instant Replay, and DigiCart are trademarks of 360 Systems

Software contained in this product is copyrighted by 360 Systems

Audinate®, the Audinate logo and Dante® are trademarks of Audinate Pty Ltd.

Limited Warranty

Instant Replay is warranted against defects in material and workmanship for a period of one year from date of original purchase. This warranty includes parts and labor.

This warranty excludes units that have been modified, repaired by unauthorized personnel, or damaged by abuse, improper operation, dirt, static electricity or other external voltages such as lightning strikes or power surges..

360 Systems assumes no liability whatsoever for real or consequential damages, loss of profits, inconvenience or any other losses due to non-operation of the Instant Replay.

360 Systems' sole liability under this limited warranty shall be the repair or replacement of defective product or components, at the discretion of 360 Systems. Products being returned under warranty shall be sent to 360 Systems or one of its foreign service centers, freight prepaid in the original or equivalent packaging.

Copyright 1995-2022 360 Systems
Printed in the United States of America. All rights reserved.



Special Thanks To

Elite Engineering
William Michalek LLC
Design Stein Studios

Safety and Warnings

-  Use only the power supply module that was supplied with the unit.
- Plug the power supply module's power cable into a properly grounded electrical outlet. The cable is equipped with a three-prong plug to help ensure proper grounding. Do not use adapter plugs or remove the grounding prong from the cable. If you must use an extension cable or power strip use a 3-wire cable with properly grounded plugs.
 - Use of the incorrect power supply module can damage the unit and will void the warranty.

There are no user serviceable parts. Refer service to 360 Systems or one of its authorized agents, or a trained electronics technician.

  **WARNING: To prevent the spread of fire, keep candles or other open flames away from this product at all times.**

SAFETY:

When operating your equipment:

- Place the equipment on a hard, level surface.
- Ensure proper ventilation. Do not place your equipment in a closed-in wall unit or other enclosure, or on a soft, fabric surface such as a bed, sofa, carpet, or a rug. Do not leave the unit powered on while covered. Do not restrict airflow into the unit by blocking any vents or air intakes.
- Do not use your equipment in a wet environment, for example, near a bath tub, sink, or swimming pool or in a wet basement.
- Do not use AC powered equipment during an electrical storm.
- Use only approved power cable(s). If you have not been provided with a power cable for the equipment or for any AC-powered option intended for the equipment, purchase a power cable that is approved for use in your country. The power cable must be rated for the equipment and for the voltage and current marked on the equipment's electrical ratings label. The voltage and current rating of the cable should be greater than the ratings marked on the equipment.
- To help prevent electric shock, plug the equipment and peripheral power cables into properly grounded electrical outlets. These cables are equipped with three-prong plugs to help ensure proper grounding. Do not use adapter plugs or remove the grounding prong from a cable. If you must use an extension cable, use a 3-wire cable with properly grounded plugs.
- Observe extension cable and power strip ratings. Ensure that the total ampere rating of all equipment plugged into the extension cable or power strip does not exceed 80 percent of the ampere ratings limit for the extension cable or power strip.
- When turning off the Instant Replay, do not unplug the AC power cable or the rear panel power input connector before performing a shutdown using the front panel power switch or the User Interface controls. Doing so risks loss of recorded data and setup information.

 **CAUTION: The AC ground connection must always be made first and disconnected last to prevent an energy hazard. Never defeat the ground conductor or**

operate the equipment in the absence of a suitably installed ground conductor. Contact the appropriate electrical inspection authority or an electrician if you are uncertain that suitable grounding is available.

- Position equipment cables and power cables carefully; route cables so that they cannot be stepped on or tripped over. Be sure that nothing rests on any cables.
- Before you clean your equipment, disconnect it from the electrical outlet. Clean your equipment with a soft cloth dampened with water. Do not use liquids or aerosol cleaners, which may contain flammable substances.
- Clean the air vents on the front, back, and sides of the system with a clean, damp cloth. Lint, dust and other foreign materials can block the vents and restrict the airflow.
- Do not spill food or liquids on equipment components, and never operate the equipment in a wet environment.
- If any of the following conditions occur, unplug the equipment from the electrical outlet and replace the part or contact your trained service provider:
 - The power cable, extension cable, or plug is damaged.
 - An object has fallen into the equipment.
 - The equipment has been exposed to water.
 - The equipment has been dropped or damaged.
 - The equipment does not operate correctly when you follow the operating instructions.

 CAUTION: Incorrectly installing or using an incompatible battery may increase the risk of fire or explosion. Replace the battery only with the same or equivalent type recommended by the manufacturer, carefully following installation instructions. Dispose of used batteries properly (see “SAFETY: Battery Disposal”).

- Handle batteries carefully. Do not disassemble, crush or puncture batteries. Do not short external contacts, dispose of batteries in fire or water, or expose batteries to temperatures higher than 60 degrees Celsius (140 degrees Fahrenheit). Do not attempt to open or service batteries. Replace batteries only with batteries designated for the equipment.

SAFETY: Battery Disposal

 Your system uses a lithium coin-cell battery. The NiMH, lithium coin-cell is a long-life battery, and it is very possible that you will never need to replace it. However, should you need to replace it, refer to the Appendix for instructions.

Do not dispose of the battery along with household waste. Contact your local waste disposal agency for the address of the nearest battery deposit site.

Network Security

- It is strongly recommended that when using Instant Replay on an outward facing network that it be protected by a VPN, firewall or other dedicated security device. 360 Systems makes no representations that the Instant Replay is secure against unauthorized outside access.

- Do not share usernames, passwords or other credentials with anyone outside of your network.

TABLE OF CONTENTS

INTRODUCTION	11
CAUTIONARY NOTICES	12
CHAPTER 1 – OVERVIEW	13
GENERAL	13
FRONT PANEL CONTROLS.....	13
<i>Hot-Keys</i>	<i>14</i>
<i>Power Button.....</i>	<i>14</i>
<i>Transport Control Buttons</i>	<i>15</i>
<i>Function Buttons.....</i>	<i>16</i>
<i>Setup and Configuration Buttons.....</i>	<i>16</i>
<i>ENTER:</i>	<i>16</i>
CHAPTER 2 – THE TOUCH SCREEN.....	18
HOME SCREEN	19
<i>Header Section</i>	<i>19</i>
<i>Time Section.....</i>	<i>19</i>
<i>Clip Section</i>	<i>19</i>
<i>Playlist Section.....</i>	<i>20</i>
<i>Information Section.....</i>	<i>20</i>
<i>Audio Control Section.....</i>	<i>20</i>
<i>Navigation Buttons.....</i>	<i>20</i>
RECORDING SCREEN.....	21
<i>Header Section</i>	<i>21</i>
<i>Information Section.....</i>	<i>21</i>
<i>Audio Control Section.....</i>	<i>22</i>
<i>Navigation Buttons.....</i>	<i>22</i>
CLIP / PLAYLIST SELECTOR SCREEN.....	22
<i>Header Section</i>	<i>23</i>
<i>Body</i>	<i>23</i>
<i>Navigation Buttons.....</i>	<i>23</i>
CLIP / PLAYLIST MANAGER.....	23
<i>Header Section</i>	<i>24</i>
<i>Body</i>	<i>24</i>
<i>Navigation Buttons.....</i>	<i>24</i>
NEW PLAYLIST	25
PLAYLIST SELECTOR	25
<i>Header Section</i>	<i>26</i>
<i>Body</i>	<i>26</i>
<i>Navigation Buttons.....</i>	<i>26</i>
FILE MANAGER.....	27
<i>Header Section</i>	<i>28</i>
<i>Body</i>	<i>29</i>
<i>Navigation Buttons.....</i>	<i>29</i>
NEW FOLDER.....	29
CLIP INFO.....	30
<i>Navigation Buttons.....</i>	<i>31</i>
EDIT CLIP.....	31
<i>Header Section</i>	<i>31</i>
<i>Body</i>	<i>31</i>

<i>Editor Section</i>	32
<i>Navigation Buttons</i>	32
BANK MANAGER	33
<i>Header Section</i>	33
<i>Body</i>	33
<i>Navigation Buttons</i>	33
PLAYLIST INFO.....	34
<i>Header Section</i>	34
<i>Body</i>	34
<i>Navigation Buttons</i>	34
EDIT PLAYLIST	35
<i>Header Section</i>	35
<i>Body</i>	35
<i>Navigation Buttons</i>	35
MAIN MENU	36
<i>Body</i>	36
<i>Navigation Buttons</i>	37
RECORD SETUP	37
<i>Body</i>	37
<i>Navigation Buttons</i>	38
PLAY SETUP	38
<i>Body</i>	38
<i>Navigation Buttons</i>	39
GLOBAL SETUP.....	39
<i>Body</i>	39
<i>Navigation Buttons</i>	40
GPI SETUP	40
<i>Body</i>	40
<i>Navigation Buttons</i>	40
GPO SETUP	41
<i>Body</i>	41
<i>Navigation Buttons</i>	41
DATE / TIME SETUP	42
<i>Body</i>	42
<i>Navigation Buttons</i>	42
NETWORK SETUP.....	42
<i>Body</i>	43
<i>Navigation Buttons</i>	43
USER ACCESS	44
<i>Settings</i>	44
<i>Navigation Buttons</i>	44
UTILITY MENU	45
BACKUP AND RESTORE	46
<i>Body</i>	47
<i>Navigation Buttons</i>	47
CHAPTER 3 –SETUP & CONNECTIONS	48
POWERING ON INSTANT REPLAY	48
<i>Power Button</i>	48
<i>Connecting Instant Replay to External Audio Equipment</i>	48
ELECTRICAL POWER	49
REAR PANEL CONNECTIONS	50
AUDIO CONNECTIONS	50

DIGITAL AUDIO CONNECTIONS.....	51
NETWORK CONNECTIONS	53
DANTE® MODULE INSTALLATION AND USE	53
<i>Content and File Types</i>	54
PERIPHERAL CONNECTIONS	54
CHAPTER 4 – PLAY & RECORD OPERATIONS.....	55
PLAYING A CLIP	55
<i>Load and Play a Single Clip</i>	55
<i>Play a Clip Using a Hot Key</i>	56
<i>Play a Clip Using the Hot List</i>	56
<i>Creating a New Hot-List</i>	56
<i>Playing a Hot-List</i>	57
<i>Clear a Hot-List</i>	57
<i>Play a Clip Using the rear-panel GPI</i>	57
<i>Pausing a Playing Clip</i>	57
RECORDING A CLIP	57
<i>To Record a Clip</i>	58
<i>Limiting the Record Time of a Clip</i>	58
CHAPTER 5 – WORKING WITH CLIPS AND PLAYLISTS	58
<i>Creating a Playlist</i>	58
<i>Editing a Playlist</i>	58
<i>Editing a clip</i>	59
<i>Assigning a Clip to a Hot Key</i>	60
<i>Using Hot-Key Banks</i>	60
<i>Replacing Clips with Existing Hot-Key Assignments</i>	60
<i>Locating a Clip Using Searches</i>	61
<i>Viewing Clip or Playlist Information</i>	61
<i>Previewing a clip</i>	61
<i>Looping a Clip or Playlist</i>	61
<i>Shuffle a playlist</i>	62
<i>Using the Record Sample Rate Converter</i>	62
CHAPTER 6 – BACKUP, RESTORE AND OTHER UTILITIES	64
<i>Backup</i>	64
<i>Restore</i>	64
<i>Create Log File</i>	65
<i>System Info</i>	65
<i>Clear Banks</i>	65
<i>Default Settings</i>	65
<i>System Reset</i>	66
<i>Firmware update</i>	66
CHAPTER 7 – FILE MANAGEMENT	67
<i>Built-in File Management</i>	67
<i>FTP Access</i>	69
<i>Windows File Sharing (Samba)</i>	69
<i>File Naming Conventions</i>	69
<i>Clip Management</i>	69
CHAPTER 8 – BANK MANAGEMENT	71
<i>Change the name of a Bank</i>	71

<i>Assigning Hot Keys</i>	71
<i>Clear a Hot Key</i>	71
<i>Clear a Hot List</i>	71
<i>Clear the Bank</i>	71
CHAPTER 9 – USING THE NETWORK	72
<i>Network Setup</i>	72
<i>Connect the Ethernet cable</i>	73
<i>Connecting to Instant Replay using FTP</i>	73
<i>Example of Connecting DOS FTP</i>	73
<i>Example FTP Transferring with Flash FXP</i>	77
<i>Example FTP Transferring with Filezilla</i>	79
<i>Using the File Share Feature</i>	80
CHAPTER 10 – SYSTEM UPDATE	82
<i>Updating the System Application</i>	82
APPENDIX A	83
CONNECTOR SPECIFICATIONS	83
<i>GPIO Connector Pinout</i>	83
APPENDIX B	88
TECHNICAL SPECIFICATIONS	88
APPENDIX C	89
MECHANICAL DRAWING.....	89
APPENDIX D	90
TROUBLE SHOOTING	90
APPENDIX E	91
BATTERY REPLACEMENT	91

INTRODUCTION

The Instant Replay 3 continues the advancement of 360 Systems' professional audio products. The Instant Replay 3 introduces a host of features to provide instant tactile access to audio play out. The Instant Replay 3 provides a unique combination of solid state storage, direct access to stored audio, network access and ease of operation, all in a professional quality package.

Key features include:

- ▶ Immediate access to 50 clips assigned to individual Hot-Keys
- ▶ Build on-the-fly playlists or organize and save playlists for use on Hot-Keys
- ▶ Familiar operational transport controls for easy operation.
- ▶ Full color touch screen.
- ▶ RGB lighting of Hot-Keys and buttons provide clip recognition and operating mode indication.
- ▶ Store and organize thousands of clips on the 32GB of internal memory.
- ▶ Expandable storage. Record and play using attached USB media.
- ▶ 16 and 24 bit WAV and MP3 support at sample rates of 44.1, 48, 88.2 and 96 KHz.
- ▶ Head and Tail editing.
- ▶ Variable Fade In and Fade Out.
- ▶ Dedicated function keys for quick access to common operations.
- ▶ Network Connectivity for uploading, downloading, renaming and deleting clips.

In most cases, units shipped from the factory contain sample audio files intended for testing and example purposes. These audio files are released under Public Domain, Creative Commons 0 or Creative Commons 3 licensees. If required, attribution and license type are located in the metadata of each file. Additional information may be obtained by contacting 360 Systems at info@360systems.com. Use of these file for any other reason or purpose may be in violation of the license.

Please visit <https://creativecommons.org/> for additional information and use of creative commons licensed files.

CAUTIONARY NOTICES

Power Supply:

The power supply utilized with this product is designed to handle the voltages and amperage necessary to operate the device. Use of an alternate supply may damage the unit and void the warranty.

USB Ports:

The USB ports on this device are a maximum of 1A and are designed for use with basic keyboards, mice, and memory sticks. These ports should not be used with large USB hard drives, LED keyboards, USB hubs (or keyboards with USB hubs), and should never be used as a charging port for other devices.

The USB port on the side of the LCD screen does not provide sufficient voltage to operate larger USB memory storage devices. Please use the rear USB ports.

WARNING: Failure to follow this notice may result in damage to the device and void the factory warranty.

The USB ports do not support mounting the Instant Replay internal storage on another device.

CHAPTER 1 – OVERVIEW



FIGURE 1

GENERAL

Each chapter in this manual contains various information regarding the ways to control and operate the system.

Since the system is designed to be intuitive, key labels and the interface provide substantial guidance on the operation of the system.

For most users, the information in the first two chapters should provide the basic information needed to operate the system. More detailed information on system operation is provided in later chapters and the appendices of this manual.

FRONT PANEL CONTROLS

Instant Replay's front panel controls are shown in Figure 1. Most of the buttons include an indicator light to show when they are in use. They are functionally grouped as follows:

- ▶ Hot-Keys
- ▶ Navigation Keys and Power Button

- ▶ Transport Control Buttons
- ▶ Function Buttons
- ▶ Setup and Configuration Buttons

These controls are described briefly in this section.

Hot-Keys

The 50 Hot-Keys provide the primary functionality for play out on the system. There are three functional uses for Hot-Keys:

1. Triggering playback of assigned Cuts
2. As an alphanumeric keyboard (in combination with the Navigation control buttons)
3. Bank selection (1 through 50)

The main array of 50 buttons are Hot-Keys numbered 1 through 50. A Hot-Key's primary function is to trigger playback of a clip assigned to the specific key. Hot-Keys light up or change color whenever their assigned Cut is playing. In certain modes, cued Hotkeys or Hotkeys with special operations pending will light in different colors indicating their state or operation.

In the Bank Select mode, the fifty Hot-Keys are used to select the corresponding Banks numbered 1 through 50. The banks are like pages of Hot-Keys. They extend the number of clips that can be assigned to Hot Keys to 2500 (50 Hot Keys times 50 Banks) and also provide a method for organizing clips.

Navigation Keys and Power Button

The bottom row of buttons on every screen allow the user to navigate to other areas of the interface or allow certain actions to be completed. Note that depending on the current state of the system, buttons may be enabled or disabled.

Power Button

The power button is located on the front panel.

- A short press of the power button (one to four seconds) initiates a normal power shutdown.
- Continuing to hold the power button down will force the immediate power off of the system.
- When the system is off, a short press of the power button will turn on the system power.

Transport Control Buttons

The Transport Controls include STOP, PLAY, PAUSE and RECORD as well as modification keys.

STOP:

Pressing STOP ends recording or playback. Pressing and holding STOP fades the clip down to a stop over a predetermined period of time.

PLAY:

PLAY Starts playback of the currently selected clip. Note that pressing Play initiates playback from the beginning of the selected Clip, even if it is already playing. The exception is when Play is used to disengage Pause or if a Clip is cued to a specific point.

RECORD:

RECORD Places Instant Replay in Record Ready mode. A default time stamped name is provided which can be changed any time prior to the actual start of the recording. Pressing Play initiates the recording which continues until a set time limit is reached (see Record Settings) or STOP is pressed. A Record Threshold value can be programmed to allow the recording to start when the input level rises to the threshold.

LOOP:

Loop causes a clip to repeat endlessly until either Stop or Loop is pressed. Stop ends playback immediately. Pressing Loop exits from the Loop mode, and allows the current Clip to continue playing to its end. Pressing Loop while running a Playlist will have different effects depending on whether the Follow On setting is set to MANUAL or FOLLOW ON. (See MANUAL setting for more information.)

Note: Loop on the keyboard only effects clips. To loop a playlist, use the LOOP soft button on the Home screen of the Touch Screen Display.

PAUSE:

Pause interrupts playback of a Clip. When pressed again, playback will resume.

FF (Fast Forward):

Pressing the button causes the playing clip to speed up the playout of the playing clip.

REW (Rewind):

Pressing the button causes the playing clip to speed up the playout of the playing clip in reverse.

FOLLOW ON:

Pressing the FOLLOW ON button causes the playout of certain playout functions to alter. Basically, if FOLLOW ON is lit, clips that play sequentially such as HOT-LISTS or playlists, will continue playing each clip in order until the list is complete.

If FOLLOW ON is off (MANUAL) clips that play sequentially such as HOT-LISTS or playlists, will stop at the end of each clip and wait for the user to press PLAY again.

Function Buttons

BANK SELECT:

The 50 Hot-Keys are stored in Banks. There are 50 Banks; this allows 2500 Clips to be programmed as Hot-Keys. When you press the Bank Select button, it lights and the Hot Keys change color. Pressing Hot-Keys 1-50 will directly select the corresponding Bank and load any assigned Hot Keys.

Note: Depending on how many keys are assigned, it may take a few seconds for the bank to load.

ASSIGN HOT-KEYS:

The Assign Hot-Keys button lights when pressed and the display prompts for selection of a Clip. Pressing a Hot-Key immediately assigns the selected Clip shown in the top line of the display to that Hot-Key, overwriting any previous assignment.

PREVIEW:

When Preview is pressed in Stop mode the main audio outputs are muted, so Clips played subsequently can be auditioned from the headphone output only. Both the analog and digital audio outputs are muted.

Setup and Configuration Buttons

MENU:

Pressing the Menu button when the system is Stopped, will open the Main Menu. Items in the Main Menu are described in the following sections.

CANCEL:

This button is used to end certain operations.

SCROLL UP/DOWN LEFT/RIGHT ARROWS:

Used for manual navigation of certain functions depending on the active screen.

TAB LEFT/RIGHT ARROWS:

Used for manual navigation of certain functions depending on the active screen.

FIND:

In certain clip navigation screen, the Find button will automatically place the cursor in the Search field. This allows for quick location of files on the screen.

ENTER:

Used to enter Menus, initiate operations, confirm choices on many of the screens.

HOT-LIST:

When the unit is idle, pressing the HOT-LIST button and subsequently pressing HOT-KEYS, will build a list of clips in the order that the HOT-KEYS are pressed. Pressing HOT-LIST again concludes the building process. Pressing HOT-LIST again displays the keys that are part of the HOT-LIST by lighting the associated keys. Pressing PLAY will start the playout of the HOT-LIST.

NOTE: Depending on if FOLLOW-ON is on or off (MANUAL) dictates if the next clip in the HOT-LIST will play automatically or stop after each clip.

NOTE: To clear an existing HOT-LIST, go to the Main Menu , open the Bank Manager screen, and select which Bank to clear the HOT-LIST from. Click CLEAR HOT-LIST.

CHAPTER 2 – THE TOUCH SCREEN

Although the main functions of the Instant Replay are executed through the keyboard, the touch screen enhances the functionality of the system by providing live information as well as additional features for maintaining the infrastructure of the system. This section covers details regarding each screen.

When navigating using the touch screen, the most common touch screen functions are available. Tapping the buttons on the screen will execute the buttons. Finger scrolling will move extended screens up/down or left/right as needed. Double tapping certain items will execute those items. In addition, arrows, tabs, enter and the hard buttons under the screen will also allow for quick navigation throughout the different screens.

Note that depending on the system state (playing, recording, idle, etc.) certain buttons or functionality may be disabled to prevent certain changes from being initiated.

The screens presented in the sections below may appear slightly different depending on the version of system software.

HOME SCREEN

The Home screen is the main interface for the Instant Replay 3 and contains information about currently loaded clips as well as provides soft keys for controlling clips and playlists, as well as headphone volume level control. The Home screen is aesthetically divided into several sections to allow for information to be presented in an easy to access manner.



Header Section

Clip Name: Displays the name of the currently loaded clip whether it is cued, or playing.

Time Section

The time section displays the Duration, Elapsed Time and Remaining Time depending on the mode of the loaded clip.

Clip Section

This section displays information about the currently loaded clip such as the bank and hot-key the clip is assigned to.

Next: Indicates the next clip to be played if one is selected. This field will be blank if there is no next clip.

MANUAL / FOLLOW ON button: Controls the mode the clip is in. This button affects what happens to a clip when it finishes playing dependent on the state of the LOOP. In general, with LOOP off, MANUAL mode causes a clip to halt at the end of its payout. With LOOP on, the clip would repeat payout until acted on. In FOLLOW ON mode, payout will continue if there is a NEXT clip in the cue. This could be from a Playlist, Hot-List or a next cued clip.

LOOP button: When on (green) this button (see also the physical keyboard LOOP button) will loop the currently loaded clip when played until this button is turned off.

Playlist Section

The playlist section provides the name of the playlist (if a clip from a playlist is currently loaded or as a next cued clip).

SHUFFLE button: Randomizes the payout of a loaded playlist.

LOOP button: When on (green), loops the currently loaded playlist. Note that if the LOOP button in the Clip section is enabled, the current clip will loop until the Clip section LOOP button is disabled.

Information Section

Various messages or alerts are displayed in this field in gold depending on the state of the system.

Audio Control Section

The audio controls include a scale to adjust the head phone volume and VU meters for visualizing the audio levels during payout.

PREVIEW button: The preview button turns off the main outputs leaving only the headphone output active. The PREVIEW button can only be activated when the system is idle.

Navigation Buttons

The bottom row of buttons on every screen allow the user to navigate to other areas of the interface or allow certain actions to be completed. Note that depending on the current state of the system, buttons may be enabled or disabled.

MENU button: Selection opens the Main Menu screen.

SELECT CLIP button: Selection opens the CLIP / PLAYLIST SELECTOR screen allowing the user to select a clip or playlist to be loaded.

CLIP INFO button: Selection opens the Clip Information screen for the clip that is currently cued.

PLAYLIST INFO button: Selection opens the Playlist Information screen if a playlist is loaded.

MANAGE CLIPS button: Selection opens the Clip / Playlist Manager screen.

NOTE: Depending on the mode the system is in, certain buttons may not be visible. This is done to prevent accidental changes.

RECORDING SCREEN

The Recording screen is only displayed when the RECORD button is pressed. Information about the recording is displayed during this operation.

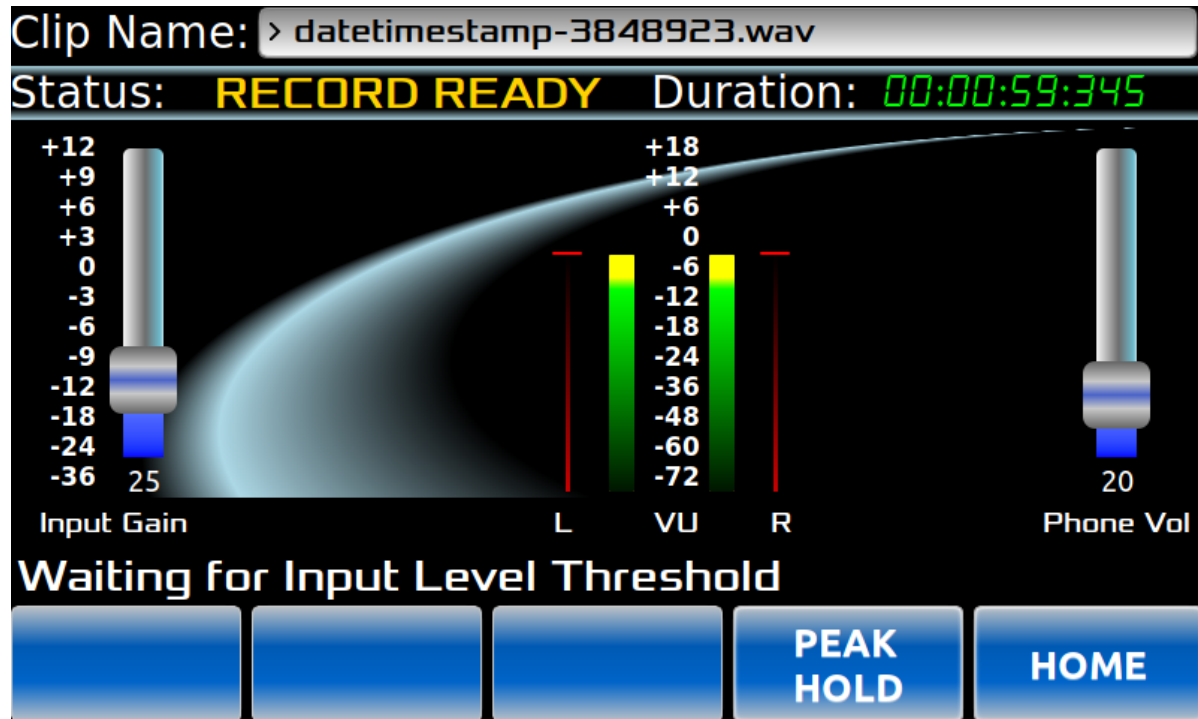

Header Section

Clip Name: When initially pressing the Record button on the keyboard, this field displays a generic, time stamped, clip name to be used for the recording. At any point before the Play button is pressed (which initiates the recording process) the Clip Name field can be selected so that the name can be edited.

Information Section

This section displays key information about the recording.

Status: Displays the status of the recording.

RECORD READY – Indicates a recording is cued but not in record.

RECORDING – Indicates a recording in progress.

Duration: Displays the elapsed recording time

Audio Control Section

Input Gain: The Input Gain slider allows adjusting of the input gain of the signal on the input to be recorded.

VU meters: Provide a visualization of the audio levels during recording.

Head Phone Volume: The audio controls include a slider to adjust the headphone volume.

Navigation Buttons

PEAK HOLD button: When turned on (**green**), the highest level for either the left or right channel is indicated by the bar to the left or right of the VU meters. The position is held for short period of time or until a higher value is reached.

When turned off (**blue**), the peak level indicators track with the VU level bars.

HOME button: Returns the user to the Home screen.

CLIP / PLAYLIST SELECTOR SCREEN

From the Home screen, click the SELECT CLIP button to open the Clip / Playlist Selector screen to select a clip or playlist to be loaded either for playout or placed as the next to be played if a clip is already playing.

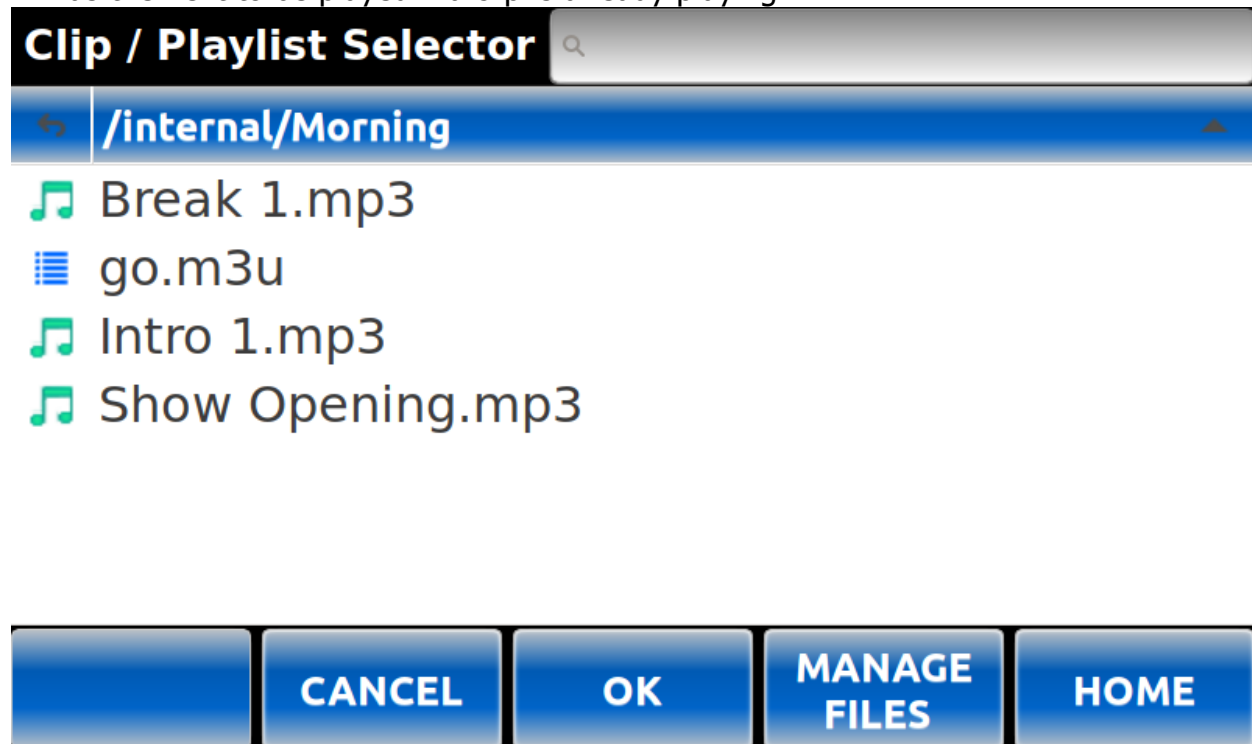

Header Section

Search Field: Typing the first few letters of the name of a file, folder or playlist will automatically locate to the first matching item in the current folder.

Body

The middle section of the screen shows the listing of the clips and playlists located in the current directory.

- Touching the bar that indicates the current directory, will re-sort the listing either ascending or descending.
- Touching the back arrow moves the listing up one level in the directory tree.
- Selecting the checkbox next to the back arrow selects or deselects all items in the current directory.
- Touching an item in the list automatically selects that clip as either the current clip or next clip depending on the state of the system.

Navigation Buttons

CANCEL button: Returns to the Home screen without taking any action.

OK button: Moves to the next folder if a folder is selected or if a clip is selected, returns to the Home screen and loads the clip that was selected. Has the same effect as pressing the Enter key on the keyboard.

MANAGE FILES button: Opens the File Manager screen.

HOME button: Selection re-opens the Home screen without taking any action.

CLIP / PLAYLIST MANAGER

From the Menu screen, the CLIP MANAGER button opens the Clip / Playlist Manager which can be used to perform basic tasks with regards to clips or playlists.

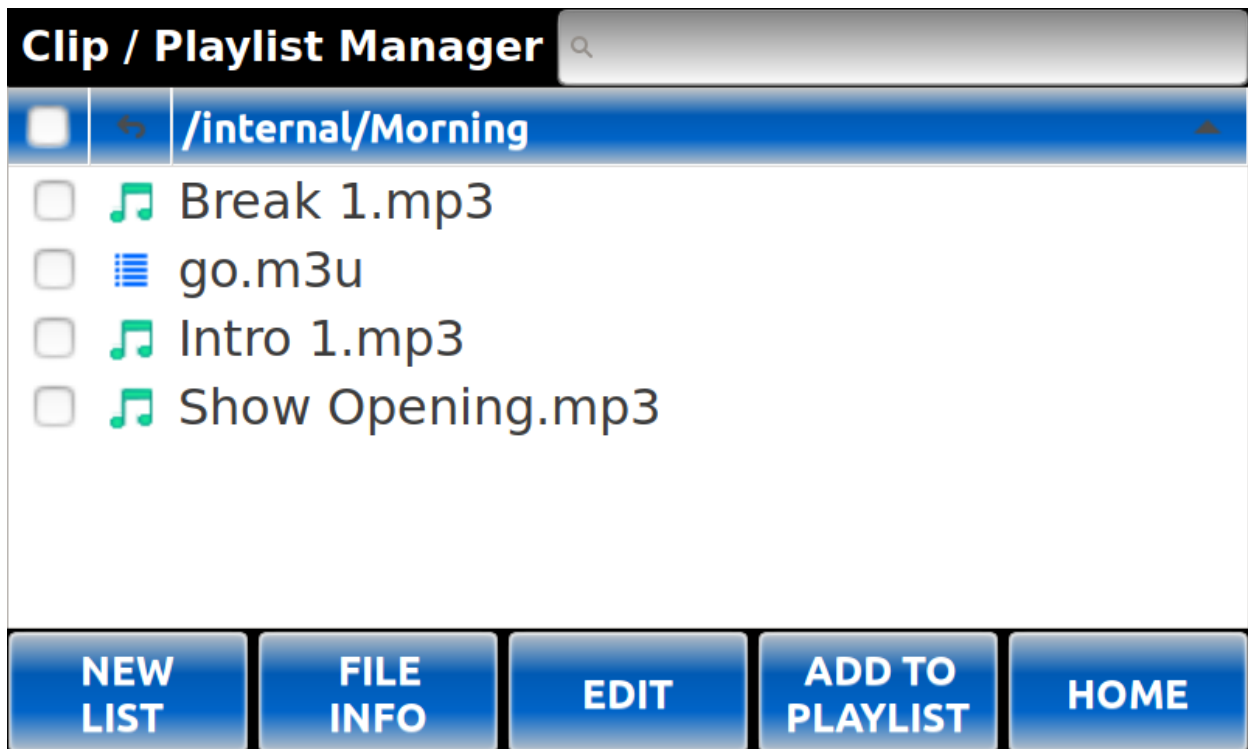

[Header Section](#)

Search Field: Typing the first few letters of the name of a file, folder or playlist will automatically locate to the first matching item in the current folder.

[Body](#)

The middle section of the screen shows the listing of the clips and playlists located in the current directory.

- Touching the bar that indicates the current directory, will re-sort the listing either ascending or descending.
- Touching the back arrow moves the listing up one level in the directory tree.
- Selecting the checkbox next to the back arrow selects or deselects all items in the current directory.
- Touching an item in the list highlights that item as selected for certain functions.
- Touching a checkbox next to an item or items in the list, cause those items to be selected for use with certain functions.

[Navigation Buttons](#)

NEW LIST button: If instead of selecting an existing playlist, a new playlist is required, the NEW LIST button prompts for the name of a new playlist which will be located in the current working directory.

FILE INFO button: Selection opens either the Clip Information screen or the Playlist Information screen depending on the selected file type.

Note: Selection is based on the highlighted file only.

EDIT button: Selection opens either the Edit Clip screen or the Edit Playlist screen depending on the selected file type.

Note: Selection is based on the highlighted file only.

ADD TO PLAYLIST button: Selection opens the Playlist Selector screen in order to add selected clip(s) to a playlist.

Note: Since multiple clips can be added to a playlist at a time, clips to be added to a playlist are all that have a checkmark next to them. The same clip can be added to a playlist multiple times.

HOME button: Selection opens the Home screen.

NEW PLAYLIST

When adding clips to a playlist from the Clip / Playlist Manager screen, the NEW LIST button can be used in the Playlist Selector screen to create a new, empty, playlist. The newly created playlist will then be available for selection.

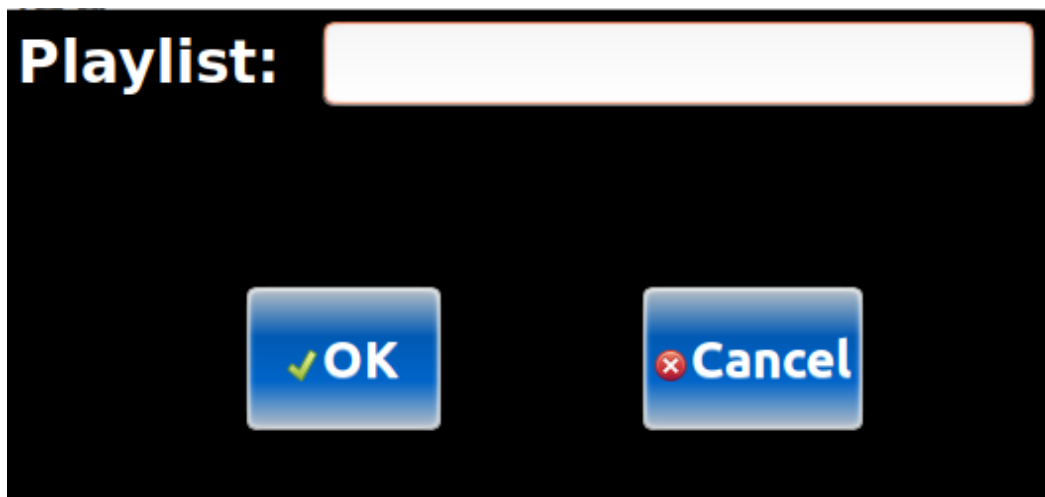

PLAYLIST SELECTOR

The Playlist Selector screen is presented when clips are selected from the Clip / Playlist Manager screen to be placed in a playlist. The Playlist Selector screen provides the ability to select a playlist no matter where it is located on the system.

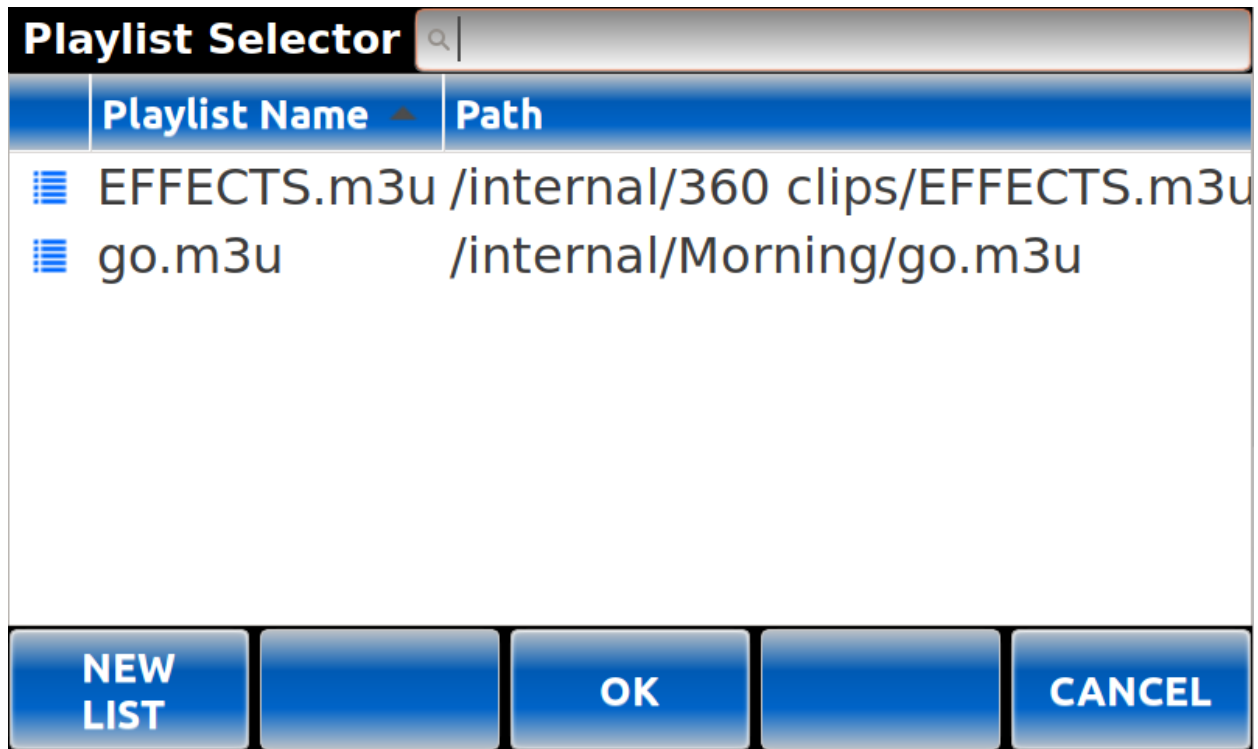

Header Section

Search Field: Typing the first few letters of the name of a file, folder or playlist will automatically locate to the first matching item in the current folder.

Body

The middle section of the screen shows the listing of the playlists located on the system.

- Touching the playlist name bar will re-sort the listing either ascending or descending.
- Touching a playlist in the list highlights that item as selected for certain functions.

Navigation Buttons

NEW LIST button: If instead of selecting an existing playlist, a new playlist is required, the NEW LIST button prompts for the name of a new playlist which will be located in the current working directory.

OK button: Touching the Ok button once a playlist has been selected, adds the previously selected clips to the playlist and returns to the Clip / Playlist Manager. (This has the same effect as double clicking on a playlist.)

CANCEL button: Closes the screen without adding clips to a playlist and returns to the Clip / Playlist Manager.

FILE MANAGER

From the Menu screen, the FILE MANAGER button opens the File Manager screen. The File Manager is much like a standard file manager used to organize clips on the internal system or on external USB devices.

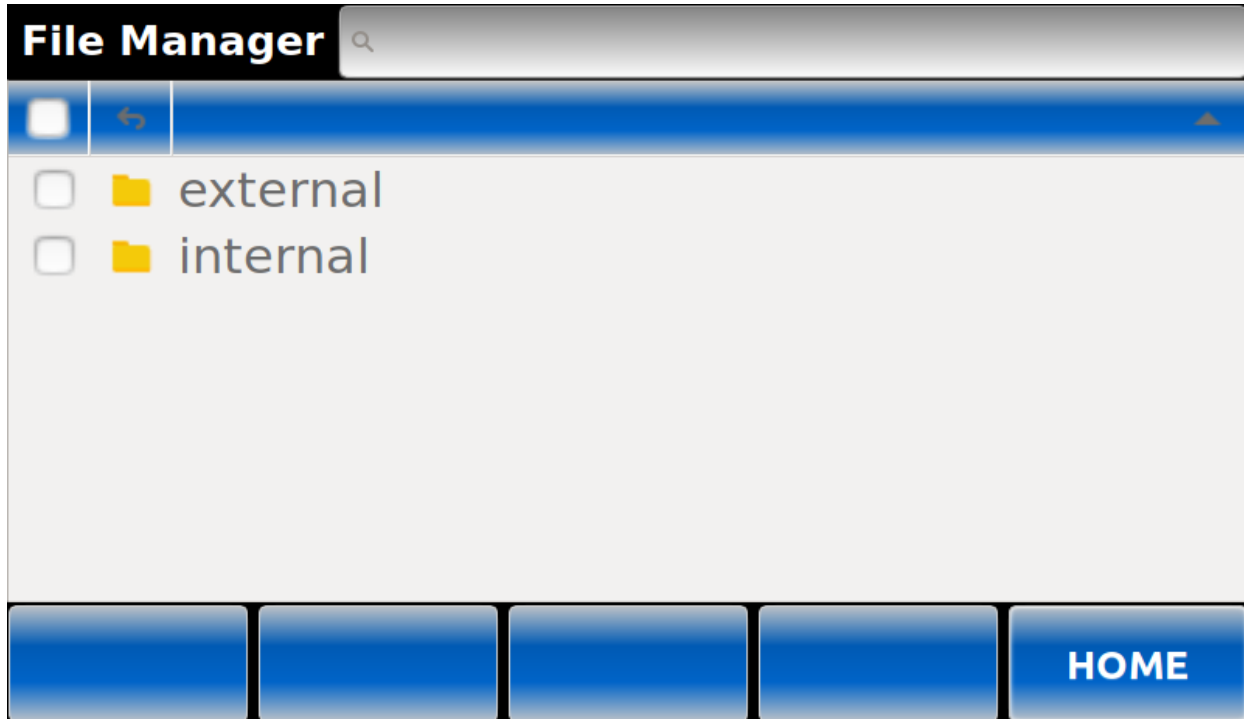

Note: At the top level of the directory tree, there are two main folders: The EXTERNAL folder is where any attached USB devices will show up. Note that only files that are .mp3, .wav or .m3u will be presented. The INTERNAL folder shows media stored on the internal memory.

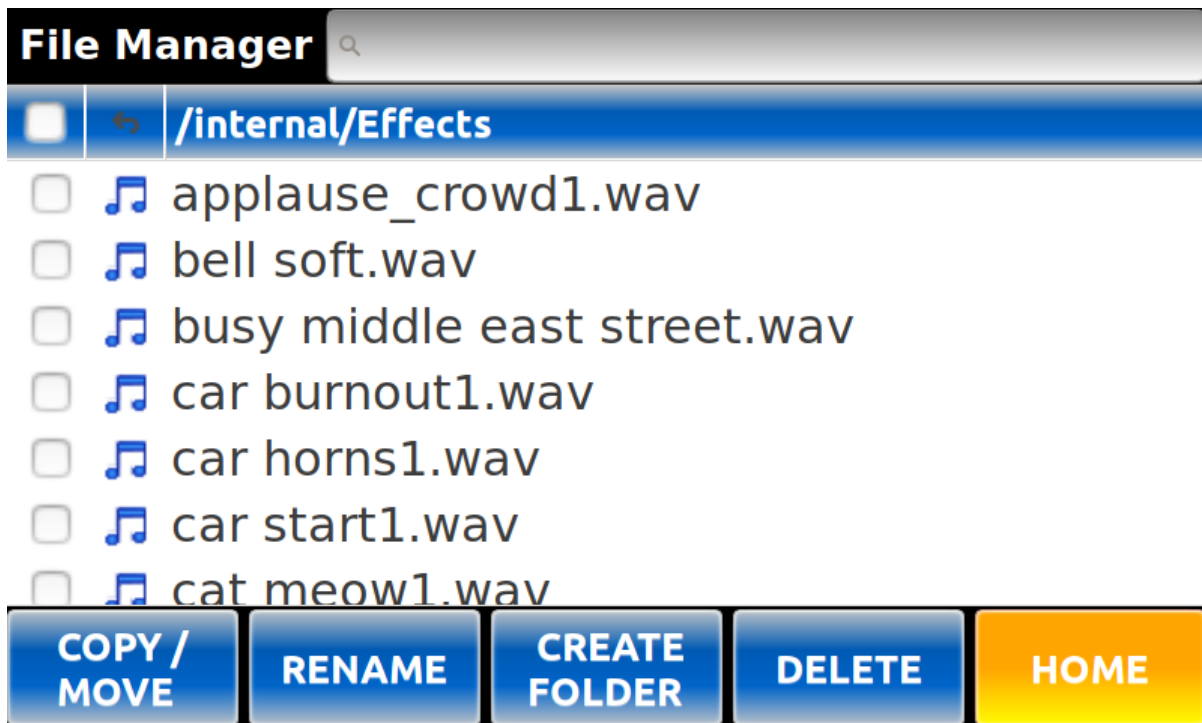

Sample – File Manager in normal mode

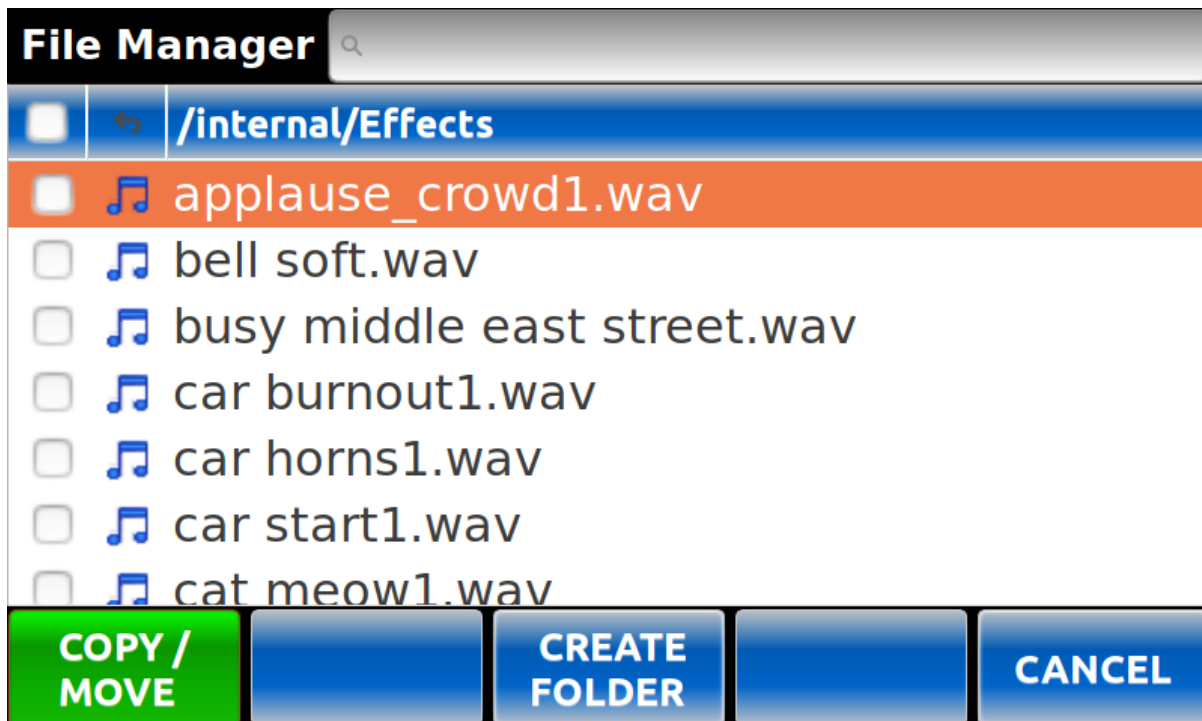

Sample - Copy / Move mode on

[Header Section](#)

Search Field: Typing the first few letters of the name of a file, folder or playlist will automatically locate to the first matching item in the current folder.

Select / Deselect All Check Box: Checking / unchecking this box selects / deselects all items in the current view.

Note: Certain functions only work with the currently selected (highlighted) item while other functions that allow multiple selections use the checkboxes. Ex. Copy/Move allow multiple selections so any check boxes that are marked will be included. Rename only acts on the selected item and ignores the checkboxes.

Back arrow: Clicking the back arrow will move to the next directory in the next level up.

Directory Location: Displays the current directory level. Tapping this bar will re-sort the items listed in ascending or descending alphabetical order.

Body

The middle section of the screen shows the listing of the clips and playlists located within the current directory.

- Touching the checkbox selects or deselects the item for use with certain functions.
- Touching an item in the list highlights that item as selected for certain functions.

Navigation Buttons

COPY / MOVE button: Selection prepares all "checked" items to be copied or moved to another location. The COPY / Move button will change color to **green** when pressed and all items will be unchecked. Navigating to another location and pressing the COPY / MOVE button again prompts for COPY or MOVE. The associated action is finished once selected.

RENAME button: Prompts for the renaming of the selected (highlighted) folder or file.

CREATE FOLDER button: Selection will prompt for a new folder name which will be added to the current directory.

DELETE button: Selection will remove the selected (highlighted) files or folders from the system. The user is prompted to confirm the action as there is no way to undo a deletion.

HOME button: Selection returns to the Home screen.

NEW FOLDER

From within the File Manager, the CREATE FOLDER button allows for the creation of a new folder in the directory structure.



CLIP INFO

From the Home screen, selecting CLIP INFO displays information about the current clip. This screen also displays the bank and HOTKEY information if the clip is assigned.

A screen titled "Clip Information" with a dark background and white text. The information displayed includes:
Clip: Morning.mp3
Path: /internal/Clips
Duration: 00:00:06.000 File Size: 24,584
Head: Tail:
Fade In: 00.500 Fade Out: 00.500
Sample Rate: 44100 Word Size: 24 bit
Artist:
Title:
Album:
At the bottom, there are five blue buttons: EDIT, MANAGE FILES, MANAGE CLIPS, and HOME.

Navigation Buttons

EDIT button: If the system is idle, the EDIT button will allow the current clip to be edited (see EDIT CLIP screen).

MANAGE FILES button: Opens the File Manager screen.

MANAGE CLIPS button: If the system is idle, selection will bring up the Clip Manager screen for further actions.

HOME button: Selection opens the Home screen.

EDIT CLIP

From the Clip Info or Clip Playlist Manager, the Edit Clip screen can be used to adjust the Head / Tail points of a clip or adjust the Fade In / Out points.

Note: Any edits are non destructive to the clip. The changes are written to metadata leaving all of the clip data intact.

The screenshot displays the 'Edit Clip' interface for a file named 'applause_crowd1.wav'. The screen is divided into several sections:

- Header Section:** Shows the original 'Length: 00:30:00.000' and the 'Edited Length: 00:01:39.900'.
- Position:** A text field containing '00:14:16.632'.
- Head and Tail:** Two text fields showing 'Head: 00:25:20.100' and 'Tail: 00:27:00.000', with a 'SAVE' button to the right.
- Fade In and Fade Out:** Two text fields showing 'Fade In: 00.000' and 'Fade Out: 00.050'.
- Timeline:** A horizontal bar representing the clip's duration from '00:00:00.000' to '00:30:00.000'. A yellow vertical line marks the current position at 00:14:16.632. A green vertical line marks the Tail point at 00:27:00.000, and a red vertical line marks the original end point at 00:30:00.000. A blue slider is positioned below the timeline.
- Navigation Buttons:** A row of five buttons: 'MARK IN', 'MARK OUT', 'CLEAR ALL EDIT DATA', 'BACK', and 'HOME'.

Header Section

Length: Displays the total unedited length of the clip.

Edited Length: Displays the length of the clip after changes are made to the Head and Tail points.

Body

Position: Displays the current position within the clip or this field can be edited directly to change the current position to a specific time.

- Head:** Displays the current position of the Head point or this field can be edited directly to change the current position to a specific time.
- Tail:** Displays the current position of the Tail point or this field can be edited directly to change the current position to a specific time.
- Fade-in:** Displays the current position of the Fade-in point or this field can be edited directly to change the current position to a specific time.
- Fade-out:** Displays the current position of the Fade-out point or this field can be edited directly to change the current position to a specific time.
- SAVE button:** Once changes are made, clicking the SAVE button writes the changes to the file.

Editor Section

The editor section consists of a timeline and a slider.

The timeline displays the current position in **yellow**, the Head or Fade-in point in **green** and the Tail or Fade-out point in **red**.

The slider can be used to set the current position within the clip.

Note: Other transport controls such as Fast Forward and Rewind can be used to set position as well.

Navigation Buttons

MARK IN button: Sets the current position to the Head position.

MARK OUT button: Sets the current position to the Tail position.

CLEAR ALL EDIT DATA button: Resets all positions to their original state.

BACK button: Returns to the Clip / Playlist Manager screen.

HOME button: Selection opens the Home screen.

BANK MANAGER

From the Menu screen, click the BANK MANAGER button to open the Bank Manager screen. This displays the list of clips assigned to each key on the selected Bank.

The screenshot shows the 'Bank Manager' interface. At the top, it displays 'Bank Number: 1' with minus and plus buttons, and 'Total Keys Assigned: 10'. Below that is 'Bank Name: > Afternoon Show'. A table lists keys and their assigned clips and paths. At the bottom are five buttons: ASSIGN, CLEAR HOTKEY, CLEAR HOTLIST, CLEAR BANK, and HOME.

KEY	CLIP / PLAYLIST	PATH
1	Show Opening.mp3	/internal/Morning
2	Intro 1.mp3	/internal/Morning
3	NONE	---
4	Break 1.mp3	/internal/Morning
5	NONE	---

Header Section

Bank Number: Used to change the bank for which information should be presented.

Note: Selecting a different bank from this screen does not change the loaded active bank.

Total Keys Assigned: Displays the total number of keys on the selected bank that have clips assigned to them.

Bank Name: Displays the name of the Bank. This field can be edited directly.

Body

This section displays all of the keys and associated clips assigned to those keys within the selected bank.

Navigation Buttons

ASSIGN button: If a KEY line is selected, opens from the Clip Playlist Selector and assigns the selected clip or playlist to the selected KEY.

CLEAR HOTKEY button: Clears the clip from the selected KEY.

CLEAR HOTLIST button: Clears all keys from a Hot-List if one exists.

CLEAR BANK button: Removes all assignments from all 50 keys on the selected bank.

HOME button: Selection opens the Home screen.

PLAYLIST INFO

From the Clip / Playlist Manager screen, select a Playlist and click File Info. The Playlist Information screen displays and allows editing of a playlist when the system is stopped.

Playlist Information	
Playlist Name: Playlist A.m3u	
File Name	Path
bell soft.wav	internal/Effects
busy middle east street.wav	internal/Effects

EDIT [Empty Button] DELETE PLAYLIST MANAGE CLIPS HOME

Header Section

Playlist Name: Displays the name of the playlist.

Bank: Displays the number of the first Bank the playlist is assigned in.

Key: Displays the number of the key on the associated bank the playlist is assigned to.

Body

This section displays all of the clips within the playlist.

Note: Any clips that are missing are displayed in red.

Navigation Buttons

EDIT button: Opens the Edit Playlist screen for the selected playlist.

DELETE PLAYLIST button: Deletes the selected playlist. **WARNING:** This is a permanent action.

MANAGE CLIPS button: Returns to the Clip / Playlist Manager screen.

HOME button: Selection opens the Home screen.

EDIT PLAYLIST

From either the Clip / Playlist Manager or Playlist Information screen, select EDIT. This screen allows for moving or deleting clips within the selected playlist.



Header Section

Playlist Name: Displays the name of the playlist. This field can be directly edited.

Body

This section displays all of the clips within the playlist.

Note: Any missing clips are displayed in red.

Check boxes can be used to select / deselect all or some of the clips in the playlist.

Navigation Buttons

MOVE UP button: Moves the highlighted clip up in the list one line.

Note: Check boxes are ignored.

MOVE DOWN button: Moves the highlighted clip down in the list one line.

Note: Check boxes are ignored.)

DELETE SELECTED button: Deletes the checked clip(s) from the playlist.

WARNING: Deleting a clip from a playlist does not delete the clip from the system, however, there is no "UNDO" for this type of deletion and the playlist is updated immediately.

Note: Highlighted clips are ignored unless they are checked.

MANAGE CLIPS button: Returns to the Clip Manager screen.
HOME button: Returns to the Home screen.

Note: To add clips to a playlist, use the Clip / Playlist Manager screen.

MAIN MENU

From the Home screen, click MENU button to open the Main Menu which provides access to settings and functions used on the device.



Body

This section displays buttons that allow access to settings and manipulation of the content on the device.

RECORD SETUP: Displays the screen where the record settings can be altered.

PLAY SETUP: Displays the screen where settings related to playout can be altered.

GLOBAL SETUP: Displays the screen that shows settings that impact the system globally.

GPI SETUP: Displays the screen that allows the assignment of functions to GPI's.

GPO SETUP: Displays the screen that allows the assignment of functions to GPO's.

DATE / TIME: Displays the screen that allows changing of date and time settings.

NETWORK SETUP: Displays the screen that allows altering that network settings for the device.

USER ACCESS: Displays the screen that allows changing the FTP and file share access and user name and password for each.

UTILITY MENU: Displays the screen that

BANK MANAGER: Displays the screen that shows information about a bank and allows changing hot key assignments.

CLIP MANAGER: Displays the screen that allows the selection of media for information or editing.

FILE MANAGER: Displays the screen that allows organization of media and folders on the system and externally connected devices.

Navigation Buttons

POWER OFF button: Graceful shutdown of the device.

HOME button: Returns to the Home screen.

RECORD SETUP

From the Menu screen, the RECORD SETUP button opens a window where the settings related to recording can be altered.

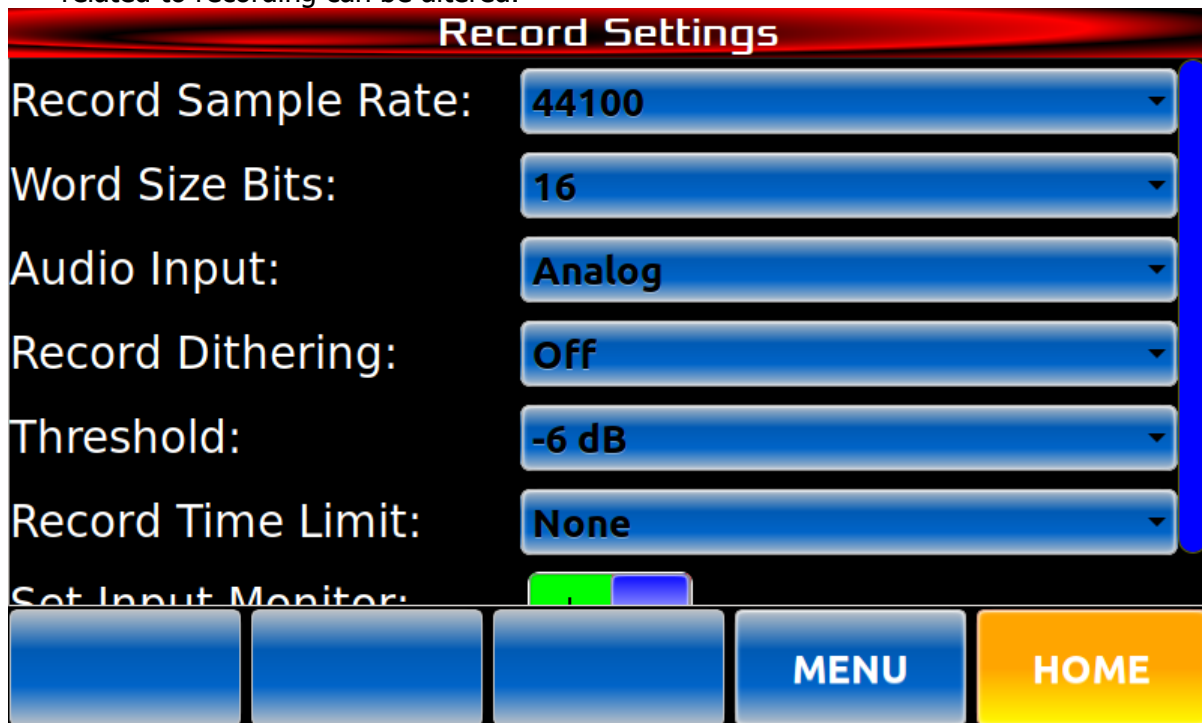

Body

Record Sample Rate: The record sample rate follows the Playout Sample Rate.

Word Size Bits: The following recording bit rate selections are available.

- a. 16
- b. 24

Audio Input: The following input sources may be selected.

- a. Analog
- b. AES/EBU
- c. IEC-958 Type II RCA
- d. Dante[®]

Record Dithering: Set if record dithering is off or set to dither DigIn 24 or 16.

Threshold: Set the threshold that a input level must reach for a recording to be started. Range is from "OFF" or -6db to -60db.

Record Limit: Set the length of time a recording will go for before it is automatically stopped.

Input Monitor: Turn the Input Monitor "ON" or "OFF".

Navigation Buttons

MENU button: Returns to the main menu.

HOME button: Returns to the Home screen.

PLAY SETUP

From the Menu screen, the Play Setup screen allows for settings related to the payout from the device to be altered.

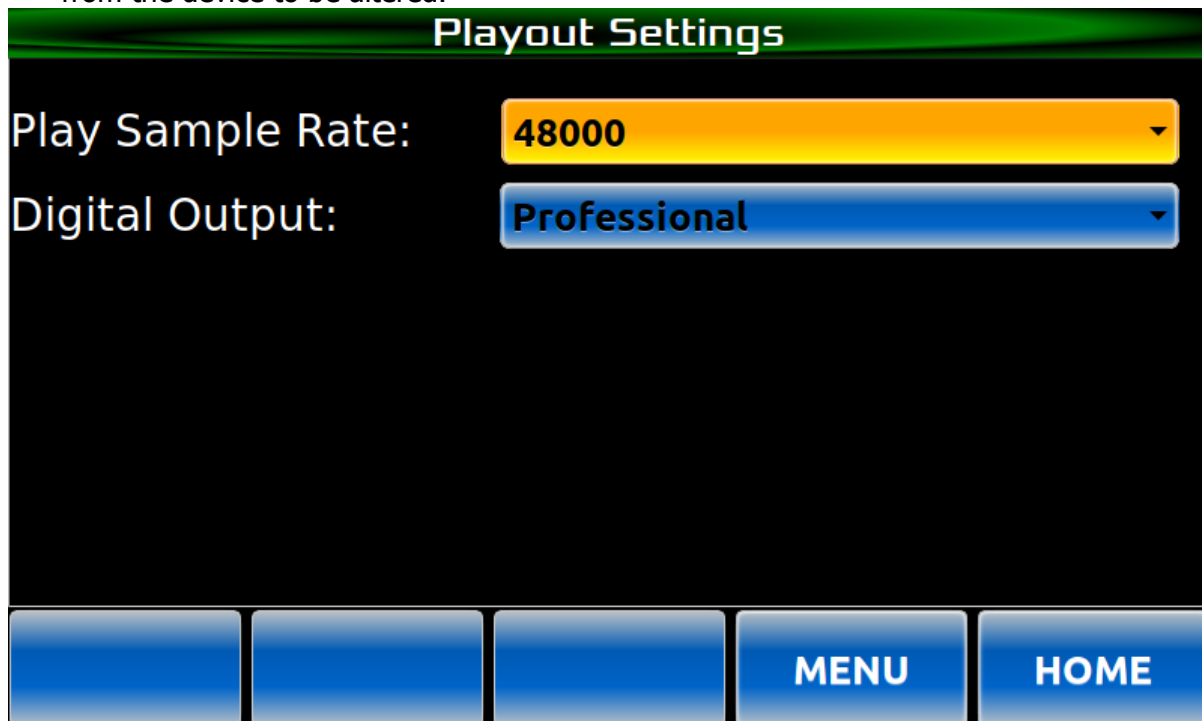

Body

Play Sample Rate: The following playout sample rates can be set.

- a. 48000

- b. 44100
- c. 88200
- d. 96000
- e. Convert to Digin RCA
- f. Convert to Digin XLR-3

Digital Output: The following selections can be made for the digital output format.

- a. Professional
- b. Consumer

Navigation Buttons

MENU button: Returns to the main menu.

HOME button: Returns to the Home screen.

GLOBAL SETUP

From the Menu screen, the Global Setup screen displays settings that affect the overall system and allows the user to alter as necessary.

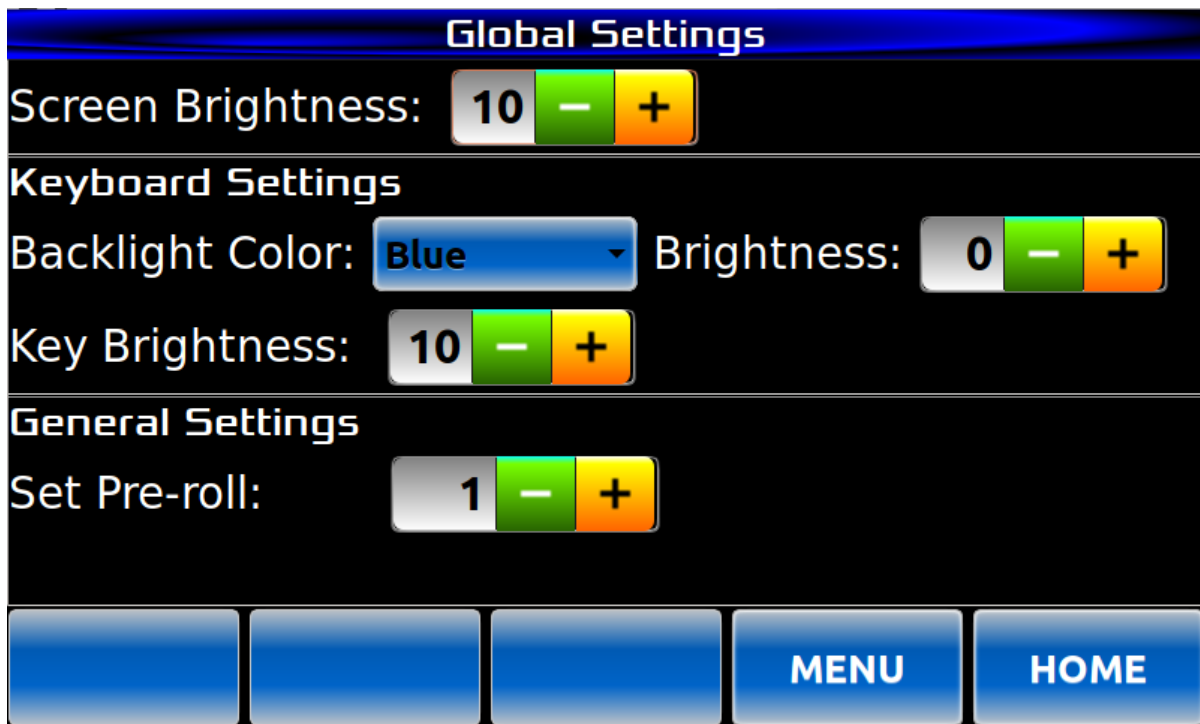

Body

LCD Brightness: This setting adjusts the brightness of the LCD screen.

Backlight Color: Determines the color the keys will light up to provide a backlight.

Brightness: Adjusts the backlit key brightness. A level of 0 is off and the highest brightness level will not exceed that of key function colors.

Key Brightness: Adjusts the brightness of the keys that are active.

Set Pre-roll: Adjusts the amount of pre-roll for payout.

Navigation Buttons

MENU button: Returns to the main menu.

HOME button: Returns to the Home screen.

GPI SETUP

From the Home screen, the Clip / Playlist Selector can be used to select a clip or playlist to be loaded either for payout or placed as the next to be played if a clip is already playing.



Body

GPI 1 - 6: The dropdown for each GPI allows for the selection of one of the following functions to be assigned to a specific GPI.

- a. Play
- b. Pause
- c. Stop
- d. Record
- e. Loop
- f. None

Navigation Buttons

MENU button: Returns to the main menu.

HOME button: Returns to the Home screen.

GPO SETUP

From the Home screen, the Clip / Playlist Selector can be used to select a clip or playlist to be loaded either for playout or placed as the next to be played if a clip is already playing.



Body

GPO 1 - 6: The dropdown for each GPO allows for the selection of one of the following player states to be assigned to a specific GPO.

- a. Playing
- b. Paused
- c. Stopped
- d. Record
- e. Looped
- f. None

Navigation Buttons

MENU button: Returns to the main menu.

HOME button: Returns to the Home screen.

DATE / TIME SETUP

From the Menu screen, the Date and Time screen allows adjusting of the date, time and time zone information as well as receiving automatic updates from a time server.

Date and Time Settings

Current Date and Time:

Hour: 12 - + Minutes: 39 - +

Month: 6 - + Day: 2 - + Year: 2022 - +

Time Zone Region: America

Zone: Los_Angeles

Automatic Time Update:

Automatic mode must be off to adjust time.

APPLY [] [] MENU HOME

Body

Note: If Automatically Update Time is on, time and date settings are locked out.

Hour, Minutes, Month, Day & Year: These settings can be adjusted to match the desired system time.

Time Zone Region: Adjusts the region of the world as desired.

Zone: Sets the time zone within the selected region.

Automatically Update Time: Determines if the time should be set manually (off) or time should be retrieved from a time server (on).

Navigation Buttons

APPLY button: Commits any changes that are not made live.

MENU button: Returns to the main menu.

HOME button: Returns to the Home screen.

NETWORK SETUP

From the Menu screen, the Network Settings screen allows the setting of the IP address and other network related settings for the device.

The screenshot shows a 'Network Settings' window with a dark background and light text. At the top, the title 'Network Settings' is centered. Below it, there are several settings:

- Use DHCP:** A toggle switch is currently turned on, indicated by a green bar on the left and a blue bar on the right.
- Hostname:** A text field containing '360-it-vm18'.
- IPv4 Address:** A text field containing '192.168.3.40'.
- Subnet Mask:** A text field containing '255.255.255.0'.
- Gateway IP:** A text field containing '192.168.3.254'.
- DNS Server 1:** A text field containing '192.168.3.1'.
- DNS Server 2:** A text field containing '192.168.3.3'.

At the bottom of the window, there are five blue buttons with white text: 'APPLY', an empty button, another empty button, 'MENU', and 'HOME'.

Body

Use DHCP: If turned on, and IP address will be assigned by a DHCP server on the network. If turned off, a static IP address and associated information can be assigned.

Note: If DHCP is turned on, IP address information is shown but will not be editable.

Hostname: The name of the system as seen on the network.

Note: A hostname must be entered for networking to function.

IPv4 Address: Displays / Sets the IP address for the system

Subnet Mask: Displays / Sets the subnet mask.

Gateway Address: Displays / Sets the router or gateway address.

DNS Server 1 and 2: Displays / Sets the DNS server(s) to be used by the system.

NTP Servers: Displays / Sets the NTP server(s) to be used for setting the system time.

Note: Multiple NTP servers may be added, space separated.

Navigation Buttons

APPLY button: Commits any changes that are not made automatically.

MENU button: Returns to the main menu.

HOME button: Returns to the Home screen.

USER ACCESS

From the Menu screen, the User Access screen is used to turn FTP and File Sharing on or off and define the user names and passwords for both.

Note: A user name and password must be entered in order to enable FTP or File Share.

User Access Settings

FTP Access: File Share Access:

FTP User: 360USER

FTP Password:

File Share User: 360USER

File Share Password:

Press "APPLY" after altering User Names or Passwords to save changes.

APPLY [] [] MENU HOME

Settings

FTP Access: If turned on, allows FTP access to the system. A user name and password must be supplied.

File Share Access: If turned on, allows the system to show up as a mapable network drive.

FTP User: The user name for FTP access.

FTP Password: The password for FTP access.

File Share User: The user name for access to the network file share.

File Share Password: The password for access to the network file share.

Navigation Buttons

APPLY button: Commits any changes that are not made automatically such as setting the Username and Password.

MENU button: Returns to the main menu.

HOME button: Returns to the Home screen.

UTILITY MENU

WARNING – Please read the following carefully. Functions provided in this section can irreversibly remove settings and content from the system.



BACKUP button: Displays the screen that allows the backup of content and settings on the device.

RESTORE button: Displays the screen that allows the restoration of content and settings to the device.

CREAT LOG FILE button: Creates and archive of the system logs and places them in the log.tgz file in the root directory. The log.tgz file can then be accessed from FTP or file sharing for retrieval.

SYSTEM INFO button: Displays information about the system.

CLEAR BANKS button: Removes all clips from all Banks.

DEFAULT SETTINGS button: Restores just the settings back to factory default leaving the content on the system.

SYSTEM RESET button: Resets the entire system back to factory default removing all settings and content.

FW UPDATE button: Places the system in a mode where new firmware can be loaded from an external USB key. The new firmware must be in the root directory of the USB key and the USB key must be the only external data drive attached to the system. See the System Update section for more information.

HOME button: Returns to the HOME screen.

BACKUP AND RESTORE

The Backup and Restore screens are provided as a simple way to backup the System Content, Systems Settings and HotKey Mappings.

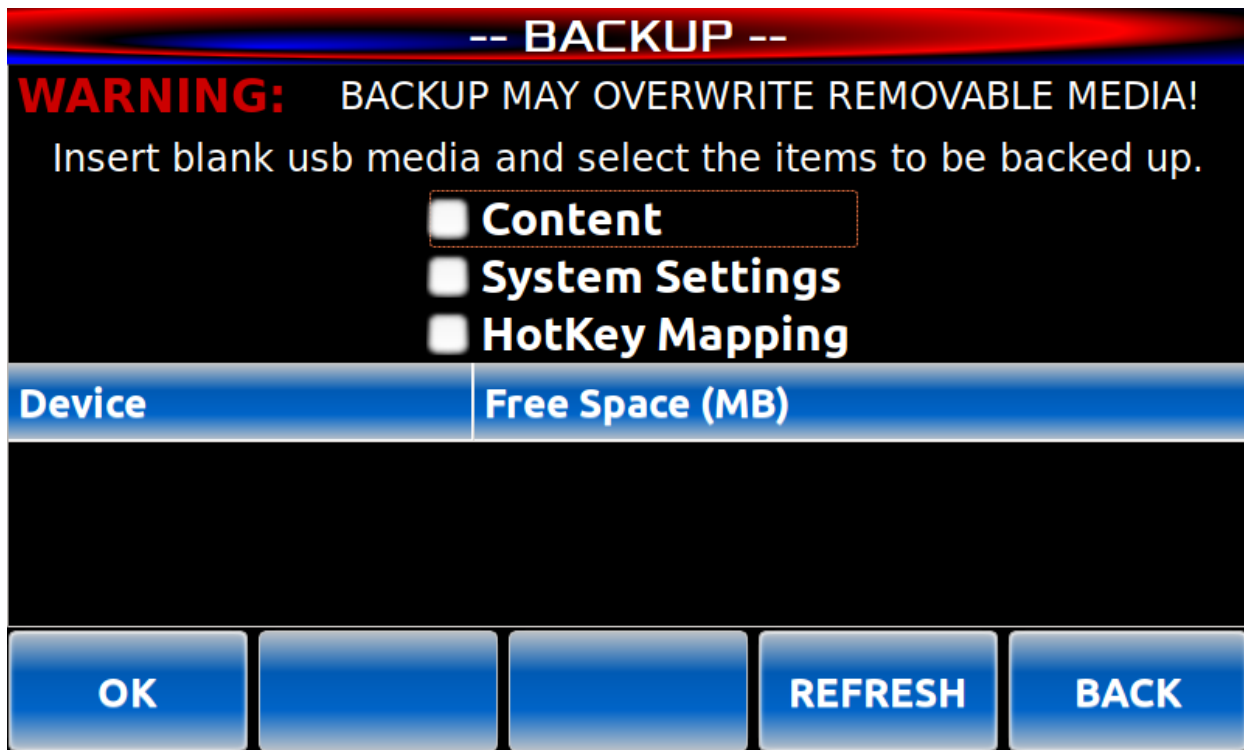

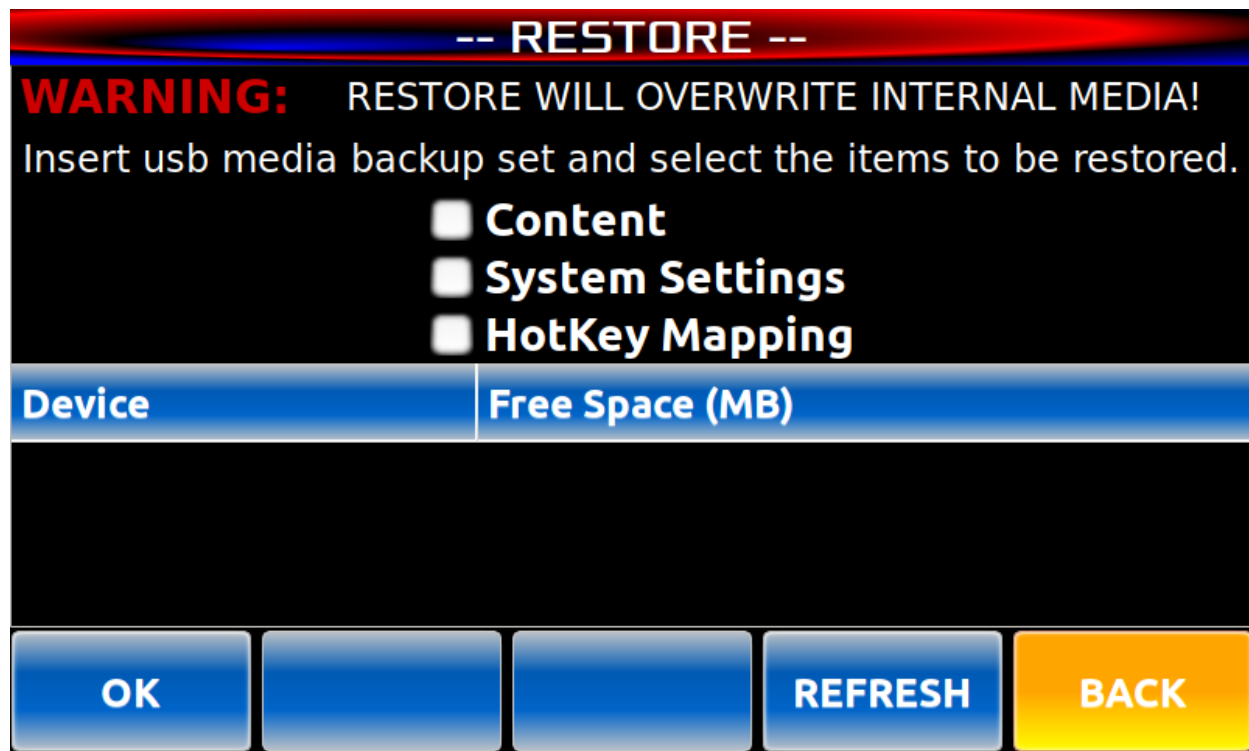

Body

Check Boxes: Check the boxes for the items that are to be backed up onto external media or restored from external media.

Device Selection: Select the device for backing up to or restoring from.

Navigation Buttons

OK button: Confirms the selections and initiates the process.

REFRESH button: Refreshes the list of available external media.

HOME button: Returns to the Home screen.

CHAPTER 3 –SETUP & CONNECTIONS

Instant Replay is an extensively featured, high quality professional audio workstation. However, it is also very simple and intuitive to use. In most cases, following the description for each button function mentioned in the previous chapters provides a good understanding of the system operation. The following sections cover the Instant Replay's basic operation.

POWERING ON INSTANT REPLAY

CAUTION!

ONLY A 360 SYSTEMS APPROVED POWER SUPPLY SHOULD BE USED WITH THIS SYSTEM. FAILURE TO USE A PROPERLY RATED POWER SUPPLY MAY CAUSE DAMAGE TO THE SYSTEM. CONNECT THIS PRODUCT ONLY TO AN AC POWER SOURCE WITHIN THE VOLTAGE AND FREQUENCY RANGE INDICATED ON THE POWER SUPPLY. THE PRODUCT IS SUPPLIED WITH A DETACHABLE IEC TYPE AC LINE CORD APPROPRIATE TO THE COUNTRY TO WHICH THE UNIT WAS ORIGINALLY DELIVERED. CHECK TO SEE THAT IT MATCHES THE ELECTRICAL OUTLET YOU WILL BE USING.

- Connect the supplied power supply to the rear panel and plug it into an AC power outlet.

WARNING:

REPLACE POWER CORD ONLY WITH UNDERWRITERS LABORATORIES (UL) LISTED CORD OF EQUIVALENT TYPE AND RATING!

Power Button

The power button is located on the front panel.

- A short press of the power button (one to four seconds) initiates a normal power shutdown.
- Continuing to hold the power button down will force the immediate power off of the system.
- When the system is off, a short press of the power button will turn on the system power.
- Instant Replay will run through a power up sequence that includes lighting each front panel indicator in sequence.
- The display will show the Home screen and display Initializing.
- Once the initialization is complete, the clip that was last loaded will display and the system is ready to use.

Connecting Instant Replay to External Audio Equipment

The rear panel of the Instant Replay is shown below.

Connecting Input Sources

Connect Balanced stereo analog sources to the BALANCED INPUT stereo pair.
Connect Unbalanced stereo analog sources to the UNBALANCED IN stereo pair.

Note: These inputs are mixed together internally and are both active whenever the AUDIO Input is set to ANALOG.

Connect a digital AES/EBU source to the AES/EBU DIGITAL IN connection.
Connect a digital IEC-958 RCA source to the IEC-958 II RCA jack.
Connect a PoE (Power Over Ethernet) switch cable to the Dante module if it exists.

The input source used for recording is selected via the Record Settings in the main menu.

Connecting Monitoring Equipment

Connect Balanced stereo analog monitors to the BALANCED OUTPUT stereo pair.
Connect Unbalanced stereo analog monitors to the UNBALANCED OUT stereo pair.
Connect a digital AES/EBU monitor to the AES/EBU DIGITAL OUT connection.
Connect standard stereo headphones to the ¼" headphones jack.

Note: Audio will be played on all outputs at all times with one exception. When the PREVIEW key is lit, audio will be played only to the headphone output.

ELECTRICAL POWER

CAUTION!

ONLY A 360 SYSTEMS APPROVED POWER SUPPLY SHOULD BE USED WITH THIS SYSTEM. FAILURE TO USE A PROPERLY RATED POWER SUPPLY MAY CAUSE DAMAGE TO THE SYSTEM. CONNECT THIS PRODUCT ONLY TO AN AC POWER SOURCE WITHIN THE VOLTAGE AND FREQUENCY RANGE INDICATED ON THE POWER SUPPLY. THE PRODUCT IS SUPPLIED WITH A DETACHABLE IEC TYPE AC LINE CORD APPROPRIATE TO THE COUNTRY TO WHICH THE UNIT WAS ORIGINALLY DELIVERED. CHECK TO SEE THAT IT MATCHES THE ELECTRICAL OUTLET YOU WILL BE USING.

WARNING:

REPLACE POWER CORD ONLY WITH UNDERWRITERS LABORATORIES (UL) LISTED CORD OF EQUIVALENT TYPE AND RATING!

Power Button

The power button is located on the front panel.

- A short press of the power button (one to four seconds) initiates a normal power shutdown.
- Continuing to hold the power button down will force the immediate power off of the system.

Note: this method should only be used in the event that the unit cannot be shutdown using the short press method or powering off from the main interface.

- When the system is off, a short press of the power button will turn on the system power.

Fuses

The fuses in this product are not user replaceable. Failure of a fuse is an indication of other component failure, and will require service by a qualified repair technician. Contact 360 Systems, or your 360 Systems distributor.

REAR PANEL CONNECTIONS



INSTANT REPLAY REAR PANEL

AUDIO CONNECTIONS

NOTE: The Balanced and Unbalanced analog inputs are mixed together. It is not recommended that both be connected at the same time, unless one or the other is muted.

Analog XLR Audio Inputs

The Balanced Analog Inputs are a pair of female XLR-3 connectors marked Left and Right. Input cables should be wired as follows:

XLR Connector Pin	Balanced Connection	Unbalanced Connection
PIN 1	COMMON	GROUND
PIN 2	+ INPUT	SIGNAL
PIN 3	- INPUT	No Connect

XLR INPUT AND OUTPUT CONNECTIONS

Analog XLR Audio Outputs

The Balanced Analog Outputs are a pair of male XLR-3 connectors. The output is electronically balanced, and is capable of driving loads of 600 ohms or greater. Output cables should be wired the same as shown above for the inputs.

[Analog RCA Audio Inputs](#)

The unbalanced Audio Inputs are provided on a pair of female RCA connectors.

[Analog RCA Audio Outputs](#)

The unbalanced Audio Outputs are provided on a pair of female RCA connectors.

[Headphone Output](#)

The Headphone Output always carries the same signal as the Main outputs, but its level is controlled by the Headphones Level control on either the Home screen or the Record screen.

When the Preview button is activated in Stop mode, the Headphone Output is active and the Main Outputs are turned off during subsequent playback. It may be helpful to use the Headphone Output for control room monitoring, while the Main Outputs provide the main feed to a mixer or transmitter.

DIGITAL AUDIO CONNECTIONS

[AES/EBU Input](#)

An XLR-3 female connector is provided for digital input in the AES/EBU format. There is a Sample Rate Converter built in to Instant Replay. Use only special AES cable having an impedance of 110 ohms. Limit the cable run to 100 feet. Do not use microphone cables for runs of over 6 feet.

[IEC 958 Type II Input](#)

An RCA "phono" connector provides a digital input from consumer or semi-pro equipment. Most equipment with connectors marked "S/P DIF" can be connected to this input.

Use only low-capacitance 75Ω coaxial cable, such as those made for video connection between VCRs and television video inputs. Do not use audio cables with RCA connectors.

[Digital Audio Interfacing](#)

Should Instant Replay detect a mismatch at its digital audio ports when preparing to record, the PLAY button is disabled and an error message, INTERFACE MISMATCH, appears in the display. Possible mismatches can include professional/consumer data format conflicts, non-audio data and data flagged as invalid. Copyright Protected data ("SCMS") will cause a similar error message. Correct the mismatch as necessary.

Another mismatch condition can arise between the selected RECORDING FORMAT and the sample rate of the incoming digital audio. The 48K Linear format requires the digital audio to be input from a 48K source. The 44.1K Linear format requires digital audio to be input from a 44.1K source.

Some digital audio equipment does not correctly output audio data or flags. Also, the data might be flagged as invalid when not in play mode. This is most common in consumer CD players with digital outputs. The following techniques may help:

- Put the device in Play and Pause before pressing Play on Instant Replay to start recording.
- Put the device in play and "cue" or "scan" backwards until the previous audio selection is heard, or in the case of CDs the "preroll" seconds are displayed (usually shown as P :02 or -:02). Let go of the button on the device and press Play on Instant Replay to begin recording immediately.
- Start Instant Replay recording on the fly between two selections and use Head Trim to remove any unwanted audio from the start of the recording.

In cases where Instant Replay records for only a few milliseconds or seconds and then stops, check for proper connections and cabling. Try another cable, or different device equipped with a digital output.

If all else fails, use the analog inputs. The conversion to digital is of high quality and will result in minimal loss of fidelity.

Digital Audio Output

When used as a digital audio source, Instant Replay has an automatic Playback Sample Rate Converter to make all of your clips conform to a single sample rate at the output. The analog outputs are not affected by sample rate changes.

AES/EBU Output

An XLR-3 male connector provides a digital audio output in the AES/EBU format. Use only special AES cable having an impedance of 110 ohms. Limit the cable run to 100 feet. Do not use microphone cable for runs over 6 feet.

Always set the DIGITAL AUDIO OUTPUT parameter in the CONFIGURATION Menu to PROFESSIONAL when using the AES/EBU output. Although the output is still active with the CONSUMER output formats selected, the signal is not AES/EBU compliant.

IEC 958 Type II Output

An RCA connector provides a digital audio output to consumer or semi-pro equipment. Most equipment with input connectors marked "S/P DIF" can also be connected to this output.

Always set the DIGITAL AUDIO OUTPUT parameter in the CONFIGURATION Menu to CONSUMER when using the IEC 958 Type II output with IEC 958 or S/P DIF equipment.

When DIGITAL AUDIO OUTPUT is set to PROFESSIONAL, this output produces a signal that is compatible with the AES/SMPTE digital audio standard. It is designed to allow digital audio to be routed and cabled using the same methods as 75Ω video signals. (This signal is normally supplied on a BNC connector; use an RCA to BNC adapter if necessary.)

NETWORK CONNECTIONS

[Network Port](#)

Instant Replay has a gigabit Ethernet port that enables file transfers via FTP or Windows file sharing. Once setup, transferring files over a network to the Instant Replay are possible. Refer to the Network Setup chapter for additional information.

Note: Due to constraints of the Instant Replay 3 design, transfer speeds using the network are restricted to a maximum of 500 Mb/s.

DANTE[®] MODULE INSTALLATION AND USE

The Instant Replay 3 contains a port for an optional integrated Dante[®] module which provides Ethernet audio, input and output, over a Dante network.

[Installing the Dante[®] module](#)

On systems that did not have the Dante module installed at the factory, one can be installed at any time. To install the module, insert a flat blade screwdriver into the knockout slot in the rear panel and twist back and forth to remove.

Once the knock out is removed, insert the Dante module with the screw hole on the left and put into the slot until the module is fully seated.

WARNING: Do not force the module in. If the module does not seat flush with the chassis, pull the module out and inspect for bent pins then reinsert again. Although the guide should align the module, it may take a couple of tries to align.



Dante Knock-Out



Dante Module Installed

[Attaching the Dante module to a network](#)

The Dante module must be connected to a PoE (Power over Ethernet) switch in order to operate. Once the connection is made, any audio played on the system will also output automatically through the Dante port.

Note: By default, Dante devices obtain IP addresses automatically which will require a DHCP server on the network. Once the module has an IP address, it can be configured with a static IP addresses via the Network Config tab of the Device View for the device.

[Using the Dante Module](#)

Once installed and setup, the module can be configured using the Dante software which can be obtained from <https://www.audinate.com/>.

On the Instant Replay 3, the Dante module will automatically receive the output of any playing content. To record using the Dante module, the input must be changed to Dante in the Record Settings screen.

[Content and File Types](#)

The Instant Replay can play .wav and .mp3 files. However, there are many ways to create these types of files and not all will play out correctly. As a general guideline, the following lists some of the parameters that should be used when creating these files.

Exporting WAV Clips

Instant Replay can record 16 and 24 bit WAV files at sample rates of 44.1 or 48Khz. Using the networking feature or external media, these clips can be transferred and played on a Personal Computer or any device capable of playing WAV files.

Importing WAV Clips

Instant Replay can play .wav files or .mp3 files created externally by other equipment.

- Wav files should be either 16 or 24 bit at a sample rate of 44.1, 48, 88.2 or 96 KHz.
- Most mp3 files will work without adjustment but when creating these files, it is best to keep the bit rate under 320Kbps.

Note: Although the Instant Replay may accept .wav or .mp3 files created in ways other than described above, they may not be recognized by the system or may play incorrectly. It is always best to test newly created files on the system to ensure they operate correctly.

PERIPHERAL CONNECTIONS

[USB Ports](#)

Instant Replay 3 has three USB ports, two on the rear panel and one on the side of the LCD display.

The USB ports on this device are a maximum of 1A and are designed for use with basic keyboards, mice, and memory sticks. These ports should not be used with large USB hard drives, LED keyboards, USB hubs (or keyboards with USB hubs), and should never be used as a charging port for other devices.

The USB port on the side of the LCD screen does not provide sufficient voltage to operate larger USB memory storage devices. Please use the rear USB ports.

WARNING: Failure to follow this notice may result in damage to the device and void the factory warranty.

The USB ports do not support mounting the Instant Replay internal storage on another device.

USB keyboard and mice connected to the system will act simply as a normal input device for the display. This can provide additional ease of use when setting up and operating the device.

Inserting a USB storage device containing music content, will allow the user to copy or move files to and from the Instant Replay 3 to the USB device. Please refer to the section on file management for additional information.

[GPIO Ports](#)

Instant Replay 3 has a high density 26 pin connector that provides GPIO connectivity. Please refer the GPIO wiring diagram and schematic for information on how to wire this type of connection.

GPI ports allow a contact closure to be used to trigger the system to Play, Pause, Stop, Loop or Record.

Note that Loop only controls the main clip loop and not the playlist loop and that Play will only play the clip that is currently loaded.

GPO ports can be used to communicate the state of the device such as Playing, Paused, Stopped, Recording, Looped, Cued. They can be used to light an external indicator LED or trigger an external device.

CHAPTER 4 – PLAY & RECORD OPERATIONS

PLAYING A CLIP

The main purpose of the Instant Replay is the instant playout of audio clips. There are multiple ways to play clips, each having unique benefits.

[Load and Play a Single Clip.](#)

From the Home screen, touch the SELECT CLIP button and in the Clip / Playlist Selector screen, select a clip. Press Enter, OK or Play, or double-tap the clip. The Home screen will show again and the clip will be loaded. Press PLAY if you did not use it to confirm the selection.

[Play a Clip Using a Hot Key](#)

By far the easiest and fastest method is the use of the Hot Keys. Simply press an assigned Hot Key for immediate playout. Hot Keys refer to the 50 numbered keys on the front panel, each of which can be assigned a clip for playout allowing rapid, on demand access to content.

Assigning a clip to a Hot Key

There are two ways to assign a clip to a Hot Key:

1. Pressing Assign Hot Key will open the Clip / Playlist Selector. Unassigned keys are lit in blue, assigned keys show red.
 - a. Select a clip from the window and press the Hot Key that the clip is to be assigned to. Assigned keys can be directly reassigned to different clips.
 - b. Repeat step (a) until all desired clips are assigned.
 - c. Press Assign Hot Key again to turn the function of.
2. Assign clips through the Bank Manager screen.
 - a. Open the Bank Manager by going to the main Menu and selecting MANAGE BANKS.
 - b. In the Bank Manager, select a key from the list and then select ASSIGN.
 - c. This will open the Clip Playlist Selector and allow the selection of a clip to be assigned. Pressing OK will set the clip to the previously selected key.

[Play a Clip Using the Hot List](#)

Hot Lists allow the creation and playback of a sequence of clips that are assigned to Hot Keys. Each Bank can have its own Hot List assigned but there can only be one Hot List per Bank.

Creating a New Hot-List

- Press the Hot List button.
- Press a series of Hot Keys.
- Press the Hot List button again to complete the list.
- Press the Hot List button again and then PLAY to start the playout.

Playing a Hot-List

Once a Hot List is created, pressing Hot List and then Play will start playout.

Note that the playout of a Hot List will follow the FOLLOW ON mode. When FOLLOW ON is on, clips will playout in sequence one after the other automatically. When FOLLOW ON is off (MANUAL), clips will stop at the end and wait for PLAY to be pushed to start the next clip.

While playing a Hot List, subsequent presses of PLAY will skip to the next clip in the Hot List and start playout.

Clear a Hot-List

Since Hot Lists are set on a per Bank basis, to clear a Hot List, go to the main menu and BANK MANAGER.

In the Bank Manager, select the Bank that has the Hot List that is to be cleared. Select CLEAR HOT LIST and then OK to clear the Hot List.

[Play a Clip Using the rear-panel GPI](#)

Instant Replay includes six General Purpose Interface (GPI) that can be set to Play, Pause, Stop, Record or Loop. See the section on setting up the GPIO for additional information.

When a remote momentary switch assigned to a GPI with the Play function is pressed, the Instant Replay will behave as if PLAY had pressed.

[Pausing a Playing Clip](#)

Press PAUSE to interrupt playback of a clip.
Press PLAY to resume playback.

RECORDING A CLIP

Note that when making recordings the resulting file is in the .wav format. The maximum recording length of a file is restricted to 90 minutes.

NOTE: The Balanced and Unbalanced analog inputs are mixed together. It is not recommended that both be connected at the same time, unless one or the other is muted.

[To Record a Clip](#)

To record a clip, with the system idle, press the REC button. This prepares the system for recording.

- A default file name is provided which can be renamed any time prior to starting the recording by clicking on the name field.
- The Input gain can be adjusted using the slider at this time.

To start the recording, press the PLAY button.

- If a threshold is set in the Record Settings, the system will wait until the input level reaches the threshold. Once the threshold is exceeded on either the left or right channel, the recording starts automatically.

To end the recording press the STOP button

[Limiting the Record Time of a Clip](#)

The recording time can be limited by selecting a maximum record time in the Record Settings menu. Once the Record Time Limit is set, it will apply to all recordings until it is specifically disabled.

CHAPTER 5 – WORKING WITH CLIPS AND PLAYLISTS

[Creating a Playlist](#)

To create a playlist, MENU and then MANAGE CLIPS. Select as clip or multiple clips using the check boxes and tap the ADD TO PLAYLIST button.

This opens the Playlist Selector screen.

- Select an existing playlist and tap OK or press ENTER on the keyboard.

Note: At this time, only clips can added to a playlist. Nested playlists (playlists within a playlist) are not allowed.

Note: Although .m3u files can be built and edited outside of the Instant Replay, to insure that they are correct, they should either be built by the internal playlist editor or checked in the playlist information screen to make sure the clips are known.

[Editing a Playlist](#)

Editing of an existing playlist is done through the Playlist Editor screen. The Playlist Editor can be started from either the Playlist Information screen by

tapping the EDIT button or from the Clip / Playlist Manager by selecting the playlist and clicking the EDIT button.

In the Playlist Editor, clips can be moved up or down in the list by selecting the clip and pressing the MOVE UP or MOVE DOWN button. For the purposes of moving up or down, a selected clip is the highlighted clip.



A selected clip may also be deleted from the playlist by pressing DELETE SELECTED. For purpose of deleting a clip, select by checking the box next to the clip to be deleted.

Note: Deleting a clip from a playlist only removes it from the playlist. The clip remains on the system.

Note: All actions on this screen are live. There is no undo or cancel so that the playlist alterations are immediate. Playlists should not be edited if they are loaded on the Home screen.

[Editing a clip](#)

Editing of a clip is done through the Clip Editor screen. The Clip Editor can be started from either the Clip Information screen by tapping the EDIT button or from the Clip / Playlist Manager by selecting the clip and clicking the EDIT button.

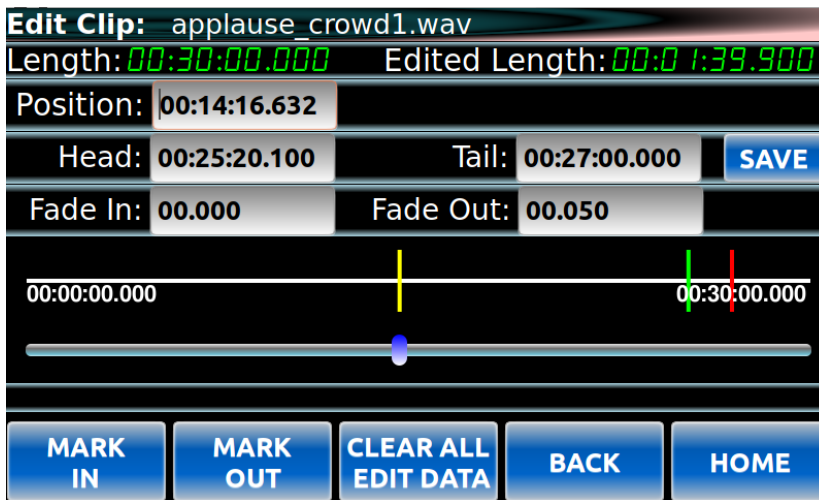

Within the Clip Editor, the Head and Tail positions can be used to trim the beginning and end of the clip as desired. To adjust the Head and Tail positions,

either enter the time for each directly into the appropriate field or use the position slider.

When using the position slider, the Position field will indicate the current location within the clip. Once the desired position is reached, pressing MARK IN will set the Head value or pressing MARK OUT will set the Tail value.

To set the Fade In or Fade Out amount of time, simply enter the appropriate value into the fields.

When all changes are made, press the SAVE button to save the settings for the clip.

Note: All editing on this screen is nondestructive to the clip. Information is written into the metadata of the clip.

[Assigning a Clip to a Hot Key](#)

As discussed in the playout section, there are two ways to assign a clip to a Hot Key.

- Using the Home screen
 - Load a clip using the SELECT CLIP button as was described previously.
 - Press the Assign Hot Key button and then press the Hot Key you wish to assign the clip to.
 - Continue this process until all desired Hot Keys are assigned.
 - Press the Assign Hot Key button to turn off the function.
- Using the Bank Manager Screen
 - Select the Bank Number you wish to edit the key assignments.
 - Tap or select a Key number line then press the ASSIGN button.
 - In the Clip / Playlist Selector, select the clip you wish to assign to the key and press Enter or OK.

[Using Hot-Key Banks](#)

The Instant Replay has 50 Banks of 50 Hot Keys allowing for the assignment of 2500 Hot Keys.

To select a Bank, press the Bank Sel button and press one of the 50 Hot Keys each of which corresponds to one of the 50 banks.

As previously described in the Assigning a Clip to a Hot Key section, clips or playlists can then be assigned to is equivalent to flipping a page, and presents a different set of Hot-Key Assignments. Note that the 50 Banks all have access to all the clips recorded in Instant Replay. Banks are a convenient way to organize Instant Replay's audio collection. A total of 2500 clips can be assigned to Hot-Keys if all 50 keys in each of the 50 banks are assigned to a different clip.

[Replacing Clips with Existing Hot-Key Assignments](#)

When audio that is assigned to Hot-Keys is replaced by any means (FTP Upload or Record Overwrite) the Hot-Key assignments will still exist, and will be assigned to the new audio. This allows material to be updated without the need for manually reassigning Hot-Keys. For instance, hourly promos can be named for their time slot and day of the week. Each week the new promos can be loaded in over the network and will appear at the same places in *a//*Banks and Playlists.

[Locating a Clip Using Searches](#)

On certain management or selector screen, a search field is available. Typing a letter or character in the field takes the selection to the first instance where the first letter of the name is a match. Typing subsequent letter will continue this process until no additional matches are found.

Note that searches only look in the current directly level and do not persist when moving between directories.

In most cases, pressing the Find button on the keyboard will move the focus to the search field.

[Viewing Clip or Playlist Information](#)

From the Home screen, pressing the CLIP INFO button will display information about the currently loaded clip.

If the system is stopped, information about a clip or playlist can be obtained through the Clip / Playlist Manager. Select MENU from the home screen and then CLIP MANAGER. In the Clip / Playlist Manager, select a clip or playlist and then the FILE INFO button.

Depending on whether a clip or playlist was selected, either the Clip Information or Playlist Information screen will be presented.

[Previewing a clip](#)

With the system stopped, PREVIEW may be pressed at which point the main audio outputs are muted. Clips played subsequently can be auditioned from the headphone output only.

Both the analog and digital audio outputs remain muted until PREVIEW is deactivated.

[Looping a Clip or Playlist](#)

Looping a clip or a playlist are separate actions. This provides a more granular control over what is looping on the system.

To loop a clip, press the LOOP button on either the keyboard or the LOOP button in the CLIP section of the home screen. This will cause the currently loaded clip to loop when played. The clip will continue to loop until:

- STOP is pressed. This will stop the playout but leave the LOOP button on. If PLAY is pressed again the clip will loop again.

- LOOP is turned off. If the clip is playing when LOOP is turned off, the clip will stop when finished playing.

NOTE: The physical LOOP button on the keyboard only functions to loop clips. Looping a playlist can only be done from the LOOP button in the PLAYLIST section of the Home screen.

If a playlist is loaded, turning loop on in the CLIP section will obey the FOLLOW ON mode. For example, with a playlist loaded and LOOP turned on, and FOLLOW ON turned off (MANUAL), the loaded clip from the playlist will not loop. Instead it simply remains the current clip and does not move to the next clip in the playlist. Subsequent presses of PLAY will continue to play the same clip.

- If FOLLOW ON mode is turned on (AUTO), the loaded clip will continue to loop until LOOP is turned off.

To loop a playlist, turn the LOOP button in the PLAYLIST section of the Home screen on. The LOOP button in the CLIP section must be off in order for a playlist to loop.

As with looping a clip, the FOLLOW ON mode dictates what happens at the end of the playlist.

- If FOLLOW ON is off, the Playlist will stop at the end of each clip and cue the next clip in the list. At the end of the last clip in the playlist, the first clip is recued. Play will restart the playlist playing again.
- If FOLLOW ON is on, the Playlist will play through the entire list, then recue and start playing the first clip again.

NOTE: The LOOP button in the CLIP section takes precedence over the LOOP in the PLAYLIST section. In other words, if LOOP in the CLIP section is on, the current clip will continue to loop even if playlist loop is on.

Using the two different LOOP buttons can open a variety of ways to control the operation of clips and playlists.

[Shuffle a playlist](#)

The SHUFFLE button on the Home screen allows for a loaded playlist to be randomized.

When a playlist is loaded and SHUFFLE is on, PLAY initiates playout of a randomly selected clip in the playlist.

The playlist will continue to play random clips in the playlist until SHUFFLE is turned off. Pressing STOP while SHUFFLE is turned on will play the next clip.

Using the Record Sample Rate Converter

What the Record Sample Rate Converter does.

If you are recording material using the digital (AES/EBU or IEC958 II) inputs, you can ensure that it will be recorded at the sample rate you have selected, even if the incoming material is at a different sample rate.

For example, assume your RECORDING FORMAT is set to 44.1K 16 Bit WAV and your input source is the AES/EBU inputs. The digital source is clocking at a 48K sample rate. If the Sample Rate Converter is enabled, the incoming 48K signal will be converted to your selected 44.1K format. Likewise, if the RECORDING FORMAT is set to 48K, an incoming signal clocking at 44.1K will be converted to 48K if the Sample Rate Converter is enabled.

Note: The Sample Rate Converter has no effect if you are using the balanced or unbalanced analog inputs for recording. The recording will simply be made at the selected rate chosen in the Playout Settings section.

CHAPTER 6 – Backup, Restore and other utilities

Instant Replay includes the ability to backup and restore, system settings, HotKey / Bank assignments and Content. Using these built in features allow for simple restoration of systems or cloning of systems as needed.

The following options are located in the Utility screen which can be accessed from the main menu.

Backup

Selecting the Backup function allows the backup and restore, system settings, Hot Key / Bank assignments and Content to an external USB storage device. System settings and Hot Key / Bank assignments will backup in seconds. Content backup may be very slow using this method depending on the amount of content to be backed up.

1. Insert a USB storage device with sufficient free space into the system.
2. From the Backup menu, select the items to be backed up.
3. Select the USB storage device to be used for the backup. If the inserted device is not listed, select RESCAN to have the system look for available USB devices.
4. Select OK to begin the process.

Note: The system will be inoperable during this process.

- Content - selection refers to clips and playlists as well as the folder structure on the system.
- System Settings – selection refers to the stored settings for items like record and playout settings. This file is a database file constructed for use only on the Instant Replay 3 product.
- Hot Key Mappings – selection refers to the Bank and Hot Keys assignments. This is also contained in a database file that is only usable on the Instant Replay 3 product.

Once the process is completed, the USB device can be removed.

Restore

On certain management or selector screen, a search field is available. Typing a letter or

WARNING: This process will overwrite all information with the settings or files being restored.

WARNING: Do not power off the system during the update process. The system may be rendered unusable should this happen.

1. Insert a USB storage device containing the appropriate files to be restored.
2. From the Restore menu, select the items to be restored up.
3. Select the USB storage device that contains the appropriate files to be restored. If the inserted device is not listed, select RESCAN to have the system look for available USB devices.
4. Select OK to begin the process.

Note: Depending on what was restored, some system settings require a full reboot of the system for normal operations.

Create Log File

On occasion, it may be necessary to supply 360 Systems' support team with information regarding an issue with the system.

- Select the CREATE LOG FILE button to generate the logs.
- The logs will take a minute to generate and the resulting file (log.tgz) will be placed in the root of the "internal" directory.
- Using FTP or file sharing over the network, retrieve the log.tgz file and email to support@360systems.com or as directed.

System Info

The SYSTEM INFO button displays information regarding the version of software on the system as well as addition information about the system.

This information along with the serial number of the unit should be supplied to 360 Systems' support should information about the product be required.

Clear Banks

Clearing the Hot Keys from all of the system Banks is accomplished using the CLEAR BANKS button. This is different from the CLEAR BANK button in the Bank Manager screen which only clears the currently selected bank.

The CLEAR BANKS button in the Utility Menu clears all Banks.

WARNING: This is not reversible. Make sure Hot Keys are backed up prior to initiating.

Default Settings

WARNING: This process will restore all system settings & Hot Key assignments to factory default. Please make sure to backup the system first.

Selecting System Reset will reset system settings & Hot Key assignments to factory defaults. Content on the system will remain.

A prompt of OK or Cancel will be provided.

WARNING: This action cannot be undone and will result in a total loss of system settings and Hot Key assignments on the system.

System Reset

WARNING: This process will remove all system settings, Hot Key assignments and content from the system. Please make sure to backup the system first.

Selecting System Reset will reset the system back to factory defaults.

A prompt of OK or Cancel will be provided.

WARNING: This action cannot be undone and will result in a total loss of everything on the system.

Firmware update

From time to time, 360 Systems may release updates to the system that may include enhancements for better system operation or functionality. To install updates on the system, please follow these steps.

WARNING: Please make certain that system content and settings are backed up prior to any system update.

WARNING: Do not power off the system during the update process. The system will be rendered unusable should this happen.

1. Obtain the appropriate software release by contacting support@360systems.com
2. Place the software update file in the root directory of a USB storage key.
3. Place the USB storage key into the system.
4. From the main menu, select Utility Menu and then select FW UPDATE.
5. You will be prompted to confirm the update which will then automatically update the system firmware.
6. Once the update is complete, the system will automatically reboot.

Chapter 7 – File Management

File management covers adding, removing or organizing the content on the system. The basic file structure is similar to that of a PC and is intuitive to use.

There are several ways to manage files, with the primary method being the built-in file manager. FTP and File Share Access are also methods of remotely accessing the file system to transfer files from a remote location to the Instant Replay.

A quick note on File Management vs Clip Management.

In the main menu there are two options. **MANAGE FILES** and **MANAGE CLIPS**.

Managing files refers to the organizational structure of the clips and playlists on the devices. Items such as deleting, moving, copying files or creating folders are in the File management screen.

Managing clips refers to actions on clips or playlists such as adding clips to playlists, or viewing the information on or editing a clip.

Built-in File Management

Access the File Manager by going to MENU and **MANAGE FILES** allows for folder creation, copying and moving of files and folders.

Using External Media

Using the File Manager, files can be copied from either the internal storage or external storage such as a USB memory key. Inserting a USB memory key into one of the USB ports on the system will display the USB device in the file manager under the main "external" directory.

By navigating to the "external" directory in the File Manager, a list of available USB memory devices will be displayed. Selecting files or folders from the device and using the copy or move functions listed below, will allow for the transfer of this content to a directory on the "internal" drive.

Note: USB memory keys should be formatted using FAT32. Using other file formats may work as well but to maintain compatibility, the FAT32 file system works best.

Note: Avoid using large external USB hard drives that source power from the USB port. These devices may pull more amps than the USB ports on the Instant Replay can provide.

Alternatively, files can be managed remotely by using either the FTP access or the File Share features.

File Manager Functions

The built-in file manager provides methods to organize the content on the system.

Copy / Move: To copy or move a file, files or playlists or entire folders, make a selection in the file manager using the checkboxes and select the COPY/MOVE button. The COPY/MOVE button will turn green and all selected checkboxes will be cleared.



Navigate to the folder where you wish the files to be copied or moved and press the COPY/MOVE button again. A dialog will appear and either COPY or PASTE can be selected.



The selected function will be carried out and the user will be returned to the file manager when the process is complete.

Note: During the COPY/MOVE process, if a large amount of files are to be processed, the unit may appear frozen during this process. This is normal as the operation must be complete prior to the unit returning to normal operation.

Rename: To rename a file, select a file by highlight (tap the screen or use the arrow keys) and then select the RENAME button which will provide a popup dialog to rename the file.

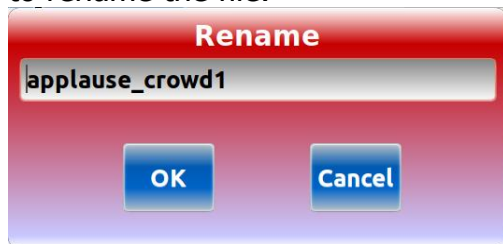

Note: Only the name portion of the file is changed. The file extension is automatically added upon completion of the operation.

Create Folder: To create a new folder, navigate to the location you wish to create the folder and select the CREATE FOLDER button. A dialog will prompt for the folder name.

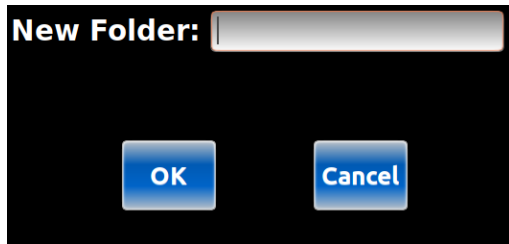

Selecting OK from the dialog will create the folder.

Delete: Deleting files or folders in the system is done by selecting using the checkboxes and then selecting the DELETE button.

Note: Folders cannot be deleted unless they are empty.

[FTP Access](#)

Using a FTP client, users can access the file system of the Instant Replay to transfer files to and from the Instant Replay quickly and easily.

Once logged in via FTP, users can transfer files or delete, move or rename files and folders.

Refer to the chapter on Networking for instruction on setting up and enabling this feature.

[Windows File Sharing \(Samba\)](#)

With File Sharing, the Instant Replay can be made to show up like any other folder on a PC by either direct access or by mapping as a network drive.

Once established, the folder acts like any other folder in the File Explorer where files can be dragged and dropped onto of off of the system and folders and files can be created, deleted or renamed.

Refer to the chapter on Networking for instruction on setting up and enabling this feature.

[File Naming Conventions](#)

Alphanumeric characters, hyphens, spaces and underscores are allowed. Some other special characters are allowed, however, they should be avoided as they may cause issues when moving files between PC's and the Instant Replay as well as other systems.

[Clip Management](#)

Clip Management pertains to gaining information about a clip or playlist, editing a clip or playlist or creating a playlist. This differs from File Management which deals with the organization of the clips on the system.

To work with clips to retrieve information, edit or to build a playlist:

- In the main menu select MANAGE CLIPS.
- In the Clip / Playlist Manager, select a clip or playlist and press one of the following.
 - FILE INFO – This will display information about the selected clip or playlist
 - EDIT – This will display a screen that allows the editing of the clip or playlist. (See the appropriate section for more on each of these features.
 - ADD TO PLAYLIST – This will display a new screen with a list of all available playlists on the system. (See Creating a Playlist for additional information.)

Chapter 8 – Bank Management

Functions related to the management of a Bank can be found in the main menu by selecting MANAGE BANKS. The Bank Manager Screen allows the viewing of each bank and all of the Hot Key assignments. In addition, it is possible to make Hot Key assignments directly from the Bank Manager.

[Change the name of a Bank](#)

Scrolling through the Banks using the number wheel at the top of the screen causes each bank to display in the screen. The name of the Bank appears in the box below. To change the name of the Bank, simply click within the bank name window and type a name using the keyboard.

[Assigning Hot Keys](#)

From within the Bank Manager, select (highlight) a Hot Key from the list and select the ASSIGN button.

The Clip / Playlist Selector screen will be presented. Navigate through the file system and select a clip to be assigned to the Hot Key. Note that selecting CANCEL will result in no changes.

Once the clip is selected, select OK or press ENTER and the clip will be assigned to the Hot Key.

[Clear a Hot Key](#)

To clear an individual Hot Key, select the Hot Key from the list and select the CLEAR HOTKEY button. This will remove the Hot Key assignment from the selected Bank.

[Clear a Hot List](#)

To clear a Hot List, select CLEAR HOTLIST then select OK or ENTER and the HOT LIST, if there was one, will be removed.

[Clear the Bank](#)

To clear all Hot Key assignments from a specific Bank, select the Bank that you wish to clear and then select the CLEAR BANK button.

Note: This is different from **the CLEAR BANKS** operation in the Utility Menu which will clear all Hot Key assignments from all Banks.

CHAPTER 9 – USING THE NETWORK

Network Setup

In order to use the Network features, networking must be setup under the Main Menu -> Network settings.

Access to the network features can be turned on or off under Main Menu -> Access Settings screen.

- ✓ Rapidly upload or download clips, from Instant Replay to your computer.
- ✓ Clip organization
- ✓ Rename clips
- ✓ Delete clips

WARNING: The Instant Replay is not designed as a network security device and therefor should be protected when placed on a network. Placing the unit behind a firewall or other network security device or having it on an isolated standalone network are best practices. Please consult your network administrator.

Network Settings

In the Network Settings screen, turn DHCP to ON to enable the system to automatically receive IP information from a DHCP server connected to the network.

Note: The system must have a unique Host Name assigned on the network. Please see your network administrator for instructions.

If DHCP is set to OFF, all IP information must be entered manually. This would include at a minimum, the IP address, Subnet Mask, Gateway

Note: When assigning a static IP address, the system must have a unique IP address on the network. Please see your network administrator for instructions.

DNS servers are automatically assigned if using DHCP and will need to be manually assigned if using a static IP address.

NTP (time) servers should be added as needed in order to keep the system clock up to date.

Note: NTP servers are only used if Automatic Updates are enabled in the Date & Time Settings.

User Access Settings

In the User Access Settings screen, FTP and File Share access can be turned on or off independently. Simply turn either FTP or File Share to ON to enable either or both of these features.

If either feature is turned on, a User Name and Password must be assigned. If not User Name or Password is assigned, that resource must be turned off.

Note: There are no password length or character restrictions. It is best practice to utilize strong passwords (ones over 8 characters in length and with a mix of letters, numbers and special characters).

[Connect the Ethernet cable](#)

Connect a Standard RJ45 CAT5e or better Ethernet cable to the Ethernet port marked NETWORK on the right left side next to the USB ports. If the cable is connected correctly, the green LINK LED directly above the cable port will turn ON. If the green LED is not ON, check the cable polarity, cable continuity or network connection.

[Connecting to Instant Replay using FTP](#)

Supported FTP Clients

Instant Replay includes an RFC-1359 compliant FTP server. Most commercially available FTP clients should work with Instant Replay.

[Example of Connecting DOS FTP](#)

1. From a Windows PC, open a DOS Shell as follows.
Press **Windows Key + r** to open a run prompt and type **cmd** and click **OK**.
2. From the command prompt, type
ftp <IP ADDRESS>

...where the IP ADDRESS is the address you set your Instant Replay to in the Initial Setup step. For example 192.168.1.120 would be a valid entry. The display will do the "dots" for you.

2. Type in USER ID when Prompted.
3. Type in the PASSWORD when prompted.

```
C:\>ftp 192.168.1.16
Microsoft Windows XP [Version 5.1.2600]
(C) Copyright 1985-2001 Microsoft Corp.

C:\>ftp 192.168.1.16
Connected to 192.168.1.16.
220 RT-IP FTP Server ready. Type HELP for help
User (192.168.1.16:(none)): FACTORY
331 User name okay, need password.
Password:
230 User logged in, proceed.
ftp> ls
200 Command okay.
150 File status okay; about to open data connection.
COWBELL
DMP
BOING
DING
226 Closing data connection. Transfer succeeded
ftp: 27 bytes received in 0.17Seconds 0.16Kbytes/sec.
ftp>
```

Downloading a file from Instant Replay to your host:

Log in per the example above. Type:

Get <FILENAME>

At the FTP prompt:

```
C:\>ftp 192.168.1.16
Microsoft Windows XP [Version 5.1.2600]
(C) Copyright 1985-2001 Microsoft Corp.

C:\>ftp 192.168.1.16
Connected to 192.168.1.16.
220 RT-IP FTP Server ready. Type HELP for help
User (192.168.1.16:(none)): FACTORY
331 User name okay, need password.
Password:
230 User logged in, proceed.
ftp> ls
200 Command okay.
150 File status okay; about to open data connection.
COWBELL
DMP
BOING
DING
226 Closing data connection. Transfer succeeded
ftp: 27 bytes received in 0.16Seconds 0.17Kbytes/sec.
ftp> get DMP
200 Command okay.
150 File status okay; about to open data connection.
226 Closing data connection. Transfer succeeded
ftp: 2514944 bytes received in 5.11Seconds 492.26Kbytes/sec.
ftp> exit
Invalid command.
ftp>
```

Uploading a file from your host computer to Instant Replay

Log in per the example above. Type:

put <FILENAME>

At the FTP prompt:

```
C:\ Command Prompt - ftp 192.168.1.16
Y:\>c:
C:\>ftp 192.168.1.16
Connected to 192.168.1.16.
220 RT-IP FTP Server ready. Type HELP for help
User (192.168.1.16:(none)): FACTORY
331 User name okay, need password.
Password:
230 User logged in, proceed.
ftp> put SIREN
200 Command okay.
150 File status okay; about to open data connection.
226 Closing data connection. Transfer succeeded
ftp: 2287616 bytes sent in 2.97Seconds 770.50Kbytes/sec.
ftp> ls
200 Command okay.
150 File status okay; about to open data connection.
SIREN
DMP
BOING
DING
COWBELL
226 Closing data connection. Transfer succeeded
ftp: 34 bytes received in 0.14Seconds 0.24Kbytes/sec.
ftp>
```

Deleting a file from Instant Replay

Log in per the example above. Type:

Del <FILENAME>

At the FTP prompt:

```
C:\ Command Prompt - ftp 192.168.1.16
220 RT-IP FTP Server ready. Type HELP for help
User (192.168.1.16:(none)): FACTORY
331 User name okay, need password.
Password:
230 User logged in, proceed.
ftp> ls
200 Command okay.
150 File status okay; about to open data connection.
FIRE
BOING
DING
COWBELL
226 Closing data connection. Transfer succeeded
ftp: 28 bytes received in 0.22Seconds 0.13Kbytes/sec.
ftp> del DING
250 Requested file action okay, completed.
ftp> ls
200 Command okay.
150 File status okay; about to open data connection.
FIRE
BOING
COWBELL
226 Closing data connection. Transfer succeeded
ftp: 22 bytes received in 0.20Seconds 0.11Kbytes/sec.
ftp>
```

Renaming a file on Instant Replay

Log in per the example above. Type:

rename <CURRENT FILENAME> < NEW FILENAME >

At the FTP prompt:

```
Command Prompt - ftp 192.168.1.16
230 User logged in, proceed.
ftp> ls
200 Command okay.
150 File status okay; about to open data connection.
SIREN
DMP
BOING
DING
COWBELL
226 Closing data connection. Transfer succeeded
ftp: 34 bytes received in 0.20Seconds 0.17Kbytes/sec.
ftp> rename SIREN FIRE
350 Requested file action pending further information.
250 Requested file action okay, completed.
ftp> ls
200 Command okay.
150 File status okay; about to open data connection.
FIRE
DMP
BOING
DING
COWBELL
226 Closing data connection. Transfer succeeded
ftp: 33 bytes received in 0.22Seconds 0.15Kbytes/sec.
ftp>
```

Example FTP Transferring with Flash FXP

Flash FXP™ can be obtained at www.inicom.net.

Note: The version used for this example may be different than the current version.

Connect to Instant Replay

Start up Flash FXP. The listing on the right hand side shows local files on your computers drive.

Make sure that FTP is set to ON in the Instant Replay (**MENU->NETWORKING->FTP MODE->ON**).

Click on the yellow Lightning Bolt then select Open Connection.

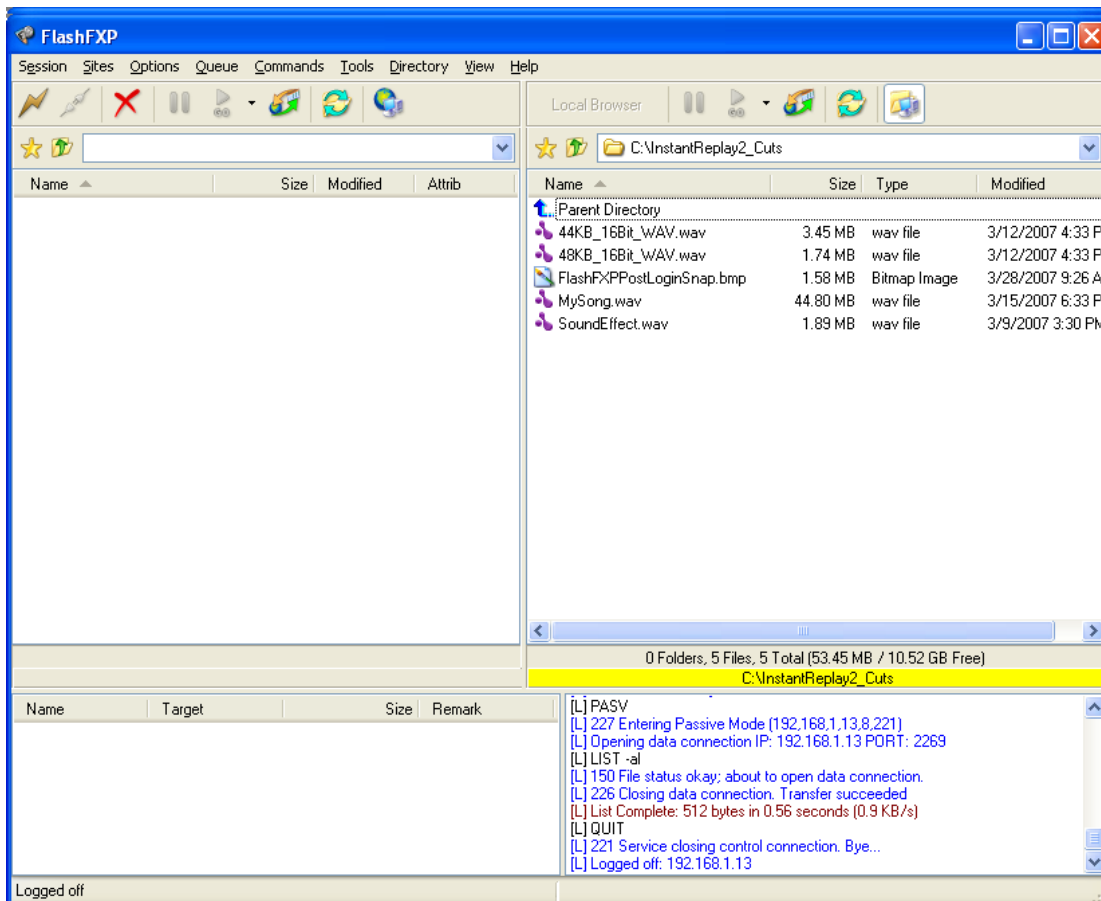

The login dialog box appears. Set the IP address, User ID and Password fields to the values you configured your Instant Replay to under the Networking menu.

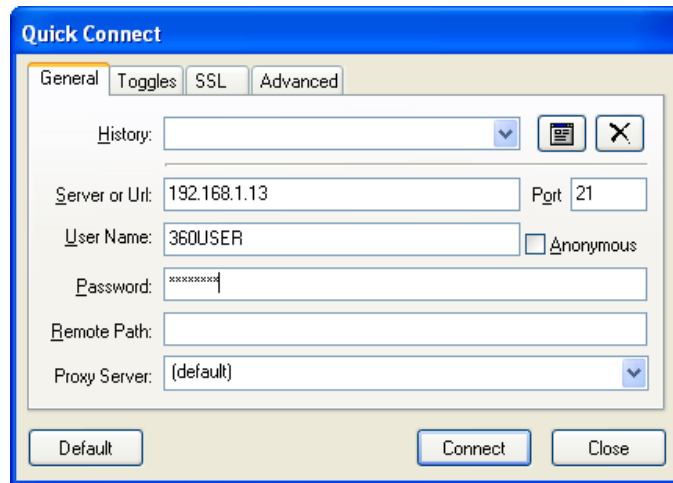

To Upload / Download files:

You can move files from Instant Replay to your computer simply by dragging them across to the listing on the right side of the screen. Likewise you can move files from your computer to Instant Replay by dragging them from left to right.

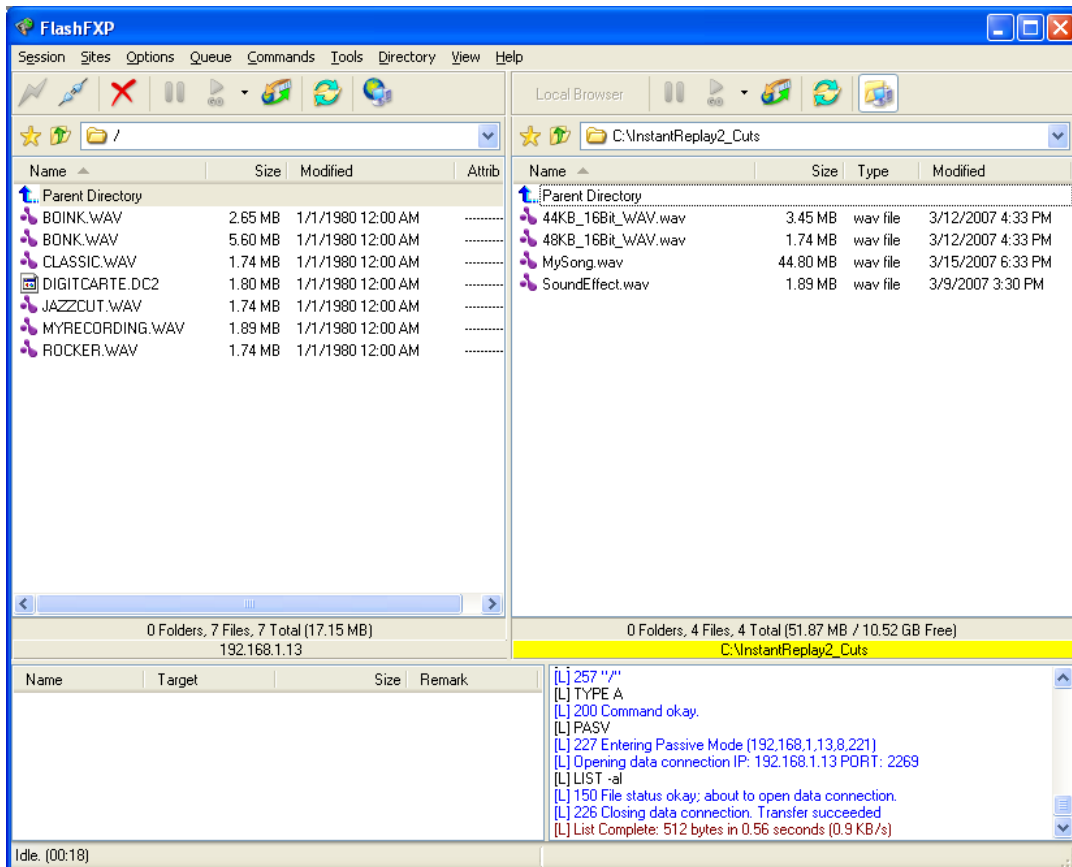

Example FTP Transferring with Filezilla

Filezilla™ is a freeware FTP client that can be obtained at <https://filezilla-project.org>.

Note: The version used for this example may be different than the current version.

Connect to Instant Replay

Start up Filezilla. To quickly connect, in the top entry fields, enter the IP address in the Host field, the User Name in the Username field and Password in the Password field and then click the Quickconnect button.

If everything was setup correctly, a listing of files on the system should show in the right side of the Filezilla window.

Alternatively, going to File and Site Manager from the menu bar, allows the establishing of a "site" which can have all of the information pre filled in. This simplifies future access to the system.

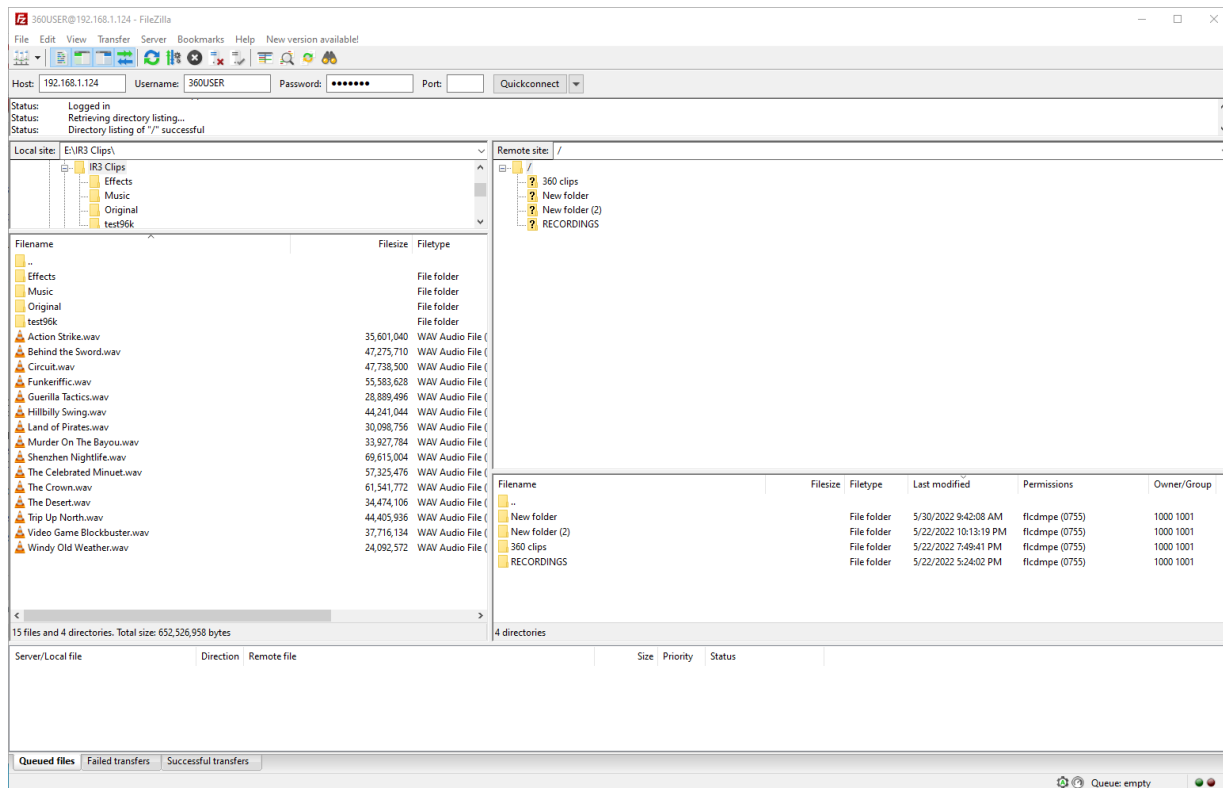

To Upload / Download files:

Simply drag and drop files either from the PC (left side) or the Instant Replay (right side) to the folder you wish the files to land in. The transfer should take place automatically.

Other functions:

Using Filezilla, right clicking on a folder or empty portion of a window frame will bring up a secondary menu. This menu will allow the renaming, deleting or making of a new folder. This allows for organization of the media contained on the Instant Re

Using the File Share Feature

When the File Share network access is turned on, the Instant Replay will be visalbe over the network and a connection can be established in a couple of different ways.

1. From a File Explorer window on a PC, simply enter "\\<IP ADDRESS>" and press ENTER.

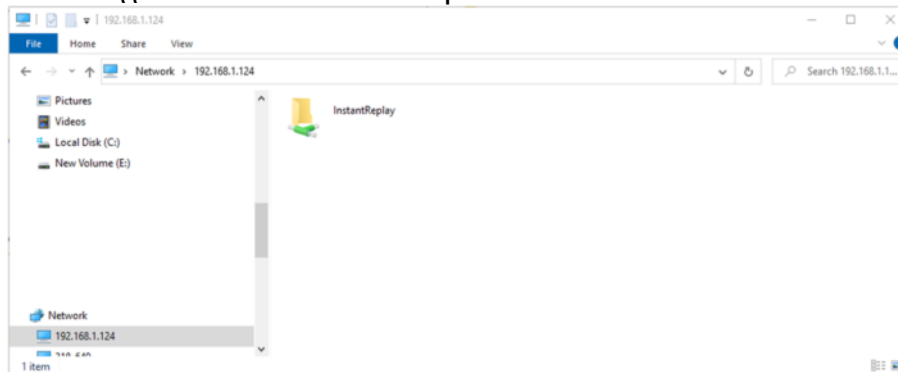

This will bring up the Instant Replay in the File Explorer. Double click the InstantReplay icon and enter the Username and Password to gain access.

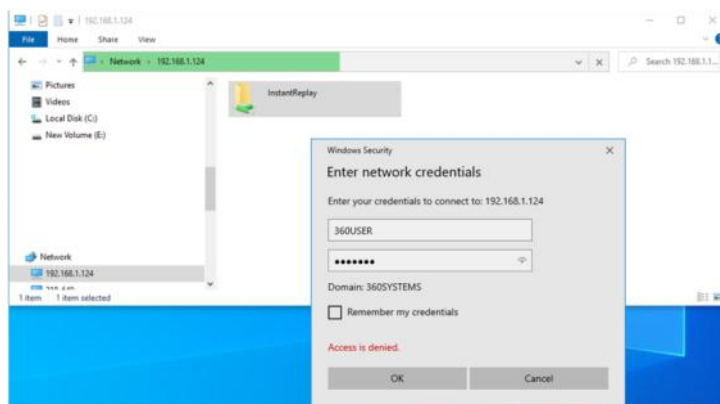

Once access is established, the family folder / file structure will appear. Simply dragging and dropping or copying and pasting files from other folders will make transferring files to and from the Instant Replay simple.

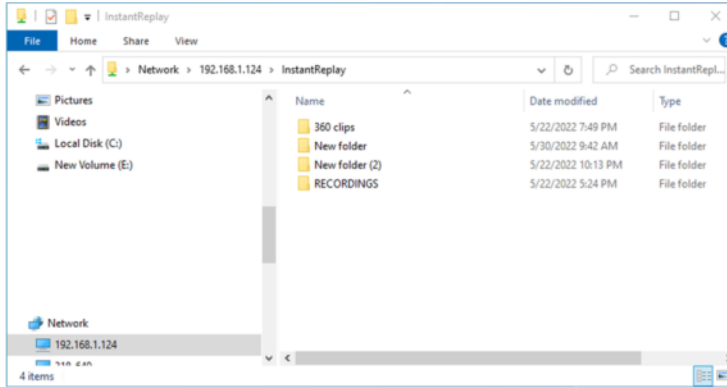

2. Mapping the Instant Replay as a Network Drive can be a more permanent solution.
 - a. Open a File Explorer window and right click on This PC or Network in the left panel.
 - b. From the dropdown menu, select Map Network Drive.

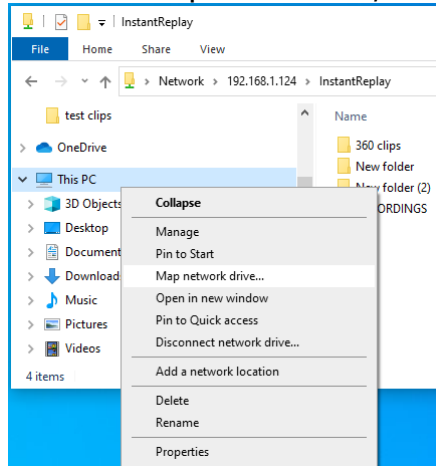

- c. In the new window, select a drive letter and then enter `\\<IP ADDRESS>\InstantReplay` for the folder

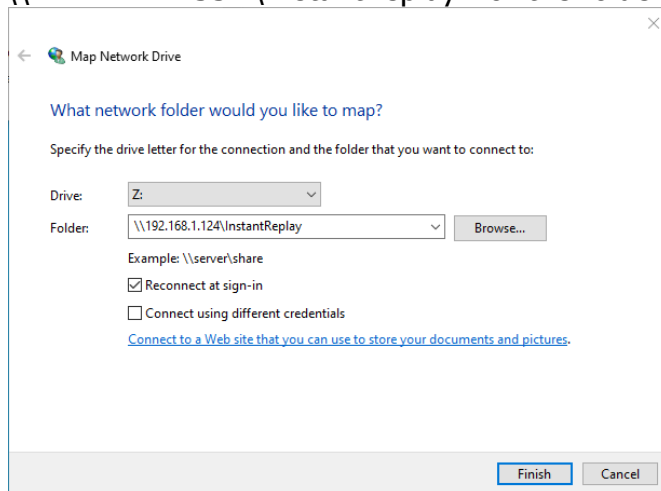

- d. Select the Reconnect at sign-in box to keep this mapping over a reboot of the PC and then click Finish. The drive letter selected should be available as the file share in the File Explorer. The system will prompt for the username and password during the process.

CHAPTER 10 – SYSTEM UPDATE

Updating the System Application

From time to time, 360 Systems revises the application software on its products to enhance and/or improve performance. System updates must be obtained by contacting 360 Systems' support to insure that the proper update is provided.

WARNING: Using the incorrect update may render the system inoperable.

WARNING: Please make sure to backup all content on the system prior to conducting any system update. Although most updates will not affect the system content or databases, the possibility of loss of content or settings does exist.

To update the system

- Copy the provided file (for example, the IR3_DR1000-A.enc) to the root directory on a USB key.
- Insert the USB key with the update file into one of the USB ports on the system.
- From the Home screen, select MENU and then in the Main Menu screen, select UTILITY MENU.
- Select FW UPDATE and follow the prompts.

Appendix A

CONNECTOR SPECIFICATIONS

GPIO Connector Pinout

Pin	Signal	Pin	Signal
1	GPI 1	14	GPI 5 RTN
2	GPI 2	15	GPI 6 RTN
3	GPI 3	16	GPO 1
4	GPI 4	17	GPO 3
5	GPI 5	18	GPO 5
6	GPI 6	19	+5V SOURCE
7	GPO 2	20	+5V SOURCE
8	GPO 4	21	+5V SOURCE
9	GPO 6	22	+5V SOURCE
10	GPI 1 RTN	23	GND
11	GPI 2 RTN	24	GND
12	GPI 3 RTN	25	GND
13	GPI 4 RTN	26	GND

Warning: Incorrect wiring of GPIO connector may damage its interface circuitry.

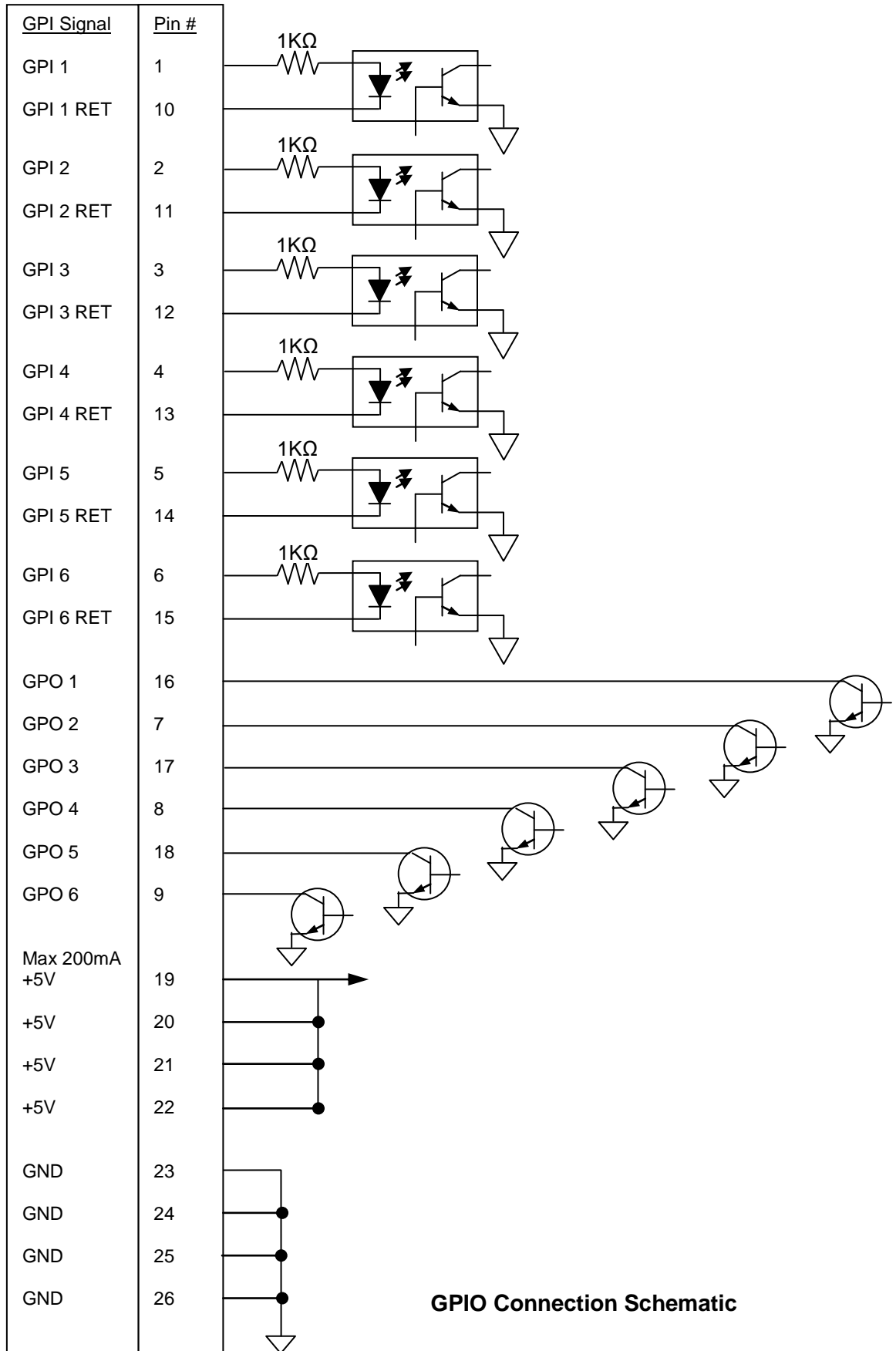

Simple GPI Switch Connection Diagram

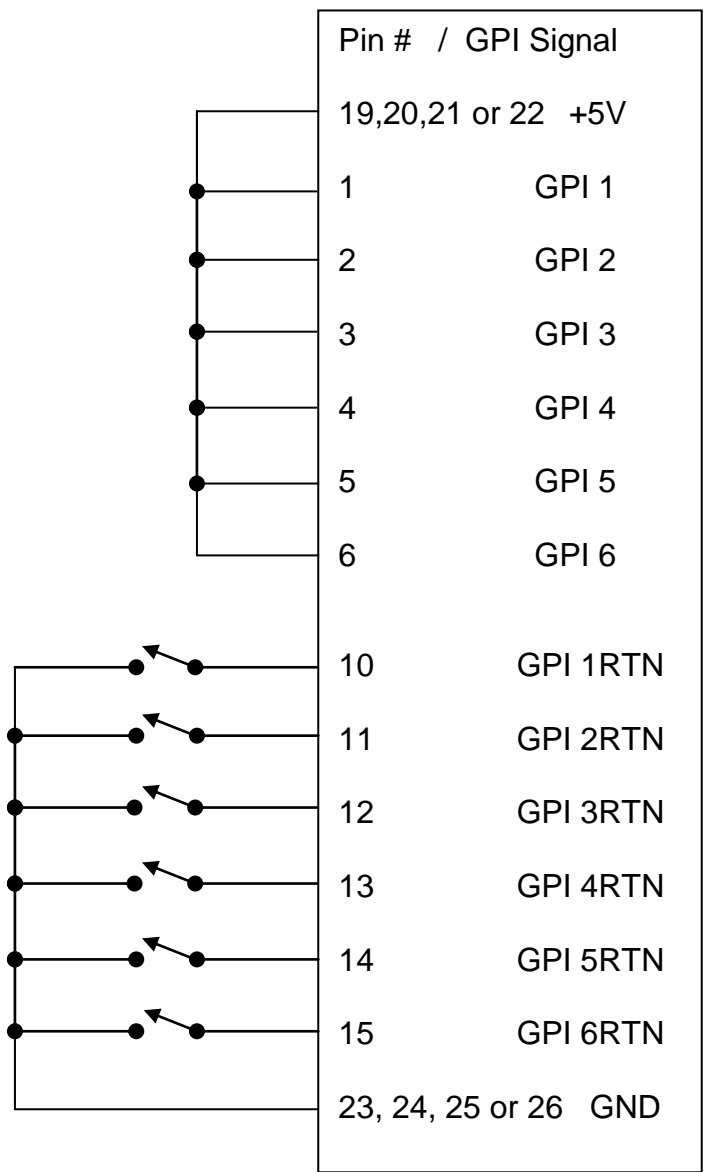

Simple GPI Connection Example

Isolated Connection to External Controller
 Contact Closure or Open Collector
 (Example using GPI1)

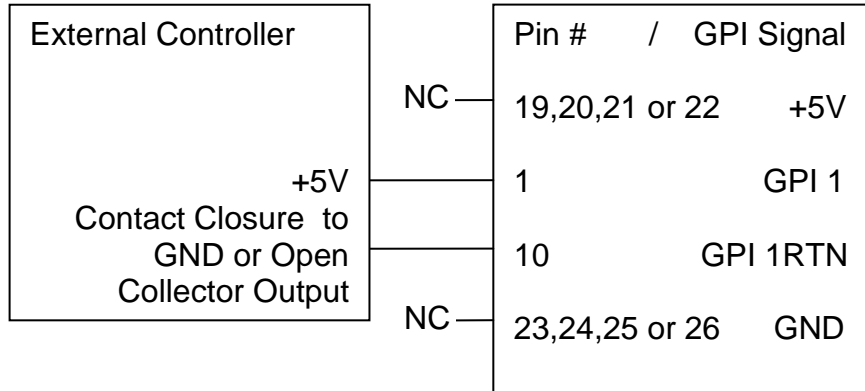

Isolated Connection to External Controller 2
 Logic Output or Other 5V Source
 (Example using GPI1)

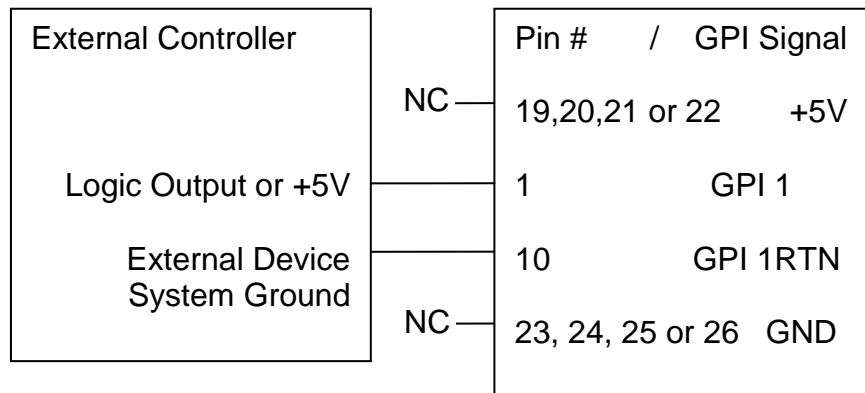

Isolated GPI Connections From Other Devices

Simple LED Drive for External Indicator
(Example using GPO1)

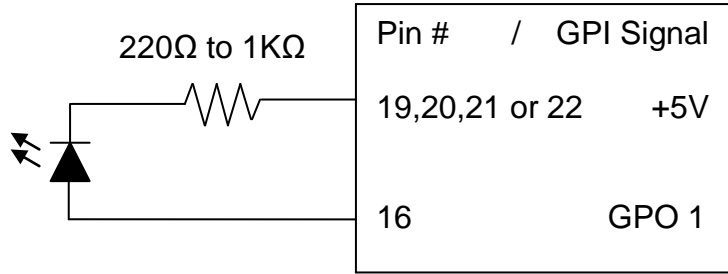

Isolated Connection to Relay
(Example using GPO1)

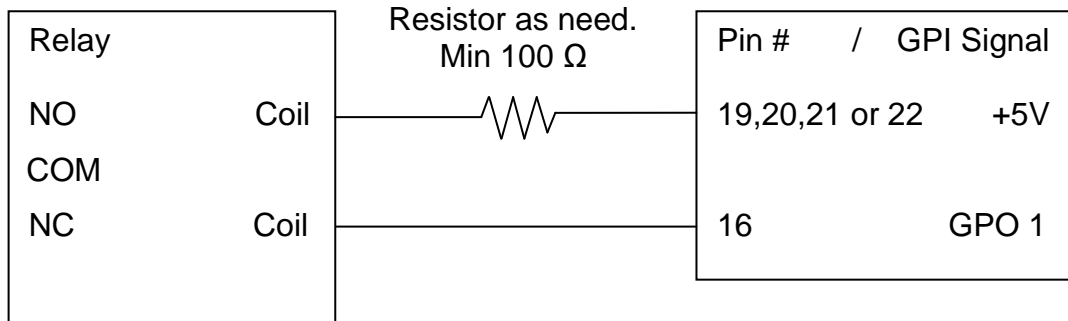

GPO Connection Example

Appendix B

Audio I/O	
Balanced analog output	On XLR connectors
Balanced analog input	On XLR connectors
Unbalanced analog I/O	On RCA jacks
AES/EBU Digital I/O	On XLR connectors
IEC-95811 or AES-75 ohm digital input / output	On RCA jacks
Headphone Jack	1 /4" headphone jack
Optional Dante Ethernet	Rear Ethernet port
Audio File Types	
Playout Files Accepted	.wav, 16 or 24-bit @ 44.1 or 48KHz or .mp3 up to 320kbps @44.1 or 48KHz
Recording File Formats	Stereo 16 or 24-bit .wav files at 44.1 or 48KHz sample rates.
Program Storage	
Internal Solid State Memory	50GB.
External USB storage	Flash Drive, memory stick or SD card converters.
Other Connectivity	
USB Ports	2 rear USB ports, 1 on side of display for keyboard, mouse or external memory devices
Gigabit Ethernet network port	1 Rear, for transferring content via FTP and file share network access
Diagnostics	Download of sequential events
GPI	6 opto-isolated inputs, 6 open-collector outputs, 26-pin Dsub
Power & Mechanical	
Power Supply	External 100-240 V AC, 50/60 Hz, 2A Max input, 12V DC 10A, 120W output
Mechanical	Desktop 17.32"W x 11.56"D x 1.75"H (44cm x 29.4cm x 4.5cm)
Cooling	Ambient
Weight	5.76Lbs (2.62Kg) net
Agency Approvals	FCC Class A, CE, RoHS
Country of Origin	U.S.A.

TECHNICAL SPECIFICATIONS

Appendix C

MECHANICAL DRAWING

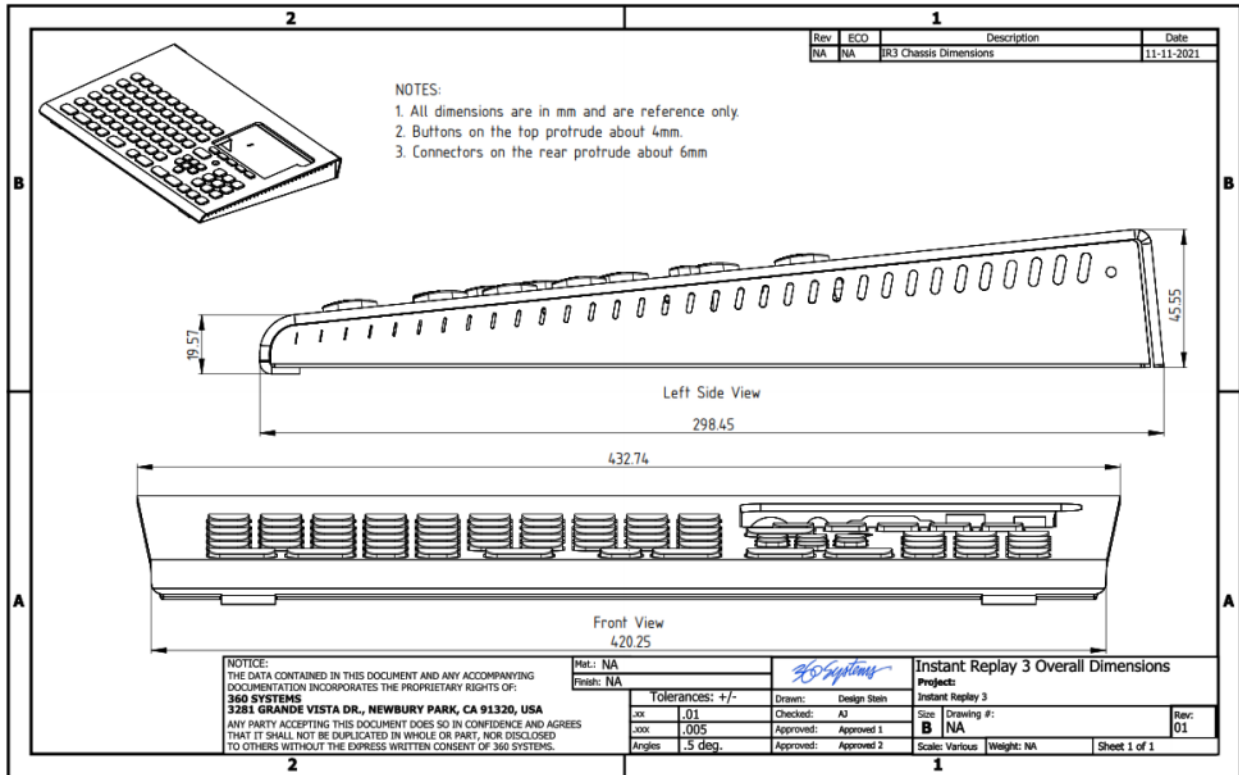

Appendix D

TROUBLE SHOOTING

Issues with booting:

- If the unit boots up and is unable to find the Internal drive
 - Unplug any USB keys in the unit and reboot the system.
- If the unit sits on a splash screen, a hard reboot may need to be initiated.
 - Press and hold the power button for 5 seconds, this will power the system off.
 - Or, unplug the AC power from the power brick for 10 seconds and then

Connection issues:

- If a samba connection was already established and the password is updated, the net connection from windows needs deleted prior to access.
 - Open a command prompt (windows + r and then type cmd)
 - Type "net use" in the command prompt to list the connections.
 - Type "net use \\<IP address of unit>\InstantReplay /delete

Appendix E

BATTERY REPLACEMENT

✘ Your system uses a lithium coin-cell 2032 battery.

Do not dispose of the battery along with household waste. Contact your local waste disposal agency for the address of the nearest battery deposit site.

The coin cell battery is located on the front of the main board. To access the battery remove the 2 rear screws on the top panel and lift the top panel towards the front. Using a small flat blade screwdriver, release the latch on the battery holder and pull the battery out. Replace the battery with a new one making sure the positive side is facing down.