



UHF Synthesized Wireless Microphone System

U, AU

Superb Performance and Reliability in an Affordable Package



Since its introduction, the unique qualities of the Sony WL-800 Series UHF synthesized wireless microphone system have been proven in many different applications. It has been particularly successful in critical applications such as broadcasting and production, where its low noise, wide audio dynamic range, stable RF transmission and reception, and high reliability have been vital factors.

Sony has continually enhanced its WL-800 Series to fulfill the ever-increasing needs for wireless operations. Offering a broad range of choices, this family presents a solution to virtually any wireless microphone application from the very simple to the most sophisticated. Such applications include ENG and EFP location, conference and entertainment, TV studio production, theater, and live performance to name just a few. A variety of options are also made available so that systems are established to suit different operational needs.

The Sony WL-800 Series UHF synthesized wireless microphone system offers a perfect choice for all levels of operational and budgetary needs*.

*Sony WL-800 Series Wireless Microphone System and UWP Series Wireless Microphone System are not compatible.

Contents

Sony Wireless Microphone Common Features _____	3	Tuners _____	12	Optional Accessories _____	16	Frequency Lists _____	18
System Examples _____	4	• WRR-862A/862B		• ECM-88 Series		Feature Comparisons _____	20
Transmitters _____	8	• WRR-855S		• ECM-77 Series		Specifications _____	22
• WRT-847A/847B		• WRR-855A/855B		• ECM-66BC		Appendix _____	26
• WRT-867A		• WRR-861A/861B		• ECM-44 Series		• Multi-channel Simultaneous Operations	
• WRT-807A/807B		• MB-8N		• ECM-166BC		• Tuner and Camcorder Combinations	
• WRT-8P		• WRU-8N		• ECM-322BC		• Attaching to Camcorders	
• WRT-8B		• MB-806A		• BTA-801			
• WRT-822A/822B		• MB-X6		• DWA-01D			
		• WRU-806A/806B		• CA-WR855			
		Distributors and Antenna _____	15	• A-8278-057-B			
		• WD-850A		• EC-1.5CF			
		• WD-880A		• DMX-P01			
		• AN-820A					

Sony Wireless Microphone Common Features

PLL Synthesized System

Phase Locked Loop (PLL) frequency synthesized systems are employed both in transmitters and receivers, assuring carrier stability and providing easy access to multiple frequencies. These PLL controlled systems provide highly stable, selectable frequencies to be generated in increments of 125 kHz. Users may choose from 94* frequencies on A-series (USA type) models and from 188 frequencies on B-series (USA type) models.

*In the case of AU models, users may choose from 102 frequencies.

Space Diversity Reception System

A space diversity reception system is used to eliminate signal dropout. Dual antenna inputs and reception circuits incorporated in the diversity system receive signals over two different paths and select the stronger signal as the output. This switching operation is undetectable on the audio output of the receivers.

Pre-programmed Frequency Groups

Optimum combinations of calculated and practically tested intermodulation-free frequencies are stored in each receiver to make it easy to choose the correct frequencies for simultaneous multi-channel operation. These frequencies are arranged in groups, with each group pre-programmed to allow virtually interference free operation.

Advanced Filtering

The Sony wireless units all employ Helical, Ceramic and/or SAW (Surface Acoustic Wave) filters as appropriate. This offers stable reception and superb audio quality, and also enables the unique miniaturization seen in most of the Sony products.

Tone Squelch Circuitry

The wireless microphone transmitters also transmit a 32.768 kHz pilot-tone signal along with the audio signal. In the receivers, a squelch circuit is present, and the audio signal is only output when the tone signal has been correctly received.

This squelch function is designed to virtually prevent the output of unwanted signals or noise from other signal transmissions in the air, as well as the RF noise and popping noise that occur when the transmitter is power on or off.

Companer System for Wide Dynamic Range and Low Noise

A compander (compressor/expander) system is included for improved audio dynamic range and low noise and interference. The time constants for attack and release times are carefully chosen in the various transmitters to match the application, ensuring minimized noise level while providing smooth and superb audio quality.

Multiple Information on Easy-to-read LCD and LED

Most receivers and transmitters feature easy-to-read LCD panel and LED indicators, which provide extensive information on the operating conditions.

Most receivers will display the RF-input level, audio-output status, current channel number and frequency, and battery status of the transmitter.

Most transmitters do in essence have the same information available in the receivers such as audio-input and RF-output status, current channel number and frequency, input attenuation setting, and accumulated battery operating time.

Remote Battery Alarm on Receiver

For added assurance of continued operation, users can monitor the battery reserves of handheld, body pack and plug-on transmitters. Remaining battery life is indicated on both the transmitter and receiver, with additional indication approximate one hour* before the battery goes dead. On the receiver, the battery indicator on the LCD and LED displays also flash, helping to avoid the chance of battery failure at a critical moment.

*This may vary depending on the operational environment.

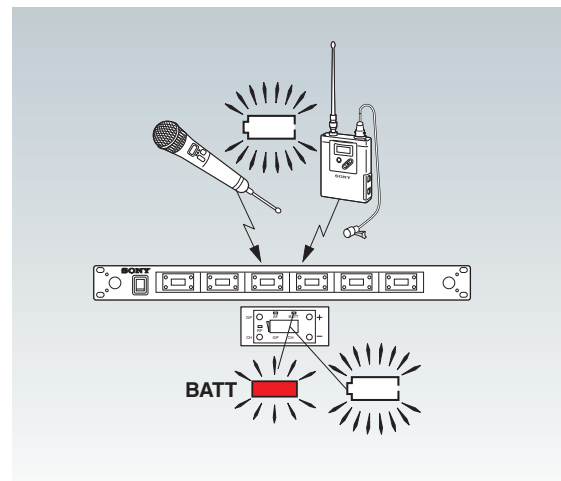

Consistent RF Power Output

A DC-DC convert circuit built into the power supply section of microphones/transmitters assures consistent output power over the life of the batteries.

Channel Setting Back Up

Each unit has a convenient memory back up for storing operating frequencies. When the power switch is turned on, the previous channel setting is automatically recalled and displayed.

System Examples

6-channel Simultaneous Operation

MB-X6 or MB-806A* System

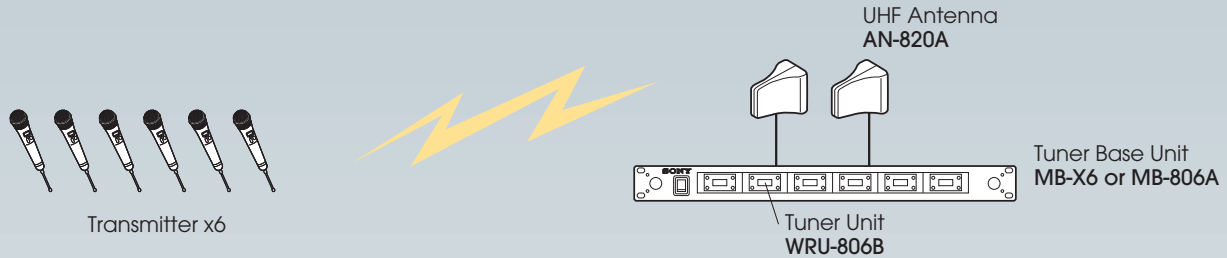

Required Components

Operation in TV 30-33 or TV 42-45 Channels

Model Number	Model Name	Operable TV Channel	Units
MB-X6	Tuner Base Unit	30-69	1
WRU-806B	Tuner Unit	30-33 or 42-45	6
AN-820A	UHF Antenna	L (30-45)	2
WRT Series	Transmitter	30-33 or 42-45	6

Operation in TV 62-65 or TV 66-69 Channels

Model Number	Model Name	Operable TV Channel	Units
MB-X6	Tuner Base Unit	30-69	1
WRU-806B	Tuner Unit	62-65 or 66-69	6
AN-820A	UHF Antenna	62-69	2
WRT Series	Transmitter	62-65 or 66-69	6

Model Number	Model Name	Operable TV Channel	Units
MB-806A	Tuner Base Unit	62-69	1
WRU-806B	Tuner Unit	62-65 or 66-69	6
AN-820A	UHF Antenna	62-69	2
WRT Series	Transmitter	62-65 or 66-69	6

* MB-806A does not support Channel 30-33 and 42-45 operation.

16-channel Simultaneous Operation

MB-X6 or MB-806A* System

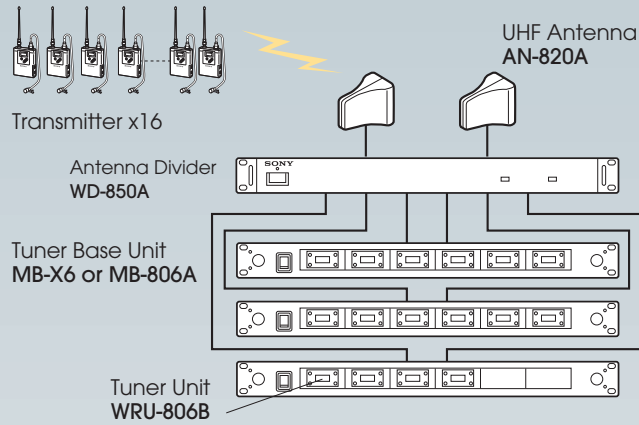

Required Components

Operation in TV 30-33 or TV 42-45 Channels

Model Number	Model Name	Operable TV Channel	Units
MB-X6	Tuner Base Unit	30-69	3
WRU-806B	Tuner Unit	30-33 or 42-45	16
AN-820A	UHF Antenna	L (30-45)	2
WRT Series	Transmitter	30-33 or 42-45	16
WD-850A	Antenna Divider	F (30-69)	1

Operation in TV 62-65 or TV 66-69 Channels

Model Number	Model Name	Operable TV Channel	Units
MB-X6	Tuner Base Unit	30-69	3
WRU-806B	Tuner Unit	62-65 or 66-69	16
AN-820A	UHF Antenna	62-69	2
WRT Series	Transmitter	62-65 or 66-69	16
WD-850A	Antenna Divider	62-69 or F (30-69)	1

Model Number	Model Name	Operable TV Channel	Units
MB-806A	Tuner Base Unit	62-69	3
WRU-806B	Tuner Unit	62-65 or 66-69	16
AN-820A	UHF Antenna	62-69	2
WRT Series	Transmitter	62-65 or 66-69	16
WD-850A	Antenna Divider	62-69 or F (30-69)	1

* MB-806A does not support Channel 30-33 and 42-45 operation.

MB-8N* System

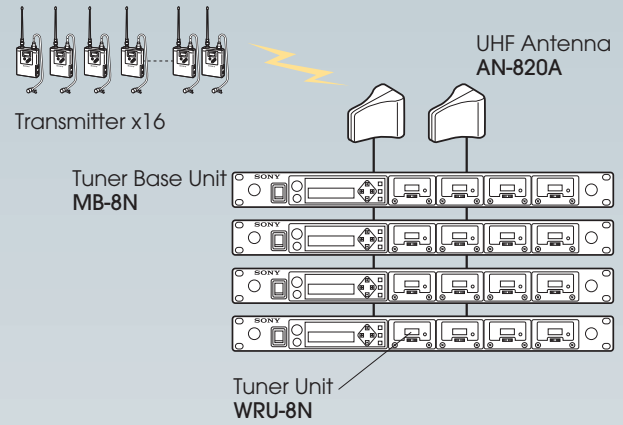

Required Components

Operation in TV 30-33 or TV 42-45 Channels

Model Number	Model Name	Operable TV Channel	Units
MB-8N	Tuner Base Unit	F (30-69)	4
WRU-8N	Tuner Unit	30-33 or 42-45	16
AN-820A	UHF Antenna	L (30-45)	2
WRT Series	Transmitter	30-33 or 42-45	16

Operation in TV 62-65 or TV 66-69 Channels

Model Number	Model Name	Operable TV Channel	Units
MB-8N	Tuner Base Unit	F (30-69)	4
WRU-8N	Tuner Unit	62-65 or 66-69	16
AN-820A	UHF Antenna	62-69	2
WRT Series	Transmitter	62-65 or 66-69	16

* Original MB-8N supports Channel 62-69 operation. Channel 30-69 operation requires new MB-8N F model.

System Examples

32-channel Simultaneous Operation

MB-X6 System

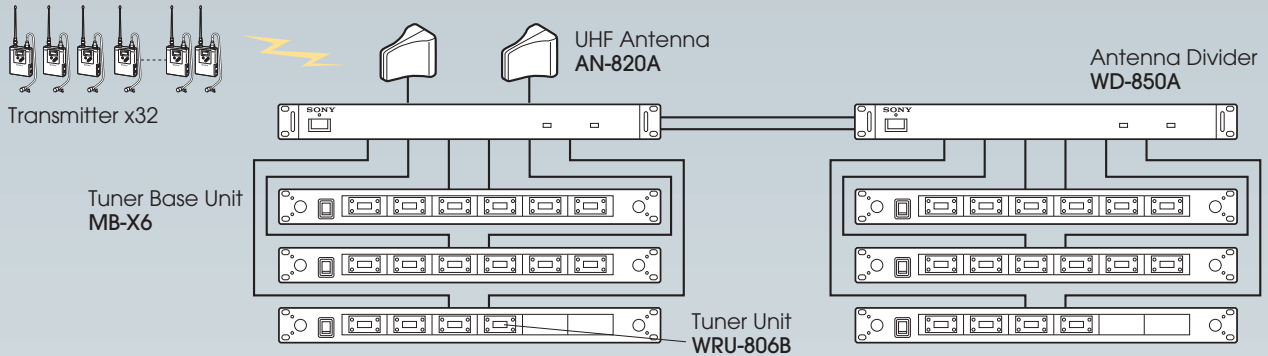

Required Components

Operation in TV 30-33 and TV 42-45 Channels*

Model Number	Model Name	Operable TV Channel	Units
MB-X6	Tuner Base Unit	30-69	6
WRU-806B	Tuner Unit	30-33 and 42-45	32
AN-820A	UHF Antenna	L (30-45)	2
WRT Series	Transmitter	30-33 and 42-45	32
WD-850A	Antenna Divider	F (30-69)	2

* Up to 22-channel simultaneous operation is possible using the B62/64 and B66/68 combination.

MB-8N* System

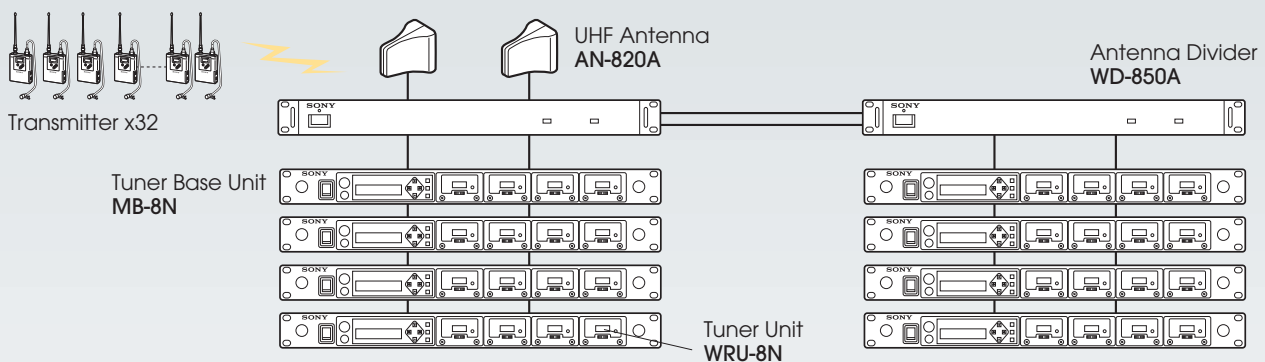

Required Components

Operation in TV 30-33 and TV 42-45 Channels**

Model Number	Model Name	Operable TV Channel	Units
MB-8N	Tuner Base Unit	F (30-69)	8
WRU-8N	Tuner Unit	30-33 and 42-45	32
AN-820A	UHF Antenna	L (30-45)	2
WRT Series	Transmitter	30-33 and 42-45	32
WD-850A	Antenna Divider	F (30-69)	2

* Original MB-8N supports Channel 62-69 operation. Channel 30-69 operation requires new MB-8N F model.

** Up to 22-channel simultaneous operation is possible using the B62/64 and B66/68 combination.

54-channel Simultaneous Operation

MB-8N* System

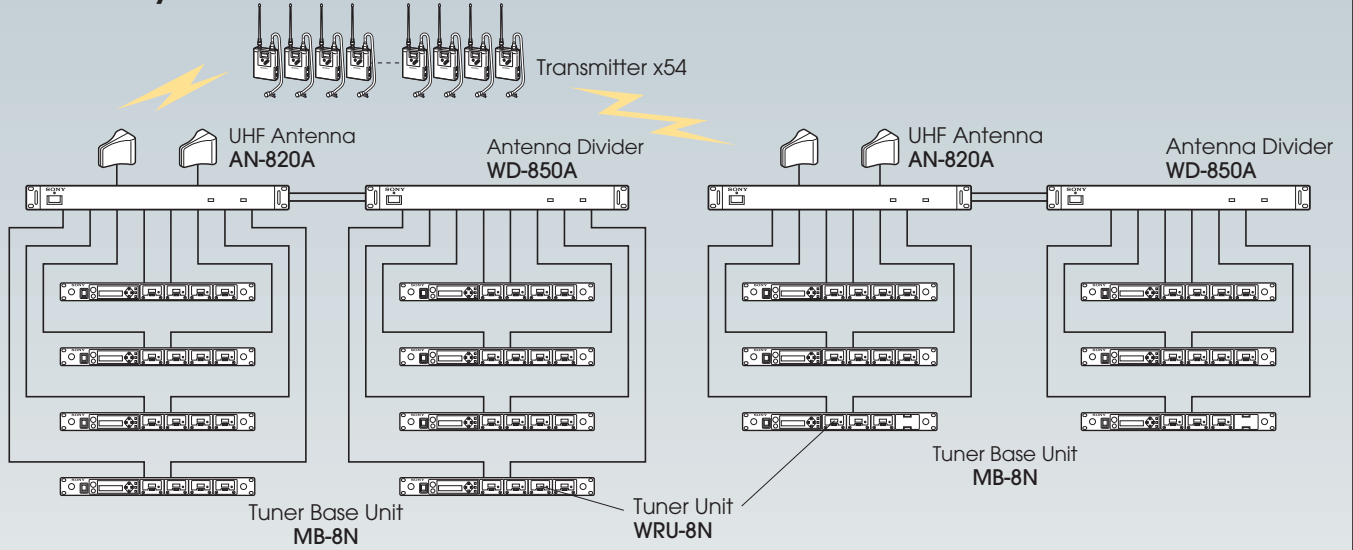

Required Components

Operation in TV 30-33, TV 42-45, and TV 62-69 Channels

Model Number	Model Name	Operable TV Channel	Units
MB-8N	Tuner Base Unit	F (30-69)	14
WRU-8N	Tuner Unit	30-33 and 42-45 and 62-65 and 66-69	54
AN-820A	UHF Antenna	L (30-45) and 62-69	4
WRT Series	Transmitter	30-33 and 42-45 and 62-65 and 66-69	54
WD-850A**	Antenna Divider	F (30-69)	4

* Original MB-8N supports Channel 62-69 operation. Channel 30-69 operation requires new MB-8N F model.

** Original WD-850A supports Channel 62-69 operation. Channel 30-69 operation requires new WD-850A F model.

The above system can be configured when using USA-type models.
When using AU-type models, max. 20-channel simultaneous operation is possible.

Transmitters

WRT-847A/847B UHF Synthesized Transmitter Unit

U30/32 U42/44 U62/64 U66/68 AU66



- Five optional microphone capsules are available, providing a choice of characteristics that suit a range of different applications. Microphone capsules are available individually. (One head is required for the WRT-847A/847B to function.)
- Audio compander time constant is switchable to suit different capsules
- Selectable RF output level: 10 mW for simultaneous multi-channel operation and 50 mW for long distance operation
- Audio gain and attenuation setting from +9 dB to -12 dB in 3 dB steps
- Lockable external power switch (ON/OFF)
- Two AA-size (LR6) alkaline batteries provide approximately eight hours of continuous operation

CU-F780 Capsule Unit



- Dynamic microphone capsule with super cardioid polar pattern
- Uses the same high quality edgewise winding CCAW voice coil that is employed in the acclaimed Sony F-780 wired microphone
- Designed for vocal applications including live music performance
- Frequency response: 50 Hz to 18 kHz
- Dimensions: \varnothing 2 1/8 x 3 5/8 inches (\varnothing 51 x 90 mm)
- Weight: 6.3 oz (180 g)

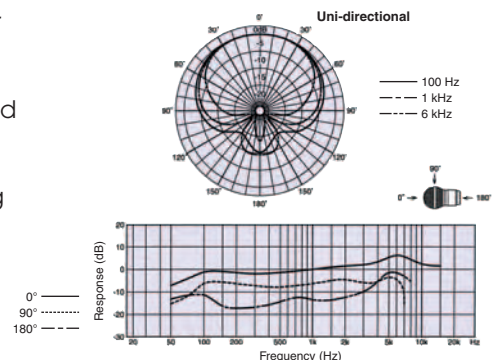

CU-G780 Capsule Unit



- Dynamic microphone capsule with super cardioid polar pattern
- Special design, based on the capsule of F-780 microphone, to cope with high sound pressure level vocals and incorporating outstanding feedback rejection
- Designed for vocal use
- Frequency response: 50 Hz to 20 kHz
- Dimensions: \varnothing 2 1/8 x 3 5/8 inches (\varnothing 51 x 90 mm)
- Weight: 6.3 oz (180 g)

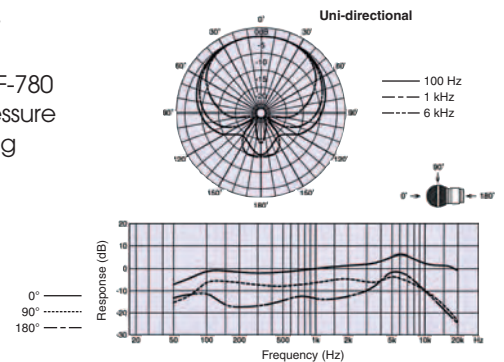

CU-E700 Capsule Unit



- Electret condenser microphone capsule with super cardioid polar pattern
- Smooth frequency response for natural sound reproduction
- Suitable for critical vocal and speech applications
- Frequency response: 50 Hz to 18 kHz
- Max. SPL: 150 dB
- Dimensions: \varnothing 2 1/8 x 3 7/8 inches (\varnothing 51 x 98 mm)
- Weight: 6.0 oz (170 g)

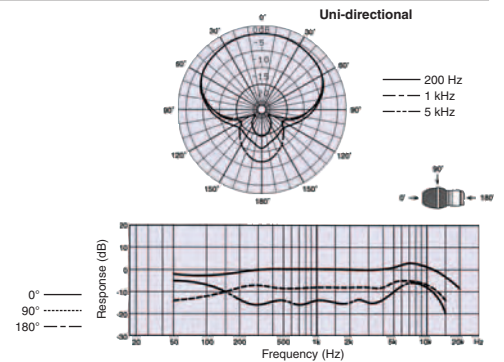

CU-E672 Capsule Unit



- Electret condenser microphone capsule with hyper cardioid polar pattern
- A wide variety of applications in news-gathering, sports events and interviews
- The supplied windscreen reduces wind noise and popping
- Frequency response: 50 Hz to 16 kHz
- Max. SPL: 120 dB
- Dimensions: \varnothing 1 1/2 x 6 7/8 inches (\varnothing 37 x 172 mm)
- Weight: 5.3 oz (150 g)
- Supplied accessory: Urethane windscreen (1)

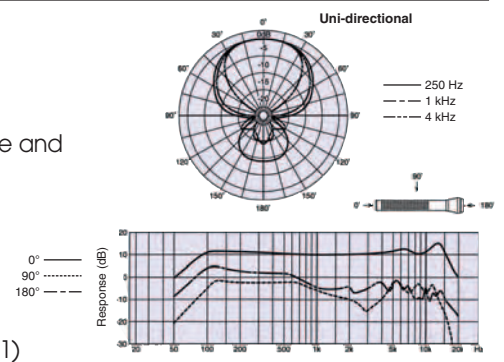

CU-F117 Capsule Unit



- Dynamic microphone capsule with omni-directional polar pattern
- Superb rejection of wind noise and popping
- Designed for interview applications
- Frequency response: 50 Hz to 15 kHz
- Dimensions: \varnothing 1 3/4 x 4 1/4 inches (\varnothing 44x 105 mm)
- Weight: 6.0 oz (170 g)
- Supplied accessory: Urethane windscreen (1)

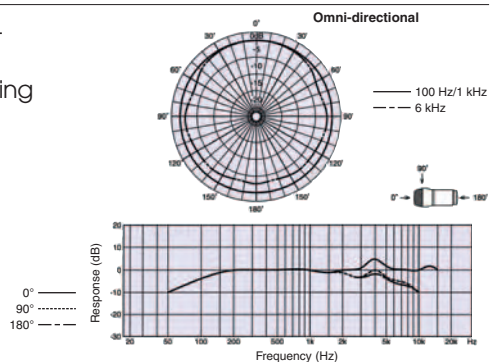

Transmitters

WRT-867A* UHF Synthesized Wireless Microphone U68 AU66



- Dynamic microphone capsule with super-cardioid polar pattern
- Resilient body structure for extremely high quality sound
- Incorporates a high quality, edgewise-winding voice coil with lightweight CCAW (Copper Clad Aluminum Wire) and AlNiCo magnet, which provides powerful, crisp and clear sound as well as presence in the middle and high frequency range
- Ideal for critical vocal applications for broadcast program and film production
- Channel select switches, audio attenuator switch and an LCD indicator inside the body to help prevent accidental operation

* AU66 model is not available in Australia.

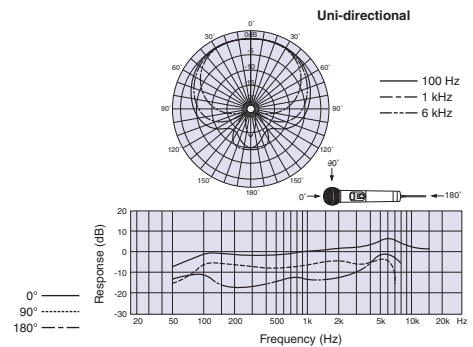

WRT-807A/807B UHF Synthesized Wireless Microphone U30/32 U42/44 U62/64 U66/68 AU66



- Uses the same dynamic microphone capsule that is employed in the F-780 professional wired microphone
- High quality sound for vocals – powerful, crisp and clear
- Single AA-size (LR6) alkaline battery provides continuous operation for approximately five hours
- Lockable external power switch (ON/OFF)

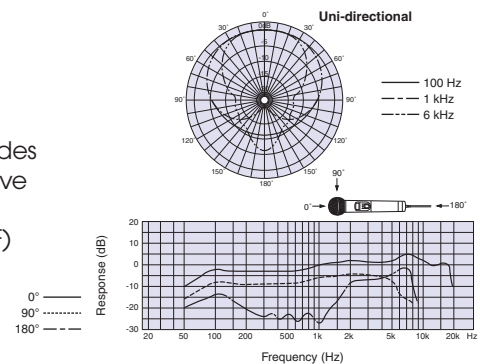

WRT-8P UHF Synthesized Transmitter U30/32 U42/44 U62/64 U66/68



- Converts a wired microphone to a wireless microphone via an XLR-type connector
- Compact and lightweight metal body provides high durability and good balance with compatible microphones
- 250 mW high RF output power for stable long-distance transmission
- Selectable RF output power: 250 mW/50 mW
- +48 V power supply capability
- Switchable input level: MIC/LINE
- Attenuator function allows adjustment of the audio-input level
- A backlit LCD provides extensive information
- Optimized balance when combined with the F-112 dynamic microphone

WRT-8B UHF Synthesized Transmitter

U30/32 U42/44 U62/64 U66/68 AU66



- Ultra compact and lightweight: 140 g including batteries (not supplied)
- Selectable RF power output: 50 mW output for long-distance transmission or 10 mW output for multi-channel simultaneous operation
- Switchable input level (LINE or MIC level) and attenuator level control knob
- SMA-J type, removable antenna
- Approximately 13 hours of continuous operation with two AA-size alkaline (LR6) batteries at 10 mW output (not supplied)
- Accepts the output of professional lavalier microphones equipped with a Sony 4-pin connector (SMC9-4P)

WRT-822A/822B UHF Synthesized Transmitter

U30/32 U42/44 U62/64 U66/68 AU66



- Approximately six* hours of continuous operation with two AA-size (LR6) alkaline batteries (not supplied)
- Compact, lightweight, magnesium alloy body
- 20** mW RF power output
- Accepts the output of professional lavalier microphones equipped with a Sony 4-pin connector (SMC9-4P)

* In the case of the WRT-822B (USA type).
The WRT-822A (AU type) offers approximately eight hours of continuous operation.

** In the case of the WRT-822B (USA type).
The WRT-822A (AU type) offers 10 mW power output.

Tuners



WRR-862A/862B UHF Synthesized Dual Diversity Tuner U30/32 U42/44 U62/64 U66/68 AU66

- Receives two independent RF signals simultaneously on two separate channels
- Compact and lightweight: 14.1 oz (400 g) including batteries (not supplied)
- Two way powering: Internal battery operation or operation on external power from Sony camcorders via the supplied cable
- A red LED starts flashing approximately one* hour before the transmitter's battery is exhausted
- Two Sony 4-pin (SMC9-4S) audio output connectors are provided on the top panel
- Switchable RF squelch levels: ON (5 dB μ , 10 dB μ , 15 dB μ) or OFF
- Stereo mini jack for monitoring the output sound (switchable: Tuner 1/Tuner 2/Mixed) with headphones
- Monitor volume control provided

*This time may vary depending on the operational environment.



WRR-855S UHF Synthesized Diversity Tuner U30/32 U42/44 U62/64 U66/68 AU66

- Space Diversity Tuner for camcorder use
- Easily mounts onto Sony HDCAM®/Digital Betacam®/XDCAM™/MPEG IMX® camcorders without need for audio/power cables or a mounting adapter
- Compact and lightweight design: 11 oz (280 g)
- A D-sub 15-pin connector for audio output to a Sony professional camcorder and for receiving its power supply from the camcorder
- A LCD provides various information such as RF input level and audio output status



WRR-855A/855B UHF Synthesized Diversity Tuner U30/32 U42/44 U62/64 U66/68 AU66

- Space Diversity Tuner for camcorder use
- Easily mounts onto Sony HDCAM/Digital Betacam/XDCAM/MPEG IMX camcorders without need for audio/power cables or a mounting adapter
- Compact and lightweight design: 11 oz (280 g)
- A D-sub 15-pin connector for audio output to a Sony professional camcorder and for receiving its power supply from the camcorder



WRR-861A/861B UHF Synthesized Diversity Tuner U30/32 U42/44 U62/64 U66/68 AU66

- Single-channel version of the WRR-862A/862B
- Two way powering: Internal battery operation or operation on external power from Sony camcorders via the supplied cable
- A red LED starts flashing approximately one* hour before the transmitter's battery is exhausted
- Switchable RF squelch levels: ON (5 dB μ , 10 dB μ , 15 dB μ) or OFF
- Stereo mini jack for monitoring the output sound
- Monitor volume control provided

*This time may vary depending on the operational environment.

MB-8N* Tuner Base Unit F (U30-69) AU66



Front Panel: MB-8N with four WRU-8N tuner units installed



Rear Panel

- Accommodates up to four WRU-8N tuner modules in a 1U high, rack-mountable chassis
- Built-in antenna-divider allows four MB-8Ns to be daisy-chained for up to 16-channel simultaneous operation without the need of an external divider. Addition of the WD-880A allows multi-channel operation with even more channels added
- Control settings such as audio output levels, RF squelch levels, attenuator levels for the installed tuner modules, and power supply setting (ON/OFF) for the connected AN-820A antennas are available from the front panel
- An auto channel assignment function for extra receiver modules with self-detection and skipping of unusable channels
- A headphone monitor jack and level control knob are located on the front panel. The monitor output can be selected from individual WRU-8N tuner modules or mixed sound from all installed modules
- Computer-based remote control is also possible via a standard Ethernet (10BASE-T) connection. The supplied software allows full monitoring of the operating status and all control settings available on both the MB-8N and WRU-8N. Multi-channel settings can be stored as files

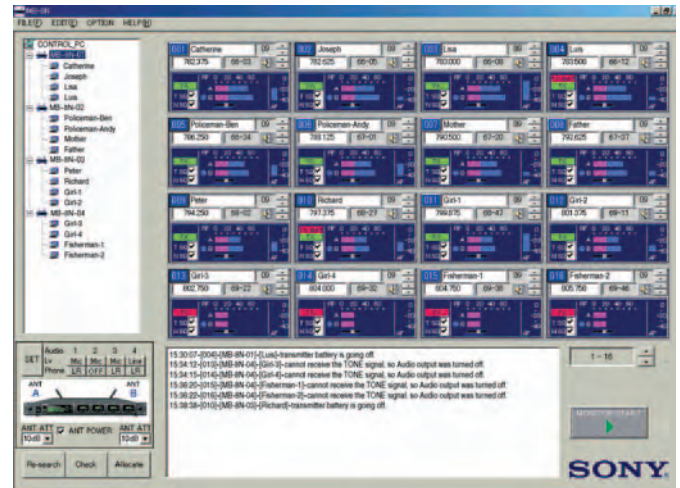

MB-8N supplied software GUI

* Original MB-8N supports Channel 62-69 operation. Channel 30-69 operation requires new MB-8N F model.

WRU-8N UHF Synthesized Tuner Unit U30/32 U42/44 U62/64 U66/68 AU66



- Plug-in diversity tuner module for the MB-8N tuner base unit
- A jog dial allows operators to quickly choose the desired channel setting
- Pre-programmed groups for interference-free, multi-channel operation
- A red LED starts flashing approximately one* hour before the transmitter's battery is exhausted
- Precise RF squelch level setting: 10 dBμ, 20 dBμ, 30 dBμ or OFF
- Space diversity reception for dependable RF reception

* This time may vary depending on the operational environment.

Tuners

MB-806A* Tuner Base Unit U62/69 AU66



Front Panel: MB-806A with six WRU-806A/806B tuner units installed



Rear Panel

- Accommodates up to six WRU-806A/806B for up to six channels of simultaneous operation
- Addition of the WD-850A or WD-880A allows multi-channel operation with even more channels
- RF input attenuator switch (10 dB/0 dB)
- Balanced XLR output connector for each tuner and mix output

- Selectable output level: -58 dBm (for MIC) or -20 dBm (for LINE) at ± 5 kHz deviation at 1 kHz modulation
- Auto channel assignment function for extra receiver modules with self-detection and skipping of unusable channels
- Supplied passive antennas for rear mounting (with provision for front mounting)
- Modular design, 1U high 19-inch rack unit

* MB-806A does not support Channel 30-33 and 42-45 operation.

MB-X6 Tuner Base Unit U30-69 AU66

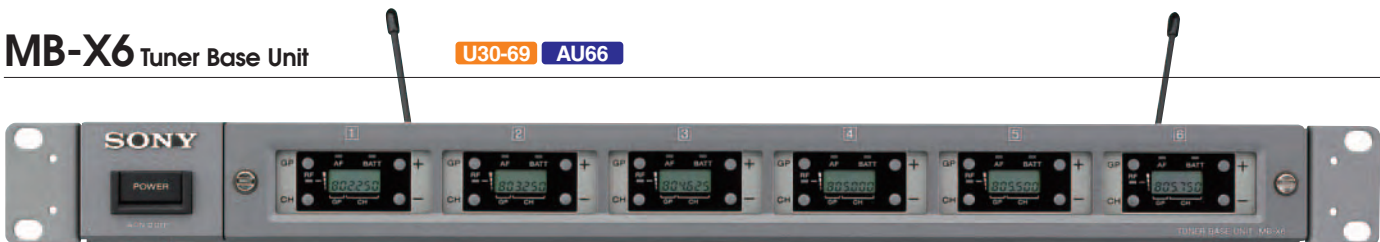

Front Panel: MB-X6 with six WRU-806A/806B tuner units installed



Rear Panel

- Accommodates up to six WRU-806A/806B for up to six channels of simultaneous operation
- Addition of the WD-850A or WD-880A allows multi-channel operation with even more channels
- Easy mechanism for attaching and detaching tuner modules
- RF input attenuator switch (10 dB/0 dB)

- Balanced XLR output connector for each tuner and mix output
- Selectable output level: -58 dBu (for MIC) or -20 dBu (for LINE) at ± 5 kHz deviation at 1 kHz modulation
- Auto channel search function automatically selects unoccupied channels
- Supplied with passive antennas
- Modular, 1U high, 19-inch rack unit

WRU-806A/806B* UHF Synthesized Tuner Unit U30/32 U42/44 U62/64 U66/68 AU66



- Plug-in diversity receiver module for MB-806A/X6 tuner base unit
- Pre-programmed groups for interference free, multi-channel operation
- RF input status, audio output status, and battery alarm indications by both LED and LCD to double check operating condition
- Space diversity reception for dependable RF reception

* Channel 30-33 and 42-45 operation is available when the WRU-806B (U30/32 or U42/44) is installed in the MB-X6.

Distributors and Antenna

WD-850A* UHF Antenna Divider F (U30-69) AU



Front Panel



Rear Panel

- Provides diversity output for up to four receivers/tuner base units
- Multi-channel operation by combination with the MB-8N and WRU-8N or the MB-806A/X6 and WRU-806A/806B
- Cascade output can be used for an additional antenna divider or receiver/tuner base unit
- Two pair of antenna input connectors for up to four AN-820A antennas to expand the operating area of a wireless microphone system

* Original WD-850A supports Channel 62-69 operation. Channel 30-69 operation requires new WD-850A F model.

WD-880A UHF Antenna Divider U64-69 AU66



WD-880A (USA type) Front Panel



WD-880A (USA type) Rear Panel

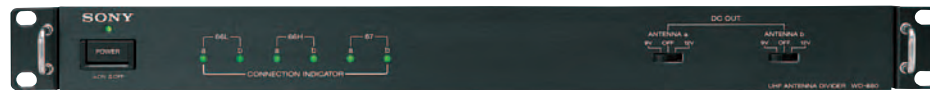

WD-880A (AU type) Front Panel



WD-880A (AU type) Rear Panel

- Ideal for complex, multi-channel applications from large scale live music events to TV OBs and large theater productions
 - Stable reception minimizing interference and distortion
 - Band pass SAW filters divide the spectrum of TV channels into multiple frequency bands, which are output from the WD-880A
 - Dual inputs and outputs for diversity operation
 - Switchable power supply (DC 9 V or 12 V) for the AN-820A UHF antennas
 - LED indicators to show the output connection status
 - 1U size rack mountable
- * The USA type operates in 770 MHz to 806 MHz.
The AU type operates in 792 MHz to 806 MHz.

AN-820A UHF Antenna L (U30-45) U62-69 AU66



- Built-in RF amplifier (10 dB gain)
- Easy installation on a wall or on a microphone stand with the supplied stand adapter
- Used in pairs for diversity reception
- LED indication for installation check
- External power supply provided from the MB-8N/806A/X6 or the WD-850A/880A via a coaxial cable

Optional Accessories



ECM-88 Series Lavalier Microphone

- Ultra-miniature, omni-directional microphone
- Rectangular dual-diaphragm mechanism contributes to a significant reduction in handling noise
- Water-resistant design
- Flat-and-wide frequency response: 20 Hz to 20 kHz

- Sensitivity: $-52 \text{ dB} \pm 2 \text{ dB}$ (in combination with optional DC-78) -39 dB (12.6 mW)
- Signal-to-noise ratio: 68 dB or more (A-weighted, 1 kHz, 1 Pa)
- Inherent noise: 26 dB SPL or less (A-weighted, 1 kHz, 1 Pa)
- Microphone head: 5/32 inch (3.5 mm) x 5/32 inch (3.5 mm) x 11/16 inch (16.8 mm), approx. 0.02 oz (0.6 g)
- Cable length: ECM-88BC: 3.9 feet (1.2 mm), ECM-88BPT/88FPT: 8.2 feet (2.5 mm)
- Three types available:
 - ECM-88BC:** Black-colored model supplied with a Sony 4-pin connector (SMC9-4P), for use with the WRT-8B/822A/822B
 - ECM-88BPT:** Black-colored model supplied without a connector (pigtail), enabling users to choose connectors according to their transmitter
 - ECM-88FPT:** Beige-colored model supplied without a connector (pigtail)

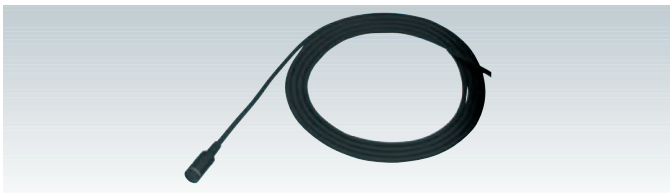

ECM-77 Series Lavalier Microphone

- High performance, miniature microphone
- Omni-directional, electret condenser microphone
- Frequency response: 40 Hz to 20 kHz
- Sensitivity: -39.0 dB (11.2 mV) (0 dB = 1V/Pa, at 1 kHz)
- Microphone head: 1/4 inch (5.6 mm) dia. x 1/2 inches (12.5 mm), approx. 0.05 oz (1.5 g)
- Cable length: ECM-77BC: 3.9 feet (1.2 m), ECM-77BPT: 9.8 feet (3.0 m)
- Two types available:
 - ECM-77BC:** Black-colored model supplied with a Sony 4-pin connector (SMC9-4P), for use with the WRT-8B/822A/822B
 - ECM-77BPT:** Black-colored model supplied without a connector (pigtail), enabling users to choose connectors according to their transmitter

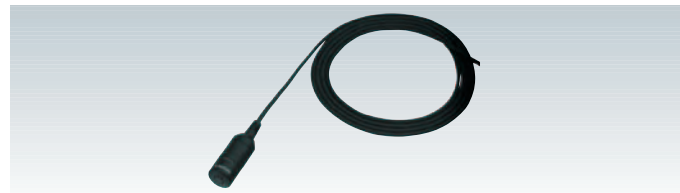

ECM-66BC Lavalier Microphone

- Uni-directional, electret condenser microphone
- Resistant to howling by rejecting indirect sound
- Wide dynamic range (101 dB), and high maximum input-sound-pressure level (130 dB SPL)
- Frequency: 70 Hz to 14 kHz
- Sensitivity: -36.5 dB (15 mV) (0 dB = 1 V/Pa, at 1 kHz)
- Low inherent-noise characteristics
- Microphone head: 7/16 inch (10.6 mm) dia. x 31/32 inch (24.2 mm), approx. 0.25 oz (7 g)
- Cable length: 3.9 feet (1.2 m)
- Black-colored model supplied with a Sony 4-pin connector (SMC9-4P), for use with the WRT-8B/822A/822B

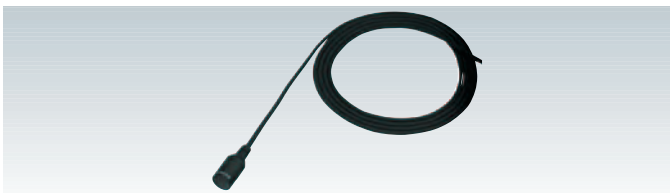

ECM-44 Series Lavalier Microphone

- Omni-directional, electret condenser microphone
- Superb sound quality
- Frequency response: 40 Hz to 15 kHz
- Sensitivity: -40 dB SPL (10 mV) (0 dB = 1V/Pa, at 1 kHz)
- Microphone head: 11/32 inch (8.5 mm) dia. x 19/32 inches (14.5 mm), approx. 0.07 oz (2 g)
- Cable length: ECM-44BC: 3.9 feet (1.2 m), ECM-44BPT: 9.8 feet (3.0 m)
- Two types available:
 - ECM-44BC:** Black-colored model supplied with a Sony 4-pin connector (SMC9-4P), for use with the WRT-8B/822A/822B
 - ECM-44BPT:** Black-colored model supplied without a connector (pigtail)



ECM-166BC Lavalier Microphone

- Uni-directional, electret condenser microphone
- Resistant to howling by rejecting indirect sound
- Ideal for institutional uses and sound contracting applications such as speeches, lectures and conferences
- Frequency response: 100 Hz to 10 kHz
- Sensitivity: -45 dB (5.6 mV) (0 dB = 1V/Pa, at 1 kHz)
- Microphone head: 1/2 inch (12.5 mm) dia. x 15/16 inches (23.5 mm), approx. 0.12 oz (3.5 g)
- Cable length: 3.9 feet (1.2 m)
- Supplied with the Sony 4-pin (SMC9-4P) connector for use with the WRT-8B/822A/822B



ECM-322BC

Headset Microphone

- Omni-directional, electret condenser microphone
- Ear-clip style design wearable on either the left or right ear
- Secure and comfortably fit with the adjustable soft-texture ear hook and detachable headband
- Ideal for a variety of multimedia presentation applications
- Frequency response: 50 Hz to 18 kHz
- Sensitivity: -42 dB (7.94 mV) (0 dB = 1 V/Pa, at 1 kHz)
- Cable length: 3.9 feet (1.2 mm)
- Supplied with the Sony 4-pin connector (SMC9-4P) for use with the WRT-8B/822A/822B



BTA-801

Portable Tuner Mount Adapter

- Allows a WRR-855S/855A/855B portable tuner to be mounted on a Sony professional camcorder
- External DC power input via the supplied 4-pin cable



DWA-01D

Digital Wireless Adapter

- Allows a WRR-855S/855A/855B portable tuner to be mounted on a Sony professional camcorder
- External DC power input via the supplied 4-pin cable
- Headphone output for monitoring (stereo mini jack)



CA-WR855

Camera Adapter

- Enables a WRR-855S/855A/855B portable tuner to be mounted on Sony DSR-450WS/450WSP/400/400P DVCAM camcorders and PDW-F355/F335 XDCAM HD® camcorders with direct audio/power connection interfaces

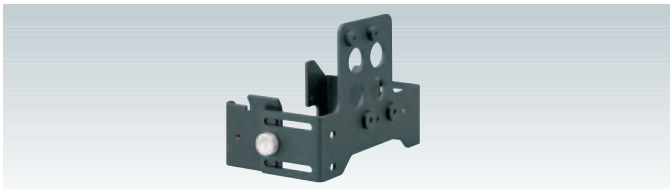

A-8278-057-B

Mounting Bracket

- For mounting any Sony portable tuner to Sony professional camcorders which operate on Sony Lithium-Ion battery packs



EC-1.5CF

Microphone Cable

- Fitted with an XLR-3-11 connector and SMC9-4P connector
- Allows a microphone with a 3-pin male XLR output connector to be connected to WRT-8B/822A/822B bodypack transmitter
- Cable length: 4.9 feet (1.5 m)



DMX-P01

Digital Portable Mixer

- Portable, digital field-mixer designed for ENG/EPF application
- Compact and lightweight: 4.9 feet (266 x 68 x 206 mm) and approx. 4 lb 13 oz (2.2 kg)
- 24-bit A/D and D/A converters and internal 32-bit DSP for excellent sound quality
- 4 microphone/line inputs with +48 V mic power (on/off)

- 2 channels of balanced analog output and AES/EBU digital output (stereo) via XLR-type connectors
- Digital cascade input with phono connector
- Coaxial output connector for mix-bus output or S/PDIF digital output
- Selectable sampling rate: 48 kHz or 96 kHz
- Full control of every parameter from the front panel using physical and menu-driven controls
- Digital limiters on both inputs and outputs, and digital compressors on outputs
- A scene memory recall feature to instantly recall up to ten different user-defined parameter settings or factory default settings
- Camera-audio return-level check via 12-pin connector
- Adjustable HPF with two user settings
- Operates on eight AA-size alkaline (LR6) batteries or external DC 10 to 15 V power

Frequency Lists

A64 (USA type)

64-01	770.125	65-01	776.125
64-02	770.250	65-02	776.250
64-03	770.375	65-03	776.375
64-04	770.500	65-04	776.500
64-05	770.625	65-05	776.625
64-06	770.750	65-06	776.750
64-07	770.875	65-07	776.875
64-08	771.000	65-08	777.000
64-09	771.125	65-09	777.125
64-10	771.250	65-10	777.250
64-11	771.375	65-11	777.375
64-12	771.500	65-12	777.500
64-13	771.625	65-13	777.625
64-14	771.750	65-14	777.750
64-15	771.875	65-15	777.875
64-16	772.000	65-16	778.000
64-17	772.125	65-17	778.125
64-18	772.250	65-18	778.250
64-19	772.375	65-19	778.375
64-20	772.500	65-20	778.500
64-21	772.625	65-21	778.625
64-22	772.750	65-22	778.750
64-23	772.875	65-23	778.875
64-24	773.000	65-24	779.000
64-25	773.125	65-25	779.125
64-26	773.250	65-26	779.250
64-27	773.375	65-27	779.375
64-28	773.500	65-28	779.500
64-29	773.625	65-29	779.625
64-30	773.750	65-30	779.750
64-31	773.875	65-31	779.875
64-32	774.000	65-32	780.000
64-33	774.125	65-33	780.125
64-34	774.250	65-34	780.250
64-35	774.375	65-35	780.375
64-36	774.500	65-36	780.500
64-37	774.625	65-37	780.625
64-38	774.750	65-38	780.750
64-39	774.875	65-39	780.875
64-40	775.000	65-40	781.000
64-41	775.125	65-41	781.125
64-42	775.250	65-42	781.250
64-43	775.375	65-43	781.375
64-44	775.500	65-44	781.500
64-45	775.625	65-45	781.625
64-46	775.750	65-46	781.750
64-47	775.875	65-47	781.875

A66 (USA type)

66-01	782.125	67-01	788.125
66-02	782.250	67-02	788.250
66-03	782.375	67-03	788.375
66-04	782.500	67-04	788.500
66-05	782.625	67-05	788.625
66-06	782.750	67-06	788.750
66-07	782.875	67-07	788.875
66-08	783.000	67-08	789.000
66-09	783.125	67-09	789.125
66-10	783.250	67-10	789.250
66-11	783.375	67-11	789.375
66-12	783.500	67-12	789.500
66-13	783.625	67-13	789.625
66-14	783.750	67-14	789.750
66-15	783.875	67-15	789.875
66-16	784.000	67-16	790.000
66-17	784.125	67-17	790.125
66-18	784.250	67-18	790.250
66-19	784.375	67-19	790.375
66-20	784.500	67-20	790.500
66-21	784.625	67-21	790.625
66-22	784.750	67-22	790.750
66-23	784.875	67-23	790.875
66-24	785.000	67-24	791.000
66-25	785.125	67-25	791.125
66-26	785.250	67-26	791.250
66-27	785.375	67-27	791.375
66-28	785.500	67-28	791.500
66-29	785.625	67-29	791.625
66-30	785.750	67-30	791.750
66-31	785.875	67-31	791.875
66-32	786.000	67-32	792.000
66-33	786.125	67-33	792.125
66-34	786.250	67-34	792.250
66-35	786.375	67-35	792.375
66-36	786.500	67-36	792.500
66-37	786.625	67-37	792.625
66-38	786.750	67-38	792.750
66-39	786.875	67-39	792.875
66-40	787.000	67-40	793.000
66-41	787.125	67-41	793.125
66-42	787.250	67-42	793.250
66-43	787.375	67-43	793.375
66-44	787.500	67-44	793.500
66-45	787.625	67-45	793.625
66-46	787.750	67-46	793.750
66-47	787.875	67-47	793.875

A68 (USA type)

68-01	794.125	69-01	800.125
68-02	794.250	69-02	800.250
68-03	794.375	69-03	800.375
68-04	794.500	69-04	800.500
68-05	794.625	69-05	800.625
68-06	794.750	69-06	800.750
68-07	794.875	69-07	800.875
68-08	795.000	69-08	801.000
68-09	795.125	69-09	801.125
68-10	795.250	69-10	801.250
68-11	795.375	69-11	801.375
68-12	795.500	69-12	801.500
68-13	795.625	69-13	801.625
68-14	795.750	69-14	801.750
68-15	795.875	69-15	801.875
68-16	796.000	69-16	802.000
68-17	796.125	69-17	802.125
68-18	796.250	69-18	802.250
68-19	796.375	69-19	802.375
68-20	796.500	69-20	802.500
68-21	796.625	69-21	802.625
68-22	796.750	69-22	802.750
68-23	796.875	69-23	802.875
68-24	797.000	69-24	803.000
68-25	797.125	69-25	803.125
68-26	797.250	69-26	803.250
68-27	797.375	69-27	803.375
68-28	797.500	69-28	803.500
68-29	797.625	69-29	803.625
68-30	797.750	69-30	803.750
68-31	797.875	69-31	803.875
68-32	798.000	69-32	804.000
68-33	798.125	69-33	804.125
68-34	798.250	69-34	804.250
68-35	798.375	69-35	804.375
68-36	798.500	69-36	804.500
68-37	798.625	69-37	804.625
68-38	798.750	69-38	804.750
68-39	798.875	69-39	804.875
68-40	799.000	69-40	805.000
68-41	799.125	69-41	805.125
68-42	799.250	69-42	805.250
68-43	799.375	69-43	805.375
68-44	799.500	69-44	805.500
68-45	799.625	69-45	805.625
68-46	799.750	69-46	805.750
68-47	799.875	69-47	805.875

AU66 (AU type)

66-01	792.250	67-01	799.250
66-02	792.375	67-02	799.375
66-03	792.500	67-03	799.500
66-04	792.625	67-04	799.625
66-05	792.750	67-05	799.750
66-06	792.875	67-06	799.875
66-07	793.000	67-07	800.000
66-08	793.125	67-08	800.125
66-09	793.250	67-09	800.250
66-10	793.375	67-10	800.375
66-11	793.500	67-11	800.500
66-12	793.625	67-12	800.625
66-13	793.750	67-13	800.750
66-14	793.875	67-14	800.875
66-15	794.000	67-15	801.000
66-16	794.125	67-16	801.125
66-17	794.250	67-17	801.250
66-18	794.375	67-18	801.375
66-19	794.500	67-19	801.500
66-20	794.625	67-20	801.625
66-21	794.750	67-21	801.750
66-22	794.875	67-22	801.875
66-23	795.000	67-23	802.000
66-24	795.125	67-24	802.125
66-25	795.250	67-25	802.250
66-26	795.375	67-26	802.375
66-27	795.500	67-27	802.500
66-28	795.625	67-28	802.625
66-29	795.750	67-29	802.750
66-30	795.875	67-30	802.875
66-31	796.000	67-31	803.000
66-32	796.125	67-32	803.125
66-33	796.250	67-33	803.250
66-34	796.375	67-34	803.375
66-35	796.500	67-35	803.500
66-36	796.625	67-36	803.625
66-37	796.750	67-37	803.750
66-38	796.875	67-38	803.875
66-39	797.000	67-39	804.000
66-40	797.125	67-40	804.125
66-41	797.250	67-41	804.250
66-42	797.375	67-42	804.375
66-43	797.500	67-43	804.500
66-44	797.625	67-44	804.625
66-45	797.750	67-45	804.750
66-46	797.875	67-46	804.875
66-47	798.000	67-47	805.000
66-48	798.125	67-48	805.125
66-49	798.250	67-49	805.250
66-50	798.375	67-50	805.375
66-51	798.500	67-51	805.500

B30/32 (USA type)

30-01	566.125	31-01	572.125	32-01	578.125	33-01	584.125
30-02	566.250	31-02	572.250	32-02	578.250	33-02	584.250
30-03	566.375	31-03	572.375	32-03	578.375	33-03	584.375
30-04	566.500	31-04	572.500	32-04	578.500	33-04	584.500
30-05	566.625	31-05	572.625	32-05	578.625	33-05	584.625
30-06	566.750	31-06	572.750	32-06	578.750	33-06	584.750
30-07	566.875	31-07	572.875	32-07	578.875	33-07	584.875
30-08	567.000	31-08	573.000	32-08	579.000	33-08	585.000
30-09	567.125	31-09	573.125	32-09	579.125	33-09	585.125
30-10	567.250	31-10	573.250	32-10	579.250	33-10	585.250
30-11	567.375	31-11	573.375	32-11	579.375	33-11	585.375
30-12	567.500	31-12	573.500	32-12	579.500	33-12	585.500
30-13	567.625	31-13	573.625	32-13	579.625	33-13	585.625
30-14	567.750	31-14	573.750	32-14	579.750	33-14	585.750
30-15	567.875	31-15	573.875	32-15	579.875	33-15	585.875
30-16	568.000	31-16	574.000	32-16	580.000	33-16	586.000
30-17	568.125	31-17	574.125	32-17	580.125	33-17	586.125
30-18	568.250	31-18	574.250	32-18	580.250	33-18	586.250
30-19	568.375	31-19	574.375	32-19	580.375	33-19	586.375
30-20	568.500	31-20	574.500	32-20	580.500	33-20	586.500
30-21	568.625	31-21	574.625	32-21	580.625	33-21	586.625
30-22	568.750	31-22	574.750	32-22	580.750	33-22	586.750
30-23	568.875	31-23	574.875	32-23	580.875	33-23	586.875
30-24	569.000	31-24	575.000	32-24	581.000	33-24	587.000
30-25	569.125	31-25	575.125	32-25	581.125	33-25	587.125
30-26	569.250	31-26	575.250	32-26	581.250	33-26	587.250
30-27	569.375	31-27	575.375	32-27	581.375	33-27	587.375
30-28	569.500	31-28	575.500	32-28	581.500	33-28	587.500
30-29	569.625	31-29	575.625	32-29	581.625	33-29	587.625
30-30	569.750	31-30	575.750	32-30	581.750	33-30	587.750
30-31	569.875	31-31	575.875	32-31	581.875	33-31	587.875
30-32	570.000	31-32	576.000	32-32	582.000	33-32	588.000
30-33	570.125	31-33	576.125	32-33	582.125	33-33	588.125
30-34	570.250	31-34	576.250	32-34	582.250	33-34	588.250
30-35	570.375	31-35	576.375	32-35	582.375	33-35	588.375
30-36	570.500	31-36	576.500	32-36	582.500	33-36	588.500
30-37	570.625	31-37	576.625	32-37	582.625	33-37	588.625
30-38	570.750	31-38	576.750	32-38	582.750	33-38	588.750
30-39	570.875	31-39	576.875	32-39	582.875	33-39	588.875
30-40	571.000	31-40	577.000	32-40	583.000	33-40	589.000
30-41	571.125	31-41	577.125	32-41	583.125	33-41	589.125
30-42	571.250	31-42	577.250	32-42	583.250	33-42	589.250
30-43	571.375	31-43	577.375	32-43	583.375	33-43	589.375
30-44	571.500	31-44	577.500	32-44	583.500	33-44	589.500
30-45	571.625	31-45	577.625	32-45	583.625	33-45	589.625
30-46	571.750	31-46	577.750	32-46	583.750	33-46	589.750
30-47	571.875	31-47	577.875	32-47	583.875	33-47	589.875

B42/44 (USA type)

42-01	638.125	43-01	644.125	44-01	650.125	45-01	656.125
42-02	638.250	43-02	644.250	44-02	650.250	45-02	656.250
42-03	638.375	43-03	644.375	44-03	650.375	45-03	656.375
42-04	638.500	43-04	644.500	44-04	650.500	45-04	656.500
42-05	638.625	43-05	644.625	44-05	650.625	45-05	656.625
42-06	638.750	43-06	644.750	44-06	650.750	45-06	656.750
42-07	638.875	43-07	644.875	44-07	650.875	45-07	656.875
42-08	639.000	43-08	645.000	44-08	651.000	45-08	657.000
42-09	639.125	43-09	645.125	44-09	651.125	45-09	657.125
42-10	639.250	43-10	645.250	44-10	651.250	45-10	657.250
42-11	639.375	43-11	645.375	44-11	651.375	45-11	657.375
42-12	639.500	43-12	645.500	44-12	651.500	45-12	657.500
42-13	639.625	43-13	645.625	44-13	651.625	45-13	657.625
42-14	639.750	43-14	645.750	44-14	651.750	45-14	657.750
42-15	639.875	43-15	645.875	44-15	651.875	45-15	657.875
42-16	640.000	43-16	646.000	44-16	652.000	45-16	658.000
42-17	640.125	43-17	646.125	44-17	652.125	45-17	658.125
42-18	640.250	43-18	646.250	44-18	652.250	45-18	658.250
42-19	640.375	43-19	646.375	44-19	652.375	45-19	658.375
42-20	640.500	43-20	646.500	44-20	652.500	45-20	658.500
42-21	640.625	43-21	646.625	44-21	652.625	45-21	658.625
42-22	640.750	43-22	646.750	44-22	652.750	45-22	658.750
42-23	640.875	43-23	646.875	44-23	652.875	45-23	658.875
42-24	641.000	43-24	647.000	44-24	653.000	45-24	659.000
42-25	641.125	43-25	647.125	44-25	653.125	45-25	659.125
42-26	641.250	43-26	647.250	44-26	653.250	45-26	659.250
42-27	641.375	43-27	647.375	44-27	653.375	45-27	659.375
42-28	641.500	43-28	647.500	44-28	653.500	45-28	659.500
42-29	641.625	43-29	647.625	44-29	653.625	45-29	659.625
42-30	641.750	43-30	647.750	44-30	653.750	45-30	659.750
42-31	641.875	43-31	647.875	44-31	653.875	45-31	659.875
42-32	642.000	43-32	648.000	44-32	654.000	45-32	660.000
42-33	642.125	43-33	648.125	44-33	654.125	45-33	660.125
42-34	642.250	43-34	648.250	44-34	654.250	45-34	660.250
42-35	642.375	43-35	648.375	44-35	654.375	45-35	660.375
42-36	642.500	43-36	648.500	44-36	654.500	45-36	660.500
42-37	642.625	43-37	648.625	44-37	654.625	45-37	660.625
42-38	642.750	43-38	648.750	44-38	654.750	45-38	660.750
42-39	642.875	43-39	648.875	44-39	654.875	45-39	660.875
42-40	643.000	43-40	649.000	44-40	655.000	45-40	661.000
42-41	643.125	43-41	649.125	44-41	655.125	45-41	661.125
42-42	643.250	43-42	649.250	44-42	655.250	45-42	661.250
42-43	643.375	43-43	649.375	44-43	655.375	45-43	661.375
42-44	643.500	43-44	649.500	44-44	655.500	45-44	661.500
42-45	643.625	43-45	649.625	44-45	655.625	45-45	661.625
42-46	643.750	43-46	649.750	44-46	655.750	45-46	661.750
42-47	643.875	43-47	649.875	44-47	655.875	45-47	661.875

B62/64 (USA type)

62-01	758.125	63-01	764.125	64-01	770.125	65-01	776.125
62-02	758.250	63-02	764.250	64-02	770.250	65-02	776.250
62-03	758.375	63-03	764.375	64-03	770.375	65-03	776.375
62-04	758.500	63-04	764.500	64-04	770.500	65-04	776.500
62-05	758.625	63-05	764.625	64-05	770.625	65-05	776.625
62-06	758.750	63-06	764.750	64-06	770.750	65-06	776.750
62-07	758.875	63-07	764.875	64-07	770.875	65-07	776.875
62-08	759.000	63-08	765.000	64-08	771.000	65-08	777.000
62-09	759.125	63-09	765.125	64-09	771.125	65-09	777.125
62-10	759.250	63-10	765.250	64-10	771.250	65-10	777.250
62-11	759.375	63-11	765.375	64-11	771.375	65-11	777.375
62-12	759.500	63-12	765.500	64-12	771.500	65-12	777.500
62-13	759.625	63-13	765.625	64-13	771.625	65-13	777.625
62-14	759.750	63-14	765.750	64-14	771.750	65-14	777.750
62-15	759.875	63-15	765.875	64-15	771.875	65-15	777.875
62-16	760.000	63-16	766.000	64-16	772.000	65-16	778.000
62-17	760.125	63-17	766.125	64-17	772.125	65-17	778.125
62-18	760.250	63-18	766.250	64-18	772.250	65-18	778.250
62-19	760.375	63-19	766.375	64-19	772.375	65-19	778.375
62-20	760.500	63-20	766.500	64-20	772.500	65-20	778.500
62-21	760.625	63-21	766.625	64-21	772.625	65-21	778.625
62-22	760.750	63-22	766.750	64-22	772.750	65-22	778.750
62-23	760.875	63-23	766.875	64-23	772.875	65-23	778.875
62-24	761.000	63-24	767.000	64-24	773.000	65-24	779.000
62-25	761.125	63-25	767.125	64-25	773.125	65-25	779.125
62-26	761.250	63-26	767.250	64-26	773.250	65-26	779.250
62-27	761.375	63-27	767.375	64-27	773.375	65-27	779.375
62-28	761.500	63-28	767.500	64-28	773.500	65-28	779.500
62-29	761.625	63-29	767.625	64-29	773.625	65-29	779.625
62-30	761.750	63-30	767.750	64-30	773.750	65-30	779.750
62-31	761.875	63-31	767.875	64-31	773.875	65-31	779.875
62-32	762.000	63-32	768.000	64-32	774.000	65-32	780.000
62-33	762.125	63-33	768.125	64-33	774.125	65-33	780.125
62-34	762.250	63-34	768.250	64-34	774.250	65-34	780.250
62-35	762.375	63-35	768.375	64-35	774.375	65-35	780.375
62-36	762.500	63-36	768.500	64-36	774.500	65-36	780.500
62-37	76						

Feature Comparisons

Handheld Microphones

	WRT-847A WRT-847B	WRT-867A*	WRT-807A WRT-807B
UHF, PLL synthesized system	●	●	●
Operating frequency band	24 MHz band (WRT-847B, USA type) 14 MHz band (WRT-847A, AU type)	12 MHz band (USA type) 14 MHz band (AU type)	24 MHz band (WRT-807B, USA type) 14 MHz band (WRT-807A, AU type)
Tone signal	●	●	●
Compander system (compressor)	●	●	●
Microphone capsule	Dynamic, uni-directional (with optional CU-F780/G780) Dynamic, omni-directional (with optional CU-F117) Electret condenser, uni-directional (with optional CU-E700/E672)	Dynamic, uni-directional	Dynamic, uni-directional
Audio-attenuator levels	-12 dB to +9 dB (in 3 dB steps)	0 dB, 6 dB or 12 dB	0 dB to 21 dB (in 3 dB steps)
Antenna	1/4 wavelength whip antenna	Helical antenna	1/4 wavelength whip antenna
RF power output	50 mW or 10 mW	10 mW	10 mW
LCD panel	Channel number, Frequency in MHz, Audio input status, RF-output level setting (Low or High), RF output status, Compander time constant, Attenuator level, Battery reserve, Accumulated operating time	Channel number	Channel number, Frequency in MHz, Audio input status, RF output status, Attenuator level, Battery reserve, Accumulated operating time
LED indicators	—	Power-on status	—
Transmission of battery status	●	—	●
Battery life	Approx. 8 hours	Approx. 5 hours	Approx. 5 hours
Channel setting back-up	●	●	●
Supplied accessories	Microphone holder (1), Stand adapter (1), Channel color seal (1), Soft case (1), Operating instructions (1)	Microphone holder (1), Stand adapter (1), Channel color seal (1), Operating instructions (1)	Microphone holder (1), Metal-screw stand adapter (1), Operating instructions (1)

*WRT-867A AU model is not available in Australia.

Bodypack/Plug-on Transmitters

	WRT-8B	WRT-822A WRT-822B	WRT-8P
UHF, PLL synthesized system	●	●	●
Operating frequency band	24 MHz band (USA type) 14 MHz band (AU type)	24 MHz band (WRT-822B, USA type) 14 MHz band (WRT-822A, AU type)	24 MHz band (USA type)
Tone signal	●	●	●
Compander system (compressor)	●	●	●
Audio-attenuator levels	0 dB to 40 dB, continuous	0 dB to 21 dB (in 3 dB steps)	0 dB to 20 dB, continuous
Antenna	1/4 wavelength whip antenna (removable)	1/4 wavelength whip antenna	Integrated type
RF power output	50 mW or 10 mW	10 mW with WRT-822A 20 mW with WRT-822B	250 mW or 50 mW
LCD panel	Channel number, Frequency in MHz, Audio input status, RF output level setting (Low or High), RF output status, Battery reserve, Accumulated operating time	Channel number, Frequency in MHz, Audio input status, RF output status, Attenuator level, Battery reserve, Accumulated operating time	Channel number, Frequency in MHz, Audio input status, Audio input status (MIC/LINE), RF output level setting (Low or High), RF output status, Battery reserve, +48 V power status
LED indicators	Audio input level (peak level)	—	Audio input level (reference level or peak level) +48 V power supply
Transmission of battery status	●	●	●
Audio input connectors	Sony 4-pin (SMC9-4S)	Sony 4-pin (SMC9-4S)	XLR type 3-pin
Battery life*	Approx. 13 hours at 10 mW output Approx. 6 hours at 50 mW output	Approx. 8 hours with WRT-822A Approx. 6 hours with WRT-822B	Approx. 2.5 hours at 250 mW output Approx. 4 hours at 50 mW output
Channel setting back-up	●	●	●
Supplied accessories	Soft case (1), Spare battery case (1), Microphone cable (SMC9-4P to XLR 3-pin) (1), Operating instructions (1)	Leatherette case (1), Operating instructions (1)	Soft case (1), Operating instructions (1)

*When not supplying power to the microphone

Portable Tuners

	WRR-862A WRR-862B	WRR-855S WRR-855A/855B	WRR-861A WRR-861B
UHF PLL synthesized system	●	●	●
Operating frequency band	24 MHz band (WRR-862B, USA type) 14 MHz band (WRR-862A, AU type)	24 MHz band (WRR-855S/855B, USA type) 14 MHz band (WRR-855S/855A, AU type)	24 MHz band (WRU-861B, USA type) 14 MHz band (WRU-861A, AU type)
Space diversity reception system	●	●	●
Pre-programmed frequency groups	●	●	●
Advanced filtering (SAW filters)	●	●	●
Tone squelch circuitry	●	●	●
Componder system (expander)	●	●	●
RF squelch levels	5 dBμ, 10 dBμ, 15 dBμ or OFF	10 dBμ or OFF	5 dBμ, 10 dBμ, 15 dBμ or OFF
LCD panel	Channel number, Frequency in MHz, RF input level, Audio output status, Tuner battery reserve, Accumulated operating time	Channel number, RF input level (WRR-855S only), Audio output status (WRR-855S only)	Channel number, Frequency in MHz, RF input level, Audio output status, Tuner battery reserve, Accumulated operating time
LED indicators	RF input level, Diversity reception status, Transmitter battery alarm	RF input level, Audio output status, Transmitter battery alarm (WRR-855S only)	RF input level, Diversity reception status, Transmitter battery alarm
Remote battery alarm of transmitters	●	● (WRR-855S only)	●
Audio output connectors	Sony 4-pin (SMC9-4S)	D-sub 15-pin	Sony 4-pin (SMC9-4S)
Battery life	Approx. 5 hours	—*	Approx. 8 hours
Channel setting back-up	●	●	●
Supplied accessories	Attachment case (1), Mounting plate for use with optional A-8278-057-B Mounting bracket (1), Antennas (1 pair), Output cable (SMC9-4S to XLR 3-pin) (2), DC cable (1), Operating instructions (1)	Antennas (1 pair), Operating instructions (1)	Attachment case (1), Mounting plate for use with optional A-8278-057-B Mounting bracket (1), Antennas (1 pair), Output cable (SMC9-4S to XLR 3-pin) (1), DC cable (1), Operating instructions (1)

*The WRR-855S/855A/855B receive power from a camcorder via the D-sub 15-pin connector.

Tuners

	MB-8N with WRU-8N	MB-806A/X6 with WRU-806A/WRU-806B
UHF PLL synthesized system	●	●
Operating frequency band	24 MHz band (USA type) 14 MHz band (AU type)	24 MHz band (WRU-806B, USA type) 14 MHz band (WRU-806A, AU type)
Space diversity reception system	●	●
Pre-programmed frequency groups	●	●
Advanced filtering (SAW filters)	●	●
Tone squelch circuitry	●	●
Componder system (expander)	●	●
RF squelch levels	10 dBμ, 20 dBμ, 30 dBμ or OFF	30 dBμ
LCD panel	MB-8N: Menu for parameter setup WRU-8N: Channel number, Frequency in MHz, RF input level, Audio output status,	WRU-806A/806B: Channel number, Frequency in MHz, RF input level, Audio output status, Transmitter battery reserve
LED indicators	WRU-8N: Diversity reception status, Audio output status, Transmitter battery alarm	WRU-806A/806B: RF input status, Audio output status, Transmitter battery alarm
Remote battery alarm of transmitters	●	●
Audio output connectors	XLR 3-pin type (main) and D-sub 15-pin, female (sub)	XLR 3-pin type
Computer-based control	●	—
Channel setting back-up	●	●
Supplied accessories	MB-8N: AC power cord (1), CD-ROM containing operating instructions and MB-8N supplied software (1) WRU-8N: —	MB-806A/X6: AC power cord (1), Antennas (1 pair), Operating instructions (1) WRU-806A/806B: —

Specifications

Handheld Microphones

	WRT-847A/847B	WRT-867A*	WRT-807A/807B
Carrier frequency range	566 MHz to 590 MHz (U30/32) 638 MHz to 662 MHz (U42/44) 758 MHz to 782 MHz (U62/64) 782 MHz to 806 MHz (U66/68) 792 MHz to 806 MHz (AU66)	794 MHz to 806 MHz (U68) 792 MHz to 806 MHz (AU66)	566 MHz to 590 MHz (U30/32) 638 MHz to 662 MHz (U42/44) 758 MHz to 782 MHz (U62/64) 782 MHz to 806 MHz (U66/68) 792 MHz to 806 MHz (AU66)
Oscillator	Crystal controlled PLL synthesizer	Crystal controlled PLL synthesizer	Crystal controlled PLL synthesizer
Type of emission	F3E	F3E	F3E
RF power output	10 mW/50 mW selectable (50 Ω load)	10 mW (50 Ω load)	10 mW (50 Ω load)
Antenna	1/4 wave length wire antenna	Helical antenna	1/4 wave length wire antenna
Reference deviation	±5 kHz (94 dB SPL, 1 kHz)	±5 kHz (94 dB SPL, 1 kHz)	±5 kHz (94 dB SPL, 1 kHz)
Frequency response	50 Hz to 18 kHz (typical)	40 Hz to 20 kHz (typical)	50 Hz to 15 kHz (typical)
Signal-to-noise ratio	60 dB or more (A-weighted, at reference deviation)	60 dB or more (A-weighted, at reference deviation)	60 dB or more (A-weighted, at reference deviation)
Audio attenuator adjustment range (pad)	-12 dB to +9 dB variable in 3 dB steps	0, 6 dB or 12 dB switchable	0 to 21 dB, variable in 3 dB steps
Max. input sound pressure level	142 dB SPL (with CU-F780/G780/E700/F117 at audio gain -12 dB) 120 dB SPL (with CU-E672)	142 dB SPL (with 12 dB attenuator)	151 dB SPL (with 21 dB attenuator)
Microphone capsule	Interchangeable (Optional)	Dynamic	Dynamic
Directivity	—	Uni-directional	Uni-directional
Operating voltage	DC 3.0 V (two LR6 AA-size alkaline batteries)	DC 1.5 V (one LR6 AA-size alkaline battery)	DC 1.5 V (one LR6 AA-size alkaline battery)
Battery life (at 77 °F (25 °C), with Sony LR6 AA-size alkaline batteries)	Approx. 8 hours	Approx. 4 hours	Approx. 5 hours
Dimensions	1 1/2 x 6 inches (ø 37 x 150 mm)	2 1/8 x 7 3/4 inches (ø 51 x 195 mm)	2 1/8 x 9 3/8 inches (ø 51 x 238 mm)
Weight	Approx. 6.7 oz (190 g) including batteries	Approx. 11.5 oz (325 g) including battery	Approx. 15.5 oz (440 g) including battery
Supplied accessories	Microphone holder (1), Stand adapter (1), Channel color seal (1), Softcase (1), Operating instructions (1)	Microphone holder (1), Stand adapter (1), Channel color seal (1), Operating instructions (1)	Microphone holder (1), Metal-screw stand adapter (1), Operating instructions (1)

*WRT-867A AU model is not available in Australia.

Bodypack/Plug-on Transmitters

	WRT-8B	WRT-822A/822B	WRT-8P
Carrier frequency range	566 MHz to 590 MHz (U30/32) 638 MHz to 662 MHz (U42/44) 758 MHz to 782 MHz (U62/64) 782 MHz to 806 MHz (U66/68) 792 MHz to 806 MHz (AU66)	566 MHz to 590 MHz (U30/32) 638 MHz to 662 MHz (U42/44) 758 MHz to 782 MHz (U62/64) 782 MHz to 806 MHz (U66/68) 792 MHz to 806 MHz (AU66)	566 MHz to 590 MHz (U30/32) 638 MHz to 662 MHz (U42/44) 758 MHz to 782 MHz (U62/64) 782 MHz to 806 MHz (U66/68)
Oscillator	Crystal controlled PLL synthesizer	Crystal controlled PLL synthesizer	Crystal controlled PLL synthesizer
Type of emission	F3E	F3E	F3E
RF power output	10 mW or 50 mW (e.r.p.) selectable	10 mW (AU-type) (50 Ω load) 20 mW (USA-type) (50 Ω load)	250 mW or 50 mW selectable
Antenna	1/4 wave length wire antenna (SMA-J type connector)	1/4 wave length wire antenna	Integrated type
Reference deviation	±5 kHz (-60 dBV, 1 kHz input, MIC position) ±5 kHz (-20 dBu, 1 kHz input, LINE position)	±5 kHz (-60 dBV, 1 kHz input)	±10 kHz (-60 dBV, 1 kHz input, MIC position) ±10 kHz (-18 dBu, 1 kHz input, LINE position)
Frequency response	40 Hz to 20 kHz (typical)	70 Hz to 15 kHz (typical)	50 Hz to 18 kHz (typical)
Signal-to-noise ratio	60 dB or more (A-weighted, at reference deviation)	60 dB (A-weighted, at reference deviation)	60 dB or more (A-weighted, at reference deviation)
Audio attenuator adjustment range (pad)	0 to 40 dB, continuous	0 to 21 dB, variable in 3 dB step	0 dB to 20 dB, continuous
Max. input level	-2 dBV (1 kHz input, MIC position) +38 dBu (1 kHz input, LINE position)	-3 dBV (with 21 dB attenuator)	-20 dBV (1 kHz input, MIC position, ATT=0 dB) +22 dBu (1 kHz input, LINE position, ATT=0 dB)
Input connectors	Sony 4-pin (SMC9-4S) (1)	Sony 4-pin (SMC9-4S) (1)	XLR type 3-pin, female
Operating voltage	DC 3.0 V (two LR6 AA-size alkaline batteries)	DC 3.0 V (two LR6 AA-size alkaline batteries)	DC 9.0 V (one 6LR61 alkaline battery)
Battery life (at 77 °F (25 °C), with Sony LR6 AA-size alkaline batteries)*	Approx. 6 hours at 50 mW output Approx. 13 hours at 10 mW output	Approx. 8 hours (AU-type) Approx. 6 hours (USA-type)	Approx. 2.5 hours at 250 mW output Approx. 4 hours at 50 mW output
Dimensions (W x H x D)	2 1/2 x 3 3/8 x 1 1/16 inches (63 x 83 x 17 mm)	2 1/2 x 4 1/8 x 1 1/16 inches (63 x 103.17 mm)	1 3/4 x 4 1/4 x 1 3/4 inches (44 x 106 x 44 mm)
Weight	Approx. 4.9 oz (140 g) including batteries	Approx. 5.1 oz (145 g) including batteries	Approx. 8.1 oz (230 g) including battery
Supplied accessories	Soft case (1), Spare battery case (1), Microphone cable (1), Operating instructions (1)	Leatherette case (1), Operating instructions (1)	Soft case (1), Operating instructions (1)

*When not supplying power to the microphone

Portable Tuners

	WRR-862A/862B	WRR-855S/855A/855B	WRR-861A/861B
Receiving channels	2 channels	1 channel	1 channel
Receiving frequency range	2 frequencies within 566 MHz to 590 MHz (U30/32) 2 frequencies within 638 MHz to 662 MHz (U42/44) 2 frequencies within 758 MHz to 782 MHz (U62/64) 2 frequencies within 782 MHz to 806 MHz (U66/68) 2 frequencies within 792 MHz to 806 MHz (AU66)	566 MHz to 590 MHz (U30/32) 638 MHz to 662 MHz (U42/44) 758 MHz to 782 MHz (U62/64) 782 MHz to 806 MHz (U66/68) 792 MHz to 806 MHz (AU66)	566 MHz to 590 MHz (U30/32) 638 MHz to 662 MHz (U42/44) 758 MHz to 782 MHz (U62/64) 782 MHz to 806 MHz (U66/68) 792 MHz to 806 MHz (AU66)
Local oscillators	1st: PLL synthesizer, 2nd: Crystal oscillator	1st: PLL synthesizer, 2nd: PLL synthesizer (WRR-855S), Crystal oscillator (WRR-855A/855B)	1st: PLL synthesizer, 2nd: Crystal oscillator
De-emphasis	50 μ s	50 μ s	50 μ s
Reference deviation	± 5 kHz deviation at 1 kHz modulation (Maximum deviation: ± 40 kHz deviation at 1 kHz modulation)	± 5 kHz deviation at 1 kHz modulation (Maximum deviation: ± 40 kHz deviation at 1 kHz modulation)	± 5 kHz deviation at 1 kHz modulation (Maximum deviation: ± 40 kHz deviation at 1 kHz modulation)
Selectivity	60 dB or more at ± 250 kHz	60 dB or more at ± 250 kHz	60 dB or more at ± 250 kHz
Spurious rejection	70 dB or more	80 dB or more	70 dB or more
Frequency range	40 Hz to 18 kHz (typical)	40 Hz to 18 kHz (typical)	40 Hz to 18 kHz (typical)
Signal-to-noise ratio	60 dB or more (65 dB typical) at 60 dB μ RF input at reference deviation, A-weighted	60 dB or more at 60 dB μ RF input at reference deviation, A-weighted	60 dB or more (65 dB typical) at 60 dB μ RF input at reference deviation, A-weighted
RF muting (squelch) level	5 dB μ , 10 dB μ , 15 dB μ or OFF	10 dB μ or OFF	5 dB μ , 10 dB μ , 15 dB μ or OFF
Audio output level	-58 dBm at reference deviation	-40 dB μ at reference deviation	-58 dBm at reference deviation
Audio output connector	SMC9-4S (Sony 4-pin) (2), balanced	D-sub 15-pin (1), unbalanced	SMC9-4S (Sony 4-pin) (1), balanced
Antenna connector	BNC-R type (2), 50 Ω (nominal)	BNC-R type (2), 50 Ω (nominal)	BNC-R type (2), 50 Ω (nominal)
Monitor output connector	3.5 mm dia. mini jack, 1, 5 mW (1) Tuner 1/2/Mixed selectable	—	3.5 mm dia. stereo mini jack, 1, 5 mW (1)
Operating voltage	Batteries: DC 6 V (four LR6 AA-size alkaline batteries) External: DC 12 V	External: DC 7 V	Batteries: DC 6 V (four LR6 AA-size alkaline batteries) External: DC 12 V
Battery life (at 25 °C (77 °F), with Sony LR6 AA-size alkaline batteries)	Approx. 5 hours	—	Approx. 8 hours
Current (power) consumption	Batteries: approx. 230 mA at DC 6 V External: approx. 135 mA at DC 12 V	200 mA or less at external DC 7 V	Batteries: approx. 140 mA at DC 6 V External: approx. 85 mA at DC 12 V
Dimensions (W x H x D)	3 5/8 x 4 3/4 x 1 3/16 inches (89.0 x 120.0 x 29.5 mm)	3 1/2 x 4 3/4 x 1 1/4 inches (88.0 x 119.0 x 31.3 mm)	3 5/8 x 4 3/4 x 1 3/16 inches (89.0 x 120.0 x 29.5 mm)
Weight	Approx. 14.1 oz (400 g) including batteries	Approx. 10.0 oz (280 g)	Approx. 14.1 oz (400 g) including batteries
Supplied accessories	Attachment case (1), Mounting plate for use with optional A-8278-057-B mounting bracket (1), Antennas (1 pair), Output cables (2), DC cable (1), Operating instructions (1)	Antennas (1 pair), Operating instructions (1)	Attachment case (1), Mounting plate for use with optional A-8278-057-B mounting bracket (1), Antennas (1 pair), output cable (1), DC cable (1), Operating instructions (1)

Tuners

	WRU-8N	WRU-806A/806B
Receiving channels	1 channel	1 channel
Receiving frequency range	566 MHz to 590 MHz (U30/32) 638 MHz to 662 MHz (U42/44) 758 MHz to 782 MHz (U62/64) 782 MHz to 806 MHz (U66/68) 792 MHz to 806 MHz (AU66)	566 MHz to 590 MHz (U30/32) 638 MHz to 662 MHz (U42/44) 758 MHz to 782 MHz (U62/64) 782 MHz to 806 MHz (U66/68) 792 MHz to 806 MHz (AU66)
Local oscillators	PLL synthesizer	1st: PLL synthesizer, 2nd: Crystal oscillator
De-emphasis	50 μ s	50 μ s
Reference deviation	± 5 kHz deviation at 1 kHz modulation (Maximum deviation: ± 40 kHz deviation at 1 kHz modulation)	± 5 kHz deviation at 1 kHz modulation (Maximum deviation: ± 40 kHz deviation at 1 kHz modulation)
Selectivity	60 dB or more at ± 250 kHz	60 dB or more at ± 250 kHz
Frequency range	40 Hz to 20 kHz (typical)	70 Hz to 18 kHz (typical)
Signal-to-noise ratio	60 dB or more (65 dB typical) at 60 dB μ RF input at reference deviation, A-weighted	60 dB or more at 60 dB μ RF input at reference deviation, A-weighted
RF muting (squelch) level	10 dB μ , 20 dB μ , 30 dB μ or off	30 dB μ
Operating voltage	DC 5 V (supplied from MB-8N)	DC 9 V (supplied from MB-806A)
Current (power) consumption	260 mA or less	225 mA or less
Dimensions (W x H x D)	2 1/4 x 1 1/4 x 5 7/8 inches (56.0 x 30.7 x 149.0 mm)	2 1/4 x 1 1/16 x 4 7/8 inches (57 x 26 x 122 mm)
Weight	Approx. 5.8 oz (165 g)	Approx. 5.7 oz (160 g)
Supplied accessories	—	Operating instructions (1)

Specifications

0 dB SPL = 20 μ Pa
 0 dBV = 1 Vrms
 1 dBu = 0.775 Vrms
 1 dB μ = 1 μ V_{EMF}

Tuner Base Units

	MB-8N*	MB-806A	MB-X6
Receiving channels	4 channels when accommodating 4 WRU-8N tuner modules	6 channels when accommodating 6 WRU-806A/806B tuner modules	6 channels when accommodating 6 WRU-806A/806B tuner modules
Receiving frequency range	566 MHz to 806 MHz (USA type) 758 MHz to 862 MHz (AU type)	758 MHz to 806 MHz (USA type) 758 MHz to 862 MHz (AU type)	566 MHz to 806 MHz (USA type) 758 MHz to 862 MHz (AU type)
Audio output level	-20 dBm (LINE)/-58 dBm (MIC) at reference deviation	-20 dBm (LINE)/-58 dBm (MIC) at reference deviation	-20 dBu (LINE)/-58 dBu (MIC) at reference deviation
Audio output connector	XLR-3-32 type (4), balanced D-sub 15-pin (1) for sub output, female, unbalanced	XLR-3-32 (7), balanced	XLR-3-32 (7), balanced
Antenna attenuator level	0 dB, 5 dB, 10 dB or 15 dB	0 dB or 10 dB	0 dB or 10 dB
Antenna connector	Inputs: BNC-R type (x 2), 50 Ω (nominal) Outputs (for cascade connection): BNC-R type (2), 50 Ω (nominal)	Inputs: BNC-R type (2), 50 Ω (nominal)	Inputs: BNC-R type (2), 50 Ω (nominal)
Monitor output level	5 mW or more (24 to 45 Ω load)	—	—
Monitor output connector	6.3 mm dia, stereo mini jack (1)	—	—
Network connector	RJ-45 (1), 10BASE-T	—	—
Operating voltage	AC 120 V, 60 Hz (USA-type) AC 100 to 240 V, 50/60 Hz (AU-type)	AC 120 V, 60 Hz (USA-type) AC 220 to 240 V, 50/60 Hz (AU-type)	AC 120 V, 60 Hz (USA-type) AC 230 V, 50/60 Hz (AU-type)
Current (power) consumption	50 W when accommodating four WRU-8N tuner modules	30 W when accommodating six WRU-806A/806B tuner modules	30 W when accommodating six WRU-806A/806B tuner modules
Dimensions (W x H x D)	19 x 1 3/4 x 11 7/8 inches (482 x 44 x 300 mm)	19 x 1 3/4 x 11 7/8 inches (482 x 44 x 300 mm)	19 x 1 3/4 x 11 1/4 inches (482 x 44 x 285 mm)
Weight	Approx. 8 lb 6 oz (3.7 kg)	Approx. 7 lb 15 oz (3.6 kg)	Approx. 12 lb 2 oz (5.5 kg)
Supplied accessories	AC power cord (1), Antennas (1 pair), CD-ROM (contains operating instructions and MB-8N supplied software) (1)	AC power cord (1), Antennas (1 pair), Operating instructions (1)	AC power cord (1), Antennas (1 pair), Operating instructions (1)

*Original MB-8N supports Channel 62-69 operation. Channel 30-69 operation requires new MB-8N F model.

Antenna Dividers

	WD-850A*	WD-880A
Frequency range	566 MHz to 806 MHz (USA type) 758 MHz to 862 MHz (AU type)	770 MHz to 806 MHz (USA type) 792 MHz to 806 MHz (AU type)
Channel distribution	Inputs: 2 pairs Outputs: 4 pairs	USA type: Inputs: 1 pair Outputs: 6 pairs (for 6 TV channels) AU type: Inputs: 2 pairs Outputs: 3 pairs
Input/output impedance	50 Ω	50 Ω
Cascade output	1 pair	USA type: 0 AU type: 1 pair
Power supply for antenna booster (supplied from antenna input connectors)	DC 9 V/OFF switchable	DC 12 V/9 V/OFF switchable
Power consumption	16 W	10 W
Dimensions (W x H x D)	19 x 1 3/4 x 11 7/8 inches (482 x 44 x 300 mm)	19 x 1 3/4 x 11 7/8 inches (482 x 44 x 300 mm)
Weight	Approx. 10 lb 2 oz (4.6 kg)	Approx. 8 lb 13 oz (4.0 kg)
Supplied accessories	50 Ω BNC terminators (6)	AC power cord (1)

*Original WD-850A supports Channel 62-69 operation. Channel 30-69 operation requires new WD-850A F model.

Antenna

	AN-820A
Frequency range	566 MHz to 662 MHz (USA type, L model) 770 MHz to 806 MHz (USA type) 758 MHz to 862 MHz (AU type)
Antenna gain	More than 10 dB
Output impedance	50 Ω
Voltage standing-wave ratio	Less than 3
Noise figure	Less than 6 dB
Third intermodulation	More than 60 dB (at 95 dB _E output)
Output connector	BNC-R type
Supply voltage	DC 9 V
Current consumption	Less than 35 mA
Dimensions (W x H x D)	2 7/8 x 4 5/8 x 5 1/4 inches (70 x 117 x 132 mm)
Weight	Approx. 9 oz (250 g)
Supplied accessories	Attachment A (1), Attachment B (1), Microphone stand screw (1), Microphone stand screw adapter (PF 1/2 to NS 5/8) (1), Fixing screws (1 set)

Appendix

Multi-channel Simultaneous Operations

Tuner and Camcorder Combinations

Attaching to Camcorders

Multi-channel Simultaneous Operations

The Sony wireless microphone system allows a wide variety of multi-channel systems to be flexibly configured to meet individual requirements.

The number of channels that can be simultaneously operated using One Version of B-series (USA-type) Products (without use of a WD-880A) is as follows;

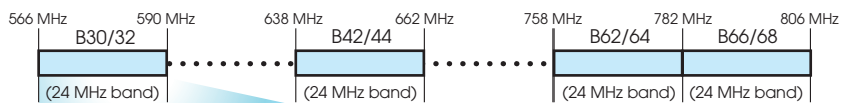

When all four TV channels are available, up to 16-channel simultaneous operation is possible.

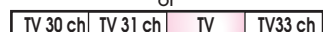
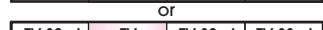
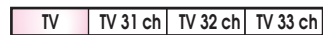

When three of four TV channels are available, up to 14-channel simultaneous operation is possible.



When either the even or the odd TV channels are available, up to 11-channel simultaneous operation is possible.

The number of channels that can be simultaneously operated using the B30/32 and B62/64 Combination (without use of a WD-880A) is as follows;

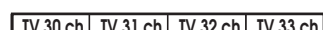

16-channel

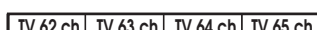

16-channel

When all eight TV channels are available; up to 32-channel simultaneous operation is possible.

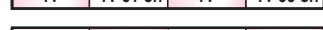

11-channel

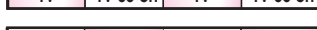

11-channel

When either all even or all odd TV channels are available; up to 22-channel simultaneous operation is possible.

The number of channels that can be simultaneously operated using the B62/64 and B66/68 Combination (without use of a WD-880A) is as follows;



When all eight TV channels are available, up to 22-channel simultaneous operation is possible.

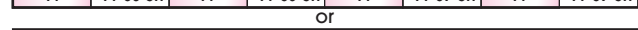

When either all even or all odd TV channels are available, up to 16-channel simultaneous operation is possible.

The number of channels that can be simultaneously operated using the B30/32, B42/44 and B62/64 Combination (without use of a WD-880A) is as follows;



16-channel



16-channel



16-channel

When all 12 TV channels are available; up to 48-channel simultaneous operation is possible.

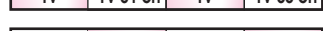
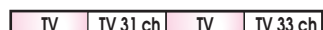

11-channel

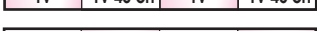

11-channel

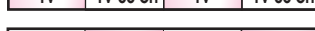

11-channel

When either all even or all odd TV channels are available; up to 33-channel simultaneous operation is possible.

The number of channels that can be simultaneously operated using the All B-series Combination (without use of a WD-880A) is as follows;

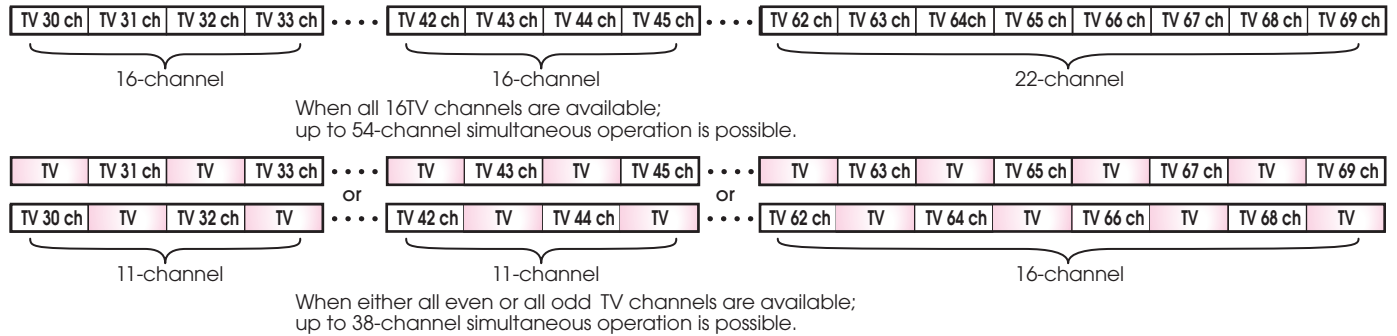

The number of channels that can be simultaneously operated using One Version of A-series (USA-type) Products (without use of a WD-880A) is as follows;

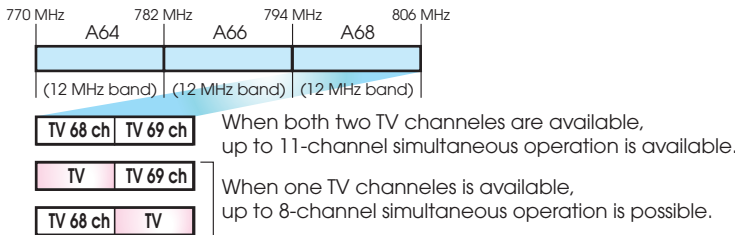

The number of channels that can be simultaneously operated using Two of the Three A-series (USA-type) Products (without use of a WD-880A) is as follows;

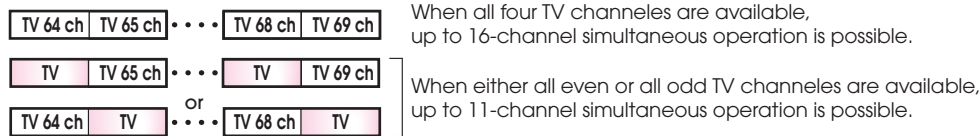



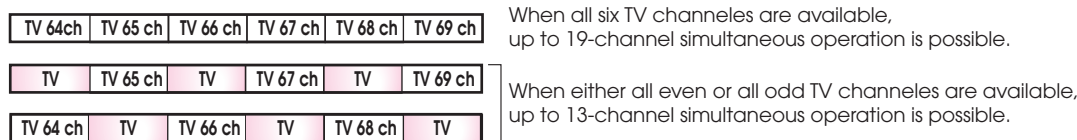

The number of channels that can be simultaneously operated using All USA-Type A64/A66/A68 Combination (without use of a WD-880A) is as follows;

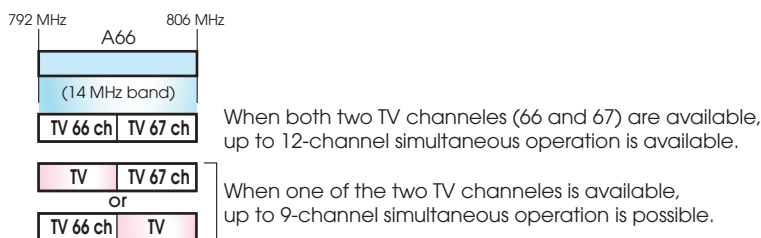





























The number of channels that can be simultaneously operated using the AU Products (without use of a WD-880A) is as follows;





























Tuner and Camcorder Combinations

	HDCAM		Digital Betacam	XDCAM	
	HDW-F900R HDW-790/790P 	HDW-730S 	DVW-970/970P 	PDW-530/530P PDW-510/510P 	
Camcorder Interfaces for Audio	Built-in Wireless Slot	Yes	Yes	Yes	Yes
	DC Output	Yes	Yes	Yes	Yes
	Audio Input	XLR 3-pin (x2)	XLR 3-pin (x2)	XLR 3-pin (x2)	XLR 3-pin (x2)
	Mic Input	XLR 5-pin (x1)	XLR 3-pin (x1)	XLR 3-pin (x1)	XLR 3-pin (x1)

Required Components

Applicable Wireless Tuners	WRR-855S/855A/855B (1ch) Slot-in 	No mounting accessories needed	No mounting accessories needed	No mounting accessories needed	No mounting accessories needed
	Rear Mount 	  BTA-801 Wireless Adapter A-8278-057-B Mount Bracket	  BTA-801 Wireless Adapter A-8278-057-B Mount Bracket	  BTA-801 Wireless Adapter A-8278-057-B Mount Bracket	  BTA-801 Wireless Adapter A-8278-057-B Mount Bracket
	  DWA-01D Digital Wireless Adapter A-8278-057-B Mount Bracket	  DWA-01D Digital Wireless Adapter A-8278-057-B Mount Bracket	  DWA-01D Digital Wireless Adapter A-8278-057-B Mount Bracket	  DWA-01D Digital Wireless Adapter A-8278-057-B Mount Bracket	
	WRR-861A/861B (1ch) Rear Mount 	 A-8278-057-B Mount Bracket	 A-8278-057-B Mount Bracket	 A-8278-057-B Mount Bracket	 A-8278-057-B Mount Bracket
	WRR-862A/862B (2ch) Rear Mount 	 A-8278-057-B Mount Bracket	 A-8278-057-B Mount Bracket	 A-8278-057-B Mount Bracket	 A-8278-057-B Mount Bracket

	MPEG IMX	XDCAM HD	DVCAM	
	MSW-970/970P	PDW-F355/F350 PDW-F335/F330	DSR-400/400P DSR-450WS/450WSP	DSR-250/250P
				
	Yes	No	No	No
	Yes	Yes	Yes	Yes
	XLR 3-pin (x2)	XLR 3-pin (x2)	XLR 3-pin (x2)	XLR 3-pin (x2)
	XLR 3-pin (x1)	XLR 5-pin (x1)	XLR 3-pin (x1)	XLR 3-pin (x1)
	No mounting accessories needed	—	—	—
	 	 *	 *	 
	BTA-801 Wireless Adapter	CA-WR855 Mount Adapter	CA-WR855 Mount Adapter	BTA-801 Wireless Adapter
	 	 	 	 
	DWA-01D Digital Wireless Adapter	DWA-01D Digital Wireless Adapter	DWA-01D Digital Wireless Adapter	DWA-01D Digital Wireless Adapter
				
	A-8278-057-B Mount Bracket	A-8278-057-B Mount Bracket	A-8278-057-B Mount Bracket	A-8278-057-B Mount Bracket
				
	A-8278-057-B Mount Bracket	A-8278-057-B Mount Bracket	A-8278-057-B Mount Bracket	A-8278-057-B Mount Bracket

* When using a battery from a third-party manufacturer to operate the camcorder, the BTA-801 or DWA-01D adapter is recommended instead of the CA-WR855.

◆ HDCAM/Digital Betacam/XDCAM/MPEG IMX Camcorder with WRR-855

Slot-in Configuration

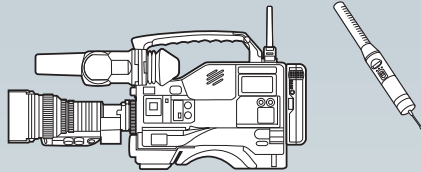

Required components

- WRR-855 Portable tuner x 1
- Transmitter x 1

Rear-mount Configuration

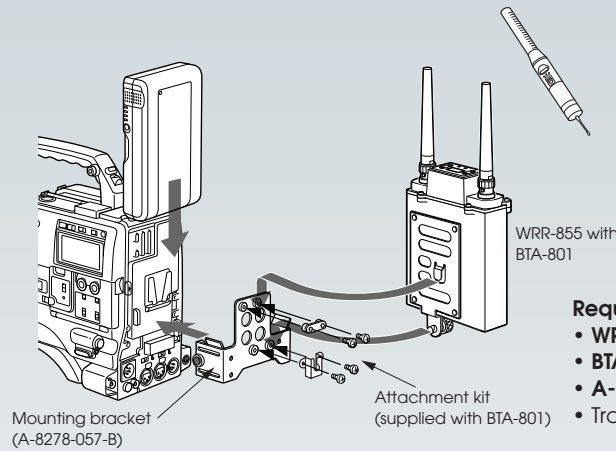

Required components

- WRR-855 Portable tuner x 1
- BTA-801 Wireless adapter x 1
- A-8278-057-B Mounting bracket x 1
- Transmitter x 1

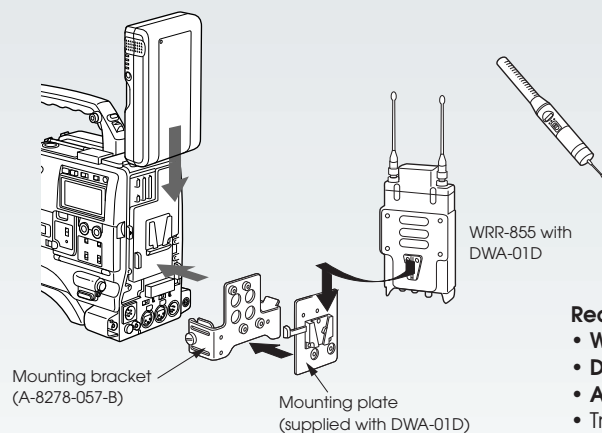

Required components

- WRR-855 Portable tuner x 1
- DWA-01D Wireless adapter x 1
- A-8278-057-B Mounting bracket x 1
- Transmitter x 1

◆ DVCAM/XDCAM HD Camcorder with WRR-855

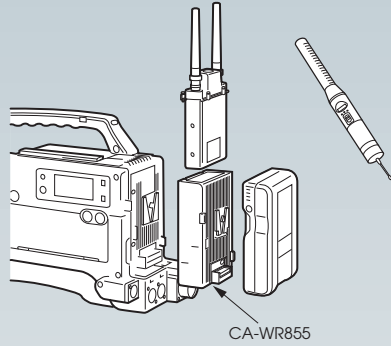

Required components

- WRR-855 Portable tuner x 1
- CA-WR855 Camera adapter x 1
- Transmitter x 1

◆ HDCAM/Digital Betacam/XDCAM/MPEG IMX Camcorder with WRR-862

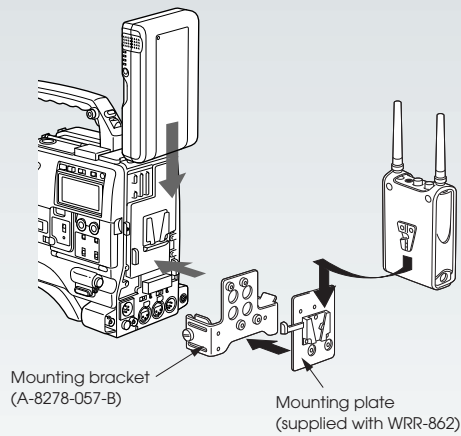

Required components

- WRR-862 Portable tuner x 1
- A-8278-057-B Mounting bracket x 1
- Transmitter x 2

SONY[®]

Sony Electronics Inc.
1 Sony Drive
Park Ridge, NJ 07656
www.sony.com/ProAudio

A-1079-D (MK10454V1)

©2008 Sony Electronics Inc. All rights reserved.
Reproduction in whole or in part without written permission is prohibited.
Features and specifications are subject to change without notice.
All non-metric weights and measurements are approximate.
Sony, Digital Betacam, DVCAM, HDCAM, MPEG IMX and XDCAM are trademarks of Sony.
Use of Sony wireless devices in the United States of America is regulated by
the Federal Communications Commission as described in Parts 15 and 74 of the
FCC regulations. Users authorized thereby are required to obtain an appropriate license.

Printed in USA (1/08)