



V12

TANNOY®



Product Description

A premium quality installation loudspeaker, the V12 combines high power handling, high efficiency and low distortion into a compact solution for class leading music and speech reproduction quality. The robust cabinet construction houses a high power 300mm (12.00") point source, constant directivity Dual Concentric™ drive unit. A drive unit which features a reinforced paper mid bass cone and double rolled cambric surround for high sensitivity, as well as a dual magnet assembly and a Tulip WaveGuide™ for the high frequency unit.

These two drivers are properly merged into one with the high frequency mounted in the throat of the mid bass; therefore coincidentally aligning both transducers to a point source delivering 90 degree conical dispersion. The result is a smooth and uniform frequency response over a wide coverage area; something unachievable with discrete, two-way designs where in the vertical plane massive cancellations appear off axis at the crossover frequency. This controlled conical dispersion ensures optimal coverage and forward gain, with the marked installation advantage of enabling either vertical or horizontal mounting without any compromise to sound quality.

Whether used for live sound reinforcement, high quality public address or large scale music reinforcement installations, the wide dispersion, even coverage pattern and high power handling means that the V12 excels in applications such as theme pubs and nightclubs, theatre front of house and effects, side fill in movie theatres and cinemas, class leading audio reproduction in houses of worship, theme parks, leisure venues, sports and multi-use stadiums.

Although designed to perform without any external controller, a Tannoy digital system controller will further enhance performance by equalising the system to improve bass performance; this as well as providing a 2-way crossover function to facilitate use with a separate subwoofer system.

Available in black or white, the rugged multi-ply birch cabinet has asymmetrical profile and convenient aspect ratio to allow installation in a variety of configurations. Supplied with a carrying handle, a blanking plate over a 35mm pole mount location, 8 x M10 bracket inserts for landscape or portrait mounting and 8 x M10 flying inserts. Tannoy's proprietary mounting hardware provides multiple options including wall mount, yoke, ceiling saddle, pole clamp, pole mount and eyebolts.

Features

- 300mm (12.00") point source Dual Concentric™ driver
- 90 degree controlled conical dispersion for optimum coverage and forward gain
- Compact and versatile enclosure
- High power handling
- High efficiency and low distortion
- Rugged birch plywood construction
- Convenient aspect ratio
- Integral carry handle
- Integral mounting and flying points
- Secure-ET™ mounting options
- Five year loudspeaker warranty

Applications

- Live sound reinforcement
- High quality public address
- Theme pubs and nightclubs
- Theatre front of house and effects
- Movie theatre and cinema
- Side fill in large-scale music reinforcement
- Theme parks and leisure venues
- Sports and multi-use stadiums
- House of worship

Tannoy United Kingdom
 Tannoy North America
 Tannoy Deutschland
 Tannoy France

T: 00 44 (0) 1236 420199
 T: 00 1 (519) 745 1158
 T: 00 49 (180) 1111 881
 T: 00 33 (0)1 7036 7473

E: enquiries@tannoy.com
 E: inquiries@tannoyna.com
 E: anfragen@tannoy.com
 E: ventes@tannoy.com

tannoy®.com



V12

TANNOY®

TECHNICAL SPECIFICATIONS

System V12

System Type	Full Range - vented
Frequency Response (-3dB) ⁽¹⁾	70Hz - 25kHz
Frequency Range (-10dB) ⁽¹⁾	55Hz - 38kHz
System Sensitivity (1W @1m) ⁽²⁾	97dB (1W = 2.83V for 8 Ohms)
Dispersion (-6dB)	90 degrees conical
Driver Complement	1 x 300mm (12.00") Dual Concentric™
Crossover	Passive 1.4kHz with dynamic HF protection
Directivity Factor (Q)	8.2 averaged 1kHz to 10kHz
Directivity Index (DI)	8.8 averaged 1kHz to 10kHz
Rated Maximum SPL ⁽²⁾	
Average	120dB
Peak	126dB
Power Handling	
Average	200W
Programme	400W
Peak	800W
Recommended Amplifier Power	400W @ 8 Ohms
Nominal Impedance	8 Ohms

Distortion

10% Full Power (12.65V)	2nd Harmonic	3rd Harmonic
250Hz	0.56%	0.23%
1kHz	2.36%	1.88%
10kHz	2.68%	0.08%
1% Full Power (4V)	2nd Harmonic	3rd Harmonic
250Hz	0.14%	0.14%
1kHz	0.38%	0.94%
10kHz	1.03%	0.05%

Construction

Enclosure	37.5 litre vented and internally braced 15mm (0.62") birch plywood enclosure with 15mm (0.62") MDF front baffle.
Finish	Textured black or white paint, with custom colours on request. Foam covered, powder coated perforated steel grille
Connectors	2 x Speakon NL4MP in/out
Fittings	Recessed rear mounted carrying handle Blanking plate allows installation of a 35mm pole-mounting socket 8 x M10 bracket inserts allowing for landscape or portrait mounting 8 x M10 flying inserts
Optional Accessories	Black or white power coated perforated steel grille
Dimensions	486 x 370 x 375mm (H x W x D) 19.13 x 14.57 x 14.76" (H x W x D)
Weight	20kg (44.0lbs)

Notes:

- (1) Average over stated bandwidth. Measured at 1 metre on axis.
(2) Unweighted pink noise input, measured at 1 metre in an anechoic chamber

A full range of measurements, performance data, CLF and Ease™ Data can be downloaded from www.tannoy.com

Full independent verification of published specifications carried out by NWAALabs, California can also be obtained from the downloads section of www.tannoy.com

Tannoy operates a policy of continuous research and development. The introduction of new materials or manufacturing methods will always equal or exceed the published specifications, which Tannoy reserves the right to alter without prior notice. Please verify the latest specifications when dealing with critical applications.

Ordering Information

PART NUMBER	MODEL NAME	COLOUR	PACKED QUANTITY
8001 2620	V12	Black	1
8001 2660	V12	White	1

Tannoy United Kingdom
Tannoy North America
Tannoy Deutschland
Tannoy France

T: 00 44 (0) 1236 420199
T: 00 1 (519) 745 1158
T: 00 49 (180) 1111 881
T: 00 33 (0)1 7036 7473

E: enquiries@tannoy.com
E: inquiries@tannoyna.com
E: anfragen@tannoy.com
E: ventes@tannoy.com

tannoy.com



V12

TANNOY®

PERFORMANCE MEASUREMENTS

1m on-axis frequency response

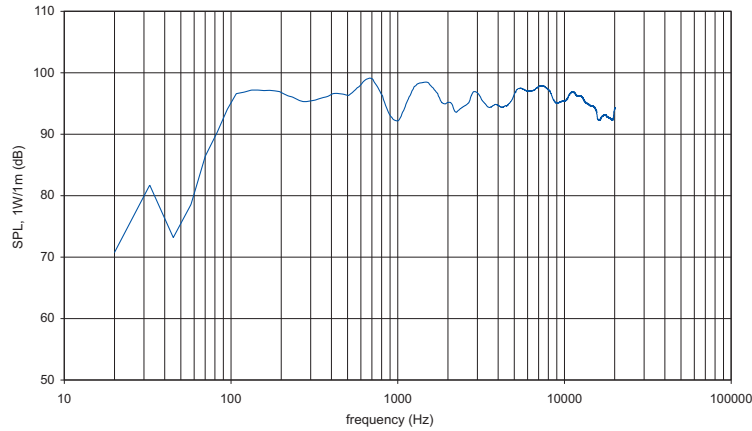

ANECHOIC
FREQUENCY
RESPONSE

Impedance vs frequency

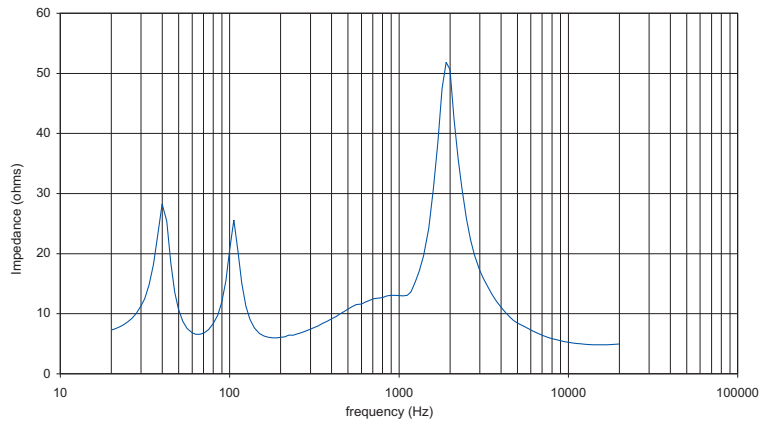

IMPEDANCE

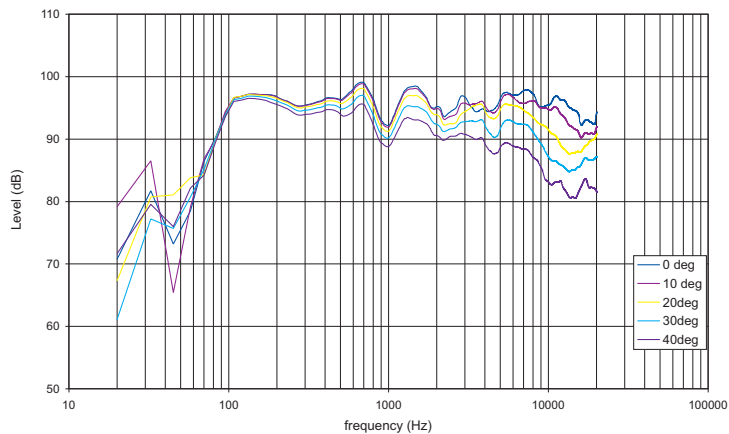

OFF AXIS
RESPONSE

Tannoy United Kingdom
 Tannoy North America
 Tannoy Deutschland
 Tannoy France

T: 00 44 (0) 1236 420199
 T: 00 1 (519) 745 1158
 T: 00 49 (180) 1111 881
 T: 00 33 (0)1 7036 7473

E: enquiries@tannoy.com
 E: inquiries@tannoyna.com
 E: anfragen@tannoy.com
 E: ventes@tannoy.com

tannoy®.com



V12

TANNOY®

PERFORMANCE MEASUREMENTS

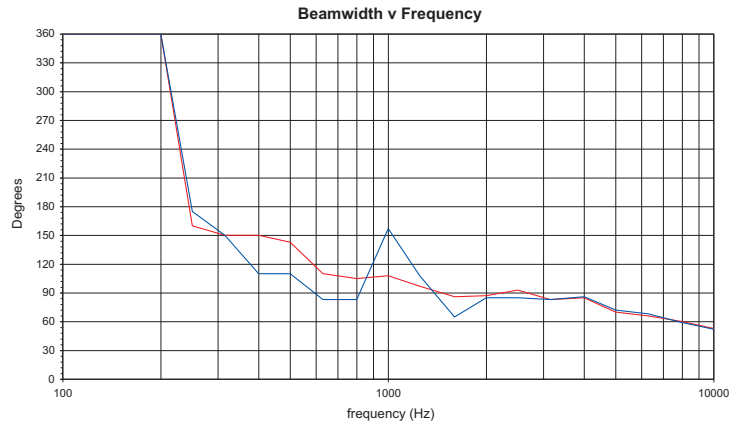

BEAMWIDTH

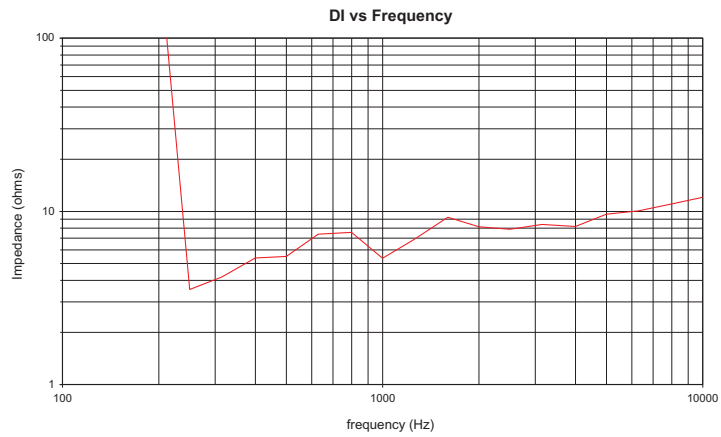

DIRECTIVITY INDEX

Tannoy United Kingdom
 Tannoy North America
 Tannoy Deutschland
 Tannoy France

T: 00 44 (0) 1236 420199
 T: 00 1 (519) 745 1158
 T: 00 49 (180) 1111 881
 T: 00 33 (0)1 7036 7473

E: enquiries@tannoy.com
 E: inquiries@tannoyna.com
 E: anfragen@tannoy.com
 E: ventes@tannoy.com

tannoy®.com



V12

TANNOY®

PERFORMANCE MEASUREMENTS POLAR PLOTS (1/3 OCTAVE)

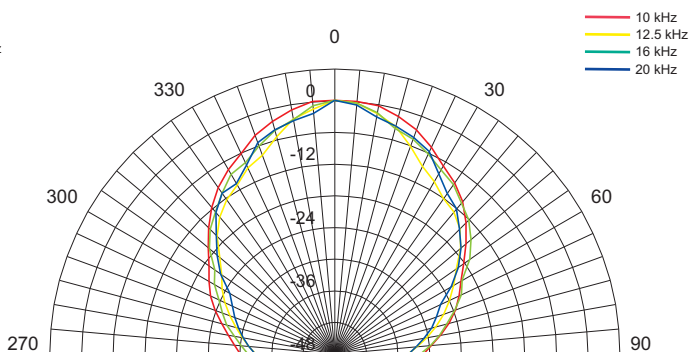
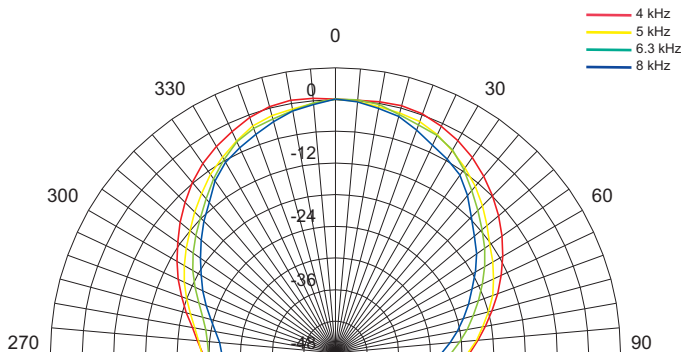
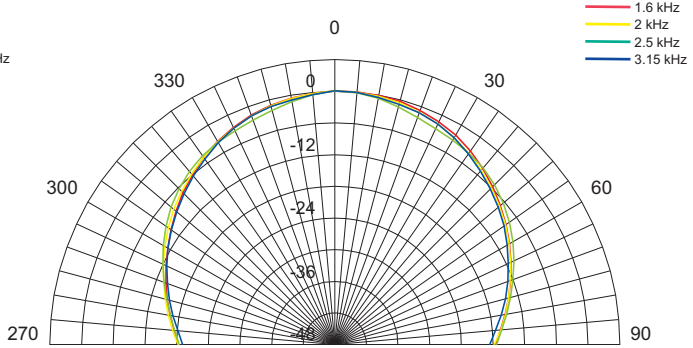
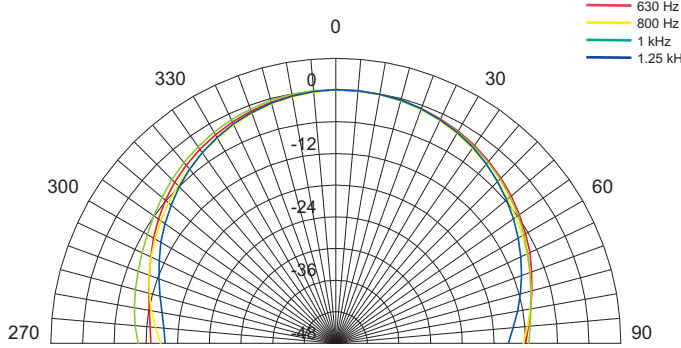
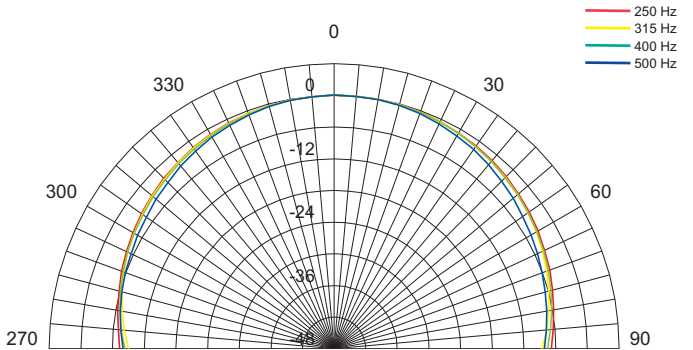
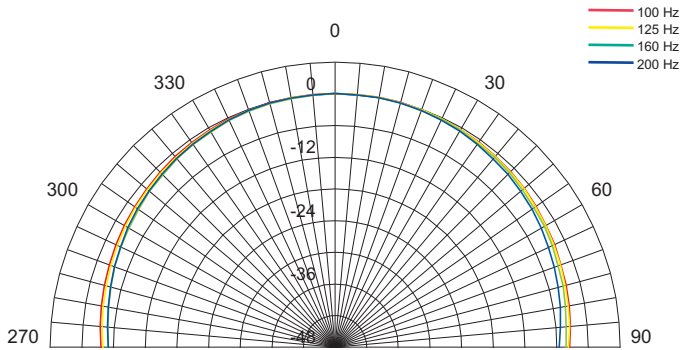

Tannoy United Kingdom
 Tannoy North America
 Tannoy Deutschland
 Tannoy France

T: 00 44 (0) 1236 420199
 T: 00 1 (519) 745 1158
 T: 00 49 (180) 1111 881
 T: 00 33 (0)1 7036 7473

E: enquiries@tannoy.com
 E: inquiries@tannoyna.com
 E: anfragen@tannoy.com
 E: ventes@tannoy.com

tannoy.com



V12

TANNOY®

PERFORMANCE MEASUREMENTS

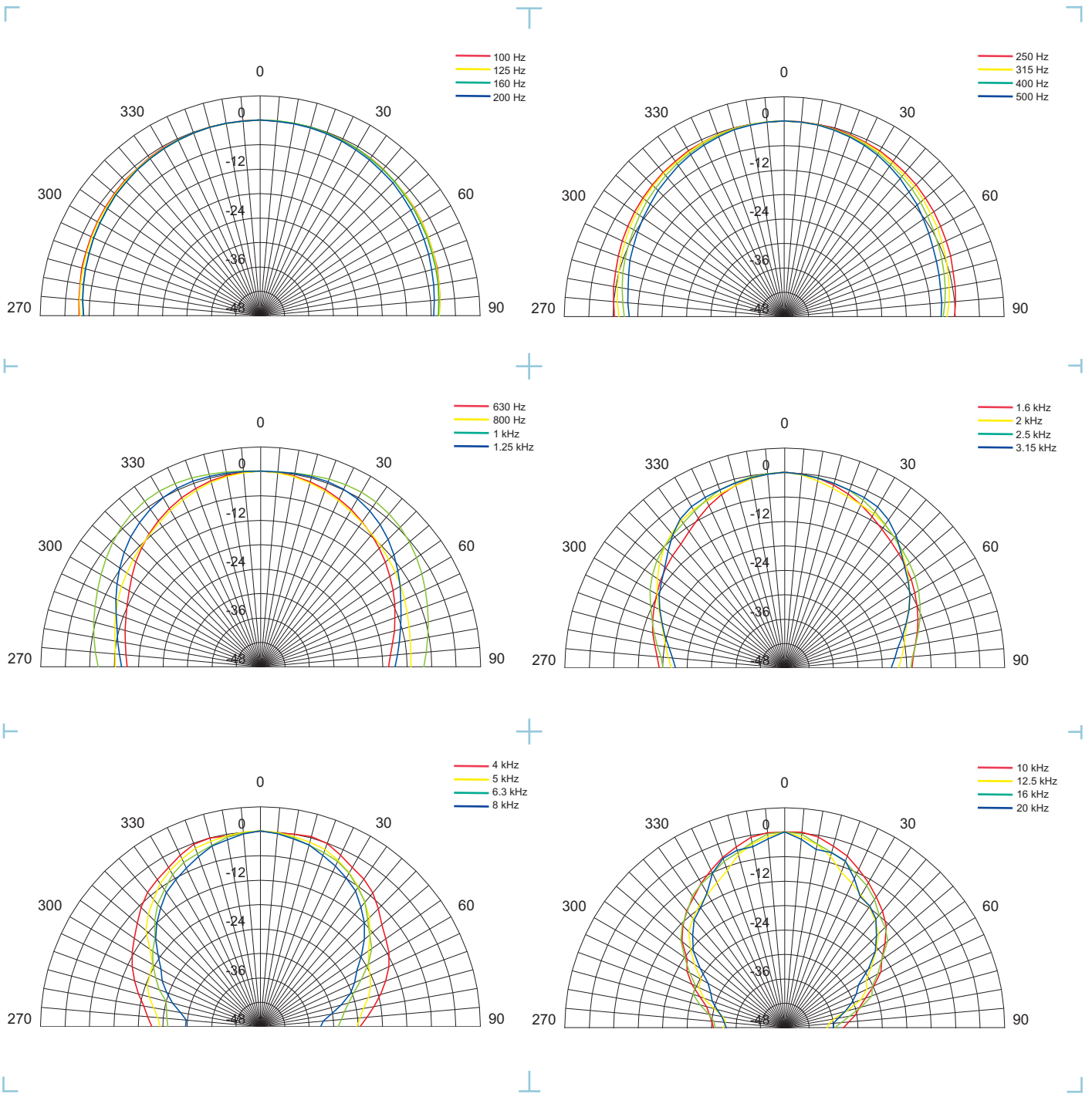

Tannoy United Kingdom
 Tannoy North America
 Tannoy Deutschland
 Tannoy France

T: 00 44 (0) 1236 420199
 T: 00 1 (519) 745 1158
 T: 00 49 (180) 1111 881
 T: 00 33 (0)1 7036 7473

E: enquiries@tannoy.com
 E: inquiries@tannoyna.com
 E: anfragen@tannoy.com
 E: ventes@tannoy.com

tannoy.com



V12

TANNOY®

DIMENSIONAL SKETCHES

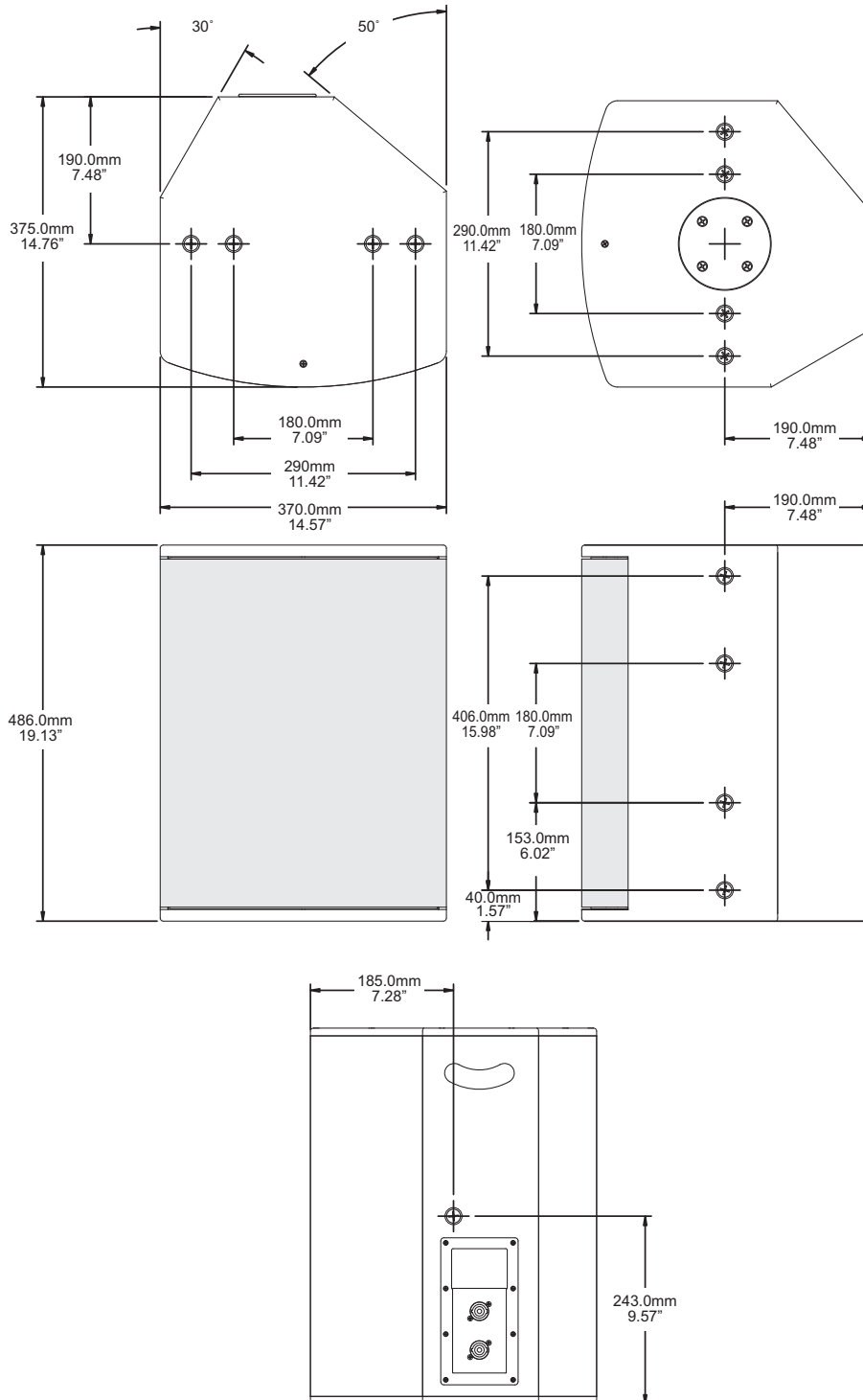

Tannoy United Kingdom
 Tannoy North America
 Tannoy Deutschland
 Tannoy France

T: 00 44 (0) 1236 420199
 T: 00 1 (519) 745 1158
 T: 00 49 (180) 1111 881
 T: 00 33 (0)1 7036 7473

E: enquiries@tannoy.com
 E: inquiries@tannoyna.com
 E: anfragen@tannoy.com
 E: ventes@tannoy.com

tannoy.com



V12

TANNOY®

MOUNTING OPTIONS & HARDWARE

V12Y Yoke

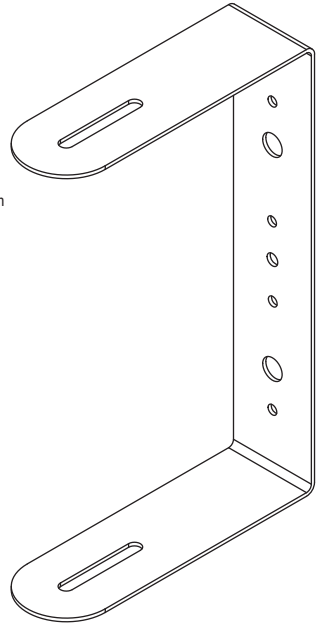
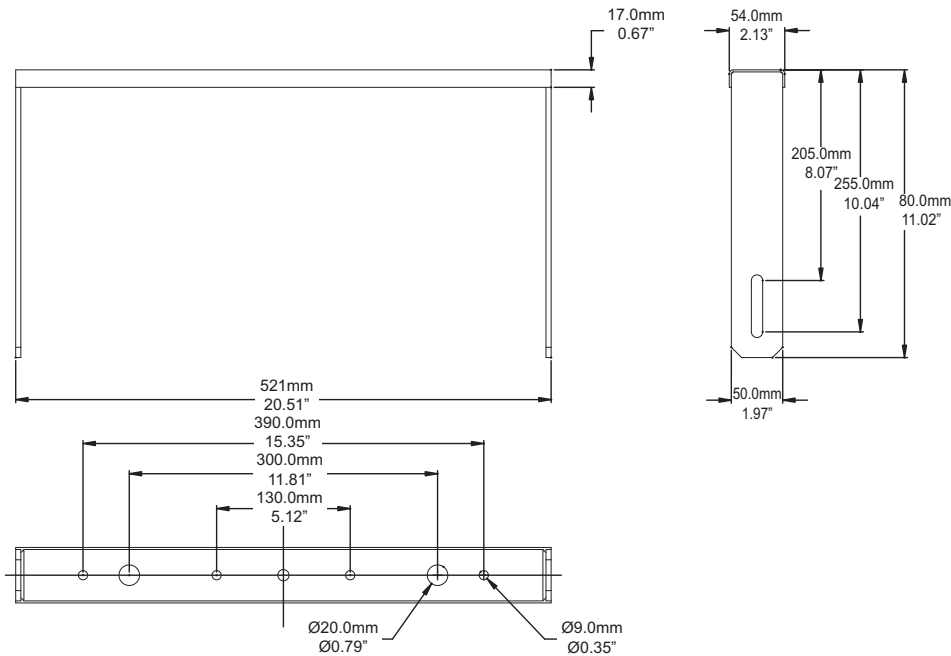

V8B Bracket

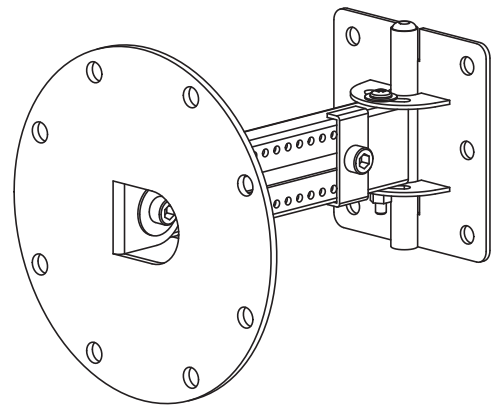
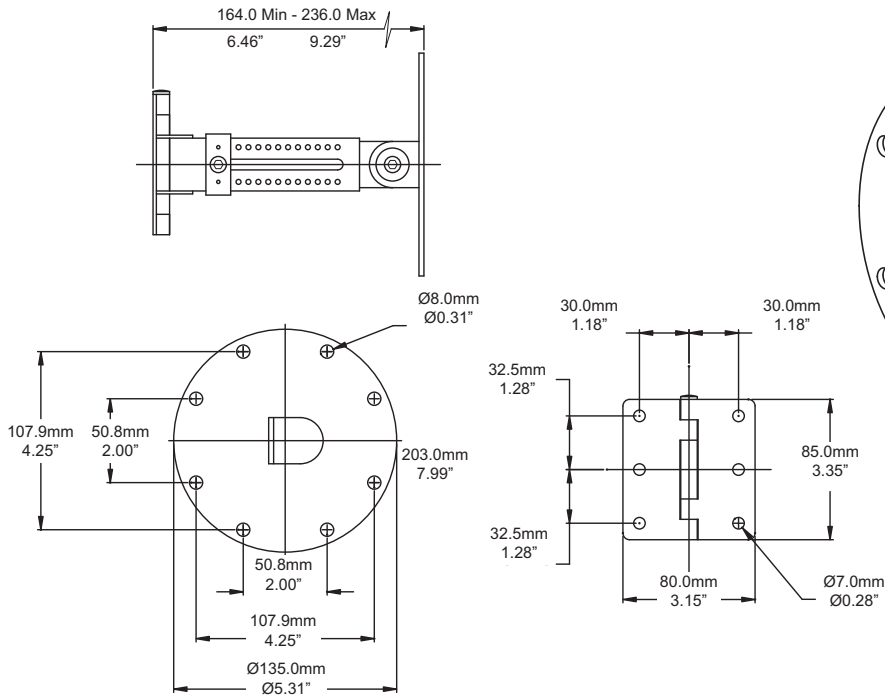

SPEAKER END OF MOUNTING BRACKET

WALL END OF MOUNTING BRACKET

Tannoy United Kingdom
 Tannoy North America
 Tannoy Deutschland
 Tannoy France

T: 00 44 (0) 1236 420199
 T: 00 1 (519) 745 1158
 T: 00 49 (180) 1111 881
 T: 00 33 (0)1 7036 7473

E: enquiries@tannoy.com
 E: inquiries@tannoyna.com
 E: anfragen@tannoy.com
 E: ventes@tannoy.com

tannoy.com



V12

TANNOY®

MOUNTING OPTIONS & HARDWARE

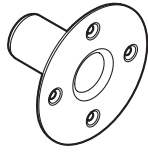

VTH

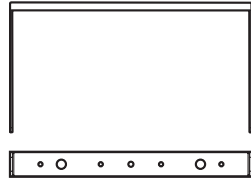

V12Y

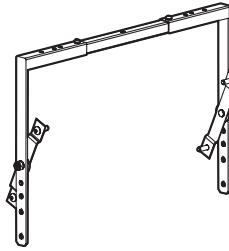

VMY

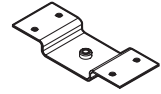

VCS

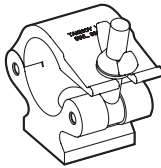

VPC

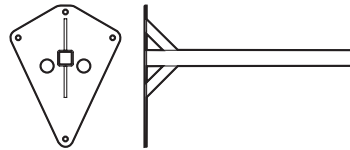

VMB

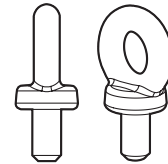

VEB

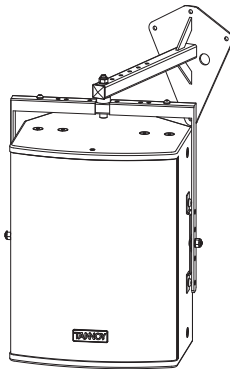

V12 - VMY - VMB

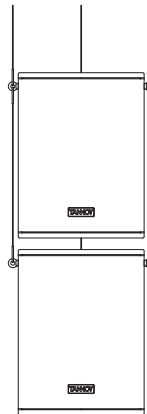

FLYING MOUNT VERTICAL

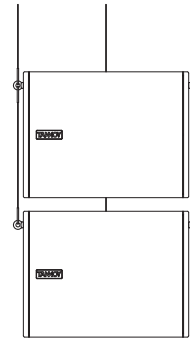

FLYING MOUNT HORIZONTAL

Ordering Information

PART NUMBER	MODEL NAME	COLOUR	PACKED QUANTITY
8001 3180	V12Y	Black	1
8001 3181	V12Y	White	1
8001 2780	VMY	Black	1
8001 2790	VMY	White	1
8001 2800	VMB	Black	1
8001 2810	VMB	White	1
8001 2820	VEB	-	1
8001 2830	VCS	Black	1
8001 2840	VCS	White	1
8001 2860	VTH	Black	1
8001 2870	VTH	White	1
8001 2850	VPC	-	1
8001 3280	Grille V12	Black	1
8001 3281	Grille V12	White	1

Tannoy United Kingdom
 Tannoy North America
 Tannoy Deutschland
 Tannoy France

T: 00 44 (0) 1236 420199
 T: 00 1 (519) 745 1158
 T: 00 49 (180) 1111 881
 T: 00 33 (0)1 7036 7473

E: enquiries@tannoy.com
 E: inquiries@tannoyna.com
 E: anfragen@tannoy.com
 E: ventes@tannoy.com

tannoy.com



V12

TANNOY®

Architectural specifications

The loudspeaker shall consist of a 300mm (12.00") full range, single point source Dual Concentric™ transducer. The low and the high frequency elements shall be combined by an internal passive crossover network operating at 1.4kHz, with 2nd order high pass, 2nd order low pass. A configurable switching arrangement on the input panel allows the user to select between full range passive or bi-amped two way powering modes.

Performance of the loudspeaker, without any electronic control shall meet or exceed the following criteria: frequency response measured at 1 metre on axis with swept sine wave shall be 70Hz - 25kHz (+/-3dB). Sensitivity shall be at least 97dB (anechoic) for 2.83 volts @ 1 metre and shall be capable of producing a peak output level of 126dB (anechoic) on axis at 1 metre. The dispersion of the loudspeaker shall be 90 degrees conical (-6dB).

The system shall have a nominal impedance of 8 Ohms, maximum power handling shall be 800 Watts (programme). The enclosure shall be an optimally tuned 37.5 litre vented enclosure of birch plywood construction. The enclosure shall be fitted with an integral carrying handle, blanked off recess for optional pole-mount socket installation, 8 x M10 bracket inserts for landscape or portrait mounting and 8 x M10 mounting points for flying hardware.

The enclosure shall not exceed the following dimensions): 486 x 370 x 375mm (19.13 x 14.57 x 14.76") (H x W x D)

The loudspeaker shall be the Tannoy...V12.

Tannoy United Kingdom
Tannoy North America
Tannoy Deutschland
Tannoy France

T: 00 44 (0) 1236 420199
T: 00 1 (519) 745 1158
T: 00 49 (180) 1111 881
T: 00 33 (0)1 7036 7473

E: enquiries@tannoy.com
E: inquiries@tannoyna.com
E: anfragen@tannoy.com
E: ventes@tannoy.com

tannoy®.com



V12

TANNOY®

NOTES

Grid area for notes

Horizontal lines for notes

Tannoy United Kingdom
Tannoy North America
Tannoy Deutschland
Tannoy France

T: 00 44 (0) 1236 420199
T: 00 1 (519) 745 1158
T: 00 49 (180) 1111 881
T: 00 33 (0)1 7036 7473

E: enquiries@tannoy.com
E: inquiries@tannoy.com
E: anfragen@tannoy.com
E: ventes@tannoy.com

tannoy®.com