

ERA 400 Performance CLD ERA 400 Performance WRM

User manual

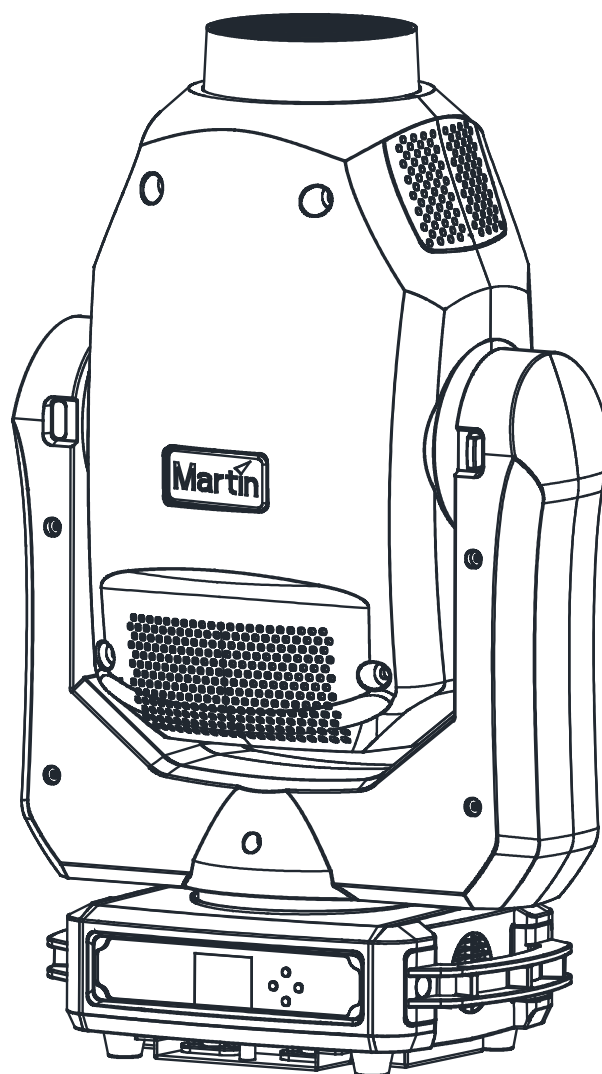

Dimensions

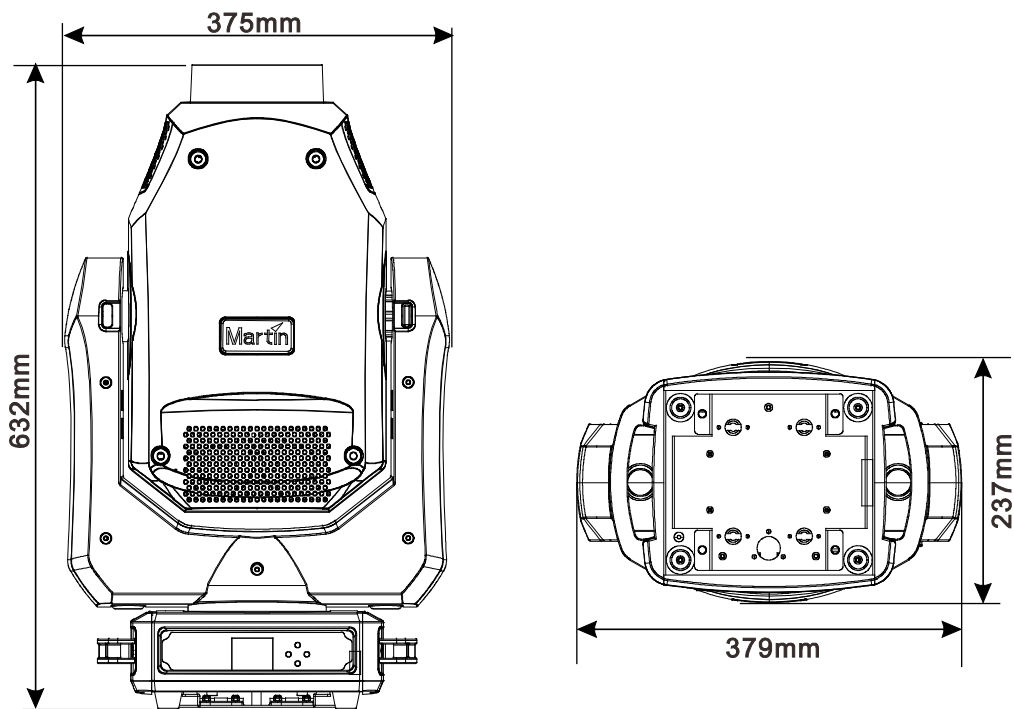

All dimensions are given in millimeters

© 2019 HARMAN® Professional Solutions. Information subject to change without notice. HARMAN® Professional Solutions and all affiliated companies disclaim liability for any injury, damage, direct or indirect loss, consequential or economic loss or any other loss occasioned by the use of, inability to use or reliance on the information contained in this manual. Martin®, HARMAN® and all other trademarks in this document pertaining to services or products by Martin Professional™ or its affiliates and subsidiaries are registered as the property of HARMAN® Professional Solutions.

Table of contents

Dimensions.....	2
Safety information.....	4
Introduction.....	8
Before using the product for the first time.....	8
Fixture overview	9
Physical installation.....	10
Fixture location.....	10
Mounting the fixture.....	10
Fastening the fixture to a flat surface.....	10
Mounting the fixture on a truss	10
AC power connection.....	12
Linking fixtures to power in a chain	12
Data network requirements.....	13
Tips for reliable data transmission.....	13
Connecting the data link.....	13
Fixture Setup	14
Using the control menus.....	14
Setting DMX address.....	14
Personality settings	14
Set all settings to factory default.....	16
Fixture Test.....	16
Fixture Information	16
Setting options by RDM.....	18
Scanning for RDM devices on the data link	18
Getting status and setting options by RDM.....	18
RDM	19
Effects	20
Dimming.....	20
Strobe effects	20
Pan and tilt.....	20
Colors	20
Gobos	21
Focus.....	22
Zoom	22
Prism	22
Iris	22
Beam shaping blades	22
Maintenance.....	24
Cleaning.....	24
Fuse replacement	24
Service and repairs	25
DMX protocol.....	26
Control menus.....	30
Troubleshooting	36
Specifications.....	37

Safety information



WARNING!

Read the safety precautions in this manual before installing, operating or servicing this product.

The following symbols are used to identify important safety information on the product and in this manual:



Warning!

Safety hazard. Risk of severe injury or death.



Warning!

Powerful light emission. Risk of eye injury.



Warning!

See user manual for important safety information.



Warning!

Hazardous voltage. Risk of lethal or severe electric shock.



Warning!

Fire hazard.



Warning!

Hot surfaces.



Warning! Risk Group 3 - high risk product (see page 5) according to EN62471. Possibly hazardous radiation emitted from this product. May be harmful to the eyes. Do not stare at operating lamp and do not view the light output with optical instruments or any device that may concentrate the beam.

This lighting fixture is for professional use only and must be installed by a qualified technician. It is not for household use. It presents risks of severe injury or death due to fire hazards, electric shock and falls. It can create a fire hazard or a risk of eye injury if the safety precautions below are not followed.



Install, operate and service Martin® products only as directed in their user manuals, or you may create a safety hazard or cause damage that is not covered by product warranties. Follow the safety precautions listed below and observe all warnings in this manual and printed on the product. Keep this user manual for future use.

For the latest user documentation and other information about this and all Martin® products, please visit the Martin® website at <http://www.martin.com>

If you have any questions about how to install, operate or service the fixture safely, please contact your Martin® distributor (see www.martin.com/distributors for details) or in the USA on 1-844-776-4899.

Respect all locally applicable laws, codes and regulations when installing, operating or servicing the fixture.



Protection from electric shock

Ensure that the fixture is electrically connected to ground (earth).

Disconnect the fixture from AC power when not in use.

Do not open the fixture or remove any cover. Refer any service operation not described in this manual to an authorized Martin Service partner.

Shut down power to the entire installation at the main power distribution board and lock out power before carrying out any installation or maintenance work.

Use only a source of AC power that complies with local building and electrical codes and has both overload and ground-fault (earth-fault) protection.

Isolate the fixture from power immediately if any seal, cover, cable, or other component is damaged, defective, deformed or showing signs of overheating. Do not reapply power until repairs have been completed.

Before using the fixture, check that all power distribution equipment and cables are in perfect condition and are of suitable type for the location (including water, pollution, temperature and UV resistance).

The light source contained in this luminaire shall only be replaced by the manufacturer or his service agent or a similar qualified person.

Do not expose the unit to rain or moisture.



Protection from burns and fire

Do not operate the fixture if the ambient temperature (T_a) exceeds 40°C (104°F).



The surface of the fixture can reach up to 70°C (158°F) if the fixture is operated at the maximum permitted ambient temperature. Allow the fixture to cool for at least 40 minutes before handling.

Install the fixture on a non-combustible surface (brick, concrete, plaster etc.) only.

Keep all combustible materials (volatile liquids etc.). Keep all combustible materials (e.g. fabric, wood, paper) at least 0.2 m (8 in.) away from the fixture head.

Ensure that there is free and unobstructed airflow around the fixture. Provide a minimum clearance of 100 mm (4 in.) around fans and air vents.

Do not illuminate surfaces within 500 mm (19.7 ins.) of the fixture.

Do not attempt to bypass thermostatic switches or fuses.

Do not modify the fixture in any way not described in this manual or install other than genuine Martin® parts. Do not stick filters, masks or other materials onto any lens or other optical component.



Protection from eye injury: ERA 400 Performance CLD variant

This fixture is a Risk Group 2 product according to IEC/TR 62778 for blue light only and a Risk Group 3 product when all photo-biological risks are considered according to IEC/EN 62471. It emits possibly hazardous optical radiation.

It falls into the Risk Group categories shown below according to both IEC/EN 62471 and IEC/TR 62778 under worst-case conditions:

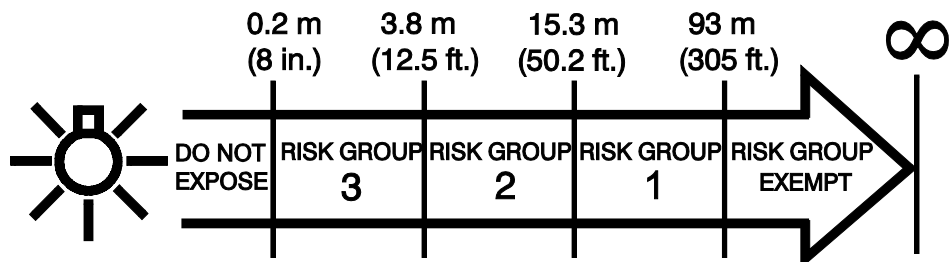

At a distance of less than 3.8 m (12.5 ft.) from the fixture, the light output can potentially cause eye or skin injury before an exposed person's natural aversion responses (blink reflex and reaction to skin discomfort) can protect them. At distances greater than 3.8 m (12.5 ft.), potential eye and skin injury hazards from the light output are normally prevented by natural aversion reflexes.

Position the fixture so that persons cannot be exposed to the fixture's light output at a distance of less than 3.8 m (12.5 ft.) from the fixture, and so that prolonged staring into the light output at less than 15.3 m (50 ft.) from the fixture is not expected.

Do not look directly into the fixture's light output.

Do not look at LEDs with magnifiers, telescopes, binoculars or similar optical instruments that may concentrate the light output.

Ensure that persons are not looking at the fixture when the fixture lights up suddenly. This can happen when power is applied, when the fixture receives a DMX signal, or when certain control menu items are selected.

Disconnect the fixture from power at all times when the fixture is not in use.

Provide well-lit conditions to reduce the pupil diameter of anyone working on or near the fixture.

Protection from eye injury: ERA 400 Performance WRM variant

This fixture is a Risk Group 2 product according to IEC/TR 62778 for blue light only and a Risk Group 2 product when all photo-biological risks are considered according to IEC/EN 62471. It emits possibly hazardous optical radiation.

It falls into the Risk Group categories shown below according to both IEC/EN 62471 and IEC/TR 62778 under worst-case conditions:

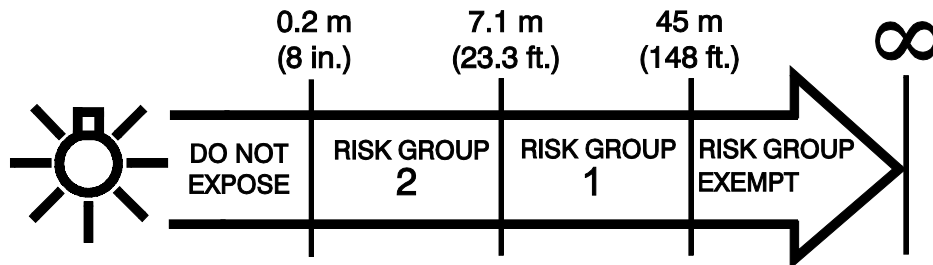

Position the fixture so that persons cannot be exposed to the fixture's light output at a distance of less than 0.2 m (8 in.) from the fixture, and so that prolonged staring into the light output at less than 7.1 m (23.3 ft.) from the fixture is not expected.

Do not look directly into the fixture's light output.

Do not look at LEDs with magnifiers, telescopes, binoculars or similar optical instruments that may concentrate the light output.

Ensure that persons are not looking at the fixture when the fixture lights up suddenly. This can happen when power is applied, when the fixture receives a DMX signal, or when certain control menu items are selected.

Disconnect the fixture from power at all times when the fixture is not in use.

Provide well-lit conditions to reduce the pupil diameter of anyone working on or near the fixture.



Protection from injury

Fasten the fixture securely to a fixed surface or structure when in use. The fixture is not portable when installed.

Ensure that any supporting structure and/or hardware used can hold at least 10 times the weight of all the devices they support.

If suspending from a rigging structure, fasten the fixture to a rigging clamp. Do not use safety cables as the primary means of support.

If the fixture is installed in a location where it may cause injury or damage if it falls, install as directed in this manual a secondary attachment such as a safety cable that will hold the fixture if a primary attachment fails. The secondary attachment must be approved by an official body such as TÜV as a safety attachment for the weight that it secures, must comply with EN 60598-2-17 Section 17.6.6 and must be capable of bearing a static suspended load that is ten times the weight of the fixture and all installed accessories.

Allow enough clearance around the head to ensure that it cannot collide with an object or another fixture when it moves.

Check that all external covers and rigging hardware are securely fastened.

Do not operate the fixture with missing or damaged covers, shields or any optical component.

Block access below the work area and work from a stable platform whenever installing, servicing or moving the fixture.

Do not lift or carry the fixture by its head. Always ensure that the fixture is supported by its base.

In the event of an operating problem, stop using the fixture immediately and disconnect it from power. Do not attempt to use a fixture that is obviously damaged.

Do not modify the fixture or install other than genuine Martin parts.

Refer any service operation not described in this manual to a qualified technician.

Introduction

The ERA 400 Performance from Martin® is a compact fully featured profile fixture with a 300W white LED engine that produces a sharp gobo projection with a flat field.

The fixture provides 540° of pan movement, 260° of tilt movement, motorized 1:3 zoom, motorized focus lens, motorised beam shaping shutters, smooth full-range dimming, strobing shutter and pulse effects, full CMY color mixing system, 9 color filters, 7 user-replaceable rotating gobos, 9 static gobos, a rotating prism, and iris making the fixture ideal for live shows, TV events, stage, concerts, and nightclubs.

The Martin® ERA 400 Performance is available in two variants with different source LEDs. This manual covers both variants.

ERA 400 Performance WRM

- 3200K warm white LED source
- 6000 lumens fixture output
- color rendering index (CRI) >96

ERA 400 Performance CLD

- 6500K cold white LED source
- 10000 lumens fixture output
- color rendering index (CRI) >72

The Martin® ERA 400 Performance can be controlled using any DMX-compliant controller and may be remotely configured by RDM. It is supplied with this user manual, a 1.5 m (4.9 ft.) power cable ready for a local power plug (not included), and two mounting brackets for attachment of suitable, user supplied rigging clamps.

Before using the product for the first time

1. Read 'Safety information' on page 4 before installing, operating or servicing the fixture.
2. Unpack and ensure that there is no transportation damage before using the fixture. Do not attempt to operate a damaged fixture.
3. Before operating, ensure that the voltage and frequency of the power supply match the power requirements of the fixture.
4. If the fixture is not going to be hard-wired to a mains supply, install a local power plug (not supplied) on the end of the supplied power cable.
5. If fixtures are exposed to a sudden temperature change, give them time to warm or cool to the ambient temperature before applying power. This will help avoid damage due to condensation.
6. Check the support pages on the Martin® website at www.martin.com for the most recent user documentation and technical information about the fixture. Martin® user manual revisions are identified by the revision letter at the bottom of the inside cover.

Note that whenever AC power is applied to the fixture, it will reset all effects and functions to their home positions and the fixture head will move. This process usually takes around 20 seconds.

Fixture overview

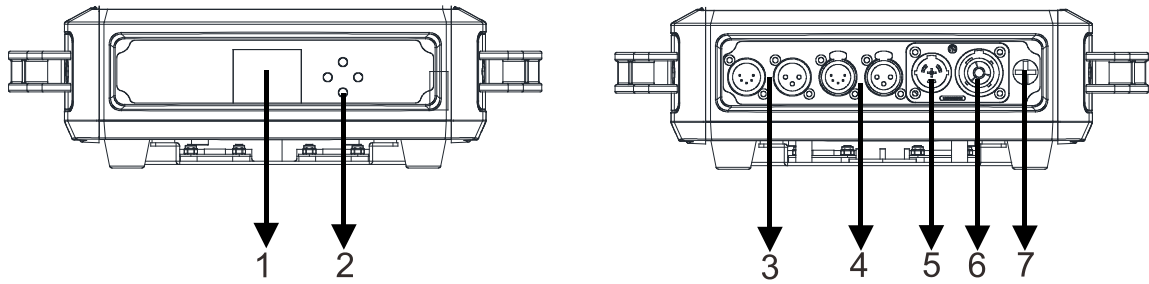

1 – Display

The display shows the fixture status and user setup menu. When DMX is not detected, the display backlight will flash on and off.

2 - Buttons

MENU: Activate the menu mode, or return to the previous level of the menu structure.

DOWN: Decrease a parameter setting, or go down a menu branch

UP: Increase a parameter setting, or go up a menu branch

ENTER: Confirm the selected function

Press and hold the MENU button to exit the menu mode.

3 - DMX XLR input plugs

3 and 5-pin XLR plugs are provided for the DMX input.

4- DMX XLR output sockets

3 and 5-pin XLR sockets are provided for the DMX output, to link through to the next fixture.

5 - Mains power input

A Neutrik PowerCON TRUE1 input connector is provided to connect the fixture to mains power.

6 - Mains power output

A Neutrik PowerCON TRUE1 output connector is provided which can be used to supply power to other fixtures. Please ensure you keep within the power limits listed in “Linking fixtures to power in a chain” on page 12.

7 - Fuse

The T 10 A fixture fuse is located in a fuseholder next to the power input/output connectors.

Physical installation



Warning! Read 'Safety information' on page 4 before installing the fixture.

Warning! The safety and suitability of lifting equipment, installation location, anchoring method, mounting hardware and electrical installation are the responsibility of the installer. All local safety regulations and legal requirements must be observed when installing and connecting the ERA 400 Performance fixture. Installation must be carried out by qualified professionals only.

Contact your Martin supplier for assistance if you have any questions about how to install this product safely.

Fixture location

The ERA 400 Performance fixture is intended for interior use only. Do not install outside or in damp or humid locations. The fixture requires free and unobstructed airflow around it to ensure adequate cooling.

Observe the following limitations in selecting a location:

- Respect the limitations listed under 'Safety information' on page 4.
- Do not locate the fixture in an unventilated space.

Mounting the fixture



Warning! All fasteners used to mount ERA 400 Performance fixtures must be strong enough to hold the fixture safely. Install a washer directly under the head of each fastener when anchoring the mounting bracket to the installation surface.

Fastening the fixture to a flat surface

The fixture can be fastened to a hard, fixed, flat surface in any orientation. Ensure that the surface and all fasteners used can support at least 10 times the weight of all fixtures and equipment they will support.

Fasten the fixture securely or stand it securely on a level surface. If you install the fixture in a location where it may cause injury or damage if it falls, secure it as directed below with a securely anchored safety cable that will hold the fixture if the primary fastening method fails.

Mounting the fixture on a truss

The fixture can be clamped to a truss or similar rigging structure in any orientation. Use a suitable rigging clamps such as a G-clamp or a half-coupler clamp (see illustration on right) fastened to the included omega brackets.



To clamp the fixture to a truss:

1. Check that the rigging structure can support at least 10 times the weight of all fixtures and equipment to be installed on it.
2. Block access under the work area.
3. The fixture is supplied with a pair of omega-type brackets to which rigging clamps can be attached. Bolt a rigging clamp securely to each bracket. The bolts used must be M12, grade 8.8 steel minimum, and fastened with a self-locking nut.

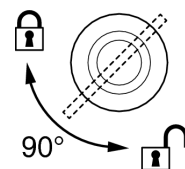

4. Fasten the omega brackets to mounting holes **A** on the base of the fixture using the bracket's quarter-turn fasteners. Turn quarter-turn fasteners a full 90° to lock them (see illustration on right).
5. Working from a stable platform, hang the fixture vertically on the truss and fasten the rigging clamps onto the truss.
6. Secure the fixture with a safety cable through attachment point **B** as directed below.
7. Check that the head will not collide with other fixtures or objects.

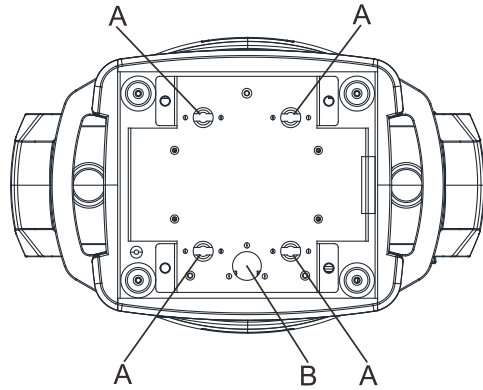

Securing with a safety cable

Secure the fixture with a safety cable (or other secondary attachment) that is approved for the weight of the fixture so that the safety cable will hold the fixture if the primary attachment fails. Loop the safety cable through the attachment point **B** in the base of the fixture base (see illustrations above and to right) and around a secure anchoring point.

If a safety cable attachment point becomes damaged or deformed, do not use the fixture. Return it to a Martin Service Centre for repair.

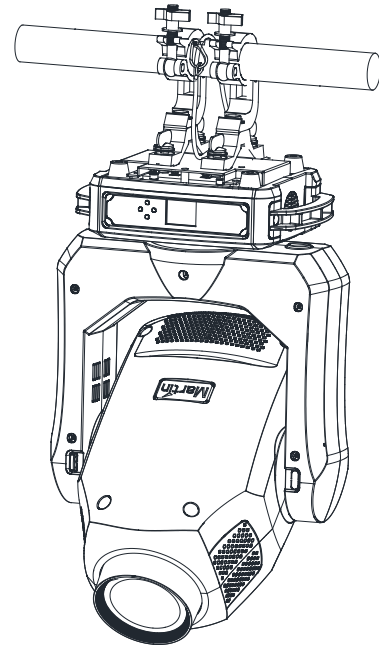

AC power connection



Warning! Read 'Safety information' on page 4 before installing the fixture.



Warning! The mains power input cable supplied with the fixture is rated 6 A and can supply only one fixture with mains power. Do not connect any device to the fixture's MAINS OUT socket when using this input cable. If you want to connect other fixtures to the MAINS OUT socket, see 'Linking fixtures to power in a chain' on page 12.

For protection from electric shock, the fixture must be grounded (earthed). The power distribution circuit must be equipped with a fuse or circuit breaker and ground-fault (earth-fault) protection.

Do not use an external dimming system to supply power to the fixture, as this may cause damage to the fixture that is not covered by the product warranty.

The fixture can be hard-wired to a building electrical installation if you want to install it permanently, or a power plug (not supplied) that is suitable for the local power outlets can be installed on the power cable. Socket outlets or external power switches used to supply the fixture with power must be located near the fixture and easily accessible so that the fixture can easily be disconnected from power.

If you install a power plug on the supplied power cable, install a grounding type (earthed) plug with integral cable grip that is suitable for your local mains voltage at a current of 6A. Follow the plug manufacturer's instructions and connect the wires in the power cable as shown in this table:

	Live or L	Neutral or N	Earth, Ground or ⊕
US system	Black	White	Green
EU system	Brown	Blue	Yellow/green

The fixture has an auto-ranging power supply that accepts AC mains power at 100-240 V at 50/60 Hz. Do not apply AC mains power at any other voltage or frequency to the fixture.

Linking fixtures to power in a chain

The mains power input cable supplied with the fixture is rated at 6A and can only supply enough power for one fixture. If you want to use the MAINS OUT socket on the fixture to link power to the next fixture in a daisy-chain, you need to obtain the larger power input cables and power link cables available as an accessory from Martin, see 'Specifications' on page 37.

Using the 14 AWG or 1.5mm² cables from Martin™, you can link:

- Maximum three (3) ERA 400 fixtures in total at 100-120 V, or
- Maximum five (5) ERA 400 fixtures in total at 200-240 V.

If you install a power plug on the 14 AWG / 1.5 mm² power input cable, install a grounding type (earthed) plug with integral cable grip that is rated minimum 16 A at the correct voltage rating for your local power supply.

Data network requirements

A DMX 512 data link is required in order to control the fixture via DMX. The fixture has 3-pin and 5-pin XLR connectors for DMX data input and output.

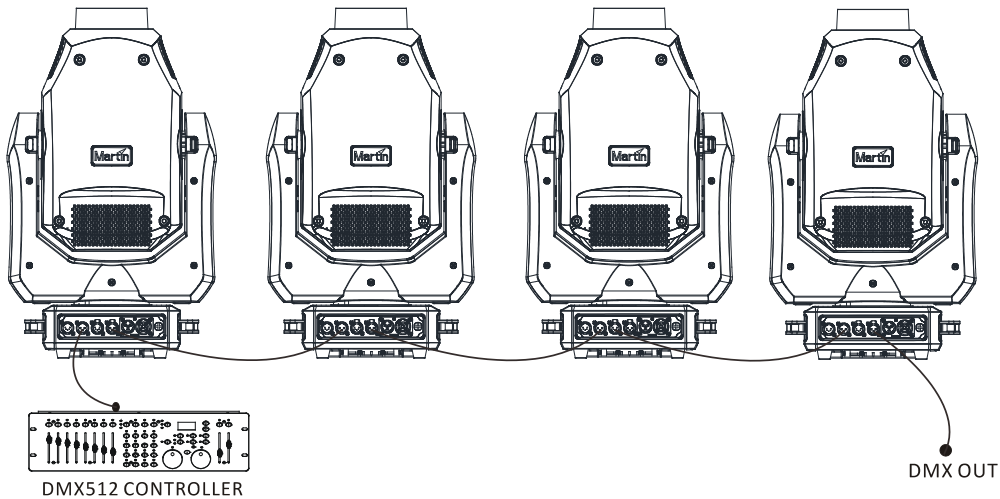

Up to 32 devices can be linked together on a single daisy chain. The total number of fixtures in one 512-channel DMX universe is limited by the number of DMX channels required by the fixtures. Note that if independent control of a fixture is required, it must have its own DMX channels. Fixtures that are required to behave identically can share the same DMX address and channels. To add more fixtures or groups of fixtures when the above limits are reached, add another DMX universe or split the daisy-chained link into branches using a powered DMX splitter.

Tips for reliable data transmission

Use shielded twisted-pair cable designed for RS-485 devices: standard microphone cable cannot transmit control data reliably over long runs. 24 AWG cable is suitable for runs up to 300 meters (1000 ft.). Heavier gauge cable and/or a DMX buffer is recommended for longer runs. The pin-out on all connectors is:

- pin 1 = shield
- pin 2 = cold (-)
- pin 3 = hot (+).

Pins 4 and 5 in the 5-pin XLR connectors are not used in the fixture but are available for possible additional data signals as required by the DMX512-A standard. Standard pin-out is pin 4 = data 2 cold (-) and pin 5 = data 2 hot (+).

To split the link into branches, use an opto-isolated splitter such as the Martin™ DMX5.3 Splitter. Do not split the link by connecting to both the 3-pin and 5-pin output sockets as this may cause data errors. Terminate the link by installing a termination plug in the output socket of the last fixture. The termination plug, which is a male XLR plug with a 120 Ohm, 0.25 W resistor soldered between pins 2 and 3, “soaks up” the control signal so it does not reflect and cause interference. If a splitter is used, terminate each branch of the link.

Connecting the data link

To connect the fixture to data:

Connect the DMX data output from the controller to the closest fixture's male XLR DMX input connector.

- Connect the first fixture's DMX output to the DMX input of the next fixture and continue connecting fixtures output to input. Terminate the last fixture on the link with a DMX termination plug.

Fixture Setup

This section explains the fixture characteristics you can set that determine how it can be controlled and will behave. You choose the settings using the menus available from the control panel, and they are retained even when the fixture is powered off.

Options can also be set over the DMX line using RDM from a suitable controller, see “Setting options by RDM” on page 18.

A complete map of the control menu structure and brief explanations of their purposes can be found on page 30. Only the most-used functions are described in this section.

Using the control menus

To access the control menus, press the MENU button.

Navigate the menu structure using the ENTER, DOWN and UP buttons.

To select a menu option or to confirm a selection, press the ENTER button.

To return to a higher level in the menu structure without making a change, press the MENU button.

To exit the control menus completely, press and hold the MENU button.

Setting DMX address

Each fixture must be assigned a DMX address. The DMX address, also known as the start channel, is the first channel used to receive instructions from a DMX controller. The fixture is controlled using 30 DMX channels. If a fixture has a DMX address of 1, then it uses channels 1 to 30 inclusive. The following fixture in the DMX chain can then be set to a DMX address of 31.

For independent control, each fixture must be assigned its own control channels. Two fixtures of the same type may share the same address if identical behavior is desired. Address sharing can be useful for diagnostic purposes and symmetric control, particularly when combined with the inverse pan and tilt options.

To set the fixture's DMX address:

1. Enter the control menu and select DMX SETUP. Press ENTER.
2. Select DMX ADDRESS and press ENTER.
3. Use the UP and DOWN buttons to select the desired address setting.
4. Press ENTER to confirm your selection (or to return to the top level menu without changing the settings, press the MENU button).

Personality settings

Personality settings include Pan inverse, Tilt inverse, Dimmer Curve, Dimmer Speed, No Data Mode, Cooling Mode and Display.

Pan/tilt inversion

The Pan inverse and Tilt inverse menus can be used to reverse the direction of pan and tilt. These settings are useful for symmetrical effects with multiple fixtures, or when coordinating the movement of fixtures that are floor mounted and rigged upside down.

To adjust the pan or tilt inversion settings:

1. Enter the control menu and select PERSONALITY. Press ENTER.
2. Select PAN INVERSE or TILT INVERSE and press ENTER.
3. The current setting will blink on the display. Use the UP and DOWN buttons to select YES (inversion) or NO (normal) mode.
4. Press ENTER to confirm your selection.

Dimming curves

Four dimming modes are available:

- LINEAR** The increase in light intensity appears to be linear as DMX value is increased.
- SQUARE LAW** Light intensity control is finer at low levels and coarser at high levels.
- INV SQ LAW** (Inverse square law) Light intensity control is coarser at low levels and finer at high levels.
- S-CURVE** Light intensity control is finer at low levels and high levels and coarser at medium levels.

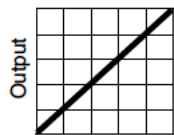

Optically linear

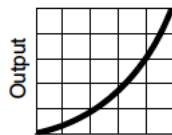

Square law

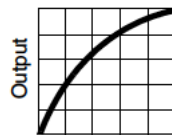

Inverse square law

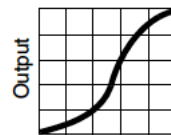

S-curve

To set the fixture's dimmer curve, select DIMMER CURVE from the PERSONALITY menu and press ENTER to confirm. Use the UP and DOWN buttons to select the desired mode. Press ENTER to save your selection.

Dimmer Speed

You can set a fade speed on the dimmer to simulate a tungsten fixture.

To set dimmer fade speed, select DIMMER SPEED from the PERSONALITY menu and press ENTER. Use the UP and DOWN buttons to select FAST or SLOW. Press ENTER to confirm your selection.

No Data Mode

This option sets what will happen when DMX data is not present.

To set No Data Mode, select NO DATA MODE from the PERSONALITY menu and press ENTER to confirm. Use the UP and DOWN buttons to select:

BLACKOUT – If data connection is lost, fixture will blackout

HOLD – If data connection is lost, fixture holds latest received data value at all channels

Press ENTER to confirm.

Cooling Mode

This option sets whether the cooling fans run at full speed all the time, or will be controlled by fixture output power.

To set cooling mode, select COOLING MODE from the PERSONALITY menu and press ENTER to confirm. Use the UP and DOWN buttons to select:

REGULATED FANS – Fan speed will be controlled by heat demand in the fixture.

FULL – Fans set to full constant speed.

Press ENTER to confirm.

Display

This option allows you to set some parameters for the display screen.

Select DISPLAY from the PERSONALITY menu and press ENTER to confirm.

Use the UP and DOWN buttons to select:

- **DISPLAY ROTATION** – Use the UP and DOWN buttons to select Normal (Display orientation normal) or ROTATE 180 (Display orientation rotated 180°)
- **DISPLAY INTENSITY** – Use the UP and DOWN buttons to adjust display intensity from 10%-100% (default = 100%)
- **TEMPERATURE UNIT** – Use the UP and DOWN buttons to select ° C or ° F

Press ENTER to confirm.

Set all settings to factory default

To return all settings to factory default, select DEFAULT SETTINGS and press ENTER to confirm, FACTORY DEFAULT will show on the display.

Use the UP and DOWN buttons to select NO (cancel) or YES (return all settings except calibrations to factory defaults).

Press ENTER to confirm (or press MENU to exit without making a change).

Fixture Test

This menu allows you to run self test sequences on the fixture. The test sequences are:

TEST ALL – runs a test sequence through all functions

TEST DIMMER – just the LED array is tested

TEST EFFECTS – tests all effects functions within the head

TEST PAN/TILT – tests the pan/tilt functions.

Fixture Information

This menu allows you to call up the following fixture information in the display.

POWER ON TIME – displays number of hour's fixture has been powered on since manufacture (not user-resettable).

LED HOURS - displays number of hour's fixture LED's have been powered on since manufacture (not user-resettable).

SW VERSION - displays the currently installed firmware (fixture software) version.

FIXTURE ID – user selectable fixture ID number (default is 0000).

RDM UID – displays the fixtures factory-set unique ID for identification in RDM systems.

TEMPERATURES – provides separate PCB temperature readouts.

Viewing live DMX values

This menu allows you to view the current DMX values for any function.

Select the DMXLIVE menu and press ENTER.

Use the UP and DOWN buttons to select the function you wish to view.

You can select Strobe, Dimmer, Dimmer Fine, Cyan, Magenta, Yellow, Color, Gobo1, RGobo1, Gobo2, Prism, R-Prism, Iris, Zoom, Focus, Blade1 Pos, Blade1 Ang, Blade2 Pos, Blade2 Ang, Blade3 Pos, Blade3 Ang, Blade4 Pos, Blade4 Ang, Blade Rot, Pan, Pan Fine, Tilt, Tilt Fine and Pan/Tilt Speed.

Setting control values manually

You can manually set control values. This may be useful when testing, or to use the fixture in a static setting without a DMX controller.

This menu also allows you to reset all functions in case something is out of position.

Reset

To reset functions, go to the MANUAL CONTROL menu and press ENTER. Use the UP and DOWN buttons to select RESET and press ENTER again.

Use the UP and DOWN buttons to select:

ALL (resets all functions in fixture)

PAN/TILT (resets just the pan/tilt motors)

EFFECTS (resets the effects in the head)

Once you have selected one of the above, press ENTER, then use UP and DOWN to select YES, then press ENTER to activate.

Setting values

Go to the MANUAL CONTROL menu and press ENTER. Use the UP and DOWN buttons to select the function you wish to control.

You can select Strobe, Dimmer, Dimmer Fine, Cyan, Magenta, Yellow, Color, Gobo1, RGobo1, Gobo2, Prism, R-Prism, Iris, Zoom, Focus, Blade1 Pos, Blade1 Ang, Blade2 Pos, Blade2 Ang, Blade3 Pos, Blade3 Ang, Blade4 Pos, Blade4 Ang, Blade Rot, Pan, Pan Fine, Tilt, Tilt Fine and Pan/Tilt Speed.

Once you have selected a function, press ENTER, then use the UP and DOWN buttons to select a value from 0 to 255.

Press MENU to go back up and select a different function to control.

Pan/tilt correction when knocked

Normally if the fixture is knocked or pushed while set to a position it will automatically return to the correct position. You can turn this feature off.

Go to the SERVICE menu and press ENTER.

Select P/T FEEDBACK and press ENTER.

Use the UP and DOWN buttons to select NO (sensors enabled, unit will correct) or YES (sensors disabled, unit will not correct).

Press ENTER to store the setting.

Calibration

Martin® fixtures are adjusted and calibrated at the factory, and further calibration will normally only be necessary if fixtures have been subjected to abnormal shocks during transport, if normal wear and tear has affected alignment after an extended period of use. You can also use calibration to fine-tune fixtures for a particular location or application.

The Calibration menu lets you define offsets in the fixture software to adjust the positions of pan, tilt etc. relative to the DMX values the fixture receives. This allows you to fine-tune fixtures and achieve uniform behavior in different fixture.

Loading and storing default calibration offsets

Go the SERVICE menu and press ENTER

Select CALIBRATION and press ENTER

Use UP and DOWN button to select function that requires calibration and press ENTER

Adjust value to desired level and press ENTER

Note

LOAD DEFAULTS lets you erase the calibration offsets that you have defined and reload the default calibration offsets that are stored in memory

SAVE DEFAULTS lets you overwrite the factory default calibration offsets that are stored in memory with any new offsets that you have defined. Overwriting is permanent, so once you have saved new default offsets, LOAD DEFAULTS will now load the new defaults, not the original factory defaults.

Setting options by RDM

You can remotely configure the fixture over the DMX line using RDM. Martin® offers a range of suitable RDM-compatible controllers.

Martin® M-PC is a Windows-based application available from Martin® that lets you set up, manage and control a lighting installation from a PC that is connected to the installation via a DMX data link. To use Martin® M-PC, connect a PC running the application to the data link via a USB-to-DMX interface box such as the Martin® M-DMX.

A full list of the RDM functions that the fixture supports is given at the end of this chapter. These functions are generally referred to using the more specific term 'PIDs' or 'Parameter IDs'.

Scanning for RDM devices on the data link

Before you can communicate with fixtures using RDM, you must send a scan command (also called a device discovery command) to all the devices on the data link so that the RDM controller can identify them. It does this by retrieving each device's factory-set unique identifier (UID). This process can take some time depending on the number of devices on the link.

To identify the fixtures on the link:

Check that the fixtures are correctly connected to the RDM controller on the data link and that power is applied to all fixtures.

1. In Martin® M-PC, go to RDM CONTROLLER → DISCOVER DEVICES.
2. Give the controller time to identify the devices on the link and prepare for communication with the devices.

Getting status and setting options by RDM

The status and options listed in the table below can be read and set by RDM.

You can set an option on one fixture by sending a unicast RDM command to that one fixture only, or you can set the same option on all the fixtures on the data link by sending a broadcast RDM command to all the devices on the link.

For status reading, you can only use unicast RDM to read information from an individual fixture.

RDM

As a minimum, the ERA 400 Performance fixture supports the following RDM functions:

Device discovery

DISC_UNIQUE_BRANCH
DISC_MUTE
DISC_UN_MUTE

Device management

	GET	SET
COMMS_STATUS	✓	
QUEUED_MESSAGE	✓	
STATUS_MESSAGES	✓	
STATUS_ID_DESCRIPTION	✓	
CLEAR_STATUS_ID		✓
SUPPORTED_PARAMETERS	✓	
DEVICE_INFO	✓	
DEVICE_MODEL_DESCRIPTION	✓	
MANUFACTURER_LABEL	✓	
DEVICE_LABEL	✓	✓
SOFTWARE_VERSION_LABEL	✓	
BOOT_SOFTWARE_VERSION_ID	✓	
DMX_PERSONALITY	✓	✓
DMX_PERSONALITY_DESCRIPTION	✓	
DMX_START_ADDRESS	✓	✓
SENSOR_DEFINITION	✓	
SENSOR_VALUE	✓	
DEVICE_HOURS	✓	
PAN_INVERT	✓	✓
TILT_INVERT	✓	✓
IDENTIFY_DEVICE	✓	✓
RESET_DEVICE		✓
LAST_STATE		✓
DIMMER_CURVE		✓

Effects

This section describes the effects provided by the ERA 400 Performance fixture. See 'DMX protocol' on page 26 for a full list of the DMX channels and values required to control the different effects.

Dimming

Overall intensity can be precisely adjusted from 0 to 100% using 16-bit coarse and fine control.

Strobe effects

An electronic shutter provides instant open and blackout, random and variable speed flash from 1 to 25 flashes per second, and pulse effects.

Pan and tilt

The fixture's head can be panned through 540° and tilted through 260° with 16-bit coarse and fine control. Using the control menus it is possible to invert pan or tilt movement. A position feedback circuit provides automatic position correction if the fixture is knocked out of position.

Light output can be set to black out when the head moves using the "Blackout Pan/Tilt move Enable" command on DMX channel 30.

Colors

The fixture has fully variable CMY color mixing.

In addition, a color wheel provides the 9 colors listed below plus an open position. Colors can be selected in full position steps or continuously scrolled to give split colors. The wheel can be rotated at varying speeds, both clockwise and counter-clockwise.

Slot 1: Open	Slot 6: Light Green
Slot 2: Light Blue	Slot 7: Magenta
Slot 3: Dark Green	Slot 8: CTO 3200K (CLD) / CTB 6000K (WRM)
Slot 4: Pink	Slot 9: Dark Blue
Slot 5: Orange	Slot 10: Dark Red

Gobos

The fixture contains two gobo wheels with gobo positions as shown below:

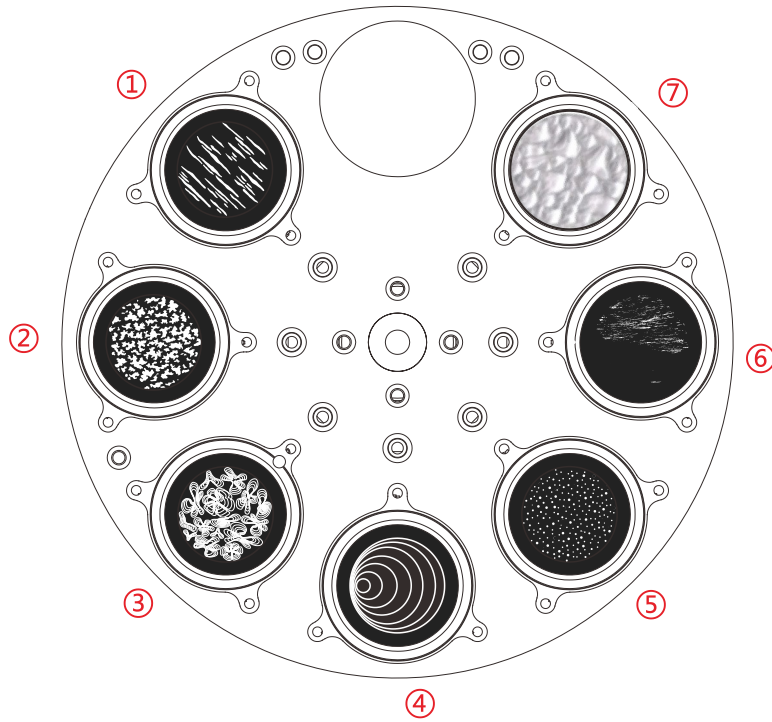

Gobo wheel 1 (rotating/indexing gobos)

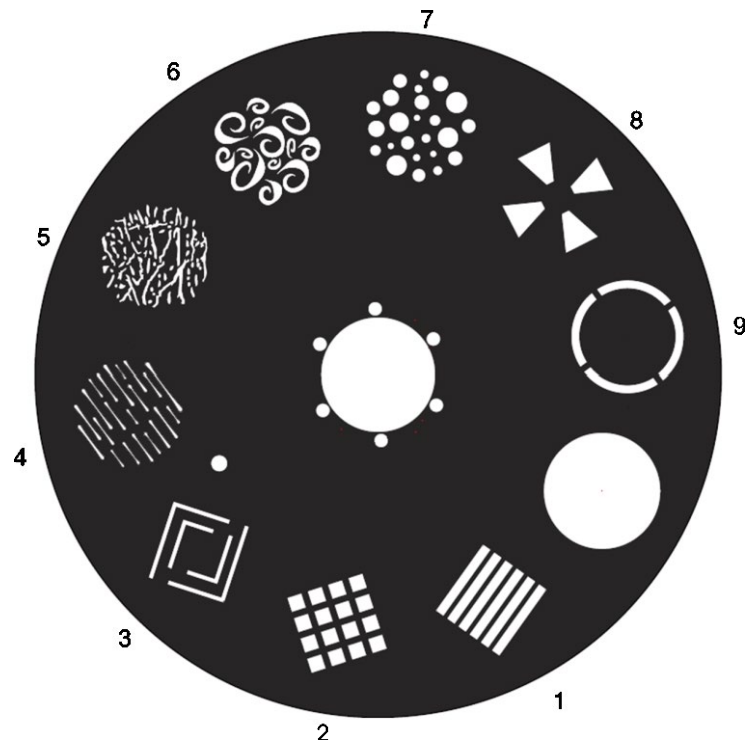

Gobo Wheel 2 (static gobos)

On Gobo Wheel 1, individual gobos can be set to indexed positions, and rotated clockwise and counter-clockwise. Gobo shake is also available on both wheels.

When option "Blackout Color Move" or "Blackout Gobo Move" are set to Enable using DMX channel 30, the fixture blacks out during color and/or gobo changes.

Focus

A motorized focus lens provides adjustment of gobo image or beam shape shutter sharpness.

Zoom

A motorized zoom function allows you to adjust the beam angle of the output beam.

Prism

The fixture incorporates a three-facet circular prism which can be inserted into the beam for split effects. The prism can be set to an indexed position or rotated clockwise or counter-clockwise.

Iris

A motorized iris allows you to close down the beam.

Beam shaping blades

Four shutter blades are provided. You can control the insertion position and angle of each blade to provide shaping of the light beam. The blade system is a full curtain system which allows each blade to be fully inserted into the gate, letting you produce beam shapes such as triangles. Additionally you can rotate the whole blade system to produce diamond shapes. Using the focus control you can make the cut edges hard or soft.

The blades are numbered as shown below looking at the projected beam on the wall, with the fixture hanging (base up), pan=default, display towards the wall.

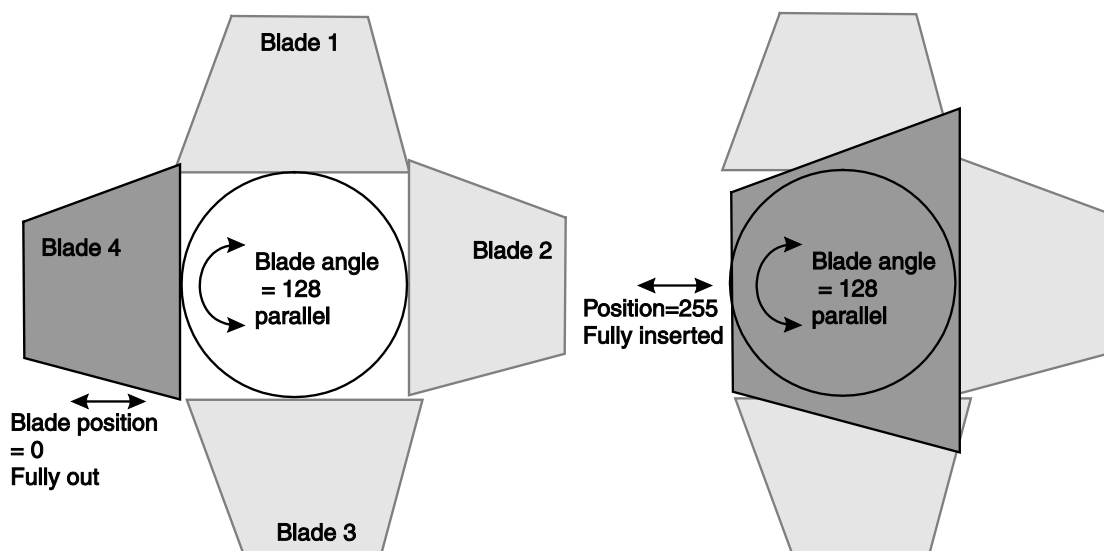

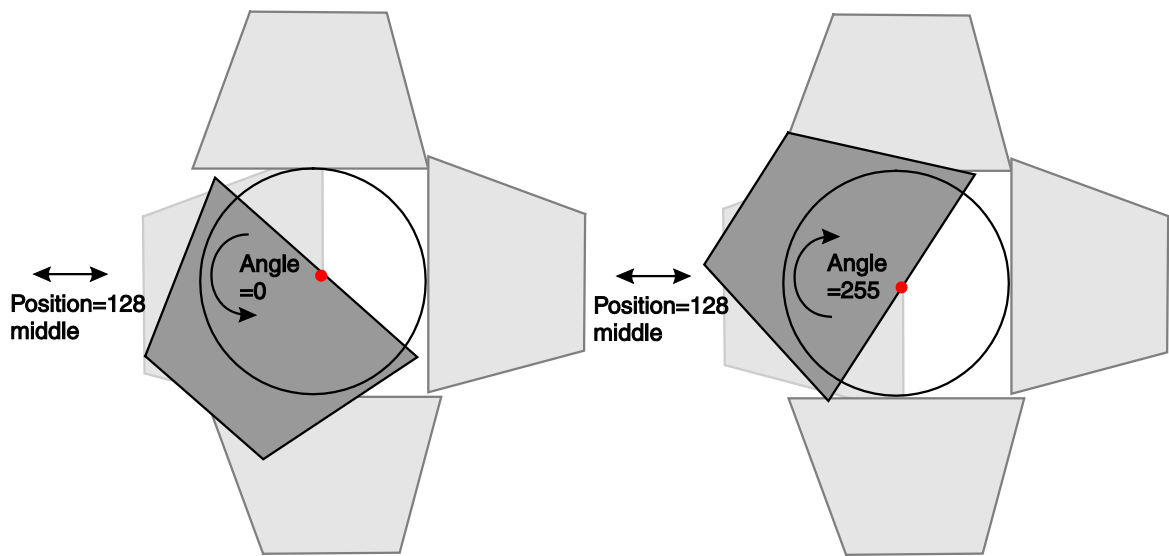

Blade system rotate
=0-127 (counter clockwise)

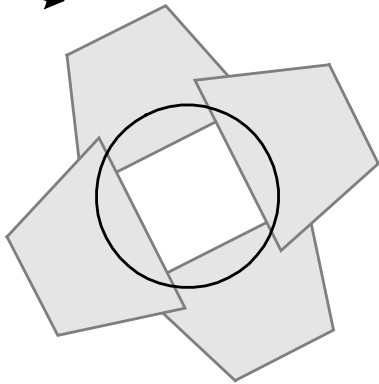

Blade system rotate
=128 (no rotation)

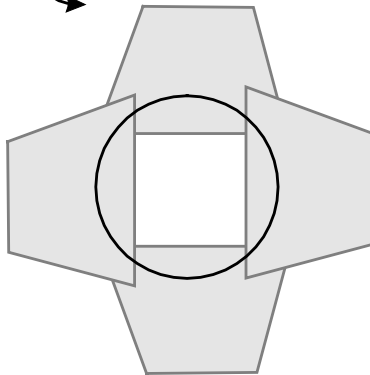

Blade system rotate
=129-255 (clockwise)

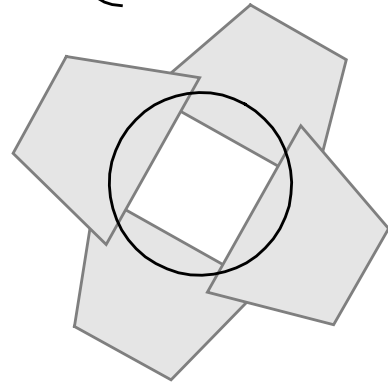

Maintenance



Read Safety information on page 6 before maintaining the fixture. Always comply with the safety instructions.

Refer any service operation not described in this user manual to a qualified service technician.

Excessive dust, smoke fluid, and particle buildup degrades performance, causes overheating and will damage the fixture. Damage caused by inadequate cleaning or maintenance is not covered by the product warranty.

Disconnect mains power before cleaning or servicing the fixture.

Fixtures must be serviced in an area where there is no risk of anyone being injured by failing parts, tools or other materials.

Cleaning

The cleaning of external optical lenses must be carried out periodically to optimize light output. Cleaning schedules for lighting fixtures vary greatly depending on the operating environment. It is therefore impossible to specify precise cleaning intervals for the fixture. Environmental factors that may result in a need for frequent cleaning include:

- Use of smoke or fog machines.
- High airflow rates (near air conditioning vents, for example).
- Presence of cigarette smoke.
- Airborne dust (from stage effects, building structures and fittings or the natural environment at outdoor events, for example).

If one or more of these factors is present, inspect fixtures within their first 100 hours of operation to see whether cleaning is necessary. Check again at frequent intervals. This procedure will allow you to assess cleaning requirements in your particular situation. If in doubt, consult your Martin dealer about a suitable maintenance schedule.

Use gentle pressure only when cleaning, and work in a clean, well-lit area. Do not use any product that contains solvents or abrasives, as these can cause surface damage.

To clean the fixture:

1. Disconnect the fixture from power and allow it to cool for at least 10 minutes.
2. Vacuum or gently blow away dust and loose particles from the outside of the fixture and the air vents at the back and sides of the head and in the base with low-pressure compressed air.
3. Clean the lens by wiping gently with a soft, clean lint-free cloth moistened with a weak detergent solution. Do not rub the surface hard: lift particles off with a soft repeated press. Dry with a soft, clean, lint-free cloth or low-pressure compressed air. Remove stuck particles with an unscented tissue or cotton swab moistened with glass cleaner or distilled water.
4. Check that the fixture is dry before reapplying power.

Fuse replacement

If you need to replace a fuse:

1. Disconnect the fixture from power and allow it to cool for at least 10 minutes.
2. Unscrew the cap of the fuseholder (see Fixture overview on page 9) and remove the fuse. Replace with a fuse of the same size and rating only.
3. Reinstall the fuseholder cap before reapplying power.

Service and repairs

There are no user serviceable parts inside the fixture. Do not open the housing.

Never try to repair the fixture by yourself as this may result in damage, malfunction and it may potentially void your product warranty. The equipment must only be serviced or repaired by an authorized Martin service technician.

Installation, on-site service and maintenance can be provided worldwide by the Martin Professional Global Service organization and its approved agents, giving owners access to Martin's expertise and product knowledge in a partnership that will ensure the highest level of performance throughout the product's lifetime. Please contact your Martin supplier for details.

DMX protocol

STD.	EXT	Value	Function	Fade	Default
1	1	Shutter		Snap	0
		000-019	Blackout		
		020-024	Open		
		025-064	Strobe 1: Fast→Slow		
		065-069	Open		
		070-084	Strobe 2: opening pulse, fast → slow		
		085-089	Open		
		090-104	Strobe 3: closing pulse, fast → slow		
		105-109	Open		
		110-124	Strobe 4: random strobe, fast → slow		
		125-129	Open		
		130-144	Strobe 5: random opening pulse, fast → slow		
		145-149	Open		
		150-255	Open		
2	2	0-255	Dimmer 0-100%	Fade	0
3	3	0-255	Dimmer Fine 0-100%	Fade	0
4	4	000-255	Cyan 0-100%	Fade	0
5	5	000-255	Magenta 0-100%	Fade	0
6	6	000-255	Yellow 0-100%	Fade	0
7	7	Color		Fade	0
		000-006	Open		
		007-012	Color 1: Light Blue		
		013-018	Color 2: Dark Green		
		019-025	Color 3: Pink		
		026-031	Color 4: Orange		
		032-037	Color 5: Light Green		
		038-044	Color 6: Magenta		
		045-050	Color 7: CTO 3200K (CLD) / CTB 6000K (WRM)		
		051-056	Color 8: Dark Blue		
		057-063	Color 9: Dark Red		
		064-127	Color Index		
		128-190	Wheel rotate counterclockwise Fast→Slow		
		191-192	Stop		
193-255	Wheel rotate clockwise Slow→Fast				
8	8	Gobo 1 (rotating)		Snap	0

STD.	EXT	Value	Function	Fade	Default
		000-007	Open		
		008-015	Gobo1		
		016-023	Gobo2		
		024-031	Gobo3		
		032-039	Gobo4		
		040-047	Gobo5		
		048-055	Gobo6		
		056-063	Gobo7		
		064-072	Gobo1 Shaking		
		073-081	Gobo2 Shaking		
		082-090	Gobo3 Shaking		
		091-099	Gobo4 Shaking		
		100-108	Gobo5 Shaking		
		109-117	Gobo6 Shaking		
		118-127	Gobo7 Shaking		
		128-190	Wheel rotate counterclockwise Fast→Slow		
		191-192	Stop		
		193-255	Wheel rotate clockwise Slow→Fast		
9	9	Rotate Gobo 1		Fade	0
		000-127	Index 0 → 360		
		128-190	Counterclockwise rotate Fast→Slow		
		191-192	Stop		
		193-255	Clockwise rotate Slow→Fast		
10	10	Gobo 2		Snap	0
		000-006	Open		
		007-012	Gobo1		
		013-018	Gobo2		
		019-025	Gobo3		
		026-031	Gobo4		
		032-037	Gobo5		
		038-044	Gobo6		
		045-050	Gobo7		
		051-056	Gobo8		
		057-063	Gobo9		
		064-070	Gobo1 Shaking		
		071-077	Gobo2 Shaking		
		078-084	Gobo3 Shaking		
		085-091	Gobo4 Shaking		
		092-098	Gobo5 Shaking		
		099-105	Gobo6 Shaking		

STD.	EXT	Value	Function	Fade	Default
		106-112	Gobo7 Shaking		
		113-119	Gobo8 Shaking		
		120-127	Gobo9 Shaking		
		128-190	Wheel rotate clockwise Fast→Slow		
		191-192	Stop		
		193-255	Wheel rotate counterclockwise Slow→Fast		
11	11	Prism		Snap	0
		000-010	No Effect		
		011-127	Prism1 On		
		128-255	Prism1 Macro1 – Macro32		
12	12	Prism rotation		Fade	0
		000-127	Index 0 -> 360		
		128-190	Clockwise rotate Fast->Slow		
		191-192	stop		
		193-255	Counterclockwise rotate Slow->Fast		
13	13	000-255	Iris Big→Small	Fade	0
14	14	000-255	Zoom Narrow → Wide	Fade	0
	15	000-255	Zoom Fine	Fade	0
15	16	000-255	Focus Far → Near	Fade	0
	17	000-255	Focus Fine	Fade	0
16	18	000-255	Blade 1 position Out → In	Fade	0
17	19	Blade 1 angle		Fade	127
		000-126	Min angle → Parallel		
		127-128	Parallel		
		129-255	Parallel → Max angle		
18	20	000-255	Blade 2 position Out → In	Fade	0
19	21	Blade 2 angle		Fade	127
		000-126	Min angle → Parallel		
		127-128	Parallel		
		129-255	Parallel → Max angle		
20	22	000-255	Blade 3 position Out → In	Fade	0
21	23	Blade 3 angle		Fade	127
		000-126	Min angle → Parallel		
		127-128	Parallel		
		129-255	Parallel → Max angle		
22	24	000-255	Blade 4 position Out → In	Fade	0
23	25	Blade 4 angle		Fade	127
		000-126	Min angle → Parallel		
		127-128	Parallel		
		129-255	Parallel → Max angle		

STD.	EXT	Value	Function	Fade	Default
24	26	Blade system rotation		Fade	0
		000-126	Counter clockwise 45 degrees → 0		
		127-128	Not rotated (square)		
		129-255	0 → Clockwise 45 degrees		
25	27	000-255	Pan 0 - 100%	Fade	127
26	28	000-255	Pan Fine 0- 100%	Fade	0
27	29	000-255	Tilt 0 - 100%	Fade	127
28	30	000-255	Tilt Fine 0 - 100%	Fade	0
29	31	000-255	Pan/Tilt Speed Fast → Slow	Fade	0
30	32	Special Function		Snap	0
		000-069	No function		
		070-079	BlackOut Pan/Tilt Move Enable		
		080-089	BlackOut Pan/Tilt Move Disable		
		090-099	BlackOut Color Move Enable		
		100-109	BlackOut Color Move Disable		
		110-119	BlackOut Gobo Move Enable		
		120-129	BlackOut Gobo Move Disable		
		130-199	No function		
		200-209	Reset All		
		210-219	Reset Effect		
		220-229	Reset Pan/Tilt		
		230-255	No function		

Control menus

To access the control menus, press the MENU button. Use the UP and DOWN buttons to navigate the menus. Select any required menu option using the ENTER button. For more information, see “Using the control menus” on page 14.

Default fixture settings are shown in **bold**.

Menu	Second-level menu	Sub-menu	Explanation
DMX SETUP	DMX ADDRESS	1* -483	Fixture DMX address setting
	CONTROL MODE	STD*	30 channel mode
		EXT	32 channel mode (16 bit control of zoom/focus)
PERSONALITY	PAN INVERSE	NO*	
		YES	Inverse DMX pan control: right → left
	TILT INVERSE	NO*	
		YES	Inverse DMX tilt control: down → up
	DIMMER CURVE	LINEAR	Optically linear dimming curve
		SQUARE LAW*	Square law dimming curve
		INV SQ LAW	Inverse square law dimming curve
		S-CURVE	S-curve (fixture emulates incandescent lamp voltage linear RMS dimming curve)
	DIMMER SPEED	FAST*	Snap dimming (fast dimmer speed)
		SLOW	Fade dimming (slow dimmer speed)
	NO DATA MODE	BLACKOUT	If data connection is lost, fixture will blackout
		HOLD*	If data connection is lost, fixture holds latest received data value at all channels
	COOLING MODE	REGULATED FAN*	Fans optimized for light intensity (temperature controlled by regulating fan speed, light output unaffected)
		FULL	Fans set to full constant speed
	DISPLAY	DISPLAY ROTATION (NORMAL* /ROTATE 180)	Display orientation normal/rotated 180°
		DISPLAY INTENSITY (*10-100*)	Set display intensity in % (default = 100)
TEMPERATURE		All temperature readouts in C°/ F°	

Menu	Second-level menu	Sub-menu	Explanation
		UNIT(° C* / ° F)	

Menu	Second-level menu	Sub-menu	Explanation	
DEFAULT SETTINGS	FACTORY DEFAULT	NO*		
		YES	Return all settings (except calibrations) to factory defaults	
FIXTURE Test	TEST ALL	TESTING	Run test sequence of all functions. To test a specific function, use Up/Down buttons to scroll through functions and pause. Press Enter to restart test sequence. Press Menu button to exit test.	
	TEST DIMMER	DIMMER	Run test sequence of LEDs only. To test a specific LED group, use Up/Down buttons to scroll through groups and pause. Press Enter to restart test sequence. Press Menu button to exit test.	
	TEST EFFECTS	CYAN MAGENTA YELLOW COLOR GOBO1 RGOBO1 GOBO2 PRISM RPRISM IRIS ZOOM FOCUS BLADE1 POS BLADE1 ANG BLADE2 POS BLADE2 ANG BLADE3 POS BLADE3 ANG BLADE4 POS BLADE4 ANG BLADE ROT		Run test sequence of effects. To test a specific effect, use Up/Down buttons to scroll through effects and pause. Press Enter to restart test sequence. Press Menu button to exit test.
		TEST PAN/TILT	PAN	Run test sequence of pan functions. Press Menu button to stop test
			TILT	Run test sequence of tilt functions. Press Menu button to stop test
INFORMATION		POWER ON TIME		Display hours fixture has been powered on since manufacture (not user-resettable)
	LED HOURS		Display number of hours fixture	

Menu	Second-level menu	Sub-menu	Explanation
			LEDs have been powered on since manufacture (not user-resettable)
	SW VERSION		Displays currently active software version
	FIXTURE ID	0-9999	User-settable fixture ID number
	RDM UID		Displays fixture's unique RDM ID
	TEMPERATURES	LED / CPU TEMP	Displays temperature in °C of all PCBs
DMX LIVE	STROBE	0-255	Scroll to see values being received on each DMX channel
	DIMMER		
	DIMMER FINE		
	CYAN		
	MAGENTA		
	YELLOW		
	COLOR		
	GOBO1		
	RGOBO1		
	GOBO2		
	PRISM		
	R-PRISM		
	IRIS		
	ZOOM		
	FOCUS		
	BLADE1 POS		
	BLADE1 ANG		
	BLADE2 POS		
	BLADE2 ANG		
	BLADE3 POS		
BLADE3 ANG			
BLADE4 POS			
BLADE4 ANG			
BLADE ROT			
PAN			
PAN FINE			
TILT			
TILT FINE			
PAN/TILT SPEED			

Menu	Second-level menu	Sub-menu	Explanation
MANUAL CONTROL	RESET	All (NO* / YES)	Reset fixture
		PAN / TILT (NO* / YES)	Reset pan and tilt movement
		EFFECTS (NO* / YES)	Reset of all effects
	STROBE	0-255	
	DIMMER		
	DIMMER FINE		
	CYAN		
	MAGENTA		
	YELLOW		
	COLOR		
	GOBO1		
	RGOBO1		
	GOBO2		
	PRISM		
	R-PRISM		
	IRIS		
	ZOOM		
	FOCUS		
	BLADE1 POS		
	BLADE1 ANG		
	BLADE2 POS		
	BLADE2 ANG		
	BLADE3 POS		
	BLADE3 ANG		
	BLADE4 POS		
	BLADE4 ANG		
	BLADE ROT		
	PAN		
PAN FINE			
TILT			
TILT FINE			
PAN/TILT SPEED			
SERVICE	P/T FEEDBACK	OFF	Disable pan/tilt feedback sensors
		ON*	Enable pan/tilt feedback sensors
	CALIBRATION	PAN	-128 -> 127
		TILT	-128 -> 127
		CYAN	-128 -> 127

Menu	Second-level menu	Sub-menu	Explanation
		MAGENTA	-128 -> 127
		YELLOW	-128 -> 127
		COLOR	-128 -> 127
		GOBO1	-128 -> 127
		RGOBO1	-128 -> 127
		GOBO2	-128 -> 127
		PRISM	-128 -> 127
		RPRISM	-128 -> 127
		IRIS	-128 -> 127
		ZOOM	-128 -> 127
		FOCUS	-128 -> 127
		BLADE1 POS	-128 -> 127
		BLADE1 ANG	-128 -> 127
		BLADE2 POS	-128 -> 127
		BLADE2 ANG	-128 -> 127
		BLADE3 POS	-128 -> 127
		BLADE3 ANG	-128 -> 127
		BLADE4 POS	-128 -> 127
		BLADE4 ANG	-128 -> 127
		BLADE ROT	-128 -> 127
		LOAD DEFAULTS (LOAD)	Load factory default calibration settings
		SAVE SETTING (SAVE)	Replace factory default calibration settings with current calibration settings

Troubleshooting

This section describes a few common problems that may occur during operation and provides some suggestions for easy troubleshooting:

Symptom	Potential cause	Remedies
No light from fixture, or fans not working.	Power supply issue, such as blown fuse, faulty connector or damaged cable.	<p>Ensure that the mains supply is connected and supplying power to the fixture..</p> <p>Check all power connections and cables.</p> <p>Replace the fixture fuse.</p>
One of the control channels is unresponsive or only responds intermittently.	Damaged step motor or cable connection between the head and body.	Contact your Martin authorized distributor or service center for assistance.
Fixture does not respond to DMX control.	Fault in the DMX network due to connector or cable damaged, or incorrect DMX addressing, or potential interference from proximity to a high voltage installation.	<p>Check that the fixture display is flashing to show that DMX is not being received, and if so, check all DMX cables and connections to ensure the integrity of the physical network.</p> <p>Ensure that the DMX network is terminated.</p> <p>Check that the components in the DMX network all use standard DMX polarity.</p> <p>Ensure that the fixture is set to the correct DMX address, one that matches that set on the DMX control device.</p> <p>Check the pins on the connectors from the previous fixture in the DMX network.</p> <p>Attempt to control the fixture with another DMX control device.</p> <p>Move the fixture if it is being operated very close to an unshielded high-voltage installation.</p>

Specifications

Physical

Weight.....22.5 kg (49.6 lbs)
Dimensions 379 x 237 x 632 mm (14.9 x 9.3 x 24.9 in)

Dynamic Effects

Color mixing.....CMY, independently variable 0-100%
Color wheel.....9 color filters plus open
Rotating gobo wheel.....7 gobos plus open, wheel rotation, gobo rotation, indexing and shake
Static gobo wheel.....9 gobos plus open, wheel indexing, rotation and shake
Beam effects.....Rotating three-facet prism
Zoom.....Motorized
Focus.....Motorized
Framing.....Rotatable, +/- 45°, 4 individually controllable blades with variable angle/position
Iris.....0-100%
Electronic 'shutter' effect..... Strobe effect, pulse effects, instant open and blackout
Electronic dimming..... 0 - 100%, four dimming curve options
Pan..... 540°, coarse & fine control and speed
Tilt 260°, coarse & fine control and speed

Control and Programming

Control options..... DMX
RDM.....Implemented
DMX channels 30ch/32ch
Setting and addressing..... Control panel with backlit LCD display
DMX compliance..... USITT DMX512/1990

Optics and Photometric Data

Zoom range..... 10° - 30°
Light source..... 300W LED engine
LED refresh rate..... 1200Hz
Minimum LED lifetime..... 20000 hours (to >70% luminous output)*
CLD variant

Fixture luminous output..... 10000 lumens@ Ta 25°C Ambient
Light engine luminous output..... 24000 lumens@ Ta 25°C Ambient
CRI.....>72
CCT..... 6500 Kelvin

WRM variant

Fixture luminous output..... 6000 lumens@ Ta 25°C Ambient
Light engine luminous output..... 14000 lumens@ Ta 25°C Ambient
CRI.....>96
CCT..... 3200 Kelvin

*Manufacturer's figure obtained under manufacturer's test conditions

Construction

Color.....Black
Housing.....High-impact flame-retardant thermoplastic
Protection rating.....IP 20

Installation

Mounting points.....two quarter-turn brackets for rigging clamps
Location.....Indoor use only, must be fastened to surface or structure
Orientation.....Any

Connections

AC power input.....	Neutrik True1 PowerCon
AC power throughput.....	Neutrik True1 PowerCon
DMX data in/out.....	3-pin & 5-pin locking XLR

Electrical

AC power.....	100-240V nominal, 50/60 Hz
Power supply unit.....	Auto-ranging electronic switch mode
Fuse.....	T 10 A

Typical power and current

120V, 60Hz.....	3.8A, 455W, PF 0.992
230V, 50Hz.....	1.96A, 442W, PF 0.968

Measurements made at nominal voltage with all LEDs at full intensity. Allow for a deviation of +/- 10%.

Approvals

EU safety.....	EN 60598-2-17 (EN 60598-1), EN 62471, EN 62493
EU EMC.....	EN 55015; EN 55032; EN 55035, EN 61000-3-2, -3, EN 61547
US safety.....	UL 1573
US EMC.....	FCC Part 15 Class B
Canadian safety.....	CSA C22.2 No. 166
Canadian EMC.....	ICES-003 Class B, ICES-005 Class B
Australia/NZ.....	RCM
Global CB Certification/IECEE:.....	IEC 60598-2-17 (IEC 60598-1)

Thermal

Cooling.....	Forced air (temperature regulated, low noise)
Maximum ambient temperature (T _a max.).....	40° C
Minimum ambient temperature (T _a min.).....	0° C

Included Items

- Power cable, 1.5 m (4.9 ft.) 18AWG/0.75mm² without mains plug
- Omega brackets for rigging clamp attachment

Accessories

Power Input Cables, 16A:

Power Input Cable, H07RN-F, 2.5 mm ² , 14 AWG, Neutrik TRUE1 NAC3FX-W to bare ends, 1.5 m (4.9 ft.).....	P/N 91611797
Power Input Cable, H07RN-F, 2.5 mm ² , 14 AWG, Neutrik TRUE1 NAC3FX-W to bare ends, 5 m (16.4 ft.).....	P/N 91611786
Power Input Cable, SJOOW, AWG 12, Neutrik TRUE1 NAC3FX-W to bare ends, 1.5 m (4.9 ft.).....	P/N 91610173
Power Input Cable, SJOOW, AWG 12, Neutrik TRUE1 NAC3FX-W to bare ends, 5 m (16.4 ft.).....	P/N 91610174

Relay cables, 16 A, for relaying power in chains:

Power Relay Cable, H07RN-F, 2.5 mm ² , Neutrik TRUE1 to TRUE1, 0.45 m (1.5 ft.).....	P/N 91611784
Power Relay Cable, H07RN-F, 2.5 mm ² , Neutrik TRUE1 to TRUE1 1.2 m (3.9 ft.).....	P/N 91611785
Power Relay Cable, H07RN-F, 2.5 mm ² , Neutrik TRUE1 to TRUE1 2.5 m (8.2 ft.).....	P/N 91611796
Power Relay Cable, SJOOW, AWG 12, Neutrik TRUE1 to TRUE1, 0.45 m (1.5 ft.).....	P/N 91610170

Power Relay Cable, SJOOW, AWG 12, Neutrik TRUE1 to TRUE1,
 1.2 m (3.9 ft.)..... P/N 91610171
 Power Relay Cable, SJOOW, AWG 12, Neutrik TRUE1 to TRUE1,
 2.5 m (8.2 ft.)..... P/N 91610172
Power connectors:
 Neutrik PowerCON TRUE1 NAC3MX-W (male)..... P/N 91611788
 Neutrik PowerCON TRUE1 NAC3FX-W (female)..... P/N 91611789
Flightcase:
 Flightcase 2 x ERA 400..... P/N 915111217

Ordering Information

ERA 400 Performance CLD in cardboard box: P/N 9025121796
 ERA 400 Performance WRM in cardboard box: P/N 9025121795

Specifications are subject to change without notice. For the latest product specifications, see www.martin.com

	<p>Disposing of this product</p> <p>Martin products are supplied in compliance with Directive 2012/19/EC of the European Parliament and of the Council of the European Union on WEEE (Waste Electrical and Electronic Equipment), where applicable. Help preserve the environment! Ensure that this product is recycled at the end of its life. Your supplier can give details of local arrangements for the disposal of Martin products</p>
---	---

FCC Compliance

Note: This equipment has been tested and found to comply with the limits for a Class B digital device, pursuant to part 15 of the FCC Rules. These limits are designed to provide reasonable protection against harmful interference in a residential installation. This equipment generates, uses and can radiate radio frequency energy and, if not installed and used in accordance with the instructions, may cause harmful interference to radio communications. However, there is no guarantee that interference will not occur in a particular installation. If this equipment does cause harmful interference to radio or television reception, which can be determined by turning the equipment off and on, the user is encouraged to try to correct the interference by one or more of the following measures:

- Reorient or relocate the receiving antenna.
- Increase the separation between the equipment and receiver.
- Connect the equipment into an outlet on a circuit different from that to which the receiver is connected.
- Consult the dealer or an experienced radio/TV technician for help.

Supplier's Declaration of Conformity

Harman Professional, Inc. have issued an FCC Supplier's Declaration of Conformity for this product. The Declaration of Conformity is available for download from the ERA 400 Performance CLD, ERA 400 Performance WRM of the Martin website at <http://www.martin.com>

Photobiological Safety Warning

The label shown below is displayed on this product. If it becomes difficult or impossible to read, it must be replaced using the illustration below to reproduce a new label sized 45 x 37 mm / 45 x 27 mm, in black on a yellow background.

ERA 400 Performance CLD



ERA 400 Performance WRM





www.martin.com · Harman Professional Solutions · 8500 Balboa Blvd · Northridge
CA 91329 · United States