



LN™1263 Column ARRAY



Specifications



FCC/ICES Compliancy Statement

This device complies with Part 15 of the FCC rules and Industry Canada license-exempt RSS Standard(s). Operation is subject to the following two conditions: (1) this device may not cause harmful interference, and (2) this device must accept any interference received, that may cause undesired operation.

Le présent appareil est conforme aux CNR d'Industrie Canada applicables aux appareils radio exempts de licence. L'exploitation est autorisée aux deux conditions suivantes: (1) l'appareil ne doit pas produire de brouillage, et (2) l'utilisateur de l'appareil doit accepter tout brouillage radioélectrique subi, même si le brouillage est susceptible d'en compromettre le fonctionnement.

Warning: Changes or modifications to the equipment not approved by Peavey Electronics Corp. can void the user's authority to use the equipment.

Note – This equipment has been tested and found to comply with the limits for a Class B digital device, pursuant to Part 15 of the FCC Rules. These limits are designed to provide reasonable protection against harmful interference in a residential installation. This equipment generates, uses, and can radiate radio frequency energy and, if not installed and used in accordance with the instructions, may cause harmful interference to radio communications. However, there is no guarantee that interference will not occur in a particular installation. If this equipment does cause harmful interference to radio or television reception, which can be determined by turning the equipment off and on, the user is encouraged to try and correct the interference by one or more of the following measures.

- Reorient or relocate the receiving antenna.
- Increase the separation between the equipment and receiver.
- Connect the equipment into an outlet on a circuit different from that to which the receiver is connected.
- Consult the dealer or an experienced radio/TV technician for help.

Caution

The equipment complies with FCC radiation exposure limits set forth for an uncontrolled environment.



Features and specifications are subject to change without notice.

Peavey Electronics Corporation • 711 A Street • Meridian, MS 39301
(601) 483-5365 • FAX (601) 486-1278 • www.peavey.com

FCC Radiation Exposure Statement

This equipment complied with FCC radiation exposure limits set forth for an uncontrolled environment. This equipment should be installed and operated with minimum distance 20cm between the radiator & your body.

IC Radiation Exposure Statement

This equipment complies with IC radiation exposure limits set forth for an uncontrolled environment. The antenna should be installed and operated with minimum distance of 20 cm between the radiator and your body. This transmitter must not be co-located or operating in conjunction with any other antenna or transmitter.

Cet appareil est conforme aux limites d'exposition aux rayonnements de la IC pour un environnement non contrôlé. L'antenne doit être installé de façon à garder une distance minimale de 20 centimètres entre la source de rayonnements et votre corps. L'émetteur ne doit pas être colocalisé ni fonctionner conjointement avec à autre antenne ou autre émetteur.

LN™1263

Column Array Powered Speaker System

Congratulations on purchasing the Peavey LN™1263 Column Array Powered Speaker System. This compact, portable and powerful system is a perfect solution for the weekend warrior, singer songwriter or DJ.

FEATURES:

- Bluetooth audio control via iOS app
- Bluetooth audio input for streaming music from any Bluetooth device
- 6 Channel mixer
- 4 Combi inputs with Guitar Channel selectability
- 4 Onboard guitar channels
- 1 1/4" Stereo input channel
- 3.5 mm input
- Professional and Simple modes
- Stereo capable
- Onboard LCD display
- 7 EQ presets
- 8 FX
- Compressor per channel
- Independent sub level control
- Mute and line indicators per channel
- Mix out for additional units
- Security lock
- Save and store scene presets
- Aluminum satellite chassis
- Birch ply subwoofer
- Satellite speaker carrying bag included
- 1,200 Watts maximum power
- 127 dB maximum SPL
- Frequency response 35 Hz - 20 kHz

Description:

The LN™1263 is a compact, powerful, lightweight and low profile portable column-array. Utilizing 1200 watts of potential maximum power, the unit contains 12 2.75" custom drivers for the mid-high column and a custom 12" driver for the subwoofer. Completely self contained, the unit has no visible cables in mono operation. Its clean design is well suited for applications where speakers should be heard and not seen. Coming in at 10lbs lighter than our nearest competitor, the LN1263 is extremely easy to carry: an entire PA system that can be moved by one person in one trip.

The satellite speakers feature rugged aluminum housing and quick attachment design. The subwoofer is built from multi-ply birch, making it both durable and lightweight. Each satellite features a speaker stand and a twist lock speaker cable connection, allowing the satellite to be positioned remotely for applications where stereo configuration or additional coverage is desired.

Modern DSP makes this unit extremely easy to use and operate. Featuring both an onboard LCD screen and remote control via Bluetooth using a custom iOS application for control, the LN1263 is state of the art. In addition to conventional features such as EQ and Effects, the app includes Simple and Professional mode, allowing more advanced users complete control while simplifying features like compression for novice users.

The onboard mixer features 4 combo inputs, each with the option of selecting a guitar input, making this the first column array designed specifically with the acoustic guitar performer in mind. Two additional media channels feature stereo 1/4" inputs and streaming audio Bluetooth in. This unique Bluetooth input can handle a separate device other than the one controlling the array. Features also include seven onboard EQ presets and eight onboard effects, with the ability to save and lock scenes along with an independent sub level control. Perfect for church, convention, DJ or club applications, the LN1263 offers the best-in-class feature-to-value and performance in the industry.



Installation Note:

This unit must have the following clearances from any combustible surface: top: 8", sides: 12", back: 12"

Top Panel

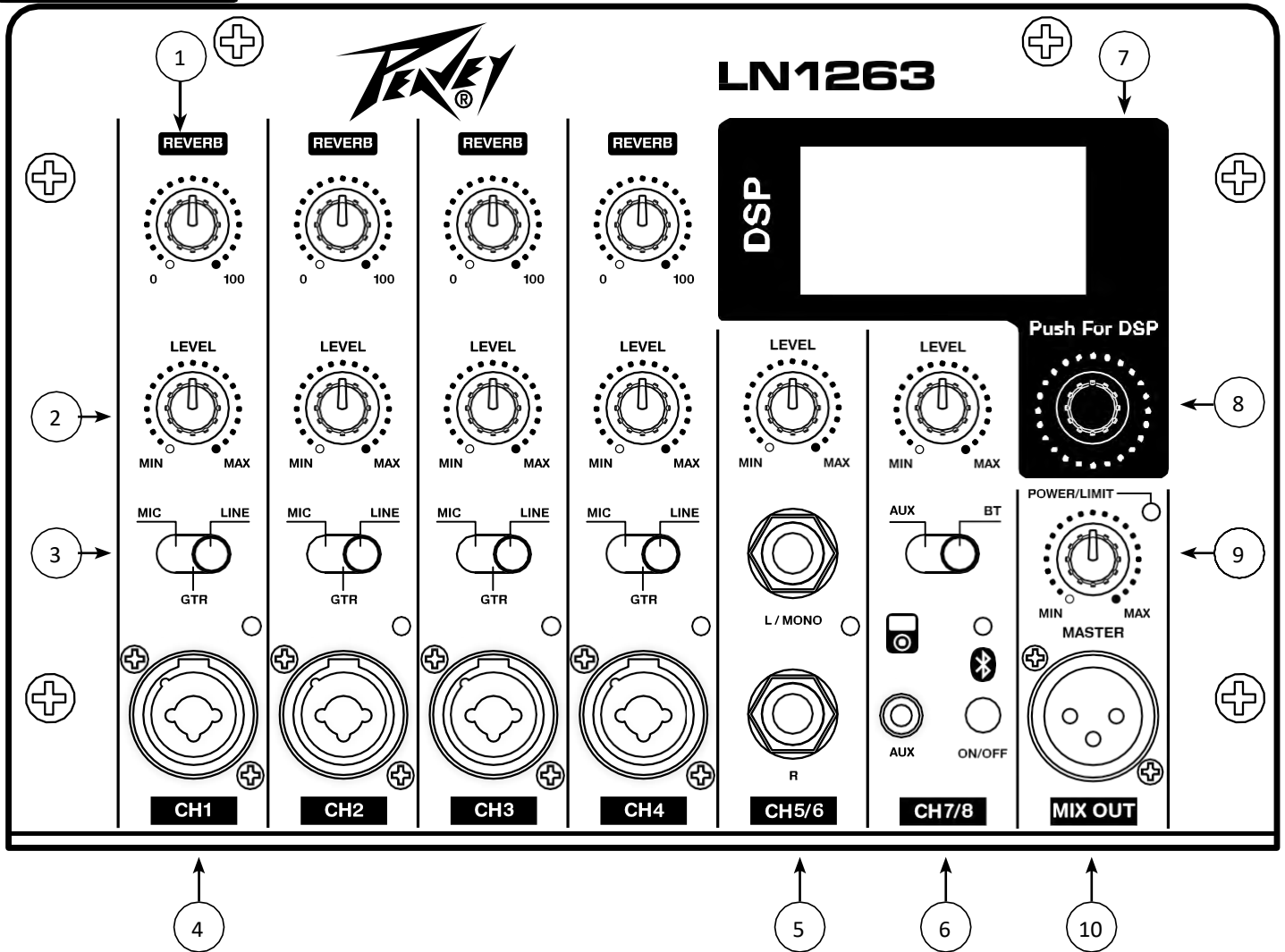

(1) Channel Reverb Control

This knob controls the amount of reverb for the corresponding channel (channels 1-4).

(2) Channel Level Control

This knob controls the volume of the specific channel.

(3) Input Select Switch

This switch allows the user to select between MIC, Guitar or LINE INPUT (channels 1-4).

(4) Channel Input

XLR combi 1/4" input.

(5) Channel 5/6 Input

Features 1/4" stereo inputs.

(6) Channel 7/8 Controls

Features 1/8" stereo input (for a portable MP3 player or other media device) and Bluetooth streaming capability. The input is selected via the input select switch. Bluetooth operation is controlled by the on/off switch. In Bluetooth mode, the LN1263 can be controlled remotely via the iOS LN1263 App (See page 7).

(7) LCD Display for DSP

Provides a menu read-out manipulated and activated by the Push-To-Select button (8)

(8) Push-To-Select knob

Rotary knob that allows the user to select and choose menu options on the LCD display screen (7). Pushing the button in till it detents makes a menu choice.

(9) Master Volume

Controls the overall volume. Features a POWER/CLIPPING LED that shines green, when power is applied. It turns RED when any of the power amps clip, or when the input channel is overloaded.

(10) Mix Out

Non-powered XLR line level out for linking systems together.

Rear Panel

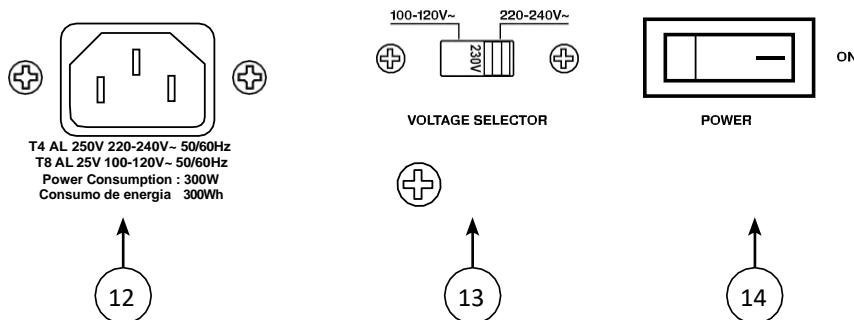
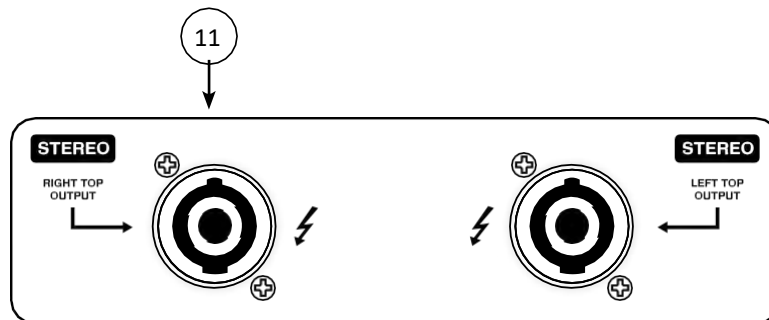

(11) Outputs to Satellite Speakers

Stereo outputs for the satellite speakers.

(12) AC POWER INLET

 This is the receptacle for an IEC line cord, which provides AC power to the unit. Connect the line cord to this connector to provide power to the unit. Damage to the equipment may result if improper line voltage is used. (See line voltage marking on unit).

 Never break off the ground pin on any equipment. It is provided for your safety. If the outlet used does not have a ground pin, a suitable grounding adapter should be used and the third wire should be grounded properly. To prevent risk of shock or fire hazard, always make sure that the amplifier and all associated equipment is properly grounded.

(13) LINE VOLTAGE SELECT SWITCH

This selector switch allows the amplifier to be operated at different line voltages. Please be sure this switch is set to the proper voltage for your area before connecting the amplifier to a power source or turning the amplifier on for the first time.

 NEVER CHANGE THE POSITION OF THIS SWITCH WHILE THE System IS TURNED ON.

(14) ON-OFF SWITCH

This rocker switch supplies AC power to the system when switched to the ON position. The ON position is with the right side of the switch pushed “in” or nearly flush with the rear panel.

Bluetooth Function

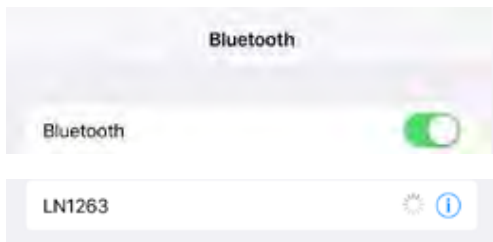

In order to utilize the Bluetooth control function of the LN™ 1263, download the Peavey® LN™ 1263 app onto your iOS device. Connect your device via Bluetooth to the LN™ 1263.

App Controls

LN™1263 app for iOS devices available at:



Main Mixer Control



Main Mixer Control Screen- This screen is the main control hub for the unit, and is comprised of the following controls

Pressing the Help Button (24) on the bottom of any screen will give the user a detailed explanation of the features of that particular control panel. This feature makes controlling the unit simple for a novice, and offers access to more detailed editing functions for the professional.





Simple Channel Control



Individual Channel Equalization (Simple Mode)



Professional EQ Control



Individual Channel Equalization (Professional Mode)



Professional Compressor





Master Output Controls





Scene Storage





While the LN1263 is designed to operate with the LN1263 app, it is possible to operate the unit using only the LCD screen on the control panel to access basic controls.

Use the rotary knob (8) to select and choose the following menu options on the LCD. Pushing the button in till it detents makes a menu choice.





The LN1263 comes loaded with the following EQ presets for quick and easy optimization. These Presets are accessible from the LCD display.

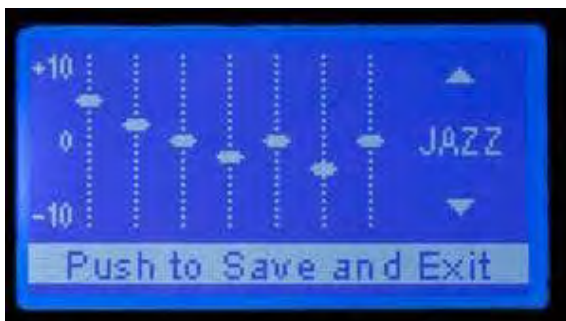
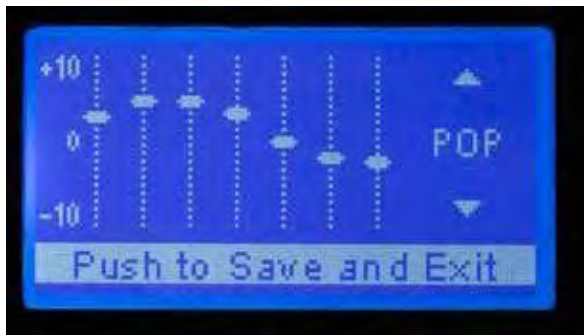

LN™1263 app for iOS devices available
at:



LN™1263 Specifications

Channel 1-4 Input:	Mic/Line/Guitar XLR and 1/4-inch TRS (balanced)
Channel 5 Left/Mono Input:	Mono/stereo (unbalanced) 1/4-inch TRS
Channel 6 Right Input:	Mono/Stereo (unbalanced) 1/4-inch TRS
Mix Out:	+4dBu XLR (balanced)
Power/Clip LED:	Green/Red
Peak Power:	1200 Watts
Frequency Response:	35-20kHz
Max Output SPL:	127 dB
Column Speaker:	12 x 2.75" drivers
Upper Column Weight:	5.5lbs. (2.5 kgs)
Upper Column Dimensions:	4.76 x 3.75 x 18.5 inches 121 x 95.5 x 470 mm
Lower Column Weight:	5.5 lbs. (2.5 kgs)
Lower Column Dimensions:	4.76 x 3.75 x 18.75 inches 121 x 95.5 x 476 mm
Sub Speaker:	12" woofer, 2.5" voice coil
Sub/Mixer Weight:	48.4 lbs. (22 kgs)
Sub/Mixer Dimensions:	19.7 x 13.75 x 20.24 inches 500 x 350 x 514 mm
Power Input (switchable):	100-120V, 50/60Hz, 300 W 220-240V, 50/60Hz, 300 W



www.peavey.com

Warranty registration and information for U.S. customers available online at
www.peavey.com/warranty
or use the QR tag below



Features and specifications subject to change without notice.

Peavey Electronics Corporation 5022 Hartley Peavey Drive Meridian, MS 39305 (601) 483-5365 FAX (601) 486-1278



Logo referenced in Directive 2002/96/EC Annex IV
(OJ(L)37/38,13.02.03 and defined in EN 50419: 2005
The bar is the symbol for marking of new waste and
is applied only to equipment manufactured after
13 August 2005