

Instruction Manual

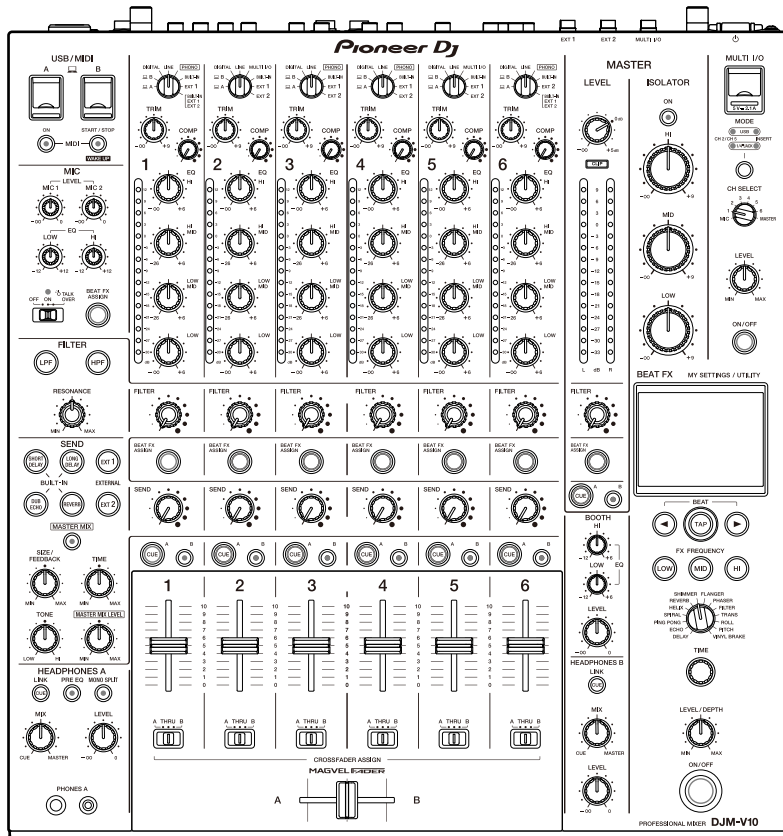

DJ Mixer

DJM-V10

pioneerdj.com/support/

rekordbox.com

kuvo.com

For FAQs and other support information for this product, visit the websites above.

Pioneer Dj

Contents

Before you start	5
How to read this manual	5
What's in the box.....	5
User guides	6
PRO DJ LINK	7
Part names	8
Top panel	8
Front panel	9
Rear panel.....	9
Touch display	12
PC/Mac setup	13
Audio driver software	13
Installation	14
Setting Utility	15
Connections	20
Connecting to the input terminals.....	20
Connecting to the output terminals	21
Connecting to the terminals on the top and front panels.....	22
Connecting external FX units	23
Audio output	25
Channel section/MASTER section	26
Outputting sound.....	29
Adjusting the sound.....	30
Setting the fader curves	30
Adjusting the left/right sound balance	32
MASTER ISOLATOR	34
MASTER ISOLATOR section.....	34

Adjusting the master sound.....	35
Monitoring sound	36
HEADPHONES A/B sections	36
Monitoring with headphones	38
BOOTH section	39
Using a booth monitor	39
Microphones	40
MIC section	40
Using a microphone	41
FILTER	42
FILTER section	42
Using the FILTER.....	43
SEND	44
SEND section	44
Routing effect sounds to the channels	45
Routing effect sounds to the master output	47
SEND types and settings	49
MULTI I/O	51
MULTI I/O section	53
Using MULTI I/O	54
BEAT FX	55
BEAT FX section	56
Touch display	57
Using BEAT FX.....	59
Setting the BPM manually.....	60
BEAT FX types and settings	61
USB/MIDI.....	66
USB/MIDI section	66
Controlling MIDI software	67

Controlling an external MIDI sequencer	68
Settings.....	69
[UTILITY]/[MY SETTINGS] screens	69
Changing the settings	70
UTILITY settings	71
MY SETTINGS	74
Saving MY SETTINGS to a storage device	78
Calling up MY SETTINGS saved on a storage device	79
Restoring the factory settings.....	80
Specifications	81
Block diagram	84
Additional information	85
Troubleshooting	85
LCD display	88
Trademarks and registered trademarks	89
Software license notice	90
Cautions on copyrights.....	91

Before you start

How to read this manual

- Thank you for choosing this Pioneer DJ product.
Be sure to read this manual, the “Quick Start Guide” and the “Precautions for Use” which are also included with this product. These documents include important information that you should understand before using the unit. In particular, be sure to read the IMPORTANT SAFETY INSTRUCTIONS.
- In this manual the names of buttons, knobs and terminals that appear on the product, and the names of buttons, menus etc. in the software on your PC/Mac or mobile device, are indicated within square brackets ([]). (e.g. **[File]**, **[CUE]** button)
- Please note that the software screens and their specifications, as well as the external appearance and specifications of the hardware, were still under development at the time this manual was created and may differ from the final specifications.
- Please note that depending on the operating system version, web browser settings, etc. operation may differ from the ways described in this manual.
- Please note that the language on the screens of the software described in this manual may differ from the language on your screen.

What’s in the box

- Power cord
- Warranty (for some regions) *
- Quick Start Guide
- Precautions for Use

* Only products in Europe.

Products in North America and Japan include warranty information in the “Precautions for Use”.

User guides

❖ rekordbox: rekordbox Introduction, Instruction Manual

Refer to the “rekordbox Introduction” to find out how to set up rekordbox, and see the “Instruction Manual” to find out how to use rekordbox.

Visit the URL below to find these user guides.

rekordbox.com/manual

PRO DJ LINK

You can use PRO DJ LINK functions by connecting the unit via a LAN cable to a PRO DJ LINK compatible DJ player and a PC/Mac running rekordbox.

- You can connect up to 4 DJ players and up to 2 computers (PC/Mac) to the unit via a switching hub.
- Use a 100BASE-TX compatible switching hub that is supported by DJ players. Some switching hubs may not work properly with selected devices.
- Set the DJ player number to the channel number which the audio cable is connected to.

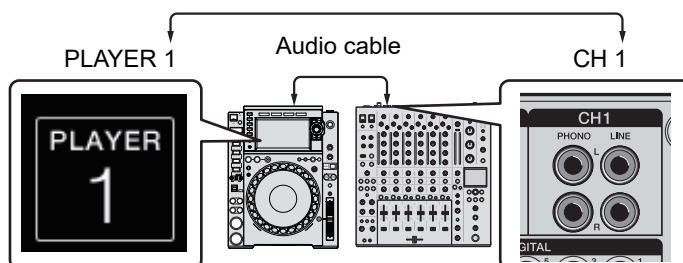

- For details on PRO DJ LINK, see the instruction manuals for the relevant DJ players and rekordbox.

pioneerdj.com/support/

❖ Quantize

When you are playing a track analyzed by rekordbox, the unit adds BEAT FX by automatically synchronizing it with the beat according to the track's grid information. This happens even if you operate the [ON/OFF] button of [BEAT FX] and [X-PAD] roughly.

❖ LINK MONITOR

You can browse and monitor via headphones the sound of tracks in rekordbox on a PC/Mac while playing a different track (page 36).

- To monitor the sound of rekordbox, click [Preferences] > [Audio] and mark the [Use "LINK MONITOR" of PIONEER DJ Mixers] check box in rekordbox.

❖ STATUS INFORMATION

You can check on-air information with DJ players.

Part names

Top panel

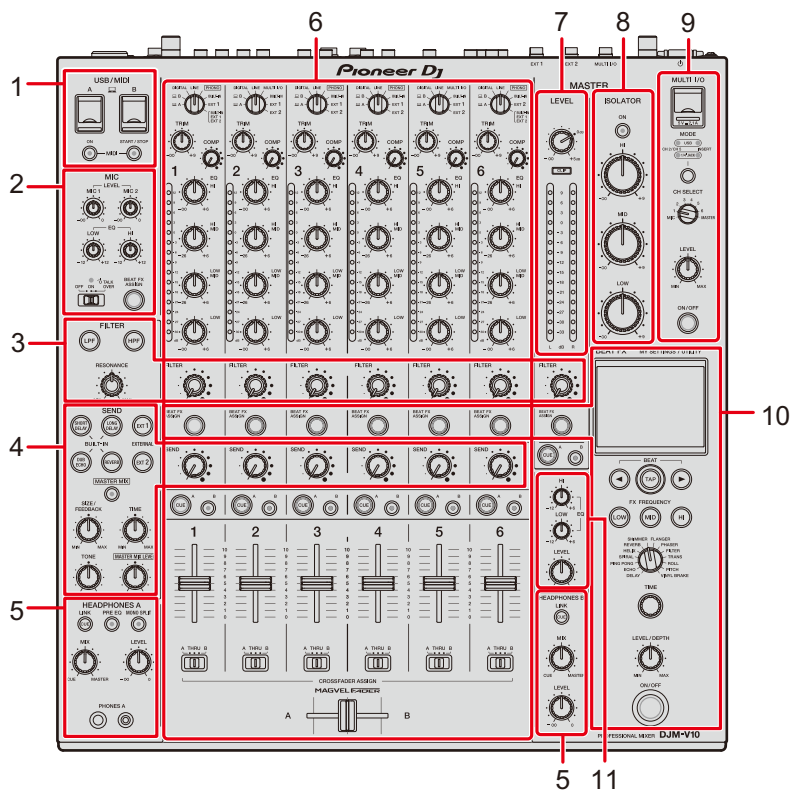

1. **USB/MIDI section** (page 66)
2. **MIC section** (page 40)
3. **FILTER section** (page 42)
4. **SEND section** (page 44)
5. **HEADPHONES (A/B) section** (page 36)
6. **Channel section** (page 26)
7. **MASTER section** (page 26)
8. **MASTER ISOLATOR section** (page 34)
9. **MULTI I/O section** (page 53)
10. **BEAT FX section** (page 56)
11. **BOOTH section** (page 39)

Front panel



1. **PHONES B terminals** (pages 22, 36)

Rear panel

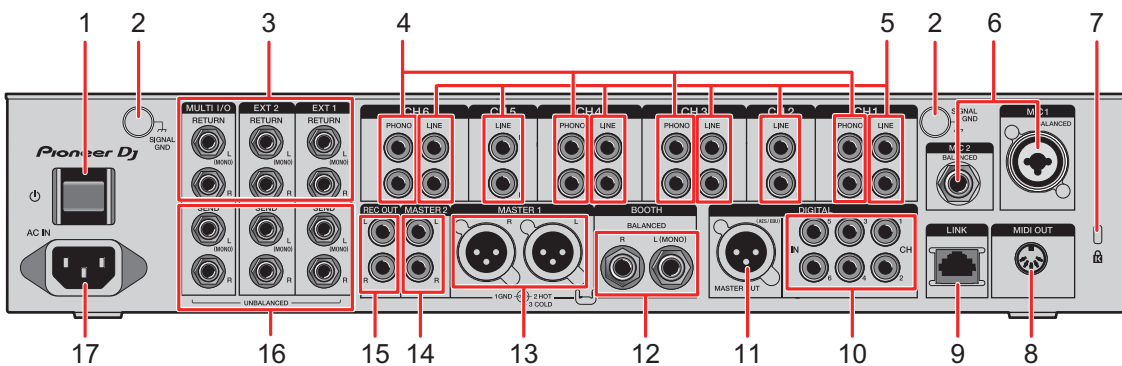

1. **⏻ button**
Turns the unit on and off.
2. **SIGNAL GND terminals** (page 20)
Connect a turntable's ground wire.
Reduces noises that occur when a turntable is connected to the unit.
3. **MULTI I/O, EXT2, EXT1 RETURN terminals (1/4"/6.35 mm, TS)** (pages 23, 24)
Connect to output terminals on external FX units.
 - If you connect equipment to the [L (MONO)] terminal only, the sound input to the [L (MONO)] terminal is also input to the [R] channel.
4. **PHONO terminals (RCA)** (page 20)
Connect phono-level (MM cartridge) output devices.
 - Do not input line-level signals to the terminals.

- Remove the short-circuit pin plugs from the terminals when connecting devices. When you are not using the terminals, attach the short-circuit pin plugs to cut out external noises.

 **WARNING**

Keep the short-circuit pin plugs out of the reach of children and infants. If accidentally swallowed, contact a doctor immediately.

5. **LINE terminals (RCA)** (page 20)
Connect DJ players or line-level output devices.
6. **MIC1 terminal (XLR or 1/4"/6.35 mm, TRS), MIC2 terminal (1/4"/6.35 mm, TRS)** (page 20)
7. **Kensington security slot**
Connect a cable lock.
8. **MIDI OUT (5-pin DIN)** (pages 21, 68)
9. **LINK terminal** (pages 7, 20)
Connect to a LINK terminal on a PC/Mac running rekordbox or a DJ player from Pioneer DJ.
 - Use a switching hub (100BASE-TX compatible type) to connect multiple devices.
10. **DIGITAL IN CH terminals (RCA)** (page 20)
Connect to a digital coaxial output terminal on a DJ player, etc.
 - Sound may break when the output signal's sampling frequency changes.
11. **DIGITAL MASTER OUT terminal (XLR (AES/EBU))** (page 21)
Connect to a digital terminal on a preamplifier, etc.
Outputs the master sound in AES/EBU format.
 - Do not connect to an analog input terminal or connect a power cord from another product to this terminal.
12. **BOOTH terminals (1/4"/6.35 mm, TRS)** (page 21)
Connect a booth monitor.
 - If you connect equipment to the [L (MONO)] terminal only, mono sound is output.
13. **MASTER1 terminals (balanced XLR)** (page 21)
Connect to analog input terminals on a power amplifier, etc.
 - Use the terminals for balanced output only.
 - Do not connect a power cord from another product to the terminals.

14. **MASTER2 terminals (RCA)** (page 21)

Connect to analog input terminals on a power amplifier, etc.

15. **REC OUT terminals (RCA)** (page 21)

Connect a device for recording.

16. **MULTI I/O, EXT2, EXT1 SEND terminals (1/4"/6.35 mm, TS)** (pages 23, 24)

Connect to input terminals on external FX units.

- If you connect equipment to the [L (MONO)] terminal only, mono sound is output.



17. **AC IN** (page 20)

Connect to a power outlet with the supplied power cord.

Touch display

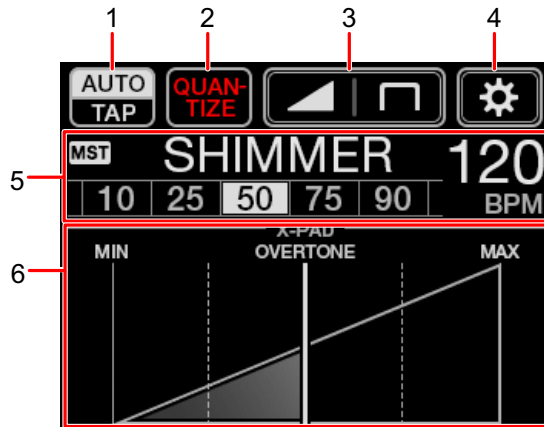
Main screen (display/touch keys)



1. **AUTO/TAP** (page 57)
2. **QUANTIZE** (page 55)
3.  (**fader curve settings**) (page 30)
4.  (**UTILITY/MY SETTINGS**) (page 70)
5. **Effect settings display** (page 57)
6. **X-PAD** (page 57)

PC/Mac setup

Audio driver software

To input or output your PC/Mac's audio to/from the unit, install the dedicated audio driver software on your computer.

Setting Utility will also be installed with the audio driver software.

❖ Supported OS

- macOS Catalina 10.15 (updated to the latest version)
 - macOS Mojave 10.14 (updated to the latest version)
 - macOS High Sierra 10.13 (updated to the latest version)
 - macOS Sierra 10.12 (updated to the latest version)
 - Windows® 10, 8.1 (the latest service pack)
-
- Operation is not guaranteed on all PC/Mac models, even if the system requirements are met.
 - Operation is not guaranteed when multiple units are connected to a PC/Mac.
 - If a PC/Mac without the audio driver software installed is connected to the unit, errors may occur on the PC/Mac.
 - Malfunctions may occur due to incompatibility with other software installed on a PC/Mac.

Installation

❖ Notes on installation

- Turn the unit off and disconnect the USB cable connected to the unit and the PC/Mac before installation.
- Close all applications running on the PC/Mac before installation.
- You will need admin rights to install the audio driver software to your PC/Mac.
- Read the License Agreement terms carefully before installation.
- If you quit the installation halfway through, perform the installation procedure from the beginning again.

Downloading the audio driver software

Download the dedicated audio driver software to your PC/Mac from the URL below.

pioneerdj.com/support/

Installing the audio driver software

- 1 Double-click the downloaded installation file.**
- 2 Read the License Agreement terms carefully.**
If you agree to the terms, mark the [Agree] check box and click [OK].
 - If you do not agree to the License Agreement terms, click **[Disagree]** (for Mac)/**[Cancel]** (for Windows) to cancel the installation.
- 3 Follow the on-screen instructions to complete the installation.**

Setting Utility

You can check and set connections between the unit and a PC/Mac using the Setting Utility installed on the PC/Mac.

Launching Setting Utility

- 1 Click **[Pioneer] > [DJM-V10 Setting Utility]** from the applications list on a PC/Mac.

Setting Utility launches.

Checking the status of the input selector switches on the unit

- 1 Click the **[MIXER INPUT]** tab.

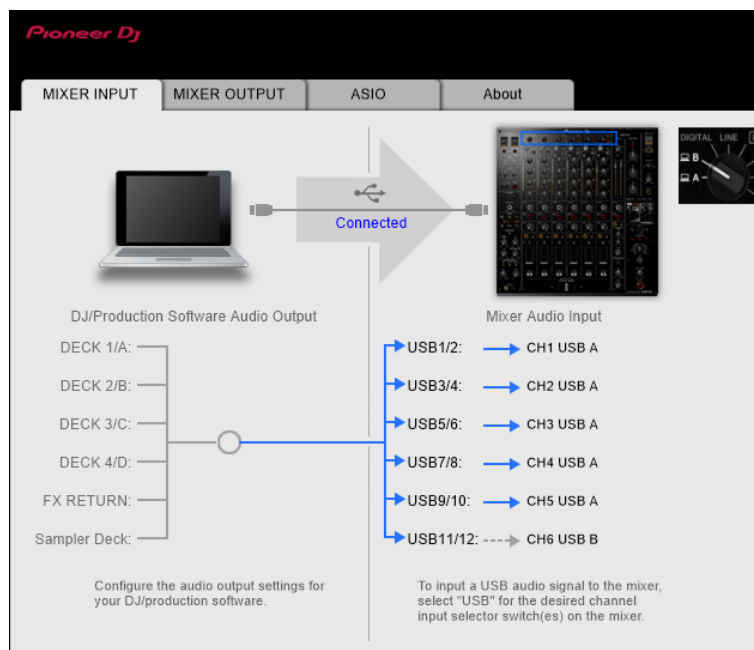

Setting the audio data output from the unit to a PC/Mac

- 1 Click the **[MIXER OUTPUT]** tab.
- 2 Click the pull-down menu under **[Mixer Audio Output]** and select the audio data output from the unit to the PC/Mac.

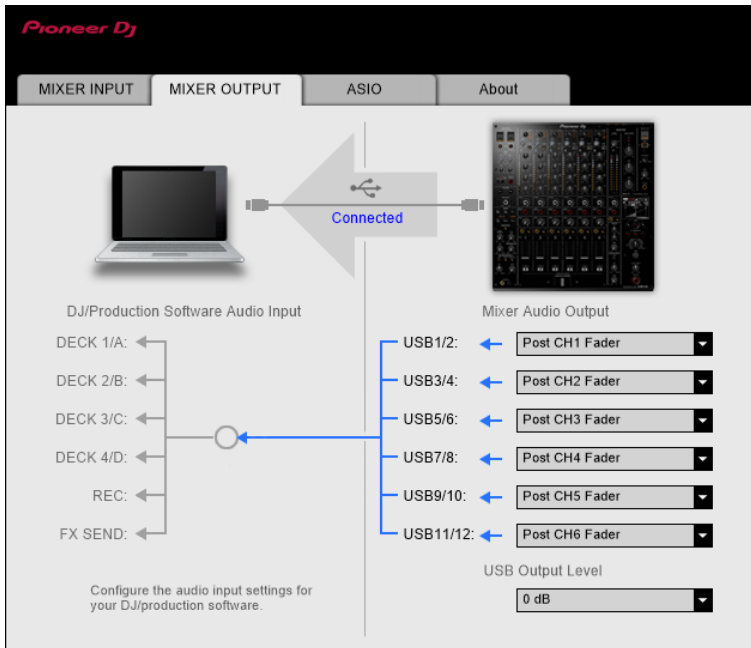

➤ Read more: **[Mixer Audio Output]** pull-down menu (page 19)

- 3 Click the pull-down menu under **[USB Output Level]** and select a level of volume output from the unit.

- Set the volume in **[USB Output Level]** when you cannot produce as much volume as you expect using the volume adjustment in your DJ application. Note that the sound may be distorted if you set the volume too high.

Adjusting the buffer size (for Windows ASIO)

- Close any running applications (DJ applications, etc.) which use the unit as the default audio device before adjusting the buffer size.

1 Click the [ASIO] tab.

2 Adjust the buffer size with the slider.

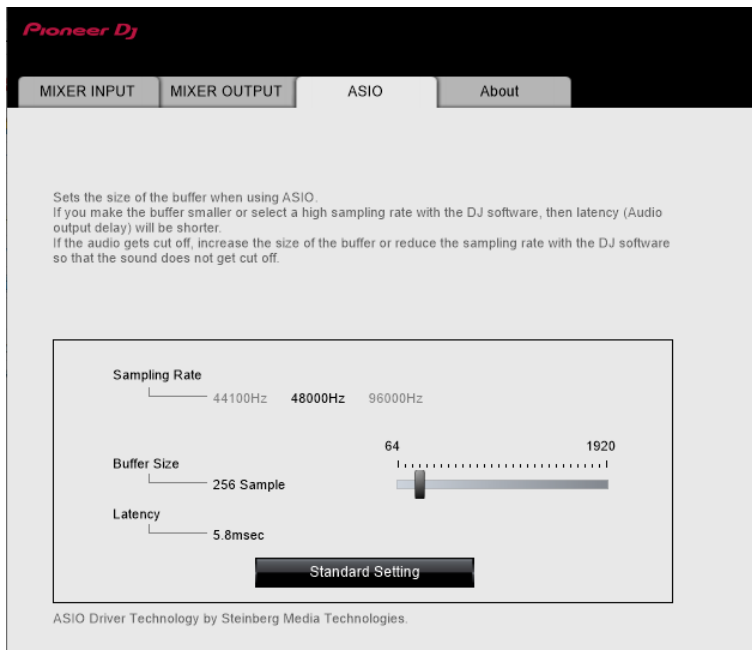

- Breaks in sound are less likely to occur if you set a large buffer size, but this increases time lag due to the latency of audio data transmission.

Checking the firmware and software versions

1 Click the [About] tab.

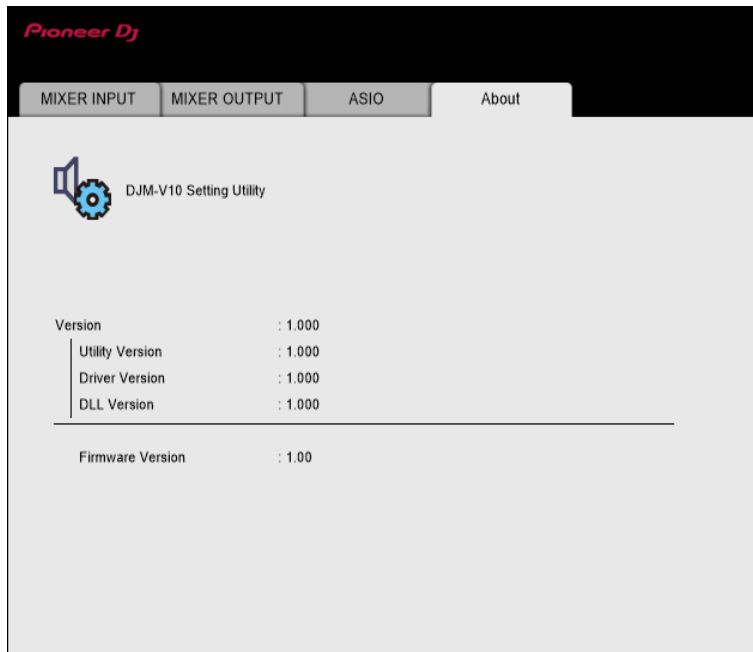

[Mixer Audio Output] pull-down menu

#: indicates channel number

CH1 (USB1/2), CH3 (USB5/6), CH4 (USB7/8), CH6 (USB11/12)	CH2 (USB3/4), CH5 (USB9/10)
CH# Control Tone PHONO ¹	—
CH# Control Tone LINE ¹	CH# Control Tone LINE ¹
CH# Control Tone DIGITAL ¹	CH# Control Tone DIGITAL ¹
Post CH# Fader	Post CH# Fader
FX SEND(for rekordbox dj) ²	FX SEND(for rekordbox dj) ²
CROSSFADER A	CROSSFADER A
CROSSFADER B	CROSSFADER B
MIC	MIC
MIX(REC OUT) ³	MIX(REC OUT) ³
EXT1(SEND EXTERNAL) ³	EXT1(SEND EXTERNAL) ³
EXT2(SEND EXTERNAL) ³	EXT2(SEND EXTERNAL) ³

- ¹ Available for software applications that support the function. Outputs sound at the volume input to the unit regardless of the [USB Output Level] setting.
- ² Available for software applications that support the function.
- ³ For uses other than recording, be sure to set the DJ application so that no sound loop occurs. Sound may be input or output at an unintended volume level when a sound loop occurs.

Connections

Turn the unit off and disconnect the power cord before connecting other units.

Connect the power cord after all the connections are complete.

- Use the supplied power cord.
- Read the instruction manuals for the devices you are going to connect with the unit.
- Use an STP (CAT5e shielded) LAN cable for the LAN connection.
- Do not disconnect a LAN cable when using PRO DJ LINK.

Connecting to the input terminals

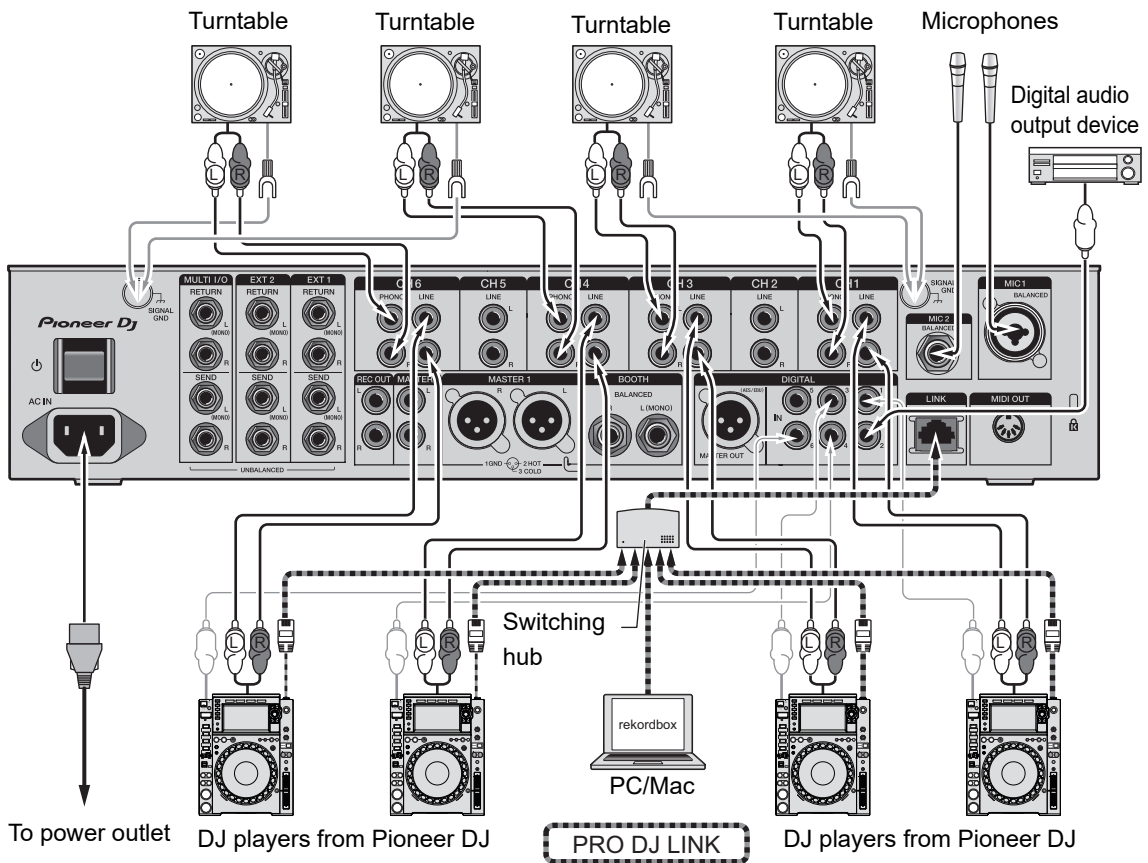

 Read more: PRO DJ LINK (page 7)

Connecting to the output terminals

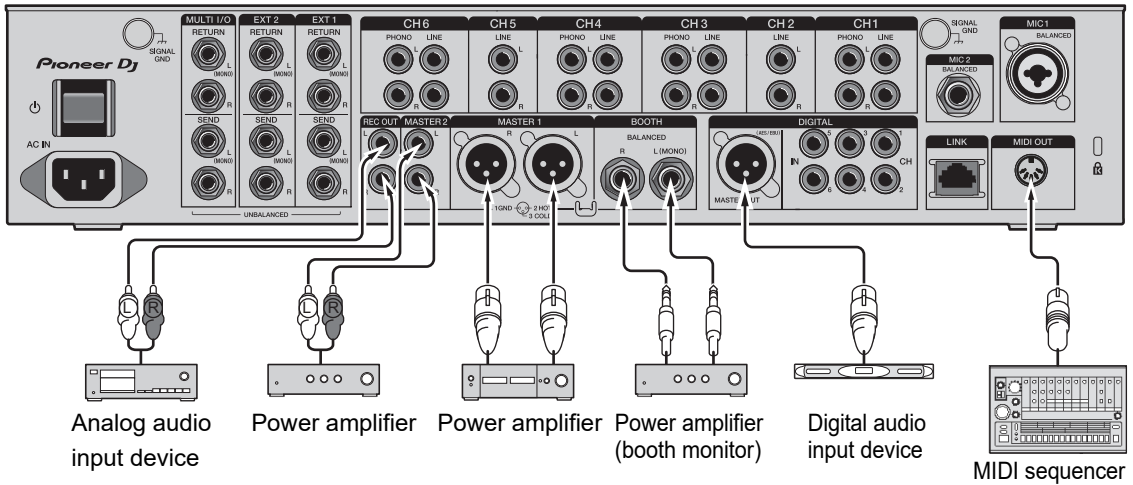

- Use the **[MASTER1]** terminals for balanced output. Connecting the terminals to unbalanced inputs (RCA, etc.) with an XLR-RCA conversion cable (conversion adapter), etc. results in unwanted noises and/or poor sound quality.
- Use the **[MASTER2]** terminals for unbalanced input (RCA, etc.).
- Use the **[BOOTH]** terminals for balanced output. Connecting the terminals to unbalanced inputs results in unwanted noises and/or poor sound quality.
- Do not connect the power cord from another product to the **[MASTER1]** or **[DIGITAL MASTER OUT]** terminals.

Connecting to the terminals on the top and front panels

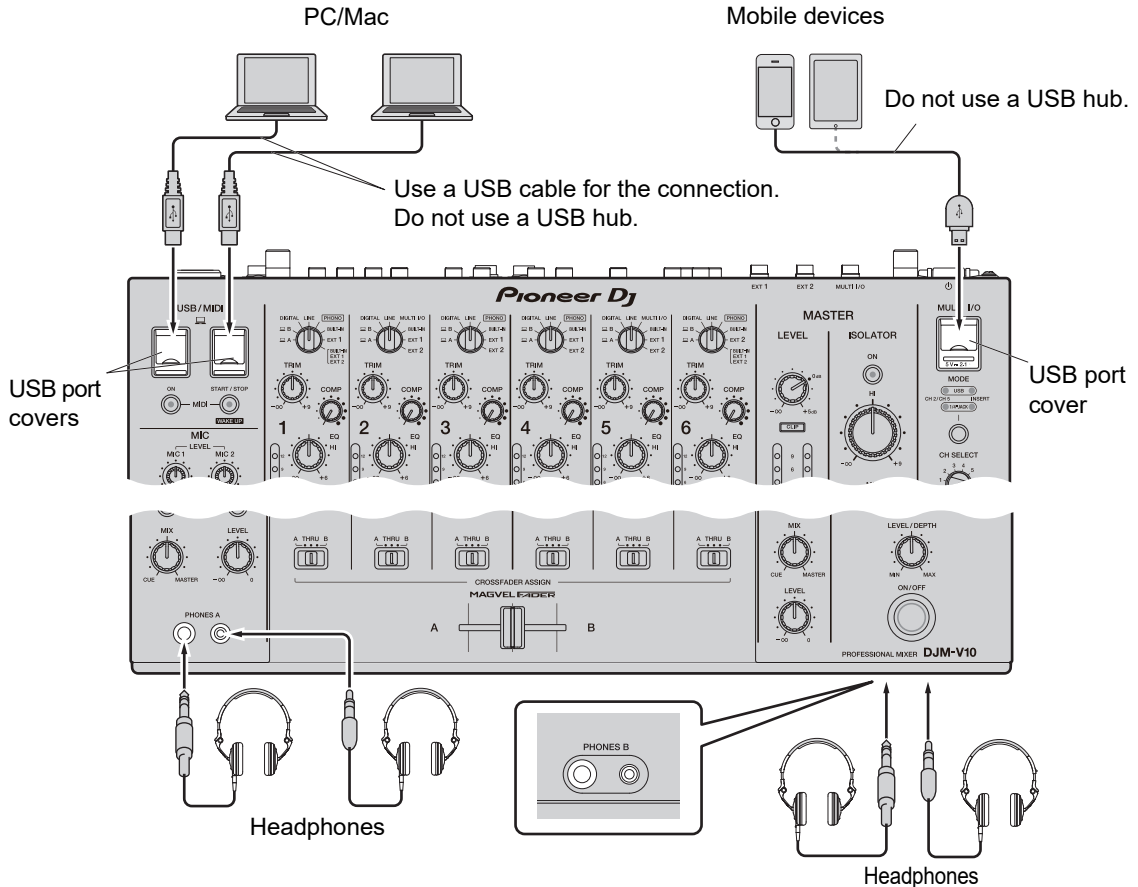

- To input or output your PC/Mac's audio to/from the unit, install the dedicated audio driver software on your computer (page 13).
- Do not press or pull the USB port covers with excessive force, or they may be damaged.
- Use a cable supplied with a mobile device for connecting it to the unit.
- For a list of the mobile devices supported by the unit, visit the URL below.

pioneerdj.com/support/

Connecting external FX units

Connecting to the EXT1/EXT2 terminals

- To use external FX units with SEND, connect as follows.
 - [EXT1 SEND] terminals (output) → FX unit 1 → [EXT1 RETURN] terminals (input)
 - [EXT2 SEND] terminals (output) → FX unit 2 → [EXT2 RETURN] terminals (input)
- Make sure to connect external FX units to the [EXT1 RETURN] or [EXT2 RETURN] terminals (input).
- Use devices that can output only effect sounds.

-----> [EXT1] (SEND/RETURN (1/4" JACK))
 =====> [EXT2] (SEND/RETURN (1/4" JACK))

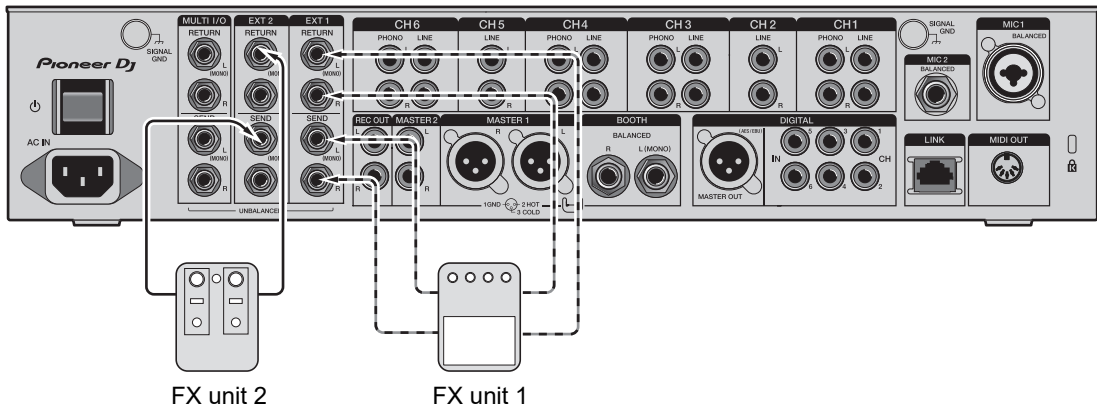

 Read more: SEND (page 44)

Connecting to the MULTI I/O terminals

- To use external FX units or mobile devices with MULTI I/O, connect as follows.
 - [MULTI I/O SEND] terminals (output) → FX unit 3 → [MULTI I/O RETURN] terminals (input)
 - Mobile device connection terminal (USB port) (input/output port) → mobile device
- Make sure to connect external FX units to the [MULTI I/O RETURN] terminals (input).

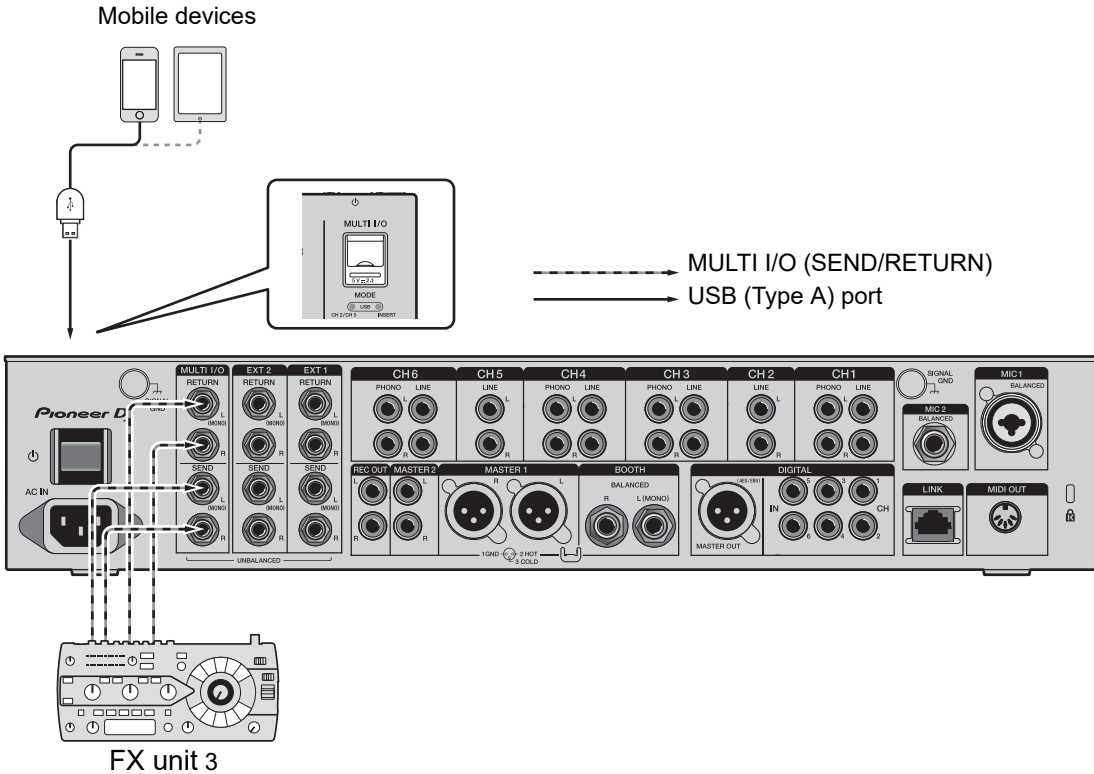

📖 Read more: MULTI I/O (page 51)

Audio output

Follow the procedures below to output and adjust sound.

- Outputting sound (page 29)
- Adjusting the sound (page 30)
- Setting the fader curves (page 30)
- Adjusting the left/right sound balance (page 32)

 To output sound to the **[BOOTH]** terminals, see Using a booth monitor (page 39).

Channel section/MASTER section

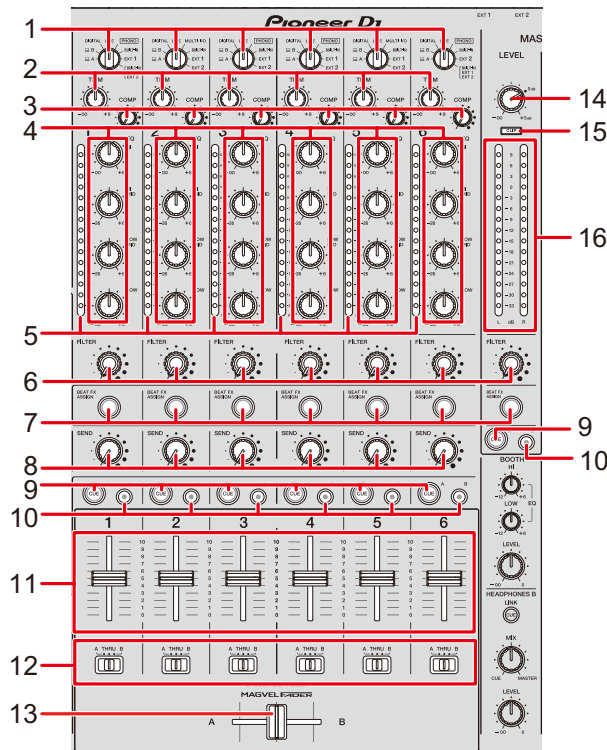

❖ Channel section

1. Input selector switch (pages 45, 51)

Selects an input sound source.

- **[A,B]**: Selects a PC/Mac connected to the **[USB]** port.
- **[DIGITAL]**: Selects a DJ player connected to the **[DIGITAL IN CH]** terminal.
- **[LINE]**: Selects a DJ player, etc. connected to the **[LINE]** terminals.
- **[PHONO]**: Selects a turntable connected to the **[PHONO]** terminals.
- **[MULTI I/O]**: Selects the effect sound input to the **[MULTI I/O]** terminals (for selecting **[MULTI I/O]**, set **[CH 2/CH 5]** with the **[MODE]** selector button in the **[MULTI I/O]** section).
- **[BUILT-IN]**: Selects the **[BUILT-IN]** FX of **[SEND]**.

- **[EXT1]**: Selects the effect sound of a device connected to the **[EXT1 RETURN]** terminals.
 - **[EXT2]**: Selects the effect sound of a device connected to the **[EXT2 RETURN]** terminals.
 - **[BUILT-IN, EXT1, EXT2]**: Selects the effect sounds of all **[SEND]** buttons (**[BUILT-IN]** and **[EXTERNAL]** buttons).
2. **TRIM knob**

Adjusts the volume for the channel input sound.
 3. **COMP knob**

Adjusts the compression level.
Turning clockwise increases its effect.
Turning all the way counterclockwise outputs the original sound.
 4. **EQ (HI, HI MID, LOW MID, LOW) knobs**

Adjusts the volume of each band.
Each knob adjusts in the following range.

 - **[HI]**: $-\infty$ dB to +6 dB
 - **[HI MID]**: -26 dB to +6 dB
 - **[LOW MID]**: -26 dB to +6 dB
 - **[LOW]**: $-\infty$ dB to +6 dB
 5. **Channel level indicator**

Displays the volume level before the sound passes through the channel fader.
 6. **FILTER knob** (page 42)
 7. **BEAT FX ASSIGN button** (page 56)
 8. **SEND knob** (page 44)
 9. **CUE A button** (page 36)
 10. **CUE B button** (page 36)
 11. **Channel fader**

Adjusts the volume for the channel output sound according to the channel fader curve specified via **[CH FADER CURVE]** (page 30).
Moving it up increases the volume, and down decreases the volume.
 12. **CROSSFADER ASSIGN (A, THRU, B) selector switch**

Assigns the channel output sound to the crossfader.

 - **[A]**: Assigns to the **[A]** (left) side.

- **[THRU]**: Bypasses the crossfader.
- **[B]**: Assigns to the **[B]** (right) side.

13. **Crossfader**

Adjusts the volume balance between the assigned sounds according to the crossfader curve specified via **[CROSSFADER CURVE]** (page 30).

Moving it to the **[A]** side outputs the sound assigned to **[A]**, and to the **[B]** side outputs the sound assigned to **[B]**.

❖ **MASTER section**

14. **LEVEL knob**

Adjusts the volume for the master sound.

15. **CLIP indicator**

Lights up when excessive volume is output from the **[MASTER1]** or **[MASTER2]** terminals.

16. **Master level indicator**

Displays the volume level of the master sound output to the **[MASTER1]**, **[MASTER2]**, and **[DIGITAL MASTER OUT]** terminals.

Outputting sound

Adjusting the channel input volume

- 1 Turn the input selector switch to select an input sound source.
- 2 Turn the [TRIM] knob to adjust the volume for the input sound.

The channel level indicator lights up when sound is input to the channel.

Adjusting the channel output volume

- 1 Move the channel fader to adjust the volume for the output sound.
- 2 Set the [CROSSFADER ASSIGN (A, THRU, B)] selector switch to assign the output sound to the crossfader.

- If selecting [THRU], this completes the volume adjustment for the channel output sound.

- 3 Move the crossfader to adjust the volume balance.

Adjusting the master sound volume

- 1 Turn the [LEVEL] knob to adjust the volume for the master sound.

The master level indicator lights up when the master sound is output.

 To adjust the master sound, see MASTER ISOLATOR (page 34).

Adjusting the sound

- 1 Turn the [EQ (HI, HI MID, LOW MID, LOW)] knobs to adjust the volume of each band.
- 2 Turn the [COMP] knob to adjust the compression level.

Setting the fader curves



Set the channel fader curve and crossfader curve.

- 1 Touch  on the main screen.

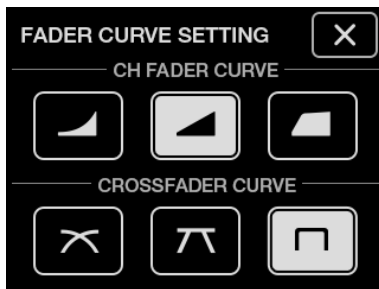



The [FADER CURVE SETTING] screen appears.



- 2 Touch a channel fader curve setting in [CH FADER CURVE].

- : Steeply raises the volume when the channel fader is moved close to the top position.
- : Gradually raises the volume as the channel fader is moved up.
- : Steeply raises the volume as the channel fader is moved from the bottom position.

3 Touch a crossfader curve setting in [CROSSFADER CURVE].

- : Gradually raises the volume of the sound assigned to the other side as the crossfader is moved from one side ([A] or [B]) to the other, and decreases the volume of the sound on the side it is moving away from (e.g. moving the crossfader away from the [A] side gradually increases the volume of the [B] side while gradually decreasing the volume of the [A] side).
- : Applies the intermediate setting between  and .
- : Steeply raises the volume of the sound assigned to the other side as the crossfader is moved from one side ([A] or [B]) to the other (e.g. moving the crossfader away from the [A] side steeply increases the volume of the [B] side).

4 Touch .

The [FADER CURVE SETTING] screen closes.

Adjusting the left/right sound balance

You can adjust the left/right balance for the sounds output from the following terminals.

- [MASTER1]
- [MASTER2]
- [BOOTH]
- [REC OUT]
- [DIGITAL MASTER OUT]
- [USB]
- [PHONES A]
- [PHONES B]

- You can adjust the left/right balance for the sound output from the [USB] port only when [MIX(REC OUT)] is selected for [Mixer Audio Output] in Setting Utility (page 16).

1 Touch and hold on the main screen.

The [UTILITY] screen appears.

2 Touch [BALANCE].

The [BALANCE] screen appears.

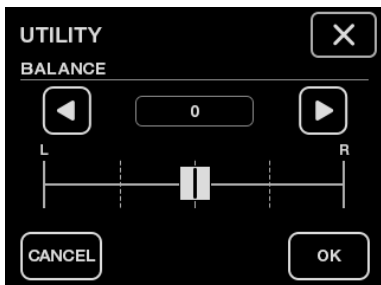

3 Touch / to set a value, or directly touch the position of the desired value on the slider to adjust the left/right balance.

- Only the left channel sound of stereo audio is output when set to the [L] (leftmost) position, and only the right channel sound is output when set to the [R] (rightmost) position.

4 Touch [OK].

- To cancel the setting, touch [**CANCEL**].

5 Touch .

The [UTILITY] screen closes.

MASTER ISOLATOR

Adjust the master sound.

MASTER ISOLATOR section

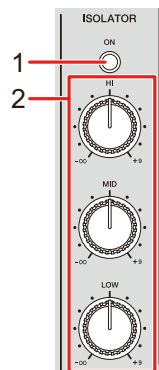

1. **ON button**

Turns on and off MASTER ISOLATOR. The button lights up when it is turned on.

2. **HI, MID, LOW knobs**

Adjusts the volume of each band.

Each knob adjusts in the following range.

- **[HI]**: $-\infty$ dB to +9 dB
- **[MID]**: $-\infty$ dB to +9 dB
- **[LOW]**: $-\infty$ dB to +9 dB

Adjusting the master sound

- 1 Press the [ON] button to turn on MASTER ISOLATOR.
 - 2 Turn the [HI, MID, LOW] knobs to adjust the volume of each band.
- Press the [ON] button again to turn off MASTER ISOLATOR.

Monitoring sound

HEADPHONES A/B sections

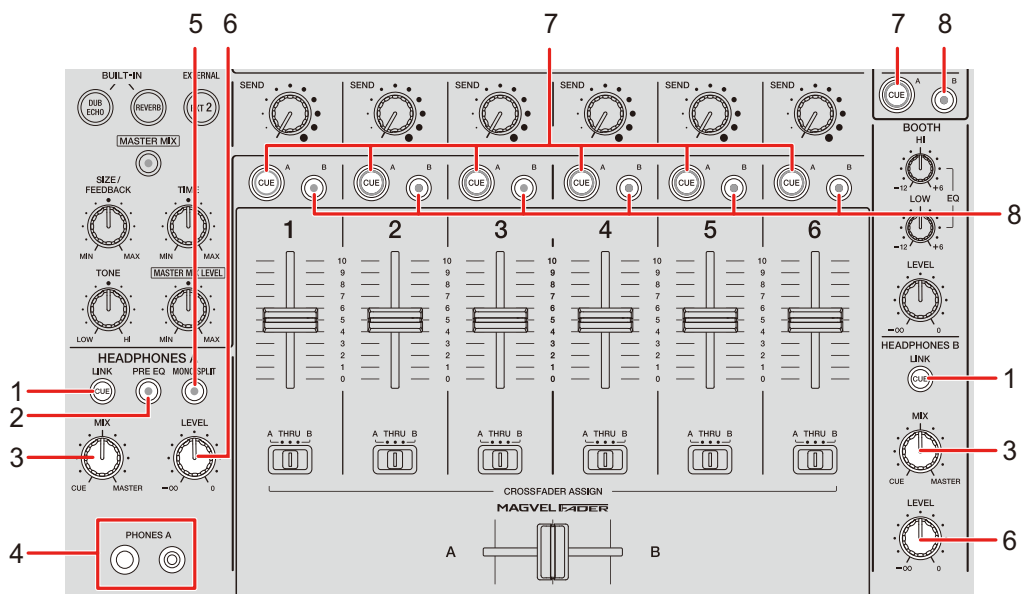

1. LINK CUE button

Outputs the LINK MONITOR sound.

2. PRE EQ button

Sets the sound (pre EQ or post EQ) output to the headphones.

Outputs the pre EQ sound when the button is lit, and the post EQ sound when it is turned off.

- The post EQ sound is output to **[HEADPHONES B]**.

3. MIX knob

Adjusts the volume balance between the channel with the **[CUE]** button pressed and the master sound.

4. PHONES A terminals

Connect headphones.

- For monitoring sound with **[HEADPHONES B]**, connect headphones to the **[PHONES B]** terminals on the front panel (page 22).

5. **MONO SPLIT button**

Sets the sound output method (MONO SPLIT or stereo) for the headphones.

Outputs the sound of the channel with the [**CUE A**] button pressed to the left channel of your headphones, and the [**MASTER**] sound to the right channel when the button is lit.

Outputs the stereo sound of the channel with the [**CUE A**] button pressed when the button is turned off.

- The stereo sound is output to [**HEADPHONES B**].

6. **LEVEL knob**

Adjusts the volume for the headphones monitor sound.

7. **CUE A button**

Outputs sound to the [**PHONES A**] terminals.

8. **CUE B button**

Outputs sound to the [**PHONES B**] terminals.

Monitoring with headphones

- 1 Connect headphones to the [PHONES A] or [PHONES B] terminals.
- 2 Press the [CUE] button ([CUE A], [CUE B] or [LINK CUE]) to select the sound you want to monitor.
 - For monitoring sound via [HEADPHONES B], skip to 5.
- 3 Press the [PRE EQ] button to set the output sound (pre EQ or post EQ).
- 4 Press the [MONO SPLIT] button to set the sound output (MONO SPLIT or stereo).
- 5 Turn the [MIX] knob to adjust the volume balance between the channel with the [CUE] button pressed and the master sound.
- 6 Turn the [LEVEL] knob to adjust the volume for the channel with the [CUE] button pressed.
 - Press the [CUE] button again to turn off monitoring.

BOOTH section

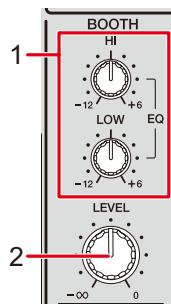

1. EQ (HI, LOW) knobs

Adjusts the volume of each band.

Each knob adjusts in the following range.

- [HI]: -12 dB to +6 dB
- [LOW]: -12 dB to +6 dB

2. LEVEL knob

Adjusts the volume for the sound output to a booth monitor.

Using a booth monitor

1 Connect a booth monitor to the [BOOTH] terminals.

➡ Read more: Connecting to the output terminals (page 21)

2 Turn the [LEVEL] knob to adjust the volume for the output sound.

3 Turn the [EQ (HI, LOW)] knobs to adjust the volume of each band.

Microphones

MIC section

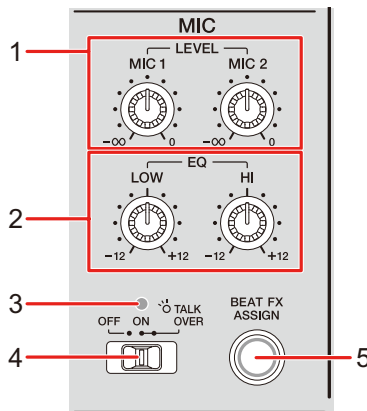

1. LEVEL (MIC1, MIC2) knobs

Adjusts the volume for the sound output to the [MIC1] and [MIC2] terminals.

2. EQ (HI, LOW) knobs

Adjusts the volume output to the [MIC1] and [MIC2] terminals.

Each knob adjusts in the following range.

- [HI]: -12 dB to +12 dB
- [LOW]: -12 dB to +12 dB

3. MIC indicator

Indicates the setting of the [OFF, ON, TALK OVER] selector switch as follows.

- Off: Set to [OFF].
- Lights up: Set to [ON].
- Blinks: Set to [TALK OVER].

4. OFF, ON, TALK OVER selector switch

Sets the microphone output.

- [OFF]: Turns the microphone off.
- [ON]: Turns the microphone on.

- **[TALK OVER]**: Sets the microphone to TALK OVER mode. The sound from channels other than the MIC channels is attenuated when sound over -10 dB is input to a microphone.
 - You can change the TALK OVER mode setting and attenuation level in **[TALK OVER]** in **[MY SETTINGS]** (page 75).
5. **BEAT FX ASSIGN button** (page 56)

Using a microphone

1 Connect a microphone to the **[MIC1]** or **[MIC2]** terminal.

➤ Read more: Connecting to the input terminals (page 20)

2 Set the **[OFF, ON, TALK OVER]** selector switch to set the microphone output.

3 Turn the **[LEVEL (MIC1, MIC2)]** knob to adjust the microphone volume.

- Note that turning the knobs too far clockwise outputs the sound at a high volume level.

4 Turn the **[EQ (HI, LOW)]** knobs to adjust the volume of each band.

5 Speak into the microphone.

➤ To add BEAT FX to the microphone sound, see BEAT FX section (page 56).

FILTER

You can adjust the cut-off frequency.

The selected filter is applied to all channels, [1] to [6].

FILTER section

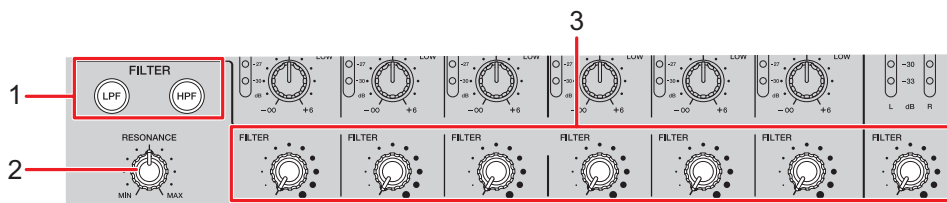

1. FILTER (LPF, HPF) buttons

Select a filter. The selected button blinks.

- [LPF]: Low Pass Filter
- [HPF]: High Pass Filter

2. RESONANCE knob

Adjusts the resonance. Turning the knob clockwise increases the resonance.

3. FILTER knob

Adjusts the cut-off frequency.

The setting changes according to the selected [FILTER (LPF, HPF)] button as follows.

- [LPF]: Turning the knob clockwise decreases the cut-off frequency.
- [HPF]: Turning the knob clockwise increases the cut-off frequency.

Using the FILTER

1 Press a [FILTER (LPF, HPF)] button to select a filter.

- If either button is already selected, pressing the other button switches to that filter.

2 Turn the [FILTER] knob to adjust the cut-off frequency.

3 Turn the [RESONANCE] knob to adjust the resonance.

- Press the blinking [FILTER (LPF, HPF)] button to turn the FILTER off.

SEND

You can route the effect sound (reverberation) of one of the built-in FX or an external FX unit to any channel or the master output.

SEND section

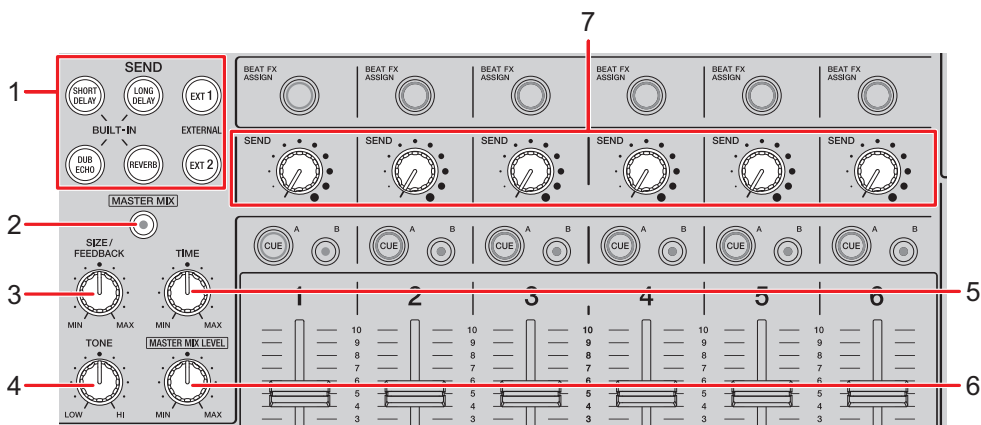

1. **SEND buttons** (page 49)
2. **MASTER MIX button**
Turns on and off MASTER MIX. The button lights up when it is turned on, and the effect sounds of all the [SEND] buttons are routed to the master output.
3. **SIZE/FEEDBACK knob** (page 49)
4. **TONE knob**
Adjusts the filter applied to the [BUILT-IN] effect sound.
5. **TIME knob** (page 49)
6. **MASTER MIX LEVEL knob**
Adjusts the volume for the SEND effect sound that is routed to the master output when MASTER MIX is turned on.
7. **SEND knob**
Adjusts the SEND effect level.

➤ For details on the connections, see Connecting to the EXT1/EXT2 terminals (page 23).

Routing effect sounds to the channels

You can route the effect sound of one of the built-in FX or an external FX unit to any channel. The selected effect is input to the selected channel.

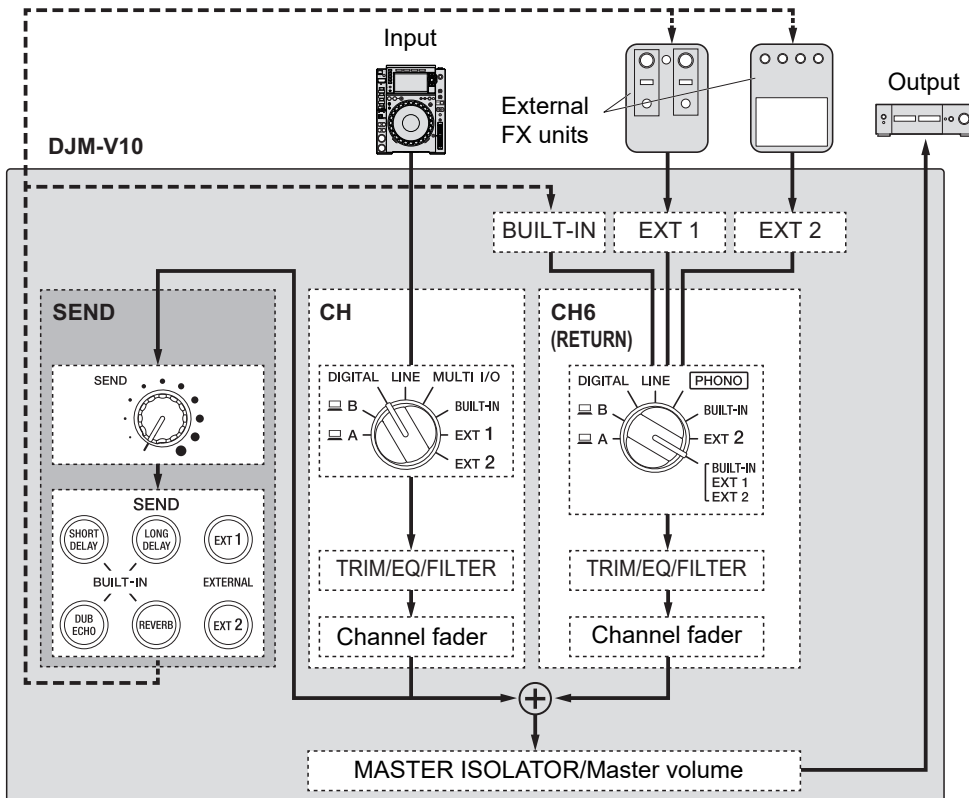

📖 Read more: SEND types and settings (page 49)

1 Turn the input selector switch to select an input sound source.

📖 For details on the input selector switch, see Channel section/MASTER section (page 26).

2 Press the [SEND] button to select the effect.

- If you are using an external FX unit, skip to step 6.

3 Turn the [SIZE/FEEDBACK] knob to adjust the quantitative parameter for the effect.

- 4 Turn the [TIME] knob to adjust the time parameter for the effect.
 - 5 Turn the [TONE] knob to adjust the filter to apply to the effect sound.
 - 6 Turn the [SEND] knob to adjust the SEND level.
- Press the blinking [SEND] button to turn off SEND.

Routing effect sounds to the master output

You can route the effect sound of one of the built-in FX or an external FX unit to the master output.

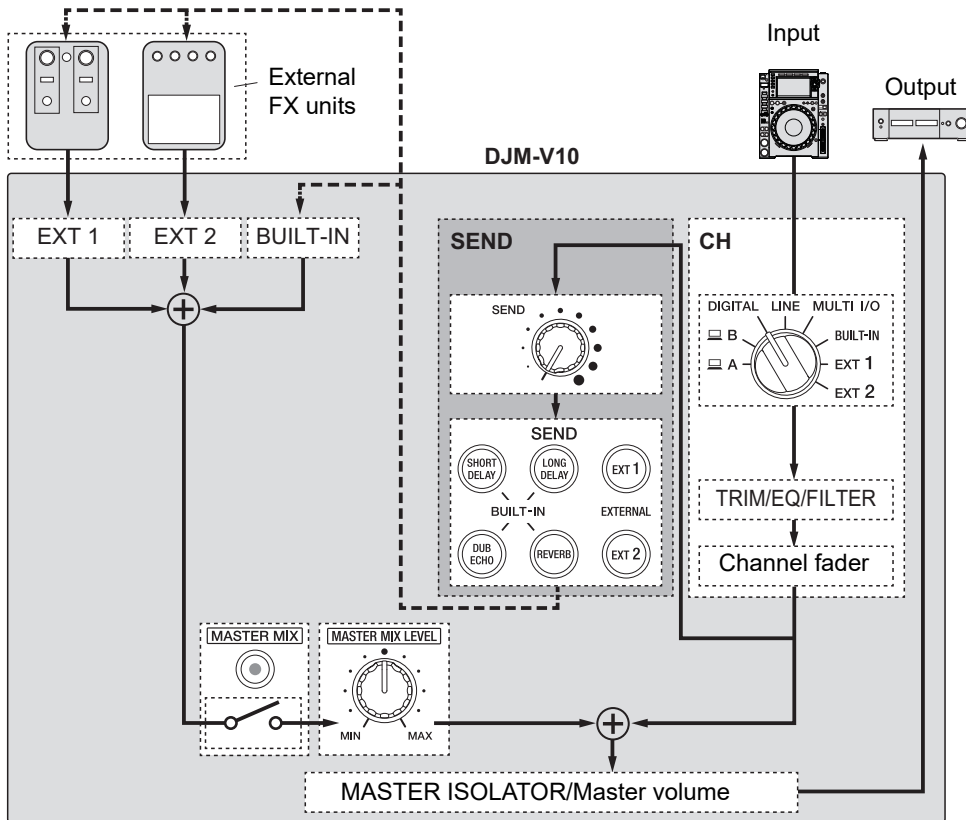

➤ Read more: SEND types and settings (page 49)

- 1 Press the **[MASTER MIX]** button to turn on MASTER MIX.
- 2 Press the **[SEND]** button to select the effect.
 - If you are using an external FX unit, skip to step 6.
- 3 Turn the **[SIZE/FEEDBACK]** knob to adjust the quantitative parameter for the effect.
- 4 Turn the **[TIME]** knob to adjust the time parameter for the effect.

- 5 Turn the [TONE] knob to adjust the filter to apply to the effect sound.
 - 6 Turn the [MASTER MIX LEVEL] knob to adjust the effect sound volume.
 - 7 Turn the [SEND] knob to adjust the SEND level.
- Press the blinking [SEND] button to turn off SEND.

SEND types and settings

You can adjust the following SEND settings with the relevant knobs.

- The selected [**SEND**] button blinks.
- You can select one of the [**BUILT-IN**] effect, and [**EXT1**]/[**EXT2**] at the same time.

FX/controls

Descriptions

BUILT-IN

SHORT DELAY

Adds short delay sounds.

- **SIZE/FEEDBACK:** Turning clockwise increases the feedback.
- **TIME:** Turning clockwise increases the delay time.

LONG DELAY

Adds long delay sounds.

- **SIZE/FEEDBACK:** Turning clockwise increases the feedback.
- **TIME:** Turning clockwise increases the delay time.

DUB ECHO

Adds reverberating echo by outputting the sounds slightly delayed from the original sound several times and attenuating them.

- **SIZE/FEEDBACK:** Turning clockwise increases the feedback.
- **TIME:** Turning clockwise increases the delay time.

REVERB

Adds reverberation.

- **SIZE/FEEDBACK:** Turning clockwise increases the room size.
- **TIME:** Turning clockwise increases reverberation time.

EXTERNAL

EXT1 ¹

Adds the effect sound of an external FX unit connected to the [**EXT1 SEND**] and [**EXT1 RETURN**] terminals.

EXT2 ¹

Adds the effect sound of an external FX unit connected to the [**EXT2 SEND**] and [**EXT2 RETURN**] terminals.

- 1 The [**SIZE/FEEDBACK**], [**TIME**], and [**TONE**] knobs are not available for this setting.

MULTI I/O

You can route the effect sound of an external FX unit or a mobile device (running an FX application) to the channels or the master output.

You can route effects in the following ways.

- **INSERT:** Replaces the original sound with the effect sound from an external device.

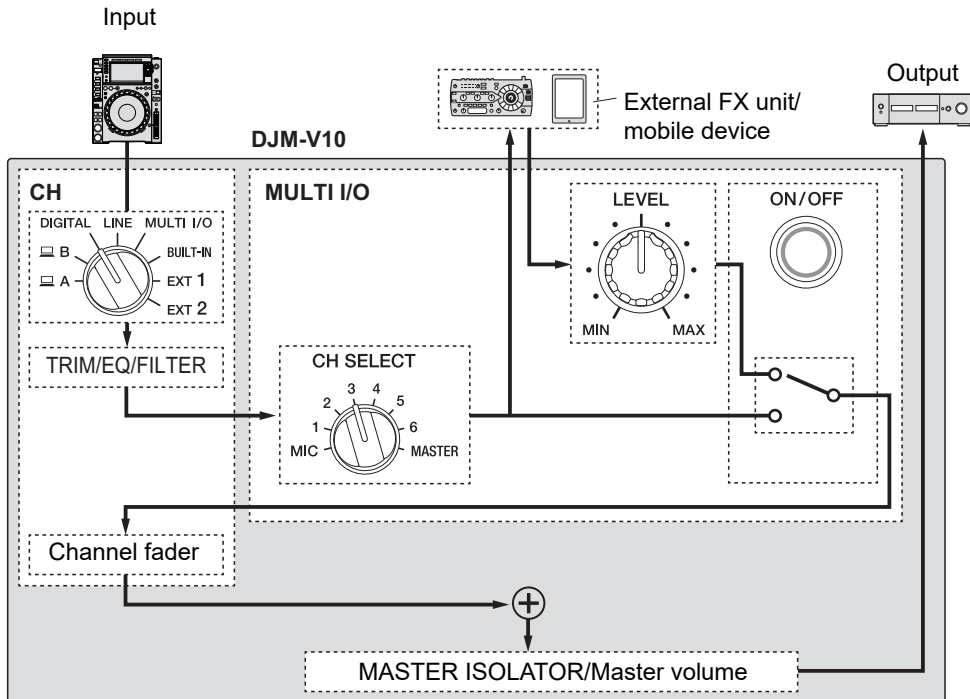

- **CH 2/CH 5:** Routes the effect sound from an external device to a channel separate from the one with the original sound. You can then mix the original sound and the effect sound using the two channels.

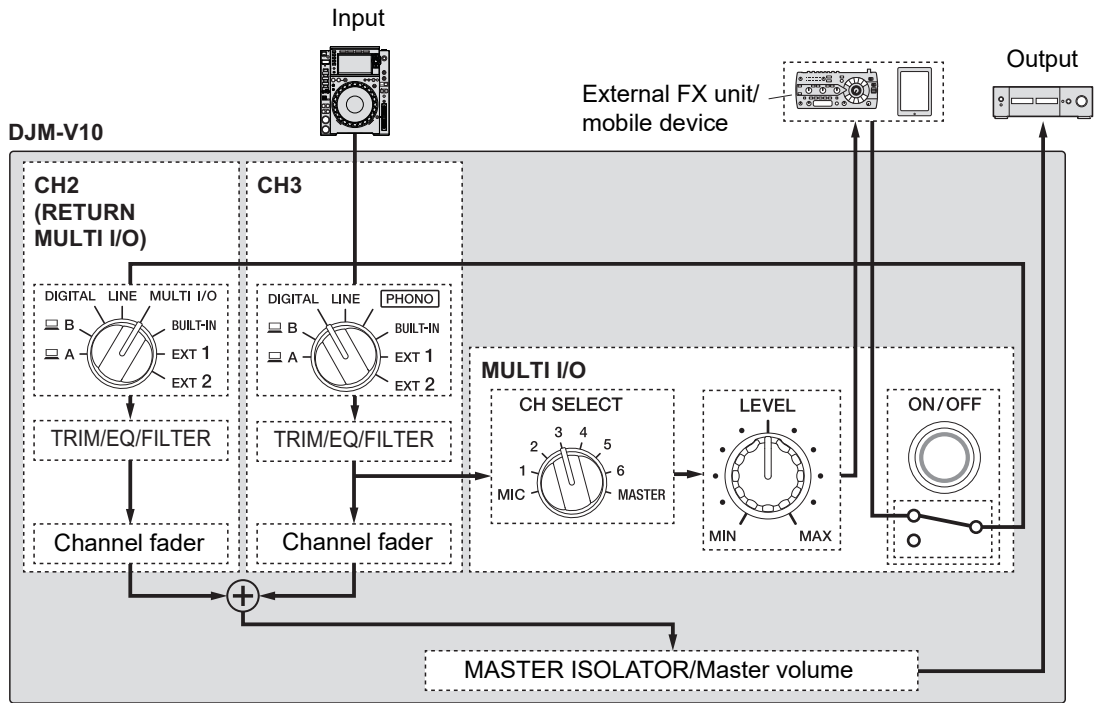

➡ For details on connections, see Connecting to the MULTI I/O terminals (page 24).

MULTI I/O section

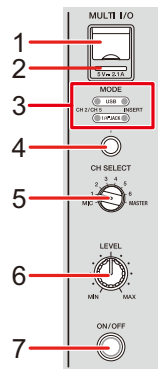

1. Mobile device connection terminal (USB port)

Connect a mobile device.

2. USB connection indicator

Lights up when a compatible mobile device is connected, and blinks when an incompatible mobile device is connected.

3. MODE selector indicator

Indicates an external FX unit and effect input method selected with the **[MODE]** selector button.

4. MODE selector button

Selects an external FX unit and effect input method.

- **[USB]**: Selects a mobile device connected to the mobile device connection terminal.
- **[1/4"JACK]**: Selects an external FX unit connected to the **[MULTI I/O RETURN]** terminals.
- **[CH 2/CH 5]**: Outputs the sound of a channel selected with the **[CH SELECT]** switch to an external FX unit or a mobile device, and routes the effected sound to a channel for which **[MULTI I/O]** is selected with the input selector switch.
- **[INSERT]**: Outputs the sound of a channel selected with the **[CH SELECT]** switch to an external FX unit or a mobile device, and routes the effected sound to the channel selected with the **[CH SELECT]** switch.

5. CH SELECT switch

Selects a channel to add the MULTI I/O effect to.

6. LEVEL knob

Adjusts the volume for the MULTI I/O effect sound.

7. ON/OFF button

Turns on and off MULTI I/O. The button blinks when it is turned on.

Using MULTI I/O

1 Press the [MODE] selector button to select an external FX unit and effect input method.

2 Turn the [CH SELECT] switch to select a channel to add the MULTI I/O effect to.

3 Press the [ON/OFF] button to turn on MULTI I/O.

4 Turn the [LEVEL] knob to adjust the volume for the MULTI I/O effect sound.

- Press the [ON/OFF] button again to turn off MULTI I/O.
- MULTI I/O turns off automatically in the following situations.
 - The unit is not connected with an external FX unit.
 - [CH 2/CH 5] is selected with the [MODE] selector button, a channel from [1] to [6] is selected with the [CH SELECT] switch, and [MULTI I/O] is selected with the input selector switch for the selected channel.
 - [CH 2/CH 5] is selected with the [MODE] selector button, and [MASTER] is selected with the [CH SELECT] switch.

BEAT FX

You can add various effects according to the tempo (BPM = Beats Per Minute) of the track being played.

If you use the Quantize function in PRO DJ LINK, the unit adds effects by automatically synchronizing it with the beat according to the track's grid information analyzed by rekordbox. This happens even if you operate the [ON/OFF] button of [BEAT FX] and [X-PAD] roughly.

- To use the Quantize function in PRO DJ LINK, connect a PRO DJ LINK compatible DJ player from Pioneer DJ to the unit.

Analyze the tracks in rekordbox beforehand. For details on track analysis, see the rekordbox Instruction Manual.

 Read more: PRO DJ LINK (page 7)

BEAT FX section

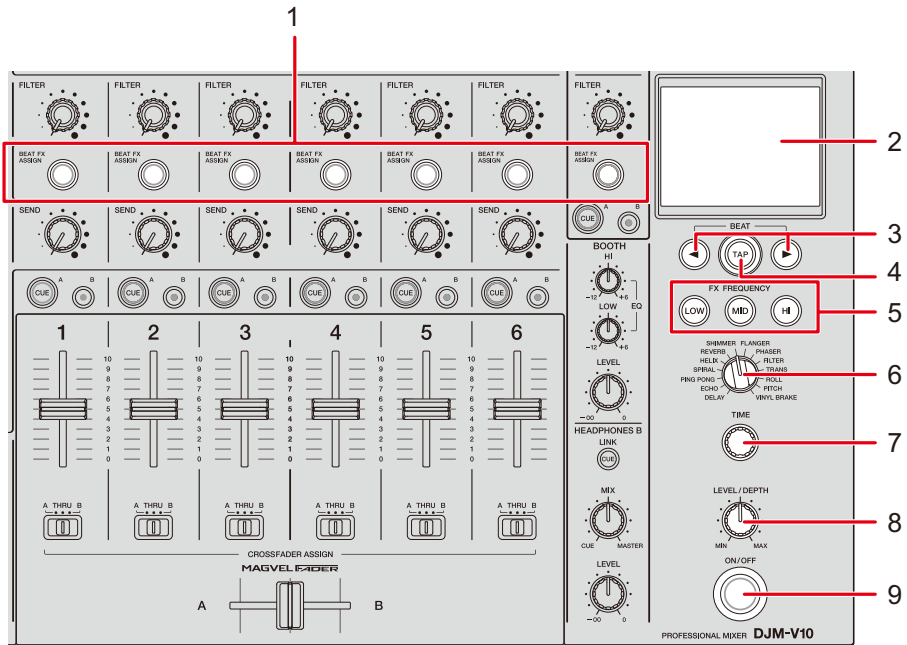

1. BEAT FX ASSIGN button

Adds BEAT FX to the channel. The selected button lights up, and blinks when BEAT FX is on.

- Press the [BEAT FX ASSIGN] button in the [MIC] section to add BEAT FX to the microphone sound.

2. Touch display (page 57)

3. BEAT ◀/▶ buttons

Set a beat fraction to synchronize BEAT FX with.

4. TAP button

Tap the button to manually set a BPM.

Press and hold to turn on the [AUTO] mode.

5. FX FREQUENCY (LOW, MID, HI) buttons

Select the band ([LOW], [MID], [HI]) to add BEAT FX to. The selected button lights up.

6. BEAT FX selector switch (page 61)

7. TIME knob (page 61)

8. LEVEL/DEPTH knob (page 61)

- Turning all the way counterclockwise outputs the original sound.

9. ON/OFF button

Turns on and off BEAT FX. The button blinks when it is turned on.

Touch display

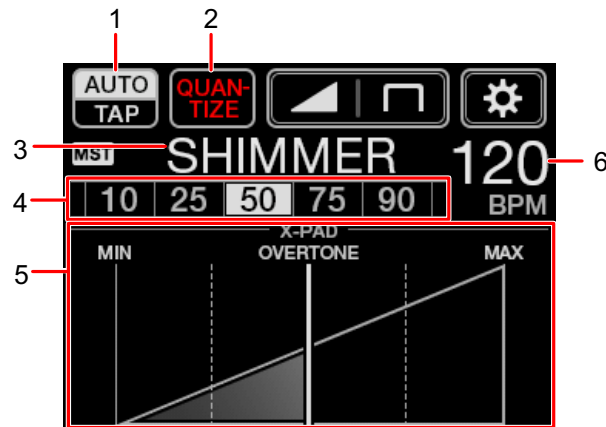

1. AUTO/TAP

Selects a BPM measuring mode.

Changes the highlighted (selected) item with each touch.

- **[AUTO]**: Automatically measures the BPM of the input sound (measuring range: 70 to 180).
- **[TAP]**: Manually sets a BPM (page 60).
- **[AUTO]** is automatically set when you turn the unit on.
- Touch and hold **[AUTO/TAP]** when **[TAP]** is selected to display the **[BPM SETTING]** screen and set a BPM in increments of 0.1.
- The BPM value blinks when it cannot be measured correctly in the **[AUTO]** setting. Use the **[TAP]** mode if this happens.

2. QUANTIZE

Indicates the status of the Quantize function as follows.

- Lights up in red: The function is turned on.
- Displays **[QUANTIZE]** and **[NO GRID]** alternately: Quantize is turned on, but the unit is not receiving the grid information.
- Lights up in gray: Quantize is turned off.
- The unit may not receive the grid information depending on the playback status of a connected DJ player (e.g. if it is off air, scratching, playing in reverse, etc.).

3. Selected effect

Displays the name of the selected effect.

4. Beat/parameter

Highlights the selected beat.

- Parameter is displayed for some effects when you press the [BEAT ◀▶] buttons. The display blinks if you choose a value out of the parameter's range.

5. X-PAD

Turns an effect on and off with a touch of [X-PAD].

Adjusts the time and quantitative parameters when you touch or slide your finger on the the [X-PAD].

- Release the [X-PAD] to turn the effect off.

6. BPM value

Displays the BPM value.

Using BEAT FX

➤ Read more: BEAT FX types and settings (page 61)

1 Touch [AUTO/TAP] or [QUANTIZE] to select a BPM measuring mode.

2 Turn the BEAT FX selector switch to select an effect.

The selected BEAT FX screen appears.

3 Press the [BEAT FX ASSIGN] button to select a channel to add the effect to.

4 Press the [BEAT ◀/▶] buttons to set a beat fraction to synchronize the effect sound with.

5 Press the [FX FREQUENCY (LOW, MID, HI)] buttons to select the band to add the effect to.

6 Turn the [TIME] and [LEVEL/DEPTH] knobs to adjust the effect settings.

7 Press the [ON/OFF] button (or touch the [X-PAD]) to turn on BEAT FX.

The effect is added to the selected channel.

- Press the [ON/OFF] button again to turn off BEAT FX.

Setting the BPM manually

1 Tap the [TAP] button more than twice in time with the beat of the track.

The BPM is set according to the average time between taps.

- The beat fraction is set to [1/1] when you set the BPM with the [TAP] button, and the length of one beat is set as the effect time.
- You can also set the BPM manually by turning the [TIME] knob while pressing the [TAP] button.
- Touch and hold [AUTO/TAP] when [TAP] is selected to display the [BPM SETTING] screen and set the BPM in increments of 0.1.

BEAT FX types and settings

You can adjust the following BEAT FX settings with the relevant buttons and knobs, etc.

BEAT FX/controls	Descriptions
DELAY ¹ ² <ul style="list-style-type: none"> • BEAT ◀/▶: Delay time with respect to 1 beat of the BPM (beat fraction): 1/16 to 16 beats • TIME: Delay time: 1 to 4000 (ms) • LEVEL/DEPTH: Balance between the original sound and the effect sound • X-PAD: Delay time 	Outputs a delay sound once according to the beat.
ECHO ¹ ² <ul style="list-style-type: none"> • BEAT ◀/▶: Delay time with respect to 1 beat of the BPM (beat fraction): 1/16 to 16 beats • TIME: Delay time: 1 to 4000 (ms) • LEVEL/DEPTH: Balance between the original sound and the effect sound • X-PAD: Delay time 	Outputs a delay sound several times while attenuating it according to the beat.
PING PONG ¹ ² <ul style="list-style-type: none"> • BEAT ◀/▶: Delay time with respect to 1 beat of the BPM (beat fraction): 1/16 to 16 beats • TIME: Delay time: 10 to 4000 (ms) • LEVEL/DEPTH: Balance between the original sound and the effect sound • X-PAD: Delay time 	Outputs a delay sound with different delay times for the left and right several times while attenuating it according to the beat, producing a stereo-like effect.

BEAT FX/controls	Descriptions
SPIRAL 1 2 <ul style="list-style-type: none"> • BEAT ◀/▶: • TIME: • LEVEL/DEPTH: • X-PAD: 	<p>Adds reverberation to the input sound.</p> <p>Delay time with respect to 1 beat of the BPM (beat fraction): 1/16 to 16 beats</p> <p>Delay time: 10 to 4000 (ms)</p> <p>Balance between the original sound and the effect sound, and feedback</p> <p>Delay time</p>
HELIX <ul style="list-style-type: none"> • BEAT ◀/▶: • TIME: • LEVEL/DEPTH: • X-PAD: 	<p>Records the input sound, and outputs the recorded sound repeatedly according to the specified beat fraction.</p> <p>Effect time with respect to 1 beat of the BPM (beat fraction): 1/16 to 16 beats</p> <p>Effect time: 10 to 4000 (ms)</p> <p>Ratio of sound overlay</p> <ul style="list-style-type: none"> • You can change the attenuation rate by turning the [LEVEL/DEPTH] knob all the way counterclockwise and then clockwise. Turn the knob all the way clockwise to fix the output sound. <p>Effect time</p>
REVERB 1 2 <ul style="list-style-type: none"> • BEAT ◀/▶: • TIME: • LEVEL/DEPTH: • X-PAD: 	<p>Adds reverberation to the input sound.</p> <p>Reverberation level: 1 to 100%</p> <p>Reverberation level: 1 to 100%</p> <p>Balance between the original sound and the effect sound</p> <p>Cut-off frequency for the filter</p>

BEAT FX/controls	Descriptions
SHIMMER ¹ ²	Adds a sparkling reverberation to the input sound. <ul style="list-style-type: none"> • BEAT ◀/▶: Reverberation level: 1 to 100% • TIME: Reverberation level: 1 to 100% • LEVEL/DEPTH: Balance between the original sound and the effect sound • X-PAD: Rate of the sparkling effect
FLANGER	Adds a cyclic flanger effect according to the beat. <ul style="list-style-type: none"> • BEAT ◀/▶: Moving cycle of the effect with respect to 1 beat of the BPM (beat fraction): 1/16 to 64 beats • TIME: Moving cycle of the effect: 10 to 32000 (ms) • LEVEL/DEPTH: Effect level • X-PAD: Cycle to finely fluctuate the effect
PHASER	Adds a cyclic phaser effect according to the beat. <ul style="list-style-type: none"> • BEAT ◀/▶: Moving cycle of the effect with respect to 1 beat of the BPM (beat fraction): 1/16 to 64 beats • TIME: Moving cycle of the effect: 10 to 32000 (ms) • LEVEL/DEPTH: Effect level • X-PAD: Cycle to finely fluctuate the effect
FILTER	Changes the cut-off frequency cyclically for the filter according to the beat. <ul style="list-style-type: none"> • BEAT ◀/▶: Moving cycle of the effect with respect to 1 beat of the BPM (beat fraction): 1/16 to 64 beats • TIME: Moving cycle of the effect: 10 to 32000 (ms) • LEVEL/DEPTH: Effect level

BEAT FX/controls	Descriptions
<ul style="list-style-type: none"> • X-PAD: 	Cycle to finely fluctuate the effect
TRANS	Cuts the sound cyclically according to the beat.
<ul style="list-style-type: none"> • BEAT ◀/▶: 	Cycle of the cut with respect to 1 beat of the BPM (beat fraction): 1/16 to 16 beats
<ul style="list-style-type: none"> • TIME: 	Effect time: 10 to 16000 (ms)
<ul style="list-style-type: none"> • LEVEL/DEPTH: 	Balance between the original sound and the effect sound, and duty
<ul style="list-style-type: none"> • X-PAD: 	Cut cycle
ROLL	Records the input sound when the [ON/OFF] button is pressed, and outputs the recorded sound repeatedly according to the specified beat fraction.
<ul style="list-style-type: none"> • BEAT ◀/▶: 	Effect time with respect to 1 beat of the BPM (beat fraction): 1/16 to 16 beats
<ul style="list-style-type: none"> • TIME: 	Effect time: 10 to 4000 (ms)
<ul style="list-style-type: none"> • LEVEL/DEPTH: 	Balance between the original sound and the effect sound
<ul style="list-style-type: none"> • X-PAD: 	Effect time
PITCH	Adjusts the pitch of the original sound.
<ul style="list-style-type: none"> • BEAT ◀/▶: 	Pitch of the effect sound: -50 to 100%
<ul style="list-style-type: none"> • TIME: 	Pitch of the effect sound: -50 to 100%
<ul style="list-style-type: none"> • LEVEL/DEPTH: 	Pitch of the effect sound
<ul style="list-style-type: none"> • X-PAD: 	Pitch of the effect sound

BEAT FX/controls	Descriptions
VINYL BRAKE	Slows down the playback speed of the input sound gradually according to the beat and then stops the playback.
• BEAT ◀/▶:	Effect time with respect to 1 beat of the BPM (beat fraction): 1/16 to 16 beats
• TIME:	Effect time: 10 to 4000 (ms)
• LEVEL/DEPTH:	Playback speed
• X-PAD:	Effect time

¹ If the **[BEAT FX ASSIGN]** button is pressed on any of the channels, **[1]** to **[6]**, you cannot monitor the effect sound, even if you press the **[CUE A]** or **[CUE B]** button for the relevant channel.

² Only the effect sound remains if you set the channel fader to the **[0]** position to cut the input sound.

USB/MIDI

If you connect a PC/Mac or mobile device with MIDI software installed, to the unit via a USB cable, you can control the MIDI software via the unit (page 67).

You can also synchronize an external MIDI sequencer with the tempo (BPM) of the track on the channel that is selected for adding BEAT FX with the **[AUTO]** or **[QUANTIZE]** setting (page 68).

- For details on the unit's MIDI messages, visit the URL below.

pioneerdj.com/support/

- Set the MIDI channel for outputting MIDI in **[MIDI]** in **[MY SETTINGS]** (page 75). You do not need to make the setting to output via HID.

USB/MIDI section

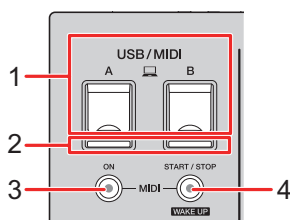

1. **A, B (USB) ports** (page 22)

2. **USB connection indicator**

Lights up when a PC/Mac is connected, and blinks when a PC/Mac is connected without the dedicated audio driver software installed.

- To input or output your PC/Mac's audio to/from the unit, install the dedicated audio driver software on your computer (page 13).

3. **MIDI ON button**

Turns on and off MIDI. The button lights up when it is turned on.

4. **MIDI START/STOP (WAKE UP) button**

Sends the MIDI start/stop messages. The button lights up after the start message is sent, and turns off after the stop message is sent.

Exits standby mode if you press the button when the unit in standby mode.

Controlling MIDI software

- Install MIDI software and configure the audio and MIDI settings on a PC/Mac or mobile device beforehand.

1 Connect a PC/Mac or mobile device to the unit.

- Connect a PC/Mac to the [**A, B**] (USB) port, or connect a mobile device to the mobile device connection terminal in the [**MULTI I/O**] section (page 22).

2 Launch the MIDI software.

- This completes the sequence if you are using a mobile device.

3 Press the [**MIDI ON**] button to turn on MIDI.

The sending of MIDI messages starts.

- Press the [**MIDI ON**] button again to turn off MIDI and stop sending MIDI messages.
- The MIDI timing clock (BPM) is sent even when the [**MIDI ON**] button is switched off.
- Press the [**MIDI START/STOP (WAKE UP)**] button to send the MIDI start and stop messages alternately. The messages are sent even when the [**MIDI ON**] button is switched off.

Controlling an external MIDI sequencer

You can synchronize an external MIDI sequencer with the tempo (BPM) of the track on the channel that is selected for adding BEAT FX with the **[AUTO]** or **[QUANTIZE]** setting.

- The tempo (BPM) of the track is sent as a MIDI timing clock (output range: 40 to 250 BPM).
- The MIDI timing clock (BPM) is sent even when you have set the BPM manually.
- External MIDI sequencers that do not support the MIDI timing clock (BPM) cannot be synchronized.
- You cannot use tracks if their BPM cannot be detected for the synchronization.
- The accuracy of the MIDI timing clock is improved when a DJ player that supports the Quantize function is connected to the unit and **[QUANTIZE]** is turned on.

1 Connect the [MIDI OUT] terminal on the unit and the MIDI IN terminal on an external MIDI sequencer with a MIDI cable (available separately).

2 Set slave synchronization mode on the external MIDI sequencer.

3 Press the [MIDI START/STOP (WAKE UP)] button to send the MIDI start message.

4 Press the [MIDI ON] button to turn on MIDI.

The sending of MIDI messages starts.



- Press the **[MIDI ON]** button again to turn off MIDI and stop sending MIDI messages.
- The MIDI timing clock (BPM) is sent even when the **[MIDI ON]** button is switched off.
- Press the **[MIDI START/STOP (WAKE UP)]** button to send the MIDI start and stop messages alternately. The messages are sent even when the **[MIDI ON]** button is switched off.

Settings

You can change the unit's settings in the **[UTILITY]** settings. If you save **[MY SETTINGS]** to a storage device (USB drive, etc.), you can load them to the unit immediately when you arrive in the booth or take over from another DJ, etc.

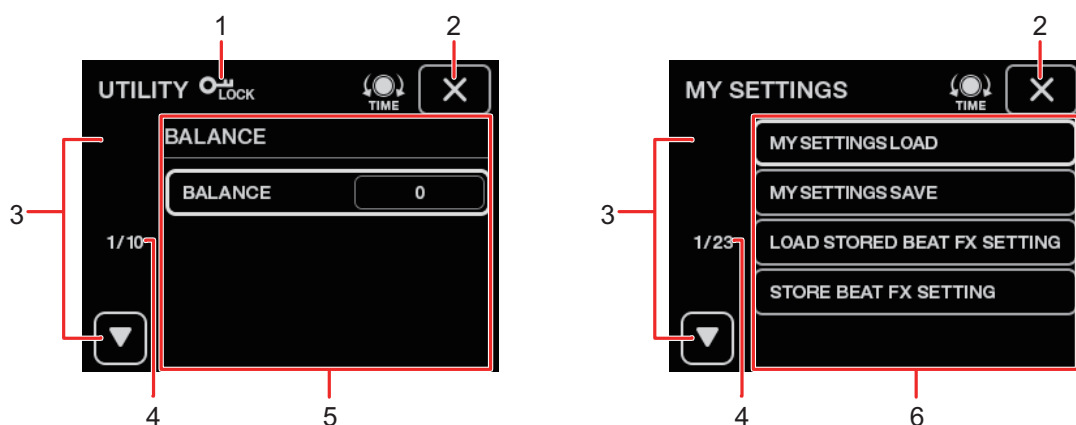
[UTILITY]/[MY SETTINGS] screens



-  Displayed when the **[UTILITY]** settings are locked (cannot be changed).
-  Closes the screen.
-  Displays the next or previous page.
 - You can also display the next or previous page by turning the **[TIME]** knob in the **[BEAT FX]** section.
- Page number**
Indicates current page number/total number of pages.
- UTILITY settings items** (page 71)
- MY SETTINGS items** (page 74)

Changing the settings

1 Touch, or touch and hold on the main screen.

Touch to display the [MY SETTINGS] screen.

Touch and hold to display the [UTILITY] screen.

2 Touch a setting item.

- You can scroll through items with the [TIME] knob in the [BEAT FX] section.

 Read more: UTILITY settings (page 71)

 Read more: MY SETTINGS (page 74)

3 Touch a setting value.

4 Touch [OK] to confirm the setting.

- To cancel the setting, touch [CANCEL].

5 Touch .

The [UTILITY] or [MY SETTINGS] screen closes.

- Note that the screen closes without saving the setting if you touch  without confirming the setting.

UTILITY settings

*: Factory setting

Setting items	Descriptions
BALANCE ¹	<p>Sets the output balance.</p> <ul style="list-style-type: none"> Setting values: L128 to 0* to R127
MASTER OUT ¹	
PEAK LIMITER	<p>Reduces distortion to the sound output from the [MASTER1] and [MASTER2] terminals.</p> <ul style="list-style-type: none"> Setting values: OFF, ON*
ATT.	<p>Sets the attenuation level for the sound output from the [MASTER1] and [MASTER2] terminals.</p> <ul style="list-style-type: none"> Setting values: -12dB, -9dB, -6dB, -3dB, 0dB*
MONO/STEREO	<p>Sets the output method (mono/stereo) for the sound output from the [MASTER1] and [MASTER2] terminals.</p> <ul style="list-style-type: none"> Setting values: MONO, STEREO*
DIGITAL MASTER OUT ¹	
REFERENCE LEVEL	<p>Sets the output level for when the master level indicator lights up at [0] dB.</p> <ul style="list-style-type: none"> Setting values: -30dBFS, -27dBFS, -24dBFS, -21dBFS*, -18dBFS, -15dBFS, -12dBFS, -9dBFS, -6dBFS Note that sound may be distorted even when the master level indicator does not show the maximum level.
SAMPLING RATE	<p>Sets the sampling rate for the digital signal.</p> <ul style="list-style-type: none"> Setting values: 44.1kHz, 48kHz, 88.2kHz, 96kHz*

Setting items	Descriptions
PEAK LIMITER	<p>Reduces distortion to the sound output from the [DIGITAL MASTER OUT] terminal.</p> <ul style="list-style-type: none"> Setting values: OFF, ON*
MONO/STEREO	<p>Sets the output method (mono/stereo) for the sound output from the [DIGITAL MASTER OUT] terminal.</p> <ul style="list-style-type: none"> Setting values: MONO, STEREO*
BOOTH OUT ¹	
ATT.	<p>Reduces distortion to the sound output from the [BOOTH] terminals.</p> <ul style="list-style-type: none"> Setting values: -12dB, -9dB, -6dB, -3dB, 0dB*
MONO/STEREO	<p>Sets the output method (mono/stereo) for the sound output from the [BOOTH] terminals.</p> <ul style="list-style-type: none"> Setting values: MONO, STEREO*
MIC OUT TO MASTER ¹	
PEAK LIMITER THRESHOLD LEVEL	<p>Sets the limiter for the microphone sound that is input to the master sound.</p> <ul style="list-style-type: none"> Setting values: 0dB, 3dB, 6dB, 9dB, 12dB, 15dB, OFF*
MIC OUT TO BOOTH ¹	
LEVEL	<p>Sets the volume for the microphone sound that is input to the sound output from the [BOOTH] terminals.</p> <ul style="list-style-type: none"> Setting values: OFF, -18dB, -15dB, -12dB, -9dB, -6dB, -3dB, 0dB*
PEAK LIMITER THRESHOLD LEVEL	<p>Sets the limiter for the microphone sound that is input to the sound output from the [BOOTH] terminals.</p> <ul style="list-style-type: none"> Setting values: 0dB, 3dB, 6dB, 9dB, 12dB, 15dB, OFF*

Setting items	Descriptions
PC UTILITY ¹	<p>Determines whether or not to automatically launch Setting Utility when a PC/Mac is connected to the unit with a USB cable.</p> <ul style="list-style-type: none"> Setting values: OFF*, ON
AUTO STANDBY ¹	<p>Sets the auto standby function (page 73).</p> <ul style="list-style-type: none"> Setting values: OFF, ON*
LOCK	<p>Determines whether or not to allow the change of the [UTILITY] settings.</p> <ul style="list-style-type: none"> Setting values: LOCKED, UNLOCKED*
OWNER SETTING	
SAVE	<p>Saves the [UTILITY] settings and [MY SETTINGS] as [OWNER SETTING] on the unit. The [MY SETTINGS] saved as [OWNER SETTING] are the default settings when you turn the unit on.</p>
LOAD	<p>Calls up the [OWNER SETTING] (the [UTILITY] settings and [MY SETTINGS]) saved on the unit.</p>

¹ The setting is saved on the unit when you touch [SAVE] in [OWNER SETTING].

Auto standby

When [AUTO STANDBY] is set to [ON], the unit enters standby mode after 10 hours without being used in the following ways.







- No audio signals are input to the channels on the unit.
- There is no PRO DJ LINK connection.

Press the [MIDI START/STOP (WAKE UP)] button to exit standby mode.

- The factory setting is [ON].
- Set [AUTO STANDBY] to [OFF] if you do not need to use the auto standby function.

MY SETTINGS

*: Factory setting

Setting items	Descriptions
MY SETTINGS LOAD	Calls up the [MY SETTINGS] saved on a storage device (page 79).
MY SETTINGS SAVE	Saves the current [MY SETTINGS] to a storage device (page 78).
LOAD STORED BEAT FX SETTING	Restores the beat and [FX FREQUENCY (LOW, MID, HI)] settings for BEAT FX to the default settings of [MY SETTINGS].
STORE BEAT FX SETTING	Saves the current beat and [FX FREQUENCY (LOW, MID, HI)] settings as the default settings of [MY SETTINGS].
CH FADER CURVE ¹	
CH FADER CURVE	<p>Sets the channel fader curve.</p> <ul style="list-style-type: none"> Setting values: , *, 
CROSSFADER CURVE ¹	
CROSSFADER CURVE	<p>Sets the crossfader curve.</p> <ul style="list-style-type: none"> Setting values: , *, 
HEADPHONES A ¹	
PRE EQ	<p>Sets [PRE EQ] (pre EQ or post EQ setting) for the headphones monitor sound of [HEADPHONES A].</p> <ul style="list-style-type: none"> Setting values: POST EQ*, PRE EQ
MONO SPLIT	<p>Sets the output method (MONO SPLIT or stereo) for the headphones monitor sound of [HEADPHONES A].</p> <ul style="list-style-type: none"> Setting values: STEREO*, MONO SPLIT

Setting items	Descriptions
BEAT FX QUANTIZE ¹	
BEAT FX QUANTIZE	<p>Sets [QUANTIZE] for BEAT FX.</p> <ul style="list-style-type: none"> Setting values: OFF, ON*
MIC LOW CUT ¹	
MIC LOW CUT	<p>Sets the low-frequency cut function for the microphone sound.</p> <ul style="list-style-type: none"> Setting values: OFF, ON (for MC)*
TALK OVER ¹	
MODE	<p>Sets TALK OVER mode.</p> <ul style="list-style-type: none"> Setting values: ADVANCED*, NORMAL The [ADVANCED] setting outputs sound by attenuating only the mid-frequency range of the sound from channels other than the [MIC] channels according to the setting of the [LEVEL] knob. The [NORMAL] setting outputs sound by attenuating the sound from channels other than the [MIC] channels according to the [LEVEL] knob setting.
LEVEL	<p>Sets the sound attenuation level for TALK OVER.</p> <ul style="list-style-type: none"> Setting values: -24dB, -18dB*, -12dB, -6dB
MIDI ¹	
CH	<p>Sets the MIDI channel.</p> <ul style="list-style-type: none"> Setting values: 1* to 16
BUTTON TYPE	<p>Sets the MIDI signal transmission method.</p> <ul style="list-style-type: none"> Setting values: TOGGLE*, TRIGGER

Setting items	Descriptions
BRIGHTNESS ¹	
DISPLAY	Sets the brightness of the touch display. <ul style="list-style-type: none"> Setting values: 1 to 5*, WHITE
INDICATOR	Sets the brightness of LED. <ul style="list-style-type: none"> Setting values: 1 to 3*
DELAY ² , ECHO ² , PING PONG ² , SPIRAL ² , TRANS ² , ROLL ²	
BEAT	<ul style="list-style-type: none"> Setting values: 1/16, 1/8, 1/4, 1/2, 3/4, 1*, 2, 4, 8, 16
FX FREQUENCY HI, MID, LOW	<ul style="list-style-type: none"> Setting values: OFF, ON*
HELIX ²	
BEAT	<ul style="list-style-type: none"> Setting values: 1/16, 1/8, 1/4, 1/2, 1*, 2, 4, 8, 16
FX FREQUENCY HI, MID, LOW	<ul style="list-style-type: none"> Setting values: OFF, ON*
REVERB ² , SHIMMER ²	
BEAT	<ul style="list-style-type: none"> Setting values: 1, 10, 25, 50*, 75, 90, 100
FX FREQUENCY HI, MID, LOW	<ul style="list-style-type: none"> Setting values: OFF, ON*
FLANGER ² , PHASER ² , FILTER ²	
BEAT	<ul style="list-style-type: none"> Setting values: 1/16, 1/8, 1/4, 1/2, 1, 2, 4*, 8, 16, 32, 64
FX FREQUENCY HI, MID, LOW	<ul style="list-style-type: none"> Setting values: OFF, ON*

Setting items	Descriptions
PITCH ²	
BEAT	<ul style="list-style-type: none"> Setting values: -50%*, -37%, -25%, 0%, 26%, 50%, 100%
FX FREQUENCY HI, MID, LOW	<ul style="list-style-type: none"> Setting values: OFF, ON*
VINYL BRAKE ²	
BEAT	<ul style="list-style-type: none"> Setting values: 1/16, 1/8, 1/4, 1/2, 3/4, 1, 2, 4*, 8, 16
FX FREQUENCY HI, MID, LOW	<ul style="list-style-type: none"> Setting values: OFF, ON*

¹ The setting is saved on the unit when you touch [**SAVE**] in [**OWNER SETTING**].

² Set the BEAT FX settings to be called up when you touch [**LOAD STORED BEAT FX SETTING**]. For details on the functions, see BEAT FX types and settings (page 61).

Saving MY SETTINGS to a storage device

You can save MY SETTINGS on a USB storage device.

- You can save MY SETTINGS to rekordbox that is connected to the unit via PRO DJ LINK.

1 Connect a storage device.

 Read more: Connections (page 20)

2 Touch on the main screen.

The [MY SETTINGS] screen appears.

3 Touch [MY SETTINGS SAVE].

Available storage devices are displayed on the [SAVE] screen.

- You can scroll through items with the [TIME] knob in the [BEAT FX] section.

4 Touch a storage device to save settings to.

5 Touch [OK].

The [MY SETTINGS] are saved to the storage device.

- To cancel the setting, touch [CANCEL].

6 Touch .

The [MY SETTINGS] screen closes.

Calling up MY SETTINGS saved on a storage device

You can call up MY SETTINGS from a USB storage device.

- You can call up MY SETTINGS from rekordbox that is connected to the unit via PRO DJ LINK.

1 Connect a storage device.

 Read more: Connections (page 20)

2 Touch on the main screen.

The [MY SETTINGS] screen appears.

3 Touch [MY SETTINGS LOAD].

Available storage devices are displayed on the [LOAD] screen.

- You can scroll through items with the [TIME] knob in the [BEAT FX] section.

4 Touch a storage device to call up settings from.

5 Touch [OK].

The [MY SETTINGS] are called up.

- To cancel the setting, touch [CANCEL].

6 Touch .

The [MY SETTINGS] screen closes.

Restoring the factory settings

- 1 While pressing the [MIDI START/STOP (WAKE UP)] button, press the [⏻] button.

The [FACTORY RESET] screen appears.



- 2 Touch [YES].

- You can scroll through items with the [TIME] knob in the [BEAT FX] section.

- 3 Touch [OK].

- 4 Press the [⏻] button to turn the unit off.

The factory settings are restored.

Specifications

General

Main unit weight	11.9 kg (26.2 lbs)
Max. external dimensions	437.6 mm (width) x 467.0 mm (depth) x 107.9 mm (height)
Tolerable operating temperature	+5 °C to +35 °C
Tolerable operating humidity	5 % to 85 % (no condensation)

Audio Section

Sampling rate	96 kHz
MASTER, BOOTH D/A converter	32-bit
CH input A/D converter	32-bit
Other A/D and D/A converters	24-bit

Frequency characteristic

LINE	20 Hz to 40 kHz
------------	-----------------

S/N ratio (rated output, A-WEIGHTED)

USB, DIGITAL IN	116 dB
PHONO	88 dB
LINE	105 dB
MIC1, MIC2	79 dB

Total harmonic distortion (LINE — MASTER1, 20 Hz to 40 kHzBW).....	0.005 %
--	---------

Standard input level/Input impedance

PHONO	-52 dBu/47 k Ω
LINE	-12 dBu/47 k Ω
MIC1, MIC2	-57 dBu/3.5 k Ω
RETURN	-12 dBu/47 k Ω

Max. input level

PHONO	-17.8 dBu
LINE	+15 dBu
MIC1, MIC2	+2.6 dBu
RETURN	+12 dBu

Standard output level/Load impedance/Output impedance

MASTER1	+6 dBu/10 k Ω /360 Ω
MASTER2	+2 dBu/10 k Ω /700 Ω
REC OUT	-8 dBu/10 k Ω /700 Ω
BOOTH	+6 dBu/10 k Ω /360 Ω
SEND	-12 dBu/10 k Ω /700 Ω

Specifications

PHONES	+8 dBu/32 Ω /1 Ω or lower
Rated output level/Load impedance	
MASTER1	+25 dBu/10 k Ω
MASTER2	+21 dBu/10 k Ω
BOOTH	+25 dBu/10 k Ω
Digital output impedance	
AES/EBU.....	110 Ω
Crosstalk	
LINE	82 dB
Channel equalizer characteristic	
HI	- ∞ dB to +6 dB (2 kHz)
HI MID	-26 dB to +6 dB (1.2 kHz)
LOW MID	-26 dB to +6 dB (400 Hz)
LOW	- ∞ dB to +6 dB (200 Hz)
Microphone equalizer characteristic	
HI.....	-12 dB to +12 dB (10 kHz)
LOW.....	-12 dB to +12 dB (100 Hz)
BOOTH MONITOR equalizer feature	
HI	-12 dB to +6 dB (3 kHz)
LOW.....	-12 dB to +6 dB (300 Hz)

Input / Output terminals

PHONO input terminal	
RCA pin jacks.....	4 sets
LINE input terminal	
RCA pin jacks.....	6 sets
MIC1 input terminal (XLR/TRS)	
XLR connector & 1/4" TRS jack	1 set
MIC2 input terminal (TRS)	
1/4" TRS jack	1 set
RETURN Input terminals (TS)	
1/4" TS jack	3 sets
DIGITAL IN coaxial input terminal	
RCA pin jacks.....	6 sets
MASTER output terminal	
XLR connector	1 set
RCA pin jacks.....	1 set
BOOTH output terminal (TRS)	
1/4" TRS jack	1 set

Specifications

REC OUT output terminal	
RCA pin jacks.....	1 set
SEND output terminal (TS)	
1/4" TS jack	3 sets
DIGITAL MASTER OUT AES/EBU	
XLR connector	1 set
MIDI OUT terminal	
5P DIN.....	1 set
PHONES output terminal	
1/4" stereo phone jack.....	2 sets
3.5 mm stereo mini jack	2 sets
USB terminal	
Type A.....	1 set
Power supply.....	5 V/2.1 A or less
Type B	2 sets
LINK terminal	
LAN terminal (100BASE-TX).....	1 set

The specifications and design of this product are subject to change without notice.

Block diagram

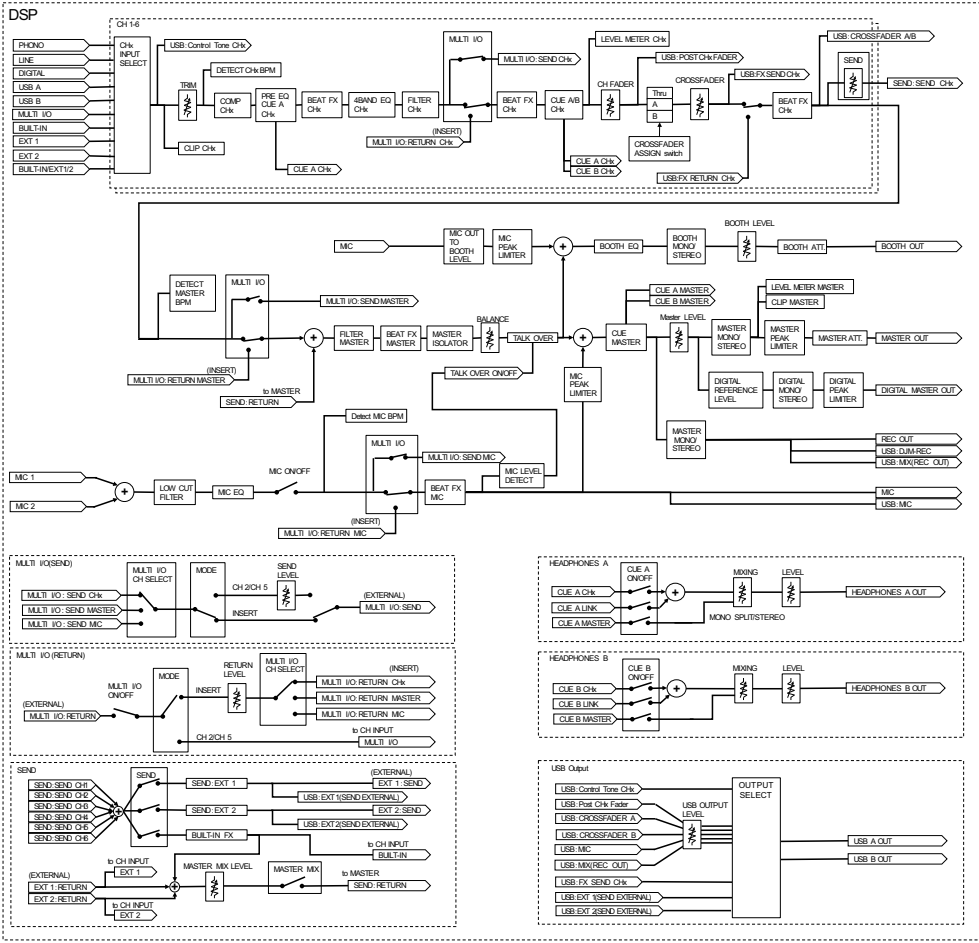
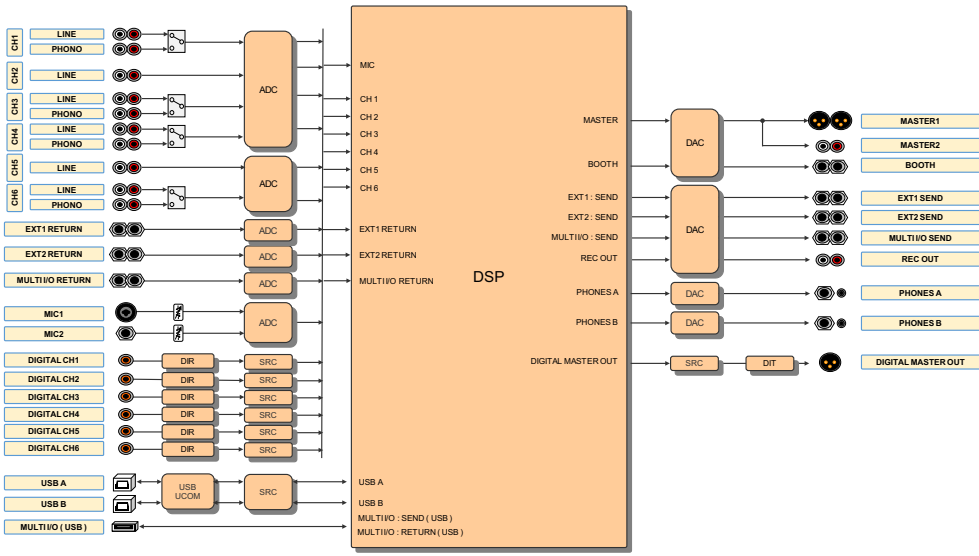

Additional information

Troubleshooting

If you think something is wrong with the unit, check the information below and refer to the [FAQ] for the DJM-V10 at the URL below.

pioneerdj.com/support/

- Inspect devices connected with the unit.
- The unit may restore proper operation after you turn it off and on.

If the problems continue, read the “Precautions for Use” and consult your nearest Pioneer DJ authorized service center or your dealer.

Power

❖ You cannot turn the unit on.

- Check if the power cord is properly connected to the unit and an AC outlet.

Audio output

❖ Sound is not outputting or the volume is low.

- Check the input selector switches are set properly.
- Check all cables are connected properly.
- Wipe any dust or dirt off the terminals and plugs before connecting them.
- Change the [ATT.] setting in [MASTER OUT] in the [UTILITY] settings.

❖ The unit does not output the digital sound.

- Make sure the specified [SAMPLING RATE] setting of [DIGITAL MASTER OUT] in the [UTILITY] settings is supported by the connected devices.

❖ Sound is distorted.

For the master sound:

- Adjust the [LEVEL] knob in the [MASTER] section so the master level indicator lights up with the peak level at around [0] dB.

- Set [ATT.] to a setting between [-3dB] and [-12dB] in [MASTER OUT] in the [UTILITY] settings.

For the channel input sound:

- Adjust the [TRIM] knob so the channel level indicator lights up with the peak level at around [0] dB.

❖ The crossfader does not work.

- Check the [CROSSFADER ASSIGN (A, THRU, B)] selector switch is set properly.

Effects

❖ BEAT FX does not work.

- Make sure the [BEAT FX ASSIGN] button is lit for the channel you want to add the effect to.
- Make sure the [FX FREQUENCY (HI, MID, LOW)] button is lit for the band you want to add the effect to.

❖ SEND does not work.

- Make sure the [SEND] knob is set properly.
- Make sure any external FX unit connected to the [EXT1 SEND] and [EXT1 RETURN] terminals, or the [EXT2 SEND] and [EXT2 RETURN] terminals, is plugged in properly.

❖ The SEND effect sound is not input to the master sound.

- Press the [MASTER MIX] button to turn on MASTER MIX.
- Make sure the [MASTER MIX LEVEL] knob in the [SEND] section is set properly.

❖ The SEND effect sound is not input to the channels.

- Set the input selector switch for the channel to [BUILT-IN], [EXT1], [EXT2], or [BUILT-IN, EXT1, EXT2].

❖ An external FX unit connected to MULTI I/O does not work.

- Select a channel to add the effect to with the [CH SELECT] switch.
- Press the [ON/OFF] button in the [MULTI I/O] section to turn on MULTI I/O.
- Make sure an external FX unit is properly connected to the [MULTI I/O SEND] and [MULTI I/O RETURN] terminals.
- Make sure mobile devices are properly connected to the mobile device connection terminal (USB terminal). Launch the FX application on the mobile device.

- Make sure the [MODE] selector button is set properly.

❖ **Sound from an external FX unit is distorted.**

- Make sure the volume for the external FX unit is set properly.

❖ **The tempo (BPM) of a track cannot be measured. The measured BPM is wrong.**

- Adjust the [TRIM] knob so the channel level indicator lights up with the peak level at around [0] dB.
- Tempo (BPM) cannot be measured for some tracks. Use the [TAP] button to manually set the tempo for those tracks.

❖ **The measured tempo (BPM) differs from the value on the CD.**

- The values do not match when BPM measuring methods are different.

MIDI

❖ **You cannot control a MIDI device with the unit.**

- Press the [MIDI ON] button to turn on MIDI.
- Assign this unit's MIDI messages to the software. For details on assignment, refer to the instruction manual for the software.

Connections

❖ **The unit is not recognized by the connected PC/Mac. The USB indicator is turned off or blinking.**

- Install the dedicated audio driver software on the PC/Mac. If the software is already installed, reinstall it.

❖ **Sound from the connected PC/Mac is not outputting from the unit.**

- Make sure the PC/Mac is connected properly (do not use a USB hub – connect directly to the unit).
- Select this unit in the audio output device settings in the software. For details, refer to the instruction manual for the software.

- Set the input selector switches to [≡A,B].

❖ **Sound is distorted when a turntable is connected to the [PHONO] terminals on the unit.**

The status of the channel level indicator does not change when you turn the [TRIM] knob.

- Check if the connected turntable has a built-in phono equalizer (if it does, connect the turntable to the [LINE] terminals).
- If the turntable has a PHONO/LINE selector switch, set it to PHONO.
- If the audio interface for PC/Mac, which is connected between the unit and the turntable, is a line-level device, connect the turntable to the [LINE] terminals.

LCD display

- Small black or shining points may appear on the LCD display. This is a phenomenon inherent to LCD displays and not a malfunction.
- When using the unit in cold places, the LCD display may be dark for a while after the power is turned on. Normal brightness will restore after a while.
- When the LCD display is exposed to direct sunlight, the light will reflect off it, making it difficult to see. Block the direct sunlight to improve visibility of the display.

Cleaning

Wipe with a dry soft cloth

- Do not use organic solvents, acids or alkalis for cleaning.

Touch display

- Operate the touch display with your fingertip. Do not press it with excessive force.
- Do not operate the touch display with hard and sharp-pointed objects such as a ballpoint pen, mechanical pencil, or sharp fingernail.

Trademarks and registered trademarks

- Pioneer DJ is a trademark of PIONEER CORPORATION and is used under license.
- rekordbox™ and KUVU are trademarks or registered trademarks of AlphaTheta Corporation.
- PRO DJ LINK™ is a trademark of AlphaTheta Corporation.
- Mac and macOS are trademarks of Apple Inc., registered in the U.S. and other countries.
- Windows is a registered trademark of Microsoft Corporation in the United States and other countries.
- ASIO is a trademark of Steinberg Media Technologies GmbH.

The names of companies and products mentioned herein are trademarks or registered trademarks of their respective owners.

About using MP3 files

This product has been licensed for nonprofit use. This product has not been licensed for commercial purposes (for profit-making use), such as broadcasting (terrestrial, satellite, cable or other types of broadcasting), streaming on the Internet, Intranet (a corporate network) or other types of networks or distributing of electronic information (online digital music distribution service). You need to acquire the corresponding licenses for such uses. For details, see <http://www.mp3licensing.com>.

Software license notice

The licenses for the open source software used on this player are shown below. For accuracy purposes, here we have included the original texts (in English).

Copyright © 2010 Texas Instruments Incorporated - <http://www.ti.com/>

Redistribution and use in source and binary forms, with or without modification, are permitted provided that the following conditions are met:

Redistributions of source code must retain the above copyright notice, this list of conditions and the following disclaimer.

Redistributions in binary form must reproduce the above copyright notice, this list of conditions and the following disclaimer in the documentation and/or other materials provided with the distribution.

Neither the name of Texas Instruments Incorporated nor the names of its contributors may be used to endorse or promote products derived from this software without specific prior written permission.

THIS SOFTWARE IS PROVIDED BY THE COPYRIGHT HOLDERS AND CONTRIBUTORS «AS IS» AND ANY EXPRESS OR IMPLIED WARRANTIES, INCLUDING, BUT NOT LIMITED TO, THE IMPLIED WARRANTIES OF MERCHANTABILITY AND FITNESS FOR A PARTICULAR PURPOSE ARE DISCLAIMED. IN NO EVENT SHALL THE COPYRIGHT OWNER OR CONTRIBUTORS BE LIABLE FOR ANY DIRECT, INDIRECT, INCIDENTAL, SPECIAL, EXEMPLARY, OR CONSEQUENTIAL DAMAGES (INCLUDING, BUT NOT LIMITED TO, PROCUREMENT OF SUBSTITUTE GOODS OR SERVICES; LOSS OF USE, DATA, OR PROFITS; OR BUSINESS INTERRUPTION) HOWEVER CAUSED AND ON ANY THEORY OF LIABILITY, WHETHER IN CONTRACT, STRICT LIABILITY, OR TORT (INCLUDING NEGLIGENCE OR OTHERWISE) ARISING IN ANY WAY OUT OF THE USE OF THIS SOFTWARE, EVEN IF ADVISED OF THE POSSIBILITY OF SUCH DAMAGE.

Cautions on copyrights

Recordings you have made are for your personal enjoyment and according to copyright laws may not be used without the consent of the copyright holder.

- Music recorded from CDs, etc., is protected by the copyright laws of individual countries and by international treaties. It is the full responsibility of the person who has recorded the music to ensure that it is used legally.
- When handling music downloaded from the Internet, etc., it is the full responsibility of the person who has downloaded the music to ensure that it is used in accordance with the contract concluded with the download site.

The specifications and design of this product are subject to change without notice.

© 2020 AlphaTheta Corporation. All rights reserved.

<DRI1643-B>