

UHF Synthesized Diversity Tuner

Operating Instructions

URX-S03D

Table of Contents

Features	3
Parts Identification	4
Preparation	5
Attaching to a Camcorder	5
Using Wireless Adapters	5
Settings	5
Setting the Receive Channel	5
Searching for Available Channels within a Group (Clear Channel Scan)	6
Searching for Active Channels within a Group (Active Channel Scan)	6
Setting the Comander Mode	6
Using the Squelch Function.....	7
Using the Infrared Communication Function.....	7
Menu Displays and Detailed Settings.....	9
Menu Structure and Hierarchy.....	9
Basic Menu Operations.....	9
UTILITY Menu	9
RX (tuner) 1/2 Menu	10
Error Messages	12
Troubleshooting	13
Important Notes on Use.....	14
Usage and Storage	14
Cleaning.....	14
Specifications	14

Features

The URX-S03D UHF Synthesized Diversity Tuner is a two-channel slot-in wireless tuner that can be used in conjunction with Sony professional camcorders and optional wireless adapters.

Two-channel camcorder-slot-in receiver

The unit is a camcorder slot-in receiver that supports systems that include two transmitters operating simultaneously. If your camcorder does not support slot-in mounting, you can attach the unit to an optional DWA-01D or DWA-F01D wireless adapter.

XDCAM compatibility

The two channels of digital signals processed by the unit's DSP can be sent directly to the camcorder via the 15-pin D-sub connector. The RF/AF levels of each wireless microphone can also be viewed via the camcorder's viewfinder.

HDCAM compatibility

The units' single channel of analog output signals can be sent directly to the camcorder via the 15-pin D-sub connector. Two different audio signals sent from two transmitters can also be mixed for output as a single-channel audio signal.

The RF/AF levels of each wireless microphone can also be viewed via the camcorder's viewfinder. When both channels are enabled, channel 1 is displayed. When only one channel is enabled, that channel is displayed.

True diversity system

The unit is equipped with two lines of reception for each channel that can receive signals from the transmitter simultaneously. The true diversity system determines the stronger of the two antennas signals and selects it automatically, achieving highly stable reception with minimal interruption and noise across a wide area.

Compatibility with Sony analog wireless microphones

The built-in DSP enables digital companding for high-quality audio transmissions. Switching to compander mode allows operation in conjunction with Sony analog wireless microphone system (UWP series and WRT series) transmitters.

High-visibility display

The area of the display screen is twice that of previous models, providing enhanced visibility. The built-in backlight also allows easy settings changing in even the darkest of shooting locations.

Channel scanning

Clear channel scanning for detecting unoccupied channels and active channel scanning for detecting used channels allow you to quickly assess the situation at a location and configure the appropriate channel.

Built-in infrared communication function

When operating in conjunction with UWP-D series transmitters, the frequency and compander mode settings configured on the unit can be sent using the infrared communication function, allowing you to complete channel configurations quickly.

Sturdy construction for use outdoors

Designed to withstand rough outdoor conditions with its solid dust-proof body, the unit meets JIS II drip-resistance standards when mounted on a camcorder with its antennas attached.

Switchable squelch function

A squelch function that can be turned on or off depending on the situation is available.

Parts Identification

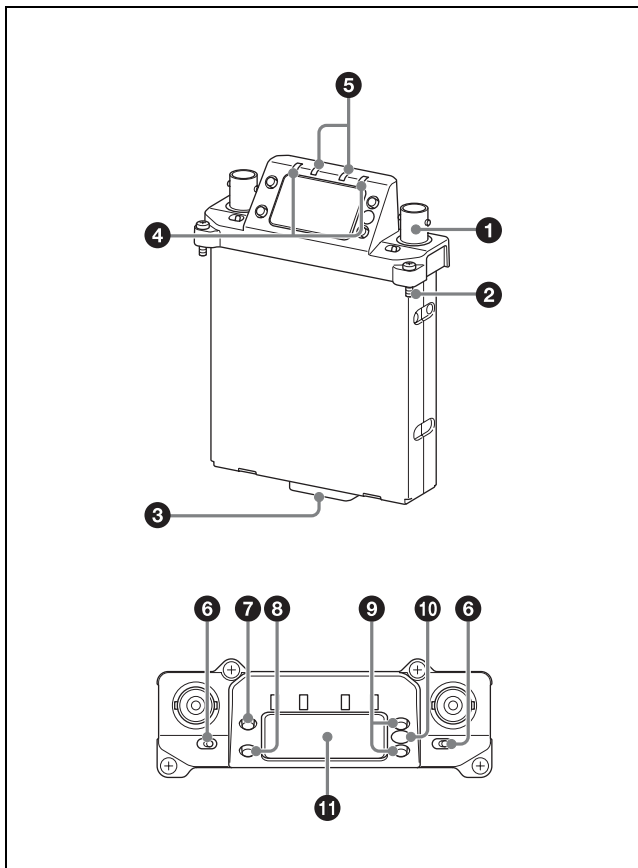

1 Antenna connector (BNC type)

Connect the supplied antenna here.

2 Mounting screw

Use to attach the receiver to a camcorder or wireless adapter.

3 Accessory connector (15-pin D-sub)

Use to connect the receiver to a camcorder or wireless adapter. Power, audio, and control signals are sent through this connector.

4 POWER indicator

Lights up green when the power is on. The POWER1 and POWER2 indicators indicate the power status of tuner 1 and tuner 2, respectively.

5 RF (radio frequency) indicators

Indicate the RF input level of tuner 1 and tuner 2.

On in green: 25 dB μ or more

On in red: 15 dB μ to 25 dB μ

Off: Less than 15 dB μ

0 dB μ = 1 μ V_{EMF}

6 POWER switches

Turn tuner 1 and tuner 2 on or off individually.

7 MENU button

Selects the displayed menu.

8 SET button

Changes the item to be set or enters the selected function or parameter value.

9 + or - button

Use to select a function or value.

10 Infrared transmission port

Transmits the frequency and compander mode settings configured on the unit to the transmitter.

11 Display section

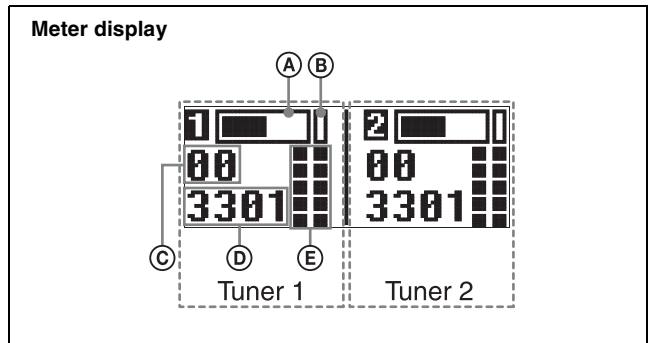

A Audio input level meter

Indicates the input signal level.

B Peak indicator

Warns of excessive input by lighting up when the signal is 3 dB below the level at which distortion begins.

C Group display

Displays the name of the receive group that is configured.

D Channel display

Displays the name of the receive channel that is configured.

E RF level meter

Indicates the RF input level. The number of segments that light up depends on the input level.

5 segments lit: 50 dB μ or higher

4 segments lit: 40 to 49 dB μ

3 segments lit: 30 to 39 dB μ

2 segments lit: 20 to 29 dB μ

1 segment lit: 10 to 19 dB μ

All segments off: 10 dB μ or less

Preparation

Attaching to a Camcorder

This receiver can be inserted into a slot provided on compatible Sony camcorders.

- 1 Remove the cover from the slot for the wireless receiver on the camcorder, and insert the receiver into the slot.

To avoid inserting the receiver in the wrong direction, confirm the location of the mounting screws before inserting the wireless receiver.

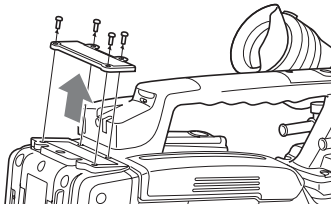

- 2 After inserting the receiver completely into slot, securely fasten the four mounting screws.

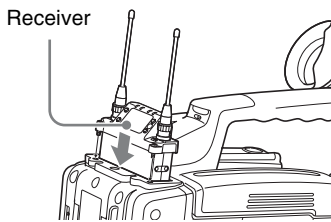

Using Wireless Adapters

Attaching the unit to an optional DWA-01D or DWA-F01D wireless adapter allows you to use the unit as a portable wireless receiver.

For details on attaching the unit, refer to the operating instructions supplied with the DWA-01D or DWA-F01D.

Settings

Setting the Receive Channel

For details about the channel groups and channels that can be selected, refer to the “Frequency List” on the CD-ROM.

Note

To prevent interference and noise, beware of the following.

- Do not use multiple transmitters that have been set to the same channel at the same time.
- When using two or more channels at the same time, always configure different channels within the same group.
- Keep all transmitters and receivers at least 3 m away from each other.

- 1 Set the POWER 1 or POWER 2 switch to ON.
- 2 Press the MENU button to display the RX1 or RX2 menu, and press the + or – button to display the GP/CH screen.
- 3 Press and hold the SET button for 1 second or longer. The channel group display starts flashing.

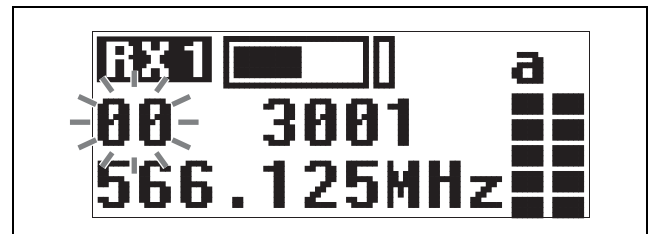

- 4 Use the + or – button to select the desired group name, then press the SET button.

The channel group is set, and the channel number display starts flashing.

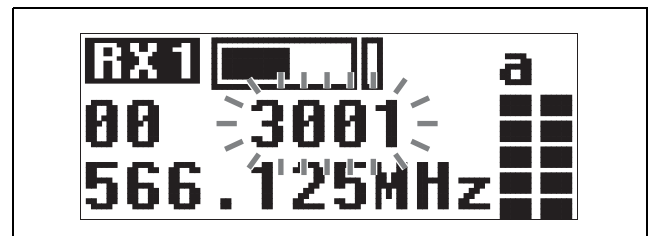

- 5 Use the + or – button to select the desired channel number, then press the SET button.

The displays stops flashing and the desired channel is set.

Notes

- If there is no user input within 10 seconds after the channel group display or channel number display starts flashing, the displayed setting that is flashing is saved. The same applies when setting other parameters.
- The frequency indicator changes in response to the channel number.
- The unit continues to receive, even when setting the receive channel.
- Make sure that the same channel is set on transmitters and receivers within the same system.

Searching for Available Channels within a Group (Clear Channel Scan)

You can search for available channels within the specified channel group.
Before performing this procedure, select the channel group.

For details, see “Setting the Receive Channel” (page 5).

- 1 Press the MENU button to display the RX1 or RX2 menu, and press the + or – button to display the CLR SCAN screen.
- 2 Press and hold the SET button for 1 second or longer.
Press and hold until the channel group and “+” display starts flashing.

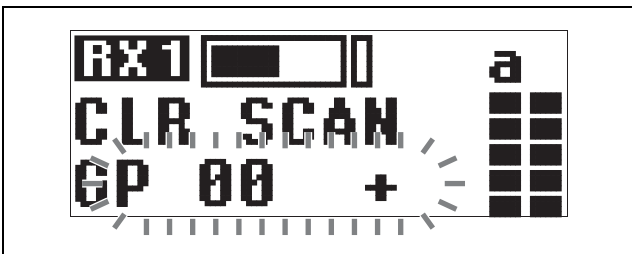

- 3 Press the + button.
The unit starts to scan through the selected channel group. When available channels are found, the first channel number among the available channels starts flashing on the display.
To display the next available channel number
Press the + button.
To cancel searching
Press the – button. The display returns to the CLR SCAN screen.
- 4 Press the SET button when the desired channel number starts flashing.
The search for available channels finishes and the displayed channel is set.

Searching for Active Channels within a Group (Active Channel Scan)

You can search for channels in use within the specified channel group. This is useful when using more than one receiver in combination with a single transmitter.
Before performing this procedure, select the channel group.

For details, see “Setting the Receive Channel” (page 5).

- 1 Press the MENU button to display the RX1 or RX2 menu, and press the + or – button to display the ACT SCAN screen.
- 2 Press and hold the SET button for 1 second or longer.
Press and hold until the channel group and “+” display starts flashing.

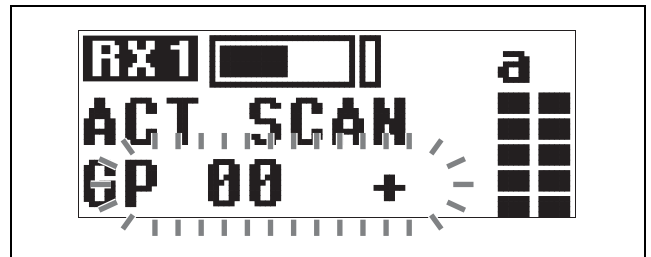

- 3 Press the + button.
The unit starts to scan for active channels in the selected channel group. When active channels are found, the first channel number among the active channels starts flashing on the display.
To display the next active channel number
Press the + button.
To cancel searching
Press the – button. The display returns to the ACT SCAN screen.
- 4 Press the SET button when the desired channel number starts flashing.
The search for active channels finishes and the displayed channel is set.

Setting the Compander Mode

Depending on the transmitter being used in conjunction with the unit, changing the compander mode may be necessary.
You can configure different compander modes for tuner 1 and tuner 2.

Notes

- When operating in conjunction with UWP-D series transmitters, set the transmitters to the same compander mode.
- No audio will be output if the tone signal frequency is different due to inconsistencies in compander mode settings configured on the devices being used together.
- When the squelch function (*page 7*) is set to OFF, audio will be output even when compander mode settings are not consistent. However, phenomena, such as changes in output level, may occur in such cases.

- 1 Press the MENU button to display the RX1 or RX2 menu, and press the + or – button to display the COMPANDER screen.
- 2 Press and hold the SET button for 1 second or longer. The selected item starts flashing.

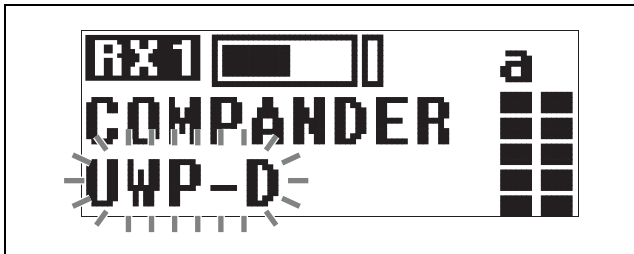

- 3 Use the + or – button to select the compander mode, then press the SET button.

The selected compander mode is configured.

UWP-D: Select this when operating in conjunction with Sony UWP-D series transmitters.

UWP: Select this when operating in conjunction with Sony UWP series transmitters.

WL800: Select this when operating in conjunction with Sony WRT series transmitters.

Transmitter and compander mode combinations

Configure the appropriate compander mode based on the transmitters being used.

Note

Audio will not be output if the combination of transmitters and compander mode settings are not correct.

Transmitter		Compander mode on unit		
		UWP-D	UWP	WL800
UWP-D series (UTX-B03, UTX-M03, UTX-P03, UTX-B03HR)	Compander mode: UWP-D	Yes	No	No
	Compander mode: UWP	No	Yes	No
	Compander mode: WL800	No	No	Yes

Transmitter	Compander mode on unit		
	UWP-D	UWP	WL800
UWP series (UTX-B2, UTX-H2, UTX-P1)	No	Yes	No
WRT series (WRT-822, etc.)	No	No	Yes

Using the Squelch Function

Using the squelch function allows you to suppress unwanted signals and noise while waiting for transmissions. Set the function to ON under normal circumstances. Set the function to OFF when you are searching for radio interference or external noise, for example.

The following squelch functions are available on the unit. However, the functions can only be enabled or disabled together and not individually.

- RF (radio frequency) squelch
Audio output is muted if the RF input level drops below the RF squelch level. The RF squelch level is fixed.
- Tone squelch
Audio output is muted unless radio waves that include specific tone signals are received.
- Noise squelch
Audio output is muted if the noise level rises above a specific level.

Note

Be sure to lower the volume on all connected devices before performing squelch function operations. If you disable the squelch function while waiting for transmissions or receiving low-level RF inputs, for example, the connected devices and speakers may be damaged due to noise.

- 1 Press the MENU button to display the RX1 or RX2 menu, and press the + or – button to display the SQUELCH screen.
- 2 Press and hold the SET button for 1 second or longer. The selected item starts flashing.
- 3 Use the + or – button to select whether to turn the squelch function ON/OFF, then press the SET button.

Using the Infrared Communication Function

When operating in conjunction with UWP-D series transmitters, the frequency and compander mode settings configured on the unit can be sent and applied to the transmitter using the infrared communication function.

Note

This function cannot be used when operating in conjunction with UWP or WRT series transmitters.

Searching for available channels and configuring the channel settings via infrared communication (AUTO SET)

- 1 Press the MENU button to display the RX1 or RX2 menu, and press the + or – button to display the AUTO SET screen.
- 2 Press and hold the SET button for 1 second or longer.
“YES” flashes on the display.

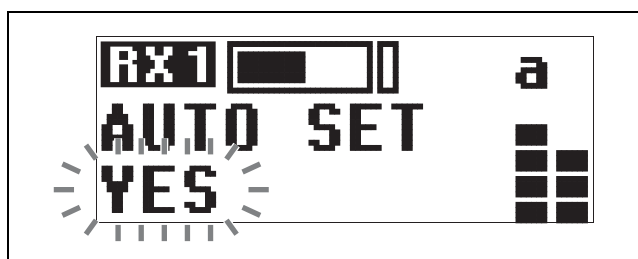

- 3 Press the SET button.

Clear Channel Scan starts searching for an available channel.
When Clear Channel Scan finishes, the channel with the least noise and interference will be set.
When the channel is set, infrared transmission starts automatically.

Note

Some noise may occur when power is turned on. Accordingly, turn down the audio input level of devices connected to the unit when turning the power on.

- 4 Press and hold the SET button on the transmitter and press the POWER/MUTING button to turn the power on.
- 5 Place the infrared transmitter port on the unit near the infrared detector on the transmitter.

Information about the channel set on the unit is sent to the transmitter, and a prompt appears on the transmitter display asking if you want to change to that frequency.

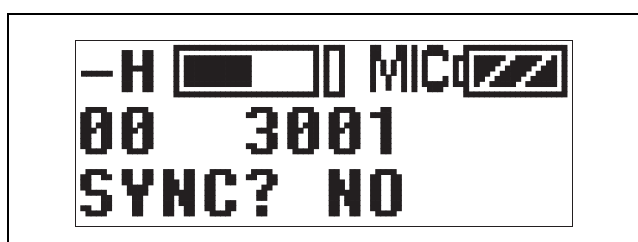

- 6 Use the + or – button to select “YES,” then press the SET button on the transmitter.

This sets the transmit channel and compander mode.

Notes

- The infrared transmission from the unit in step 3 continues for about 10 seconds. Perform steps 4 and 5 within those 10 seconds. If 10 seconds have elapsed, you can reestablish the infrared link using the SYNC screen on the unit.
- Place the unit and transmitter within about 20 cm (8 in.) of each other.
- If 5 seconds elapse without any user input after the prompt appears on the transmitter display, the transmitter returns to its previous state without changing the frequency.
- Communications using the infrared link may be adversely affected, depending on the surrounding environment. If this occurs, use the SYNC screen on the unit to reestablish the link.

Configuring the group/channel manually and configuring the channel settings via infrared communication (SYNC)

- 1 Configure the group/channel settings (*page 5*).
- 2 Press the MENU button to display the RX1 or RX2 menu, and press the + or – button to display the SYNC screen.
- 3 Press and hold the SET button for 1 second or longer.
A confirmation screen appears.
- 4 Use the + or – button to select “YES,” then press the SET button.
- 5 Press and hold the SET button on the transmitter and press the POWER/MUTING button to turn the power on.
- 6 Place the infrared transmitter port on the unit near the infrared detector on the transmitter.

Information about the channel set on the unit is sent to the transmitter, and a prompt appears on the transmitter display asking if you want to change to that frequency.

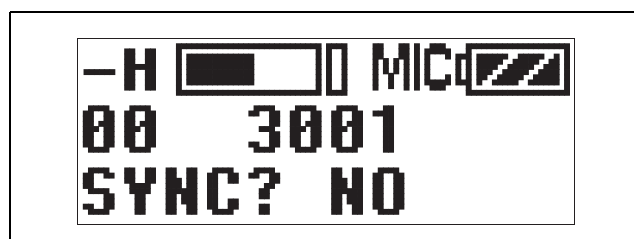

- 7 Use the + or – button to select “YES,” then press the SET button on the transmitter.

This sets the transmit channel and compander mode.

Menu Displays and Detailed Settings

Menu Structure and Hierarchy

Menu structure

UTILITY menu

You can display the UTILITY menu from the meter screen which displays information on tuners 1 and 2. This menu allows you to configure basic settings for the unit and settings for when the unit is used in conjunction with a wireless adapter.

RX1 (tuner 1) menu

This menu allows you to configure settings for RX1 (tuner 1).

RX2 (tuner 2) menu

This menu allows you to configure settings for RX2 (tuner 2).

Menu hierarchy

MENU

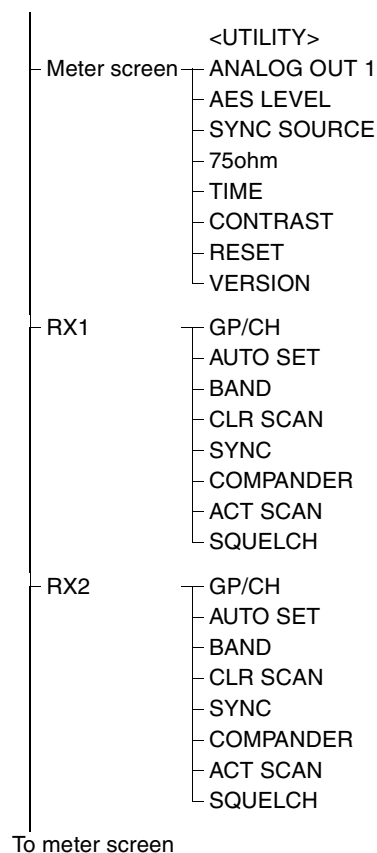

Basic Menu Operations

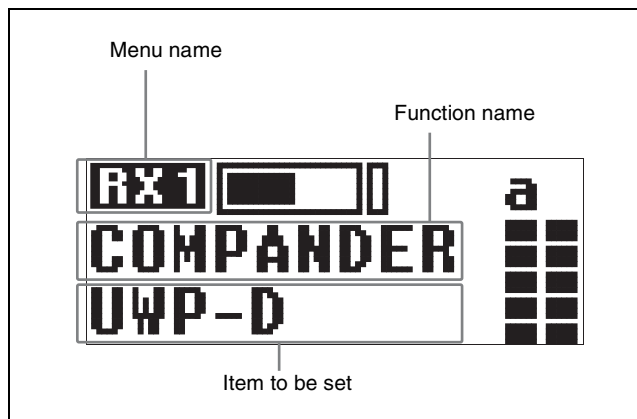

- 1 Press the MENU button repeatedly to select the menu.

Each time you press the MENU button, the menu changes in the following order:
meter screen, RX1, RX2, meter screen
If you want to configure settings in the UTILITY menu, display the meter screen.
- 2 Press the + or – button repeatedly until the function to be set appears.
- 3 Hold down the SET button until the item to be set flashes.
- 4 Press the + or – button to change the setting.
- 5 Press the SET button to apply the setting.

Note

When the tuner is turned off, the menus corresponding to that tuner are not displayed.

UTILITY Menu

The UTILITY menu includes basic settings for the unit and settings for when the unit is used in conjunction with a wireless adapter. These functions and parameters are explained here. Underlined items are the factory setting.

Note

The functions indicated by “ADAPTER” in the upper-right corner are related to the AES/EBU output when the receiver is used in conjunction with an optional wireless adapter. The function does not operate even when used with a compatible Sony slot-in type camcorder.

Selecting output 1 (ANALOG OUT1)

Select the output signal for when a camcorder with only one channel of analog input (e.g., HDCAM) is connected. In addition, when the unit is attached to a DWA-01D

wireless adapter and you are using the OUTPUT 2 connector of the DWA-01D for AES/EBU output, select the signal to be used as the OUTPUT 1 connector's sub output.

Notes

- OUTPUT 2 settings cannot be configured.
- Adjust the volume for each channel using the attenuator function on the transmitter.

RX1: Outputs the audio signal received on tuner 1.

RX2: Outputs the audio signal received on tuner 2.

RX1+2: Mixes and outputs the audio signals received on tuners 1 and 2.

Selecting the AES/EBU output reference level (AES LEVEL)

Select the reference level for the AES/EBU output of an optional wireless adapter.

Note

The function does not operate for analog output.

-36dB LINEAR: The audio signal from the transmitter is output with a headroom of 36 dB.

-20dB LIMIT: The reference level is changed to -20 dBFS in conformity with the normal AES/EBU interface and the audio signal from the transmitter is compressed.

-20dB ST LIM: The reference level is changed to -20 dBFS (as in the -20dB LIMIT mode above) and audio signal compression is linked for tuner 1 and tuner 2. Select this setting when sending stereo audio signals using 2 transmitters.

Selecting the sync signal (SYNC SOURCE)

Select the sync signal source for the receiver when it is attached through the optional wireless adapter. The receiver supports an external sync signal (word clock) of 32 kHz -6% to 96 kHz +6%.

For details on locking the sync signal, refer to the operating instructions supplied with the wireless adapter.

INTERNAL: The internal sync signal (48 kHz) is used.

AUTO: The external sync signal is used on a priority basis. When there is no external sync signal input, the internal sync signal is used automatically. The currently selected sync signal is displayed "INTERNAL" or "EXTERNAL."

EXTERNAL: Synchronization with an external word clock signal. The current synchronization status is displayed "UNLOCK" or "LOCK."

Terminating the sync signal (75ohm)

This function provides termination for the WORD SYNC connector on the wireless adapter.

ON: 75-ohm termination is added.

OFF: 75-ohm termination is not added.

Note

When the receiver is turned off, the termination is released.

Displaying the accumulated running time (TIME)

Display the accumulated running time of the unit as a guide to total usage time.

The factory default setting is 00:00. Up to 99:99 can be displayed.

To reset the time display

- 1 Press and hold the SET button until the time display starts flashing.
- 2 Press the - button to display "00:00 CLR" and press the SET button.

Pressing the + button when "00:00 CLR" is displayed causes the time display to start flashing. You can press the SET button in this state to cancel the reset of the accumulated running time.

Setting the display contrast (CONTRAST)

Adjust the contrast of text and icons on the display in the range 1 to 10.

The configurable values are given below.
(Light) 1 2 3 4 5 6 7 8 9 10 (Dark)

Restoring factory default settings (RESET)

Restore all parameters to their factory default settings. Press and hold the SET button. A prompt appears asking you whether to restore factory default settings. Press the + or - button to select YES, then press the SET button. The unit parameters are restored to their factory default settings.

Displaying the software version (VERSION)

Display the software version of the unit.

RX (tuner) 1/2 Menu

For details on menu operation, see "Basic Menu Operations" (page 9).

Use this menu to set the digital wireless receiver functions (the main functions of this receiver).

Selecting group/channel (GP/CH)

The factory default setting varies depending on the model.

For details, see “Setting the Receive Channel” (page 5).

For details, see “Using the Squelch Function” (page 7).

Setting an available channel automatically (AUTO SET)

Automatically search for and set an available channel, and start infrared transmission to the transmitter.

For details, see “Searching for available channels and configuring the channel settings via infrared communication (AUTO SET)” (page 8).

Selecting the frequency band (BAND)

Select the receive frequency band.

Note

This menu is not available on Japanese and Korean models. On these models, the frequency band cannot be selected.

For details about the groups and channels in each frequency band, refer to the “Frequency List” on the CD-ROM.

Searching for and selecting available channels (CLR SCAN)

Search for available channels.

For details, see “Searching for Available Channels within a Group (Clear Channel Scan)” (page 6).

Using infrared transmission (SYNC)

Transfer the frequency and compander mode set on the unit to a transmitter using an infrared transmitter.

For details, see “Configuring the group/channel manually and configuring the channel settings via infrared communication (SYNC)” (page 8).

Setting the compander mode (COMPANDER)

Set the operating mode of the compander.

For details, see “Setting the Compander Mode” (page 6).

Setting the frequency to an active channel (ACT SCAN)

Search for channels already in use. This is useful when using more than one receiver in combination with a single transmitter.

For details, see “Searching for Active Channels within a Group (Active Channel Scan)” (page 6).

Setting the squelch function (SQUELCH)

Enable the squelch function to suppress unwanted signals and noise while waiting for transmissions.

Error Messages

When a problem occurs, one of the following error messages may appear on the display.

Message	Meaning	Solution
EEP ERROR	An error has occurred in the backup memory data.	Contact your Sony service representative.
PLL ERROR	An error occurred in the PLL synthesizer circuit.	Restart the unit. If the message persists, contact your Sony service representative.
NO TONE	Audio signal output has been muted, because a tone signal different from the compander mode configured on the unit was received.	Configure the appropriate compander mode based on the transmitters you are using " <i>Setting the Compander Mode</i> " (page 6). When operating in conjunction with UWP-D series transmitters (UTX-B03, UTX-M03, etc.), set the unit and the transmitters to the same compander mode.

Troubleshooting

If you have any problem, use the following checklist before asking for repairs. If the problem persists, contact your Sony service representative.

Symptom	Cause	Solution
The unit does not turn on.	The unit is not correctly inserted into the slot of the camcorder or the wireless adapter.	Insert the unit until it is firmly and completely in, and then secure it with the mounting screws.
There is no sound.	The channel setting on the transmitter is different from that on the receiver.	Use the same channel setting on both the transmitter and receiver.
	The compander mode setting on the transmitter is different from that on the receiver.	Use the same compander mode setting on both the transmitter and receiver.
	When the receiver is attached to a wireless adapter, the setting of the sync signal is not appropriate.	Using the sync signal selection (SYNC SOURCE) function, set the sync signal to INTERNAL. When an external sync signal is used, confirm the connection of the sync signal, and set to AUTO or EXTERNAL.
The sound is distorted.	The channel setting on the transmitter is different from that on the receiver.	Use the same channel setting on both the transmitter and receiver.
	The compander mode setting on the transmitter is different from that on the receiver.	Use the same compander mode setting on both the transmitter and receiver.
There is sound interruption or noise.	The channel setting on the transmitter is different from that on the receiver.	Use the same channel setting on both the transmitter and receiver.
	Two or more transmitters are set to the same channel.	Two or more transmitters cannot be used on the same channel. Refer to the frequency list stored on the supplied CD-ROM, and reconfigure the channel on each transmitter.
	The transmitters are not set to the channels within the same channel group.	The channel plan is set so that no signal interference occurs when two or more transmitters are used simultaneously. Set each transmitter to a different channel within the same channel group.
	Adjacent channels are being used.	Use the channels separated by at least two channels (250 kHz).
	Jamming radio waves are being received.	Set the channel on the receiver to a channel for which the RF indicator does not light, or use the Clear Channel Scan function to switch to a channel without interference. Then, set the transmitter to the same channel as the receiver. If using two or more transmitters, change to a channel group that is not affected.
	The squelch function is set to OFF.	Set the squelch function to ON (<i>page 7</i>).
The RF indicator on the receiver lights up even when the transmitter is off.	Jamming radio waves are being received.	Set the channel on the receiver to a channel for which the RF indicator does not light, or use the Clear Channel Scan function to switch to a channel without interference. Then, set the transmitter to the same channel as the receiver. If using two or more transmitters, change to a channel group that is not affected.
The transmitter channel cannot be set with infrared transmission.	The infrared receptor on the transmitter is too far from the infrared transmission port on the receiver.	Reduce the distance between the infrared receptor on the transmitter and the infrared transmission port on the receiver to within about 20 cm (8 in.).
	Interference from infrared communications between other devices or from direct sunlight is present.	The transmitting distance is reduced when interference from strong sunlight, for example, is present. Place the transmitter and receiver as close to each other as possible.

Important Notes on Use

Usage and Storage

- Operating the UWP-D series devices near electrical equipment (motors, transformers, or dimmers) may cause interference due to electromagnetic induction. Keep the devices as far from such equipment as possible.
- The presence of lighting equipment may produce electrical interference over a wide frequency range. In this case, interference may fluctuate with the position of the receiver antenna and position of the transmitter. Position the devices so that interference is minimized.
- To avoid degradation of the signal to noise ratio, do not use UWP-D devices in noisy places or in locations subject to vibration, such as the following:
 - Near electrical equipment, such as motors, transformers, or dimmers
 - Near air conditioning equipment or places subject to direct air flow from an air conditioner
 - Near PA (public address) loudspeakers
 - Near equipment that might knock against the receiverKeep devices as far from such equipment as possible or use buffering material.

Cleaning

Clean the surface and the connectors of devices with a dry, soft cloth. Never use thinners, benzene, alcohol, or any other chemicals, since these may mar the finish.

To prevent electromagnetic interference

Some channels may be unable to be used due to noise generated due to the effects of external noise and/or radio interference. In this case, it is recommended to stop transmitting (turn the power off) or change to another frequency (change channel).

To prevent electromagnetic interference from portable communication devices

The use of portable telephones and other communication devices near the devices may result in malfunction and interference with audio signals. It is recommended that portable communication equipment near the devices be turned off.

Specifications

Antenna connector	BNC-R, 50 Ω (2)
RF squelch level	15 dB μ / OFF (0 dB μ = 1 μ V)
Audio output level	–40 dBu (0 dBu = 0.775 Vrms with modulating frequency of 1 kHz and frequency deviation of \pm 5.0 kHz)
Accessory connector	D-sub connector (15-pin) (1)
Reception method	True diversity method
Local oscillator	Crystal-controlled PLL synthesizer
Receive frequencies	Models available in USA: 470 MHz to 542 MHz (UC14 model), 536 MHz to 608 MHz (UC25 model), 566 MHz to 608 MHz and 614 MHz to 638 MHz (UC30 model), 638 MHz to 698 MHz (UC42 model) Models available in Europe: 470 MHz to 542 MHz (CE21 model), 566 MHz to 630 MHz (CE33 model), 638 MHz to 694 MHz (CE42 model), Model available in China: 710 MHz to 782 MHz (CN38 model) Model available in Korea: 925 MHz to 937.5 MHz (KR Model) Model available in Thailand 794 MHz to 806 MHz (E model)
Signal-to-noise-ratio	60 dB or more (A-weighted)
Voice delay	0.375 ms
Deemphasis	50 μ s
Reference frequency deviation	\pm 5 kHz
Frequency response	40 Hz to 18 kHz
Distortion	0.9% or less (with modulating frequency of 1 kHz and frequency deviation of \pm 5.0 kHz)
Tone signal	In UWP-D compander mode: 32.382 kHz In UWP compander mode: 32 kHz In WL800 compander mode: 32.768 kHz
Indicators	POWER 1/2, RF 1/2
Operating temperature	0 $^{\circ}$ C to 50 $^{\circ}$ C (32 $^{\circ}$ F to 122 $^{\circ}$ F)
Storage temperature	–20 $^{\circ}$ C to +55 $^{\circ}$ C (–4 $^{\circ}$ F to +131 $^{\circ}$ F)
Supply voltage	7.0 V DC (supplied from camcorder or wireless adapter)
Current consumption	200 mA or less (during 7 V DC)

Dimensions

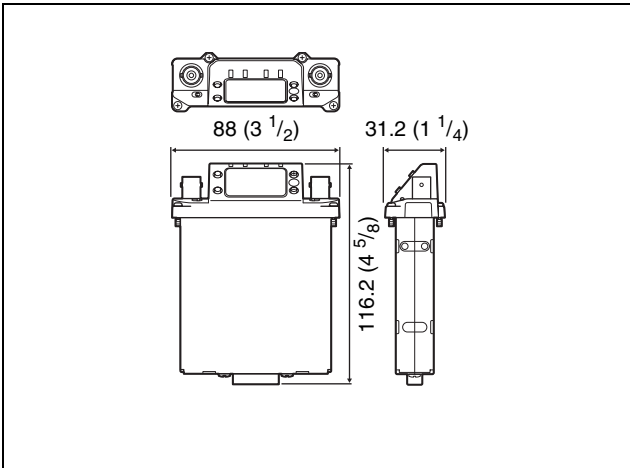

88 × 116.2 × 31.2 mm
(3 1/2 × 4 5/8 × 1 1/4 in.)
(width / height / depth)

Mass Approx. 303 g (11 oz.)
(with supplied antennas attached)

Supplied accessories

Whip antenna (2)
Before Use (1)
CD-ROM (1)
Warranty card (1)

Design and specifications are subject to change without notice.

Notes

- Always verify that the unit is operating properly before use. SONY WILL NOT BE LIABLE FOR DAMAGES OF ANY KIND INCLUDING, BUT NOT LIMITED TO, COMPENSATION OR REIMBURSEMENT ON ACCOUNT OF THE LOSS OF PRESENT OR PROSPECTIVE PROFITS DUE TO FAILURE OF THIS UNIT, EITHER DURING THE WARRANTY PERIOD OR AFTER EXPIRATION OF THE WARRANTY, OR FOR ANY OTHER REASON WHATSOEVER.
- SONY WILL NOT BE LIABLE FOR CLAIMS OF ANY KIND MADE BY USERS OF THIS UNIT OR MADE BY THIRD PARTIES.
- SONY WILL NOT BE LIABLE FOR THE TERMINATION OR DISCONTINUATION OF ANY SERVICES RELATED TO THIS UNIT THAT MAY RESULT DUE TO CIRCUMSTANCES OF ANY KIND.

<http://www.sony.net/>

Sony Corporation