

# Operating Instructions

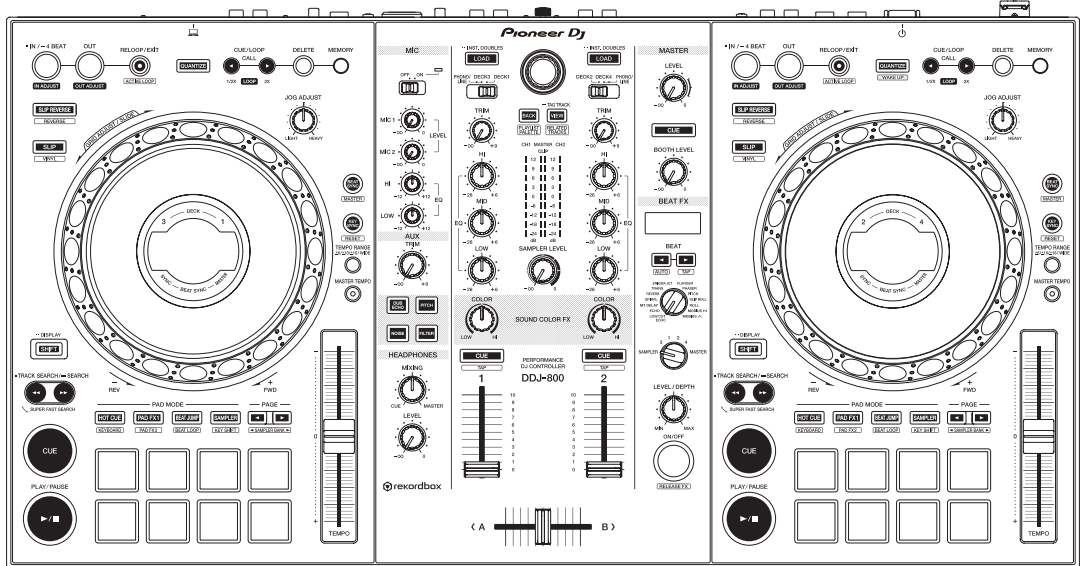

DJ Controller

# DDJ-800

[pioneerdj.com/support/  
rekordbox.com](http://pioneerdj.com/support/rekordbox.com)

For FAQs and other support information for this product, visit the above site.

**Pioneer Dj**

## How to read this manual

- Thank you for purchasing this Pioneer DJ product.  
Be sure to read this manual and the “Operating Instructions (Quick Start Guide)” included with the unit. Both documents include important information that you should understand before using this product.
- In this manual, names of buttons and terminals indicated on the unit, names of menus in the PC/Mac screen, etc., are indicated within square brackets ([ ]). (e.g. **[FILE]**, **[CUE]** button, **[PHONES]** output terminal)
- Please note that the screens and specifications of the software and the external appearance and specifications of the hardware are subject to change without notice for improvement and may differ from those described in this manual.
- Depending on the operating system version, web browser settings, etc., operation may differ from the procedures described in this manual.

This manual consists mainly of explanations of functions of this unit as hardware. For detailed instructions on operating the rekordbox software, see the rekordbox Operating Instructions.

- The rekordbox Operating Instructions can be downloaded from the following site.  
[rekordbox.com/manual](http://rekordbox.com/manual)

---

---

# Contents

## 01 Before start

Accessories .....	5
Viewing Introduction / Operating Instructions of rekordbox .....	6
rekordbox .....	6
Installing rekordbox .....	8

## 02 Part names and functions

Top panel of the unit.....	11
Browser section.....	12
Deck sections .....	14
Jog dial display section .....	22
Mixer section .....	26
Rear panel.....	31
Front panel .....	33

## 03 Basic operation

Example of connections .....	34
Starting the system.....	39
Turning off the system.....	44

## 04 Advanced operation

Using 4 beat loops.....	45
Using manual loops.....	45
Using the performance pads .....	47
Switching the mixer mode .....	57
Using slip mode.....	58
Using the fader start function .....	62
Using effects.....	63
Using the BEAT FX function.....	64
Types of BEAT FX.....	66
Using the SOUND COLOR FX function .....	74
Using a microphone .....	77
Using external inputs.....	79

## **05 Changing the settings**

Changing the settings with the unit .....	83
Changing the settings with rekordbox .....	84
Setting utility software .....	91

## **06 Additional information**

Troubleshooting .....	94
Liquid crystal display .....	101
Signal flow .....	101
Specifications .....	102
Using this unit as a controller for other DJ software .....	104
Trademarks and registered trademarks .....	114
Cautions on copyrights .....	115

---

---

# Before start

---

---

## Accessories

- AC adapter
- Power cord
- USB cable
- Warranty (for some regions) <sup>[1]</sup>
- Operating Instructions (Quick Start Guide)
- rekordbox dj license key card <sup>[2]</sup>

[1] Products for Europe only. (The corresponding information is provided on the back cover of the “Operating Instructions (Quick Start Guide)” for Japan, and on the last page of the English and French versions of the “Operating Instructions (Quick Start Guide)” for the North American region.)

[2] For the latest information, see the site below.  
[rekordbox.com](http://rekordbox.com)

## Cautions

The license key cannot be reissued. Be careful not to lose it.

---

---

## Viewing Introduction / Operating Instructions of rekordbox

- For setting up rekordbox, see Introduction.
- For using Collection, EXPORT mode and PERFORMANCE mode, see Operating Instructions.

**1 Launch a web browser on your PC/Mac and access the following site.**

rekordbox.com

**2 Click [Manual] under [Support].**

**3 Click the required language of rekordbox Introduction or rekordbox Operating Instructions.**

---

---

## rekordbox

- rekordbox

rekordbox is music management software for DJs to prepare tracks and perform DJ play.

- rekordbox dj

The DJ performance function of rekordbox is called rekordbox dj. rekordbox dj can be used by simply connecting the unit to a PC/Mac. If you wish to use rekordbox dj on a PC/Mac without connecting the unit, enter the license key shown on the rekordbox dj license key card included with this product to use rekordbox dj.

\* For the latest information, see the site below.

rekordbox.com

## Operating environment

Supported operating systems	CPU and required memory
Mac: macOS Mojave 10.14 macOS High Sierra 10.13 macOS Sierra 10.12 (latest update)	Intel® processor Core™ i7, i5, i3 4 GB or more of RAM
Windows: Windows® 10 Windows® 8.1 Windows® 7 32-bit version or 64-bit version (latest service pack)	Intel® processor Core™ i7, i5, i3 4 GB or more of RAM

Others	
USB port	A USB 2.0 port is required to connect the PC/Mac with this unit.
Display resolution	1 280 x 768 or greater
Internet connection	An Internet connection is required for registering the rekordbox user account and downloading the software.

- Operation is not guaranteed on all PC/Mac, even if all the required operating environment conditions indicated here are fulfilled.
- Depending on power saving settings, etc. of the PC/Mac, the CPU and hard disk may not provide sufficient processing capabilities. For a laptop PC/Mac, in particular, make sure the PC/Mac is in the proper conditions to provide constant high performance (for example, by keeping the AC power connected) when using rekordbox.
- A separate contract with an Internet service provider and payment of the utilization fee are required to access the Internet.
- Use the latest version/service pack of the operating system.
- For information on the latest system requirements, compatibility, and supported operating systems of rekordbox, see the site below.  
[rekordbox.com/system](http://rekordbox.com/system)

---

---

## Installing rekordbox

---

### Preparing rekordbox

Install the software by following the procedure below when you use rekordbox for the first time or if you are using rekordbox 4.x or an earlier version.

If rekordbox Ver.5.x is already installed, update rekordbox to the latest version using Update Manager which is shown when starting rekordbox.

- The user is responsible for preparing a PC/Mac, network devices, and other elements of the Internet usage environment required for a connection to the Internet.

---

### Installation procedure

The installation procedure depends on the operating system (OS) of your PC/Mac.

#### ❖ Installation (for Mac)

Do not connect this unit and the Mac until installation is completed.

- If any other programs are running on the Mac, quit all of them.
- 1 Unzip the downloaded rekordbox software file.**
  - 2 Double-click the rekordbox software to launch the installer.**



## 3 Read the license agreement, and select [Agree] if you agree to the terms.

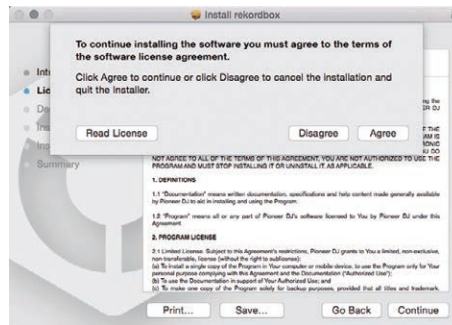

- If you do not agree to the contents of the license agreement, click [Disagree] to cancel the installation.

## 4 If the installation completion screen appears, click [Close] to close the rekordbox installer.

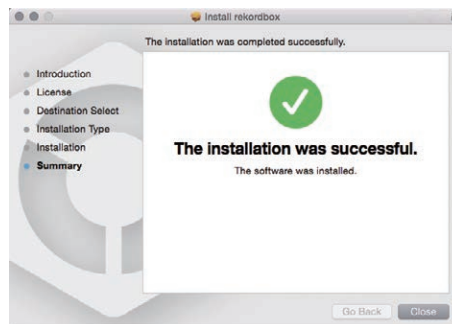

### ❖ Installation (for Windows)

Do not connect this unit and the PC until installation is completed.

- Log on as the user which was set as the PC's administrator before installation.
- If any other programs are running on the PC, quit all of them.

### 1 Unzip the downloaded rekordbox software file.

### 2 Double-click the rekordbox software to launch the installer.

### 3 Read the license agreement, select **[Agree]** if you agree to the terms, and click **[Next]**.

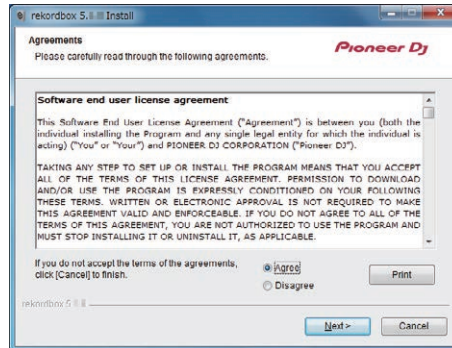

- If you do not agree to the license agreement, click **[Cancel]** to cancel the installation.

After the installation destination is specified, the installation starts.

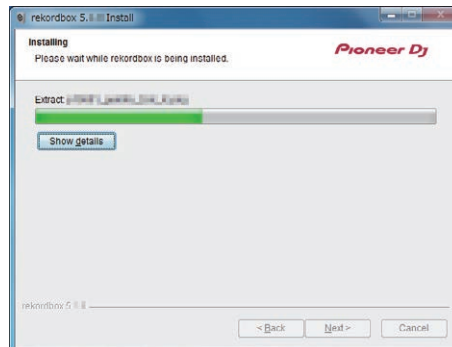

When the installation is completed, an installation successful message appears.

### 4 Click **[Finish]** to close the rekordbox installer.

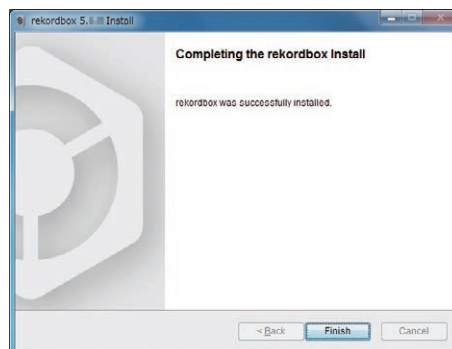

The installation is completed.

# Part names and functions

## Top panel of the unit

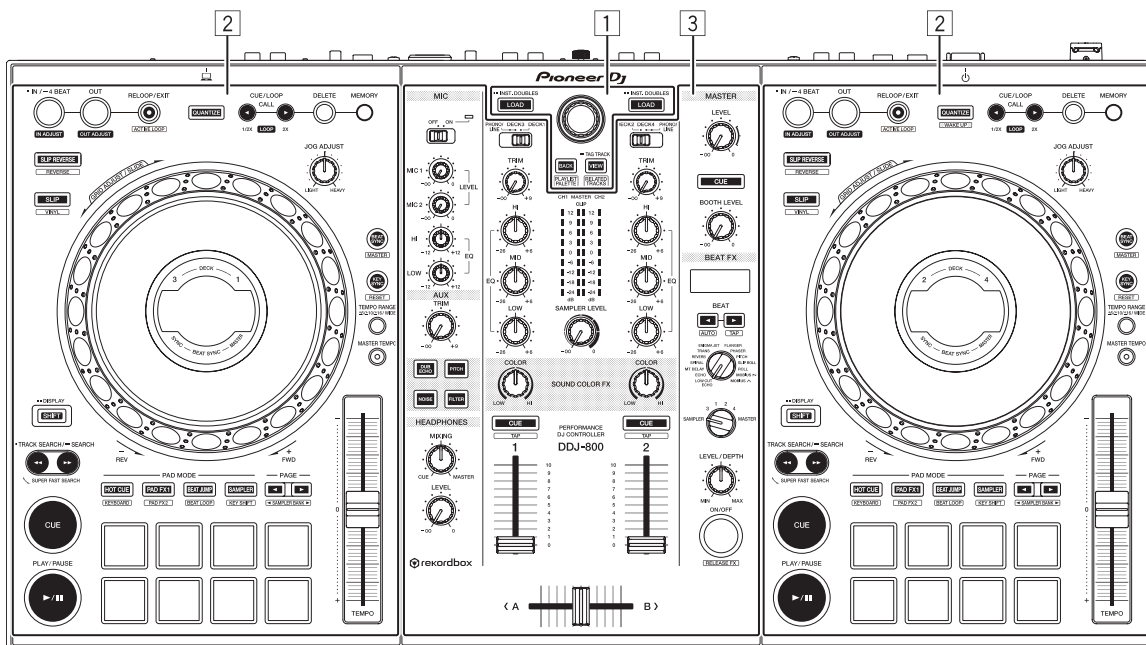

1 **Browser section**

2 **Deck sections**

3 **Mixer section**

## Browser section

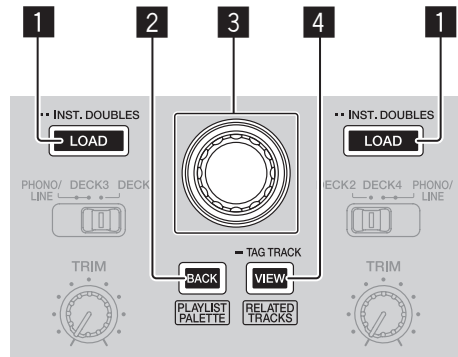

### 1 LOAD button

Press:

The selected tracks are loaded to the respective decks.

Press twice:

Loads the track loaded in the deck not being operated to the deck on the operation side.

The playback position is also loaded in the same state. (Instant Doubles)

### 2 BACK button

Press:

Moves the cursor between the tree view and track list each time the button is pressed. Also, if the cursor is on a folder, closes that folder.

- If the playlist palette is displayed, the cursor can be moved among the tree view, the track list, and the playlist.
- The tree view, track list, and playlist palette are in the browse section of rekordbox dj. For details, see the rekordbox Operating Instructions.

**[SHIFT]** + Press:

Displays or hides the rekordbox dj playlist palette.

## 3 Rotary selector

Rotate:

Moves the selection cursor in rekordbox dj.

**[SHIFT]** + Rotate:

Zooms in/out the enlarged waveform of rekordbox dj.

Rotate to the right to enlarge the waveform, and rotate to the left to reduce.

Press:

Moves the cursor between the tree view and track list each time you press the button. Also, if the cursor is on a folder, opens that folder.

- If the playlist palette is displayed, the cursor can be moved among the tree view, the track list, and the playlist.
- The tree view, track list, and playlist palette are in the browse section of rekordbox dj. For details, see the rekordbox Operating Instructions.

## 4 VIEW button

Press:

Reduces the size of the rekordbox dj deck and expands the browser area.

Press again to undo the change.

**[SHIFT]** + Press:

Moves the cursor to **[Related Tracks]** in the tree view area.

Press + Hold:

Registers or deletes the selected track to **[Tag List]**.

## Deck sections

This section is used to control the four decks. The buttons and controls for operating decks 1 and 3 are located on the left side of the controller, and those for operating decks 2 and 4 are located on the right side of the controller.

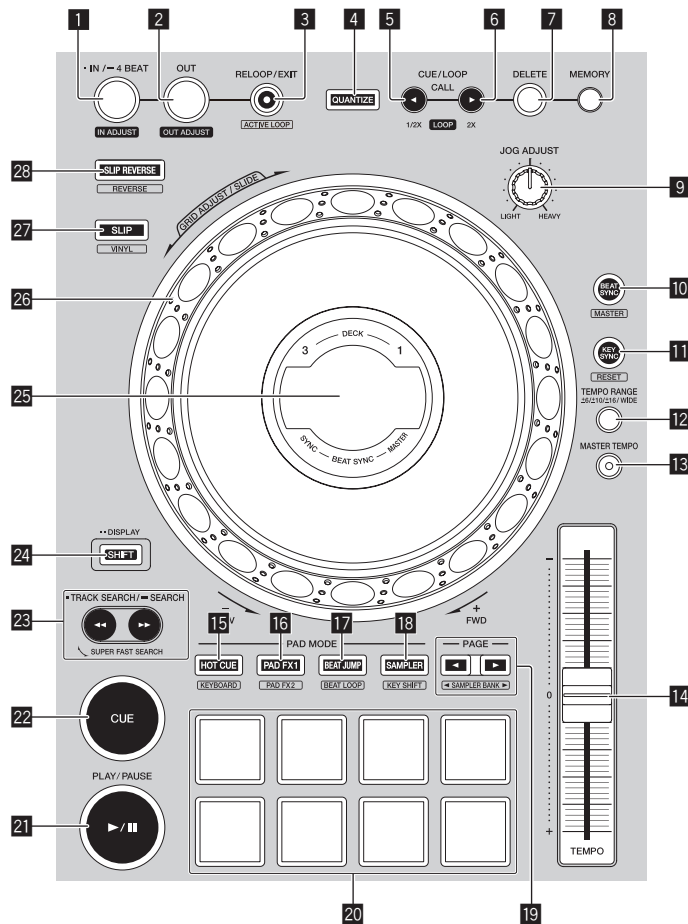

### 1 LOOP IN/4 BEAT (IN ADJUST) button

Press:

Sets a loop in point.

Press during loop playback:

The loop in point can be fine-adjusted using the jog dial.

Press for over 1 second:

Turns the auto 4-beat loop on.

## 2 LOOP OUT (OUT ADJUST) button

Press:

Sets a loop out point and starts loop playback.

Press during loop playback:

The loop out point can be fine-adjusted using the jog dial.

## 3 RELOOP/EXIT button

Press:

Returns to the last set loop in point and resumes loop playback.

Press during loop playback:

Cancels loop playback.

**[SHIFT]** + Press:

Switches the loop saved in the track between active and non-active. (Active Loop)

- When you press this button while pressing the **[SHIFT]** button in playback mode, the loop closest to the playback position becomes active.
- When you select a loop in a track and press the button while pressing the **[SHIFT]** button, the loop becomes active/non active (toggle feature).

## 4 QUANTIZE button

Press:

Turns on the quantize function.

If the quantize function is turned on, hot cue point, etc. is automatically set to the nearest beat position.

- The resolution of the quantized beat can be selected in **[Preferences]** of rekordbox.

Press (in standby mode):

Cancels standby mode.

- This operation is limited to the button of the deck on the right side.

## **5 CUE/LOOP CALL, ◀ (LOOP 1/2X) button**

Press:

Select and call a cue point or loop point stored in a track.

Press during loop playback:

Halves the loop playback length.

- Even if you press the button, the length of the loop will not change while playback is paused at a loop in point.

## **6 CUE/LOOP CALL, ▶ (LOOP 2X) button**

Press:

Select and call a cue point or loop point stored in a track.

Press during loop playback:

Doubles the loop playback length.

- Even if you press the button, the length of the loop will not change while playback is paused at a loop in point.

## **7 DELETE button**

Delete a cue point or loop point.

➔ *Deleting cue points (p.56)*

## **8 MEMORY button**

Stores a cue point or loop point.

➔ *Setting cue points (p.56)*

## **9 JOG FEELING ADJUST control**

Adjusts the load when you spin the jog dial.

Turn clockwise to increase the load, and turn counterclockwise to decrease the load.



## 10 BEAT SYNC button

Press:

Automatically synchronizes with the tempos (pitches) and beat grids of the deck set as the master for synchronization.

[SHIFT] + Press:

Sets the deck whose button is pressed as the master deck for synchronization.

## 11 KEY SYNC button

Shifts the key of the track that's played on the deck to the same key as the target track, to a dominant key (5 degrees higher), or to a subdominant key (4 degrees higher).

[SHIFT] + Press:

Resets the key of the track that's played on the deck to its original key.

## 12 TEMPO RANGE button

Changes the [TEMPO] slider's range of variation each time the button is pressed.



## 13 MASTER TEMPO button

Turns the master tempo function on and off.

When the master tempo function is on, the key does not change even if the playback speed is changed with the [TEMPO] slider.

## 14 TEMPO slider

Adjusts the playing speed of tracks.

## 15 HOT CUE mode button

Press:

Sets hot cue mode.

➔ *Using hot cues* (p.47)

[SHIFT] + Press:

Sets keyboard mode.

➔ *Using the keyboard mode* (p.53)

## 16 PAD FX1 mode button

Press:

Sets pad FX mode 1.

➔ *Using the pad FX* (p.48)

[SHIFT] + Press:

Sets pad FX mode 2.

➔ *Using the pad FX* (p.48)

## 17 BEAT JUMP mode button

Press:

Sets beat jump mode.

➔ *Using beat jump* (p.50)

[SHIFT] + Press:

Sets beat loop mode.

➔ *Using beat loops*(p.54)

## 18 SAMPLER mode button

Press:

Sets sampler mode.

➔ *Using the sampler function* (p.51)

[SHIFT] + Press:

Sets key shift mode.

➔ *Using the key shift function* (p.55)

## 19 PAGE ◀, ▶ button

Press:

Switches the page of the pad in each pad mode.

➔ *Using the performance pads (p.47)*

[SHIFT] + Press:

Switches the sampler bank.

## 20 Performance pads

Achieves various performances.

➔ *Using the performance pads (p.47)*

## 21 PLAY/PAUSE ▶/II button

Plays or pauses the track.

## 22 CUE button

Sets, calls, and plays cue points.

- To set a cue point, press the **[CUE]** button while the track is paused.
- During playback, press the **[CUE]** button to return to the cue point and pause playback. (Back Cue)
- After the playback position returned to the cue point, you can keep playing the track by holding down the **[CUE]** button. (Cue Sampler)

[SHIFT] + Press:

Brings the playback position to the beginning of the track.

## 23 TRACK SEARCH ◀◀, ▶▶/SEARCH button

Press:

Searches for the beginning of a track.

Press + Hold:

Fast-forwards or rewinds the track while the button is kept pressed.

## 24 **SHIFT button**

You can access an alternative function when operating a button while holding down the **[SHIFT]** button.

Press twice:

Press this button when changing the display between the INFO screen and ARTWORK screen.

➡ *ARTWORK screen* (p.25)

## 25 **Jog dial display section**

➡ *Jog dial display section* (p.22)

## 26 **Jog dial**

Turn on VINYL mode and spin the top of the jog dial:  
Scratching.

Spin the outer section, or, spin the top of the jog dial when VINYL mode is off:

Pitch bend (adjusting the playing speed)

**[SHIFT]** + Spin the top of the jog dial:

The beat grid interval for the loaded track can be adjusted.

**[SHIFT]** + Spin the outer section:

The entire beat grid of the loaded track can be slid to the left or right.

**[TRACK SEARCH]** + Spin the top of the jog dial:

You can fast forward or rewind the track at a high speed. (Super Fast Search)

## 27 **SLIP button**

Press:

Turns slip mode on and off.

➡ *Using slip mode* (p.58)

**[SHIFT]** + Press:

Turns VINYL mode on and off.

## **28 SLIP REVERSE button**

Press:

Plays a track in the reverse direction while this button is pressed, and resumes normal playback when the button is released.

- Normal playback continues in the background of the reverse playback. If the button is released, normal playback resumes from the current point playing in the background.
- Slip reverse play is automatically canceled after 8 beats and normal playback resumes even if the **[SLIP REVERSE]** button is kept pressed.

**[SHIFT]** + Press:

Plays a track in the reverse direction. Reverse playback is canceled and normal playback resumes when the **[SHIFT]** and **[SLIP REVERSE]** buttons are pressed again.

## Jog dial display section

### INFO screen

When a track from rekordbox is loaded, the following information is displayed on the jog dial display section.



#### 1 Deck number

The number of the deck currently being operated lights up.

#### 2 Artwork

Displays the artwork of the track loaded in rekordbox dj. You can change whether to display or hide the artwork in **[Preferences]** of rekordbox.

➔ *Changing the settings with rekordbox (p.84)*

#### 3 Key variation

Displays the variation between the track's original key and the current key.

#### 4 Key

Displays the current key.

## 5 CUE SCOPE

Indicates the cue points, loop points, and hot cue points set from 4 bars before to 16 bars after the current playback position. When cue/loop point is set/called, markers are indicated for 4 bars from the set/called the point. You can change whether to display or hide the CUE SCOPE in **[Preferences]** of rekordbox.

➔ *Changing the settings with rekordbox (p.84)*

## 6 Deck status

The current status of the deck is indicated by the background color.

White (bright): Deck 1 or 2 is selected and on air

White (dark): Deck 1 or 2 is selected and off air

Blue (bright): Deck 3 or 4 is selected and on air

Blue (dark): Deck 3 or 4 is selected and off air

Red (bright): Slip playback

- The slip playback takes precedence regardless of the on-air state of the deck.

## 7 Cue point

Displays the position of the set and called cue point.

## 8 BPM

The current BPM is displayed.

## 9 Playing speed

The value changes according to the position of the **[TEMPO]** slider.

## 10 Playing speed adjustment range

Displays the range that the playing speed can be adjusted.

## 11 Waveform

Displays the waveform of the sound.

The waveform is displayed according to the settings of **[Waveform]** in **[Preferences]** of rekordbox, so you can change the color and format (**[Full Waveform]**/**[Half Waveform]**) at the Preferences. For details on the changing of settings, see the rekordbox Operating Instructions.

# Part names and functions

## **12 Cue/loop/hot cue points set in the loaded track**

Displays the cue points, loop points, and hot cue points set in the loaded track.

## **13 Playback position**

Displays the current playback position.

## **14 Time (minutes, seconds)**

Displays the remaining time or elapsed time.

You can change the displayed information in **[Preferences]** of rekordbox.

➡ *Changing the settings with rekordbox* (p.84)

- The number of loop beats (loop length) is displayed during loop playback.

## **15 MASTER**

Lights up when the deck being operated is set as the master.

## **16 Playback status**

Displays the current playback position.

Rotates during playback, and stops when paused.

## **17 SYNC**

Lights up when **[BEAT SYNC]** is turned on.



---

## ARTWORK screen

The following information is displayed on the jog dial display section.



### 1 Deck number

The number of the deck currently being operated lights up.

### 2 Playback status

Displays the current playback position.

Rotates during playback, and stops when paused.

### 3 Artwork

Displays the artwork of the track loaded in rekordbox dj.

### 4 SYNC

Lights up when **[BEAT SYNC]** is turned on.

### 5 Cue point

Displays the position of the set and called cue point.

### 6 MASTER

Lights up when the deck being operated is set as the master.

## Mixer section

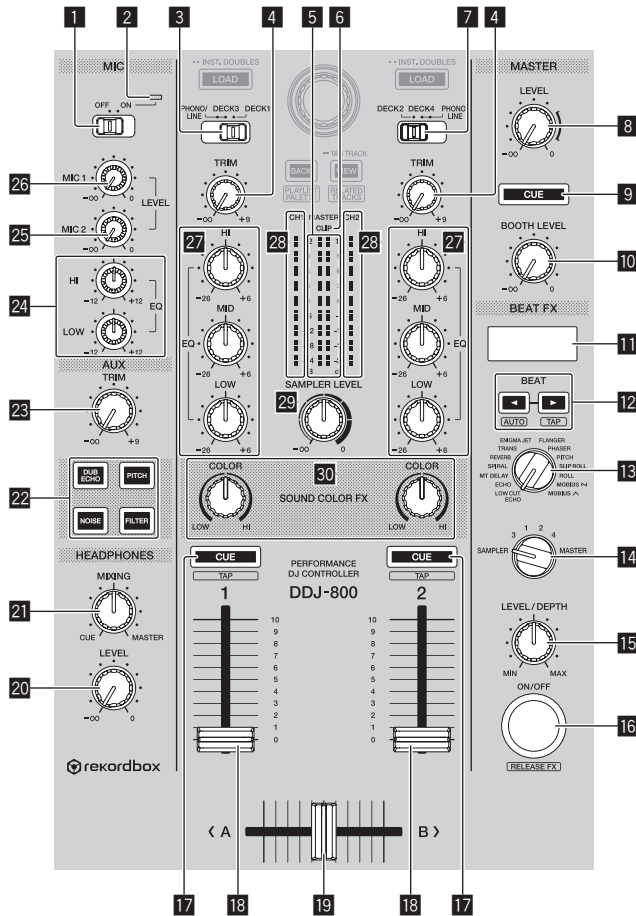

### 1 MIC ON, OFF selector switch

Turns the microphone on and off.

➔ *Using a microphone (p.77)*

### 2 Microphone indicator

➔ *Using a microphone (p.77)*

## 3 PHONO/LINE, DECK3, DECK1 selector switch

Selects the input source for each channel from the components connected to this unit.

- **[DECK1], [DECK3]:** Select this to use the track loaded in a deck of rekordbox dj.
- **[PHONO/LINE]:** Select this to use a phono level (for MM cartridges) output device (analog player, etc.) or a line level output device (DJ player, etc.) connected to the **[LINE/PHONO]** input terminals.

➔ *Using external inputs (p.79)*

## 4 TRIM control

Adjusts the level of sound output from each channel.

## 5 Master level indicator

Displays the level of sound output to the master channel.

## 6 CLIP indicator

**[CLIP]** blinks when the output level is too high.

- Blinking slowly: indicates that the sound is about to be distorted.
- Blinking quickly: Indicates that the sound is distorted.

## 7 DECK2, DECK4, PHONO/LINE selector switch

Selects the input source for each channel from the components connected to this unit.

- **[DECK2], [DECK4]:** Select this to use the track loaded in a deck of rekordbox dj.
- **[PHONO/LINE]:** Select this to use a phono level (for MM cartridges) output device (analog player, etc.) or a line level output device (DJ player, etc.) connected to the **[LINE/PHONO]** input terminals.

➔ *Using external inputs (p.79)*

## 8 MASTER LEVEL control

Adjusts the level of sound output to the master channel.

## 9 MASTER CUE button

Outputs the sound of the master channel to the headphones.

## 10 BOOTH LEVEL control

Adjusts the level of sound output to the booth channel.

## 11 Effect section display

Displays the effect name, BPM, effect parameter, etc.

## 12 BEAT ◀, ▶ buttons

Press:

Set the beat fraction to synchronize the effect sound with.

Press [SHIFT] + [BEAT ◀]:

Sets the mode for automatically measuring the BPM from the input audio signal.

Press [SHIFT] + [BEAT ▶]:

Sets the mode for inputting the BPM manually.

## 13 BEAT FX SELECT control

Sets the BEAT FX type.

## 14 BEAT FX CH SELECT control

Switches the channel to which the BEAT FX is to be applied.

## 15 BEAT FX LEVEL/DEPTH control

Adjusts the BEAT FX quantitative parameter.

## 16 BEAT FX ON/OFF button

Press:

Turns BEAT FX on and off.

[SHIFT] + Press:

Turns on rekordbox release FX.

➡ *Using the BEAT FX function (p.64)*

## 17 Headphones CUE button

Press:

Outputs the sound of the channel for which this button is pressed to the headphones.

[SHIFT] + Press:

The tempo for each deck can be set by tapping this button. (Tap function)

## 18 Channel fader

Adjusts the level of sound output from each channel.

## 19 Crossfader

Outputs the sound of the channels assigned to the left and right sides of the crossfader.

## 20 HEADPHONES LEVEL control

Adjusts the level of sound output to the headphones.

## 21 HEADPHONES MIXING control

Adjusts the balance of the monitor volume between the sound of the channels for which the headphones [CUE] button is pressed and the sound of the master channel.

## 22 SOUND COLOR FX SELECT buttons

Turns on and off SOUND COLOR FX.

➔ *Using the SOUND COLOR FX function (p.74)*

## 23 AUX TRIM control

Adjusts the sound level of the **AUX** input.

➔ *Using the AUX function (p.82)*

## 24 MIC EQ (HI, LOW) control

Adjusts the sound quality of the [MIC 1] and [MIC 2] channels.

## 25 MIC 2 LEVEL control

Adjusts the level of sound output from the [MIC 2] channel.

# Part names and functions

## **26 MIC 1 LEVEL control**

Adjusts the level of sound output from the **[MIC 1]** channel.

## **27 EQ (HI, MID, LOW) control**

Boosts or cuts frequencies for the different channels.

## **28 Channel level indicator**

Displays the sound level of each channel before it passes through the channel faders.

## **29 SAMPLER LEVEL control**

Adjusts the sound level of the sampler.

## **30 COLOR control**

Changes the parameters of the SOUND COLOR FX of the different channels.

Do not pull out the channel fader and crossfader forcibly. The controls have a structure that prevents them from being pulled off easily. Pulling the controls may damage them.

## Rear panel

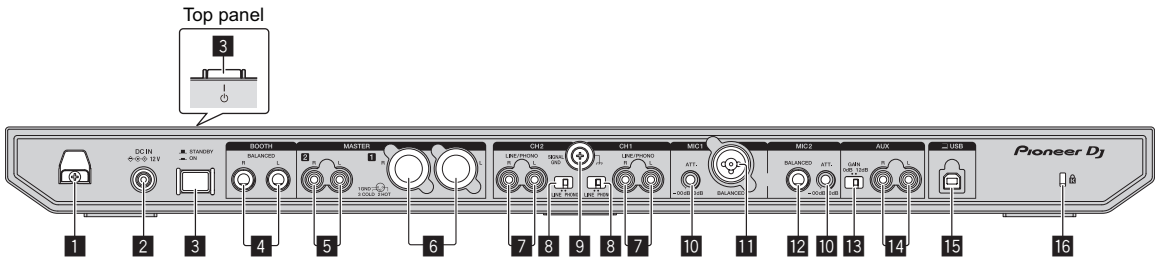

### 1 DC cord hook

Hook for the AC adapter power cord.

- If the AC adapter is disconnected during playback, the sound will be interrupted.

### 2 DC IN terminal

Connect to a power outlet using the included AC adapter (with the included power cord connected).

- Connect the AC adapter after all the connections between devices are completed.
- Use the included AC adapter.

### 3 switch

Turns this unit on or puts this unit into standby mode.

### 4 BOOTH output terminals

Output terminals for booth monitor.

- Compatible with TRS connector type balanced outputs.

Be sure to use these as balanced outputs.

- The master channel sound can be output from the **[BOOTH]** output terminals regardless of the audio level set for the master channel.

The volume level can be adjusted with the **[BOOTH LEVEL]** control.

### 5 MASTER 2 output terminals

Connect a powered speaker, a power amp, etc.

- Compatible with RCA pin-jack type unbalanced outputs.

## 6 MASTER 1 output terminals

Connect a powered speaker, a power amp, etc.

- Compatible with XLR connector type balanced outputs.

Be sure to use these as balanced outputs.

- **Be careful not to accidentally insert the power cord of another unit.**
- **Do not connect a terminal that can supply phantom power.**

## 7 LINE/PHONO input terminals

Connect a phono level (for MM cartridges) output device (analog player, etc.) or a line level output device (DJ player, etc.). Switch the input source according to the connected device using the **[LINE/PHONO]** switch on the rear panel of this unit.

- The **[PHONO/LINE, DECK3, DECK1]** selector switch or **[DECK2, DECK4, PHONO/LINE]** selector switch on top of the unit needs to be set to **[PHONO/LINE]**.

## 8 LINE/PHONO switches

Selects the input source for each channel from the components connected to this unit.

- **[LINE]**: Uses a line level output device (DJ player, etc.) connected to the **[LINE/PHONO]** input terminals.
- **[PHONO]**: Uses a phono level (for MM cartridges) output device (analog player, etc.) connected to the **[LINE/PHONO]** input terminals.

## 9 SIGNAL GND terminal

Connect a ground wire of an analog player to reduce noise that occurs when an analog player is connected.

## 10 MIC attenuator

Adjusts the level of the audio input to the **[MIC]** terminals.

- The gain of the audio input to the microphone differs greatly depending on the microphone being used. The **[MIC ATT.]** control on the rear panel of the unit is used to adjust the audio level according to the microphone before DJ performances. During DJ performances, use the **[MIC LEVEL]** control on the top of this unit to adjust the volume of the microphone.



## 11 MIC 1 input terminal

Connect a microphone.

- Only an XLR connector can be used.

## 12 MIC 2 input terminal

Connect a microphone.

- Only phone plugs (Ø 6.3 mm) can be used.

## 13 AUX gain selector switch

Switches the **AUX** input gain depending on the connected device.

## 14 AUX input terminals

Connect to a DJ player or line level output device or a portable player.

## 15 USB terminal

Connect to a PC/Mac.

- Connect this unit and your PC/Mac directly with the included USB cable or one that conforms to USB 2.0.
- Do not use a USB hub.

## 16 Kensington security slot

---

---

## Front panel

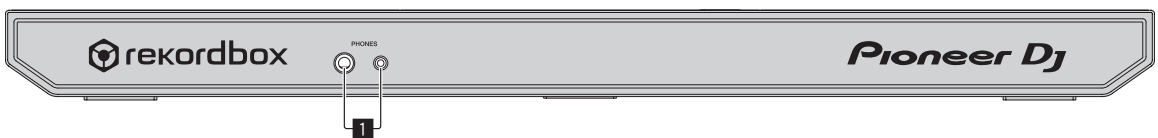

## 1 PHONES output terminals

Connect headphones.

Stereo phone plugs (Ø 6.3 mm) and stereo mini phone plugs (Ø 3.5 mm) can be used.

Do not use the two output terminals (one for a stereo phone jack and one for a mini-phone jack) simultaneously. If a cable is connected to or disconnected from one of the terminals while another terminal is in use, the volume for the terminal in use may increase or decrease unintentionally.

---

---

# Basic operation

- Connect the power cord to a power outlet after all the connections are completed.

Turn off this unit and disconnect the power cord from the power outlet before connecting components or changing the connections.

Refer to the operating instructions for the components to be connected.

- Be sure to use the included power cord and AC adapter.
- Be sure to use the USB cable included with this product or one that conforms to USB 2.0.
- A USB hub cannot be used.

---

---

## Example of connections

---

---

### Connecting input terminals

#### Rear panel

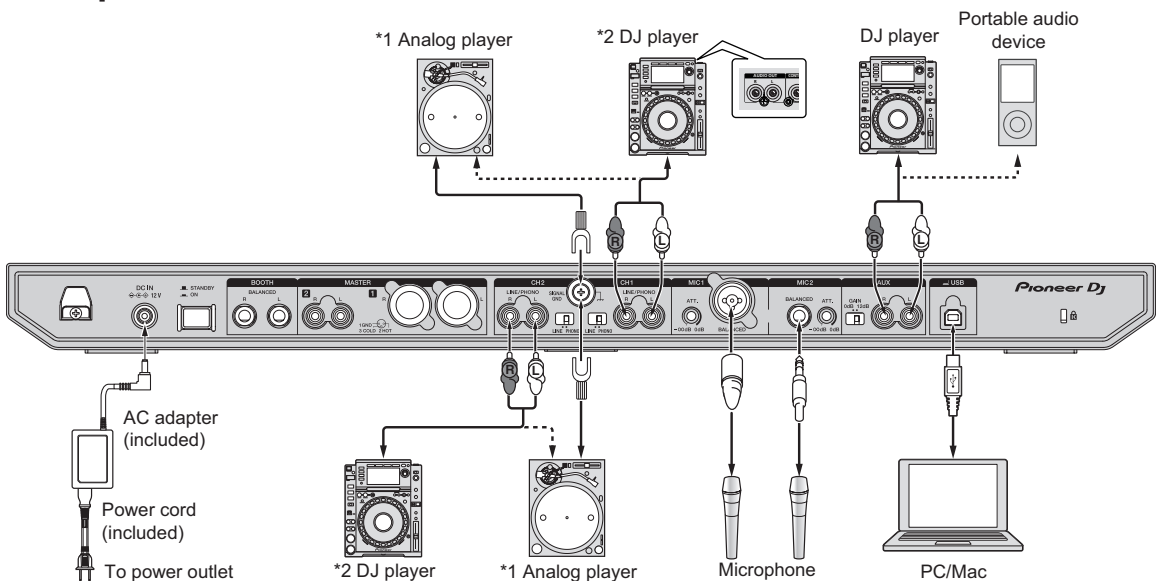

\*1 When connecting an analog player, select the **[LINE/PHONO]** switch beside the terminals to **[PHONO]**.

\*2 When connecting a DJ player, select the **[LINE/PHONO]** switch beside the terminals to **[LINE]**.

---

## Cord hook

### ● Hooking the AC adapter power cord onto the cord hook

Fasten the AC adapter power cord into place by hooking it onto the cord hook. This prevents the power cord from being accidentally pulled and causing the plug to get disconnected from the terminal.

- Do not fasten with the base of the AC adapter power cord bent. If used continuously under these conditions, the power cord may be damaged, resulting in faulty contact.
- If the AC adapter is disconnected during playback, the sound will be interrupted.

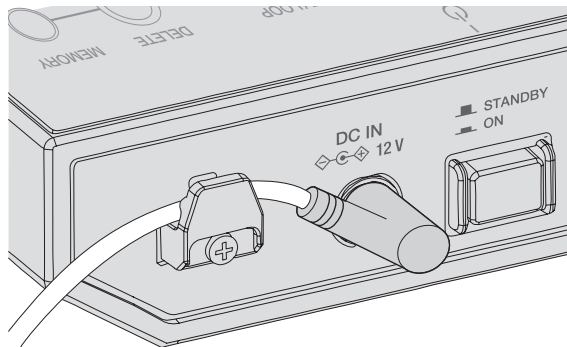

## Connecting output terminals

### Rear panel

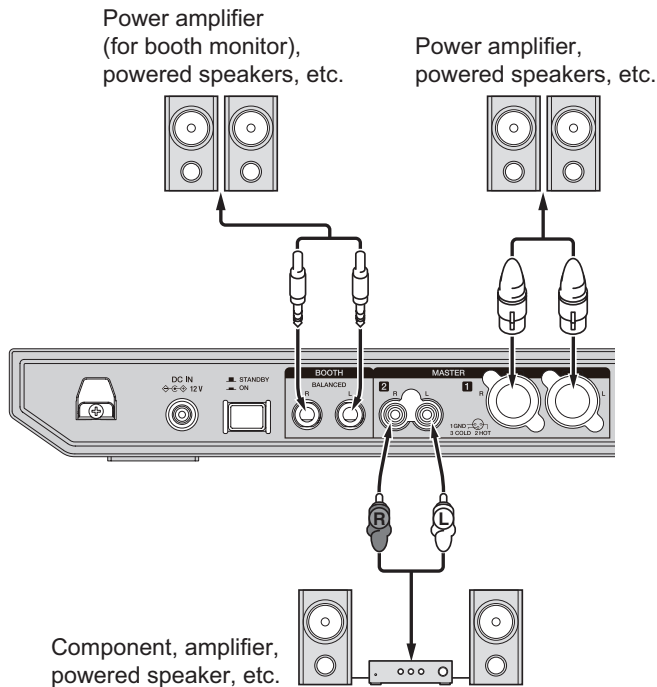

### Front panel

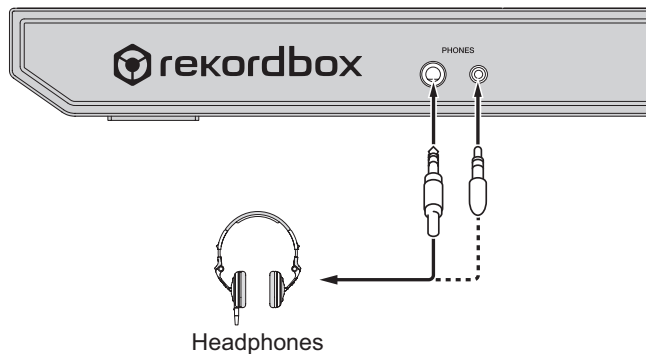

- Be sure to use the **[MASTER 1]** output terminals for a balanced output. If they are connected to an unbalanced input (such as RCA) using an XLR to RCA converter cable (or converter adapter), etc., the sound quality may be lowered or noise may occur.

For connection with an unbalanced input (such as RCA), use the **[MASTER 2]** output terminals.

- Be careful not to accidentally insert the power cord plug of another unit into a [MASTER 1] output terminals.

Do not connect terminals capable of supplying phantom power to the [MASTER 1] output terminals.

- Be sure to use the [BOOTH] output terminals for a balanced output. If they are connected to an unbalanced input (such as an RCA or TS terminal) with an TRS to RCA converter cable (or converter adapter), TS cable, etc., the sound quality may be lowered or noise may occur.

---

## Connections

- 1 Connect headphones to the [PHONES] output terminals.

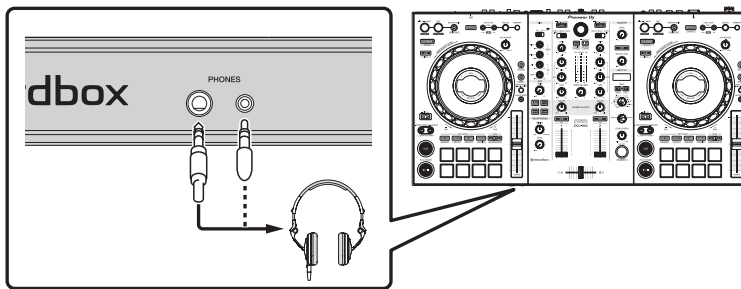

- 2 Connect devices such as powered speakers, a power amplifier, and components to the [MASTER 1] or [MASTER 2] output terminals.

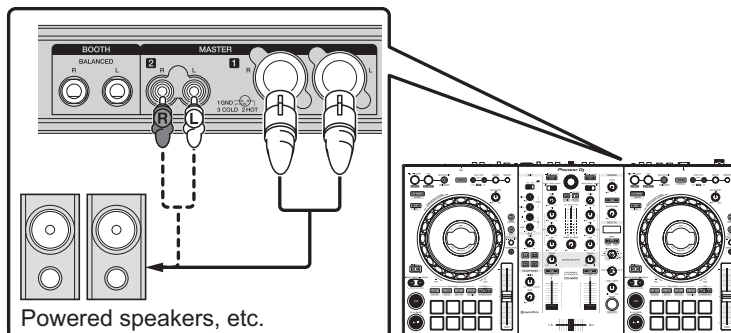

- To output the sound from the [BOOTH] output terminals, connect devices such as speakers to the [BOOTH] output terminals.

## 3 Connect this unit and your PC/Mac with a USB cable.

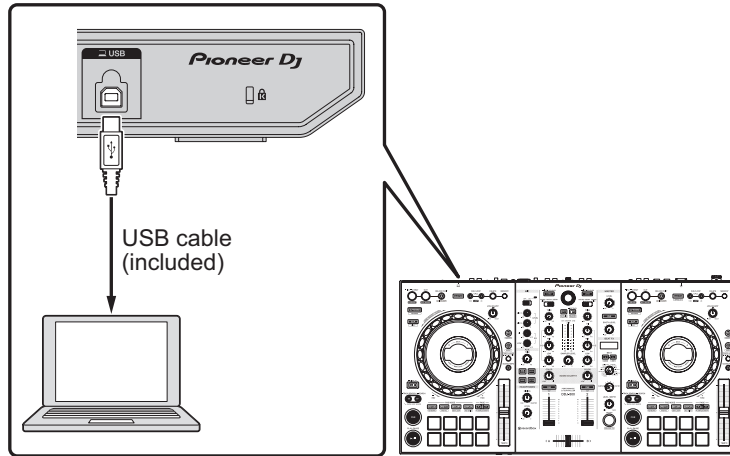

## 4 Turn on the power of the PC/Mac.

## 5 Connect the AC adapter.

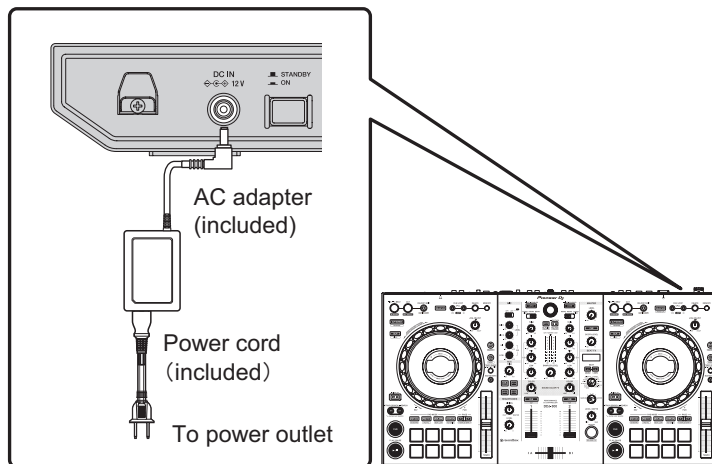

## 6 Press the [⏻] switch on the rear panel of this unit to turn this unit on.

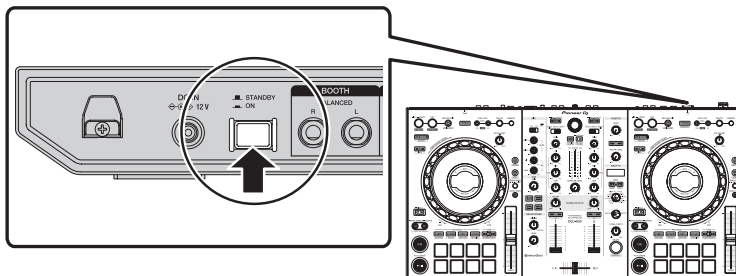

This unit turns on.

- For Windows

The **[Installing device driver software]** message may appear when this unit is first connected to the PC or when it is connected to a different USB port on the PC. Wait a while until the **[Your devices are ready for use]** message appears.

## 7 Turn on the devices connected to the output terminals (powered speakers, power amplifier, components, etc.).

- If a microphone, DJ player or other external device is connected to the input terminals, turn on the connected device.

---

## Starting the system

---

### Launching rekordbox

It is necessary to register an account for using rekordbox. For details about procedure, click **[Manual]** under **[Support]** of the following site, and then refer to “rekordbox introduction”.  
rekordbox.com

#### For Mac

Open the **[Applications]** folder in Finder and then double-click the **[rekordbox 5] > [rekordbox.app]** icon.

#### For Windows 10

From the **[Start]** menu, click **[Pioneer] > [rekordbox]** icon.

#### For Windows 8.1

Click the **[rekordbox]** icon in **[Apps view]**.

#### For Windows 7

From the **[Start]** menu, click **[All Programs] > [Pioneer] > [rekordbox 5.X.X]** and the **[rekordbox]** icon.

## Checking audio settings

Check that the **[Audio]** settings in **[Preferences]** of rekordbox are set as follows.

### For Mac

**[Audio]: [DDJ-800]**

**[Output channels]:**

**[Master Output]: [DDJ-800: MASTER]**

**[Booth Output]: [DDJ-800: BOOTH]**

**[Headphones Output]: [DDJ-800: PHONES]**

### For Windows

**[Audio]: [DDJ-800 ASIO]**

**[Output channels]:**

**[Master Output]: [DDJ-800 ASIO: MASTER]**

**[Booth Output]: [DDJ-800 ASIO: BOOTH]**

**[Headphones Output]: [DDJ-800 ASIO: PHONES]**

- If PC MASTER OUT is enabled, the “+ Name of audio device in PC/Mac” information will also be displayed after **[MASTER]** of the **[Master Output]** item in the **[Audio]** settings.



---

## Adding track files to [Collection]

A list of track files managed by rekordbox is displayed on the **[Collection]** screen.

Registering the track files on the PC/Mac as the track collection of rekordbox and then analyzing them enables those tracks to be used with rekordbox.

### 1 Click **[Collection]** in the tree view.

A list of the tracks registered in **[Collection]** is displayed.

### 2 Open Finder (Mac) or Explorer (Windows), and drag and drop track files or folders containing track files to the track list.

The track files are added to **[Collection]**, and the waveform analysis of the track files starts. Wait until the analysis of all the track files is finished.

---

## Loading a track into a deck of the unit

This section explains how to load a track into Deck 1 (left) as an example.

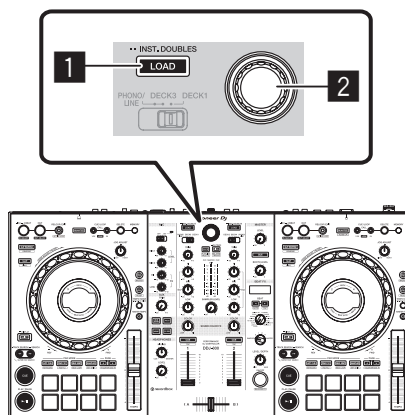

### 1 LOAD button

### 2 Rotary selector

- Turn the rotary selector to select a track in **[Collection]** and then press the **[LOAD]** button of deck 1 (left side).

The track is loaded into deck 1.

## Play tracks

The following describes the procedure for outputting the sound of deck 1 (left side) as an example.

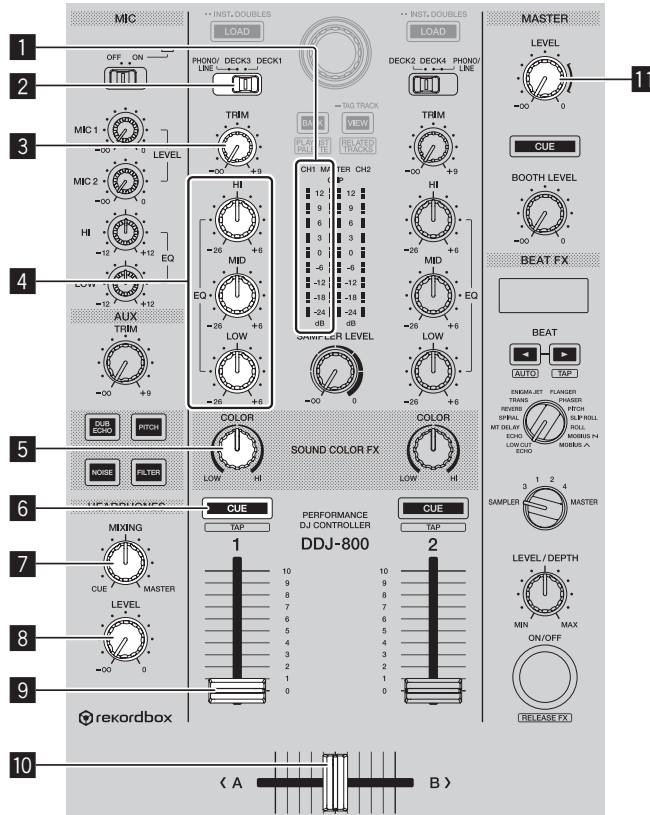

- 1** Channel level indicator
- 2** PHONO/LINE, DECK3, DECK1 selector switch
- 3** TRIM control
- 4** EQ (HI, MID, LOW) control
- 5** COLOR control
- 6** Headphones CUE button
- 7** HEADPHONES MIXING control

## 8 HEADPHONES LEVEL control

## 9 Channel fader

## 10 Crossfader

## 11 MASTER LEVEL control

1 Set the positions of the controls, etc., as shown below.

Names of controls, etc.	Operation
PHONO/LINE, DECK3, DECK1 selector switch	[DECK1] position
TRIM control	Turn it fully counterclockwise.
EQ (HI, MID, LOW) control	Center position
COLOR control	Center position
Channel fader	Move it downward.
MASTER LEVEL control	Turn it fully counterclockwise.
Crossfader	Center position

2 Press the [PLAY/PAUSE ►/II] button to play the track.

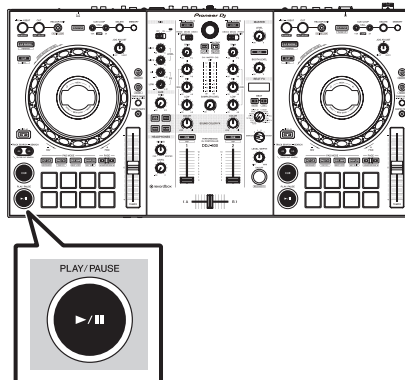

3 Turn the [TRIM] control.

Adjust the [TRIM] control so that the channel level indicator's orange indicator lights at the peak level.

4 Move the channel fader upward.

## 5 Turn the [MASTER LEVEL] control to adjust the audio level of the speakers.

Adjust the level of the sound output from the [MASTER 1] and [MASTER 2] output terminals to an appropriate level.

- To output sound from the speakers of the PC/Mac, adjust not the [MASTER LEVEL] control but the volume of the speakers of the PC/Mac.

---

## Monitoring channel audio with headphones

Set the positions of the controls, etc., as shown below.

Names of controls, etc.	Operation
HEADPHONES MIXING control	Center position
HEADPHONES LEVEL control	Turn it fully counterclockwise.

### 1 Press the headphones [CUE] button.

### 2 Turn the [HEADPHONES LEVEL] control.

Adjust the level of sound output from the headphones to an appropriate level.

### Note

This unit and rekordbox dj include many functions to allow for more individualistic DJ performances. For details on each function, access the site below and see the rekordbox Operating Instructions.

[rekordbox.com/manual](http://rekordbox.com/manual)

---

## Turning off the system

### 1 Close rekordbox.

### 2 Press the [⏻] switch on the rear panel of this unit to set the unit to standby.

### 3 Disconnect the USB cable from the PC/Mac.

---

---

# Advanced operation

---

---

## Using 4 beat loops

- **Press the [LOOP IN/4 BEAT] button for over 1 second during playback.**

A loop extending 4 beats from the point at which the button was pressed starts automatically and loop playback begins.

- When the quantize function is on, there may be a slight delay in operation of this function to synchronize the beat.
- 

## Canceling loop playback

- **Press the [RELOOP/EXIT] button.**

Playback continues beyond the loop-out point without returning to the loop-in point.

---

## Using manual loops

Use this function to play specific sections repeatedly.

- When the quantize function is on, there may be a slight delay in operation of this function to synchronize the beat.
- 1 During playback, press the [LOOP IN/4 BEAT] button at the point where you want to start loop playback (the loop in point).**  
Sets the loop-in point.
  - 2 Press the [LOOP OUT] button at the point where you want to end loop playback (the loop out point).**

## Halving a loop

- **Press the [CUE/LOOP CALL, ◀ (LOOP 1/2X)] button during loop playback.**

The length of loop playback is reduced to half each time this button is pressed.

- The length of a loop can be reduced to half even during 4-beat loop playback.
- 

## Doubling a loop

- **Press the [CUE/LOOP CALL, ▶ (LOOP 2X)] button during loop playback.**

Each time the button is pressed, the length of the loop playback is doubled.

- The length of the loop can be doubled even during 4 beat loop playback.
- 

## Canceling loop playback

- **Press the [RELOOP/EXIT] button.**

Playback continues beyond the loop-out point without returning to the loop-in point.

---

## Changing the point where loop playback starts

- **Press the [LOOP IN/4 BEAT] button during loop playback and then turn the jog dial.**

Moves the position of the loop-in point.

---

## Changing the point where loop playback ends

- **Press the [LOOP OUT] button during loop playback and then turn the jog dial.**

Moves the position of the loop-out point.

---

---

## Using the performance pads

---

### Using hot cues

You can start playback from the position where a hot cue is set. In addition to hot cues, loops can be set to call out a playback point.

- Up to 16 hot cue points can be set and stored in one track.

#### ❖ Setting and calling out a hot cue

##### 1 Press the [HOT CUE] mode button.

This unit enters hot cue mode.

- For the registered 16 hot cues, you can switch to hot cues A to H by pressing the [PAGE ◀] button, and hot cues I to P by pressing the [PAGE ▶] button. The content of the hot cue display area within the rekordbox dj deck screen can also be switched by performing the same operation.

##### 2 During playback or in pause mode, press a performance pad to set a hot cue point.

The hot cue points are assigned to the respective performance pads as shown below.

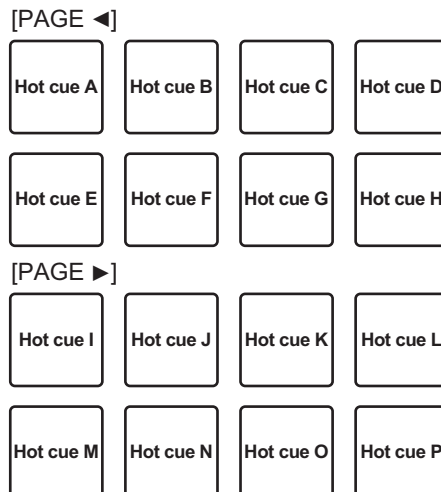

##### 3 Press the performance pad to which the hot cue point is set.

Playback starts from the hot cue point.

- Press a performance pad while pressing the [SHIFT] button to clear the hot cue point.

## ❖ Setting and calling out a 4 beat loop

### 1 Press the [HOT CUE] mode button.

This unit enters hot cue mode.

### 2 Press the [LOOP IN/4 BEAT] button for over 1 second during playback.

Sets a 4 beat loop at the point where the button is pressed, and loop playback starts.

### 3 During loop playback, press a performance pad to set a loop during loop playback.

### 4 Press the performance pad to which the loop is set.

Loop playback starts from the point where the loop is set.

- Press a performance pad while pressing the [SHIFT] button to clear the loop.

## ❖ Setting and calling out a manual loop

### 1 Press the [HOT CUE] mode button.

This unit enters hot cue mode.

### 2 Press the [LOOP IN/4 BEAT] button during playback and then press the [LOOP OUT] button.

Loop playback starts.

### 3 During loop playback, press a performance pad to set a loop during loop playback.

### 4 Press the performance pad to which the loop is set.

Loop playback starts from the point where the loop is set.

- Press a performance pad while pressing the [SHIFT] button to clear the loop.

---

## Using the pad FX

Various performances are possible with the simple operation of pressing and releasing performance pads.

### 1 Press the [PAD FX1] mode button.

This unit enters pad FX mode 1.

Effects are assigned to the performance pads as shown below.



# Advanced operation

For the effects assigned to the pads, you can switch to effects A to H by pressing the **[PAGE ◀]** button, and effects I to P by pressing the **[PAGE ▶]** button. The content of the pad FX display area within the rekordbox dj deck screen can also be switched by performing the same operation.

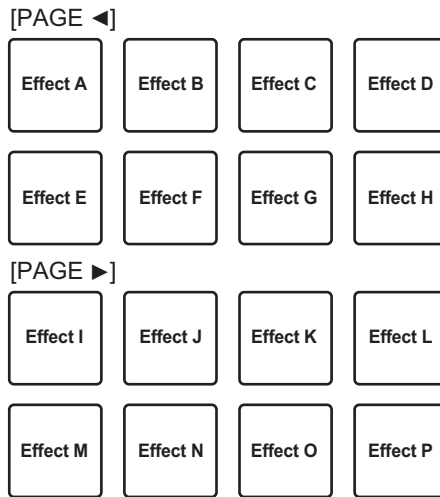

- Press the **[PAD FX1]** mode button while pressing the **[SHIFT]** button to switch to pad FX mode 2. Effects are assigned to the performance pads as shown below.

For the effects assigned to the pads, you can switch to effects Q to X by pressing the **[PAGE ◀]** button, and effects Y to AF by pressing the **[PAGE ▶]** button. The content of the pad FX display area within the rekordbox dj deck screen can also be switched by performing the same operation.

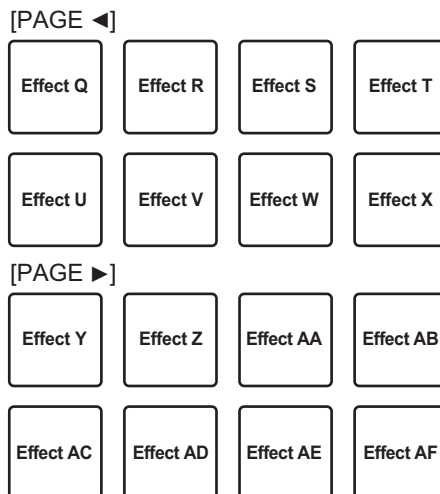

## 2 Press and hold a performance pad.

The effect turns on according to the effect and number of beats assigned to the pad.

## 3 Release the performance pad.

The effect turns off.

### ❖ Using the release FX of the pad FX

Release FX must be assigned to a performance pad beforehand.

## 1 Press and hold a performance pad to which an effect other than release FX is assigned.

The effect turns on according to the effect and number of beats assigned to the pad.

## 2 Press the performance pad to which release FX is assigned.

The effect that was on turns off, and the release FX effect is added.

---

## Using beat jump

You can move the playback position instantly without breaking the rhythm of the track currently playing.

## 1 Press the [BEAT JUMP] mode button.

This unit enters beat jump mode.

The number of beats or number of bars skipped is assigned to the respective performance pads as shown below. (Default value)

- Press the [PAGE ◀] button or the [PAGE ▶] button to switch the number of beats or number of bars assigned to the performance pad.

1 beat (Left direction)	1 beat (Right direction)	2 beat (Left direction)	2 beat (Right direction)
4 beat (Left direction)	4 beat (Right direction)	8 beat (Left direction)	8 beat (Right direction)

## 2 Press pad 1, pad 3, pad 5, or pad 7.

The playback position moves to the left by the number of beats or number of bars assigned to the pressed pad.

## 3 Press pad 2, pad 4, pad 6, or pad 8.

The playback position moves to the right by the number of beats or number of bars assigned to the pressed pad.

---

## Using the sampler function

You can play the tracks loaded in the sampler slots of the sampler using the performance buttons.

### ❖ Preparing to use the sampler

- **Select the [SAMPLER] check box at the upper part of the rekordbox dj screen.**

The sampler panel appears on the rekordbox dj screen.

### ❖ Loading a track into a sampler slot

- 1 **Press the [SAMPLER] mode button.**

This unit enters sampler mode.

- 2 **Press the [PAGE ◀] button or the [PAGE ▶] button while pressing the [SHIFT] button.**

The sampler bank is switched. The sampler has four banks and each bank has sixteen slots.

- 3 **Press the rotary selector to move the cursor to the track list.**

- 4 **Rotate the rotary selector.**

Select the track to be loaded in a sampler slot.

- 5 **Press the performance pad while pressing the [SHIFT] button.**

The selected track is loaded into the sampler slot.

- Loading by overwriting an already loaded sampler slot may not be possible depending on the [Preferences] setting of rekordbox.

### ❖ Using the performance pads to play the sampler

- 1 **Press the [SAMPLER] mode button.**

This unit enters sampler mode.

## 2 Press the [PAGE ◀] button or the [PAGE ▶] button while pressing the [SHIFT] button.

Switches the sampler bank.

## 3 Adjusting the sampler gain on the rekordbox dj screen

## 4 Press a performance pad.

The sound for the slot assigned to the pad is played.

- Sampler slots are assigned to the respective performance pads as shown below. (The slots in parentheses are for when the pad mode of deck 2 is the sampler mode.)



## 5 During sampler playback, press a performance pad.

Playback continues by returning to the beginning.

## 6 During sampler playback, press the performance pad while pressing the [SHIFT] button.

The sound of the slot that is currently playing stops.

---

## Using the keyboard mode

You can use the performance pads as a keyboard, assigning a musical scale to the hot cues.

### 1 Press the [HOT CUE] mode button while pressing the [SHIFT] button.

This unit enters keyboard mode.

### 2 Press a performance pad.

Select the hot cue to use in keyboard mode.

- If there are no hot cues set, the currently playback position is set as a hot cue and is used in keyboard mode.
- If you want to reselect the hot cue to use in keyboard mode, press the [HOT CUE] mode button while pressing the [SHIFT] button.

When a hot cue used with the keyboard mode is selected, the sound pitch settings are assigned to the respective performance pads as shown below. (Initial state)

① +4 Semitone	② +5 Semitone	③ +6 Semitone	④ +7 Semitone
⑤ ±0 Semitone	⑥ +1 Semitone	⑦ +2 Semitone	⑧ +3 Semitone

A semitone is a unit to represent the sound pitch. “+1 Semitone” indicates a sound that is a half step higher than the original tone.

### 3 Press the [PAGE ◀] button or [PAGE ▶] button to change the setting for the pitch of the sound assigned to a performance pad.

### 4 Press a performance pad.

The hot cue is played in the pitch assigned to the pressed pad.

## Using beat loops

When a performance pad is pressed, a loop with the number of beats assigned to the pad is set, and loop playback continues even when you release your finger from the pad.

### 1 Press the [BEAT JUMP] mode button while pressing the [SHIFT] button.

This unit enters beat loop mode.

The number of beats for beat loop mode is assigned to the respective performance pads as shown below.

- When you press the [PAGE ◀] button or [PAGE ▶] button, the number of beats assigned to the performance pad changes.

Beat Loop 1/64 beat	Beat Loop 1/32 beat	Beat Loop 1/16 beat	Beat Loop 1/8 beat
Beat Loop 1/4 beat	Beat Loop 1/2 beat	Beat Loop 1 beat	Beat Loop 2 beats

### 2 Press a performance pad.

A loop with the number of beats assigned to the pad that was pressed is played.

### 3 Press the same performance pad again.

Loop playback is canceled.

## Using the key shift function

When a performance pad is pressed, the key of the track being played changes to the pitch assigned to that pad.

### 1 Press the [SAMPLER] mode button while pressing the [SHIFT] button.

This unit enters key shift mode.

The sound pitch settings are assigned to the respective performance pads as shown below. (Initial state)

① +4 Semitone	② +5 Semitone	③ +6 Semitone	④ +7 Semitone
⑤ ±0 Semitone	⑥ +1 Semitone	⑦ +2 Semitone	⑧ +3 Semitone

A semitone is a unit to represent the sound pitch. “+1 Semitone” indicates a sound that is a half step higher than the original tone.

### 2 Press the [PAGE ◀] button or [PAGE ▶] button to change the setting for the pitch of the sound assigned to a performance pad.

### 3 Press a performance pad.

The key of the track being played changes to the pitch assigned to the pad that is pressed.

### 4 Press the [KEY SYNC] button while pressing the [SHIFT] button.

The key of the track being played returns to the original pitch.

## Setting cue points

Cue points or loop points can be set in the loaded track.

- 1 Move the playback position to the point where you want to set a cue point.**
  - 2 Press the [CUE] button in the pause mode.**
  - 3 Press [MEMORY].**  
The cue point set in step 2 is stored.  
Press the [MEMORY] button while looping to store the loop point.
- 

## Calling out cue points

Set cue points or loop points can be called out.

- **Press the [CUE/LOOP CALL, ◀ (LOOP 1/2X)] or [CUE/LOOP CALL, ▶ (LOOP 2X)] button.**  
Calls out the set cue points or loop points.
- 

## Deleting cue points

Set cue points or loop points can be deleted.

- 1 Press the [CUE/LOOP CALL, ◀ (LOOP 1/2X)] or [CUE/LOOP CALL, ▶ (LOOP 2X)] button.**  
Call out the cue point that you want to delete.
- 2 Press the [DELETE] button.**  
The cue point called out is deleted.



## Switching the mixer mode

This unit can be switched to 2-channel mixer mode or 4-channel mixer mode in the setting items of rekordbox.

➔ *Changing the settings with rekordbox* (p.84)

### 2-channel mixer mode

This is a mode for fixing the mixer function to 2 channels to match the buttons and controls on this unit.

Preparing the next track to be played in advance enables a performance with quick switching to target tracks.

### 4-channel mixer mode

This is a mode for using the mixer functions with 4 channels to match rekordbox dj.

Up to four mixes are possible so you can create music mixes and performances with even greater originality.

- The software takeover function operates for the mixer function in 4-channel mixer mode.

## Using slip mode

When slip mode is turned on, normal playback with the original rhythm continues in the background during scratching, looping and hot cue playback. When scratching, looping or hot cue playback is canceled, normal playback resumes from the position where the operation was canceled.

Various performances can be achieved without breaking the rhythm.

- The **[SLIP]** button lights up when slip mode is set and flashes while playing the sound in the background.
- 

## Slip scratching

### 1 Turn VINYL mode on.

Press the **[SHIFT]** button to check if the **[SLIP]** button lights up.

### 2 Press the **[SLIP]** button.

This unit enters slip mode.

### 3 During playback, perform scratching using the top of the jog dial.

Normal playback continues in the background while scratching is performed.

### 4 Release the top of the jog dial.

Playback starts from the current position playing in the background playback.

- Press the **[SLIP]** button again to cancel slip mode.

## How to check VINYL mode on/off

VINYL mode is turned on by default, and scratching is available. You can check the current status based on the light status of the **[SLIP]** button while the **[SHIFT]** button is pressed.

- When VINYL mode is on, the **[SLIP]** button lights up while the **[SHIFT]** button is pressed.
- When VINYL mode is off, the **[SLIP]** button does not light up while the **[SHIFT]** button is pressed.

Press the **[SLIP]** button while pressing the **[SHIFT]** button to switch VINYL mode on and off.

---

## Slip hot cue

### 1 Press the **[HOT CUE]** mode button.

This unit enters hot cue mode.

### 2 Set the hot cue.

Press a performance pad to set a hot cue.

### 3 Press the **[SLIP]** button.

This unit enters slip mode.

### 4 During playback, press and hold a performance pad.

Playback starts from the position where the hot cue is set. Playback continues while the performance pad is pressed.

Normal playback continues in the background while playing the hot cue.

### 5 Release the performance pad.

Playback starts from the current position playing in the background playback.

- Press the **[SLIP]** button again to cancel slip mode.

## Slip braking

- 1 Adjust the setting for [Vinyl Speed Adjust] - [Touch/Brake] in the [Deck] tab of [Preferences] > [Controller] menu for rekordbox.**

Adjusts the speed, etc., at which track playback stops with [Vinyl Speed Adjust].

When using slip braking, adjust the [Touch/Brake] control of [Vinyl Speed Adjust] on the PC/Mac screen and set the sound to stop slowly.

- 2 Press the [SLIP] button.**

This unit enters slip mode.

- 3 During playback, press the [PLAY/PAUSE ►/II] button.**

Playback slowly stops while normal playback continues in the background.

- 4 Press the [PLAY/PAUSE ►/II] button again.**

Playback starts from the current position playing in the background playback.

- Press the [SLIP] button again to cancel slip mode.
- 

## Slip auto beat loop

- 1 Press the [SLIP] button.**

This unit enters slip mode.

- 2 Press the [LOOP IN/4 BEAT] button for over 1 second.**

A loop with the specified number of beats is set and loop playback starts. Normal playback continues in the background even during loop playback.

- 3 Press the [RELOOP/EXIT] button.**

Loop playback is canceled and playback starts from the current position playing in the background playback.

- Press the [SLIP] button again to cancel slip mode.

## Manual slip looping

### 1 Press the [SLIP] button.

This unit enters slip mode.

### 2 Press the [LOOP IN/4 BEAT] button and then press the [LOOP OUT] button.

Loop playback starts.

Normal playback continues in the background even during loop playback.

### 3 Press the [RELOOP/EXIT] button.

Loop playback is canceled and playback starts from the current position playing in the background playback.

- Press the [SLIP] button again to cancel slip mode.

## Using the fader start function

---

### Using the channel fader start function

#### 1 Set a cue point.

Pause playback at the position where you want to set a cue point (playback start point), and press the **[CUE]** button for the corresponding deck.

- Cue points can also be set by moving the channel fader from the back to the position nearest you while pressing the **[SHIFT]** button in the pause mode.

#### 2 Move the channel fader from the position nearest you towards the back while pressing the **[SHIFT]** button.

Playback of the track starts from the set cue point.

- When the channel fader is moved back to the position nearest you while pressing the **[SHIFT]** button during playback, the track moves back to the set cue point and playback is paused (back cue).

If a cue point is not set, playback starts from the beginning of the track.

When the channel fader is moved from the back to the position nearest you while pressing the **[SHIFT]** button when a cue is in standby, playback starts from the set cue point.

## Using the crossfader start function

### 1 Setting the cue point.

Pause playback at the position where you want to set a cue point (playback start point), and press the **[CUE]** button for the corresponding deck.

- Cue points can also be set by moving the crossfader to the far left or the far right while pressing the **[SHIFT]** button in pause mode.

### 2 Move the crossfader to the far-left or far-right position.

Set the crossfader to the far end of the channel to be used with the fader start function.

### 3 Move the crossfader to the opposite direction while pressing the **[SHIFT]** button.

Playback of the track starts from the set cue point.

- When the crossfader is returned to the original position while pressing the **[SHIFT]** button during playback, the track moves instantaneously back to the set cue point and pause mode is set (Back Cue).

If a cue point is not set, playback starts from the beginning of the track.

When the crossfader is moved from the left edge to the right edge (or from the right edge to the left edge) while pressing the **[SHIFT]** button when a cue is in standby, playback starts from the set cue point.

---

## Using effects

The following explains the two effect function types, BEAT FX and SOUND COLOR FX, that can be operated when the unit is connected with rekordbox dj.

For details on operating these effects using the performance pads, see *Using the pad FX* (p.48).

## Using the BEAT FX function

You can set various effects according to the tempo (BPM = Beats Per Minute) of the track currently playing using the BEAT FX function.

### Main display



<b>1</b>	Effect name	Displays the name of the selected effect.
<b>2</b>	<b>AUTO</b> (TAP)	When the BPM measurement mode is auto mode, <b>[AUTO]</b> is displayed. When it is manual input mode, <b>[TAP]</b> is displayed.
<b>3</b>	BPM value display (3 digits)	Displays the automatically detected BPM in auto mode. If the BPM cannot be detected, the previously detected BPM value flashes. Displays the manually input BPM value in manual input mode.
<b>4</b>	Beat/ parameter display section	Displays the selected number of beats. Displays parameters when the <b>[BEAT ◀, ▶]</b> buttons are pressed for some effects. Blinks when outside the parameter limits.
<b>5</b>	Selected channel display section	Displays the channel to which the effect is to be applied. <b>SAMPLER, CH 1, CH 2, CH 3, CH 4,</b> or <b>MASTER</b> is displayed depending on what is selected.

### 1 Press the **[BEAT ◀]** or **[BEAT ▶]** button while pressing the **[SHIFT]** button.

Select the BPM measurement mode.

— **[AUTO]**: Press the **[BEAT ◀]** button while pressing the **[SHIFT]** button.

The BPM is automatically measured from the input audio signal.



— **[TAP]**: Press the **[BEAT ◀]** button while pressing the **[SHIFT]** button.

Enter the BPM manually. For information on manual input, refer to *Inputting the BPM manually* (p.66).

- The BPM measurement range for the **[AUTO]** setting is 70 to 180. BPM cannot be correctly measured for some tracks. If the BPM cannot be measured, the BPM value on the display flashes. In such cases, use the **[TAP]** button to input the BPM manually.

## 2 Rotate the **[BEAT FX SELECT]** control.

Selects the type of effect.

- For information on the types of effects, refer to *Types of BEAT FX* (p.66).

## 3 Rotate the **[BEAT FX CH SELECT]** control.

Selects the channel to apply the effect to.

- **[SAMPLER]**: Applies the effect to the sound of **[SAMPLER]** of rekordbox.
- **[1]** to **[4]**: Applies the effect to the sound of each channel. Only **[1]** and **[2]** are enabled when 2-channel mixer mode is set.
- **[MASTER]**: Applies the effect to the sound of the **[MASTER]** channel.

## 4 Press the **[BEAT ◀, ▶]** button.

Set the beat fraction to synchronize the effect sound with.

The effect time corresponding to the beat fraction is set automatically.

## 5 Press the **[BEAT FX ON/OFF]** button.

The effect is applied to the sound.

The effect's quantitative parameter can be adjusted by turning the **[BEAT FX LEVEL/DEPTH]** control.

The **[ON/OFF]** button flashes when the effect is on.

- Press the **[ON/OFF]** button again to turn the effect off.

### Note

The effect cannot be applied to the **AUX** sound.

## Inputting the BPM manually

- While pressing the [SHIFT] button, tap the [BEAT ►] button more than two times with your finger in time with the beat (quarter notes) of the sound being played.

The average value of the interval at which the [BEAT ►] button is tapped with a finger while the [SHIFT] button is pressed is displayed in the BPM value display section.

- You can return to AUTO mode, press the [BEAT ◀] button while pressing the [SHIFT] button.

## Types of BEAT FX

### LOW CUT ECHO <sup>1</sup>

A delayed sound with the low frequency range reduced is output several times and gradually attenuated according to the beat fraction set with the [BEAT ◀, ►] buttons.

- Lowering the channel faders and cutting the input volume leaves an echo sound, producing a fade out.

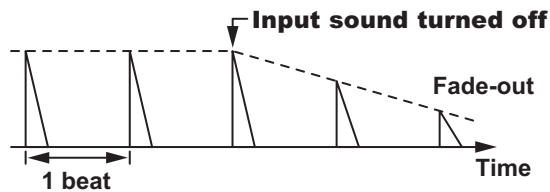

<b>BEAT ◀, ►</b> buttons	Sets the delay time between <b>1/16</b> and <b>16</b> beats with respect to 1 beat of BPM time.
<b>LEVEL/DEPTH</b> control	Sets the balance between the original sound and the echo sound.

## ECHO <sup>1</sup>

A delayed sound is output several times and gradually attenuated according to the beat fraction set with the **[BEAT ◀, ▶]** buttons.

- Lowering the channel faders and cutting the input volume leaves an echo sound, producing a fade out.

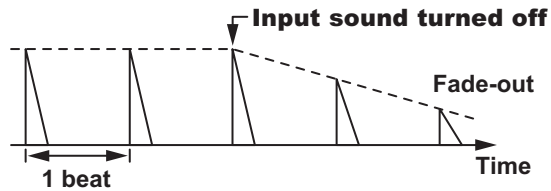

<b>BEAT ◀, ▶</b> buttons	Sets the delay time between <b>1/16</b> and <b>16</b> beats with respect to 1 beat of BPM time.
<b>LEVEL/DEPTH</b> control	Sets the balance between the original sound and the echo sound.

## MULTI TAP DELAY <sup>1</sup>

A delayed sound is output up to 7 times in 1/8 beat intervals according to the beat fraction set with the **[BEAT ◀, ▶]** buttons.

- Lowering the channel faders and cutting the input volume leaves a delayed sound.

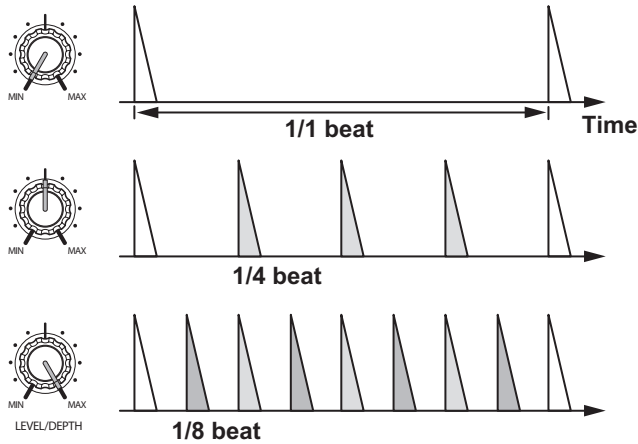

<b>BEAT ◀, ▶</b> buttons	Sets the effect time between <b>1/16</b> and <b>16</b> beats with respect to 1 beat of BPM time.
<b>LEVEL/DEPTH</b> control	Sets the volume to an odd-number delay from the <b>[MIN]</b> position to the center position, and an even-number delay from the center position to the <b>[MAX]</b> position.

## SPIRAL <sup>1</sup>

A reverberation effect is applied to the input sound.

The pitch changes simultaneously if the delay time is changed.

- Lowering the channel faders and cutting the input volume leaves an effect sound.

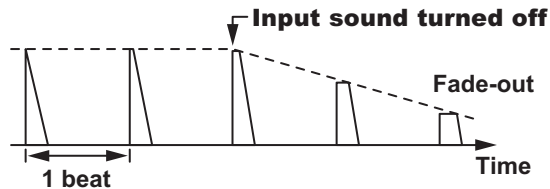

<b>BEAT</b> ◀, ▶ buttons	Sets the delay time between <b>1/16</b> and <b>16</b> beats with respect to 1 beat of BPM time.
<b>LEVEL/DEPTH</b> control	Sets feedback, and the balance between the original sound and the effect sound.

## REVERB <sup>1</sup>

A reverberation effect is applied to the input sound.

- Lowering the channel faders and cutting the input volume leaves a delay sound.

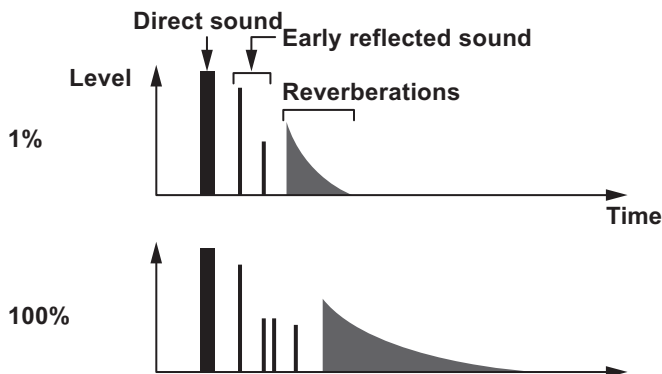

<b>BEAT</b> ◀, ▶ buttons	Sets the extent of the reverberation effect between <b>1</b> and <b>100</b> %.
<b>LEVEL/DEPTH</b> control	Sets the balance between the original sound and the effect sound.

## TRANS

The sound is cut according to the beat fraction set with the [BEAT ◀, ▶] buttons.

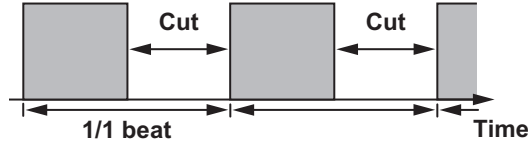

<b>BEAT ◀, ▶</b> buttons	Sets the beat fraction between <b>1/16</b> and <b>16</b> with respect to 1 beat of BPM time.
<b>LEVEL/DEPTH</b> control	Sets the duty ratio and balance between the original sound and effect sound.

## ENIGMA JET

A flanger effect is produced according to the beat fraction set with the [BEAT ◀, ▶] buttons. The pitch sounds as if it continues to ascend or descend.

<b>BEAT ◀, ▶</b> buttons	Sets the beat fraction between <b>1/16</b> and <b>64</b> beats or between <b>-64</b> and <b>-1/16</b> beats, with respect to 1 beat of BPM time. The pitch ascends for beat fractions between <b>1/16</b> and <b>64</b> beats. The pitch descends for beat fractions between <b>-64</b> and <b>-1/16</b> .
<b>LEVEL/DEPTH</b> control	The further the control is turned clockwise, the more the effect is stressed. When turned all the way counterclockwise, only the original sound is output.

## FLANGER

A 1-cycle flanger effect is produced according to the beat fraction set with the **[BEAT ◀, ▶]** buttons.

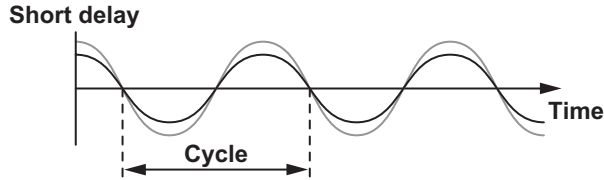

<b>BEAT ◀, ▶</b> buttons	Sets the effect time between <b>1/16</b> and <b>64</b> beats with respect to 1 beat of BPM time.
<b>LEVEL/DEPTH</b> control	The further the control is turned clockwise, the more the effect is stressed. When turned all the way counterclockwise, only the original sound is output.

## PHASER <sup>1</sup>

The phaser effect changes according to the beat fraction set with the **[BEAT ◀, ▶]** buttons.

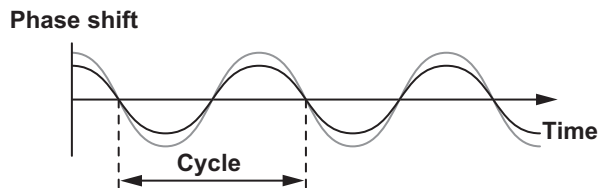

The phaser effect changes according to the beat button fraction.

<b>BEAT ◀, ▶</b> buttons	Sets the cycle for moving the phaser effect with respect to 1 beat of BPM between <b>1/16</b> and <b>64</b> beats.
<b>LEVEL/DEPTH</b> control	The further the control is turned clockwise, the more the effect is stressed. When turned all the way counterclockwise, only the original sound is output.

## PITCH

The pitch of the source sound is changed.

<b>BEAT ◀, ▶</b> buttons	Sets the pitch of the effect sound between <b>-50</b> and <b>100%</b> .
<b>LEVEL/DEPTH</b> control	Sets the pitch of the effect sound. When rotated all the way counterclockwise, the setting returns to the pitch of the original sound.

## SLIP ROLL

The sound being input at the point when the **[ON/OFF]** button is pressed is recorded, and the recorded sound is output repeatedly according to the beat fraction set with the **[BEAT ◀, ▶]** buttons. When the effect time changes, the input sound is recorded again.

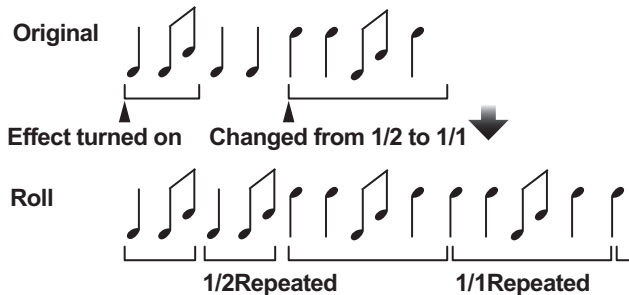

<b>BEAT ◀, ▶</b> buttons	Sets the effect time between <b>1/16</b> and <b>16</b> beats with respect to 1 beat of BPM time.
<b>LEVEL/DEPTH</b> control	Sets the balance between the original sound and <b>ROLL</b> .



## ROLL

The sound being input at the point when the **[ON/OFF]** button is pressed is recorded, and the recorded sound is output repeatedly according to the beat fraction set with the **[BEAT ◀, ▶]** buttons.

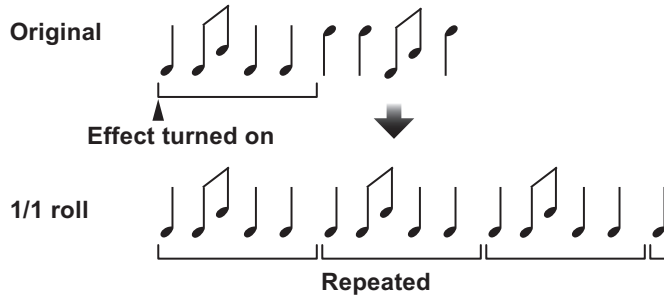

<b>BEAT ◀, ▶</b> buttons	Sets the effect time between <b>1/16</b> and <b>16</b> beats with respect to 1 beat of BPM time.
<b>LEVEL/DEPTH</b> control	Sets the balance between the original sound and <b>ROLL</b> .

## MOBIUS (SAW)

Sawtooth wave sound is produced according to the beat fraction set with the **[BEAT ◀, ▶]** buttons. The pitch sounds as if it continues to ascend or descend.

This sound is mixed with the input sound, and the resulting sound is output. Oscillation is possible even if sound is not input.

<b>BEAT ◀, ▶</b> buttons	Sets the beat fraction between <b>1/16</b> and <b>64</b> beats or between <b>-64</b> and <b>-1/16</b> beats, with respect to 1 beat of BPM time. The pitch ascends for beat fractions between <b>1/16</b> and <b>64</b> beats. The pitch descends for beat fractions between <b>-64</b> and <b>-1/16</b> .
<b>LEVEL/DEPTH</b> control	Adjusts the volume of the sawtooth wave sound to be mixed.

---

## MOBIUS $\wedge$ (TRI)

Triangular wave sound is produced according to the beat fraction set with the **[BEAT ◀, ▶]** buttons. The pitch sounds as if it continues to ascend or descend.

This sound is mixed with the input sound, and the resulting sound is output. Oscillation is possible even if sound is not input.

<b>BEAT ◀, ▶</b> buttons	Sets the beat fraction between <b>1/16</b> and <b>64</b> beats or between <b>-64</b> and <b>-1/16</b> beats, with respect to 1 beat of BPM time. The pitch ascends for beat fractions between <b>1/16</b> and <b>64</b> beats. The pitch descends for beat fractions between <b>-64</b> and <b>-1/16</b> .
<b>LEVEL/DEPTH</b> control	Adjusts the volume of the sawtooth wave sound to be mixed.

- 1 When **[1]** to **[4]** is selected with the effect channel selector switch, the effect sound cannot be monitored even if the **[CUE]** button of the selected channel is pressed.

---

---

## Using the SOUND COLOR FX function

This effect changes in association with the **[COLOR]** control for each channel.

You can use SOUND COLOR FX included in rekordbox dj.

### 1 Press a **[SOUND COLOR FX SELECT]** button.

Selects the type of effect.

The pressed button flashes.

- If a **[SOUND COLOR FX SELECT]** button is pressed when a **[SOUND COLOR FX SELECT]** button is already selected, the newly pressed button is selected.
- The same effect is set for all channels.

### 2 Turn the **[COLOR]** control.

The effect is applied to the sound of the channel for which the control is turned.

### Canceling the **SOUND COLOR FX** effect

- Press the flashing [**SOUND COLOR FX SELECT**] button.  
The effect is canceled.
- 

### Types of **SOUND COLOR FX** effects

rekordbox dj supports various **SOUND COLOR FX**.

When the software is used with the unit **DUB ECHO**, **PITCH**, **NOISE** and **FILTER** are selected by default.

Effects other than these can be used by changing the **SOUND COLOR FX** settings in rekordbox dj.

Switch **SOUND COLOR FX** of rekordbox dj to the [**USER**] mode to change the **SOUND COLOR FX** setting. You can set each effect to the desired effect.

Effect name	Descriptions	[COLOR] control
<b>DUB ECHO</b>	Outputs delayed sounds repeatedly after the original sound and gradually attenuates the delayed sounds to achieve an echo effect.	Turn counterclockwise: Applies the echo effect to the mid-range only. Turn clockwise: Applies the echo effect to the high-range only.
<b>PITCH</b>	Changes the sound pitch.	Turn counterclockwise: The pitch descends. Turn clockwise: The pitch rises.
<b>NOISE</b>	White noise generated inside this unit is mixed in to the sound of the channel via the filter and output.	Turn counterclockwise: Gradually decreases the cut-off frequency of the filter through which the white noise passes. Turn clockwise: Gradually increases the cut-off frequency of the filter through which the white noise passes.
<b>FILTER</b>	Outputs sound that has passed through a filter.	Turn counterclockwise: Gradually decreases the low-pass filter's cut-off frequency. Turn clockwise: Gradually increases the high-pass filter's cut-off frequency.

## Using a microphone

**1 Connect a microphone to the [MIC 1] input terminal or the [MIC 2] input terminal.**

**2 Set the [MIC ON, OFF] selector switch to [ON].**

[ON]: The indicator lights up.

- When using the TALK OVER function, select the **[MIXER/MIC]** check box in rekordbox dj to display the graphical user interface of TALK OVER. Click the **[TALK OVER]** button.
- When set to **[TALK OVER]**, the sound of channels other than the **[MIC 1]** channel and the **[MIC 2]** channel is attenuated by -18 dB (default) when a sound of -10 dB or greater is input to the microphone.
- For details on how to change the sound attenuation level when **[TALK OVER]** is selected, see *Microphone Talkover Level setting* (p.88).
- The talkover mode can be switched between normal mode and advanced mode. For information on how to change this setting, refer to *Microphone Talkover Mode setting* (p.88).

**3 Turn the [MIC 1 LEVEL] control or [MIC 2 LEVEL] control.**

Adjusts the level of sound output from the **[MIC 1]** channel or the **[MIC 2]** channel.

- The sound is output at a loud volume if the control is rotated to the extreme right.

**4 Input audio to the microphone.**

### Notes

- To output the microphone sound from the unit via your PC/Mac, do the following.
  - Use rekordbox dj.
  - Change the setting of **[Microphone Input Mode]** in rekordbox to **[Effect Mode]**.

For information on how to change this setting, refer to *Microphone Input Mode setting* (p.87).

- In a case other than the above, the microphone sound will be output from the unit without passing via your PC/Mac.

The following shows the function differences depending on the above setting.

Function name	Via the PC/Mac	Not via the PC/Mac
MIC ON, OFF selector switch	Enabled	Enabled
MIC 1/2 LEVEL control	Enabled	Enabled
MIC EQ (HI, LOW) control	Enabled	Enabled
Output of microphone sound to booth monitor	Enabled	Enabled
Limiter of microphone sound added to Master Output	Enabled	Disabled
Limiter of microphone sound added to Booth Output	Enabled	Disabled
TALK OVER function	Enabled	Disabled
Microphone FX	Enabled	Disabled

For details on the microphone FX and other functions, access the site below and see the rekordbox Operating Instructions.

[rekordbox.com/manual](http://rekordbox.com/manual)

---

## Adjusting the sound quality

- Turn the [EQ (HI, LOW)] control.
  - [HI]: -12 dB to +12 dB (10 kHz)
  - [LOW]: -12 dB to +12 dB (100 Hz)

## Using external inputs

This unit is equipped with two sets of external inputs for connecting a CD player, analog turntable, and other devices. The audio of these devices can be output from the unit via a PC/Mac or output from the unit not via a PC/Mac.

The following shows the function differences.

- When a USB cable is connected and rekordbox is running:  
Outputs the audio of the external device from this unit via a PC/Mac. This enables using the mixer functions or effect functions of rekordbox dj for the audio of the external device.
- When rekordbox is not running or a USB cable is not connected:  
Outputs the audio of the external device from this unit not via a PC/Mac.

Function name	USB cable is connected and rekordbox is running	USB cable is connected and rekordbox is not running	When USB cable is not connected
<b>TRIM</b> control	Enabled	Enabled	
<b>EQ (HI, MID, LOW)</b> control	Enabled	Enabled	
Microphone EQ	Enabled	Enabled	
SOUND COLOR FX	Enabled	Disabled	
Headphones CUE	Enabled	Enabled	
Channel fader	Enabled	Enabled	
Crossfader	Enabled	Enabled	
Crossfader curve	Enabled	Disabled	
Crossfader Cut Lag	Enabled	Enabled	
Master Output peak limiter	Enabled	Disabled	
Fader start	Enabled	Disabled	

Function name	USB cable is connected and rekordbox is running	USB cable is connected and rekordbox is not running	When USB cable is not connected
Booth Output peak limiter	Enabled	Disabled	
Master Output monaural/ stereo selection	Enabled	Disabled	
Booth Output monaural/ stereo selection	Enabled	Disabled	
Channel level indicator	Enabled	Enabled	
Master level indicator	Enabled	Enabled	
BEAT FX	Enabled	Disabled	

## Notes

- For details on the respective items, see *Connections* (p.37) and *Part names and functions* (p.11).
- The values adjusted with the various controls for rekordbox dj differ from the values adjusted with the various controls for external input.
- When using the unit with the setting to forcefully operate the unit as a general MIDI controller in the utilities mode of the unit, check the settings of the DJ application to be used.



### Mixing the sound of a DJ player, etc.

- 1 Connect your PC/Mac and the unit with a USB cable.
  - 2 Launch rekordbox.
  - 3 Connect a DJ player or other line level output device to the [LINE/PHONO] input terminals.
  - 4 Set the [LINE/PHONO] switch on the rear panel of this unit to [LINE].
    - Be sure to change the setting of the [LINE/PHONO] switch when the power of the unit is off.
  - 5 Turn on this unit's power.
  - 6 Set the [PHONO/LINE, DECK3, DECK1] selector switch or [DECK2, DECK4, PHONO/LINE] selector switch on top of the unit to [PHONO/LINE].
  - 7 Operate the [TRIM] control and channel fader to adjust the level of sound output from each channel.
- 

### Mixing the sound of an analog turntable, etc.

- 1 Connect your PC/Mac and the unit with a USB cable.
- 2 Launch rekordbox.
- 3 Connect the analog player or other phono level (for MM cartridges) output device to the [LINE/PHONO] input terminals.
  - Connect the ground wire of an analog player to the [SIGNAL GND] terminal of this unit.
- 4 Set the [LINE/PHONO] switch on the rear panel of this unit to [PHONO].
  - Be sure to change the setting of the [LINE/PHONO] switch when the power of the unit is off.
- 5 Turn on this unit's power.

- 6 Set the [PHONO/LINE, DECK3, DECK1] selector switch or [DECK2, DECK4, PHONO/LINE] selector switch on top of the unit to [PHONO/LINE].
  - 7 Operate the [TRIM] control and channel fader to adjust the level of sound output from each channel.
- 

### Using the AUX function

- Turn the [AUX TRIM] control.

Adjust the level of sound input to the [AUX IN] channel.

#### Note

The sound input to the [AUX IN] channel is output from the unit without passing via your PC/Mac. The BEAT FX or SOUND COLOR FX effect of rekordbox dj is not applied to this sound.

---

---

# Changing the settings

---

---

## Changing the settings with the unit

The “MIDI Controller Settings” can be set in the utilities mode. This unit automatically switches operation as shown below depending on whether or not rekordbox dj is running.

- When rekordbox is running, controller operation depends on the rekordbox dj functions.
- When rekordbox dj is not running, this controller operates as a general MIDI controller.

Even if rekordbox dj is running, this controller can forcibly be operated as a general MIDI controller.

If the utilities mode is launched while the DJ application is running, the set status may not be displayed properly.

- 1 Disconnect the USB cable from the PC/Mac.**
- 2 Press the [⏻] switch on the rear panel of this unit to set the unit to standby.**

This unit enters standby mode.

- 3 While pressing both the [SHIFT] and [PLAY/PAUSE ▶/II] buttons on the left deck, press the [⏻] switch on the rear panel of this unit.**

Utilities mode is launched.

- 4 Press the [SLIP REVERSE] button on the left deck.**
  - [SLIP REVERSE] button (not lit): Automatically switches operation depending on whether or not rekordbox is running.
  - [SLIP REVERSE] button (lit): Forcibly operates as a general MIDI controller regardless of whether or not rekordbox is running.

## 5 Press the [⏻] switch on the rear panel of this unit to set the unit to standby.

To save the settings, set the [⏻] switch on the rear panel of this unit to standby and quit utilities mode.

---

---

## Changing the settings with rekordbox

The settings required for the DJ player can be changed with rekordbox.

Change the setting items in **[Controller]** of **[Preferences]**.

- The following settings can be changed only when rekordbox and the unit are connected.

---

### Setting items of **[Deck]** tab in **[Controller]**

#### ❖ **Brightness of the display setting**

Sets the brightness of the jog display section.

5 levels from 1 to 5 are available for this setting.

- Set to 1 for the darkest illumination, and 5 for the brightest illumination.

#### ❖ **Display setting for the jog display**

You can change the information displayed in the jog display section.

#### **Display**

Set the display of the jog display section. Also, when the power of the unit is turned on, the screen selected in the setting is displayed on the jog display.

— **INFO screen**: Displays the INFO screen.

— **ARTWORK screen**: Displays the ARTWORK screen.

## Display Artwork

Selecting the check box of the **[Display Artwork]** item enables display and displays the artwork of the track loaded from rekordbox on the jog display. This is enabled only when the INFO screen is displayed.

## Display CUE SCOPE

Selecting the check box of the **[Display CUE SCOPE]** item enables display and displays the CUE SCOPE on the jog display. This is enabled only when the INFO screen is displayed.

## Time Mode

Time information display can be changed in the **[Time Mode]** item. This is enabled only when the INFO screen is displayed.

- **Elapsed:** With 0:00 as the starting point of the track, displays the time elapsed from the beginning to the current playback position.
- **Remaining:** With 0:00 as the end of the track, displays the time remaining to the end from the current playback position.

## ❖ Slip Mode Flashing

Changes the slip mode flashing setting.

- **Enable:** The buttons that can be operated only while slip mode is on (**[HOT CUE]**, **[RELOOP/EXIT]**, etc.) flash.
- **Disable:** The buttons that can be operated only while slip mode is on do not flash.

## ❖ Slip button LED while slip mode is on

Sets the lighting operation of the **[SLIP]** button for when slip mode is on.

- **Light is On:** The **[SLIP]** button lights up when slip mode is on, and flashes while slip mode is being operated.
- **Blink:** The **[SLIP]** button does not light up when slip mode is on.

## Setting items of [Mixer] tab in [Controller]

### ❖ Mixer Mode setting

Changes the mixer mode setting.

➡ *Switching the mixer mode* (p.57)

### ❖ Fader Start setting

Changes the fader start function setting.

- By default, this is enabled.

When the **[Activate the fader start when moving a channel fader or the cross fader while pressing the SHIFT button.]** check box is selected, the function is enabled.

### ❖ Cross Fader Curve setting

Switches the characteristics of the crossfader curve.

- The further the control is turned clockwise, the sharper the curve rises.
- The further the control is turned counterclockwise, the more gradually the curve rises.

### ❖ Cross Fader Cut Lag setting

Adjust the length of the silent zone (cut lag) of both ends of the crossfader.

Adjustment can be made from 0.5 mm to 5.7 mm in 0.1 mm increments.

- By default, the level is set to 1.0 mm.

### ❖ Output setting of the microphone to the booth monitor

Changes whether or not the microphone sound is output from the booth channel.

When the **[Don't output microphone sound to the Booth output.]** check box is unselected, the microphone sound is output from the booth channel. When the check box is selected, the microphone sound is not output from the booth channel.

## ❖ **Brightness setting of effect section display**

Set the brightness of the effect section display.

3 levels from 1 to 3 are available for this setting.

Set to 1 for the darkest illumination, and 3 for the brightest illumination.

## ❖ **Microphone Input Mode setting**

— **Effect Mode**: Enables output of the microphone sound from the unit via your PC/Mac. This allows you to apply the microphone FX and other effects of rekordbox dj to the microphone sound.

— **Low Latency Mode**: Enables output of the microphone sound from the unit not via your PC/Mac. This does not allow you to apply the microphone FX and other effects of rekordbox dj to the microphone sound, but the time lag due to the transmission delay (latency) of the sound data is reduced compared with the effect mode.

## **Note**

For details on the microphone FX and other functions, access the site below and see the rekordbox Operating Instructions.

[rekordbox.com/manual](http://rekordbox.com/manual)

## ❖ **Mic Low Cut Filter setting**

Set whether or not to apply a filter to reduce the sound lower than the human voice for the microphone sound.

The background noise output from speakers, etc. that is input to the microphone can be reduced by the low cut filter.

— **On**: Enables the low cut filter of microphone sound.

— **Off**: Disables the low cut filter of microphone sound.

# Changing the settings

## ❖ Microphone Talkover Mode setting

Switches the talkover mode.

- **Advanced Talkover Mode:** Sound from channels other than the microphone channel is output with only the mid-range attenuated according to the talkover level setting.

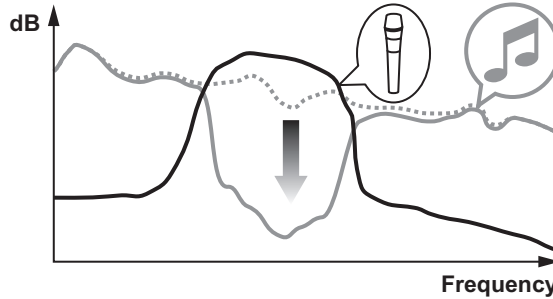

- **Normal Talkover Mode:** Sound from channels other than the microphone channel is output with the sound attenuated according to the talkover level setting.

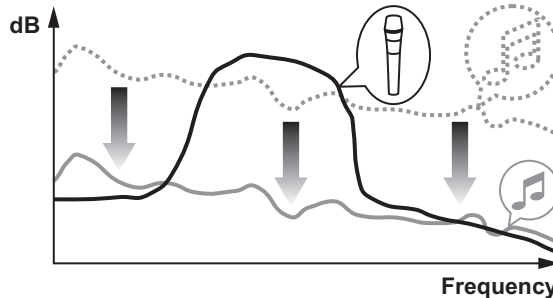

## ❖ Microphone Talkover Level setting

Sets the talk over function's sound attenuation level.

Setting values: -6 dB / -12 dB / -18 dB / -24 dB



## Setting items of [DDJ-800] tab in [Controller]

### ❖ **Master Attenuator Level setting**

Sets the master output attenuator level.

Setting values: 0 dB / -6 dB / -12 dB

### ❖ **Monaural/Stereo Selection for Master Output**

Switches the monaural/stereo setting for the master output sound.

— **Monaural**: Outputs the master sound in monaural.

— **Stereo**: Outputs the master sound in stereo.

### ❖ **Booth Attenuator Level setting**

Sets the booth output attenuator level.

Setting values: 0 dB / -6 dB / -12 dB

### ❖ **Monaural/Stereo Selection for Booth Output**

Switches the monaural/stereo setting for the booth output sound.

— **Monaural**: Outputs the booth sound in monaural.

— **Stereo**: Outputs the booth sound in stereo.

### ❖ **Peak Limiter setting for Master Output**

Lessens sudden, unpleasant digital clipping of the master output.

— **Enable**: Enables the peak limiter for master output.

— **Disable**: Disables the peak limiter for master output.

### ❖ **Microphone sound limiter setting added to Master Output**

Lessens sudden, unpleasant digital clipping of the microphone sound that is added to the master output.

— **Enable**: Enables the peak limiter

— **Disable**: Disables the peak limiter

## Changing the settings

### ❖ **Microphone sound limiter setting added to Booth Output**

Lessens sudden, unpleasant digital clipping of the microphone sound that is added to the booth output.

— **Enable**: Enables the peak limiter

— **Disable**: Disables the peak limiter

### ❖ **SHIFT Function List setting**

Changes the display setting for the **SHIFT** function list.

- By default, this is enabled.

If you select the [**Display SHIFT Function List while pressing the SHIFT button.**] check box, a list of the **SHIFT** functions in rekordbox is displayed when you press the [**SHIFT**] button.

### ❖ **Demo/Screen saver setting**

Sets the screen saver function and the time for when to start demo mode.

- By default, demo mode starts when there is no operation for 10 minutes.
- When any control or button on this unit is operated while in the demo mode, the demo mode is canceled.
- When the screen saver function is enabled, it starts up when there is no operation for 30 minutes.

— **Demo (1 minute)**: Demo mode starts when there is no operation on this unit for 1 minute.

— **Demo (5 minutes)**: Demo mode starts when there is no operation on this unit for 5 minutes.

— **Demo (10 minutes)**: Demo mode starts when there is no operation on this unit for 10 minutes.

— **Screen saver**: Enables the screen saver function.

— **Disable**: Demo mode and the screen saver function do not start.

## ❖ **Auto Standby setting**

Changes the auto standby function setting.

- By default, this is enabled.

When this setting is enabled, this unit enters standby automatically after 4 hours if any of the following conditions are met.

— None of the unit's buttons or controls are operated.

— No audio signal of -24 dB or greater is input to an input terminal of this unit.

- If the **[QUANTIZE]** button of the right side deck is pressed, the standby state is canceled.

---

## **Setting utility software**

The setting utility can be used to perform the checks and settings described below.

— Adjusting the buffer size (when ASIO is used)

— Checking the version of the driver software

---

## **Displaying the setting utility**

### **For Mac**

Open the **[Applications]** folder in Finder and then click **[Pioneer] > [DDJ-800] > [DDJ-800 driver version display utility]**.

### **For Windows 10**

Click **[Pioneer] > [DDJ-800 Settings Utility]** from the **[Start]** menu.

### **For Windows 8.1**

From **[Apps view]**, click **[Pioneer] > [DDJ-800 Settings Utility]**.

### **For Windows 7**

Click **[All Programs] > [Pioneer] > [DDJ-800] > [DDJ-800 Settings Utility]** from the **[Start]** menu.

## Adjusting the buffer size (when ASIO is used)

This function can only be used by those using a Windows operating system.

If an application using this unit as the default audio device (DJ software, etc.) is running, quit the application before adjusting the buffer size.

Display the setting utility before starting.

- Click the [ASIO] tab.

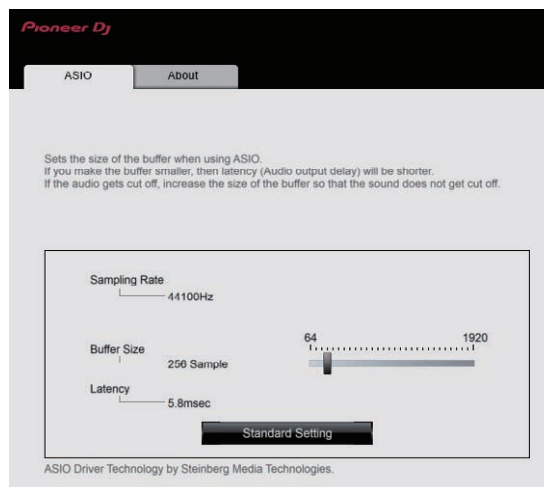

- If a large buffer size is set, drops in audio data (breaks in the sound) occur less easily, but the time lag due to the delay in the transfer of the audio data (latency) increases.

## Checking the version of the driver software

Display the setting utility before starting.

- Click the **[About]** tab.

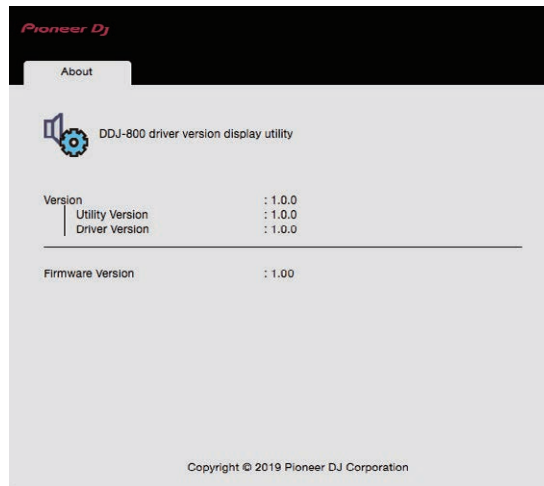

- You can check the firmware version of this unit on the screen.
- The firmware version is not displayed when the unit is not connected to the PC/Mac or when the unit and PC/Mac are not communicating properly.

---

---

## Additional information

---

---

### Troubleshooting

- If you think that there is something wrong with this unit, check the following items and access the Pioneer DJ support page and check **[FAQ]** of DDJ-800.

pioneerdj.com/support/

Also, refer to **[Support]** > **[FAQ]** at the rekordbox product site.

Some problems occur due to the connected components. If the problem cannot be resolved after checking the connected components, contact the service center or your dealer for repairs.

- The player may not operate properly due to static electricity or other external influences. In such cases, normal operation may become possible if you turn the power off and then back on.

Problem	Check	Remedy
The unit does not turn on.	Is the [⏻] switch of the power on the rear panel of the unit on?	Turn on the [⏻] switch.
	Is the included AC adapter properly connected?	Connect the included AC adapter correctly.
The unit is not recognized.	Is the included USB cable properly connected?	Connect the included USB cable properly.
	Are you using a USB hub?	A USB hub cannot be used. Connect the PC/Mac and this unit directly using the included USB cable.
	Is the driver software properly set?	Set the driver software properly. (p.105)

## Additional information

Problem	Check	Remedy
The unit is not recognized.	Is your PC/Mac recognizing the unit?	Windows: Check if the firmware version of this unit is displayed on the <b>[About]</b> tab of <b>[DDJ-800 Settings Utility]</b> . (p.93)
		Mac: Check if the firmware version of this unit is displayed on the <b>[About]</b> tab of <b>[DDJ-800 driver version display utility]</b> . (p.93)
	Are other applications running?	Quit all applications including also the screen saver and resident software. (Before quitting antivirus security software and other security software, disconnect the Internet connection to ensure the security of your PC/Mac.)
	Are USB devices other than this unit connected?	Remove external hard disks and the keyboard (for some models), etc. to check the status with only the built-in hard disc.
	—	If your PC/Mac has multiple USB ports, check whether the unit is recognized using a different USB port.
	Are multiple ASIO drivers for units other than this unit installed on the PC?	Uninstall unnecessary ASIO drivers. For details on how to uninstall ASIO drivers, check with the manufacturer of the respective ASIO driver.

Problem	Check	Remedy
The unit is not recognized.	Is the sound setting on the Mac set correctly?	Disconnect the USB cable connecting the unit and the computer, launch <b>[Audio MIDI Setup]</b> (the utility software for macOS), and the <b>[MIDI Window]</b> or <b>[MIDI studio]</b> will be displayed. Select the <b>[DDJ-800]</b> icon, and click <b>[Remove Device]</b> . (The <b>[USB MIDI Device]</b> icon may be displayed instead of the <b>[DDJ-800]</b> icon. In that case, select <b>[USB MIDI Device]</b> .) If this unit is connected to the computer using the USB cable again, the <b>[DDJ-800]</b> icon will appear.
Sound is not output, or sound is too small.	Are the <b>[TRIM]</b> control, channel fader, crossfader, <b>[PHONO/LINE, DECK3, DECK1]</b> selector switch or <b>[DECK2, DECK4, PHONO/LINE]</b> selector switch, <b>[LINE/PHONO]</b> switch, and <b>[MASTER LEVEL]</b> control set to the correct positions?	Set the <b>[TRIM]</b> control, channel fader, crossfader, <b>[PHONO/LINE, DECK3, DECK1]</b> selector switch or <b>[DECK2, DECK4, PHONO/LINE]</b> selector switch, <b>[LINE/PHONO]</b> switch, and <b>[MASTER LEVEL]</b> control to the correct positions.
	Are the connected powered speakers, etc., properly set?	Properly set the external input selection, volume, etc., on the powered speakers, etc.



## Additional information

Problem	Check	Remedy
Sound is not output, or sound is too small.	Are the connection cables properly connected?	Connect the connection cables properly.
	Are the terminals and plugs dirty?	Clean the terminals and plugs before connecting them to the unit.
	Is the driver software properly set?	Set the driver software properly. (p.105)
Sound is distorted.	Is the <b>[MASTER LEVEL]</b> control set to the correct position?	Adjust the <b>[MASTER LEVEL]</b> control so that the orange indicator on the master level indicator lights at the peak level.
	Is the <b>[TRIM]</b> control set to the correct position?	Adjust the <b>[TRIM]</b> control so that the channel level indicator's orange indicator lights at the peak level.
	Is the <b>[LINE/PHONO]</b> switch set to the proper position?	Set the <b>[LINE/PHONO]</b> switch to the proper position.
Sound is interrupted when the DJ software is used.	Is the buffer size (latency) value appropriate?	On a Windows operating system, use the setting utility to set an appropriate buffer size value. (p.91)
		On a Macintosh, set the appropriate buffer size (latency) value for the DJ software.
Cannot output the microphone sound.	Is the <b>[MIC ON, OFF]</b> selector switch set to the correct position?	Set the <b>[MIC ON, OFF]</b> selector switches to the correct position.

Problem	Check	Remedy
Cannot output the sound of the external device.	Is the <b>[PHONO/LINE, DECK3, DECK1]</b> selector switch or <b>[DECK2, DECK4, PHONO/LINE]</b> selector switch set to the correct position?	Set the <b>[PHONO/LINE, DECK3, DECK1]</b> selector switch or <b>[DECK2, DECK4, PHONO/LINE]</b> selector switch to the correct position.
Sound is interrupted when the ASIO driver is set.	Has the ASIO driver been set with rekordbox running?	Set the ASIO driver before launching rekordbox. (p.91)
The indicator flashes and operation is strange.	—	Normal operation can be restored by disconnecting the AC adapter, waiting at least 1 minute, and then reconnecting the AC adapter. If the same symptom persists, disconnect the AC adapter, and then make a request for repairs.
Operation of rekordbox dj becomes unstable.	Are you using the latest version of the software?	Free updates of rekordbox can be downloaded from the website. Use the most recent version. (p.8)
	Are you using software other than rekordbox at the same time?	Quit other applications to decrease the load on the PC/ Mac. If operation continues to be unstable, try disabling the wireless network or other wireless connections, antivirus software, the screen saver, the low power mode, etc. (p.6)

## Additional information

Problem	Check	Remedy
<p>Operation of rekordbox dj becomes unstable.</p>	<p>Other USB devices are connected to the PC/Mac.</p>	<p>Disconnect the other USB devices from the PC/Mac. If another USB audio device is connected to the PC/Mac at the same time, it may not operate or be recognized normally.</p>
	<p>Are you using a USB hub?</p>	<p>A USB hub cannot be used. Connect the PC/Mac and this unit directly using the included USB cable.</p>
	<p>Is there a problem with the USB port to which this unit is connected?</p>	<p>If your PC/Mac has multiple USB ports, try connecting this unit to a different USB port.</p>
	<p>Is this unit connected to a notebook PC/Mac running on battery?</p>	<p>Supply power to the notebook PC/Mac from a power outlet. (Depending on the notebook PC/Mac's settings, the low power mode may be set when the PC/Mac is running on battery, automatically reducing the performance of the PC/Mac itself.) (p.6)</p>
	<p>Is the USB buffer size too small?</p>	<p>Raise the USB buffer size. (p.91)</p>
<p>The INFO screen and ARTWORK screen are not displayed on the jog dial display section.</p>	<p>Is the utility mode setting correct?</p>	<p>In utility mode, check that the unit is not set to be forcefully operated as a general MIDI controller. (p.83)</p>

## Additional information

Problem	Check	Remedy
The fader start function does not work.	Is a cue set?	Set a cue. (p.62)
	Is the fader start setting incorrect?	To enable the fader start setting, select the <b>[Mixer]</b> tab of <b>[Preferences]</b> > <b>[Controller]</b> in rekordbox and then select the <b>[Fader Start]</b> check box. (p.84)
Only one track deck is display on the screen. The platter is not displayed on the track deck.	Is rekordbox set to <b>[EXPORT]</b> mode?	Click the area indicated by <b>[EXPORT]</b> at the upper left of the screen, and then select <b>[PERFORMANCE]</b> .
The sound of the sampler deck cannot be monitored with headphones.	Is the position of the <b>[SAMPLER LEVEL]</b> control fully turned counterclockwise?	Set the <b>[SAMPLER LEVEL]</b> control to an appropriate position.

## Liquid crystal display

- The LCD display is manufactured using extremely high precision technology, but even so defective pixels (small number of black dots or constantly lit red, blue, and green dots) may be visible on some parts of the screen. Also, color unevenness and brightness unevenness may be visible depending on the angle of view. These phenomena are due to the characteristics of LCD displays and are not an indication of a failure.
- When this unit is used in cold places, the liquid crystal display may be dark for a while after this unit is turned on. It will reach the normal brightness after a while.
- When the liquid crystal display is exposed to direct sunlight, the light will reflect off it, making it difficult to see. Block the direct sunlight.

## Signal flow

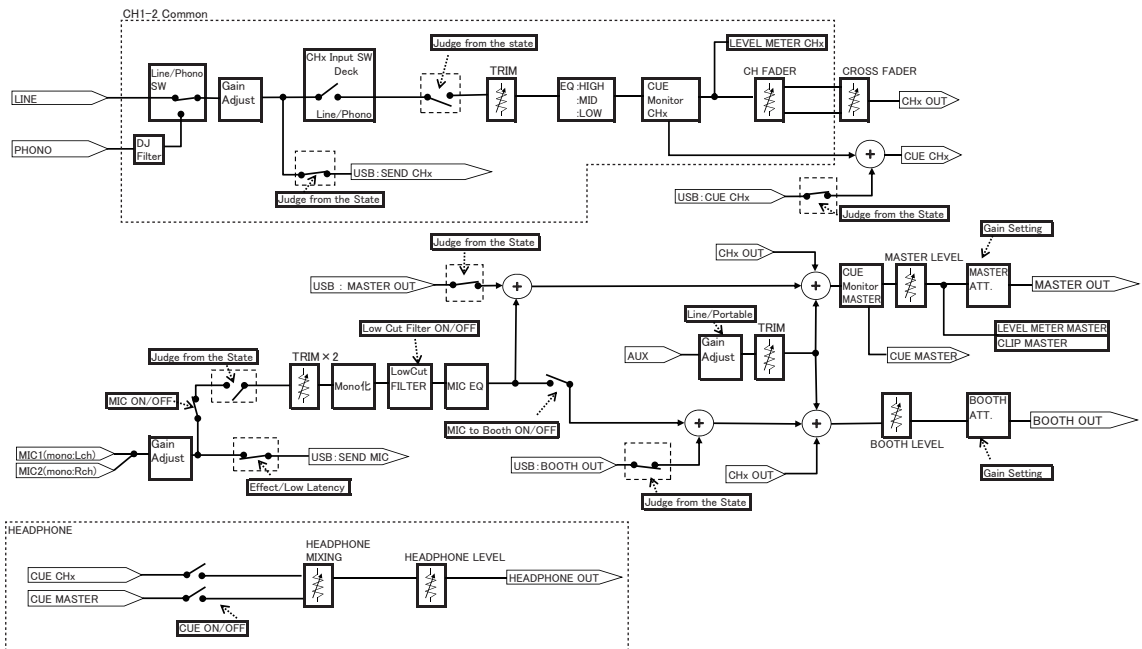

---

---

## Specifications

### AC adapter

Power source.....	AC 100 V to 240 V, 50 Hz/60 Hz
Rated current.....	0.6 A
Rated output.....	DC 12 V, 2 A

### General – Main Unit

Power consumption.....	DC 12 V, 1 400 mA
Main unit weight.....	4.7 kg
Max. external dimensions .....	632 mm (width) x 69.7 mm (height) x 334.5 mm (depth)
Tolerable operating temperature.....	+5 °C to +35 °C
Tolerable operating humidity.....	5 % to 85 % (no condensation)

### Audio Section

Sampling rate.....	44.1 kHz
A/D, D/A converter.....	24-bit

#### Frequency characteristic

<b>USB, LINE, MIC 1, MIC 2</b> .....	20 Hz to 20 kHz
--------------------------------------	-----------------

#### S/N ratio (rated output, A-WEIGHTED)

<b>USB</b> .....	111 dB
<b>LINE</b> .....	94 dB
<b>PHONO</b> .....	80 dB
<b>AUX (0 dB)</b> .....	94 dB
<b>AUX (12 dB)</b> .....	94 dB
<b>MIC 1</b> .....	77 dB
<b>MIC 2</b> .....	77 dB

#### Total harmonic distortion (20 Hz to 20 kHzBW)

<b>USB</b> .....	0.003 %
<b>LINE</b> .....	0.005 %

## Additional information

### Standard input level / Input impedance

<b>LINE</b> .....	-12 dBu/47 k $\Omega$
<b>PHONO</b> .....	-52 dBu/47 k $\Omega$
<b>AUX (0 dB)</b> .....	-12 dBu/47 k $\Omega$
<b>AUX (12 dB)</b> .....	-24 dBu/47 k $\Omega$
<b>MIC 1</b> .....	-57 dBu/3 k $\Omega$
<b>MIC 2</b> .....	-57 dBu/3 k $\Omega$

### Standard output level / Load impedance / Output impedance

<b>MASTER 1</b> .....	+6 dBu/10 k $\Omega$ /410 $\Omega$ or less
<b>MASTER 2</b> .....	+2 dBu/10 k $\Omega$ /1 k $\Omega$ or less
<b>BOOTH</b> .....	+6 dBu/10 k $\Omega$ /820 $\Omega$ or less
<b>PHONES</b> .....	+8 dBu/32 $\Omega$ /10 $\Omega$ or less

### Rated output level / Load impedance

<b>MASTER 1</b> .....	25 dBu/10 k $\Omega$
<b>MASTER 2</b> .....	21 dBu/10 k $\Omega$
<b>BOOTH</b> .....	25 dBu/10 k $\Omega$

### Crosstalk

<b>LINE</b> .....	82 dB
-------------------	-------

### Channel equalizer characteristic

<b>HI</b> .....	-26 dB to +6 dB (20 kHz)
<b>MID</b> .....	-26 dB to +6 dB (1 kHz)
<b>LOW</b> .....	-26 dB to +6 dB (20 Hz)

### Microphone equalizer characteristic

<b>HI</b> .....	-12 dB to +12 dB (10 kHz)
<b>LOW</b> .....	-12 dB to +12 dB (100 Hz)

### Input / Output terminals

#### LINE/PHONO input terminals

RCA pin jacks .....	2 sets
---------------------	--------

#### AUX input terminal

RCA pin jacks .....	1 set
---------------------	-------

#### MIC input terminals

XLR connector & 1/4" TRS jack.....	1 set
1/4" TRS jack .....	1 set

<b>MASTER 1</b> output terminal	
XLR connector .....	1 set
<b>MASTER 2</b> output terminal	
RCA pin jacks .....	1 set
<b>BOOTH</b> output terminal	
1/4" TRS jack .....	1 set
<b>PHONES</b> output terminal	
1/4" stereo jack .....	1 set
3.5 mm stereo mini jack .....	1 set
<b>USB</b> terminals	
B type.....	1 set

The specifications and design of this product are subject to change without notice.

---

---

### Using this unit as a controller for other DJ software

This unit also outputs the operation information of buttons and controls in universal MIDI format. When this unit is connected by USB cable to a PC/Mac on which MIDI-compatible DJ software is installed, the DJ software can be operated from the unit. The sound of the music file that is playing on the PC/Mac can be output from this unit.

Set the DJ software's audio and MIDI related settings. (p.83)

- For details, see your DJ software's operating instructions.

---

### MIDI messages

For details on the MIDI messages on this unit, see "List of MIDI Messages".

- "List of MIDI Messages" can be acquired from the following Pioneer DJ site.  
[pioneerdj.com/](http://pioneerdj.com/)



### Driver software

This driver software is an exclusive driver for outputting audio from a PC/Mac.

- First read the *Software end user license agreement* on page 110 carefully.

### Operating environment

#### Supported operating systems

Mac:

macOS Mojave 10.14  
macOS High Sierra 10.13  
macOS Sierra 10.12

(latest update)

Windows:

Windows® 10  
Windows® 8.1  
Windows® 7

32-bit version or 64-bit version  
(latest service pack)

#### ❖ Checking the latest information on the driver software

For the latest information on the dedicated driver software for this unit, see the following Pioneer DJ support site.

- [pioneerdj.com/](http://pioneerdj.com/)

### Obtaining the driver software

- 1 **Launch a web browser on the PC/Mac and access the Pioneer DJ site below.**

pioneerdj.com/

- 2 **Click [Support].**
- 3 **Click [Software & firmware updates].**
- 4 **Click [DDJ-800] in the [DJ CONTROLLER] category.**
- 5 **After clicking [Drivers], download the latest driver software from the download page.**

Download the driver software for either Mac or Windows from the download page.

---

### Installation (for Mac)

Do not connect this unit and the Mac until installation is completed.

- If any other programs are running on the Mac, quit all of them.
- 1 **Unzip the driver software for Mac (DDJ800MXXXdmg.zip) downloaded in *Obtaining the driver software*.**
  - 2 **Double-click [DDJ-800\_M\_X.X.X.dmg].**
  - 3 **Double-click [DDJ-800AudioDriver.pkg].**  
The driver software installation screen appears.
  - 4 **Check the details on the screen and click [Continue Anyway].**
  - 5 **When the end user license agreement appears, read the *Software end user license agreement* carefully, and then click [Continue Anyway].**
  - 6 **If you consent to the provisions of the *Software end user license agreement*, click [Agree].**  
If you do not consent to the provisions of the *Software end user license agreement*, click [Disagree] and stop installation.

### 7 Complete the installation by following the instructions on the screen.

#### ❖ Precautions when installing the driver software in macOS Mojave 10.14 or macOS High Sierra 10.13

A new security function has been added to macOS Mojave 10.14 and macOS High Sierra 10.13.

When installing Pioneer DJ's driver software in macOS Mojave 10.14 or macOS High Sierra 10.13, you need to perform the following procedure to enable the driver software.

This procedure is necessary when newly installing the driver software in macOS Mojave 10.14 or macOS High Sierra 10.13. It is not necessary if the driver software was installed in macOS or OS X before updating to macOS Mojave 10.14 or macOS High Sierra 10.13.

### 1 Install Pioneer DJ's driver software in macOS Mojave 10.14 or macOS High Sierra 10.13.

The following dialog box will appear during driver software installation.

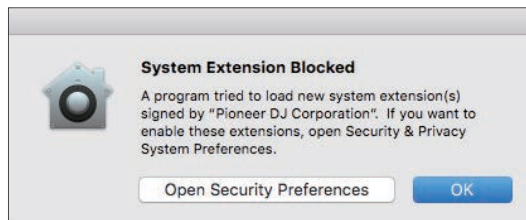

### 2 Click [Open Security Preferences].

The [Security & Privacy] dialog box is displayed.

- 3 Check that [System software from developer “Pioneer DJ Corporation” was blocked from loading.] appears at the bottom of the screen.

This message will be displayed for 30 minutes after you start the installation of the driver software.

If it is not displayed, reinstall the driver software.

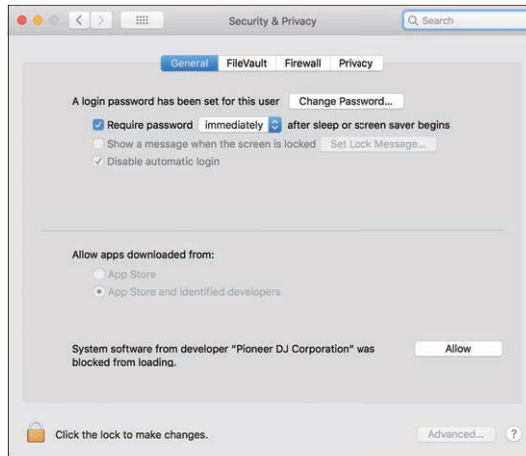

- 4 Click [Allow] at the bottom right of the screen.
- 5 When this unit is connected to a Mac, disconnect the USB cable and then reconnect it again.

### Installation procedure (Windows)

Do not connect this unit and the PC until installation is completed.

- Log on as the user which was set as the PC's administrator before installation.
- If any other programs are running on the PC, quit all of them.

**1 Unzip the driver software for Windows (DDJ800XXXexe.zip) downloaded in *Obtaining the driver software*.**

**2 Double-click [DDJ-800\_X.XXX.exe].**

The driver software installation screen appears.

**3 Carefully read the *Software end user license agreement* and if you consent to the provisions, put a check mark in [I agree.] and click [OK].**

If you do not consent to the provisions of the *Software end user license agreement*, click [Cancel] and stop installation.

**4 Complete the installation by following the instructions on the screen.**

If [Windows Security] appears on the screen while the installation is in progress, click [Install this driver software anyway] to continue the installation.

When the installation is completed, a completion message appears.

### **Software end user license agreement**

This Software End User License Agreement (“Agreement”) is between you (both the individual installing the Program and any single legal entity for which the individual is acting) (“You” or “Your”) and Pioneer DJ Corporation (“Pioneer DJ”).

TAKING ANY STEP TO SET UP OR INSTALL THE PROGRAM MEANS THAT YOU ACCEPT ALL OF THE TERMS OF THIS LICENSE AGREEMENT. PERMISSION TO DOWNLOAD AND/OR USE THE PROGRAM IS EXPRESSLY CONDITIONED ON YOUR FOLLOWING THESE TERMS. WRITTEN OR ELECTRONIC APPROVAL IS NOT REQUIRED TO MAKE THIS AGREEMENT VALID AND ENFORCEABLE. IF YOU DO NOT AGREE TO ALL OF THE TERMS OF THIS AGREEMENT, YOU ARE NOT AUTHORIZED TO USE THE PROGRAM AND MUST STOP INSTALLING IT OR UNINSTALL IT, AS APPLICABLE.

#### **1 DEFINITIONS**

- 1** “Documentation” means written documentation, specifications and help content made generally available by Pioneer DJ to aid in installing and using the Program.
- 2** “Program” means all or any part of Pioneer DJ’s software licensed to You by Pioneer DJ under this Agreement.

#### **2 PROGRAM LICENSE**

- 1** Limited License. Subject to this Agreement’s restrictions, Pioneer DJ grants to You a limited, non-exclusive, non-transferable, license (without the right to sublicense):
  - a To install a single copy of the Program in Your computer or mobile device, to use the Program only for Your personal purpose complying with this Agreement and the Documentation (“Authorized Use”);
  - b To use the Documentation in support of Your Authorized Use; and

- c To make one copy of the Program solely for backup purposes, provided that all titles and trademark, copyright and restricted rights notices are reproduced on the copy.
- 2 **Restrictions.** You will not copy or use the Program or Documentation except as expressly permitted by this Agreement. You will not transfer, sublicense, rent, lease or lend the Program, or use it for third-party training, commercial time-sharing or service bureau use. You will not Yourself or through any third party modify, reverse engineer, disassemble or decompile the Program, except to the extent expressly permitted by applicable law, and then only after You have notified Pioneer DJ in writing of Your intended activities.
- 3 **Ownership.** Pioneer DJ or its licensor retains all right, title and interest in and to all patent, copyright, trademark, trade secret and other intellectual property rights in the Program and Documentation, and any derivative works thereof. You do not acquire any other rights, express or implied, beyond the limited license set forth in this Agreement.
- 4 **No Support.** Pioneer DJ has no obligation to provide support, maintenance, upgrades, modifications or new releases for the Program or Documentation under this Agreement.

### **3 WARRANTY DISCLAIMER**

THE PROGRAM AND DOCUMENTATION ARE PROVIDED “AS IS” WITHOUT ANY REPRESENTATIONS OR WARRANTIES, AND YOU AGREE TO USE THEM AT YOUR SOLE RISK. TO THE FULLEST EXTENT PERMISSIBLE BY LAW, PIONEER DJ EXPRESSLY DISCLAIMS ALL WARRANTIES OF ANY KIND WITH RESPECT TO THE PROGRAM AND DOCUMENTATION, WHETHER EXPRESS, IMPLIED, STATUTORY, OR ARISING OUT OF COURSE OF PERFORMANCE, COURSE OF DEALING OR USAGE OF TRADE, INCLUDING ANY WARRANTIES OF MERCHANTABILITY, FITNESS FOR A PARTICULAR PURPOSE, SATISFACTORY QUALITY, ACCURACY, TITLE OR NON-INFRINGEMENT.

### **4 EXPORT CONTROL AND COMPLIANCE WITH LAWS AND REGULATIONS**

You may not use or otherwise export or re-export the Program except as authorized by United States law and the laws of the jurisdiction in which the Program was obtained. In particular, but without limitation, the Program

may not be exported or re-exported (a) into any U.S.-embargoed countries or (b) to anyone on the U.S. Treasury Department's Specially Designated Nationals List or the U.S. Department of Commerce Denied Persons List or Entity List. By using the Program, you represent and warrant that you are not located in any such country or on any such list. You also agree that you will not use the Program for any purposes prohibited by United States law, including, without limitation, the development, design, manufacture, or production of nuclear, missile, or chemical or biological weapons.

### **5 U.S. GOVERNMENT RESTRICTED RIGHTS**

The Program and Documentations are "commercial computer software" and "commercial computer software documentation" as those terms are defined in 48 C.F.R. §252.227-7014 (a) (1) (2007) and 252.227-7014 (a) (5) (2007). The U.S. Government's rights with respect to the Program and Documentations are limited by this license pursuant to 48 C.F.R. §12.212 (Computer software) (1995) and 48 C.F.R. §12.211 (Technical data) (1995) and/or 48 C.F.R. §227.7202-3, as applicable. As such, the Program and Documentations are being licensed to the U.S. Government end users: (a) only as "commercial items" as that term is defined in 48 C.F.R. §2.101 generally and as incorporated in DFAR 212.102; and (b) with only those limited rights as are granted to the public pursuant to this license. Under no circumstance will the U.S. Government or its end users be granted any greater rights than we grant to other users, as provided for in this license. Manufacturer is Pioneer DJ Corporation, 6F, Yokohama i-Mark Place, 4-4-5 Minatomirai, Nishi-ku, Yokohama, Kanagawa, 220-0012 Japan

### **6 DAMAGES AND REMEDIES FOR BREACH**

You agree that any breach of this Agreement's restrictions would cause Pioneer DJ irreparable harm for which money damages alone would be inadequate. In addition to damages and any other remedies to which Pioneer DJ may be entitled, You agree that Pioneer DJ may seek injunctive relief to prevent the actual, threatened or continued breach of this Agreement.

### **7 TERMINATION**

Pioneer DJ may terminate this Agreement at any time upon Your breach of any provision. If this Agreement is terminated, You will stop using the Program, permanently delete it from your computer or mobile device where it resides, and destroy all copies of the Program and Documentation in Your possession, confirming to Pioneer DJ in writing that You have done



so. Sections 2.2, 2.3, 2.4, 3, 4, 5, 6, 7 and 8 will continue in effect after this Agreement's termination.

### 8 GENERAL TERMS

- 1** Limitation of Liability. In no event will Pioneer DJ or its subsidiaries be liable in connection with this Agreement or its subject matter, under any theory of liability, for any indirect, incidental, special, consequential or punitive damages, or damages for lost profits, revenue, business, savings, data, use, or cost of substitute procurement, even if advised of the possibility of such damages or if such damages are foreseeable. In no event will Pioneer DJ's liability for all damages exceed the amounts actually paid by You to Pioneer DJ or its subsidiaries for the Program. The parties acknowledge that the liability limits and risk allocation in this Agreement are reflected in the Program price and are essential elements of the bargain between the parties, without which Pioneer DJ would not have provided the Program or entered into this Agreement.
- 2** The limitations or exclusions of warranties and liability contained in this Agreement do not affect or prejudice Your statutory rights as consumer and shall apply to You only to the extent such limitations or exclusions are permitted under the laws of the jurisdiction where You are located.
- 3** Severability and Waiver. If any provision of this Agreement is held to be illegal, invalid or otherwise unenforceable, that provision will be enforced to the extent possible or, if incapable of enforcement, deemed to be severed and deleted from this Agreement, and the remainder will continue in full force and effect. The waiver by either party of any default or breach of this Agreement will not waive any other or subsequent default or breach.
- 4** No Assignment. You may not assign, sell, transfer, delegate or otherwise dispose of this Agreement or any rights or obligations under it, whether voluntarily or involuntarily, by operation of law or otherwise, without Pioneer DJ's prior written consent. Any purported assignment, transfer or delegation by You will be null and void. Subject to the foregoing, this Agreement will be binding upon and will inure to the benefit of the parties and their respective successors and assigns.
- 5** Entire Agreement. This Agreement constitutes the entire agreement between the parties and supersedes all prior or contemporaneous agreements or representations, whether written or oral, concerning

its subject matter. This Agreement may not be modified or amended without Pioneer DJ's prior and express written consent, and no other act, document, usage or custom will be deemed to amend or modify this Agreement.

- 6 You agree that this Agreement shall be governed and construed by and under the laws of Japan.

---

### Trademarks and registered trademarks

- Pioneer DJ is a trademark of PIONEER CORPORATION and is used under license.
- rekordbox is a registered trademark of Pioneer DJ Corporation.
- Mac, macOS, OS X, and Finder are trademarks of Apple Inc., registered in the U.S. and other countries.
- Windows is a registered trademark of Microsoft Corporation in the U.S. and other countries.
- Intel and Intel Core are registered trademarks of Intel Corporation in the U.S. and other countries.
- ASIO is a trademark of Steinberg Media Technologies GmbH.

The names of companies and products mentioned herein are trademarks or registered trademarks of their respective owners.

This product has been licensed for nonprofit use. This product has not been licensed for commercial purposes (for profit-making use), such as broadcasting (terrestrial, satellite, cable or other types of broadcasting), streaming on the Internet, Intranet (corporate networks) or other types of networks or distributing of electronic information (online digital music distribution services). You need to acquire the corresponding licenses for such uses. For details, see <http://www.mp3licensing.com>.

### **Cautions on copyrights**

rekordbox restricts playback and duplication of copyright-protected music contents.

- When coded data, etc., for protecting the copyright is embedded in the music contents, it may not be possible to operate the program normally.
- When rekordbox detects that coded data, etc., for protecting the copyright is embedded in the music contents, processing (playback, reading, etc.) may stop.

Recordings you have made are for your personal enjoyment and according to copyright laws may not be used without the consent of the copyright holder.

- Music recorded from CDs, etc., is protected by the copyright laws of individual countries and by international treaties. It is the full responsibility of the person who has recorded the music to ensure that it is used legally.
- When handling music downloaded from the Internet, etc., it is the full responsibility of the person who has downloaded the music to ensure that it is used in accordance with the contract concluded with the download site.

© 2019 Pioneer DJ Corporation. All rights reserved.

<DRI1577-A>