

Panasonic®

Operating Instructions

LCD Projector **Commercial Use**

Model No. **PT-LB80NTU**

PT-LB80U

PT-LB75NTU

PT-LB75U

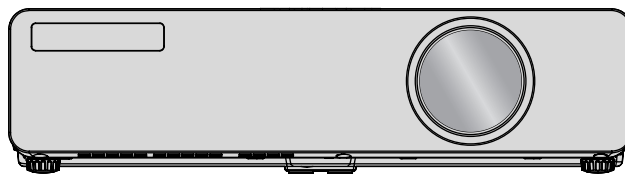

Before operating this product, please read the instructions carefully and save this manual for future use.

TQBJ0244

ENGLISH

Important Safety Notice

Dear Panasonic Customer:

The following information should be read and understood as it provides details, which will enable you to operate the projector in a manner which is both safe to you and your environment, and conforms to legal requirements regarding the use of projectors. Before connecting, operating or adjusting this projector, please read these instructions completely and save this booklet with the projector for future reference. We hope it will help you to get the most out of your new product, and that you will be pleased with your Panasonic LCD projector.

The serial number of your product may be found on its bottom. You should note it in the space provided below and retain this booklet in case service is required.

Model number: PT-LB80NTU / PT-LB75NTU/PT-LB80U/PT-LB75U

Serial number:

WARNING: TO REDUCE THE RISK OF FIRE OR ELECTRIC SHOCK, DONOT EXPOSE THIS PRODUCT TO RAIN OR MOISTURE.

Power Supply: This LCD Projector is designed to operate on 100 V - 240 V, 50 Hz/60 Hz AC, house current only.

CAUTION: The AC power cord which is supplied with the projector as an accessory can only be used for power supplies up to 125 V, 7 A. If you need to use higher voltages or currents than this, you will need to obtain a separate 250 V power cord. If you use the accessory cord in such situations, fire may result.



The lightning flash with arrowhead symbol, within an equilateral triangle, is intended to alert the user to the presence of uninsulated "dangerous voltage" within the product's enclosure that may be of sufficient magnitude to constitute a risk of electric shock to persons.



The exclamation point within an equilateral triangle is intended to alert the user to the presence of important operating and maintenance (servicing) instructions in the literature accompanying the product.

CAUTION: This equipment is equipped with a three-pin grounding-type power plug. Do not remove the grounding pin on the power plug. This plug will only fit a grounding-type power outlet. This is a safety feature. If you are unable to insert the plug into the outlet, contact an electrician. Do not defeat the purpose of the grounding plug.

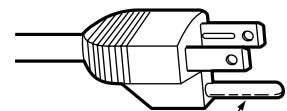

Do not remove

Pursuant to at the directive 2004/108/EC, article 9(2)
Panasonic Testing Center
Panasonic Service Europe, a division of Panasonic Marketing Europe GmbH
Winsbergring 15, 22525 Hamburg, F.R. Germany

NOTICE:

- This product has a High Intensity Discharge (HID) lamp that contains mercury. Dispose may be regulated in your community due to environmental considerations. For disposal or recycling information, please contact your local authorities, or the Electronic Industries Alliance: <http://www.eiae.org>

WARNING:

This equipment has been tested and found to comply with the limits for a Class B digital device, pursuant to Part 15 of the FCC Rules. These limits are designed to provide reasonable protection against harmful interference in a residential installation. This equipment generates, uses and can radiate radio frequency energy and, if not installed and used in accordance with the instructions, may cause harmful interference to radio communications. However, there is no guarantee that interference will not occur in a particular installation. If this equipment does cause harmful interference to radio or television reception, which can be determined by turning the equipment off and on, the user is encouraged to try to correct the interference by one or more of the following measures:

- Reorient or relocate the receiving antenna.
- Increase the separation between the equipment and receiver.
- Connect the equipment into an outlet on a circuit different from that to which the receiver is connected.
- Consult the dealer or an experienced radio/TV technician for help.

FCC CAUTION: To assure continued compliance, follow the attached installation instructions and use only shielded interface cables when connecting to computer and/or peripheral devices. Any changes or modifications not expressly approved by Panasonic Corp. of North America could void the user's authority to operate this device.

FCC RF Exposure Warning: (if provided with wireless device)

- This equipment complied with FCC radiation exposure limits set forth for an uncontrolled environment.
- This equipment has been approved for mobile operation and requires minimum 20 cm spacing be provided between antenna(s) and all person's body (excluding extremities of hands, wrist and feet) during wireless modes of operation.
- This equipment may not be used with other installed transmitters, which may be capable of simultaneous transmission.

WARNING:

- Not for use in a computer room as defined in the Standard for the Protection of Electronic Computer/Data Processing Equipment, ANSI/NFPA 75.
- For permanently connected equipment, a readily accessible disconnect device shall be incorporated in the building installation wiring.
- For pluggable equipment, the socket-outlet shall be installed near the equipment and shall be easily accessible.

Declaration of Conformity

Model Number: PT-LB80NTU / PT-LB75NTU/PT-LB80U/PT-LB75U
 Trade Name: **Panasonic**
 Responsible party: Panasonic Corporation of North America
 Address: One Panasonic Way, Secaucus, New Jersey 07094
 Telephone number: (888) 411 - 1996
 E-mail: projectorsupport@us.panasonic.com

This device complies with Part 15 of the FCC Rules. Operation is subject to the following two conditions: (1) This device may not cause harmful interference, and (2) this device must accept any interference received, including interference that may cause undesired operation.

Information on Disposal in other Countries outside the European



This symbol is only valid in the European Union.

If you wish to discard this product, please contact your local authorities or dealer and ask for the correct method of disposal.

Contents

Quick steps

1. Set up your projector
See “Setting up” on page 15.



2. Connect with other devices
See “Connections” on page 17.



3. Prepare the Remote control
See “Remote control” on page 14.



4. Start projecting
See “Switching the projector on/off” on page 18.



5. Adjust the image
See “Menu Navigation” on page 27.

- **When you start the projection for the first time, the minimum required setting screen for projection will be displayed.**
See “Minimum required setting screen” on page 11.

Important Information

Important Safety Notice	2
Precautions with regard to safety	6
WARNINGS	6
CAUTIONS.....	7
Cautions when transporting	8
Cautions when installing	9
Cautions on use	9
Security	9
Accessories.....	10

Preparation

Read this first	11
Minimum required setting screen	11
About Your Projector	12
Projector body	12
Remote control.....	14

Getting Started

Setting up	15
Screen size and throw distance	15
Projection method	16
Front leg adjusters and throwing angle	16
Connections	17
Before connection to the projector	17
Connecting example: AV equipment.....	17
Connecting example: Computers.....	17

Basic Operation

Switching the projector on/off	18
Power cord	18
Switching on the projector.....	19
Switching off the projector.....	20
POWER and POWER LOCK indicators.....	21
Projecting an image	22
Selecting the input signal	22
Positioning the image.....	22
Remote control operation	23
Operating range	23
Setting up the image position automatically.....	23
Switching the input signal.....	24
Capturing an image.....	24
Stopping the projection temporary	24
Resetting to the factory default settings.....	24
Projecting an image in INDEX-WINDOW mode.....	25
Using an assigned function	25
Controlling the volume of the speaker.....	25
Enlarging the centered area.....	26

Settings

Menu Navigation	27
Navigating through the MENU	27
Main menu and Sub-menu	28
PICTURE menu	30
PICTURE MODE	30
CONTRAST	30
BRIGHTNESS	30
COLOR	30
TINT	30
SHARPNESS	30
COLOR TEMPERATURE	30
DAYLIGHT VIEW	30
DETAILED SETUP	31
POSITION menu	32
REALTIME KEYSTONE	32
KEYSTONE	32
POSITION	32
DOT CLOCK	32
CLOCK PHASE	32
ASPECT	32
FRAME LOCK	33
OPTION menu	34
INPUT GUIDE	34
STARTUP LOGO	34
COMPUTER2 SELECT	34
RGB/YPBPR	34
WIDE MODE	34
LAMP POWER	35
LAMP RUNTIME	35
POWER OFF TIMER	35
DIRECT POWER ON	35
CONTROL PANEL	35
AUTO SETUP	35
SIGNAL SEARCH	35
INSTALLATION	35
ALTITUDE	35
CLOSED CAPTION SETTING	36
FUNCTION BUTTON	36
TEST PATTERN	36
DETAILED SETUP	36
SECURITY menu	37
INPUT PASSWORD	37
PASSWORD CHANGE	37
TEXT DISPLAY	37
TEXT CHANGE	37
WIRELESS menu	38
Items in WIRELESS menu	38

Maintenance

LAMP and TEMP Indicators	39
Managing the indicated problems	39
Care and Replacement	40
Cleaning the projector	40
Replacing the Lamp unit	41
Troubleshooting	43

Appendix

Technical Information	44
List of compatible signals	44
Serial terminal	45
Computer connection guidance	46
Screen size and throw distance for 16:9 aspect ratio	47
Specifications	48
Dimensions	50
Trademark acknowledgements	50
Index	51
Avis important concernant la sécurité	53
Précautions de sécurité	55
AVERTISSEMENTS	55
MISES EN GARDE	56
Précautions lors du transport	57
Précautions lors de l'installation	57
Précautions lors de l'utilisation	58
Sécurité	58
Remplacement de l'unité de la lampe	59
Protections du support de montage au plafond	60

Important Information

Preparation

Getting Started

Basic Operation

Settings

Maintenance

Appendix

Precautions with regard to safety

WARNINGS

If you notice smoke, strange smells or noise coming from the projector, disconnect the power plug from the wall outlet.

- Do not continue to use the projector in such cases, otherwise fire or electric shocks could result.
- Check that no more smoke is coming out, and then contact an Authorized Service Center for repairs.
- Do not attempt to repair the projector yourself, as this can be dangerous.

Do not install this projector in a place which is not strong enough to take the full weight of the projector.

- If the installation location is not strong enough, it may fall down or tip over, and severe injury or damage could result.

Installation work (such as ceiling suspension) should only be carried out by a qualified technician.

- If installation is not carried out correctly, there is the danger that injury or electric shocks may occur.
- Do not use other than an authorized ceiling mount bracket.

If foreign objects or water get inside the projector, or if the projector is dropped or the cabinet is broken, disconnect the power plug from the wall outlet.

- Continued use of the projector in this condition may result in fire or electric shocks.
- Contact an Authorized Service Center for repairs.

The wall outlet shall be installed near the equipment and shall be easily accessible.

- Unplug the power plug from the wall outlet immediately when problem occurred.

Do not overload the wall outlet.

- If the power supply is overloaded (for example, by using too many adapters), overheating may occur and fire may result.

Never attempt to modify or disassemble the projector.

- High voltages can cause fire or electric shocks.
- For any inspection, adjustment and repair work, please contact an Authorized Service Center.

Clean the power plug regularly to prevent it from becoming covered in dust.

- If dust builds up on the power plug, the resulting humidity can damage the insulation, which could result in fire. Pull the power plug out from the wall outlet and wipe it with a dry cloth.
- If not using the projector for an extended period of time, pull the power plug out from the wall outlet.

Do not handle the power plug with wet hands.

- Failure to observe this may result in electric shocks.

Insert the power plug securely into the wall outlet.

- If the plug is not inserted correctly, electric shocks or overheating could result.
- Do not use plugs which are damaged or wall outlets which are coming loose from the wall.

Do not place the projector on top of surfaces which are unstable.

- If the projector is placed on top of a surface which is sloped or unstable, it may fall down or tip over, and injury or damage could result.
- Do not use the projector at a raised or a horizontally tilted position as it may cause malfunction of the projector.

Do not place the projector into water or let it become wet.

- Failure to observe this may result in fire or electric shocks.

Do not do anything that might damage the power cord or the power plug.

- Do not damage the power cord, make any modifications to it, place it near any hot objects, bend it excessively, twist it, pull it, place heavy objects on top of it or wrap it into a bundle.
- If the power cord is used while damaged, electric shocks, short-circuits or fire may result.
- Ask an Authorized Service Center to carry out any repairs to the power cord that might be necessary.

Do not place the projector on soft materials such as carpets or sponge mats.

- Doing so may cause the projector to overheat, which can cause burns, fire or damage to the projector.

Do not place liquid containers on top of the projector.

- If water spills onto the projector or gets inside it, fire or electric shocks could result.
- If any water gets inside the projector, contact an Authorized Service Center.

Do not insert any foreign objects into the projector.

- Do not insert any metal objects or flammable objects into the projector or drop them onto the projector, as doing so can result in fire or electric shocks.

Do not use the projector in a bath or shower.

- Fire or electric shocks can result.

During a thunderstorm, do not touch the projector or the cable.

- Electric shocks can result.

Precautions with regard to safety

Do not place your skin into the light beam while the projector is being used.

- Strong light is emitted from the projector's lens. If you place directly into this light, it can hurt or damage your skin.

Do not allow the + and - terminals of the batteries to come into contact with metallic objects such as necklaces or hairpins.

- Failure to observe this may cause the batteries to leak, overheat, explode or catch fire.
- Store the batteries in a plastic bag and keep them away from metallic objects.
- Use manganese batteries or alkaline batteries with the remote control.

Do not touch the leaked liquid from the batteries.

- If you touch the leaked liquid, it may hurt your skin. Immediately wash away the liquid with water and seek medical advice.
- If you get the leaked liquid in your eye, it may cause blindness or damage. Never rub your eye, and immediately wash away the liquid with water and seek medical advice.
- Damaged or insulation may cause leak of battery.

Do not look into the lens while the projector is being used.

- Strong light is emitted from the projector's lens. If you look directly into this light, it can hurt and damage your eyes.
- Be especially careful not to let young children look into the lens. In addition, turn off the power and disconnect the power plug when you are away from the projector.

Do not place your hands or other objects close to the air outlet port.

- Heated air comes out of the air outlet port. Do not place your hands or face, or objects which cannot withstand heat close to this port [allow at least 50 cm (20") of space], otherwise burns or damage could result.

Replacement of the lamp is recommended to be carried out by a qualified technician.

- The lamp has high internal pressure. If improperly handled, explosion might result.
- The lamp can easily become damaged if struck against hard objects or dropped, and injury or malfunctions may result.

When replacing the lamp, allow it to cool for at least one hour before handling it.

- The lamp cover gets very hot, and touching it can cause burns.

Before replacing the lamp, be sure to disconnect the power plug from the wall outlet.

- Electric shocks or explosions can result if this is not done.

Do not allow infants or pets to touch the remote control unit.

- Keep the remote control unit out of the reach of infants and pets after using it.

CAUTIONS

Do not cover the air inlet port or the air outlet port.

- Doing so may cause the projector to overheat, which can cause fire or damage to the projector.
- Do not place the projector in narrow, badly ventilated places such as closets or bookshelves.
- Do not place the projector on cloth or papers, as these materials could be drawn into the air inlet port.

Do not set up the projector in humid or dusty places or in places where the projector may come into contact with oily smoke or steam.

- Using the projector under such conditions may result in fire, electric shocks or plastic deterioration. The plastic deterioration may cause the falling down of the projector which is mounted in the ceiling.

Do not set up the projector in a high temperature environment, such as near a heater or in direct sunlight.

- Failure to observe this may result in fire, malfunction or plastic deterioration.

Do not set up the projector outdoors.

- The projector is designed for indoor use only.

When disconnecting the power cord, hold the plug, not the cord.

- If the power cord itself is pulled, the cord will become damaged, and fire, short-circuits or serious electric shocks may result.

Always disconnect all cables before moving the projector.

- Moving the projector with cables still attached can damage the cables, which could cause fire or electric shocks to occur.

Do not place any heavy objects on top of the projector.

- Failure to observe this may cause the projector to become unbalanced and fall, which could result in damage or injury.

Precautions with regard to safety

Do not short-circuit, heat or disassemble the batteries or place them into water or fire.

- Failure to observe this may cause the batteries to overheat, leak, explode or catch fire, and burns or other injury may result.

When inserting the batteries, make sure the polarities (+ and -) are correct.

- If the batteries are inserted incorrectly, they may explode or leak, and fire, injury or contamination of the battery compartment and surrounding area may result.

Use only the specified batteries.

- If incorrect or different kind of batteries are used, they may explode or leak, and fire, injury or contamination of the battery compartment and surrounding area may result.

Do not mix old and new batteries.

- If the batteries are inserted incorrectly, they may explode or leak, and fire, injury or contamination of the battery compartment and surrounding area may result.

Remove the used batteries from the remote control promptly.

- If you leave used batteries in the remote control for an extended period of time, it may cause liquid leaking, abnormal internal temperature rising or explosion.

If not using the projector for an extended period of time, disconnect the power plug from the wall outlet and remove the batteries from the remote control.

- If dust builds up on the power plug, the resulting humidity may damage the insulation, which could result in fire.
- Keeping or leaving the remote control with batteries inside may cause insulation deterioration, electrical leakage or explosion which could result in fire.

We are constantly making efforts to preserve and maintain a clean environment. Please take non repairable units back to your dealer or a recycling company.

Do not put your weight on this projector.

- You could fall or the projector could break, and injury may result.
- Be especially careful not to let young children stand or sit on the projector.

Disconnect the power plug from the wall outlet as a safety precaution before carrying out any cleaning.

- Electric shocks can result if this is not done.

If the lamp has broken, ventilate the room immediately. Do not touch or bring your face close to the broken pieces.

- Failure to observe this may cause the user to absorb the gas which was released when the lamp broke and which contains nearly the same amount of mercury as fluorescent lamps, and the broken pieces may cause injury.
- If you believe that you have absorbed the gas or that the gas has got into your eyes or mouth, seek medical advice immediately.
- Ask your dealer about the replacement of the lamp unit and check the inside of the projector.

Ask an Authorized Service Center to clean inside the projector at least once a year.

- If dust is left to build up inside the projector without being cleaned out, it can result in fire or problems with operation.
- It is a good idea to clean the inside of the projector before the season for humid weather arrives. Ask your nearest Authorized Service Center to clean the projector when required. Please discuss with the Authorized Service Center regarding cleaning costs.

Cautions when transporting

Do not subject the projector to excessive vibration or shocks.

- The projector lens need to be handled with care.
- Cover the lens with the lens cover when transporting the projector.

When you move the projector, hold the body at the bottom securely.

- Do not hold the adjuster legs or the leg adjuster buttons when move the projector, as this may cause damage.

When transporting, keep the projector in the provided carrying bag.

- Make the lens of the projector upward direction and put it gently into the carrying bag.
- In the carrying bag, the elongated adjuster legs must be housed.
- Do not put anything other than the projector and its accessories in the carrying bag.

Cautions when installing

Avoid setting up in places which are subject to vibration or shocks.

- The internal parts can be damaged, which may cause malfunctions or accidents.

Avoid setting up in places which are subject to sudden temperature changes, such as near an air conditioner or lighting equipment.

- The life of the lamp may be shortened or the projector may be turned off. See "TEMP indicator" on page 39.

Do not set up the projector near high-voltage power lines or near motors.

- The projector may be subject to electromagnetic interference.

If installing the projector to the ceiling, ask a qualified technician to carry out all installation work.

- You will need to purchase the separate installation kit. Furthermore, all installation work should only be carried out by a qualified technician.

If using this projector at high elevations, 1 400 - 2 700 m (4 593 - 8 858 ft) sea level, set the ALTITUDE to HIGH. See "ALTITUDE" on page 35.

- Failure to observe this may result in malfunctions or the life of the lamp or the other components may be shortened.
- Do not use the projector at high elevation higher than 2 700 m (8 858 ft).

Cautions on use

In order to get the best picture quality

- Draw curtains or blinds over any windows and turn off any lights near the screen to prevent outside light or light from indoor lamps from shining onto the screen.

Optical components

- If you use the projector consecutively 6 hours every day, the optical components may need to be replaced in less than 1 year.

Liquid crystal panel

- Do not project the same image for long periods of time, as this may remain as an afterimage on the liquid crystal panel. Display the white screen test pattern for more than an hour to remove it.
- The liquid crystal panel of the projector is built with very high precision technology to provide fine picture details. Occasionally, a few stuck pixels may appear on the screen as fixed points of blue, green or red. It is recommended to switch off the projector once and try after 1 hour later again. Please note that this does not affect the performance of your LCD.

The projector has a high pressure mercury lamp and that is characterised as follows:

- The brightness of the lamp depends on the duration of use.
- The lamp may explode or shorten the lamp life by shocks or chipping damage.
- The lamp may explode only occasionally after using the projector.
- When the lamp exploded, it emits the internal smoke-like gas.
- The lamp may explode if using the projector after the instructed lamp replacement timing.
- The lamp life is depends on individual lamp characteristics, usage condition and the installation environment. Especially the consecutive use of the projector for more than 10 hours, or the frequent switching on or off may greatly affect on the lamp life.

Do not touch the surfaces of the lens or lens cover with your bare hands.

- If the surface of the lens or lens cover becomes dirty from fingerprints or anything else, this will be magnified and projected onto the screen.

Security

Take safety measures for use of the projector which should cover the following envisioned incidents.

- The leakage of your personal registered information.
- Dishonest operation by an untrusted third party.
- Locking out or prevent anyone else from using the projector by an untrusted third party.





Security instruction

- Change your password regularly.
- Do not use too simple password to guess.
- Any of Authorized Service Centers will never ask you for the password.
- Do not share your password with the general public.
- Secure the network environment by the firewall.

Precautions with regard to safety

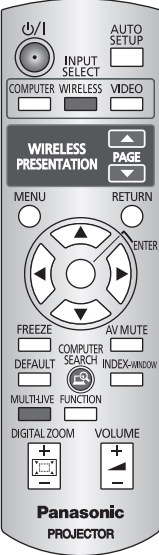
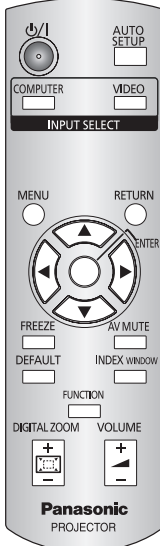
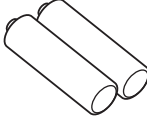
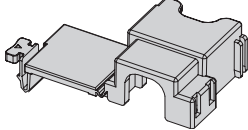
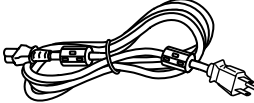
Accessories

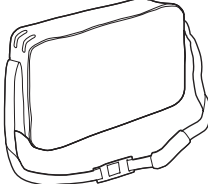
Make sure the following accessories are provided with your projector.

<p>Remote control for PT-LB80NTU / PT-LB75NTU (x1)^{*1} N2QAYB000260</p> 	<p>Remote control for PT-LB80U / PT-LB75U (x1)^{*2} N2QAYB000262</p> 	<p>AA batteries for Remote control (x2)</p> 	<p>Power cord secure lock (x1) TMXX051</p> 
		<p>Power cord (x1) K2CG3DR00007</p> 	<p>CD-ROM^{*3} (x1) TQBH9011</p> 
		<p>Carrying bag (x1) TPEP021</p> 	<p>RGB signal cable (x1) 1.8 m (5'10") K1HA15DA0002</p> 

*1. PT-LB80NTU / PT-LB75NTU only

*2. PT-LB80U / PT-LB75U only

*3. PT-LB80NTU / PT-LB75NTU only

* The protectors for enclosed products, such as a plug cover or foam cartons, must be treated properly.

* Contact to an Authorized Service Center for lost accessories.

Read this first

Minimum required setting screen

When you start the projection for the first time or after the projector is initialised, the minimum required setting screen for projection will be displayed.

LANGUAGE

Select the required language setting.

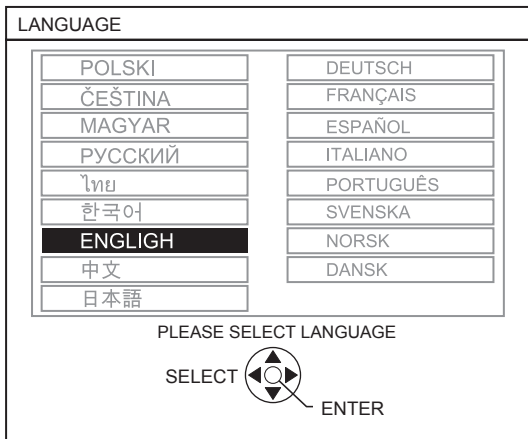

Press ▲ ▼ ◀ ▶ buttons of the remote control or control panel on the projector to highlight the required language, and press the **ENTER** button to proceed to the next setting.

OPTION

Select the current projection method and fan speed setting. If you need return to the previous setting, press the **RETURN** button.

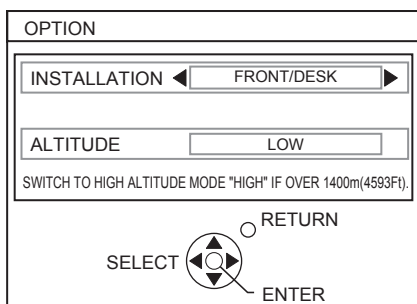

Press the ENTER button to start the projection.

- Once you finish the minimum requirement setting, it will not be displayed again unless the projector is initialised. See “INITIALIZE ALL” on page 36.
- You can change each settings in the main menu. See “Menu Navigation” on page 27.

INSTALLATION

Press ◀ ▶ buttons of the remote control or control panel on the projector to select the required installation method. Press ▼ to proceed to the **ALTITUDE** setting.

FRONT/DESK	Setting on a desk/floor and projecting from front
FRONT/CEILING	Mounting in the ceiling and projecting from front
REAR/DESK	Setting on a desk/floor and projecting from rear
REAR/CEILING	Mounting in the ceiling and projecting from rear

ALTITUDE

If you use the projector at high elevation, the **ALTITUDE** setting need to be **HIGH** to set the fan speed high. Press ◀ ▶ to select the required option. If you need to return to the **INSTALLATION**, press ▲.

- **LOW** The fan speed is low.
- **HIGH** The fan speed is high.

NOTE:

- At 1 400 - 2 700 m (4 593 - 8 858 ft) sea level, the setting must be **HIGH**.
- The loudness of fan noise depends on the **ALTITUDE** setting.

About Your Projector

Projector body

Top and front view

Zoom-Focus ring cover

Cover the zoom and focus rings to protect from dust.

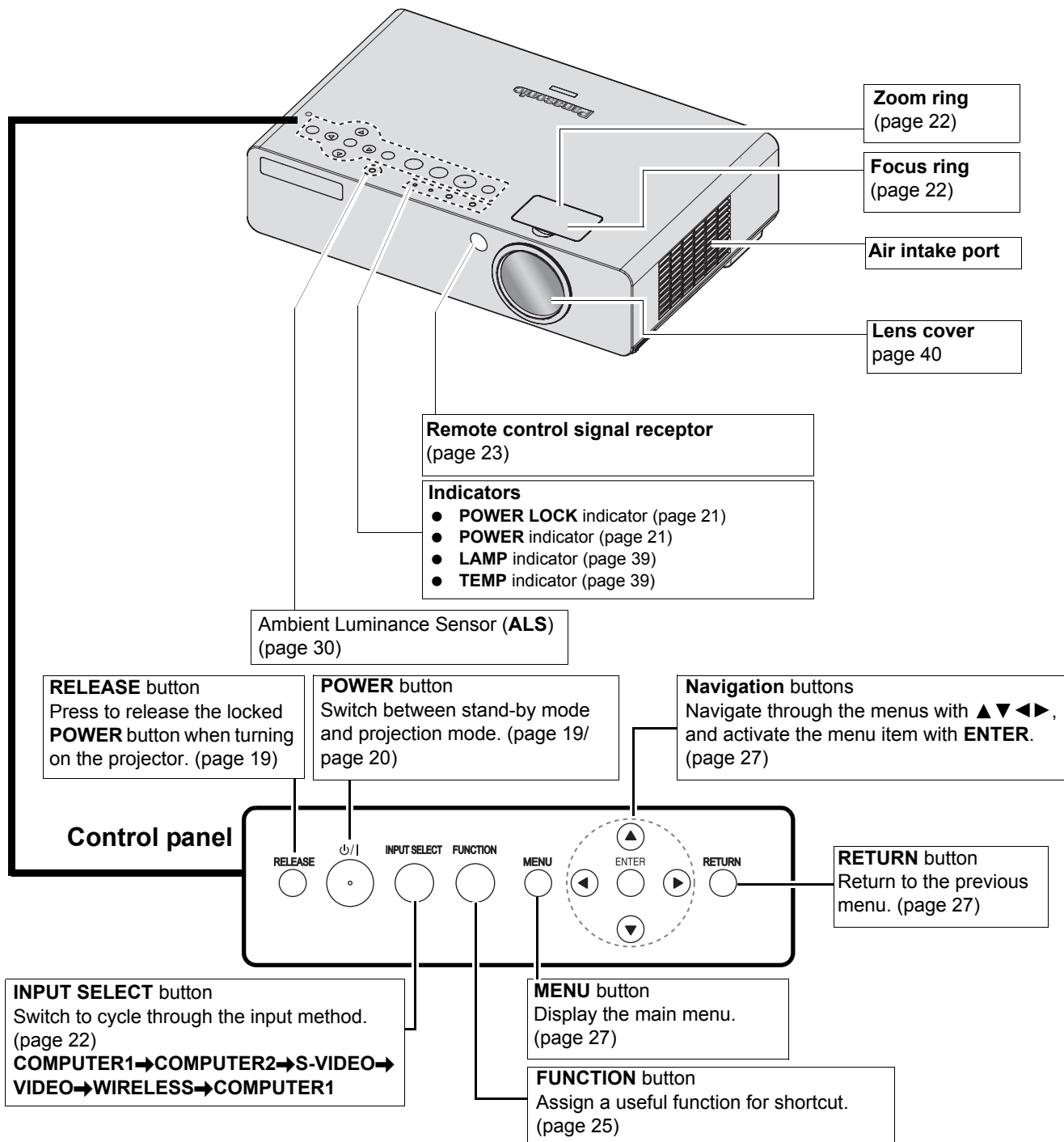
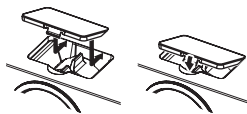

NOTE:

- Do not cover the ventilation openings or place anything within 50 cm (20") of them as this may cause damage or injury.
- While the projector is not in use, keep the lens cover attached to protect the lens.

Back and bottom view

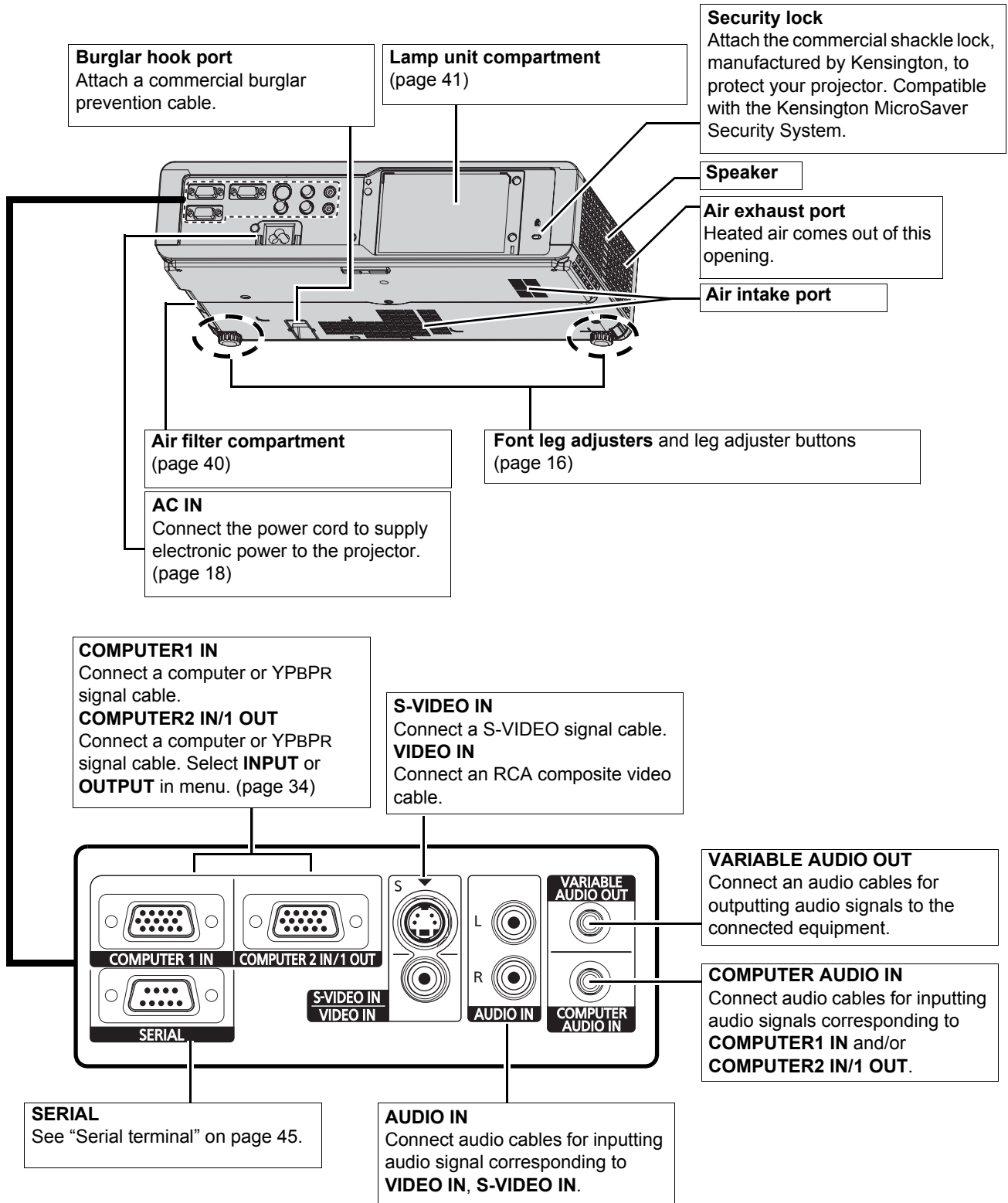

NOTE:

- Do not cover the ventilation openings or place anything within 50 cm (20") of them as this may cause damage or injury.
- When a cable is connected to the **VARIABLE AUDIO OUT**, the built-in speaker will be disabled.

About Your Projector

Remote control

Preparation

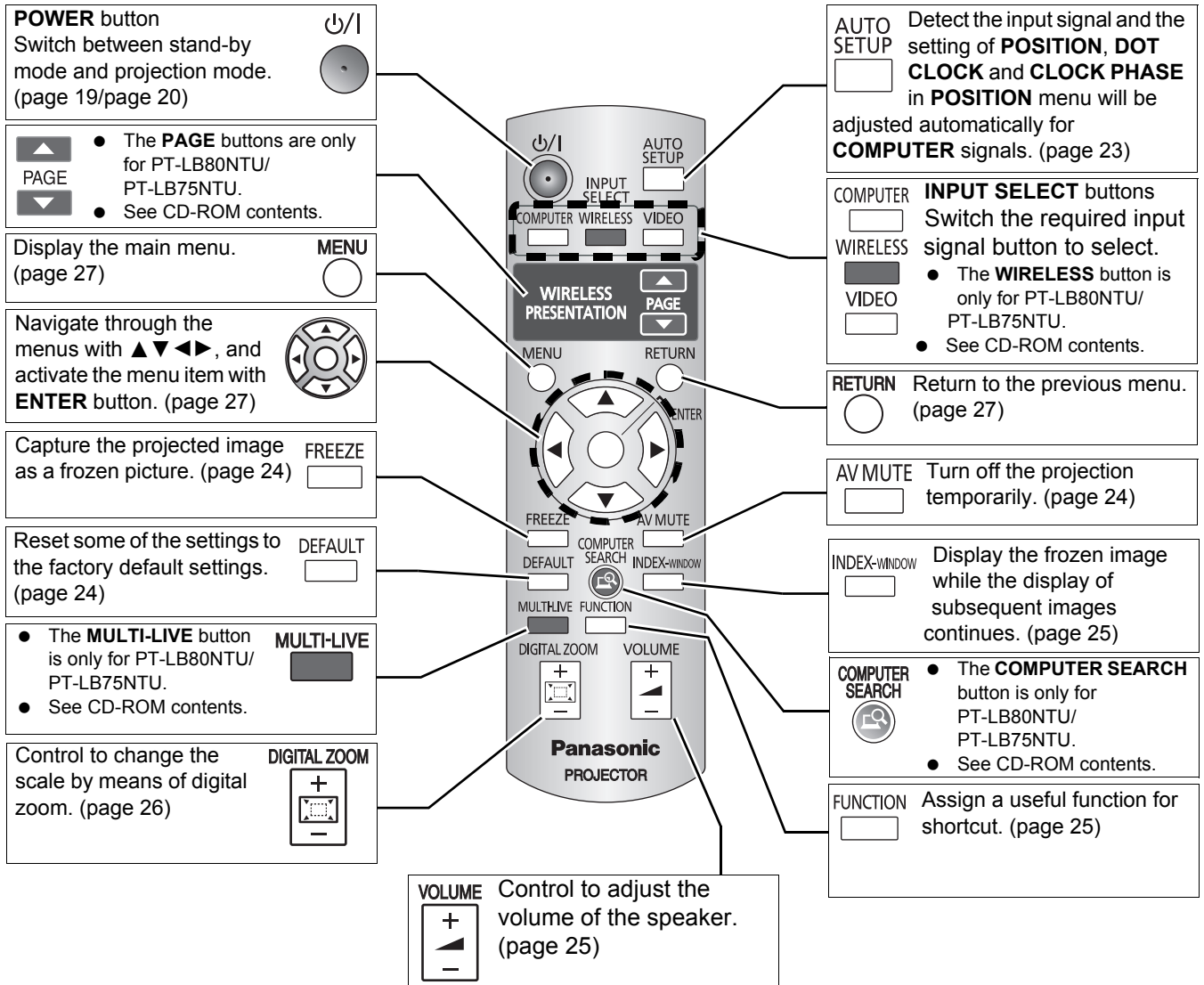

Battery compartment

1. Press the tab and lift up the cover.
2. Insert the batteries according to the polarity diagram indicated inside.



Top view (page 23)

Remote control signal emitters

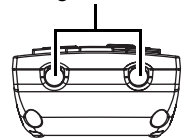

Attaching a hand strap

You can attach a favorite strap on to the remote control.

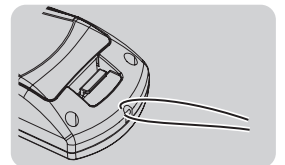

NOTE:

- Do not drop the remote control.
- Avoid contact with liquids or moisture.
- Use manganese batteries or alkaline batteries with the remote control.
- Do not attempt to modify or disassemble the remote control. Contact an Authorized Service Center for repairs.
- Do not keep pressing the remote control buttons as this may shorten battery life.
- See "Remote control operation" on page 23.

Setting up

Screen size and throw distance

You can adjust the projection size with 2.0x zoom lens. Calculate and define the throw distance as follows.

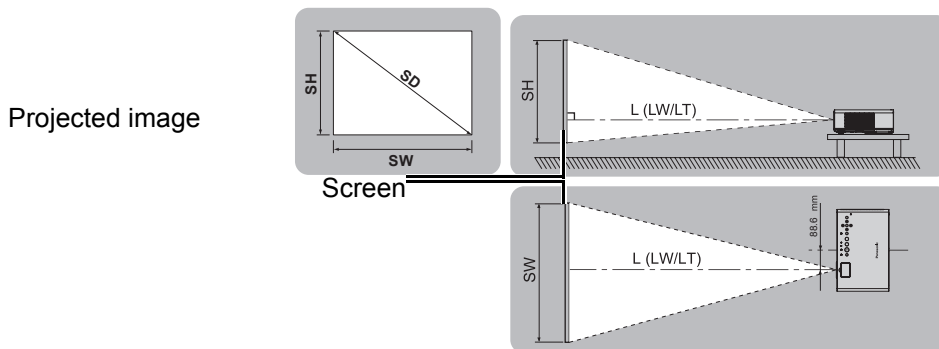

Projection size (4 : 3)	Throw distance (L) PT-LB80NTU / PT-LB80U		Throw distance (L) PT-LB75NTU / PT-LB75U	
	Minimum distance (LW)	Maximum distance (LT)	Minimum distance (LW)	Maximum distance (LT)
33" (0.84 m)		1.1 m (3'7")		1.1 m (3'7")
40" (1.02 m)	1.1 m (3'7")	1.4 m (4'7")	1.1 m (3'7")	1.4 m (4'7")
50" (1.27 m)	1.4 m (4'7")	1.7 m (5'6")	1.4 m (4'7")	1.7 m (5'6")
60" (1.52 m)	1.7 m (5'6")	2.1 m (6'10")	1.7 m (5'6")	2.1 m (6'10")
70" (1.78 m)	2.0 m (6'6")	2.5 m (8'2")	2.0 m (6'6")	2.4 m (7'10")
80" (2.03 m)	2.3 m (7'6")	2.8 m (9'2")	2.3 m (7'6")	2.8 m (9'2")
90" (2.29 m)	2.6 m (8'6")	3.2 m (10'5")	2.6 m (8'6")	3.1 m (10'2")
100" (2.54 m)	2.9 m (9'6")	3.5 m (11'5")	2.9 m (9'6")	3.5 m (11'5")
120" (3.05 m)	3.5 m (11'5")	4.2 m (13'9")	3.5 m (11'5")	4.2 m (13'9")
150" (3.81 m)	4.4 m (14'5")	5.3 m (17'4")	4.3 m (14'1")	5.2 m (17')
200" (5.08 m)	5.9 m (19'4")	7.1 m (23'3")	5.8 m (19')	7.0 m (22'11")
250" (6.35 m)	7.4 m (24'3")	8.9 m (29'2")	7.3 m (23'11")	8.7 m (28'6")
300" (7.62 m)	8.8 m (28'10")	10.7 m (35'1")	8.7 m (28'6")	10.5 m (34'5")

* All measurements above are approximate and may differ slightly from the actual measurements.

Calculation methods for screen dimensions

You can calculate more detailed screen dimension from the screen diagonal.

- Screen width (SW) and screen height (SH)

$$SW (m) = SD (") \times 0.0203$$

$$SH (m) = SD (") \times 0.0152$$

- Minimum distance (LW) and maximum distance (LT)

$$PT-LB80NTU: LW (m) = 0.0296 \times SD (") - 0.039$$

$$LT (m) = 0.0358 \times SD (") - 0.047$$

$$PT-LB75NTU: LW (m) = 0.0292 \times SD (") - 0.036$$

$$LT (m) = 0.0351 \times SD (") - 0.044$$

* The results above are approximate and may differ slightly from the actual measurements.

NOTE:

- See "Screen size and throw distance for 16:9 aspect ratio" on page 47.
- Do not use the projector at a raised or a horizontally tilted position as it may cause malfunction of the projector.
- You can tilt the projector body approximately $\pm 30^\circ$ vertically. Overtilting may result in shortening the component's life.
- For the best quality of the projection image, install a screen where sun light or room light does not shine directly onto the screen. Close window shades or curtains to block the lights.

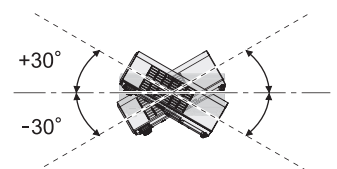

Setting up

Projection method

You can use the projector with any of the following 4 projection methods. To set the desired method in the projector, See "INSTALLATION" on page 35.

■ Setting on a desk/floor and projecting from front

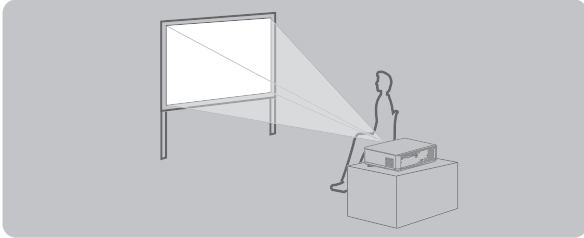

INSTALLATION: FRONT/DESK

■ Setting on a desk/floor and projecting from rear

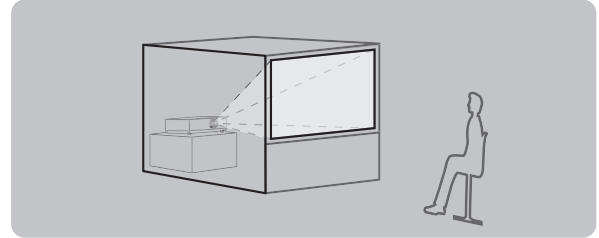

INSTALLATION: REAR/DESK

■ Mounting in the ceiling and projecting from front

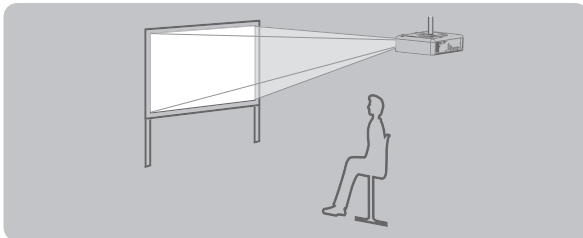

INSTALLATION: FRONT/CEILING

■ Mounting in the ceiling and projecting from rear

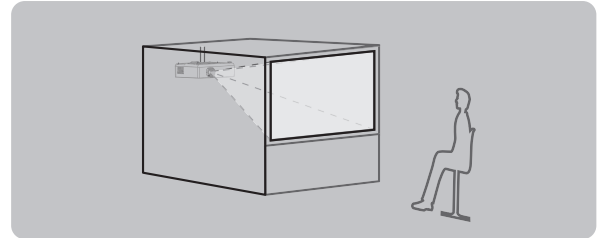

INSTALLATION: REAR/CEILING

NOTE:

- A translucent screen is required for rear projection.
- When mounting the projector in the ceiling, the optional ceiling mount bracket (ET-PKB80) is required.

Front leg adjusters and throwing angle

You can adjust the projection angle in the vertical direction by pressing the leg adjuster buttons. See "Positioning the image" on page 22.

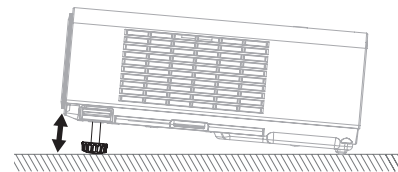
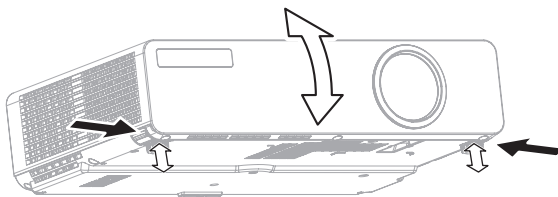

NOTE:

- Heated air comes out of the air exhaust port. Do not touch the air exhaust port directly.
- If keystone distortion occurs, see "KEYSTONE" on page 32.

Connections

Before connection to the projector

- Read and follow the operating and connecting instructions of each peripheral device.
- The peripheral devices must be turned off.
- Prepare the connecting cables that match with the projector and peripheral device terminals.
- If the input signal is affected by signal jitter, the projected image may have poor image quality and timebase correction is effective.
- Confirm the type of video signals. See “List of compatible signals” on page 44.
- When you connect more than one AV equipment, switch the audio connection manually.

Connecting example: AV equipment

Connecting with VIDEO IN/S-VIDEO IN

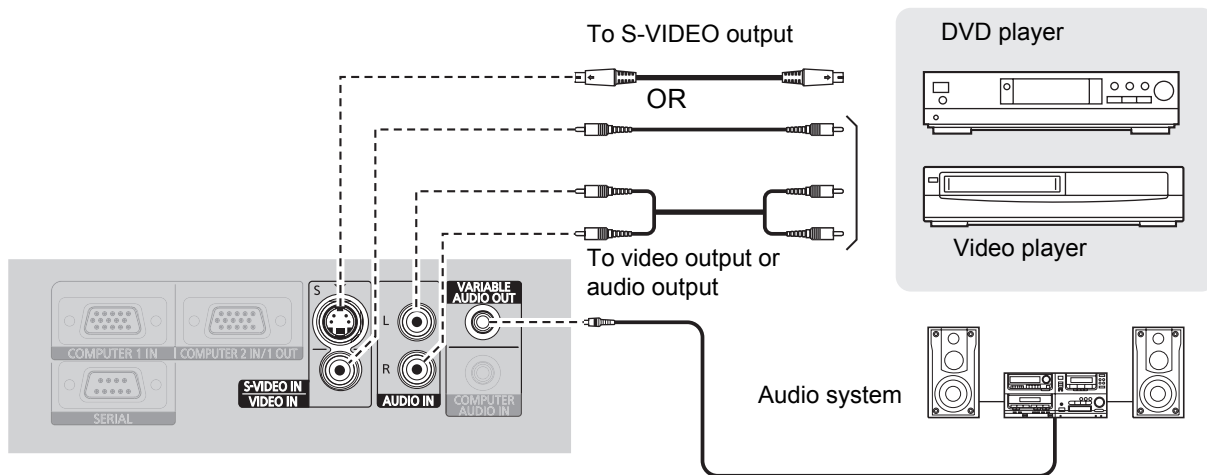

Connecting example: Computers

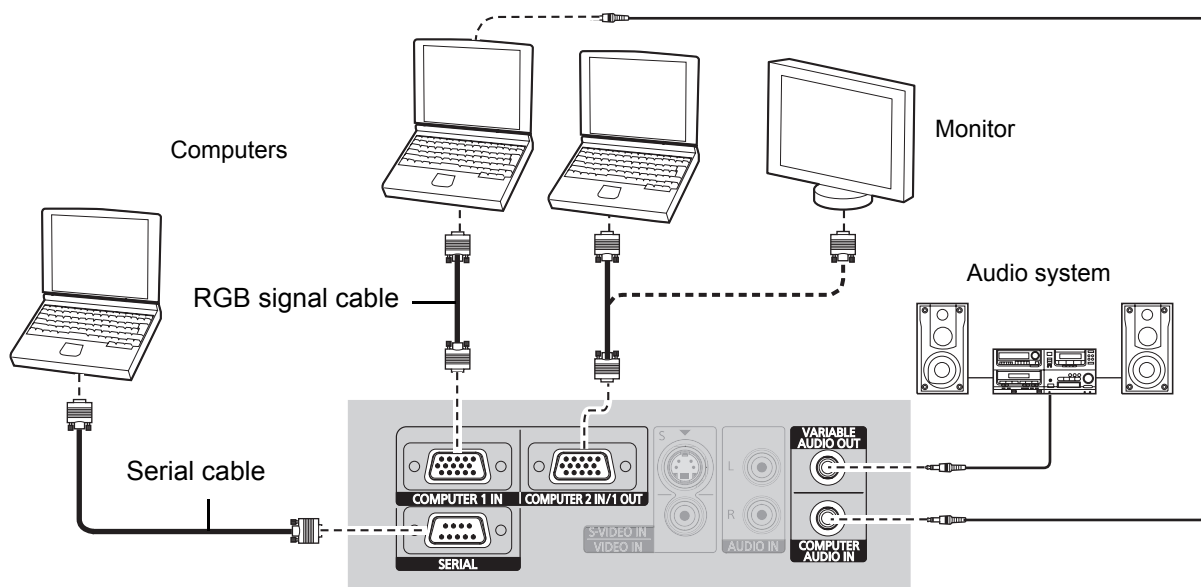

NOTE:

- When **COMPUTER2 SELECT** in the **OPTION** menu is set to **OUTPUT**, do not connect any input signals.
- See CD-ROM contents for the wireless connection. (PT-LB80NTU/PT-LB75NTU only)

Switching the projector on/off

Power cord

Connecting

1. Make sure the shape of the power plug and the **AC IN** terminal on the back of the projector match, then push the plug all the way in.

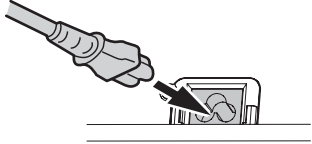

2. Align the side of the power cord secure lock with the side guide rail of the **AC IN** terminal of the projector and slide it in.

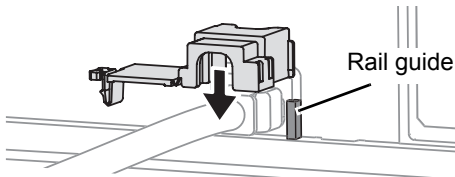

3. Place the latch to the latch catcher and press until it clicks.

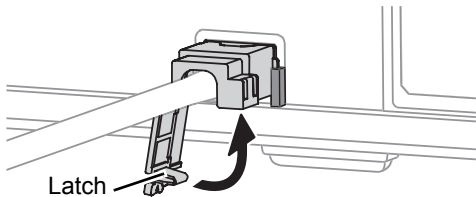

4. Connect the power cord to a wall outlet.
5. The **POWER** and **POWER LOCK** indicators light in red and the projector stays in standby mode.

Direct power on function

If the **DIRECT POWER ON** in **OPTION** menu is set to **ON**, connect the power cord to a wall outlet and the projection will start even when the control panel is disabled or the **POWER** button is locked. See "DIRECT POWER ON" on page 35.

If the **DIRECT POWER ON** is set to **OFF**, the projector will be at the same mode as last unplugged, standby mode or projection mode.

Disconnecting

1. Unplug the power cord from the wall outlet.
2. Depress the latch and slide the cover off.

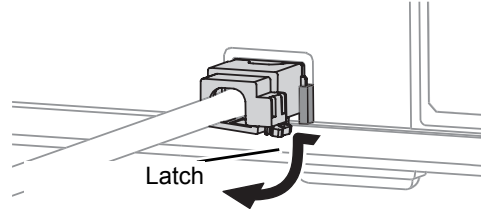

3. Slide the power cord secure lock up along the side guide rail and remove.

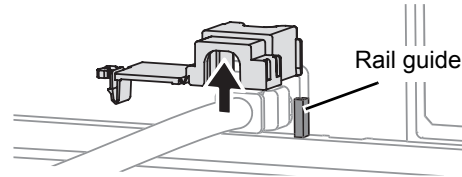

4. Hold the plug and unplug the power cord from the **AC IN** terminal on the back of the projector.
 - **POWER** indicator lights in orange if the internal cooling fan is still operating by internal power supply.

Direct power off function

You can switch off the electric power supply any time by unplugging the power plug from the wall outlet or by switching off the main power. The internal lamp cooling fan keeps operating by the internal power supply, and stops automatically when cooled enough.

NOTE:

- Do not use other than a provided power cord.
- Ensure all the input devices are connected and turned off before connecting the power cord.
- Do not force the connector as this may damage the projector and/or the power cord.
- Dirt or dust build-up around plugs may cause fire or electrical hazards.
- Switch off the power to the projector when not in use.
- If the projector is switched on again while the internal cooling fan is still operating by the internal power supply, it may take a while to start the projection.
- If the projector is switched on again while the internal cooling fan is still operating by the internal power supply, it may take a while to start the projection.
- Do not put the projector into the carrying bag with the **POWER** indicator lit.

Switching on the projector

Before switching on the projector, make sure the power cord and all the other devices are connected correctly. See “Connections” on page 17 and “Power cord” on page 18.

● By control panel operation

Make sure **CONTROL PANEL** in **OPTION** menu is set to **VALID**. The **POWER** button is locked to prevent malfunction and the **POWER LOCK** indicator lights in red.

1. Press the **RELEASE** button.
 - The **POWER LOCK** indicator goes off.
 - Without any operation in 10 seconds, the **POWER** button will be locked again.
2. Press the **POWER** button in 10 seconds.
 - The **POWER** button beeps once.
3. The **POWER** indicator flashes in green several times.
4. The **POWER** indicator lights in green and displays the startup logo for 30 seconds.
 - When the **STARTUP LOGO** in **OPTION** menu is set to **OFF**, the startup logo will not be displayed. See “STARTUP LOGO” on page 34.

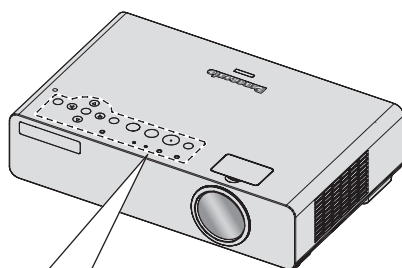

● By remote control operation

1. Press the **POWER** button.
2. The **POWER** indicator flashes in green several times.
3. The **POWER** indicator lights in green and displays the startup logo for 30 seconds.
 - When the **STARTUP LOGO** in **OPTION** menu is set to **OFF**, the startup logo will not be displayed. See “STARTUP LOGO” on page 34.

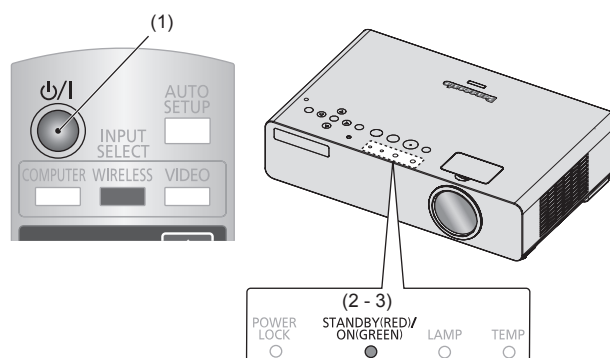

● By direct power on function

You can switch on the projector by connecting the power cord. See “Direct power on function” on page 18.

NOTE:

- When starting up the projector, some small rattling or tinkling sound may be heard, or the display may flicker for the characteristics of the lamp. Those are normal and will not affect the performance of the projector.
- When the internal cooling fan is operating, some, operational sound may be heard. The loudness of the operational sound depends on the external temperature.
- If the projector is switched on again while the internal cooling fan is still operating by the internal power supply, it may take a while to start the projection.
- Operating the control panel buttons with covered hand, such as plastered or gloved, may result in fail.

Switching the projector on/off

Switching off the projector

By control panel operation

Make sure the **CONTROL PANEL** setting in **OPTION** menu is set to **VALID**.

1. Press the **POWER** button.
 - The confirmation screen will be displayed.
 - Without any operation for 10 seconds or press any button other than the **POWER** button, the confirmation screen will go off and return to the projection.
2. Press the **POWER** button again in 10 seconds.
3. The **POWER** indicator will flash in orange.
 - The projector is cooling the lamp.
4. The **POWER** and **POWER LOCK** indicator light red.

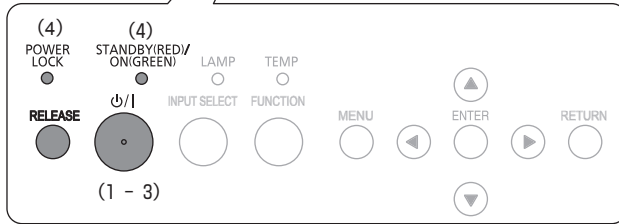
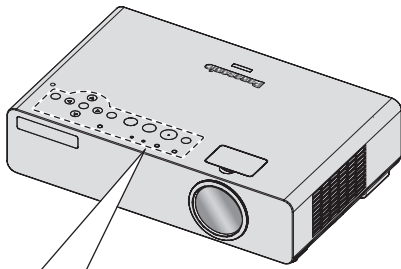

By remote control operation

1. Press the **POWER** button.
 - The confirmation screen will be displayed.
 - Without any operation for 10 seconds or press any button other than the **POWER** button, the confirmation screen will go off and return to the projection.
2. Press the **POWER** button again in 10 seconds.
3. The **POWER** indicator will flash in orange.
 - The projector is cooling the lamp.
4. The **POWER** and **POWER LOCK** indicator light red.

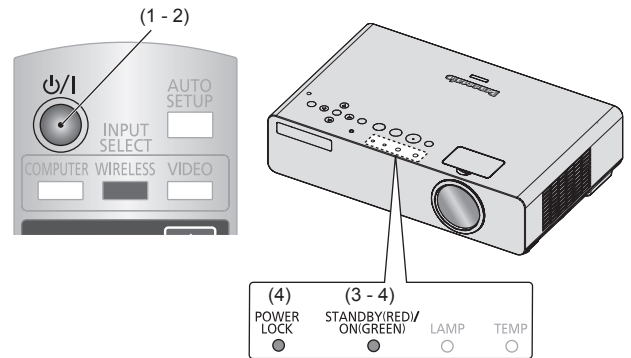

By direct power off function

You can switch off the projector by disconnecting the power cord. See "Direct power off function" on page 18.

NOTE:

- You can switch off the power without displaying the confirmation screen by pressing the **POWER** button for longer than 0.5 second.
- When the internal cooling fan is operating, some, operational sound may be heard. The loudness of the operational sound depends on the external temperature.
- If the projector is switched on again while the internal cooling fan is still operating by the internal power supply, it may take a while to start the projection.
- Operating the control panel buttons with covered hand, such as plastered or gloved hand, may result in fail.

POWER and POWER LOCK indicators

The **POWER** indicator informs you the status of the power and the **POWER LOCK** indicator shows the status of the **RELEASE** button.

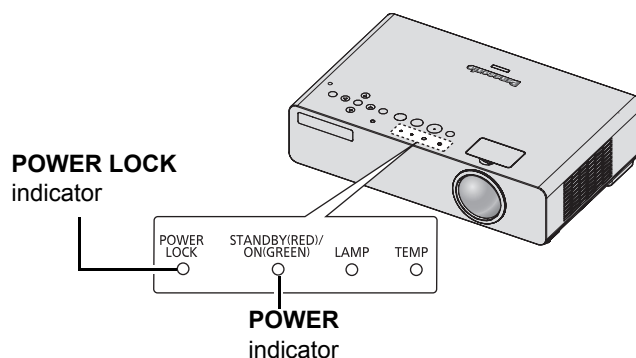

POWER LOCK indicator status

Indicator status		Status
No illumination or flashing		<ul style="list-style-type: none"> No power is supplied. The RELEASE button is pressed and the POWER button is unlocked. The power is on.
Red	Lit	The POWER button is locked.
	Flashing	Pressing the locked POWER button.

POWER indicator status

Indicator status ^{*1}		Status
No illumination or flashing		No power is supplied and the internal cooling fan is not operating.
Red	Lit	The power is supplied and in standby mode ^{*2} , and the POWER button is locked.
	Flashing	Preparing for wireless connection. (PT-LB80NTU/PT-LB75NTU only)
Green	Flashing	The power is on and preparing for projection.
	Lit	Projecting.
Orange	Lit	No power supply and the internal fan is cooling the lamp by internal power supply.
	Flashing	The power is switched on again while cooling the lamp and recovering to the projection mode. Recovery may take a while.

*1. When the **LAMP** or **TEMP** indicator is flashing, the **POWER** indicator will not light.

*2. The electric consumption in standby mode is 4.0 W.

Projecting an image

Selecting the input signal

1. Switch on the connected devices.
 - Press the play button of the required device.
2. Detect the input signal automatically.
3. Switch the aspect ratio automatically.

NOTE:

- If the **SIGNAL SEARCH** in **OPTION** menu is deactivated, select the required input method by pressing the **INPUT SELECT** buttons of the remote control or the **INPUT SELECT** button of the projector several times. See “**SIGNAL SEARCH**” on page 35, “**Switching the input signal**” on page 24 or “**INPUT SELECT** button” on page 12.
- See “**ASPECT**” on page 32.

Positioning the image

1. Place the projector at the right angle from the screen.



2. Adjust the vertical angle of the projector.
 - Press the front leg adjuster buttons and adjust the vertical angle.
 - See “**Front leg adjusters and throwing angle**” on page 16.

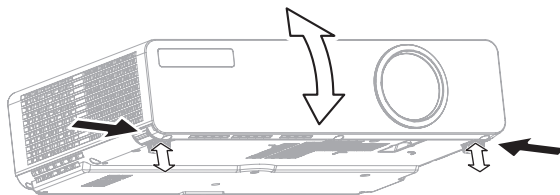

3. Open the Zoom-Focus ring cover.
 - See “**Zoom-Focus ring cover**” on page 12.
4. Turn the zoom and focus rings to adjust the projected image.
 - You can confirm the adjusted effect with the **TEST PATTERN** in **OPTION** menu. See “**TEST PATTERN**” on page 36.

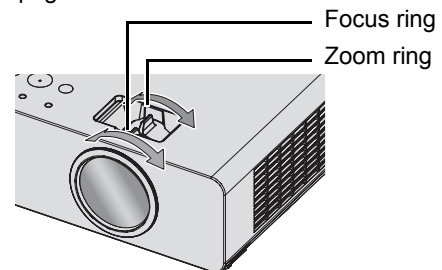

NOTE:

- Do not touch the air exhaust port as this may cause burns or injury.
- If keystone distortion occurs, see “**KEystone**” on page 32.
- If you adjust the focus, you may need to adjust the size of the image by moving the zoom ring again.

Remote control operation

Operating range

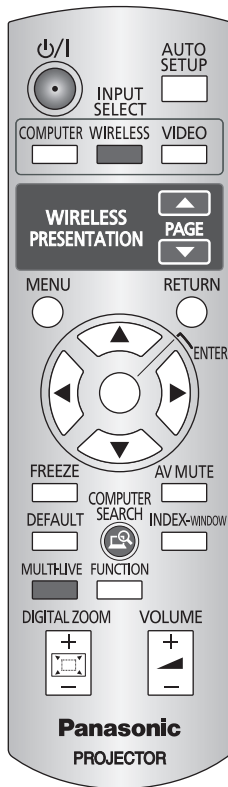

You can operate the projector with the remote control within the remote range 15 m (49'2"), approximately $\pm 30^\circ$ vertically and horizontally.

● Facing to the projector

Make sure the remote control emitter is facing to the remote control signal receptor of the projector when pressing the buttons to operate.

● Facing to the screen

Make sure the remote control emitter is facing to the screen when pressing the buttons to operate the projector. The signal will be reflected off the screen to the projector.

- The operating range may differ due to the screen material, and this function may not be effective with a translucent screen.

NOTE:

- See "About Your Projector" on page 12 to confirm the position of the remote control signal emitter and receptor.
- Do not let strong light shine onto the signal receptor. The remote control may malfunction under strong light such as fluorescent.
- If there are any obstacles between the remote control emitter and the remote control signal receptor, the remote control may not operate correctly.

Setting up the image position automatically

AUTO SETUP If you need to readjust the projected image position while projecting or when **AUTO SETUP** in **OPTION** menu is set to **OFF**, press the **AUTO SETUP** button.

The projector will detect a RGB signal by **SIGNAL SEARCH** system and adjust the setting of **POSITION**, **DOT CLOCK** and **CLOCK PHASE** in **POSITION** menu automatically.

NOTE:

- If **SIGNAL SEARCH** setting in **OPTION** menu is set to **OFF**, select the required signal manually first. See "Switching the input signal" on page 24.
- If the dot clock frequency is 108 MHz or higher, **AUTO SETUP** is not effective.
- If the projected image is too dark or blurred around the edge, **AUTO SETUP** may stop the processing before complete the adjustment and return to the previous setting. Project a much clearer or lighter image and try again.

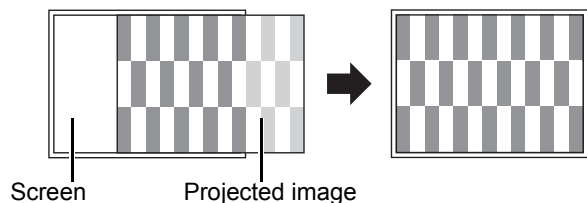

Remote control operation

Switching the input signal

COMPUTER

WIRELESS

VIDEO

You can switch the input method manually by pressing the **COMPUTER**, **WIRELESS** (PT-LB80NTU/PT-LB75NTU only) and **VIDEO** buttons. Press the required button several times or ◀ ▶ to cycle through the input methods as follows.

- You can confirm the selected input method in displayed graphical input guide on the upper right of the screen. Highlighted in yellow is selected terminal. See "INPUT GUIDE" on page 34.

● Pressing the **COMPUTER** button



NOTE:

- Only when the **COMPUTER2 SELECT** is set to **INPUT**, you can switch between **COMPUTER1** and **COMPUTER2**.
- With no signals from **COMPUTER** terminals, the computer connecting guidance will be displayed. See "Computer connection guidance" on page 46.

● Pressing the **WIRELESS** button

- The **WIRELESS** button is only for PT-LB80NTU/PT-LB75NTU.
- See CD-ROM contents for more detailed information.

● Pressing the **VIDEO** button



● Pressing the **INPUT SELECT** button on the projector

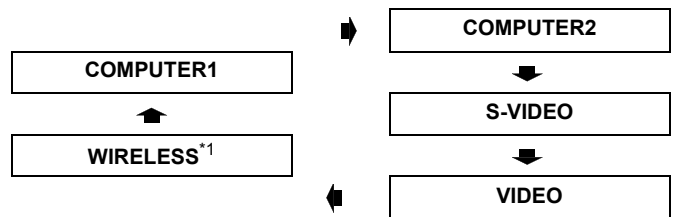

*1. **WIRELESS** is only for PT-LB80NTU/PT-LB75NTU.

NOTE:

- Switched signal may be displayed after a short interval.
- If you select an unplugged input method, the input guidance will blink on and off several times.
- See "List of compatible signals" on page 44.
- See "Connections" on page 17.

Capturing an image

FREEZE

Press the **FREEZE** button to capture the image and you can see it as a still picture. While the image is frozen, the audio sound through the

projector will stop. Press the **FREEZE** button again to escape and return to the continuing image.

Stopping the projection temporary

AV MUTE

You can stop the projection and audio sound through the projector temporarily for saving

electrical power. Press the **AV MUTE** button again to escape.

Resetting to the factory default settings

DEFAULT

You can reset most of the customised settings to the factory defaults by pressing the **DEFAULT** button of the remote control. Display the required sub menu or the menu items and press the **DEFAULT** button again.

- See "Main menu and Sub-menu" on page 28.

NOTE:

- Some menu items are not available to reset by pressing the **DEFAULT** button. Adjust each menu items manually.
- To reset all the settings to the factory defaults, see "INITIALIZE ALL" on page 36.

Projecting an image in INDEX-WINDOW mode

INDEX-WINDOW



You can project an image split in 2 windows as an **INDEX-WINDOW**. One is frozen and stored in memory, and displayed on the screen's left side while displaying subsequent image continues on the right.

Press the **MENU** or **RETURN** button to escape.

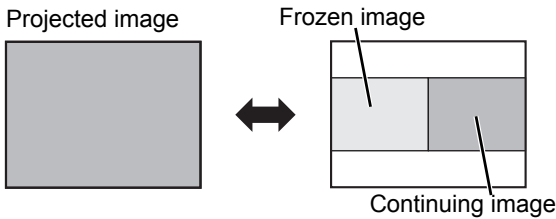

● Switching the position

In default, the frozen image is displayed on the left and the subsequent image is displayed on the right. Press ◀ ▶ to switch the position.

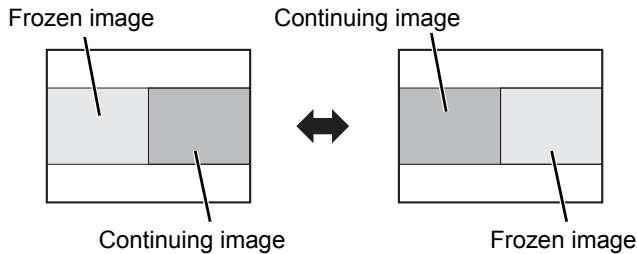

● Changing the image size

Press ▲ ▼ to capture a new image and change the size in 3 ways.

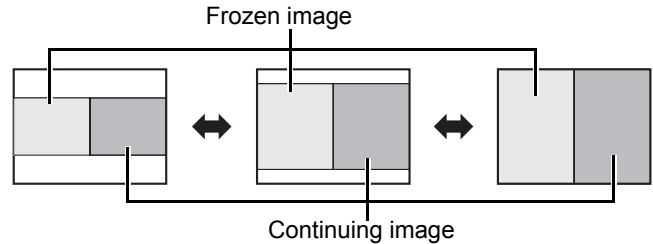

NOTE:

- If you change the window size, the aspect ratio of the image is changed and becomes vertically elongated.

● Capturing a new image

While in **INDEX-WINDOW** mode, press the **ENTER** button to capture a new image and the frozen image window will be updated in a moment.

NOTE:

- When capturing a quick moving picture, perform several times to get a stabled picture.

Using an assigned function

FUNCTION



You can assign a selected function to the **FUNCTION** button.

Following functions are assignable. See "FUNCTION BUTTON" on page 36 for assigning procedure.

AV MUTE	See "Stopping the projection temporary" on page 24.
FREEZE	See "Capturing an image" on page 24.
AUTO SETUP	See "Setting up the image position automatically" on page 23.
INDEX-WINDOW	See "Projecting an image in INDEX-WINDOW mode" on page 25.
ASPECT	See "ASPECT" on page 32.
PICTURE MODE	See "PICTURE MODE" on page 30.
CLOSED CAPTION SETTING	See "CLOSED CAPTION SETTING" on page 36.

Controlling the volume of the speaker

VOLUME



You can control the volume of the built-in speakers and output audio sound. Press "+" side of the **VOLUME** button to increase and "-" to decrease.

Enlarging the centered area

DIGITAL ZOOM



You can enlarge the projected image down to a centered area for emphasizing within the range of 1x to 2x.

● Enlarging the image

1. Press any side of the **DIGITAL ZOOM +/-** button once.
 - The centered area of the image will then be enlarged

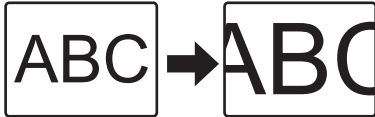

2. Adjust the image size by pressing the **DIGITAL ZOOM +/-** button.
 - Changes the size of the image in steps of 0.1.



● Shifting the center point

Press ▲ ▼ ◀ ▶ to shift the center point.

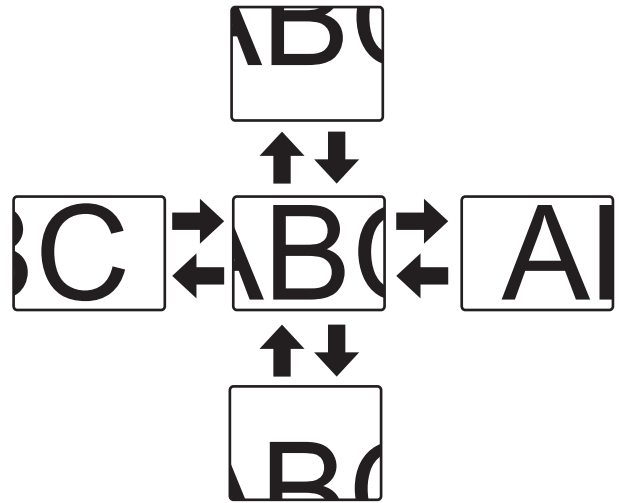

NOTE:

- When the **COMPUTER** signal is projected, the enlargement range will be changed to 1x to 3x. When the **FRAME LOCK** in **POSITION** menu is set to **ON**, the enlargement range is 1x to 2x. See "FRAME LOCK" on page 33.
- When the input signal is changed while the **DIGITAL ZOOM** is activated, the **DIGITAL ZOOM** will be cancelled.
- While the **DIGITAL ZOOM** is activated, the **AUTO SETUP**, **FREEZE**, **DEFAULT**, **INDEX-WINDOW** and **FUNCTION** (except when **AV MUTE** is assigned) buttons are not available.

Menu Navigation

The menu system allows you to access functions which do not have their own dedicated buttons on the remote control. The menu options are structured and categorised. You can navigate through the menu with ▲ ▼ ► ◀ buttons.

Navigating through the MENU

■ Displaying the main menu

MENU Press the **MENU** button to display the main menu and the operating guidance.

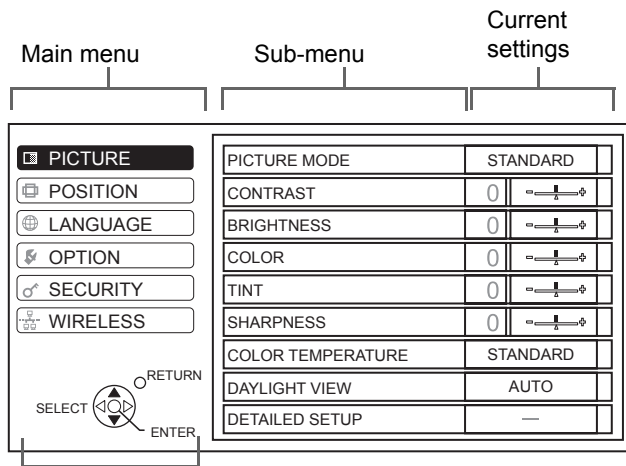

Operating guidance

Contains the required buttons to adjust the settings.

■ Adjusting with the bar scale items

The triangle mark under the bar indicates factory default setting and the square indicates the current setting.

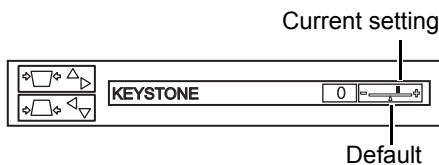

■ Returning to the previous menu

RETURN Press the **MENU** or **RETURN** button to return to the previous menu. Press repeatedly to escape from the menu mode and return to the projection.



■ Operating procedure

- Press ▲ ▼ to scroll to the required main menu item and press the **ENTER** button to select.
 - The selected item is highlighted in orange and displays the sub-menu on the right.
 - See “Main menu and Sub-menu” on page 28.

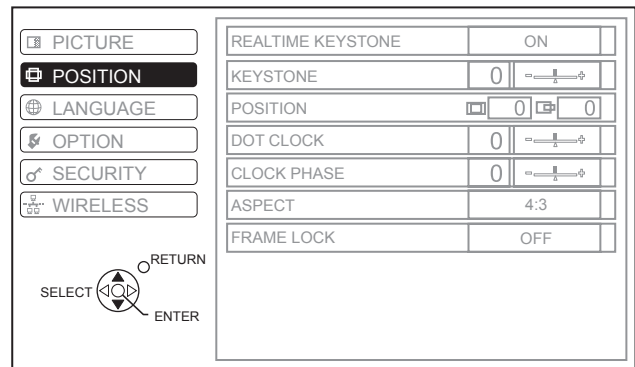

- Press ▲ ▼ to scroll to the required sub-menu item and press ◀ ► or the **ENTER** button to adjust.
 - The selected item is called up and the other menu items disappear from the screen. Called up item will be disappear after 5 seconds without any operation and return to the menu mode.
 - If there is a lower level, the next level will be displayed.

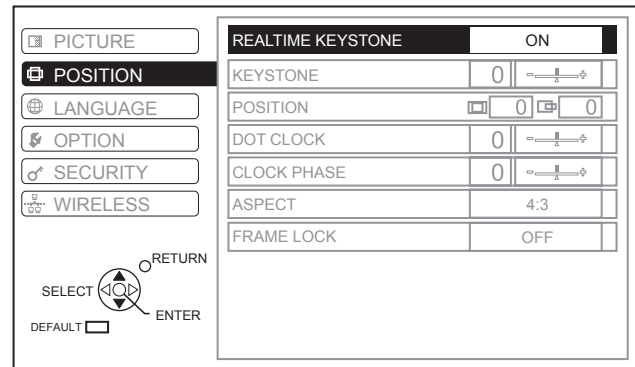

- Press ◀ ► to adjust the bar scale or select the required option.
 - For items indicated in bar scale type, the current settings are displayed on the left of the bar.
 - You can cycle through the options of an item by pressing ◀ ►.

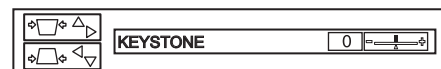

- Press **MENU** or **RETURN** button to return to the previous menu.

NOTE:

- See “Resetting to the factory default settings” on page 24 to reset each menu items.
- See “INITIALIZE ALL” on page 36 to reset all the settings.

Menu Navigation

Main menu and Sub-menu

The main menu has 6 options. Select the required menu item and press **ENTER** to display the sub-menu. Underlined items are factory default settings.

NOTE:

- Some default settings vary by the selected input signal.
- sub-menu items vary according to the selected input signal.
- Some settings are adjustable without any signals.

PICTURE

PICTURE MODE	page 30
<u>NATURAL DYNAMIC</u>	STANDARD BLACKBOARD
CONTRAST (Default: 0)	page 30
BRIGHTNESS	page 30
COLOR (Signals from S-VIDEO/VIDEO only) (Default: 0)	page 30
TINT (Signals from S-VIDEO/VIDEO only) (Default: 0)	page 30
SHARPNESS (Default: 0)	page 30
COLOR TEMPERATURE	page 30
<u>STANDARD</u>	HIGH
DAYLIGHT VIEW	page 30
<u>AUTO</u>	ON
DETAILED SETUP (Not available with wireless connection)	page 31
TV-SYSTEM	
<u>AUTO</u>	NTSC 4.43
NTSC	PAL-M
PAL	SECAM
PAL-N	
STILL MODE	
<u>ON</u>	OFF
NOISE REDUCTION	
<u>ON</u>	OFF
WHITE BALANCE RED (Default: 0)	
WHITE BALANCE GREEN (Default: 0)	
WHITE BALANCE BLUE (Default: 0)	

POSITION

REALTIME KEYSTONE	page 32
<u>ON</u>	OFF
KEYSTONE (Not available with wireless connection) (Default: 0)	page 32
POSITION (Not available with wireless connection) H (Default: 0) V (Default: 0)	page 32
DOT CLOCK (Signals from COMPUTER only) (Default: 0)	page 32
CLOCK PHASE (Signals from COMPUTER only) (Default: 0)	page 32
ASPECT	page 32
(Vary according to the selected input signal)	
<u>AUTO</u>	16:9
4:3	THROUGH
S4:3	
FRAME LOCK (Signals from COMPUTER only)	page 33
<u>OFF</u>	ON

LANGUAGE

	1/2
DEUTSCH	
FRANÇAIS	
ESPAÑOL	
ITALIANO	
PORTUGUÊS	
SVENSKA	
NORSK	
DANSK	
▼	
	2/2
POLSKI	
ČEŠTINA	
MAGYAR	
РУССКИЙ	
ไทย	
한국어	
● ENGLISH	
中文	
日本語	

 **OPTION**

INPUT GUIDE		page 34
<u>DETAILED</u>	SIMPLE	
OFF		
STARTUP LOGO		page 34
ON	OFF	
USER		
COMPUTER2 SELECT		page 34
<u>INPUT</u>	OUTPUT	
RGB/YP_BPR		page 34
<u>AUTO</u>		
RGB	YPBPR	
WIDE MODE		page 34
<u>OFF</u>		
ON		
LAMP POWER		page 35
<u>STANDARD</u>	ECO-MODE	
LAMP RUNTIME		page 35
POWER OFF TIMER		page 35
<u>DISABLE</u>		
15 MIN.	20 MIN.	
25 MIN.	30 MIN.	
35 MIN.	40 MIN.	
45 MIN.	50 MIN.	
55 MIN.	60 MIN.	
DIRECT POWER ON		page 35
<u>OFF</u>	ON	
CONTROL PANEL		page 35
<u>VALID</u>	INVALID	
AUTO SETUP		page 35
<u>AUTO</u>	BUTTON	
SIGNAL SEARCH		page 35
<u>ON</u>	OFF	
INSTALLATION		page 35
<u>FRONT/DESK</u>	FRONT/CEILING	
REAR/DESK	REAR/CEILING	
ALTITUDE		page 35
<u>LOW</u>	HIGH	
CLOSED CAPTION SETTING		page 36
CLOSED CAPTION		
<u>OFF</u>	ON	
MODE		
CC1	CC2	
CC3	CC4	
FUNCTION BUTTON		page 36
<u>AV MUTE</u>	FREEZE	
AUTO SETUP	INDEX-WINDOW	
ASPECT	PICTURE MODE	
TEST PATTERN		page 36

DETAILED SETUP page 36

OSD DESIGN	
<u>TYPE1</u>	TYPE2
TYPE3	
SXGA MODE	
<u>SXGA</u>	SXGA+
BLACKBOARD	
<u>ON</u>	OFF
BACK COLOR	
<u>BLUE</u>	BLACK
VOLUME (Default: 20)	
AUDIO BALANCE (Default: 0)	
INITIALIZE ALL	

 **SECURITY**

INPUT PASSWORD		page 37
<u>OFF</u>	ON	
PASSWORD CHANGE		page 37
TEXT DISPLAY		page 37
<u>OFF</u>	ON	
TEXT CHANGE		page 37

 **WIRELESS**

(PT-LB80NTU/PT-LB75NTU only)

NETWORK
NAME CHANGE
INPUT PASSWORD
PASSWORD CHANGE
NETWORK STANDBY
WEB CONTROL
LIVE MODE CUT IN
STATUS
INITIALIZE

page 38*1

*1. See CD-ROM contents for more detailed information.

PICTURE menu

Remote control

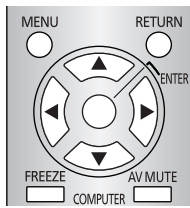

Control panel

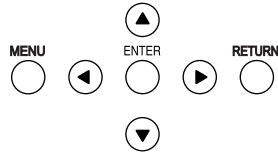

- See “Navigating through the MENU” on page 27.
- See “Main menu and Sub-menu” on page 28.

PICTURE MODE

Depending on the projection environment, you can use these preset parameter settings to optimise image projection. Press ◀ ▶ to cycle through the options.

NATURAL	Reproduces the original color of the image
STANDARD	Setting for a general image
DYNAMIC	Bright and sharp setting
BLACKBOARD	Setting for when projecting on a blackboard See “BLACKBOARD” on page 36.

NOTE:

- It may take for a while until the selected mode is stabilised.

CONTRAST

You can adjust the contrast of the projected image. Adjust the **BRIGHTNESS** in advance if necessary.

Lower



Higher

BRIGHTNESS

You can adjust the brightness of the projected image.

Darker



Brighter

COLOR

You can adjust the color saturation of the projected image. (Available with signals of VIDEO/S-VIDEO/YPBPR only)

Lighter



Darker

TINT

You can adjust the skin tone in the projected image. (Available with signals of VIDEO/S-VIDEO/YPBPR only)

More reddish



More greenish

SHARPNESS

You can adjust the sharpness of the projected image and the adjustable range depends on the input signal.

Less sharp



More sharp

COLOR TEMPERATURE

You can adjust the white balance of the projected image. Press ◀ ▶ to cycle through the options.

- **STANDARD** Balanced white
- **HIGH** More bluish
- **LOW** More reddish

DAYLIGHT VIEW

You can keep the projected image bright and vivid even in well-lit rooms where the ambient light sources cannot be controlled, such as when a door opens or when window coverings fail to block out sunlight.

- **AUTO:** Automatic adjustment
- **ON:** Active
- **OFF:** Deactive

NOTE:

- Do not cover the Ambient Luminance Sensor (ALS) of the projector. See “Ambient Luminance Sensor (ALS)” on page 12.
- **AUTO** is not available when **INSTALLATION** setting in **OPTION** menu is set to **REAR/DESK** or **REAR/CEILING**.

DETAILED SETUP

You can perform more detailed image adjustment manually.

For S-VIDEO/VIDEO signals

TV-SYSTEM

When the video signal is changed, the setting switches automatically. You can switch the setting manually to match the video data. Press ◀ ▶ to cycle through the options.

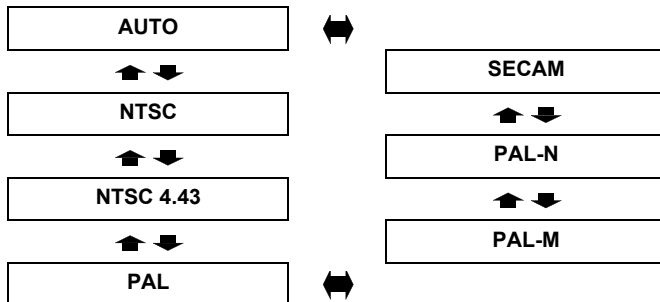

NOTE:

- **AUTO** setting will select from NTSC/NTSC 4.43/PAL/PAL60/PAL-M/PAL-N/SECAM.

STILL MODE

You can reduce the vertical flicker when projecting a still image.

- **ON:** Active
- **OFF:** Deactive

NOTE:

- Set to **OFF** when projecting a moving image.

NOISE REDUCTION

You can switch the automatic noise reduction system on/off. Press ◀ ▶ to select the required setting.

- **ON:** Automatic noise reduction
- **OFF:** No noise reduction

NOTE:

- Applying noise reduction may affect the image quality.

For RGB signals

You can adjust the white balance more properly in 3 colors temperature by pressing ◀ ▶.

- **WHITE BALANCE RED**
- **WHITE BALANCE GREEN**
- **WHITE BALANCE BLUE**

POSITION menu

Remote control

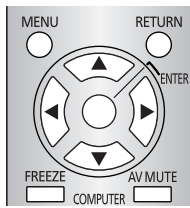

Control panel

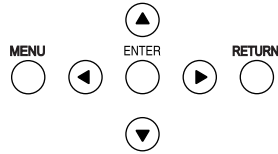

- See "Navigating through the MENU" on page 27.
- See "Main menu and Sub-menu" on page 28.

REALTIME KEYSTONE

If the projector is aligned non-perpendicularly to the screen, or if the projection screen has an angled surface, the keystone will be corrected automatically. Press ◀ ▶ to select the required setting.

- **ON:** Active
- **OFF:** Deactive

KEYSTONE

If you need to correct the angle of the projection even when the **REALTIME KEYSTONE** is activated, you can correct the keystone manually.

Image	Operation

NOTE:

- You can correct the distortion ± 30 degrees from the plane. For a better quality image, installing the projector with a minimum of distortion is recommended.
- The distortion of the Main menu screen is not correctable.
- The result of the keystone correction will affect the aspect ratio and the size of the image.

POSITION

You can move the projected image for fine adjustment. Press ◀ ▶ to move horizontally and ▲ ▼ vertically. (Available with signals of **VIDEO/S-VIDEO/RGB/YPbPr** only)

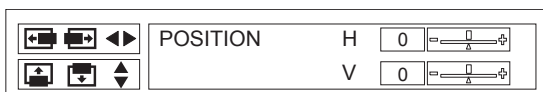

DOT CLOCK

If you have interference patterns of the projected image, which is sometimes referred to as moire or noise, you can minimize it by pressing ◀ ▶ to adjust the clock frequency. (Available with signals of **RGB** only)

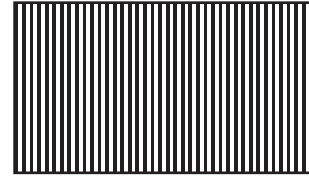

NOTE:

- If the projecting signal's dot clock frequency is higher than 108 MHz, the adjustment may not make a difference.
- **DOT CLOCK** needs to be adjusted before adjust the **CLOCK PHASE**.

CLOCK PHASE

If you require further adjustment for the same reason as the **DOT CLOCK** adjustment, you can fine adjust the timing of the clock. Press ◀ ▶ to adjust. (Available with signals of **RGB/YPbPr** only)

NOTE:

- If the projecting signal's dot clock frequency is higher than 108 MHz, the adjustment may not make a difference. See "List of compatible signals" on page 44.

ASPECT

You can switch the aspect ratio manually when needed. Press ◀ ▶ to cycle through the options.

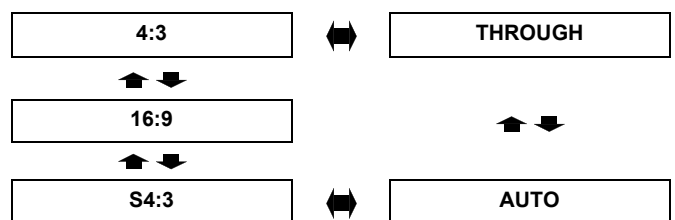

- Selectable options vary according to a input signal.

● 4:3

The input signal will be projected in 4:3 ratio.

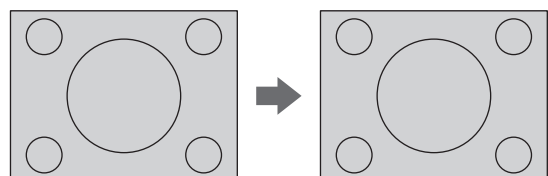

● **16:9**

The squeezed signal will be projected in 16:9 ratio.

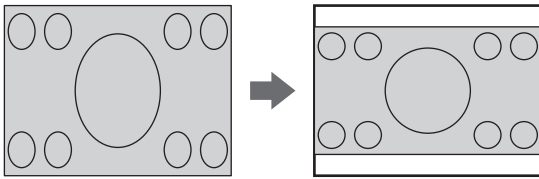

● **S4:3**

The input signal will be sized down 75 % and projected. **S4:3** mode is effective when projecting 4:3 image on to a 16:9 screen.

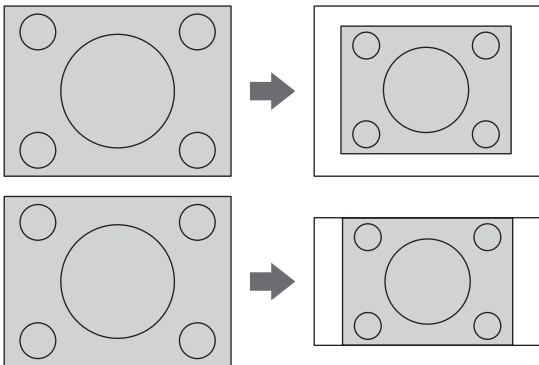

● **THROUGH**

The image will be projected without any size adjustment.

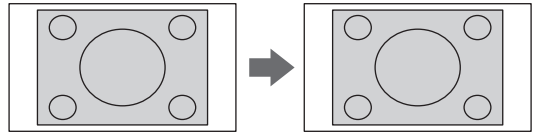

● **AUTO**

The signal which contains an identifying signal will be detected and automatically project the image in proper ratio.

NOTE:

- **WIDE MODE** in **OPTION** menu should be **ON** when projecting WIDE signals.
- If you project an image with an unmatched aspect ratio, the image may distort or some portions may be cropped. Select an aspect ratio which preserves the intention of the image creator.
- The order of **ASPECT** types is defined not only by the input method but also by the input signals. See "List of compatible signals" on page 44.
- If you project a copyrighted image enlarged or distorted by using **ASPECT** function in commercial use in a public place, such as a restaurant or hotel, you might infringe on the copyright of the creator which is protected by copyright law.

FRAME LOCK

If the projected image is degraded, you can activate **FRAME LOCK** for synchronisation. Press ◀ ▶ to select the required option. (Available with signals of **RGB** only)

- **OFF** Deactive
- **ON** Active

OPTION menu

Remote control

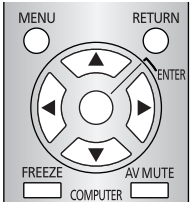

- See "Navigating through the MENU" on page 27.
- See "Main menu and Sub-menu" on page 28.

Control panel

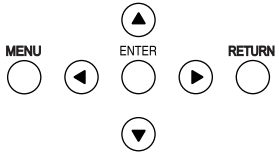

INPUT GUIDE

When you change the input method, the guidance appears in the upper right corner of the screen. The following display methods are available. Press ◀ ▶ to cycle through the options.

Options	Function
DETAILED	Display the input method by graphic. The INPUT GUIDE will go out after 10 seconds without any operation. If you select any of the COMPUTER terminals which has no signal, the computer connection guidance will be displayed. See "Computer connection guidance" on page 46.
SIMPLE	Display the input method by text. The INPUT GUIDE will go out after 5 seconds without any operation.
OFF	Turn off the guidance.

STARTUP LOGO

You can switch the logo on/off that is displayed when starting up the projector. Press ◀ ▶ to select the required option. **STARTUP LOGO** will be displayed for 30 seconds.

- **ON** Active
- **USER** Display the original text
- **OFF** Deactive

● Editing the original text

If you select **USER**, you can display a 2 lines of original text which contains up to 40 characters in each.

TEXT CHANGE

A	B	C	D	E	F	G	H	I	J	K	L	M	ALL DELETE			
N	O	P	Q	R	S	T	U	V	W	X	Y	Z				
a	b	c	d	e	f	g	h	i	j	k	l	m				
n	o	p	q	r	s	t	u	v	w	x	y	z				
0	1	2	3	4	5	6	7	8	9	SPACE						
!	"	#	\$	%	&	'	*	+	-	/	=	?	@	\	^	
_	`		~	()	<	>	[]	{	}	,	.	:	;	

OK
CANCEL

1. Select **USER** and press the **ENTER** button.
2. Select the required line to enter or edit the original text, and press the **ENTER** button.
3. Use ▲ ▼ ◀ ▶ to specify the location of the required character and press the **ENTER** button.
 - The selected character will be displayed in the box.
4. Repeat the step 3 until you finish the text to display in a line.
 - To delete all the entered characters, move the cursor to **ALL DELETE** and press the **ENTER** button.
 - To insert a character in the entered text line, move the cursor to the text box to select the required place, and press ▼ and return to the character field.
 - To delete a character, press the **DEFAULT** button or move the cursor to the required character then press the **DEFAULT** button.
5. Select **OK** and press the **ENTER** button to set the entered text in a box.
 - Press ▼ and edit the **TEXT2** if you need to, and repeat the step 3 - 5.
 - Select **CANCEL** or press the **MENU/RETURN** button to return to the previous menu without setting.

COMPUTER2 SELECT

You can switch the function of the **COMPUTER2 IN/1 OUT** terminal.

- **INPUT**
- **COMPUTER2 IN**
- **OUTPUT**
- **COMPUTER1 OUT**

RGB/YPBPR

The projector will detect the signal from the **COMPUTER1 IN** or **COMPUTER2 IN/1 OUT** terminal if the signal is RGB or YPBPR. You can turn off the automatic system and switch the settings manually.

- **AUTO** Automatic adjustment
- **RGB** For RGB signals
- **YPBPR** For YPBPR signals

NOTE:

- Available with 480i, 576i, 480p, 576p, 1 125 (1 080)/60i, 1 125 (1 080)/50i, only.
- When the input signal is not selected correctly with **AUTO** setting, select **RGB** or **YPBPR** manually.

WIDE MODE

When projecting WIDE signals, switch to **ON** to display the image in well adjusted size.

- **OFF** For 4:3 signals
- **ON** For WIDE signals (16:9, 16:10 and 15:9)

LAMP POWER

You can adjust the power of the lamp to save electricity, prolong the lamp life and reduce the noise.

- **STANDARD** When higher luminance is required
- **ECO-MODE** When lower luminance is sufficient

NOTE:

- When no input signal is detected, the function is disabled.
- The **ECO-MODE** setting is recommended when higher luminance is not required such as in a small room.

LAMP RUNTIME

You can check how long the lamp has been used.

NOTE:

- **LAMP RUNTIME** is a relevant matter for lamp replacement timing. See “Replacing the Lamp unit” on page 41.
- When the lamp unit is replaced with the new unit, the setting need to be reset to “0”.

POWER OFF TIMER

You can set the off timer to switch off the power of the projector after a certain period of time automatically when no signal is detected. Press ◀▶ to select the required period from 15 to 60 minutes at intervals of 5 minutes.

DIRECT POWER ON

You can switch the projector start up status for when the electric power is supplied. Press ◀▶ to select the required option.

- **OFF** Starts in the same mode as last use.
- **ON** Skips the standby mode and starts the projection.

NOTE:

- If the projector is started from the projecting mode, the **POWER** button pressing procedure is skippable.

CONTROL PANEL

You can turn off the function of the control panel buttons on the projector body. Press ◀▶ to select the required option.

- **VALID** Validate the control panel buttons
- **INVALID** Invalidate the control panel buttons
The confirmation screen will be displayed.

AUTO SETUP

You can turn off the automatic **AUTO SETUP** adjustment system.

- **AUTO** When the projector detect a **COMPUTER** signal, automatically set the setting of **POSITION**, **DOT CLOCK** and **CLOCK PHASE** in **POSITION** menu.
- **BUTTON** Only when the **AUTO SETUP** button is pressed, automatically set the **POSITION**, **DOT CLOCK** and **CLOCK PHASE** in **POSITION** menu for **COMPUTER** signals. See “Remote control” on page 14.

NOTE:

- **AUTO** setting is recommended.

SIGNAL SEARCH

You can turn off the auto signal detecting system.

- **ON** Detect the input signal from the terminals and project the image.
- **OFF** Deactive

NOTE:

- **SIGNAL SEARCH** is not available when any input signal is projected.

INSTALLATION

When installing the projector, select the projection method according to the projector position. Press ◀▶ to cycle through the options. See “Projection method” on page 16.

FRONT/DESK	Setting on a desk/floor and projecting from front
FRONT/CEILING	Mounting in the ceiling and projecting from front
REAR/DESK	Setting on a desk/floor and projecting from rear
REAR/CEILING	Mounting in the ceiling and projecting from rear

ALTITUDE

If you use the projector at high elevation, the **ALTITUDE** setting need to be **HIGH** to set the fan speed high. Press ◀▶ to select the required option.

- **LOW** The fan speed is low.
- **HIGH** The fan speed is high.

NOTE:

- At 1 400 -2 700 m (4 593 - 8 858 ft) sea level, the setting must be **HIGH**.
- The loudness of fan noise depends on the **ALTITUDE** setting.

OPTION menu

CLOSED CAPTION SETTING

If the input signal contains closed captions, you can turn on the feature and switch the channels.

CLOSED CAPTION

- OFF Deactive
- ON Active

MODE

- CC1 - 4 Change the channels CC1 - 4

NOTE:

- VCR with TBC (Time Base Corrector) function is recommended for video cassette tapes.

FUNCTION BUTTON

You can select a useful function from the list and assign to the **FUNCTION** button for shortcut.

1. Press the **ENTER** button.
2. Press **▲ ▼** to select the required function.
3. Press the **ENTER** button.
 - The dot on the left of the option is indicating the assigned function.

Option items	Refer
AV MUTE	page 24
FREEZE	page 24
AUTO SETUP	page 23
INDEX-WINDOW	page 25
ASPECT <ul style="list-style-type: none"> • Press the FUNCTION button to display the ASPECT in POSITION menu. 	page 32
PICTURE MODE <ul style="list-style-type: none"> • Press the FUNCTION to display the PICTURE MODE in PICTURE menu. 	page 30
CLOSED CAPTION SETTING	page 36

TEST PATTERN

You can use the 7 different test patterns to adjust the focus of the image. See "Positioning the image" on page 22.

1. Press the **ENTER** button to display the test pattern 1.
2. Press **◀ ▶** to select the required test pattern.
3. Press the **MENU** or **RETURN** button to return to the previous menu, or press repeatedly to escape the menu mode.

DETAILED SETUP

You can perform more detailed setting in various items.

OSD DESIGN

You can change the background color of the menu. Press **◀ ▶** to select the required option.

TYPE1	Semi transparent black
TYPE2	Solid blue
TYPE3	Semi transparent dark blue

SXGA MODE

When an SXGA signal image is cropped, you can switch the setting between **SXGA** and the larger setting, **SXGA+**. Press **◀ ▶** to select the required option.

BLACKBOARD

You can exclude the **BLACKBOARD** in menu items of **PICTURE MODE** in **PICTURE** menu.

Press **◀ ▶** to select the required option.

- ON Include the **BLACKBOARD** in menu items.
- OFF Exclude the **BLACKBOARD** in menu items.

BACK COLOR

You can choose a **BLUE** or **BLACK** screen for when the projector is idle. Press **◀ ▶** to select the required option.

VOLUME

You can adjust the volume of the built-in monaural speaker and **VARIABLE AUDIO OUT** terminal.

- ◀ Decrease
- ▶ Increase

AUDIO BALANCE

You can adjust to hear the sound played equally through both right and left external stereo speakers, or shift the balance so more sound plays through the left or right side.

- ◀ More sound plays through the left side
- ▶ More sound plays through the right side

INITIALIZE ALL

You can reset all of the customised settings to the factory defaults except **WIRELESS** and **LAMP RUNTIME** menu settings.

1. Press the **ENTER** button
2. Turn off the projector by pressing the **POWER** button.
3. Reset the projector by unplugging and plugging again.
4. The minimum required setting screen will be displayed.
 - See "Minimum required setting screen" on page 11.

NOTE:

- The security system is deactivated by default and when initialised.

SECURITY menu

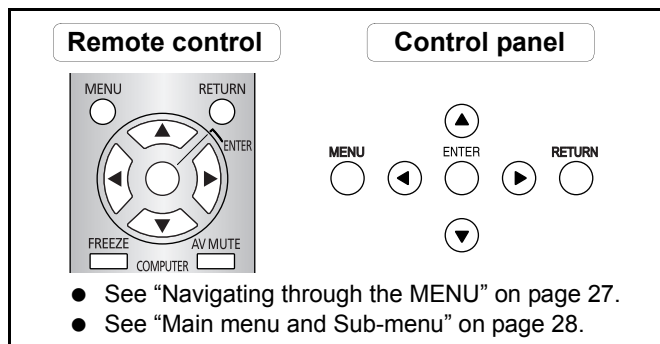

Entering the SECURITY menu

Every time when you apply to the **SECURITY** menu, you will be asked to perform the password operation.

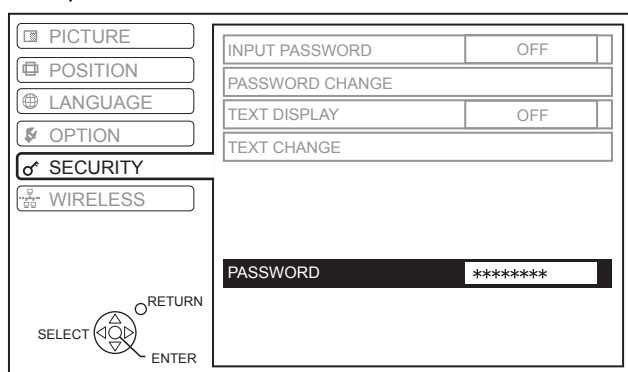

When you apply to the **SECURITY** menu before you change the password to your original, perform to input the following factory default password operation.

- Press **▲▶▼◀▲▶▼◀** and the **ENTER** button.

After you change the password

When you apply to the **SECURITY** menu after you change the password to your original in the **PASSWORD CHANGE** menu, input the original password operation.

NOTE:

- The factory default password is valid until you change the password in **PASSWORD CHANGE** menu.
- The entered password operations will appear as asterisks in the box.

INPUT PASSWORD

You can activate the security system and the password operation will be asked to perform when projecting mode started. Unless you perform the correct password operation, all of the button controls will be disabled except the **POWER** button.

- **OFF** Deactive
- **ON** Active

NOTE:

- When you activated the security system, make sure to change the password to your original for safety.
- The security system is deactivated by default and when initialised.

PASSWORD CHANGE

You can change the password operation to your original.

1. Press a series of button operation up to 8 as a password by using **▲ ▼ ◀ ▶** buttons.
2. Press the **ENTER** button.
3. Press the exact same series of button operation you entered in the **NEW** password box for confirmation.
 - If a series of button operation is incorrect, you will be asked to perform again.
4. Press the **ENTER** button.

NOTE:

- The entered password operations will appear as asterisks in the box.
- Change your password regularly.
- Do not use too simple password to guess.

TEXT DISPLAY

You can set your original text, such as company name or URL information, to display regularly at the bottom of the projected image while projecting.

- **OFF** Deactive
- **ON** Active

TEXT CHANGE

You can enter your original text up to 22 characters for **TEXT DISPLAY**.

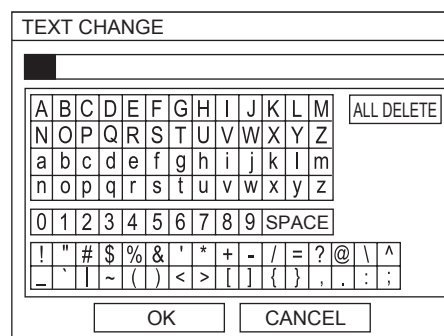

1. Use **▲ ▼ ◀ ▶** to specify the location of the required character and press the **ENTER** button.
 - The selected character will be displayed in the **TEXT CHANGE** box.
2. Repeat step 1 until finish your original text.
 - To delete all the entered characters, move the cursor to **ALL DELETE** and press the **ENTER** button.
 - To insert a character in the entered text line, move the cursor to the text box to select the required place, and press **▼** and return to the character field.
 - To delete a character, press the **DEFAULT** button or move the cursor to the required character then press the **DEFAULT** button.
3. Select **OK** and press the **ENTER** button to set the entered text.
 - Select **CANCEL** or press the **MENU/RETURN** button to return to the previous menu without setting.

WIRELESS menu

Remote control

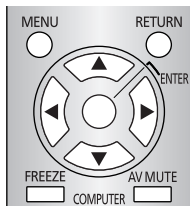

Control panel

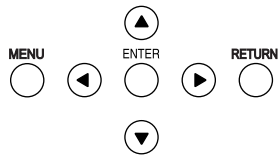

- See "Navigating through the MENU" on page 27.
- See "Main menu and Sub-menu" on page 28.

NOTE:

- The **WIRELESS** menu is available only with PT-LB80NTU/PT-LB75NTU.
- See the wireless information in the contents of the CD-ROM which is provided with the projector.
- When **INPUT PASSWORD** in **SECURITY** menu is activated, perform the correct password operation to initialise the projector via network.

Items in WIRELESS menu

In **WIRELESS** menu, the following items are available.

- **NETWORK**
- **NAME CHANGE**
- **INPUT PASSWORD**
- **PASSWORD CHANGE**
- **NETWORK STANDBY**
- **WEB CONTROL**
- **LIVE MODE CUT IN**
- **STATUS**
- **INITIALIZE**

LAMP and TEMP Indicators

Managing the indicated problems

If a problem should occur with the projector, the **LAMP** and/or **TEMP** indicators will inform you. Manage the indicated problems as follow.

1. Confirm the status of all indicators and projector, and switch off the projector in proper way.
 - See “Switching the projector on/off” on page 18.
2. Find out the cause of the problem by status of the **LAMP** and/or **TEMP** indicators.
3. Follow the instruction for each indication below and solve the problem.
4. Turn on the projector in the correct way and confirm the indicator is not indicating a problem any longer.

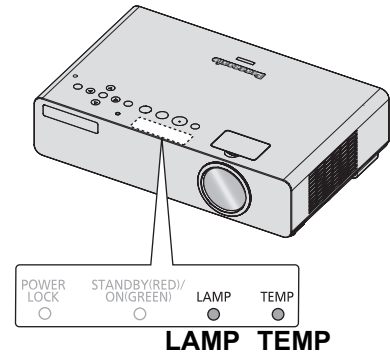

NOTE:

- If no problem is found or the problem remains, do not turn on the projector. Instead contact an Authorized Service Center.

LAMP indicator

Indicator	ILLuminating red	FLashing red		
Problem	LAMP RUNTIME has reached 2 800 hours.	LAMP circuit failure, abnormal function or the lamp unit is damaged.		
Cause	Lamp unit will run out soon and needs to be replaced.	The projector is switched on again too soon.	LAMP circuit failure, abnormal function.	Lamp unit is damaged.
Remedy	See “Replacing the Lamp unit” on page 41.	Let the lamp unit cool down and turn on the projector after 90 seconds.	Switch off the projector and contact an Authorized Service Center.	See “Replacing the Lamp unit” on page 41.

TEMP indicator

Indicator	ILLuminating red while projecting and the alert will be displayed. FLashing red and power is turned off			
Problem	The temperature inside and/or outside the projector is abnormally high.			
Cause	The ventilation openings are covered.	The room temperature is too high.	The filter is excessively dirty and the ventilation is poor.	The projector is located at 1 400 - 2 700 m (4 593 - 8 858 ft).
Remedy	Remove the object(s) from the ventilation openings or clear around the projector.	Reinstall the projector in temperature controlled place. See page 48.	Clean the filter in the proper method. See page 40.	Turn on the projector* ¹ and set the ALTITUDE to HIGH . See page 35.

*1. The projector will perform 2 minutes with **LOW** setting at high elevation.

Care and Replacement

Cleaning the projector

Before cleaning the projector

- Switch off the projector and disconnect the power plug from the wall outlet.
- Unplug all the cables from the projector.

Cleaning the outer surface of the projector

Wipe off dirt and dust gently with a soft cloth.

- If it is difficult to remove the dirt, soak a cloth with water, wring the cloth well and then wipe the projector. Dry off the projector with dry cloth.
- Do not use petroleum benzine, thinner, any alcoholic solvent, kitchen detergents or chemical clothes. Failure to observe these may result in altered or damaged surface of the projector.

Cleaning the lens and front glass surface

Wipe off dirt and dust gently with a lint-free cloth.

- Make sure no dirt or dust remains on the surface of the lens or lens cover glass. It will be enlarged and projected onto a screen.

Attaching the lens cover

1. Attach the lens cover with aligning the latches in the holes.
2. Turn the lens cover counterclockwise.

Removing the lens cover

1. Turn the lens cover clockwise.
2. Remove the lens cover from the projector.

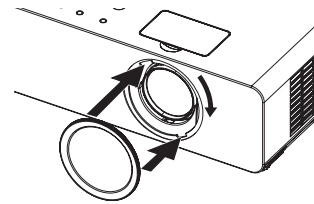
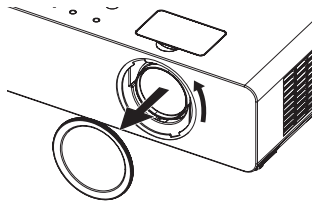

NOTE:

- Handle the ring cover with special care. Dropping or giving a shock may cause damage.
- Do not attempt to modify the ring cover.
- The ring cover must be attached to the projector all the time except cleaning time.

Cleaning the air filter

If the air filter is excessively dirty, the internal temperature of the projector increases and may cause malfunction. Clean the air filter regularly every 100 hours of usage.

1. Turn the projector upside down and place it gently on a soft cloth.
2. Press the tab and slightly slide up the air filter to remove.
3. Vacuum dirt and dust from the air filter.
 - Do not wash the air filter.
4. Place and slightly slide in the air filter in the air intake port to attach.
 - Make sure the air filter clicks into the place.

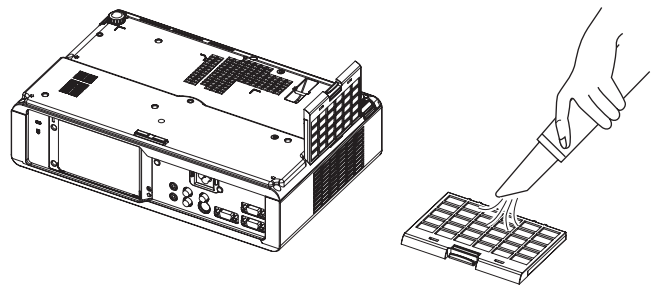

NOTE:

- Do not use the projector without attaching the air filter.

Replacing the air filter



The air filter should be replaced when cleaning is ineffective and when replacing lamp unit. A replacement air filter is provided with a replacement lamp unit. Contact an Authorized Service Center for the optional air filter.

Replacing the Lamp unit

The lamp unit, ET-LAB80 is consumable and you must replace it regularly. It is recommended that a qualified technician carry the lamp unit replacement and consult with an Authorized Service Center.

When to replace the Lamp unit

When the lamp is consumed, the brightness may decrease over time. 3 000 hours of use is the replacing timing as rough guided, and that might be shortened by the usage conditions, characteristics of the lamp unit or environmental conditions. You can find the duration of usage time by checking **LAMP RUNTIME** in **OPTION** menu.

Indication	On screen 	LAMP indicator 
Over 2 800 hours	Displays " REPLACE LAMP " on the upper left of the screen for 30 seconds.	Illuminates red.
Over 3 000 hours	Displays " REPLACE LAMP " on the upper left of the screen, and it will stay until you respond. Press any button to clear the screen.	

NOTE:

- The guide times, 2 800 and 3 000 hours, are rough estimates based on certain conditions and is not a guaranteed time.
- For more information about the lamp unit and its guaranteed time, see the instructions which is provided with the lamp unit.
- Do not use a lamp unit over 3 000 hours. Failure to observe this may result in explosion of the lamp.

Before replacing the lamp unit

- Contact an Authorized Service Center to purchase a replacement lamp unit (ET-LAB80).
- Switch off the projector and disconnect the power plug from the wall outlet.
- Wait for more than 1 hour and make sure the lamp unit and the surroundings are cooled enough.
- Prepare a Phillips-head screwdriver.
- When the projector is mounted in the ceiling, do not work directly under the projector or put your face closer to the projector.

NOTE:

- Prior to replacing the lamp unit, allow it to cool down to prevent the risk of burns, damage and other hazards.
- Do not attempt replacement with an unauthorized lamp unit.

Care and Replacement

Replacement procedure

Removing and replacing the lamp unit

1. Use a Phillips-head screwdriver to loosen the 2 lamp unit cover fixing screws on the back of the projector until the screws turn freely, and remove the lamp unit cover.

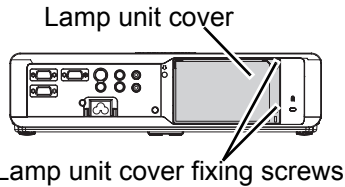

2. Use a Phillips-head screwdriver to loosen the 3 lamp unit fixing screws.

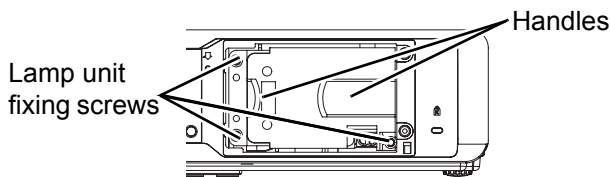

3. Pull the used lamp unit gently from the projector.
 - Grip the handle and keep the lamp unit paralleled when you remove the lamp. Some parts of the lamp unit are sharpened and may cause injury.

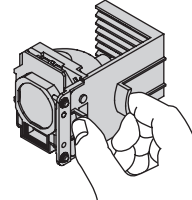

4. Replace the new lamp unit in correct direction.
5. Press in the lamp unit until it clicks and make sure the unit is installed securely.
6. Tighten the 3 lamp unit fixing screws securely with a Phillips-head screwdriver.

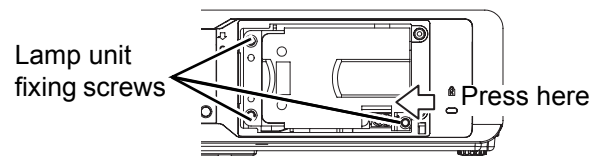

7. Attach the lamp unit cover and tighten the 2 lamp unit cover fixing screws securely with a Phillips-head screwdriver.

NOTE:

- Be sure to install the lamp unit and attach the lamp unit cover securely. If they are not installed securely, it may cause the protection circuit to operate so that the power cannot be turned on.
- Do not switch the power on while the lamp unit cover removed.
- Handle the lamp unit with special care as that is a glass product. Dropping or giving a shock may cause burst or damage.

Resetting the LAMP RUNTIME

1. Connect the power cord to a wall outlet, and switch on the projector.
2. Press the **MENU** button to display the menu.
3. Press **▲ ▼** to select **OPTION** and press **ENTER**.
4. Press **▲ ▼** to select **LAMP RUNTIME**.
5. Press and hold the **ENTER** button for approximately 3 seconds.
6. The confirmation screen will be displayed and select **OK**.
7. Reset the projector by unplugging and plug again the power cord.
8. Display the **LAMP RUNTIME** menu again and confirm the duration of time is reset to "0 H".

LAMP POWER	NORMAL
LAMP RUNTIME	1820H

Troubleshooting

Should any problem persist, contact your dealer.

Problem	Cause	Reference page
Power does not turn on.	● The power cord may not be connected securely.	18
	● No electric supply at the wall outlet.	19
	● TEMP indicator is lit or flashes.	39
	● LAMP indicator is lit or flashes.	39
	● The lamp unit cover has not been securely installed.	42
	● The circuit breakers have tripped.	-
No picture appears.	● The signal input source may not be connected to a terminal properly.	17
	● The input selection setting may not be correct.	24
	● The BRIGHTNESS adjustment setting may be at the minimum setting.	30
	● The signal input source may not be operating properly.	-
	● The AV MUTE function may be in use.	24
The picture is fuzzy.	● The lens focus may not have been set correctly.	22
	● The projector may not be at the correct distance from the screen.	15
	● The lens may be dirty.	40
	● The projector may be tilted too much.	15/16
The color is pale or grayish.	● COLOR or TINT adjustment may be incorrect.	30
	● The input source which is connected to the projector may not be adjusted correctly.	28
No sound can be heard from the internal speaker.	● The audio signal source may not be connected properly.	17
	● A cable may be connected to the VARIABLE AUDIO OUT terminal.	13
	● The volume adjustment may be at the lowest possible setting.	25
The control buttons of the projector do not operate.	● CONTROL PANEL in OPTION menu is invalidated. If you have a loss of the remote control while the CONTROL PANEL is invalidated, press and hold the MENU button for 2 seconds with pressing the ENTER button.	35
The Remote control does not operate.	● The batteries may be weak.	-
	● The batteries may not have been inserted correctly.	14
	● The remote control signal receptor on the projector may be obstructed.	23
	● The remote control unit may be out of the operation range.	23
	● The remote control is under the strong light such as fluorescent.	23
The picture does not display correctly.	● The signal format (TV-SYSTEM) may not have been set correctly.	31
	● There may be a problem with the VCR or other signal source.	-
	● A signal which is not compatible with the projector is being input.	44
Picture from a computer does not appear.	● The cable may be longer than the optional cable.	-
	● The external video output from a laptop computer may not be correct. (You may be able to change the external output settings by pressing the [Fn] + [F3] or [Fn] + [F10] keys simultaneously. The actual method varies depending on the type of computer; refer to the documentation provided with your computer for further details.)	46
	● COMPUTER2 SELECT setting in OPTION menu is not correct.	34

Technical Information

List of compatible signals

Mode	Display resolution (dots) ^{*1}	Scanning frequency		Dot clock frequency (MHz)	Picture quality ^{*2}	Terminals
		H (kHz)	V (Hz)			
NTSC/NTSC 4.43/ PAL-M/PAL60	720 x 480i	15.7	59.9	-	A	VIDEO/S-VIDEO
PAL/PAL-N/SECAM	720 x 576i	15.6	50.0	-	A	
525i (480i)	720 x 480i	15.7	59.9	13.5	A	COMPUTER/YPBPR
625i (576i)	720 x 576i	15.6	50.0	13.5	A	
525p (480p)	720 x 483	31.5	59.9	27.0	A	
625p (576p)	720 x 576	31.3	50.0	27.0	A	
1 125 (1 080)/60i	1 920 x 1 080i	33.8	60.0	74.3	A	
1 125 (1 080)/50i	1 920 x 1 080i	28.1	50.0	74.3	A	
750 (720)/60p	1 280 x 720	45.0	60.0	74.3	A	COMPUTER/YPBPR ^{*3}
750 (720)/50p	1 280 x 720	37.5	50.0	74.3	A	
VESA	640 x 400	31.5	70.1	25.2	A	COMPUTER
	640 x 400	37.9	85.1	31.5	A	
VGA	640 x 480	31.5	59.9	25.2	A	
	640 x 480	35.0	66.7	30.2	A	
	640 x 480	37.9	72.8	31.5	A	
	640 x 480	37.5	75.0	31.5	A	
	640 x 480	43.3	85.0	36.0	A	
SVGA	800 x 600	35.2	56.3	36.0	A	
	800 x 600	37.9	60.3	40.0	A	
	800 x 600	48.1	72.2	50.0	A	
	800 x 600	46.9	75.0	49.5	A	
	800 x 600	53.7	85.1	56.3	A	
MAC	832 x 624	49.7	74.6	57.3	A	
XGA	1 024 x 768	39.6	50.1	51.9	AA	
	1 024 x 768	48.4	60.0	65.0	AA	
	1 024 x 768	56.5	70.1	75.0	AA	
	1 024 x 768	60.0	75.0	78.8	AA	
	1 024 x 768	68.7	85.0	94.5	AA	
MXGA	1 152 x 864	64.0	71.2	94.2	A	
	1 152 x 864	67.5	74.9	108.0	A	
	1 152 x 864	77.1	85.0	119.7	B	
MAC	1 152 x 870	68.7	75.1	100.0	A	
MSXGA	1 280 x 960	60.0	60.0	108.0	A	
SXGA	1 280 x 1 024	64.0	60.0	108.0	A	
	1 280 x 1 024	80.0	75.0	135.0	B	
	1 280 x 1 024	91.1	85.0	157.5	B	
SXGA60+	1 400 x 1 050	64.0	60.0	108.0	A	
	1 400 x 1 050	65.1	59.9	122.4	B	
UXGA	1 600 x 1 200	75.0	60.0	162.0	B	
WIDE750 (720)	1 280 x 720	44.8	59.9	74.5	A	
	1 280 x 720	37.1	49.8	60.5	A	
WXGA768	1 280 x 768	39.6	49.9	65.3	A	
	1 280 x 768	47.8	59.9	79.5	A	
WXGA800	1 280 x 800	41.3	50.0	68.0	A	
	1 280 x 800	49.1	60.2	69.1	A	
	1 280 x 800	49.7	59.8	83.5	A	
WXGA+	1 440 x 900	55.9	59.9	106.5	A	
WSXGA+	1 680 x 1 050	65.3	60.0	146.3	B	
WUXGA	1 920 x 1 200	74.6	59.9	193.3	B	

*1. The "i" appearing after the resolution indicates an interlaced signal.

*2. The following symbols are used to indicate picture quality.

AA Maximum picture quality can be obtained.

A Signals are converted by the image processing circuit before picture is projected.

B Some loss of data occurs to make projection easier.

*3. Displays 750 (720)/60p or 750 (720)/50p signals through COMPUTER terminals as WIDE750 (720). Press the **AUTO SETUP** button and adjust the image.

Serial terminal

The serial connector which is on the connector panel of the projector conforms to the RS-232C interface specification, so that the projector can be controlled by a personal computer which is connected to this connector.

Connection

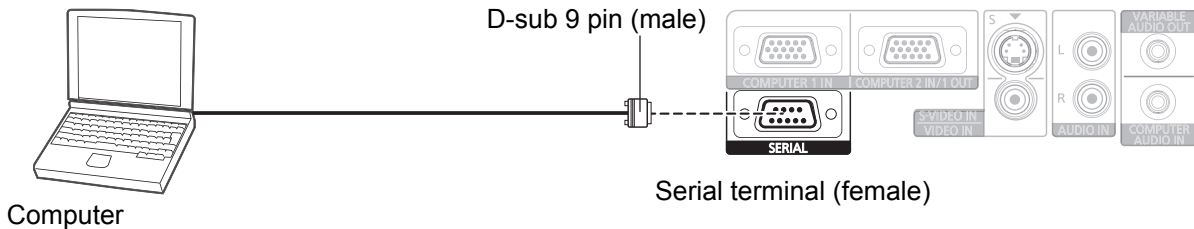

Pin assignments and signal names

	Pin No.	Signal name	Contents
	①		NC
	②	TXD	Transmitted data
	③	RXD	Received data
	④		NC
	⑤	GND	Earth
	⑥		NC
	⑦	RTS	Connected internally
	⑧	CTS	
	⑨		NC

Communication settings

Signal level	RS-232C	Character length	8 bits
Sync. method	Asynchronous	Stop bit	1 bit
Baud rate	9 600 bps	X parameter	None
Parity	None	S parameter	None

Basic format

STX	Command	:	Parameter	ETX
Start byte (02h)	3 bytes	1 byte	1 byte - 4 bytes	End (03h)

The data streaming from the computer will start with STX, and proceed to Command, Parameter and end with ETX. You can add the required parameter.

- The projector can not receive any command for 10 seconds after the lamp is switched on. Wait 10 seconds before sending the command.
- If sending multiple commands, check that a response has been received from the projector for one command before sending the next command.
- When a command which does not require parameters to be sent, the colon (:) is not required.
- If an incorrect command is sent from the personal computer, the ER401 command will be sent from the projector to the personal computer.

Technical Information

Cable specifications

(When connected to a personal computer)

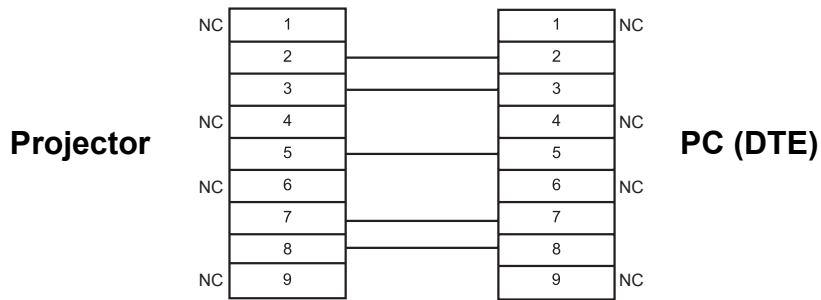

Control commands

Command	Control contents	Remarks
PON	Power on	In standby mode, all commands other than the PON command are ignored. ● The PON command is ignored during lamp ON control.
POF	Power off	If a PON command is received while the cooling fan is operating after the lamp has switched off, the lamp is not turned back on again straight away in order to protect the lamp.
AVL	Volume	Parameter 000 - 063 (Adjustment value 0 - 63)
IIS	Input	Parameter: VID = VIDEO RG1 = COMPUTER1 SVD = S-VIDEO RG2 = COMPUTER2 NWP = WIRELESS (PT-LB80NTU/PT-LB75NTU only)
Q\$S	Lamp condition query	Call back 0 = Standby 1 = Lamp on control active 2 = Lamp on 3 = Lamp off control active
OSH	Shutter	Turning off the projection temporarily. Send the command to switch between on and off. Do not send the command consecutively.

Computer connection guidance

You can switch the signals which to output from the **COMPUTER1 OUT** terminal by pressing the computer key command. The key commands are depend on the manufactures. If you select the computer terminals which has no signals while the **INPUT GUIDE** is set to **DETAILED**, the computer connection guidance will be displayed.

Manufacturer	Key command	Manufacturer	Key command	Manufacturer	Key command
Panasonic NEC	Fn + F3	TOSHIBA SHARP HP	Fn + F5	IBM SONY	Fn + F7
				Apple	F7
FUJITSU	Fn + F10	EPSON DELL	Fn + F8	Other	Fn +

NOTE:

- The computer connection guidance will disappear after 5 minutes.
- Please refer the instructions which provided with the computers for more detailed information.

Screen size and throw distance for 16:9 aspect ratio

Projection size (16 : 9)	Throw distance (L) PT-LB80NTU / PT-LB80U		Throw distance (L) PT-LB75NTU / PT-LB75U	
	Minimum distance (LW)	Maximum distance (LT)	Minimum distance (LW)	Maximum distance (LT)
33" (0.84 m)		1.2 m (3'11")		1.2 m (3'11")
40" (1.02 m)	1.2 m (3'11")	1.5 m (4'11")	1.3 m (4'3")	1.5 m (4'11")
50" (1.27 m)	1.6 m (5'2")	1.9 m (6'2")	1.6 m (5'2")	1.9 m (6'2")
60" (1.52 m)	1.9 m (6'2")	2.3 m (7'6")	1.9 m (6'2")	2.3 m (7'6")
70" (1.78 m)	2.2 m (7'2")	2.7 m (8'10")	2.2 m (7'2")	2.6 m (8'6")
80" (2.03 m)	2.5 m (8'2")	3.0 m (9'10")	2.5 m (8'2")	3.0 m (9'10")
90" (2.29 m)	2.8 m (9'2")	3.4 m (11'1")	2.8 m (9'2")	3.4 m (11'1")
100" (2.54 m)	3.2 m (10'5")	3.8 m (12'5")	3.2 m (10'5")	3.8 m (12'5")
120" (3.05 m)	3.8 m (12'5")	4.6 m (15'1")	3.8 m (12'5")	4.6 m (15'1")
150" (3.81 m)	4.8 m (15'8")	5.8 m (19')	4.7 m (15'5")	5.7 m (18'8")
200" (5.08 m)	6.4 m (20'11")	7.7 m (25'3")	6.3 m (20'8")	7.6 m (24'11")
250" (6.35 m)	8.0 m (26'2")	9.6 m (31'5")	7.9 m (25'11")	9.5 m (31'2")
300" (7.62 m)	9.6 m (31'5")	11.6 m (38')	9.5 m (31'2")	11.4 m (37'4")

* All measurements above are approximate and may differ slightly from the actual measurements.

Calculation methods for screen dimensions

You can calculate more detailed screen dimension from the screen diagonal.

- Screen width (SW) and screen height (SH)

$$SW (m) = SD (") \times 0.0221$$

$$SH (m) = SD (") \times 0.0125$$

- Minimum distance (LW) and maximum distance (LT)

$$PT-LB80NTU: LW (m) = 0.0321 \times SD (") - 0.04$$

$$LT (m) = 0.0388 \times SD (") - 0.06$$

$$PT-LB75NTU: LW (m) = 0.0318 \times SD (") - 0.022$$

$$LT (m) = 0.0383 \times SD (") - 0.046$$

* The results above are approximate and may differ slightly from the actual measurements.

Technical Information

Specifications

Power supply		AC 100 - 240 V 50 Hz/60 Hz
Power consumption		300 W During standby (when fan is stopped): 4 W
Amps		3.5 A - 1.2 A
LCD panel	Panel size (diagonal)	0.63 type (16.00 mm)
	Aspect ratio	4 : 3
	Display method	3 transparent LCD panels (RGB)
	Drive method	Active matrix method
	Pixels	786 432 (1 024 x 768) x 3 panels
Lens		Manual zoom (1.2x)/Manual focus F 1.6 - 1.9, f 18.8 mm - 22.6 mm (PT-LB80NTU /PT-LB80U) F 1.7 - 1.9, f 18.5 mm - 22.2 mm (PT-LB75NTU / PT-LB75U)
Optical axis		8:1 fixed (PT-LB80NTU/PT-LB80U) 5:1 fixed (PT-LB75NTU / PT-LB75U)(page 15)
Lamp		UHM lamp (220 W)
Luminosity*1		3 200 lm (PT-LB80NTU /PT-LB80U) 2 500 lm (PT-LB75NTU / PT-LB75U)
Operating environment		Temperature 0 °C - 40 °C (32 °F - 104 °F) When the ALTITUDE (page 35) is set to HIGH : 0 °C - 35 °C (32 °F - 95 °F) Humidity 20% - 80% (no condensation)
Scanning frequency*2 (for RGB signal)	Horizontal scanning frequency	15 kHz - 91 kHz
	Vertical scanning frequency	50 Hz - 85 Hz
	Dot clock frequency	Less than 110 MHz
COMPONENT (YPbPr) signals		525i (480i), 525p (480p), 625i (576i), 625p (576p), 750 (720)/60p, 750 (720)/50p, 1 125 (1 080)/60i, 1 125 (1 080)/50i
Color system		7 (NTSC/NTSC 4.43/PAL/PAL-M/PAL-N/PAL60/SECAM)
Projection size		33" - 300" (838.2 mm - 7 620 mm)
Throw distance		1.1 m - 11.6 m (3'7" - 38')
Screen aspect ratio		4 : 3
Installation		FRONT/DESK, FRONT/CEILING, REAR/DESK, REAR/CEILING (Menu selection method)
Speaker		1 piece 4 cm x 2 cm (1 - 9/16" x - 25/32")
Max. useable volume output		1.0 W

*1. Measurement, measuring conditions and method of notation all comply with ISO21118 international standards.

*2. See "List of compatible signals" on page 44 for available signals.

Terminals	S-VIDEO IN	Single - line, Mini DIN 4p Y: 1.0 V [p-p], C: 0.286 V [p-p], 75 Ω
	VIDEO IN	Single - line, RCA pin jack 1.0 V [p-p], 75Ω
	COMPUTER	Single - line, D - sub HD 15-pin (female) <ul style="list-style-type: none"> ● RGB input/output <p style="margin-left: 40px;">R.G.B.: 0.7 V [p-p], 75 Ω</p> <p style="margin-left: 40px;">G SYNC: 1.0 V [p-p], 75 Ω</p>
		HD, VD/SYNC: TTL high impedance, automatic positive/negative polarity compatible
		<ul style="list-style-type: none"> ● YPBPR/YPBCB input/output <p style="margin-left: 40px;">Y: 1.0 V [p-p] (include sync) 75 Ω</p> <p style="margin-left: 40px;">PB/CB, PR/CR: 0.7 V [p-p] 75 Ω</p>
	AUDIO IN	Single - line, 0.5V [rms], RCA pin jack x 2 (L - R)
	COMPUTER AUDIO IN	Single - line, 0.5V [rms], M3 jack (Stereo MINI)
	VARIABLE AUDIO OUT	Single - line, 0.5V [rms], M3 jack (Stereo MINI) Monitor output/stereo compatible 0 V [rms] - 2.0 V [rms] (variable)
SERIAL	D-sub 9-pin RS-232C compatible	
Wireless LAN (PT-LB80NTU/PT-LB75NTU only)	Compatible	IEEE802.11b/IEEE802.11g (Wireless LAN standard protocol)
	Wireless channel	IEEE802.11b/IEEE802.11g: 1 - 13 channels
	Distance	30 m (98'5") Depends on the usage environment
Cabinet	Moulded plastic (PC+ABS)	
Dimensions	Width	368 mm (14 - 15/32")
	Height	88 mm (3 - 13/16")
	Length	233 mm (9 - 5/32") (not including surface projection parts)
Weight	3 kg (6.6 lbs.)	
Certifications	UL60950-1	C-UL
	FCC Class B	ICES-003
Remote control	Power supply	3 V DC (AA battery x 2)
	Operating range	Approx. 15 m (49'2") (when operated directly in front of signal receptor)
	Weight	117 g (4.2 ozs.) (including batteries)
	Dimensions	Width
Length		163 mm (6 - 13/32")
Height		24.5 mm (-15/16") (not including surface projection parts)
Options	Ceiling bracket	ET-PKB80

Technical Information

Dimensions

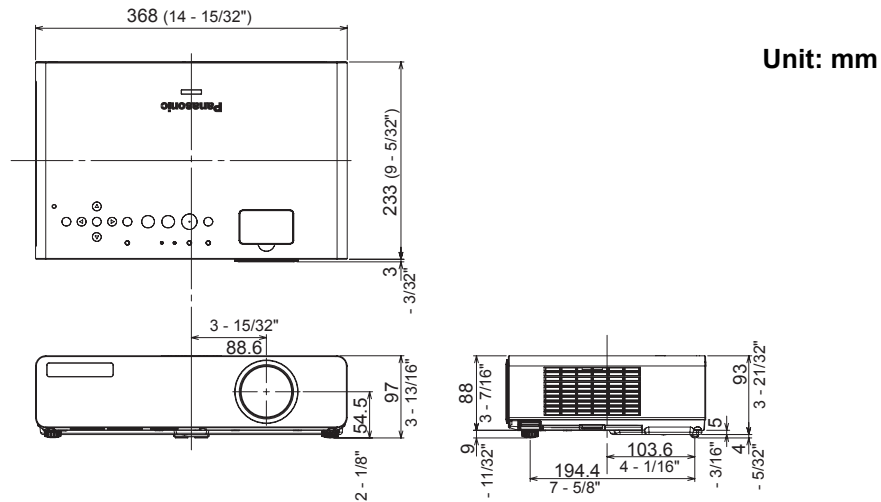

Trademark acknowledgements

- VGA and XGA are trademarks of International Business Machines Corporation.
- S-VGA is a registered trademark of the Video Electronics Standards Association.
- HDMI, the HDMI logo and High-Definition Multimedia Interface are trademarks or registered trademarks of HDMI Licensing LLC.
- The font used in the on-screen displays is a Ricoh bitmap font, which is manufactured and sold by Ricoh Company, Ltd.

All other trademarks are the property of the various trademark owners.

Index

A	
AC IN	13
Accessories	10
Air exhaust port	13
Air filter	
Cleaning	40
Compartment	13
Air intake port	12
ALTITUDE	35
Ambient Luminance Sensor (ALS)	12
ASPECT	32
AUDIO BALANCE	36
AUDIO IN	13
AUTO SETUP	
Menu	35
Remote control	23
Remote control button	14
AV MUTE	
Remote control	24
Remote control button	14
B	
BACK COLOR	36
Batteries	10
Battery compartment	14
BLACKBOARD	36
BRIGHTNESS	30
Burglar hook port	13
C	
Calculation methods	
16:9	47
4:3	15
Carrying bag	10
CD-ROM	
Accessories	10
Cleaning	
Air filter	40
Projector	40
CLOCK PHASE	32
CLOSED CAPTION SETTING	36
COLOR	30
COLOR TEMPERATURE	30
COMPUTER	
Connection guidance	46
Remote control	24
Remote control button	14
COMPUTER AUDIO IN	13
COMPUTER SEARCH	14
COMPUTER1 IN	13
COMPUTER2 IN/1 OUT	13
COMPUTER2 SELECT	34
Connections	17
CONTRAST	30
CONTROL PANEL	
Buttons	12
Menu	35
D	
DAYLIGHT VIEW	30
DEFAULT	
Remote control	24
Remote control button	14
DETAILED SETUP	
OPTION menu	36
PICTURE menu	31
DIGITAL ZOOM	
Remote control	26
Remote control button	14
Dimensions	50
Direct power off	18
DIRECT POWER ON	
Function	18
Menu	35
DOT CLOCK	32
E	
ENTER	
Control panel button	12
Remote control button	14
F	
Focus ring	12, 22
FRAME LOCK	33
FREEZE	
Remote control	24
Remote control button	14
Front leg adjusters	13, 16, 22
Buttons	22
FUNCTION	
Control panel button	12
FUNCTION BUTTON	36
Remote control	25
Remote control button	14
H	
Hand strap	14
HIGHLAND	35
I	
INDEX-WINDOW	
Remote control	25
Remote control button	14
INITIALIZE ALL	36
INPUT GUIDE	34
INPUT PASSWORD	37
INPUT SELECT	
Control panel button	12
Remote control button	14
Selecting	24
INSTALLATION	
Menu	35
Projection method	16
K	
KEYSTONE	32
L	
LAMP	
Indicator	12
Indicator status	39
LAMP POWER	35
LAMP RUNTIME	35, 42
Lamp unit compartment	13
Replacing	41
Lens cover	12, 40
M	
MENU	
Control panel button	12
Main menu	28
Navigation	27
Remote control	27
Remote control button	14
MULTI-LIVE	14

Index

N		STARTUP LOGO	34
Navigation buttons		STILL MODE	31
Control panel button	12	Sub-menu	28
Remote control button	14	S-VIDEO IN	13
NOISE REDUCTION	31	SXGA MODE	36
O		T	
OPTION menu	34	Technical Information	44
OSD DESIGN	36	TEMP	
P		Indicator	12
PAGE	14	Indicator status	39
PASSWORD CHANGE	37	TEST PATTERN	36
PICTURE menu	30	TEXT CHANGE	37
PICTURE MODE	30	TEXT DISPLAY	37
POSITION	32	Throw distance	
POSITION menu	32	16:9	47
POWER		4:3	15
Control panel	12	Throwing angle	16
Indicator	12	TINT	30
Indicator status	21	Troubleshooting	43
Remote control button	14	TV-SYSTEM	31
Power cord		V	
Accessories	10	VARIABLE AUDIO OUT	13
Connecting	18	VIDEO	
Power cord secure lock	10, 18	Remote control	24
POWER LOCK		Remote control button	14
Indicator	12	VIDEO IN	13
Indicator status	21	VOLUME	36
POWER OFF TIMER	35	Remote control	25
Projection method	16	Remote control button	14
R		W	
REALTIME KEYSTONE	32	WHITE BALANCE	31
RELEASE		WIDE MODE	34
Control panel button	12	WIRELESS	
Remote control		Menu	38
Accessories	10	Remote control	24
Operation	23	Remote control button	14
Signal emitter	14	Z	
Signal receptor	12	Zoom ring	12, 22
Replacing		Zoom-Focus ring cover	12
Air filter	40		
Lamp unit	41		
RETURN			
Control panel button	12		
Remote control	27		
Remote control button	14		
RGB/YBPBR	34		
S			
Screen size			
16:9	47		
4:3	15		
Security	9		
Security lock	13		
SECURITY menu	37		
SERIAL	13		
Basic format	45		
Cable specifications	46		
Communication settings	45		
Connection	45		
Control commands	46		
Pin assignments	45		
SHARPNESS	30		
SIGNAL SEARCH	35		
Signals	44		
Speaker	13		
Specifications	48		

Avis important concernant la sécurité

Cher client Panasonic:

Il est important de lire et comprendre les informations suivantes car elles fournissent des détails qui vous permettront d'utiliser le projecteur sans danger pour vous et votre environnement, conformément aux dispositions légales relatives à l'utilisation de projecteurs. Avant de brancher, utiliser ou régler ce projecteur, veuillez lire toute la notice puis la conserver avec le projecteur pour vous y référer ultérieurement. Nous espérons qu'elle vous aidera à optimiser l'utilisation de votre nouveau produit et que vous serez satisfait de votre projecteur LCD Panasonic. Le numéro de série de votre produit se trouve sous le projecteur. Veuillez le noter dans l'espace ci-dessous prévu à cet effet et conserver cette notice en cas de maintenance requise.

Numéro de modèle: PT-LB80NTU / PT-LB75NTU/PT-LB80U/PT-LB75U

Numéro de série:

AVERTISSEMENT: POUR REDUIRE LES RISQUES DE FEU OU DE CHOC ÉLECTRIQUE, NE PAS EXPOSER CE PRODUIT À L'EAU OU À L'HUMIDITÉ.

Alimentation: Ce projecteur LCD est conçu pour fonctionner sur secteur de 100 V - 240 V, 50 Hz/60 Hz seulement.

ATTENTION: Le cordon d'alimentation secteur fourni avec le projecteur peut être utilisé uniquement pour une alimentation électrique de 125 V, 7 A maximum. Si on veut l'utiliser avec une tension ou un courant plus forts, on doit se procurer un autre cordon d'alimentation de 250 V. Si on utilise le cordon fourni sous ces conditions, risque de provoquer un incendie.

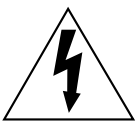

Le symbole de la flèche en forme d'éclair, dans un triangle, avertit l'utilisateur de la présence de «tensions dangereuses» à l'intérieur du produit qui peuvent être de force suffisante pour constituer un risque de choc électrique aux personnes.



Le point d'exclamation dans un triangle avertit l'utilisateur de la présence d'instructions importantes concernant l'utilisation et l'entretien (réparation) dans la littérature accompagnant le produit.

ATTENTION: Cet appareil est équipé d'une fiche de courant à trois broches avec mise à la terre. Ne pas retirer la broche de mise à la masse de la fiche. Cette fiche ne pourra être utilisée que dans une prise avec mise à la terre. Ceci est une précaution sécuritaire. S'il est impossible d'insérer la fiche dans la prise, s'adresser à un électricien. Ne pas annuler la protection de la fiche à mise à la terre.

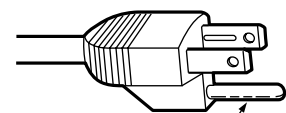

Ne pas retirer

Pursuant to at the directive 2004/108/EC, article 9(2)
Panasonic Testing Centre
Panasonic Service Europe, a division of Panasonic Marketing Europe GmbH
Winsbergring 15, 22525 Hamburg, F.R. Germany

NOTICE:

- Ce produit possède une lampe à décharge haute intensité (DHI) qui contient du mercure. Son élimination peut être réglementée dans votre s à cause de considérations environnementales. Pour d'amples informations sur la mise au rebut ou le recyclage, veuillez contacter vos autorités locales ou aller au site Web de l'Electronics Industries Alliance: <http://www.eiae.org>

Avis important concernant la sécurité

AVERTISSEMENT:

Cet équipement a été soumis à des tests qui ont démontré que celui-ci respectait les limites spécifiées pour les appareils numériques de la classe B aux termes de la partie 15 des règles de la FCC (Federal Communications Commission U.S.A.). Ces limites ont pour objet de fournir une protection raisonnable contre les interférences nuisibles dans le cas d'une installation en milieu résidentiel. Cet équipement produit, utilise et peut rayonner de l'énergie de haute fréquence, et s'il n'est pas installé et utilisé conformément aux instructions fournies avec celui-ci, peut provoquer des interférences nuisibles aux communications radio. En outre, même en cas d'utilisation conforme, il n'est pas garanti qu'aucune interférence ne saurait survenir avec certaines installations. Si cet équipement s'avère nuire à la bonne réception d'émissions de radiophonie ou de télévision, ce que l'on pourra déterminer en mettant l'équipement successivement hors tension puis sous tension, il est conseillé de tenter de remédier au problème par l'une des méthodes suivantes:

- Réorientez ou déplacez l'antenne du récepteur;
- Éloignez l'équipement du récepteur;
- Branchez l'équipement dans une prise de courant située sur un circuit autre que celui qui alimente la prise de courant du récepteur;
- Demandez conseil à votre distributeur ou à un technicien de radio/télévision expérimenté.

ATTENTION: Pour assurer la bonne conformité, utilisez uniquement des câbles d'interface blindés lorsque vous connectez des ordinateurs ou des périphériques. Toute modification non autorisée de cet équipement annulera le droit de l'utilisateur à utiliser cet équipement.

Si le port sériel est utilisé pour connecter un ordinateur personnel afin de commander le projecteur depuis l'extérieur, il faut utiliser le câble d'interface sériel en option RS-232C avec une âme en ferrite. Tout changement ou modification non autorisé à cet équipement annule l'autorité de faire fonctionner cet appareil.

Avertissement de la FCC relative à l'exposition RF : (si fourni avec un appareil sans fil)

- Cet équipement est conforme aux limitations concernant l'exposition aux radiations établies par la FCC dans un environnement non contrôlé.
- Cet équipement a été approuvé pour un fonctionnement mobile et requiert de respecter une distance minimum de 20 cm entre l'antenne(s) et toutes les parties de votre corps (sauf les extrémités des mains, poignets et pieds) durant les modes de fonctionnement sans fil.
- Cet équipement ne peut pas être utilisé avec d'autres transmetteurs installés, qui peuvent être capable de transmission simultanée.

AVERTISSEMENT:

- Ne peut être utilisé dans une salle d'ordinateurs telle que définie dans la norme ANSI/NFPA 75 Standard for Protection of Electronic Computer/Data Processing Equipment.
- Pour l'équipement branché en permanence, un dispositif de dis connexion d'accès facile doit être incorporé dans le câble d'installation du bâtiment;
- Pour l'équipement bran cable, une prise secteur d'accès facile doit être installée près de l'équipement.

Déclaration de conformité

Modèle n°: PT-LB80NTU / PT-LB75NTU/PT-LB80U/PT-LB75U

Désignation commerciale: **Panasonic**

Fabricant responsable: Panasonic Corporation of North America

Adresse: One Panasonic Way, Secaucus, New Jersey 07094

Téléphone: (888) 411 - 1996

Email: projectorsupport@us.panasonic.com

Cet appareil est conforme à la partie 15 des règles de la FCC (Federal Communications Commission U.S.A.) ce qui signifie: (1) que l'appareil ne produit pas d'interférences nuisibles, et (2) que l'appareil est capable de supporter sans danger les interférences reçues, y compris celles susceptibles de perturber son fonctionnement.

Informations sur l'évacuation des déchets dans les pays ne faisant pas partie de l'Union européenne



Ce symbole n'est reconnu que dans l'Union européenne. Pour vous débarrasser de ce produit, veuillez contacter les autorités locales ou votre revendeur afin de connaître la procédure d'élimination à suivre.

AVERTISSEMENTS

Si l'on remarque une émission de fumée, d'odeurs suspectes ou de bruits provenant du projecteur, débrancher la fiche du cordon d'alimentation de la prise de courant.

- Ne pas continuer d'utiliser le projecteur dans ces cas-là, autrement cela peut entraîner un incendie ou des chocs électriques.
- Après s'être assuré que de la fumée ne se dégage plus, s'adresser à un centre technique agréé et demander que les réparations nécessaires soient faites.
- Le fait de réparer le projecteur soi-même est très dangereux, et ne doit jamais être fait.

Ne pas installer ce projecteur dans un endroit qui n'est pas assez résistant pour supporter le poids du projecteur.

- Si l'emplacement d'installation n'est pas assez résistant, le projecteur risque de tomber et causer de graves blessures et (ou) des dommages.

Demander à un technicien qualifié d'installer le projecteur par exemple s'il est installé au plafond.

- Si l'installation n'est pas faite correctement, cela peut entraîner des blessures ou des chocs électriques.
- Ne pas utiliser un support de montage au plafond qui n'est pas agréé.

Si de l'eau ou des objets étrangers pénètrent dans le projecteur, si le projecteur tombe, ou si le boîtier est endommagé, débrancher immédiatement la fiche du cordon d'alimentation de la prise de courant.

- Si l'on continue d'utiliser le projecteur dans ces conditions, cela peut entraîner un incendie ou des chocs électriques.
- S'adresser à un centre technique agréé pour que les réparations nécessaires puissent être faites.

Ne pas surcharger la prise de courant.

- Si l'alimentation est surchargée (par exemple, par l'utilisation de trop d'adaptateurs), cela risque de faire surchauffer le projecteur et peut entraîner un incendie.

Ne jamais entreprendre toute modification quelconque ou démontage du projecteur.

- Des hautes tensions qui peuvent causer de graves blessures sont présentes à l'intérieur du projecteur.
- Pour toute inspection, réglage ou réparation, s'adresser à un centre technique agréé.

Nettoyer la fiche du cordon d'alimentation régulièrement afin d'éviter toute accumulation de poussière.

- Si de la poussière s'accumule sur la fiche du cordon d'alimentation, l'humidité peut endommager l'isolant et entraîner un incendie. Débrancher la fiche du cordon d'alimentation de la prise de courant et l'essuyer avec un tissu sec.
- Si le projecteur n'est pas utilisé pendant une période prolongée, débrancher la fiche du cordon d'alimentation de la prise de courant.

Ne pas manipuler le cordon d'alimentation avec les mains mouillées.

- Cela peut entraîner des chocs électriques.

Brancher la fiche du cordon d'alimentation fermement dans la prise de courant.

- Si la fiche n'est pas complètement insérée, cela peut entraîner des chocs électriques ou la faire surchauffer.
- Si la fiche est endommagée ou la plaque de la prise desserrée, celles-ci ne devraient pas être utilisées.

Ne pas placer le projecteur sur des surfaces instables.

- Si le projecteur est placé sur une surface qui est inclinée ou instable, il risque de tomber ou de se renverser et cela peut causer des blessures ou des dommages.

Ne pas placer le projecteur dans l'eau ou ne pas le laisser se mouiller.

- Sinon cela peut causer un incendie ou des chocs électriques.

Faire attention à ne pas endommager le cordon d'alimentation.

- Ne pas endommager le cordon d'alimentation, ne pas le modifier, ne pas le placer sous des objets lourds, ne pas le chauffer, ne pas le placer près d'objets chauffants, ne pas le tordre, ne pas le plier ou le tirer excessivement et ne pas le rouler en boule.
- Si le cordon d'alimentation est endommagé, cela peut entraîner un incendie et des chocs électriques.
- Si le cordon d'alimentation est endommagé, le faire réparer par un centre technique agréé.

Ne pas placer le projecteur sur des matériaux comme du tapis ou du tissu éponge.

- Cela peut provoquer une surchauffe du projecteur, pouvant entraîner des brûlures, un incendie ou endommager le projecteur.

Ne pas placer des récipients de liquide sur le projecteur.

- Si de l'eau se renverse sur le projecteur ou pénètre dans celui-ci, il y aura risque d'incendie ou d'électrocution.
- Si de l'eau entre à l'intérieur du projecteur, entrer en contact avec un centre technique agréé.

Ne pas mettre d'objets étrangers dans le projecteur.

- Ne pas insérer d'objets métalliques ou inflammables dans les orifices de ventilation ou les faire tomber sur le projecteur, car cela peut causer un incendie ou des chocs électriques.

Précautions de sécurité

Veiller à ce que les bornes + et – des piles n'entrent pas en contact avec des objets métalliques tels que colliers ou épingles à cheveux.

- Sinon, les piles risquent de fuir, de surchauffer, d'exploser ou de prendre feu.
- Ranger les piles dans un sac en plastique, et ne pas les ranger à proximité d'objets métalliques.

Pendant un orage, ne pas toucher le projecteur ou le câble.

- Il y a risque d'électrocution.

Ne pas utiliser l'appareil dans un bain ou une douche.

- Il y a risque d'incendie ou d'électrocution.

Veillez à ce que le faisceau lumineux n'éclaire pas directement votre peau pendant que vous utilisez le projecteur.

- Une lumière intense est émise par l'objectif du projecteur. Si vous vous placez dans ce faisceau lumineux, celui-ci risquera de vous blesser ou de vous abîmer la peau.

Ne pas regarder directement dans l'objectif pendant que le projecteur fonctionne.

- Une lumière intense est émise par l'objectif du projecteur. Si l'on regarde directement dans cette lumière, elle risque de causer des blessures et de graves lésions aux yeux.
- Veiller particulièrement à ce que les enfants ne regardent pas dans l'objectif. En outre, éteindre le projecteur si on le laisse sans surveillance.

Ne pas placer les mains ou autres objets près de l'orifice de sortie d'air.

- De l'air chaud sort par l'orifice de sortie d'air. Ne pas placer les mains, le visage ou d'autres objets qui ne peuvent résister à la chaleur près de cette sortie d'air [laisser un espace d'au moins 50 cm], sinon des brûlures ou des dommages risqueraient de s'ensuivre.

Le remplacement de la lampe ne doit être effectué que par un technicien qualifié.

- La lampe a une pression interne élevée. Si elle est manipulée incorrectement, une explosion peut s'ensuivre.
- La lampe peut être facilement endommagée si elle est heurtée contre des objets durs ou si on la laisse tomber et des blessures et des mauvais fonctionnements peuvent s'ensuivre.

Lors du remplacement de la lampe, la laisser refroidir pendant au moins une heure avant de la manipuler.

- Le couvercle de la lampe devient très chaud, et on risque de se brûler si on le touche.

Avant de remplacer la lampe, veiller à débrancher la fiche du cordon d'alimentation de la prise de courant.

- Il y a risque d'électrocution ou d'explosion.

Ne pas laisser des enfants ou des animaux domestiques toucher la télécommande.

- Après avoir utilisé la télécommande, la ranger hors de portée des enfants ou des animaux domestiques.

MISES EN GARDE

Ne pas obstruer les orifices d'entrée et de sortie d'air.

- Cela risque de faire surchauffer le projecteur, et causer un incendie ou endommager le projecteur.
- Ne pas installer le projecteur dans des endroits étroits, mal ventilés tels que des placards ou des étagères.
- Ne pas placer le projecteur sur des tissus ou du papier, ces matériaux peuvent être aspirés dans l'orifice d'entrée d'air.

Ne pas installer le projecteur dans des endroits humides ou poussiéreux ou dans des endroits où le projecteur peut entrer en contact avec des fumées grasses ou de la vapeur.

- L'utilisation du projecteur dans de telles conditions peut causer un incendie, des chocs électriques ou une détérioration du boîtier en plastique. Une détérioration du plastique risquerait en effet d'entraîner une chute du projecteur en cas d'installation au plafond.

Ne pas utiliser le projecteur à l'air libre.

- Ce projecteur a été conçu pour une utilisation en intérieur.

Ne pas installer le projecteur dans un environnement à haute température, tel qu'à proximité d'un chauffage ou en plein soleil.

- Sinon cela peut causer un incendie, un dysfonctionnement ou une détérioration du plastique.

Pour débrancher le cordon d'alimentation, tenir la fiche et non pas le cordon.

- Si le cordon d'alimentation est tiré, le cordon sera endommagé et cela peut causer un incendie, des courts-circuits ou des chocs électriques sérieux.

Débrancher toujours tous les câbles avant de déplacer le projecteur.

- Le fait de déplacer le projecteur avec des câbles branchés peut endommager les câbles, ce qui pourrait causer un incendie ou des chocs électriques.

Ne pas placer d'objets lourds sur le projecteur.

- Cela peut déséquilibrer le projecteur et le faire tomber, ce qui peut entraîner des dommages ou des blessures.

Ne pas court-circuiter, chauffer ou démonter les piles, et ne pas les mettre dans l'eau ou dans le feu.

- Si l'on utilise des piles différentes ou si elles ont été insérées de manière incorrecte, cela peut causer une surchauffe, une fuite, une explosion ou un incendie, et provoquer ainsi des dommages ou blessures.

Lorsqu'on insère les piles, veiller à ce que les polarités (+ et -) soient bien respectées.

- Si l'on insère les piles incorrectement, elles risquent d'exploser ou de fuir, ce qui peut causer un incendie, des blessures ou une contamination du logement des piles et de la zone environnante.

Utiliser uniquement les piles spécifiées.

- Si l'on insère des piles d'un type différent, elles risquent d'exploser ou de fuir, ce qui peut causer un incendie, des blessures ou une contamination du logement des piles et de la zone environnante.

Retirer les piles usées de la télécommande au plus vite.

- Si vous laissez des piles usagées dans la télécommande pendant une longue période, cela risque de provoquer des fuites, une hausse anormale de la température interne ou une explosion.

Si vous n'utilisez pas le projecteur pendant une longue période de temps, débrancher la fiche du cordon d'alimentation de la prise de courant, et retirer les piles de la télécommande.

- Si de la poussière s'accumule sur la fiche du cordon d'alimentation, l'humidité créée pourrait endommager l'isolation, et provoquer un incendie.
- Le fait de laisser des piles à l'intérieur de la télécommande pourrait causer une détérioration de l'isolation, des fuites de courant ou même une explosion, ce qui pourrait entraîner un incendie.

Nous faisons tous les efforts possibles afin de préserver l'environnement. Prière de rapporter l'appareil, s'il n'est pas réparable, à votre revendeur ou à un centre de recyclage.

Ne pas peser de tout son poids sur ce projecteur.

- On risque de tomber ou de casser l'appareil, ce qui peut causer des blessures.
- Veiller tout particulièrement à ce que les enfants ne se tiennent pas debout ou ne s'asseyent pas sur le projecteur.

Débrancher la fiche du cordon d'alimentation de la prise de courant comme mesure de sécurité avant d'effectuer tout nettoyage.

- Sinon cela peut causer des chocs électriques.

Si la lampe s'est cassée, ventiler immédiatement la pièce. Ne pas toucher ni approcher le visage des morceaux cassés.

- Le non respect de cette consigne peut entraîner l'absorption du gaz par l'utilisateur. Ce gaz se dégage lorsque la lampe est cassée et il contient presque autant de mercure qu'une lampe fluorescente, de plus les morceaux cassés peuvent provoquer des blessures.
- Si vous pensez avoir inhalé du gaz ou que du gaz a pénétré dans votre bouche ou dans vos yeux, contactez un médecin immédiatement.
- S'adresser au revendeur pour le remplacement de la lampe et l'inspection de l'intérieur du projecteur.

Demander à un centre technique agréé de nettoyer l'intérieur du projecteur au moins une fois par an.

- S'il n'est pas nettoyé et que de la poussière s'accumule à l'intérieur du projecteur, cela peut causer un incendie ou des problèmes de fonctionnement.
- Il est recommandé de nettoyer l'intérieur du projecteur avant l'arrivée de la saison humide. Demander au centre technique agréé le plus proche de nettoyer le projecteur lorsque cela est requis. Se renseigner auprès du centre technique agréé pour le coût du nettoyage.

Précautions lors du transport

Ne pas soumettre le projecteur à des vibrations ou des chocs excessifs.

- L'objectif du projecteur doit être manipulé avec soin.
- Placer le couvercle sur l'objectif lors du transport du projecteur.

Lors du transport du projecteur, bien le tenir par le bas.

- Ne pas tenir le projecteur par les pieds de réglage ou le couvercle supérieur pour le déplacer car cela pourrait l'endommager.

Précautions lors de l'installation

Éviter de l'installer dans les endroits sujets à des vibrations ou à des chocs.

- Les pièces internes peuvent être endommagées, ce qui peut causer des pannes ou des accidents.

Éviter d'installer le projecteur à des endroits sujets à des changements de température brusques, à proximité d'un climatiseur ou d'un matériel d'éclairage.

- La durée de vie de la lampe risquerait d'être réduite, ou le projecteur risquerait de s'éteindre. Voir « Indicateur TEMP » à la page 39.

Précautions de sécurité

Si le projecteur est installé au plafond, demander à un technicien qualifié de faire tous les travaux d'installation.

- Il faut acheter le kit d'installation séparé (numéro de modèle. En outre, tous les travaux d'installation doivent être exécutés uniquement par un technicien qualifié.
- Voir « Protections du support de montage au plafond » à la page 61 pour plus de détails à propos de l'installation du **Câble de sécurité**.

Ne pas installer le projecteur près de lignes d'alimentation électrique à haute tension ou de moteurs.

- Le projecteur peut être soumis à des interférences électromagnétiques.

Si l'on utilise ce projecteur à un endroit élevé (1 400 - 2 700 m), réglez MONTAGNE sur OUI. Voir « MONTAGNE » à la page 35.

- Le non-respect de ces consignes peut entraîner un dysfonctionnement ou peut raccourcir la durée de vie de la lampe ou d'autres composants.

Précautions lors de l'utilisation

Afin d'obtenir la meilleure qualité d'image

- Fermer les rideaux ou les volets de toutes les fenêtres et éteindre les lampes fluorescentes situées à proximité de l'écran afin que la lumière extérieure ou la lumière des lampes intérieures n'éclaire pas l'écran.

Ne pas toucher aux surfaces de l'objectif ou du verre avant avec les mains nues.

- Si la surface de l'objectif est salie par des empreintes digitales ou autre, celles-ci seraient agrandies et projetées sur l'écran. De plus, refermer le **Couvercle du panneau avant** lorsque le projecteur n'est pas utilisé.

Affichage à cristaux liquides

- Ne pas projeter la même image pendant une longue durée, car elle risquerait de former une après-image sur l'affichage à cristaux liquides.
- L'affichage à cristaux liquides du projecteur a été fabriqué en utilisant une technologie de haute précision afin d'offrir une image très détaillée. Il est possible que parfois quelques pixels figés apparaissent sur l'écran sous forme de points fixes bleus, verts ou rouges. Il est alors recommandé d'éteindre le projecteur puis de le rallumer environ 1 heure après. Bien noter que ceci n'affecte pas le bon fonctionnement de votre LCD.

Ce projecteur est équipé d'une lampe au mercure sous haute pression, dont les principales caractéristiques sont:

- La luminosité de la lampe dépend de sa durée d'utilisation.
- Les chocs et éclats risquent d'endommager ou de réduire la durée de vie de la lampe.
- Un risque d'explosion réduit existe pendant la durée d'utilisation du projecteur.
- La lampe risque d'exploser si son utilisation dépasse la durée recommandée de remplacement de la lampe.
- La durée de vie de la lampe dépend de ses caractéristiques, des conditions d'utilisation et de l'environnement d'installation. Par exemple, une utilisation en continu du projecteur pendant plus de 10 heures, ou des fréquente mises en marche/arrêt risquent d'avoir un effet particulièrement négatif sur la durée de vie de la lampe.

Composants optiques

- En cas d'utilisation quotidienne du projecteur pendant 6 heures ou plus, les composants optiques devront être remplacés en moins d'1 an.

Sécurité

Suivez les mesures de sécurité lors de l'utilisation du projecteur pour prévenir les éventuels incidents suivants.

- La fuite d'informations enregistrées personnelles.
- Les activités malhonnêtes accomplies par une tierce partie non digne de confiance.
- L'utilisation du projecteur par une tierce partie non de confiance (pour éviter une telle situation, vous pouvez verrouiller le projecteur).

Instructions de sécurité

- Modifiez fréquemment votre mot de passe.
- N'utilisez pas un mot de passe facile à deviner.
- Lemot de passe ne vous sera jamais demandé par le Centre de dépannage agréé.
- Ne révélez jamais votre mot de passe.

Remplacement de l'unité de la lampe

■ Avant de remplacer le l'Unité de la lampe



- Eteindre l'**ALIMENTATION PRINCIPALE** puis débrancher le cordon principal de la prise du secteur.
- Attendez au moins 1 heure que la lampe et les composants contigus soient suffisamment froids.
- Préparer un tournevis cruciforme.
- Contacter un centre de service après-vente agréé pour acheter une **Unité de la lampe** (ET-LAB80) de rechange.
- En cas d'installation du projecteur au plafond, ne jamais travailler directement dessous et éloigner le visage du projecteur.

REMARQUE:

- Avant de remplacer la lampe, la laisser refroidir pour éviter les risques de brûlures, les dommages et autres dangers.
- Ne pas essayer de la remplacer par une lampe non autorisée.

■ Délai de remplacement de l'Unité de la lampe

L'**Unité de la lampe** est un consommable et sa luminosité diminue avec la durée d'utilisation. L'indicateur **LAMP** vous informera des délais de remplacement de 2 800 heures, et coupera le projecteur à 3 000 heures. Ces valeurs sont fournies avant tout à titre indicatif et peuvent être réduites en fonction des conditions d'utilisation réelles, des caractéristiques de l'**Unité de la lampe**, de la température ambiante, etc. Vous pouvez vérifier la durée d'utilisation avec la fonction **DURÉE DE LA LAMPE** dans le menu **OPTION**.

Indication	A l'écran 	Indicateur LAMP 
Plus de 2 800 heures	« LAMPE DE REMPLACEMENT » est affiché en haut à gauche de l'écran pendant 30 secondes.	
Plus de 3 000 heures	« LAMPE DE REMPLACEMENT » s'affiche en haut à gauche de l'écran, et attend votre réponse. Pour le supprimer immédiatement, appuyer sur n'importe quelle touche.	S'allume en ROUGE .

REMARQUE:

- Les durées indiquées, de 2 800 et 3 000 heures, sont des estimations basées sur certaines conditions et ne représentent en aucun cas des durées garanties.
- Pour plus d'informations à propos des caractéristiques de l'**Unité de la lampe**, telles que la durée de garantie, se reporter aux instructions fournies avec l'**Unité de la lampe**.

Remplacement de l'unité de la lampe

■ Procédure de remplacement

● Retirer et remplacer la lampe

1. Dévisser à l'aide d'un tournevis cruciforme les 2 vis de fixation du **Couvercle de la lampe** à l'arrière du projecteur jusqu'à ce qu'elles tournent librement, puis retirer le **Couvercle de la lampe**.

Couvercle de la l'Unité de la lampe

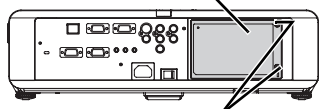

Vis de fixation du couvercle de l'Unité de la lampe

2. Dévisser les 2 vis de fixation de l'**Unité de la lampe** à l'aide du tournevis cruciforme.
3. Tenir l'**Unité de la lampe** par la poignée puis débloquer le verrou de la lampe.
4. Extraire doucement l'**Unité de la lampe** du projecteur.

Vis de fixation de l'Unité de la lampe

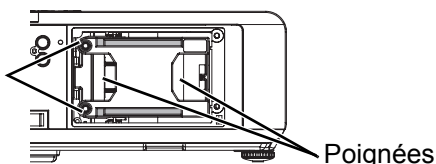

Poignées

5. Remettre la nouvelle **Unité de la lampe** à son emplacement.

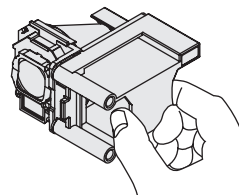

6. Appuyer sur l'**Unité de la lampe** jusqu'à ce qu'elle s'encliquète et s'assurer qu'elle soit bien fixée en place.
7. Resserrer les 2 vis de fixation de l'**Unité de la lampe** à l'aide du tournevis cruciforme.

Vis de fixation de l'Unité de la lampe

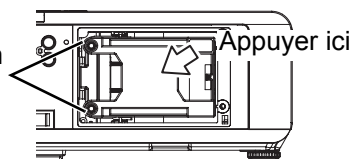

8. Remettre en place le **Couvercle de la lampe** puis resserrer les 2 vis de fixation du **Couvercle de la lampe** à l'aide du tournevis cruciforme.

- **DURÉE DE LA LAMPE** sera automatiquement réinitialisée à "0".

Protections du support de montage au plafond

Bien que le projecteur ainsi que le support d'installation au plafond aient été conçus pour répondre aux plus hauts critères de sécurité, il est néanmoins recommandé d'installer et d'attacher au bas du projecteur le câble de sécurité fourni, en cas d'installation au plafond, afin de garantir une sécurité optimale.

REMARQUE:

- Pendant toute la durée de la garantie, le fabricant ne pourrait en aucun cas, être tenu pour responsable de tout danger ou dommages causés soit par l'utilisation d'un support au plafond non conforme, acheté auprès de distributeurs non autorisés, soit par ses conditions d'utilisation.
- N'utiliser qu'un tournevis dynamométrique durant l'installation, et ne jamais utiliser un tournevis électrique ou un tournevis à frapper.
- Les travaux d'installation du support au plafond ne devront être effectués que par un technicien qualifié.
- Démonter au plus vite tout support au plafond qui ne sera plus utilisé.

NOTE:

This product contains a CR Coin Cell Lithium Battery which contains Perchlorate Material - special handling may apply.

See www.dtsc.ca.gov/hazardouswaste/perchlorate.

Panasonic[®]

Projectors

Panasonic Projector Systems Company

Unit of Panasonic Corporation of North America

One Panasonic Way, Secaucus, NJ 07094
(201) 392 - 6591

Technical Support:

(888) 411 - 1996

FAX: (201) 348 - 7523

E-Mail: projectorsupport@us.panasonic.com

© 2008 Matsushita Electric Industrial Co., Ltd. All Rights Reserved.

Printed in Japan
S0308-1048B