



DIGITAL PIANO
PIANO NUMÉRIQUE
PIANO DIGITAL

P-S500

Owner's Manual

Mode d'emploi

Manual de instrucciones

Before using the instrument, be sure to read "PRECAUTIONS" on pages 4-5.

Avant d'utiliser l'instrument, lisez attentivement la section « PRÉCAUTIONS D'USAGE » aux pages 4 et 5.

Antes de utilizar el instrumento, lea las "PRECAUCIONES", en las páginas 4-5.



Smart Device App "Smart Pianist" (page 20)

You can get even more enjoyment out of this instrument—with additional functions and highly intuitive controls—by connecting to the "Smart Pianist" smart device app.

Application « Smart Pianist » pour appareil intelligent (page 20)

Profitez davantage encore de l'instrument, grâce à des fonctions supplémentaires et des commandes extrêmement intuitives, en vous connectant à l'application « Smart Pianist » pour appareil intelligent.

Aplicación para smartphones o tablets "Smart Pianist" (página 20)

Puede disfrutar aun más este instrumento si lo conecta a la aplicación "Smart Pianist" para smartphones o tablets, que proporciona más funciones y controles muy intuitivos.

English
Français
Español



EN FR ES

FCC INFORMATION (U.S.A.)

1. IMPORTANT NOTICE: DO NOT MODIFY THIS UNIT!

This product, when installed as indicated in the instructions contained in this manual, meets FCC requirements. Modifications not expressly approved by Yamaha may void your authority, granted by the FCC, to use the product.

2. IMPORTANT:

When connecting this product to accessories and/or another product use only high quality shielded cables. Cable/s supplied with this product MUST be used. Follow all installation instructions. Failure to follow instructions could void your FCC authorization to use this product in the USA.

3. NOTE:

This product has been tested and found to comply with the requirements listed in FCC Regulations, Part 15 for Class "B" digital devices. Compliance with these requirements provides a reasonable level of assurance that your use of this product in a residential environment will not result in harmful interference with other electronic devices. This equipment generates/uses radio frequencies and, if not installed and used according to the instructions found in the users manual, may cause interference harmful to the operation of other electronic

devices. Compliance with FCC regulations does not guarantee that interference will not occur in all installations. If this product is found to be the source of interference, which can be determined by turning the unit "OFF" and "ON", please try to eliminate the problem by using one of the following measures:

Relocate either this product or the device that is being affected by the interference.

Utilize power outlets that are on different branch (circuit breaker or fuse) circuits or install AC line filter/s.

In the case of radio or TV interference, relocate/reorient the antenna. If the antenna lead-in is 300 ohm ribbon lead, change the lead-in to co-axial type cable.

If these corrective measures do not produce satisfactory results, please contact the local retailer authorized to distribute this type of product. If you can not locate the appropriate retailer, please contact Yamaha Corporation of America, Electronic Service Division, 6600 Orangethorpe Ave, Buena Park, CA90620

The above statements apply ONLY to those products distributed by Yamaha Corporation of America or its subsidiaries.

* This applies only to products distributed by Yamaha Corporation of America.

(class B)

COMPLIANCE INFORMATION STATEMENT (Supplier's declaration of conformity procedure)

Responsible Party : Yamaha Corporation of America

Address : 6600 Orangethorpe Ave., Buena Park, Calif. 90620

Telephone : 714-522-9011

Type of Equipment : Digital Piano

Model Name : P-S500

This device complies with Part 15 of the FCC Rules.

Operation is subject to the following two conditions:

- 1) this device may not cause harmful interference, and
- 2) this device must accept any interference received including interference that may cause undesired operation.

* This applies only to products distributed by Yamaha Corporation of America.

(FCC SDoC)

The model number, serial number, power requirements, etc., may be found on or near the name plate, which is at the bottom of the unit. You should note this serial number in the space provided below and retain this manual as a permanent record of your purchase to aid identification in the event of theft.

Model No.

Serial No.

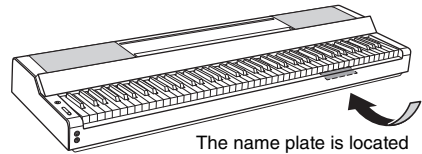

The name plate is located on the bottom of the unit.

(bottom_en_01)

For the AC adaptor

CAUTION

RISK OF ELECTRIC SHOCK
DO NOT OPEN

CAUTION: TO REDUCE THE RISK OF ELECTRIC SHOCK, DO NOT REMOVE COVER (OR BACK). NO USER-SERVICEABLE PARTS INSIDE. REFER SERVICING TO QUALIFIED SERVICE PERSONNEL.

Explanation of Graphical Symbols

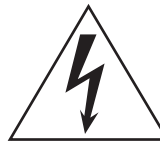

The lightning flash with arrowhead symbol within an equilateral triangle is intended to alert the user to the presence of uninsulated “dangerous voltage” within the product’s enclosure that may be of sufficient magnitude to constitute a risk of electric shock to persons.



The exclamation point within an equilateral triangle is intended to alert the user to the presence of important operating and maintenance (servicing) instructions in the literature accompanying the product.

IMPORTANT SAFETY INSTRUCTIONS

- 1 Read these instructions.
- 2 Keep these instructions.
- 3 Heed all warnings.
- 4 Follow all instructions.
- 5 Do not use this apparatus near water.
- 6 Clean only with dry cloth.
- 7 Do not block any ventilation openings. Install in accordance with the manufacturer’s instructions.
- 8 Do not install near any heat sources such as radiators, heat registers, stoves, or other apparatus (including amplifiers) that produce heat.
- 9 Do not defeat the safety purpose of the polarized or grounding-type plug. A polarized plug has two blades with one wider than the other. A grounding type plug has two blades and a third grounding prong. The wide blade or the third prong are provided for your safety. If the provided plug does not fit into your outlet, consult an electrician for replacement of the obsolete outlet.
- 10 Protect the power cord from being walked on or pinched particularly at plugs, convenience receptacles, and the point where they exit from the apparatus.
- 11 Only use attachments/accessories specified by the manufacturer.
- 12 Use only with the cart, stand, tripod, bracket, or table specified by the manufacturer, or sold with the apparatus. When a cart is used, use caution when moving the cart/apparatus combination to avoid injury from tip-over.
- 13 Unplug this apparatus during lightning storms or when unused for long periods of time.
- 14 Refer all servicing to qualified service personnel. Servicing is required when the apparatus has been damaged in any way, such as power-supply cord or plug is damaged, liquid has been spilled or objects have fallen into the apparatus, the apparatus has been exposed to rain or moisture, does not operate normally, or has been dropped.



WARNING

TO REDUCE THE RISK OF FIRE OR ELECTRIC SHOCK, DO NOT EXPOSE THIS APPARATUS TO RAIN OR MOISTURE.

(UL60065_03)

PRECAUTIONS

PLEASE READ CAREFULLY BEFORE PROCEEDING

Please keep this manual in a safe and handy place for future reference.

For the AC adaptor



WARNING

- This AC adaptor is designed for use with only Yamaha electronic instruments. Do not use for any other purpose.
- Indoor use only. Do not use in any wet environments.



CAUTION

- When setting up, make sure that the AC outlet is easily accessible. If some trouble or malfunction occurs, immediately turn off the power switch of the instrument and disconnect the AC adaptor from the outlet. When the AC adaptor is connected to the AC outlet, keep in mind that electricity is flowing at the minimum level, even if the power switch is turned off. When you are not using the instrument for a long time, make sure to unplug the power cord from the wall AC outlet.

For the instrument



WARNING

Always follow the basic precautions listed below to avoid the possibility of serious injury or even death from electrical shock, short-circuiting, damages, fire or other hazards. These precautions include, but are not limited to, the following:

Power supply/AC adaptor

- Do not place the power cord near heat sources such as heaters or radiators. Also, do not excessively bend or otherwise damage the cord, or place heavy objects on it.
- Only use the voltage specified as correct for the instrument. The required voltage is printed on the name plate of the instrument.
- Use the specified adaptor (page 35) only. Using the wrong adaptor can result in damage to the instrument or overheating.
- Use only the supplied power cord/plug.
- Check the electric plug periodically and remove any dirt or dust which may have accumulated on it.

Do not open

- This instrument contains no user-serviceable parts. Do not open the instrument or attempt to disassemble or modify the internal components in any way. If it should appear to be malfunctioning, discontinue use immediately and have it inspected by qualified Yamaha service personnel.

Water warning

- Do not expose the instrument to rain, use it near water or in damp or wet conditions, or place on it any containers (such as vases, bottles or glasses) containing liquids which might spill into any openings. If any liquid such as water seeps into the instrument, turn off the power immediately and unplug the power cord from the AC outlet. Then have the instrument inspected by qualified Yamaha service personnel.
- Never insert or remove an electric plug with wet hands.

Fire warning

- Do not put burning items, such as candles, on the unit. A burning item may fall over and cause a fire.

If you notice any abnormality

- When one of the following problems occur, immediately turn off the power switch and disconnect the electric plug from the outlet. Then have the device inspected by Yamaha service personnel.
 - The power cord or plug becomes frayed or damaged.
 - It emits unusual smells or smoke.
 - Some object has been dropped into the instrument.
 - There is a sudden loss of sound during use of the instrument.
 - If any cracks or breakages exist on the instrument.



CAUTION

Always follow the basic precautions listed below to avoid the possibility of physical injury to you or others, or damage to the instrument or other property. These precautions include, but are not limited to, the following:

Power supply/AC adaptor

- Do not connect the instrument to an electrical outlet using a multiple-connector. Doing so can result in lower sound quality, or possibly cause overheating in the outlet.
- When removing the electric plug from the instrument or an outlet, always hold the plug itself and not the cord. Pulling by the cord can damage it.
- Remove the electric plug from the outlet when the instrument is not to be used for extended periods of time, or during electrical storms.

Location

- Do not place the instrument in an unstable position where it might accidentally fall over.
- Do not go near the instrument during an earthquake. Strong shaking during an earthquake could cause the instrument to move or tip over, resulting in damage to the instrument or its parts, and possibly causing injury.
- When transporting or moving the instrument, always use two or more people. Attempting to lift the instrument by yourself may damage your back, result in other injury, or cause damage to the instrument itself.
- Before moving the instrument, remove all connected cables, to prevent damage to the cables or injury to anyone who might trip over them.
- When moving the instrument, hold the bottom of the instrument. Holding the niche where the connectors are located may damage the connectors or the instrument, and result in injury.
- When setting up the product, make sure that the AC outlet you are using is easily accessible. If some trouble or malfunction occurs, immediately turn off the power switch and disconnect the plug from the outlet. Even when the power switch is turned off, electricity is still flowing to the product at the minimum level. When you are not using the product for a long time, make sure to unplug the power cord from the wall AC outlet.
- Use only the stand specified for the instrument (page 17). When attaching it, use the provided screws only. Failure to do so could cause damage to the internal components or result in the instrument falling over.
- Do not lean the instrument up against a wall or lay it with the connectors side down. The instrument may fall over and result in damage or cause injury. Make sure to put the instrument horizontally on a desk or use the stand specified for the instrument (page 17).

Connections

- Before connecting the instrument to other electronic components, turn off the power for all components. Before turning the power on or off for all components, set all volume levels to minimum.
- Be sure to set the volumes of all components at their minimum levels and gradually raise the volume controls while playing the instrument to set the desired listening level.

Handling

- Do not insert a finger or hand in any gaps on the instrument.
- Never insert or drop paper, metallic, or other objects into the gaps on the panel or keyboard. This could cause physical injury to you or others, damage to the instrument or other property, or operational failure.
- Do not rest your weight on, or place heavy objects on the instrument, and do not use excessive force on the buttons, switches, music rest or connectors.
- Do not use the instrument/device or headphones for a long period of time at a high or uncomfortable volume level, since this can cause permanent hearing loss. If you experience any hearing loss or ringing in the ears, consult a physician.

Yamaha cannot be held responsible for damage caused by improper use or modifications to the instrument, or data that is lost or destroyed.

Always turn the power off when the instrument is not in use.

Even when the [𐄂] (Standby/On) switch is in standby status (power lamp is off), electricity is still flowing to the instrument at the minimum level.

When you are not using the instrument for a long time, make sure you unplug the power cord from the wall AC outlet.

NOTICE

To avoid the possibility of malfunction/ damage to the product, damage to data, or damage to other property, follow the notices below.

■ Handling

- Do not connect this product to a public Wi-Fi and/or Internet service directly. Only connect this product to the Internet through a router with strong password protections. Consult your router manufacturer for information on optimum security practices.
- Do not use the instrument in the vicinity of a TV, radio, stereo equipment, mobile phone, or other electric devices. Otherwise, the instrument, TV, or radio may generate noise. When you use the instrument along with an application on your smart device such as a smartphone or tablet, we recommend that you set Wi-Fi to on after setting “Airplane Mode” to on on that device in order to avoid noise caused by communication.
- Do not expose the instrument to excessive dust or vibrations, or extreme cold or heat (such as in direct sunlight, near a heater, or in a car during the day) to prevent the possibility of panel disfiguration, damage to the internal components or unstable operation. (Verified operating temperature range: 5° – 40°C, or 41° – 104°F)
- Do not place vinyl, plastic or rubber objects on the instrument, since this might discolor the panel or keyboard.

■ Maintenance

- When cleaning the instrument, use a soft and dry/slightly damp cloth. Do not use paint thinners, solvents, alcohol, cleaning fluids, or chemical-impregnated wiping cloths.

■ Saving data

- Some of the data of this instrument (page 29) are retained when the power is turned off.
To protect against data loss due to some failure, and operation mistake, etc., save your important data to the smart device application “Smart Pianist.” You can back up the data and setting of this instrument to “Smart Pianist” as a backup file.

Information

■ About copyrights

- Copying of the commercially available musical data including but not limited to MIDI data and/or audio data is strictly prohibited except for your personal use.
- This product incorporates and bundles contents in which Yamaha owns copyrights or with respect to which Yamaha has license to use others' copyrights. Due to copyright laws and other relevant laws, you are NOT allowed to distribute media in which these contents are saved or recorded and remain virtually the same or very similar to those in the product.
 - * The contents described above include a computer program, Accompaniment Style data, MIDI data, WAVE data, voice recording data, a score, score data, etc.
 - * You are allowed to distribute medium in which your performance or music production using these contents is recorded, and the permission of Yamaha Corporation is not required in such cases.

■ About functions/data bundled with the instrument

- Yamaha may from time to time update firmware of the product without notice for improvement in functions and usability. To take full advantage of this instrument, we recommend that you upgrade your instrument to the latest version. The latest firmware can be downloaded from the website below:
<https://download.yamaha.com/>
- Some of the preset songs have been edited for length or arrangement, and may not be exactly the same as the original.
- This device is capable of using various types/formats of music data by optimizing them to the proper format music data for use with the device in advance. As a result, this device may not play them back precisely as their producers or composers originally intended.

■ About this manual

- The illustrations and LCD screens as shown in this manual are for instructional purposes only, and may appear somewhat different from those on your instrument.
- The letters at the end of the model name (such as “B,” “WH”) indicate the color of the instrument. Since they simply indicate the appearance, these letters are omitted in this manual.
- Windows is a registered trademark of Microsoft® Corporation in the United States and other countries.
- Apple, iTunes, iPhone, iPad, iPod touch and Lightning are trademarks of Apple Inc., registered in the U.S. and other countries.
- Android and Google Play are trademarks of Google LLC.
- The company names and product names in this manual are the trademarks or registered trademarks of their respective companies.

Compatible formats for this instrument

■ GM2

“GM (General MIDI)” is one of the most common Voice allocation formats. “GM System Level 2” is a standard specification that enhances the original “GM” and improves Song data compatibility. It provides for increased polyphony, greater Voice selection, expanded Voice parameters, and integrated effect processing.

■ XG

XG is a major enhancement of the GM System Level 1 format, and was developed by Yamaha specifically to provide more Voices and variations, as well as greater expressive control over Voices and effects, and to ensure compatibility of data well into the future.

■ GS

GS was developed by the Roland Corporation. In the same way as Yamaha XG, GS is a major enhancement of the GM specifically to provide more Voices and Drum kits and their variations, as well as greater expressive control over Voices and effects.

■ XF

The Yamaha XF format enhances the SMF (Standard MIDI File) standard with greater functionality and open-ended expandability for the future. This instrument is capable of displaying lyrics when an XF file containing lyric data is played.

Thank you for purchasing this Yamaha Digital Piano!

This instrument gives you the pleasure of playing your favorite songs by yourself with the help of the Stream Lights feature. We recommend that you read this manual carefully so that you can fully take advantage of the advanced and convenient functions of the instrument. We also recommend that you keep this manual in a safe and handy place for future reference.

About the Manuals

This instrument has the following documents and instructional materials.

Included Documents



Owner's Manual (this book)

Explains how to use this instrument.

Online Materials (Downloadable from the web)



Data List

Contains lists of Voices and Styles, as well as MIDI-related information of this instrument.



Computer-related Operations

Includes instructions on connecting this instrument to a computer, and operations related to transmitting/receiving data.

To obtain these manuals, access the Yamaha Downloads, enter the model name for searching the desired files.

Yamaha Downloads

<https://download.yamaha.com/>

Included Accessories

- **Owner's Manual (this book) × 1**
- **Online Member Product Registration × 1**
- **AC adaptor × 1, Power cord × 1 (May not be included depending on your area. Check with your Yamaha dealer.)**
- **Music rest × 1**
- **Footswitch × 1**

Table of Contents

| | |
|--|-----------|
| PRECAUTIONS | 4 |
| NOTICE | 6 |
| Information | 6 |
| About the Manuals | 8 |
| Included Accessories | 8 |
| Main Features – A World of Piano Performance and Control with Smart Pianist – | 10 |
| Panel Controls and Terminals | 12 |
| Top Panel..... | 12 |
| Rear Panel | 13 |
| Starting Up | 14 |
| Turning the power on or off..... | 14 |
| Adjusting the Master Volume | 15 |
| Attaching the music rest..... | 16 |
| Using a pedal (footswitch) – [AUX PEDAL] jack | 17 |
| Using a pedal unit and keyboard stand (sold separately) – [PEDAL UNIT] jack | 17 |
| Using headphones – [PHONES] jacks | 19 |
| Playing with Smart Pianist | 20 |
| Installing Smart Pianist | 20 |
| Connecting with Smart Pianist | 20 |
| Playing the Instrument Stand-alone | 24 |
| Playing various musical instrument sounds (Voices) – [VOICE] | 24 |
| Playing a Style with the auto accompaniment – [STYLE]..... | 25 |
| Playing back a Song – [SONG] | 26 |
| Adjusting the tempo – [TEMPO] | 26 |
| Practice along with the Stream Lights by using the Guide function – [GUIDE] | 27 |
| Using the metronome – [METRONOME] | 27 |
| Make settings of various functions – [FUNCTION] | 28 |
| Restoring the factory-programmed settings (initializing)..... | 29 |
| Connecting to other devices | 30 |
| Connecting with a smart device for using an app | |
| – [iPad] terminal, [USB TO DEVICE] terminal, [USB TO HOST] terminal | 30 |
| Connecting to an external audio device – [AUX IN] jack, AUX OUT [R]/[L/L+R] jacks..... | 30 |
| Connecting a microphone – [MIC INPUT] jack | 31 |
| Connecting to a computer – [USB TO HOST] terminal..... | 32 |
| Transmitting/receiving audio data (USB Audio Interface function) | |
| – [iPad] terminal, [USB TO HOST] terminal | 33 |
| Troubleshooting | 34 |
| Specifications | 35 |
| Index | 37 |

Main Features

– A World of Piano Performance and Control with Smart Pianist –

Get more fun out of your piano with Smart Pianist

By using this instrument with the smart device app “Smart Pianist,” you can fully enjoy various functions, such as playing along with a favorite song, or performing with a band or ensemble. Try installing the app to your smart device and connect with this instrument to take advantage of those added features.

For details on the app and compatible devices, see the website below or search “Yamaha Smart Pianist” on a web search engine. For connection, refer to page 20.

<https://www.yamaha.com/kbdapps/>

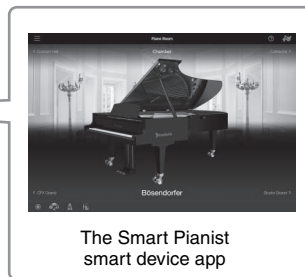
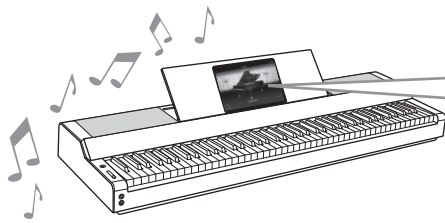

Play your favorite songs right away

A number of songs, including popular, classical and lesson songs, are pre-installed to this instrument. Smart Pianist allows you to view the music notation (score) of these songs. For people who have difficulty reading notation, the Stream Lights function (page 27) shows which key to play next. Just press the keys at the right time as indicated by the moving lights above the keys.

Moreover, by using the Guide function, you can practice at your own pace since Song playback pauses and waits for you to play the correct notes. It also allows you to practice by one-hand, or repeatedly practice a specified range of the song.

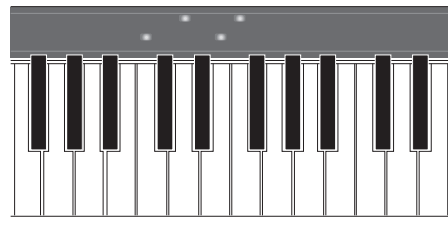
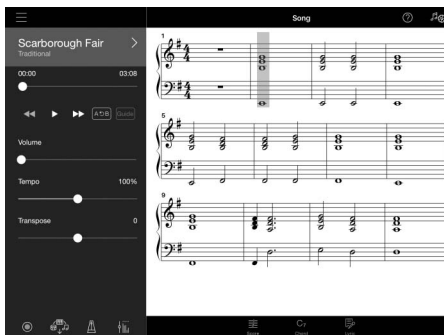

The app also includes an “Audio To Score” function, which automatically creates a piano accompaniment score from songs on your smart device. Even without a score, you can enjoy playing piano accompaniment to a song.

Enjoy backing band accompaniment and singing with your own performance

This instrument features a wide variety of instrumental Voices, including piano, organ, guitar, saxophone and more. It also allows you to layer two Voices, or play different Voices in the right- and left- hand sections. Moreover, the Style function provides dynamic backing band accompaniment, even when you're playing by yourself, and features a wide number of patterns in various genres to match your performance. You can even connect a microphone and sing along with your own performance—and has luxurious harmony functions that allow you to automatically create vocal chorus backing for yourself, even when you're singing alone.

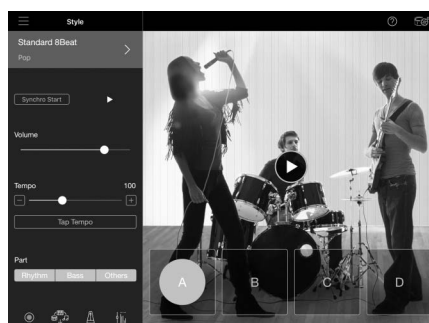
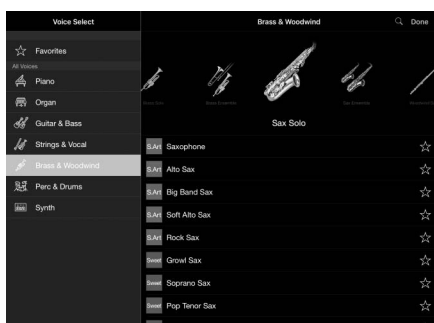

Playing with your favorite piano sound

The piano Voices have been created with samples of Yamaha's flagship CFX concert grand piano and the world renowned Bösendorfer* concert grand piano. On Smart Pianist, the Piano Room function reproduces the way sound echoes based on the environment (such as a concert hall), and the subtle changes in sound due to the opening or closing of the lid of a grand piano—letting you customize the piano sound to your exact liking.

*Bösendorfer is a subsidiary company of Yamaha.

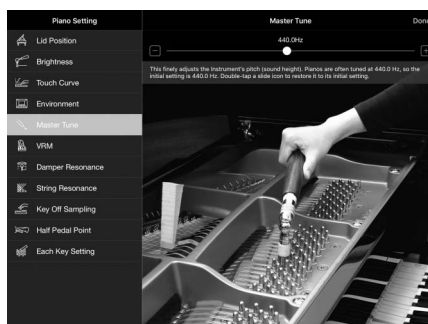
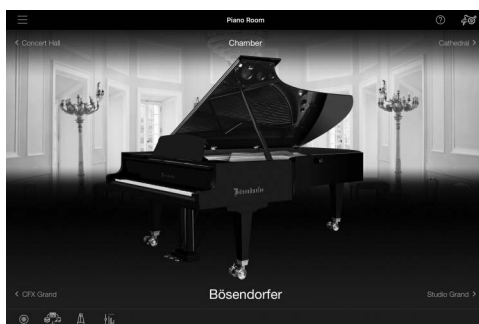

Using Smart Pianist gives you access to many more convenient and powerful functions—such as recording, adjusting volume balance among the keyboard parts/Song/Style, and transposing the pitch of the Song. (See page 36 for these additional functions.)

NOTE

All screen examples shown here have been captured from the app with the latest specifications as of the publishing date. The screens and the specifications may be updated for improvement.

Panel Controls and Terminals

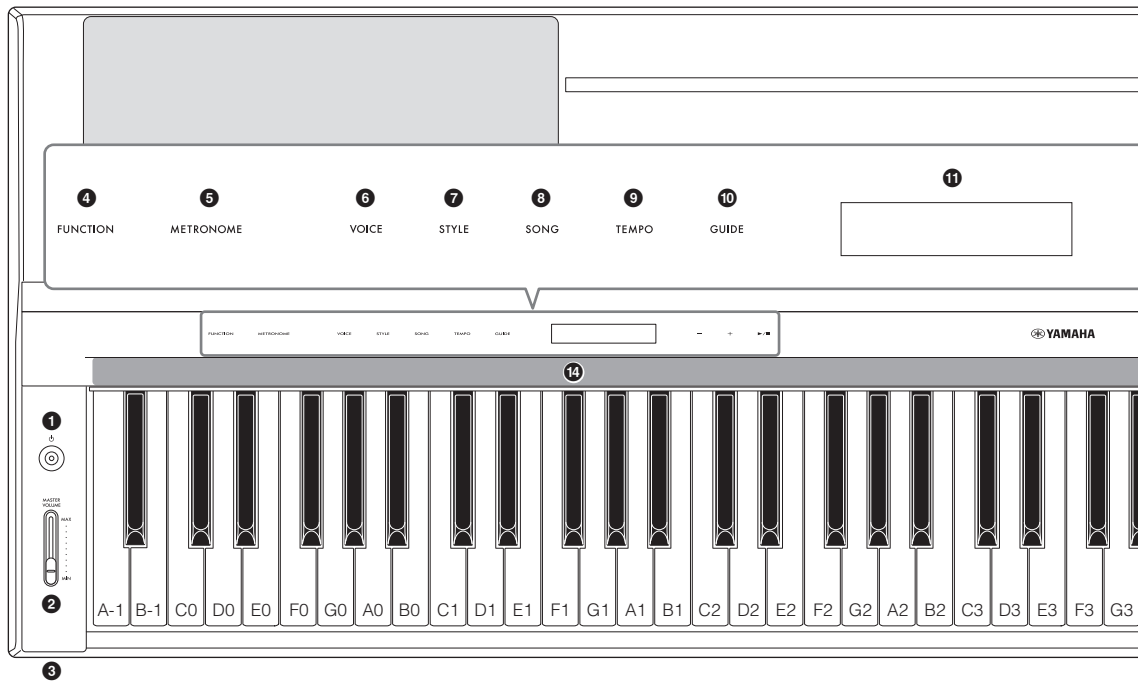

Top Panel

- 1** **[⏻] (Standby/On) switch (page 14)**
Turns on the instrument's power or sets to standby.
- 2** **[MASTER VOLUME] slider (page 15)**
Adjusts the overall volume.
- 3** **[PHONES] jacks (page 19)**
For connecting headphones. 
- 4** **[FUNCTION] button (page 28)**
Calls up the display for setting various functions, such as transpose and tuning.
- 5** **[METRONOME] button (page 27)**
Turns the metronome on or off.
- 6** **[VOICE] button (page 24)**
Calls up the display for selecting Voices.
- 7** **[STYLE] button (page 25)**
Calls up the display for selecting Styles.
- 8** **[SONG] button (page 26)**
Calls up the display for selecting Songs.
- 9** **[TEMPO] button (page 26)**
Calls up the display for adjusting tempo.
- 10** **[GUIDE] button (page 27)**
Calls up the display for setting the Guide function.
- 11** **Display**
Indicates the current instrument's setting.
- 12** **[-]/[+] buttons (page 24)**
For selecting a Voice or Style, or changing a parameter value such as tempo. Holding one of these buttons changes the value continuously. Pressing both [-] and [+] buttons simultaneously can reset the parameter to the default value.
- 13** **[▶/■] (Start/Stop) button (page 24)**
Starts or stops playback of the selected Song or Style.
- 14** **Stream Lights (page 27)**
Four lamps are embedded on top of each keys. These lamps light in succession in a descending pattern during Song playback to indicate the notes you should play and when you should play them.

The control buttons and display are shown when the power is turned on.

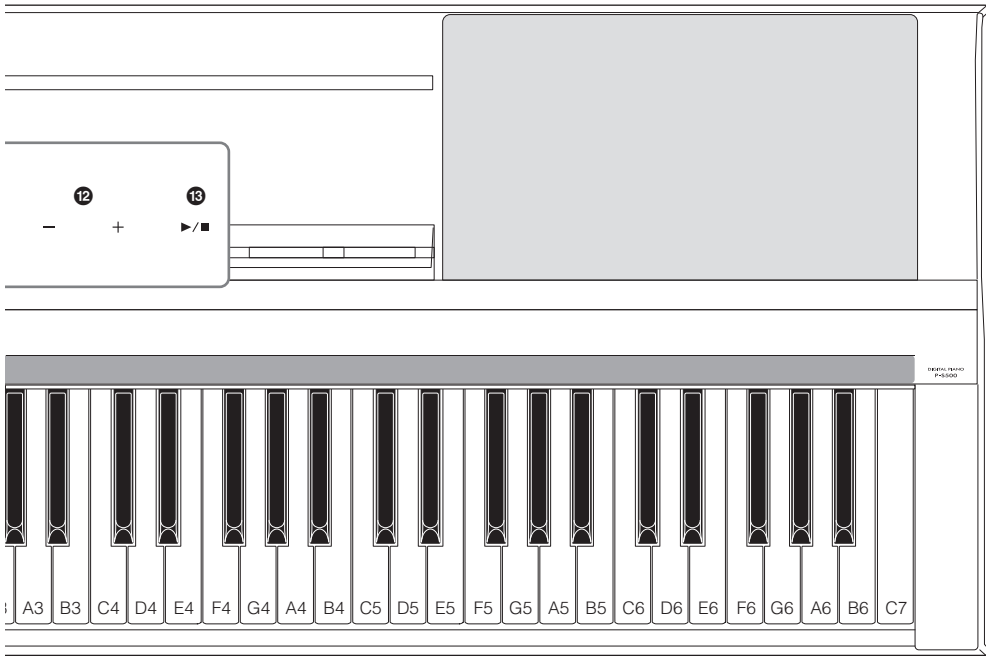

Rear Panel

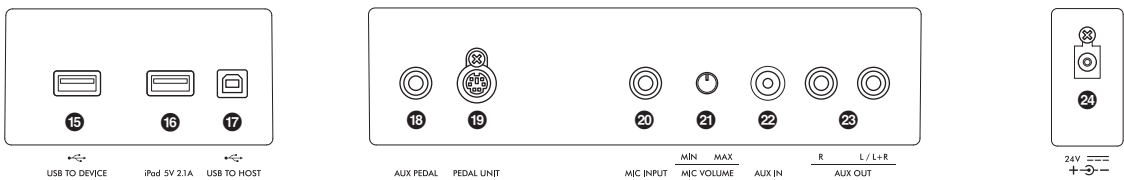

15 [USB TO DEVICE] terminal (page 22)

For connecting a USB wireless LAN adaptor (sold separately).

16 [iPod] terminal (pages 21, 33)

For connecting a smart device with a Lightning connector.

17 [USB TO HOST] terminal (pages 21, 32, 33)

For connecting a smart device with a USB Type-C connector or a computer.

18 [AUX PEDAL] jack (page 17)

For connecting the included footswitch or separately sold foot pedals.

19 [PEDAL UNIT] jack (page 17)

For connecting a separately sold pedal unit.

20 [MIC INPUT] jack (page 31)

For connecting a microphone.

21 [MIC VOLUME] knob (page 31)

For adjusting the input level of the [MIC INPUT] jack.

22 [AUX IN] jack (page 30)

For connecting an external audio device, such as a portable audio player. Audio playback by the connected device can be output from this instrument's speaker.

23 AUX OUT [R]/[L/L+R] jacks (page 31)

For connecting an audio device such as a speaker. The sound played on this instrument can be output from the connected external device's speaker.

24 DC IN jack (page 14)

For connecting the AC adaptor.

Starting Up

This section explains how to set up and start using your instrument. Setup is so simple, you can start playing right away.

Turning the power on or off

- 1 Connect the plugs of the AC adaptor and the power cord in the order shown in the illustration.

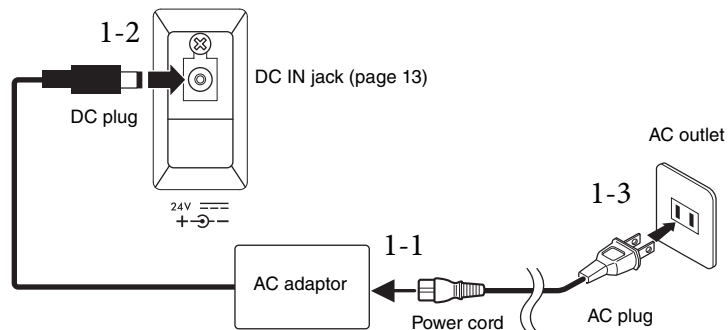

The shape of the plug and outlet differ depending on the particular locale.

⚠ WARNING

Use the specified AC adaptor (page 35) only. Using the wrong AC adaptor can result in damage to the instrument or overheating.

⚠ CAUTION

When setting up the product, make sure that the AC outlet you are using is easily accessible. If some trouble or malfunction occurs, immediately turn the power off and disconnect the plug from the outlet.

NOTE

When disconnecting the power cord/AC adaptor, first turn off the power, and then follow this procedure in reverse order.

- 2 Turn down the [MASTER VOLUME] slider to “MIN.”

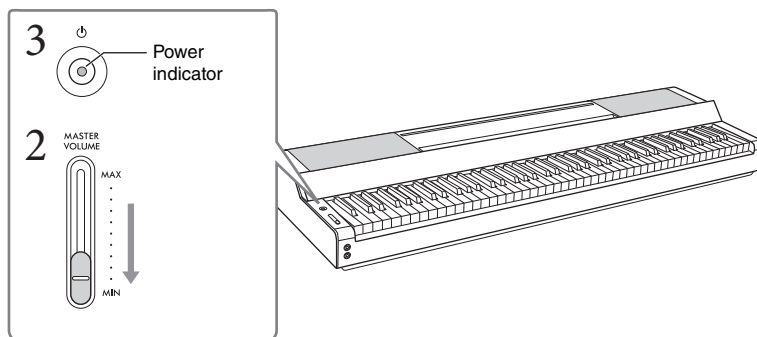

- 3 Press the [⏻] (Standby/On) switch to turn the power on.

The power indicator on the [⏻] (Standby/On) switch lights up, and the control buttons appear.

- 4 Adjust the volume.

Play the keyboard to produce sound and turn up the [MASTER VOLUME] slider slowly while you adjust the volume.

5 After you finish using the instrument, turn off the power by pressing the [⏻] (Standby/On) switch for a second.

The display, control buttons and power indicator are all turned off.

⚠ CAUTION

Even when the [⏻] (Standby/On) switch is in standby status, electricity is still flowing to the instrument at the minimum level. Remove the electric plug from the outlet when the instrument is not to be used for extended periods of time, or during electrical storms.

NOTICE

- Do not press any keys or pedals until the instrument has completely started up (the control buttons appear) after turning on the switch. Doing so may cause malfunction.
- If you need to force-quit the instrument, hold down the [⏻] (Standby/On) switch for longer than three seconds. Keep in mind that the force-quit operation might cause data loss and damage to the instrument.

Auto Power Off function

To prevent unnecessary power consumption, this instrument features an Auto Power Off function that automatically turns the power off if the instrument is not operated for a specified period of time. The amount of time that elapses before the power is automatically turned off is approximately 30 minutes by default; however, you can change the setting from [Utility] → [System] on Smart Pianist.

NOTICE

Any data which are not saved will be lost if the power automatically turns off. Make sure to save your data before this happens.

Disabling Auto Power Off (simple method)

Turn the power on while holding down the lowest key on the keyboard. The instrument starts up with the Auto Power Off function disabled.

Lowest key (A-1)



NOTE

You can enable/disable the Auto Power Off function by using the [FUNCTION] button (page 29).

Adjusting the Master Volume

To adjust the volume of the entire keyboard sound, use the [MASTER VOLUME] slider. Play the keyboard to check the sound while you adjust the volume.

⚠ CAUTION

Do not use the instrument for a long period of time at a high or uncomfortable volume level, since this can cause permanent hearing loss.

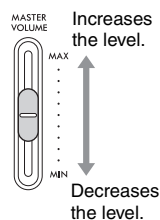

Intelligent Acoustic Control (IAC)

IAC is a function which automatically adjusts and controls the sound quality according to the overall volume of the instrument. Even when playing the instrument with the overall volume turned down, it permits both low sounds and high sounds to be clearly heard. IAC is effective only from the sound output of the instrument speakers. This function is set to on by default; however, you can turn it on or off, and set the depth from [Utility] → [Sound Setting] on Smart Pianist.

Attaching the music rest

- 1 Insert the music rest into the slots.

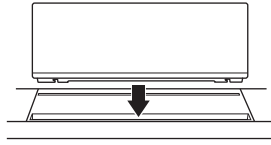

- 2 Open the stand at the rear side of the music rest to fit into the groove.

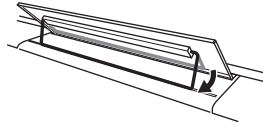

- 3 Slide the music rest to the right so that it is securely fastened.

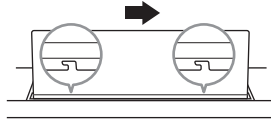

To detach the music rest, slide the music rest to the left and then lift it up.

CAUTION

- Before using the music rest, make sure that the stand fits into the groove and is fastened securely. Also, be sure to remove your smart device, etc. from the music rest when moving the instrument. Failure to do so may result in damage to the instrument or smart device, or even injury.
- Be careful to avoid catching your fingers when attaching or detaching the music rest.

Using a pedal (footswitch) – [AUX PEDAL] jack

Connect the included footswitch to the [AUX PEDAL] jack. Just as with a damper pedal of a piano, pressing the footswitch sustains notes even when you release your fingers from keyboards. Other separately sold foot pedal FC3A or footswitch FC4A/FC5 can also be connected to this jack. The FC3A allows you to use the Half Pedal function (page 18).

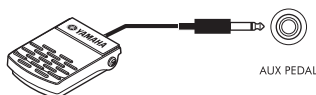

You can change the function of the pedal from [Utility] → [Pedal Setting] on Smart Pianist. Various functions such as “Style Start/Stop” are available.

NOTE

- Make sure that the power is off when connecting or disconnecting the footswitch/foot pedal.
- Do not press the footswitch/foot pedal while turning the power on. Doing this changes the recognized polarity of the footswitch/foot pedal, resulting in reversed operation.

Using a pedal unit and keyboard stand (sold separately) – [PEDAL UNIT] jack

A separately sold LP-1B/LP-1WH pedal unit can be connected to the [PEDAL UNIT] jack. When connecting the pedal unit, make sure to also assemble the unit on the separately sold L-300B/L-300WH keyboard stand. On the metal brackets of the L-300B/L-300WH, there are screw holes “A” and “B.” When assembling the keyboard stand for the P-S500, make sure to use the screw holes indicated by “A” on the metal brackets of the stand. For details, refer to the assembly manual of the stand.

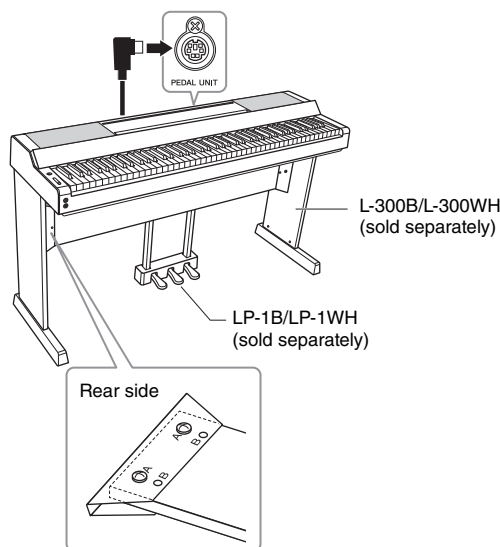

NOTE

- Make sure that the power is off when connecting or disconnecting the pedal unit.
- Do not press the pedals while turning the power on. Doing this changes the recognized polarity of the pedals, resulting in reversed operation.

Pedal Unit functions

By default, the following functions are assigned to each pedal. You can also assign other functions such as “Style Start/Stop” to the pedals from [Utility] → [Pedal Setting] on Smart Pianist.

■ Damper pedal (right pedal)

Pressing this pedal lets you sustain notes even after releasing the keys. You can use the Half Pedal function (see below) with this pedal.

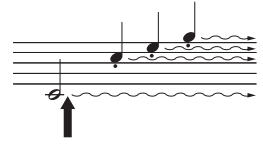

When you press the damper pedal here, the notes you play before you release the pedal have a longer sustain.

■ Sostenuto pedal (center pedal)

If you play a note or notes on the keyboard and press the sostenuto pedal while the note(s) are held, those notes will sustain as long as you hold the pedal but all subsequently played notes will not be sustained. This makes it possible to sustain a note or notes, for example, while other notes are played staccato.

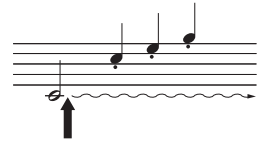

When you press the sostenuto pedal here while holding the note(s), the notes will sustain as long as you hold the pedal.

■ Soft pedal (left pedal)

The soft pedal reduces the volume and slightly changes the timbre of notes played while the pedal is pressed. The soft pedal will not affect notes that are already playing when it is pressed. In order to apply this effect, play notes after pressing the pedal.

Half Pedal function (for LP-1B/LP-1WH and FC3A)

The FC3A (page 17) and the right pedal of the LP-1B/LP-1WH have a Half Pedal function which allows you to use half-damper techniques, in which the damper is pressed somewhere between all the way down and all the way up. In this half-damper state (on a real piano), the damper felts only partially mute the strings. The Half Pedal function lets you delicately and expressively control the damper muting, and create subtle nuances in your performance, by finely controlling the point at which pressure on the pedal affects the damper muting. The point is called “Half Pedal Point” and can be set in the [Piano Room] of Smart Pianist.

Using headphones – [PHONES] jacks

Connect a pair of headphones to the [PHONES] jacks. Since this instrument is equipped with two [PHONES] jacks, you can connect two pairs of headphones.

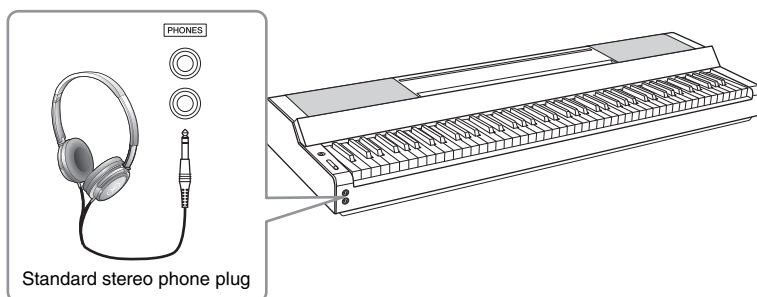

CAUTION

Do not use the headphones for a long period of time at a high or uncomfortable volume level, since this can cause permanent hearing loss.

Reproducing the natural sensation of sound distance (even when using headphones) —Binaural Sampling and Stereophonic Optimizer

This instrument features two advanced technologies that allow you to enjoy exceptionally realistic, natural sound, even though listening on headphones.

■ Binaural Sampling (“CFX Grand” Voice only)

Binaural Sampling is a method that uses two special microphones set at the ear position of a performer and records the sound from a piano as it would actually be heard. Listening to the sound with this effect through headphones gives the impression of being immersed in the sound, as if it was actually emanating from the piano. Moreover, you can enjoy the sound naturally for a long time without ear fatigue. When the “CFX Grand” Voice is selected, connecting the headphones automatically enables the binaural sampling sound.

Sampling

A technology which records the sounds of an acoustic instrument and then stores them to the tone generator to be played based on information received from the keyboard.

■ Stereophonic Optimizer (VRM Voices other than “CFX Grand”)

Stereophonic Optimizer is an effect which reproduces the natural sound distance, like with the sound of Binaural Sampling, even though you are listening to it on headphones. When one of the VRM Voices other than “CFX Grand” is selected, connecting the headphones automatically enables the Stereophonic Optimizer. To see which Voices are VRM Voices, refer to the Data List on the website.

What is VRM?

On an actual acoustic piano, if you press the damper pedal and play a key, not only does the string of the pressed key vibrate, it also causes other strings and the soundboard to vibrate, each influencing the rest and creating a rich and brilliant resonance that sustains and spreads. The VRM (Virtual Resonance Modeling) technology featured in this instrument reproduces the complicated interaction of both string and soundboard resonance faithfully using a virtual musical instrument (physical modeling), and makes the sound more like a real acoustic piano. Since instantaneous resonance is made at the moment according to the state of the keyboard or pedal, you can vary the sound expressively by changing the timing of your pressing the keys, and the timing and depth of your pressing the pedal.

Playing with Smart Pianist

You can take greater advantage of this instrument and get even more enjoyment from it by connecting it to your smart device and using the Smart Pianist smart device app. Smart Pianist gives you convenient and powerful access to additional functions, such as recording and Registration Memory. Moreover, the display gives you exceptionally intuitive visual control, making it even easier to control the instrument. To see what you can do on the instrument by itself, or by using the Smart Pianist, refer to the list on page 36.

NOTICE

All settings on the instrument are replaced by the settings on Smart Pianist when the instrument is connected with Smart Pianist.

Installing Smart Pianist



Get the Smart Pianist app and install it on your smart device!

- iPadOS/iOS: Available on the App Store
- Android: Available on Google Play

For details on the app and the compatible devices, see the website below.

<https://www.yamaha.com/kbdapps/>

Connecting with Smart Pianist

This instrument can be connected to a smart device via a USB cable or Wi-Fi (wireless LAN). For instructions on connecting the instrument with a smart device, the “Connection Wizard” of Smart Pianist will guide you according to the condition of the instrument you are using.



- 1 On Smart Pianist, tap the [≡] icon located at the upper left on the display to open the menu.
- 2 Tap [Instrument] to call up the Connection display.
- 3 Tap [Start Connection Wizard] at the bottom.
- 4 Follow the Connection Wizard.

When the connection is done successfully, “P-S500” is shown next to [Instrument] located at the lower left on the display. When the instrument is connected with Smart Pianist, the control buttons on the instrument are disabled, and all control over the instrument is done by using Smart Pianist.

Examples of connection via cables

NOTE

The [iPad] terminal and [USB TO HOST] terminal cannot be used at the same time for connecting smart devices.

■ Lightning connector devices (iPhone, iPad, etc.)

Connect the device to the [iPad] terminal by using a Lightning - USB cable. The iPhone or iPad connected to this terminal is automatically charged during use.

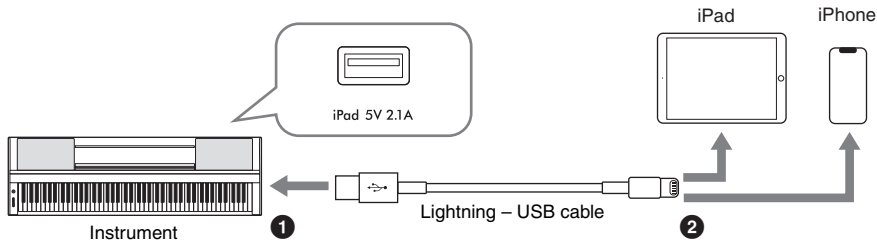

NOTICE

- The [iPad] terminal is dedicated for connection with iOS or iPadOS devices. Do not connect other devices to the terminal.
- Use an Apple Lightning - USB cable of less than 3 meters.

■ Micro B or USB Type-C connector devices

Connect the device to the [USB TO HOST] terminal by using an appropriate USB conversion adaptor and a USB cable. Before using the [USB TO HOST] terminal, be sure to read “Precautions when using the [USB TO HOST] terminal” (page 22).

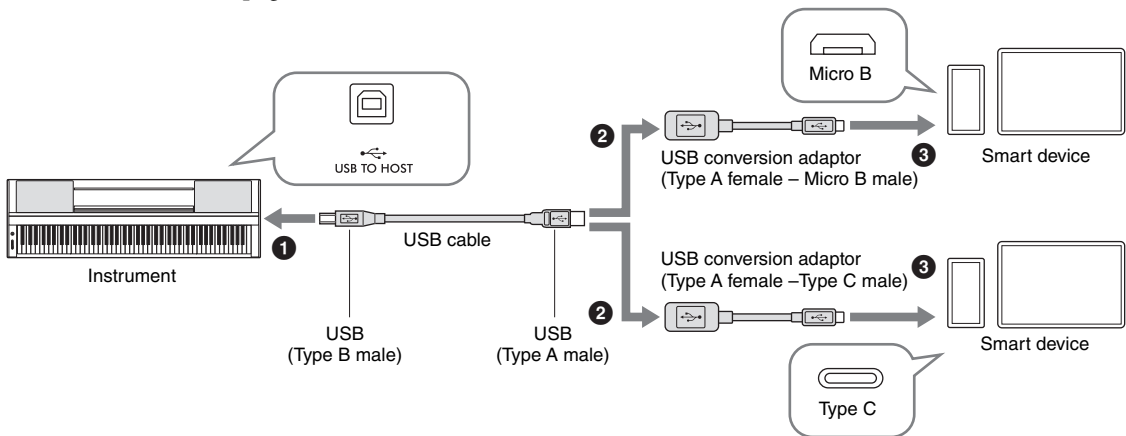

A USB type-C connector iPadOS device can also be connected by using the Apple USB-C Digital AV Multiport Adapter or Apple USB-C VGA Multiport Adapter.

NOTE

- The smart device cannot be charged when it is connected to the [USB TO HOST] terminal.
- Not all commercially available USB conversion adaptors are compatible.

Precautions when using the [USB TO HOST] terminal

When connecting the smart device to the [USB TO HOST] terminal, make sure to observe the following points to avoid freezing the smart device/instrument and corrupting or losing the data.

NOTICE

- Use an AB type USB cable of less than 3 meters. USB 3.0 cables cannot be used.
- Execute the following before turning the power to the instrument on/off or plugging/unplugging the USB cable to/from the [USB TO HOST] terminal.
 - Quit any open app on the smart device.
 - Make sure that data is not being transmitted from the instrument. (Data is transmitted even when the notes on the keyboard are played or a Song is played back.)
- While the smart device is connected to the instrument, you should wait for six seconds or more between these operations: (1) when turning the power of the instrument off then on again, or (2) when alternately connecting/disconnecting the USB cable.

If the smart device or the instrument freezes, restart the app or the smart device, or turn the power to the instrument off then on again.

Examples of connection via Wi-Fi (Wireless LAN)

For Wi-Fi connection, you need a separately sold wireless LAN adaptor (UD-WL01). Before connecting the wireless LAN adaptor, be sure to read “Precautions when using the [USB TO DEVICE] terminal” below.

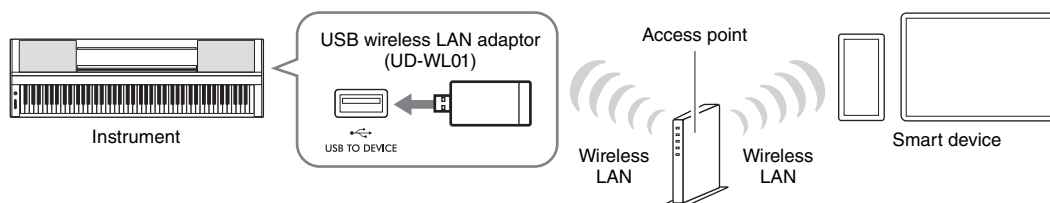

NOTICE

Do not connect this product to a public Wi-Fi and/or Internet service directly. Only connect this product to the Internet through a router with strong password protections. Consult your router manufacturer for information on optimum security practices.

NOTE

The instrument can be connected via Wi-Fi directly without need of an access point. However, in this condition Internet access will be disabled on your smart device, and certain functions may be limited, such as mailing, searching and some functions of Smart Pianist.

Precautions when using the [USB TO DEVICE] terminal

This instrument features a built-in [USB TO DEVICE] terminal. When connecting a USB device to the terminal, be sure to handle the USB device with care. Follow the important precautions below.

NOTE

For more information about the handling of USB devices, refer to the owner's manual of the USB device.

■ Compatible USB devices

- USB wireless LAN adaptor (UD-WL01; sold separately)
- USB flash drive (can only be used to update the software; not for use in saving files, reading data, recording nor playing back)

Other USB devices such as a USB hub, computer keyboard or mouse cannot be used.

NOTICE

The rating of the [USB TO DEVICE] terminal is a maximum of 5V/500mA. Do not connect USB devices having a rating above this, since this can cause damage to the instrument itself.

■ Connecting a USB device

When connecting a USB device to the [USB TO DEVICE] terminal, make sure that the connector on the device is appropriate and that it is connected in the proper direction.

NOTICE

- Avoid connecting or disconnecting the USB device when accessing the USB device. Failure to observe this may result in “freezing” of the operation of the instrument or corruption of the USB device and the data.
- When connecting and then disconnecting the USB device (and vice versa), make sure to wait a few seconds between the two operations.
- Do not use an extension cable when connecting a USB device.

Disconnecting Smart Pianist

You can disconnect the instrument from Smart Pianist by closing the app on the smart device, or by following the operation steps below on the instrument itself.

Even if Smart Pianist is disconnected, you can use the instrument with the settings you've made on the app maintained until the power of the instrument is turned off.

- 1 Press anywhere on the panel next to the display (where control buttons would normally be shown).**

A message is shown in the display.



```
Disconnect App?  
Cancel[-]/OK[+]
```

- 2 To disconnect, press the [+] button.**

To cancel, press the [-] button.

■ To reconnect with Smart Pianist:

On the menu of Smart Pianist, tap [Instrument] to call up the Connection display (steps 1 – 2 on page 20), and then select “P-S500.” If “P-S500” is not shown in the Connection display, start the Connection Wizard again.

Playing the Instrument Stand-alone

This chapter explains about the functions that can be controlled by using this instrument alone (without Smart Pianist). When the instrument is connected with Smart Pianist, the control buttons on the instrument cannot be used. Disconnect the instrument from Smart Pianist (page 23) to use these buttons.

- 1 FUNCTION
- 2 METRONOME
- 3 VOICE
- 4 STYLE
- 5 SONG
- 6 TEMPO
- 7 GUIDE



- 1 [FUNCTION].....page 28
- 2 [METRONOME]page 27
- 3 [VOICE]page 24
- 4 [STYLE]page 25
- 5 [SONG]page 26
- 6 [TEMPO]page 26
- 7 [GUIDE]page 27

For changing the parameter value. Holding one of these buttons changes the value continuously. Pressing both [+] and [-] buttons simultaneously can reset the parameter to the default value.

Starts/stops playback of the selected Style or Song. Pressing this button without selecting a Style or Song, the last selected one is played back.

For the list of Voices, Styles and Songs, refer to the Data List on the website.

Playing various musical instrument sounds (Voices) – [VOICE]

You can play the keyboard by using a wide variety of instrumental Voices. Voices 01 to 100 can be selected by using the instrument.

- 1 Press the [VOICE] button, and then use the [+] and [-] buttons to select the desired Voice.



Pressing the [VOICE] button repeatedly alternates the Voice category.

- 2 Play the keyboard.

If you use Smart Pianist, the Voices can be played via three keyboard parts: Main, Layer and Left. These playing modes allow you to play just one single Voice (Main) on entire keyboard, layer a different Voice (Layer part) to the Main part, or play a different Voice in the left-hand areas of the keyboard by turning the Left part on. When the Left part is turned on, the Stream Lights lights up at the point which divides the keyboard into the left-hand and right-hand areas. The point (called Split Point) can be changed in the Voice display on Smart Pianist.

Playing a Style with the auto accompaniment – [STYLE]

The instrument features various accompaniment and rhythmic backing patterns (called “Styles”) in a variety of different musical genres including pop, jazz, and many others. The Style features Auto Accompaniment which detects the “chords” automatically, and lets you produce automatic accompaniment playback simply by playing the keyboard. This lets you automatically recreate the sound of a full band or orchestra — even if you’re playing by yourself. Styles 01 to 100 can be selected by using the instrument.

- 1 Press the [STYLE] button, and then use the [+] and [-] buttons to select the desired Style.



Pressing the [STYLE] button repeatedly alternates the Style category.

- 2 Press the [▶/■] (Start/Stop) button to start playback.

To adjust the tempo, use the [TEMPO] button (page 26).

- 3 As you play the keyboard using both hands, the auto accompaniment changes along with your performance.



By default, just playing anywhere on the keyboard using both hands as you like, the instrument detects the chords and plays the accompaniment along with your performance automatically. If you set the Chord Detection Area to “Lower” by using Smart Pianist, a specifically assigned left-hand section of the keyboard is used to specify chords, and chords played in this section are detected and used as a basis for automatic accompaniment with the selected Style. To restore the default setting, select “Full” as the Chord Detection Area.

- 4 After you finish your performance, press the [▶/■] (Start/Stop) button to stop playback.

Playing back a Song – [SONG]

This section explains how to play the preset Songs. Songs 00 to 100 (No. 00 is the Demo Song) can be selected by using the instrument.

- 1 Press the [SONG] button, and then use the [+] and [-] buttons to select the desired Song.



Holding down the [SONG] button starts playback of “00:Clocks (Demo).”

- 2 Press the [▶/■] (Start/Stop) button to start playback.

During Song playback, the playback position (current measure/total number of measures) is shown in the display, and the Stream Lights (page 27) start lighting in succession.

- 3 To stop playback of the Song, press the [▶/■] (Start/Stop) button.

Fast forward/rewind

Press the [+] or [-] button during playback of the Song. Pressing either of them once moves forward/backward one measure. Holding either of them scrolls forward/backward continuously.

Returning to the top of the Song

Press the [+] and [-] buttons simultaneously to return to the top of the Song during playback.

Repeat playback

Call up “Song Repeat” by using the [FUNCTION] button (page 28) to select the type of Song Repeat. Then, select the desired Song and start playback to start repeat playback in the selected type.

Adjusting the tempo – [TEMPO]

The [TEMPO] button lets you change the playback tempo of metronome (page 27), Style (page 25) and Song (page 26). Press the [TEMPO] button, and then use the [+] and [-] buttons to adjust the tempo.



You can change the tempo by tapping the [TEMPO] button twice or more at the desired tempo.

Practice along with the Stream Lights by using the Guide function – [GUIDE]

You can mute the right and/or left-hand part of the Song to try practicing that part on your own. The Stream Lights indicate the notes you should play and when you should play them.

- 1 Select the desired Song (page 26).
- 2 Press the [GUIDE] button, and then use the [+] and [-] buttons to select the desired part to practice.

(**Right:** For right-hand practice, **Left:** For left-hand practice, **Right & Left:** For both-hand practice, **Off:** Turns the Guide function off)



- 3 Press the [▶/■] (Start/Stop) button to start playback.

The part selected in step 2 is muted and the Stream Lights indicate the notes you should play and when you should play them. As the lights “descend,” play the indicated key when the light reaches the bottom, nearest the key. You can also practice at your own pace — since the playback of other parts will wait for you to play the notes correctly.

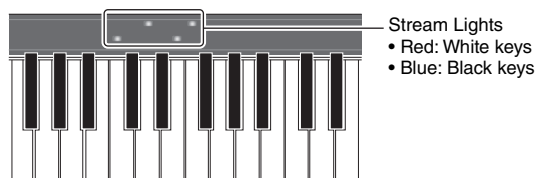

- 4 After your practice, select “Off” on the display in step 2 to turn the Guide function off.

The Stream Lights speed and the on/off status can be set from [Song] → (Song select) → [Setting] → [Playback] on Smart Pianist.

Using the metronome – [METRONOME]

The [METRONOME] button lets you start or stop the metronome. The metronome provides a click sound, giving you an accurate tempo guide when you practice, or letting you hear and check how a specific tempo sounds. To adjust the tempo, use the [TEMPO] button (page 26).

Make settings of various functions – [FUNCTION]

1 Press the [FUNCTION] button repeatedly to select the setting display.

For details on each setting display, see “Function List” below.

NOTE

You can also select the next or previous setting display by pressing the [+] or [-] button while holding down the [FUNCTION] button.

2 Use the [+] and [-] buttons to change the setting value.

To reset to the default setting, press the [+] and [-] buttons simultaneously.

3 To exit from the setting display, press any button other than [+]/[-] buttons.

Function List

| Setting display | Description | Default setting |
|-------------------|--|-------------------------------------|
| Transpose | Shifts the pitch of the entire keyboard up or down in semitone steps to facilitate playing in difficult key signatures, and to let you easily match the pitch of the keyboard to the range of a singer or other instruments. Setting range: -12 – 0 – +12 | 0 |
| Tuning* | Fine tunes the pitch of the entire instrument in 0.2 Hz steps. This function is useful when you play this instrument along with other instruments or CD music. Setting range: 414.8 – 466.8 Hz | 440.0 |
| Reverb | Determines the Reverb type which is applied to the entire sound including the keyboard performance, Style/Song playback and MIDI data input from an external MIDI device. <ul style="list-style-type: none"> • Recital Hall: Simulates clear reverberation in a mid-sized hall suitable for piano recital. • Concert Hall: Simulates brilliant reverberation in a large hall for public orchestra performances. • Chamber: Simulates the elegant reverberation in a small room suitable for chamber music. • Cathedral: Simulates the solemn reverberation in a high-ceiling stone-made cathedral. • Club: Simulates the lively reverberation in a jazz club or a small bar. • No Effect: No reverb effect is applied. When a Style or Song is selected, the ideal Reverb type is automatically called up. If the type which cannot be selected on this instrument is called up, “(Auto)” is shown on the display. | Differs depending on the Style/Song |
| Reverb Depth | Adjusts the Reverb depth. When the Reverb above is set to “No Effect” or the depth is set to 0, no effect is produced. Setting range: 0 – 127 If you change the setting value while a VRM Voice (page 19) is selected, this setting is applied to all VRM Voices, including the VRM Voices contained in Songs and Styles, as well as the keyboard performance. | Differs depending on the Voice |
| Touch Response* | Determines how the sound responds to your playing strength. This setting does not change the weight of the keyboard. <ul style="list-style-type: none"> • Soft 2: Produces relatively high volume even with light playing strength. • Soft 1: Produces high volume with moderate playing strength. • Medium: Standard Touch Sensitivity. • Hard 1: Requires moderately strong playing for high volume. • Hard 2: Requires strong playing to produce high volume. • Fixed: The volume level will be the same regardless of how hard you play the keys. | Medium |
| Time Signature | Selects the time signature of the metronome. The Metronome plays back according to the selected Time Signature with the Bell sound on the first beat of each measure. When “Bell Off” is selected, the Bell does not sound. When the time signature is set to a value other than “Bell Off,” changing the Style or Song sets the time signature to the default value for each Style or Song automatically. Setting range: Bell Off, 2/4, 3/4, 4/4, 5/4, 6/4 | Bell Off |
| Metronome Volume* | Sets the volume of metronome. Setting range: 0 – 127 | 100 |

| Setting display | Description | Default setting |
|-----------------|---|-----------------|
| Style Part | Selects the Style parts to be played back. <ul style="list-style-type: none"> • All: All parts (1 – 8 channels) • Rhythm & Bass: Rhythm parts and Bass part (1 – 3 channels) • Rhythm: Only Rhythm part (1 – 2 channels) Changing the Style sets this value to “All” automatically. When the playback parts are changed by MIDI data input from Smart Pianist or other external device, “(Changed)” is shown in the display. | All |
| Song Repeat | Selects the type of Song Repeat. <ul style="list-style-type: none"> • Off: Disables repeat playback. When the currently selected Song reaches to the end, playback stops automatically. • Single: Plays through the currently selected Song repeatedly. • All: Continuously plays back all Songs (from 01 to 100) in order. • Random: Continuously plays back all Songs (from 01 to 100) in random order. | Off |
| MIDI Channel | Determines the MIDI channel over which the MIDI messages generated via the keyboard performance will be transmitted to the external device. When the Layer and/or Left part is on (page 24), the MIDI channels are assigned as follows. <ul style="list-style-type: none"> • Main part = n (setting value: 1 – 8) • Layer part = n+1 • Left part = n+2 * The value after 8 is 1. Style parts are transmitted via the 9 – 16 channels regardless of the setting here. | 1 |
| Audio Loopback* | Determines whether audio sound input from the connected computer or smart device is output to a computer or a smart device or not along with the performance played on the instrument. For example, if you want to record the audio input sound as well as the sound played on the instrument by using the computer or the smart device, set this to “On.” If you intend to record only the sound played on the instrument by using the computer or the smart device, set this to “Off.” | On |
| Button Sound* | Determines whether a sound is made when a control button on the panel is pressed (the “On” setting), or whether no sound is heard (the “Off” setting). | On |
| Auto Power Off* | Turns on (the “Enabled” setting) or off (the “Disabled” setting) the Auto Power Off function (page 15). | Enabled |
| Language* | Selects the language (English/Japanese) for the display. This setting will be enabled after exiting from this setting display. | English |
| Version | Shows the firmware version of this instrument. Yamaha may from time to time update firmware of the product without notice for improvement in functions and usability. To take full advantage of this instrument, we recommend that you upgrade your instrument to the latest version. The latest firmware can be downloaded from the website below: https://download.yamaha.com/ | – |

The settings marked with “*” are backed up even when the power of the instrument is turned off.

Restoring the factory-programmed settings (initializing)

While holding the C7 key (right-most key on the keyboard), turn the power on. This restores (or initialize) all of the settings to their factory defaults, with the exception of “Language” in the Function List above.

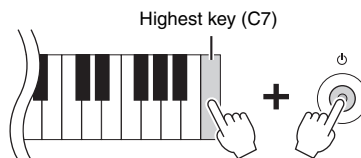

Connecting to other devices

External devices can be connected to the jacks and terminals, and you can enjoy playing this instrument with these devices. For the [AUX PEDAL] jack and the [PEDAL UNIT] jack, refer to page 17. This section explains connections with other connectors.

⚠ CAUTION

Before connecting the instrument to other electronic components, turn off the power of all the components. Also, before turning any components on or off, make sure to set all volume levels to minimum (0). Otherwise, damage to the components, electrical shock, or even permanent hearing loss may occur.

NOTICE

Do not place any external devices in an unstable position. Doing so may cause the device to fall and result in damage.

Connecting with a smart device for using an app – [iPad] terminal, [USB TO DEVICE] terminal, [USB TO HOST] terminal

By connecting to a smart device and using the compatible smart device app, you can get more enjoyment out of this instrument. For information about the compatible apps and smart devices, access the web page of the respective apps on the following page:

<https://www.yamaha.com/kbdapps/>

For information on connecting with Smart Pianist, refer to page 20. To use other apps, check the connection method in the web page of the respective apps shown above.

NOTE

The [iPad] terminal and [USB TO HOST] terminal cannot be used at the same time for connecting smart devices.

Connecting to an external audio device – [AUX IN] jack, AUX OUT [R]/[L/L+R] jacks

Listening to playback on an audio player through the instrument's speaker

You can connect the headphone jack of an audio player such as a smartphone to the instrument's [AUX IN] jack. Audio playback on the connected device is output from the built-in speakers of this instrument.

NOTICE

To avoid damage to the devices, first turn on the power to the external device, and then to the instrument. When turning off the power, first turn off the power to the instrument, and then to the external device.

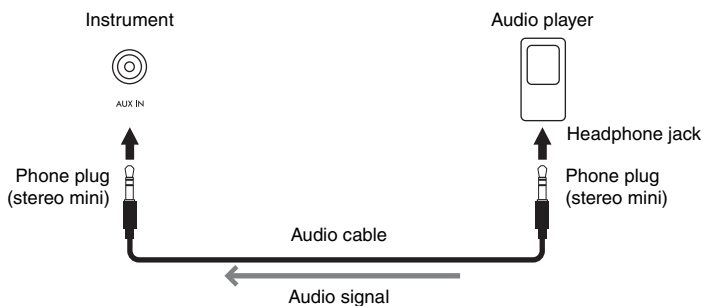

NOTE

- Use audio cables and adaptor plugs having no (zero) resistance.
- The USB Audio Interface function gives you direct, clear sound in which the sound quality has less noise and deterioration than that from the [AUX IN] jack (page 33).

Using an external speaker system for listening to sounds from the instrument

You can connect a stereo system to amplify the instrument's sound by using the AUX OUT [R]/[L/L+R] jacks. The sound input from the [AUX IN] jack and the [MIC INPUT] jack is output at the same time.

NOTICE

- To avoid possible damage, first turn on the power to the instrument, and then to the external device. When turning off the power, first turn off the power to the external device, and then to the instrument. Since this instrument's power may automatically be turned off due to the Auto Power Off function (page 29), turn off the power to the external device, or disable Auto Power Off when you do not intend to operate the instrument.
- Do not route the output from the AUX OUT jacks to the [AUX IN] jacks. If you make this connection, the signal input at the [AUX IN] jacks is output from the AUX OUT jacks. These connections could result in a feedback loop that will make normal performance impossible, and may even damage the equipment.

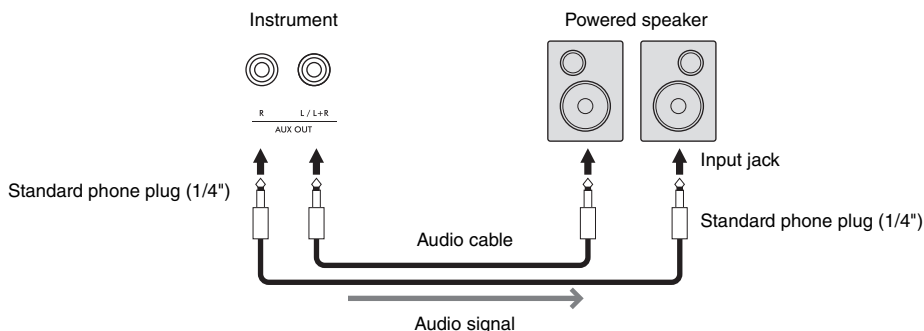

NOTE

- Use only the [L/L+R] jack for connection with a monaural device.
- Use an appropriate adaptor plug if the input jack of the powered speaker does not match the phone plug of the audio cable.
- Use audio cables and adaptor plugs having no (zero) resistance.
- When you are monitoring the sound output via the AUX OUT jacks from headphones connected to the instrument, we recommend that you set the Binaural Sampling and Stereophonic Optimizer functions (page 19) to off. These can be turned on or off from [Utility] → [Sound Setting] → [Binaural] on Smart Pianist.

Connecting a microphone – [MIC INPUT] jack

By connecting a microphone to the [MIC INPUT] jack (standard mono phone jack), you can enjoy singing along with your keyboard performance or with Song playback. The instrument outputs your vocals through the built-in speakers. Moreover, you can apply various harmony effects (called Vocal Harmony) to your singing voice from [Utility] → [Mic Setting] on Smart Pianist.

- 1 Before turning on the power of the instrument, set the [MIC VOLUME] knob to the minimum position.

- 2 Connect the microphone to the [MIC INPUT] jack.

NOTE

Make sure you have a conventional dynamic microphone.

- 3 Turn on the power of the instrument.
- 4 (If necessary, turn on the microphone.) Adjust the [MIC VOLUME] knob while singing into the microphone.
- 5 After you finish your performance, turn the [MIC VOLUME] knob to the minimum position, and then disconnect the microphone.

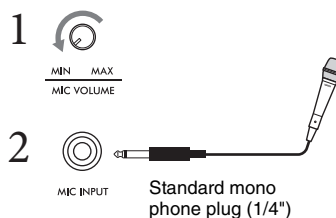

Connecting to a computer – [USB TO HOST] terminal

By connecting a computer to the [USB TO HOST] terminal, you can transmit or receive data between the instrument and the computer. For details on using a computer with this instrument, refer to the “Computer-related Operations” on the website.

NOTICE

- Use an AB type USB cable of less than 3 meters. USB 3.0 cables cannot be used.
- If you are using a DAW (digital audio workstation) application with this instrument, set the Audio Loopback function (page 33) to off. Otherwise, a loud sound may occur, depending on the settings of the computer or the application software.

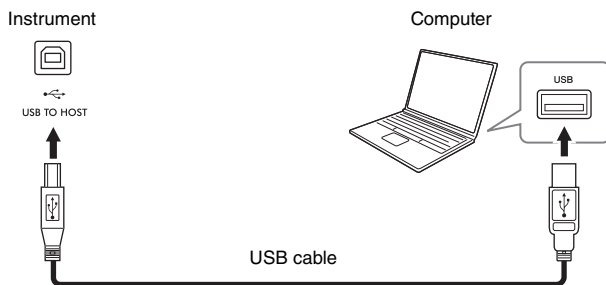

NOTE

- When using a USB cable to connect the instrument to your computer, make the connection directly without passing through a USB hub.
- You cannot connect a computer to this instrument with a USB wireless LAN adaptor.
- The instrument will begin transmission a short time after the USB connection is made.
- For information on setting up your sequence software, refer to the owner's manual of the relevant software.
- The instrument does not transmit any MIDI messages when connected with Smart Pianist.
- The [USB TO HOST] terminal and [iPad] terminal cannot be used at the same time for connecting a computer and a smart device.

Transmitting/receiving audio data (USB Audio Interface function) – [iPad] terminal, [USB TO HOST] terminal

By connecting a computer or a smart device to the instrument via the [iPad] or [USB TO HOST] terminal, digital audio data can be transmitted/received. This USB Audio Interface function provides the following advantages:

■ Playing back audio data with high sound quality

This gives you direct, clear sound in which the sound quality has less noise and deterioration than that from the [AUX IN] jack.

■ Recording performance on the instrument as audio data by using a recording software or a music production software

The recorded audio data can be played back on the computer or smart device.

For details on connecting to a computer, refer to the “Computer-related Operations” on the website. For instructions on connecting to a smart device, refer to the examples of connection via cables on page 21.

NOTE

When using a computer running Windows, the Yamaha Steinberg USB Driver should be installed to the computer.

Turning Audio Loopback on/off

This allows you to set whether audio sound input from the computer or smart device via the USB Audio Interface function above, or the Wi-Fi connection (page 22) is output to a computer or a smart device or not along with the performance played on the instrument. To output the audio input sound, set the Audio Loopback to “On.” For example, if you want to record the audio input sound as well as the sound played on the instrument by using the connected computer or smart device, set this to “On.” If you intend to record only the sound played on the instrument by using the computer or smart device, set this to “Off.” The setting can be made via the [FUNCTION] button (page 29).

NOTE

- The Audio Loopback function does not affect the input sound from the [AUX IN] jack.
- When Audio Recording by using Smart Pianist, the audio input sound from the connected computer or smart device is recorded when this is set to “On,” and not recorded when set to “Off.”

Troubleshooting

For troubleshooting information on the app settings, refer to the included Help within the app. On Smart Pianist, tap the [≡] (Menu) icon located upper left on the display, and then call up [Utility] → [System] → [FAQ].

| Problem | Possible Cause and Solution |
|--|--|
| The instrument does not turn on. | The plugs are not properly connected. Make sure that the DC plug is securely inserted into the DC IN jack on the instrument, and that the AC plug is securely inserted to the AC outlet (page 14). |
| The power is automatically turned off. | This is normal and due to the Auto Power Off function. If necessary, set the parameter of the Auto Power Off function (page 15). |
| Noise is heard from the speakers or headphones. | The noise may be due to interference caused by the use of a mobile phone in close proximity to the instrument. Turn off the mobile phone, or use it further away from the instrument. |
| Noise is heard from the instrument's speakers or headphones when using the instrument with your smart device. | When you use the instrument along with your smart device, we recommend that you connect with a cable, or set your device to not emit radio waves (such as with "Airplane Mode"), turn on Wi-Fi only, and connect to the instrument. |
| The overall volume is low, or no sound is heard. | The Master Volume is set too low; set it to an appropriate level using the [MASTER VOLUME] slider (page 15). |
| Pedals do not function. | The pedal plug may not be properly connected. Make sure to securely insert the pedal plug into the [AUX PEDAL] or [PEDAL UNIT] jack. Be sure to insert the pedal cord all the way until the metal part of the cord plug disappears from view. |
| The keyboard volume is lower than the metronome volume. | The volume level for the metronome is set too loud. Adjust the metronome volume (page 28). |
| Higher or lower notes do not sound correctly when the transpose setting is made. | The instrument can cover a key range of C-2 – G8 when you set the transposition. If notes lower than C-2 are played, the actual resulting sound is one octave higher. If notes higher than G8 are played, the resulting sound is one octave lower. |
| The sound output from the external speaker or the sound of Song playback recorded in audio format is not the usual. | This is because the "Binaural" setting is turned on. When "Binaural" is on and headphones are connected, the VRM Voices (including the sound outside the headphones) automatically change to the sound of Binaural Sampling or the sound enhanced with the Stereophonic Optimizer. This is turned on by default. You can turn it on or off from [Utility] → [Sound Setting] → [Binaural] of Smart Pianist. |
| The error message does not disappear even when the problem has been solved. | Press the [+] button. |

Specifications

P-S500

| | | P-S500 | |
|-----------------------------|-------------------------------|---|--|
| Product Name | | Digital Piano | |
| Size/Weight | Dimensions (W × D × H) | 1,329 mm × 410 mm × 167 mm (52-5/16" × 16-1/8" × 6-9/16") | |
| | with music rest | 1,329 mm × 410 mm × 283 mm (52-5/16" × 16-1/8" × 11-1/8") | |
| | Weight | 21.8 kg (48 lb, 1 oz) | |
| Control Interface | Keyboard | Number of Keys | 88 |
| | | Type | GHS (Graded Hammer Standard) keyboard with matte black keytops |
| | | Touch Response | Soft2/Soft1/Medium/Hard1/Hard2/Fixed |
| | Display | Type | Full dot LCD |
| | | Size | 80 × 16 dots |
| | | Language | English, Japanese |
| | Panel | Type | Touch sensors |
| | | Language | English |
| Function | USB Audio Interface | 44.1 kHz, 16 bit, stereo | |
| | Lesson/Guide | Yes (with Stream Lights) | |
| Voices | Tone Generation | Piano Sound | Yamaha CFX, Bösendorfer Imperial |
| | | Binaural Sampling | Yes ("CFX Grand" only) |
| | Piano Effect | VRM | Yes |
| | | Key-off Samples | Yes |
| | Polyphony (max.) | 256 | |
| | Compatibility | XG, GS, GM, GM2 | |
| Connectivity | DC IN | 24 V | |
| | Headphones | Standard stereo phone jack (× 2) | |
| | Microphone | Mic input (standard mono phone jack), input volume | |
| | AUX PEDAL | Yes | |
| | PEDAL UNIT | Yes | |
| | AUX IN | Stereo mini jack | |
| | AUX OUT | Standard phone jack (R, L/L+R) | |
| | USB TO DEVICE | Yes | |
| | USB TO HOST | Yes | |
| | iPad | 5V, 2.1A | |
| Sound System | Amplifiers | (20 W + 6 W) × 2 | |
| | Speakers | (Oval (12 cm × 6 cm) + 2.5 cm (dome)) × 2 | |
| Power Supply | AC Adaptor | PA-500 (Output: DC 24 V, 2.5 A) | |
| | Power Consumption | 40 W | |
| | Auto Power Off | Yes | |
| Included Accessories | | <ul style="list-style-type: none"> • Owner's Manual • Online Member Product Registration • Power cord*/AC adaptor PA-500* • Music Rest • Footswitch <p>*May not be included depending on your area. Check with your Yamaha dealer.</p> | |

What you can do with the P-S500 stand-alone and when connected with Smart Pianist

| | | P-S500 | P-S500 + Smart Pianist |
|--|--|---|---|
| Language | | English/Japanese | Menu: English/German/French/ Spanish/Japanese/Chinese Messages and Help: 26 languages |
| Piano Room (various settings for piano sound) | | – | Yes |
| Voices | Number of Voices | 100 | 660 |
| | Layer (layering two Voices) | – | Yes |
| | Left (playing two different Voices by right- and left-hand) | – | Yes |
| | Split Point Change | – | Yes |
| | Octave | – | Yes |
| Styles | Number of Styles | 100 | 370 |
| | Chord Detection Area | Full (cannot be changed) | Full/Lower |
| | Intro/Ending | On (cannot be changed) | On/Off |
| | Section Change | – | Main × 4 |
| | Synchro Start | – | Yes |
| | Playback Parts | All/Rhythm&Bass/Rhythm | 8 parts, independent on/off control |
| Effects | Reverb Types | 5 types | 58 types |
| Recording | MIDI | – | Yes (SMF format 0) |
| | Audio | – | Yes (WAV, AAC) |
| Songs | Number of Songs for playback | 100 | 403 |
| | Stream Lights Setting | On (cannot be changed) | On/Off, Speed |
| | Guide Type | Correct Key (Cannot be changed) | Correct Key/Any Key/Your Tempo |
| | Score/Chord/Lyrics Display Function | – | Yes |
| | Audio To Score | – | Yes |
| | A-B Repeat | – | Yes |
| Registration Memory | | – | Yes |
| Metronome | | Yes | |
| Tempo | | 5 – 500, Tap Tempo | |
| Balance (volume balance among parts) | | – | Yes |
| Utility | Transpose | Keyboard | Keyboard/Style, Song |
| | Tuning | 414.8 – 440.0 – 466.8 Hz (0.2 Hz increments) | 414.8 – 440.0 – 466.8 Hz (0.2 Hz increments), 9 scale types |
| | Keyboard Setting (Touch Curve) | Soft2/Soft1/Medium/Hard1/Hard2/Fixed | |
| | Pedal Setting | – | Yes (functions can be selected) |
| | Mic Setting | – | Yes (Vocal Harmony, etc.) |
| | Master EQ | – | Yes |
| | Sound Setting | – | Yes (Binaural, IAC, etc.) |
| | Auto Power Off | Disabled/Enabled | Disabled/Enabled (elapsed time can be set) |

There are many more parameters that can be set on Smart Pianist. Check and try them out on the app.

Separately Sold Accessories

*May not be available depending on your area.

- Keyboard Stand L-300B, L-300WH
- Pedal Unit LP-1B, LP-1WH
- Foot Pedal FC3A
- Footswitch FC4A, FC5
- Headphones HPH-150, HPH-100, HPH-50
- AC adaptor PA-500
- USB Wireless LAN Adaptor UD-WL01
- Wireless MIDI Adaptor UD-BT01

The contents of this manual apply to the latest specifications as of the publishing date. To obtain the latest manual, access the Yamaha website then download the manual file. Since specifications, equipment or separately sold accessories may not be the same in every locale, please check with your Yamaha dealer.

Index

A

| | |
|----------------------|--------|
| Accompaniment | 25 |
| App | 30 |
| Audio device | 30 |
| Audio Loopback | 29, 33 |
| Audio To Score | 10 |
| Auto Power Off | 15, 29 |

B

| | |
|-------------------------|----|
| Binaural Sampling | 19 |
| Button Sound | 29 |

C

| | |
|-------------------------------------|----|
| Computer | 32 |
| Connection (external devices) | 30 |
| Connection (Smart Pianist) | 20 |
| Connection Wizard | 20 |

F

| | |
|------------------|----|
| Footswitch | 17 |
| Functions | 28 |

G

| | |
|-------------|----|
| Guide | 27 |
|-------------|----|

H

| | |
|------------------|----|
| Half pedal | 18 |
| Headphones | 19 |

I

| | |
|--|----|
| IAC (Intelligent Acoustic Control) | 15 |
| Initializing | 29 |
| Intelligent Acoustic Control (IAC) | 15 |

K

| | |
|----------------------|----|
| Keyboard stand | 17 |
|----------------------|----|

L

| | |
|----------------|----|
| Language | 29 |
|----------------|----|

M

| | |
|---------------------|----|
| Master Volume | 15 |
| Metronome | 27 |
| Microphone | 31 |
| MIDI Channel | 29 |
| Music rest | 16 |

P

| | |
|--------------------|----|
| Part (Style) | 29 |
| Pedal | 17 |
| Pedal unit | 17 |
| Power | 14 |

R

| | |
|-----------------------|----|
| Repeat playback | 29 |
| Reverb | 28 |

S

| | |
|------------------------------|----|
| Smart Pianist | 20 |
| Song | 26 |
| Song Repeat | 29 |
| Stand | 17 |
| Stereophonic Optimizer | 19 |
| Stream Lights | 27 |
| Style | 25 |
| Style Part | 29 |

T

| | |
|----------------------|----|
| Tempo | 26 |
| Time Signature | 28 |
| Touch Response | 28 |
| Transpose | 28 |
| Tuning | 28 |

U

| | |
|---------------------------|----|
| USB Audio Interface | 33 |
|---------------------------|----|

V

| | |
|------------------------------|----|
| Version | 29 |
| Voice | 24 |
| Volume (master volume) | 15 |
| Volume (metronome) | 28 |
| VRM | 19 |



Information for users on collection and disposal of old equipment:

This symbol on the products, packaging, and/or accompanying documents means that used electrical and electronic products should not be mixed with general household waste.

For proper treatment, recovery and recycling of old products, please take them to applicable collection points, in accordance with your national legislation.

By disposing of these products correctly, you will help to save valuable resources and prevent any potential negative effects on human health and the environment which could otherwise arise from inappropriate waste handling.

For more information about collection and recycling of old products, please contact your local municipality, your waste disposal service or the point of sale where you purchased the items.

For business users in the European Union:

If you wish to discard electrical and electronic equipment, please contact your dealer or supplier for further information.

Information on Disposal in other Countries outside the European Union:

This symbol is only valid in the European Union. If you wish to discard these items, please contact your local authorities or dealer and ask for the correct method of disposal.

(weee_eu_en_02)

Credits and Copyrights for the pre-installed Songs

All I Want For Christmas Is You

Words and Music by Mariah Carey and Walter Afanasieff
Copyright © 1994 BEYONDIDOLIZATION, SONY/ATV MUSIC PUBLISHING LLC, TAMAL VISTA MUSIC, WALLYWORLD MUSIC and KOBALT MUSIC COPYRIGHTS SARL
All Rights for BEYONDIDOLIZATION Controlled and Administered by UNIVERSAL TUNES, A Division of SONGS OF UNIVERSAL, INC.
All Rights for SONY/ATV MUSIC PUBLISHING LLC, TAMAL VISTA MUSIC and WALLYWORLD MUSIC Administered by SONY/ATV MUSIC PUBLISHING LLC, 424 Church Street, Suite 1200, Nashville, TN 37219
All Rights Reserved Used by Permission

All The Things You Are

Lyrics by Oscar Hammerstein II
Music by Jerome Kern
Copyright © 1939 UNIVERSAL - POLYGRAM INTERNATIONAL PUBLISHING, INC.
Copyright Renewed
All Rights Reserved Used by Permission

Autumn Leaves

English lyric by Johnny Mercer
French lyric by Jacques Prevert
Music by Joseph Kosma
© 1947, 1950 (Renewed) ENOCH ET CIE
Sole Selling Agent for U.S. and Canada: MORLEY MUSIC CO., by agreement with ENOCH ET CIE
All Rights Reserved

Back For Good

Words and Music by Gary Barlow
Copyright © 1995 Sony/ATV Music Publishing(UK) Limited
All Rights Administered by Sony/ATV Music Publishing LLC, 424 Church Street, Suite 1200, Nashville, TN 37219
International Copyright Secured All Rights Reserved

Billie Jean

Words and Music by Michael Jackson
Copyright © 1982 Mijac Music
All Rights Administered by Sony/ATV Music Publishing LLC, 424 Church Street, Suite 1200, Nashville, TN 37219
International Copyright Secured All Rights Reserved

Can't Take My Eyes Off Of You

Words and Music by Bob Crewe and Bob Gaudio
Copyright © 1967 EMI Longitude Music and Seasons Four Music
Copyright Renewed
All Rights on behalf of EMI Longitude Music Administered by Sony/ATV Music Publishing LLC, 424 Church Street, Suite 1200, Nashville, TN 37219
International Copyright Secured All Rights Reserved

Candle In The Wind

Words and Music by Elton John and Bernie Taupin
Copyright © 1973 UNIVERSAL/DICK JAMES MUSIC LTD.
Copyright Renewed
All Rights in the United States and Canada Controlled and Administered by UNIVERSAL - SONGS OF POLYGRAM INTERNATIONAL, INC.
All Rights Reserved Used by Permission

Clocks

Words and Music by Guy Berryman, Jon Buckland, Will Champion and Chris Martin
Copyright © 2002 by Universal Music Publishing MGB Ltd.
All Rights in the United States Administered by Universal Music - MGB Songs
International Copyright Secured All Rights Reserved

Dancing Queen

Words and Music by Benny Andersson, Bjorn Ulvaeus and Stig Anderson
Copyright © 1976, 1977 UNIVERSAL/UNION SONGS MUSIKFORLAG AB
Copyright Renewed
All Rights Administered by UNIVERSAL - POLYGRAM INTERNATIONAL PUBLISHING, INC. and EMI GROVE PARK MUSIC, INC.
All Rights Reserved Used by Permission

Eternal Flame

Words and Music by Billy Steinberg, Tom Kelly and Susanna Hoffs
Copyright © 1988 Sony/ATV Music Publishing LLC and Bangophile Music
All Rights on behalf of Sony/ATV Music Publishing LLC Administered by Sony/ATV Music Publishing LLC, 424 Church Street, Suite 1200, Nashville, TN 37219
All Rights on behalf of Bangophile Music Controlled and Administered by Songs Of Universal, Inc.
International Copyright Secured All Rights Reserved

Every Breath You Take

Music and Lyrics by Sting
Copyright © 1983 G.M. Sumner
All Rights Administered by Sony/ATV Music Publishing LLC, 424 Church Street, Suite 1200, Nashville, TN 37219
International Copyright Secured All Rights Reserved

Fields Of Gold

Music and Lyrics by Sting
Copyright © 1993 Steerpike Ltd.
All Rights Administered by Sony/ATV Music Publishing LLC, 424 Church Street, Suite 1200, Nashville, TN 37219
International Copyright Secured All Rights Reserved

Final Countdown

Words and Music by Joey Tempest
Copyright © 1986 EMI Music Publishing Ltd.
All Rights Administered by Sony/ATV Music Publishing LLC, 424 Church Street, Suite 1200, Nashville, TN 37219
International Copyright Secured All Rights Reserved

The Girl From Ipanema (Garôta De Ipanema)

Music by Antonio Carlos Jobim
English Words by Norman Gimbel
Original Words by Vinicius De Moraes
Copyright © 1963 ANTONIO CARLOS JOBIM and VINICIUS DE MORAES, Brazil
Copyright Renewed 1991 and Assigned to SONGS OF UNIVERSAL, INC. and WORDS WEST LLC
English Words Renewed 1991 by NORMAN GIMBEL for the World and Assigned to WORDS WEST LLC (P.O. Box 15187, Beverly Hills, CA 90209 USA)
All Rights Reserved Used by Permission

Hallelujah

Words and Music by Leonard Cohen
Copyright © 1985 Sony/ATV Music Publishing LLC
All Rights Administered by Sony/ATV Music Publishing LLC, 424 Church Street, Suite 1200, Nashville, TN 37219
International Copyright Secured All Rights Reserved

Hey Jude

Words and Music by John Lennon and Paul McCartney
Copyright © 1968 Sony/ATV Music Publishing LLC
Copyright Renewed
All Rights Administered by Sony/ATV Music Publishing LLC, 424 Church Street, Suite 1200, Nashville, TN 37219
International Copyright Secured All Rights Reserved

The House Of The Rising Sun

Words and Music by Alan Price
Copyright © 1964 Keith Prowse Music Publishing Co., Ltd. and ole Cantaloupe Music Copyright Renewed
All Rights Administered by Sony/ATV Music Publishing LLC, 424 Church Street, Suite 1200, Nashville, TN 37219
International Copyright Secured All Rights Reserved

I Will Always Love You

Words and Music by Dolly Parton
Copyright © 1973 Velvet Apple Music
Copyright Renewed
All Rights Administered by Sony/ATV Music Publishing LLC, 424 Church Street, Suite 1200, Nashville, TN 37219
International Copyright Secured All Rights Reserved

In The Mood

By Joe Garland
Copyright © 1939, 1960 Shapiro, Bernstein & Co., Inc., New York
Copyright Renewed

International Copyright Secured All Rights Reserved
Used by Permission

It Must Have Been Love

Words and Music by Per Gessle
Copyright © 1990 JIMMY FUN MUSIC
All Rights Administered in the United States and Canada
by UNIVERSAL - SONGS OF POLYGRAM INTERNATIONAL, INC.
All Rights Reserved Used by Permission

Just The Way You Are

Words and Music by Billy Joel
Copyright © 1977 IMPULSIVE MUSIC
Copyright Renewed
All Rights Administered by ALMO MUSIC CORP.
All Rights Reserved Used by Permission

La Bamba

By Richard Valenzuela
Copyright © 1959 EMI Longitude Music and Valens Heirs Designee
Copyright Renewed
All Rights Administered by Sony/ATV Music Publishing LLC,
424 Church Street, Suite 1200, Nashville, TN 37219
International Copyright Secured All Rights Reserved

Let It Go

from FROZEN
Music and Lyrics by Kristen Anderson-Lopez and Robert Lopez
© 2013 Wonderland Music Company, Inc.
All Rights Reserved. Used by Permission.

Let There Be Love

Lyric by Ian Grant
Music by Lionel Rand
Copyright © 1940 Shapiro, Bernstein & Co., Inc., New York
Copyright Renewed
International Copyright Secured
All Rights Reserved Used by Permission

Moon River

from the Paramount Picture BREAKFAST AT TIFFANY'S
Words by Johnny Mercer
Music by Henry Mancini
Copyright © 1961 Sony/ATV Music Publishing LLC
Copyright Renewed
All Rights Administered by Sony/ATV Music Publishing LLC,
424 Church Street, Suite 1200, Nashville, TN 37219
International Copyright Secured All Rights Reserved

Moves Like Jagger

Words and Music by Adam Levine, Benjamin Levin, Ammar Malik and
Shellback
Copyright © 2010, 2011 by Universal Music - Careers, Sudgee Music,
Matza Ball Music, Where Da Kasz At, Maru Cha Cha and MXM
All Rights for Sudgee Music Administered by Universal Music - Careers
All Rights for Matza Ball Music Administered by DTCM Blvd.
All Rights for Where Da Kasz At and Maru Cha Cha Administered
Worldwide by Song of Kobalt Music Publishing
All Rights for MXM Administered Worldwide by Kobalt Songs Music
Publishing
International Copyright Secured All Rights Reserved

My Heart Will Go On (Love Theme From "Titanic")

from the Paramount and Twentieth Century Fox Motion Picture
TITANIC
Music by James Horner
Lyric by Will Jennings
Copyright © 1997 Sony/ATV Harmony, Sony/ATV Melody, T C F Music
Publishing, Inc., Fox Film Music Corporation and Blue Sky Rider
Songs
All Rights on behalf of Sony/ATV Harmony and Sony/ATV Melody
Administered by Sony/ATV Music Publishing LLC, 424 Church
Street, Suite 1200, Nashville, TN 37219
All Rights on behalf of Blue Sky Rider Songs Administered by Irving
Music, Inc.
International Copyright Secured All Rights Reserved

Poker Face

Words and Music by Stefani Germanotta and RedOne
Copyright © 2008 Sony/ATV Music Publishing LLC, House Of Gaga
Publishing Inc. and RedOne Productions, LLC

All Rights Administered by Sony/ATV Music Publishing LLC,
424 Church Street, Suite 1200, Nashville, TN 37219
International Copyright Secured All Rights Reserved

Someone Like You

Words and Music by Adele Adkins and Dan Wilson
Copyright © 2011 MELTED STONE PUBLISHING LTD., BMG
MONARCH and SUGAR LAKE MUSIC
All Rights for MELTED STONE PUBLISHING LTD. in the U.S. and
Canada Controlled and Administered by UNIVERSAL - SONGS OF
POLYGRAM INTERNATIONAL, INC.
All Rights for BMG MONARCH and SUGAR LAKE MUSIC
Administered by BMG RIGHTS MANAGEMENT (US) LLC
All Rights Reserved Used by Permission

Spanish Eyes

Words by Charles Singleton and Eddie Snyder
Music by Bert Kaempfert
Copyright © 1965 Bert Kaempfert Music
Copyright Renewed
All Rights Administered by Sony/ATV Music Publishing LLC,
424 Church Street, Suite 1200, Nashville, TN 37219
International Copyright Secured All Rights Reserved

Unchained Melody

Lyric by Hy Zaret
Music by Alex North
© 1955 (Renewed) North Melody Publishing (SESAC) and HZUM
Publishing (SESAC) c/o Unchained Melody Publishing, LLC
All Rights Reserved Used by Permission

Up Where We Belong

from the Paramount Picture AN OFFICER AND A GENTLEMAN
Words by Will Jennings
Music by Buffy Sainte-Marie and Jack Nitzsche
Copyright © 1982 Sony/ATV Music Publishing LLC
All Rights Administered by Sony/ATV Music Publishing LLC,
424 Church Street, Suite 1200, Nashville, TN 37219
International Copyright Secured All Rights Reserved

What A Wonderful World

Words and Music by George David Weiss and Bob Thiele
Copyright © 1967 by Range Road Music Inc., Quartet Music and Abilene
Music, Inc.
Copyright Renewed
All Rights for Rang Road Music Inc. Administered by Round Hill Carlin,
LLC
All Rights for Quartet Music Administered by BMG Rights Management
(US) LLC
All Rights for Abilene Music, Inc. Administered Worldwide by Imagem
Music LLC
International Copyright Secured All Rights Reserved
Used by Permission

White Christmas

from the Motion Picture Irving Berlin's HOLIDAY INN
Words and Music by Irving Berlin
© Copyright 1940, 1942 by Irving Berlin
Copyright Renewed
International Copyright Secured All Rights Reserved

Wonderful Tonight

Words and Music by Eric Clapton
Copyright © 1977 by Eric Patrick Clapton
Copyright Renewed
International Copyright Secured All Rights Reserved

Wonderwall

Words and Music by Noel Gallagher
Copyright © 1995 SM Music Publishing UK Limited and Oasis Music
All Rights Administered by Sony/ATV Music Publishing LLC,
424 Church Street, Suite 1200, Nashville, TN 37219
International Copyright Secured All Rights Reserved

You've Lost That Lovin' Feelin'

Words and Music by Barry Mann, Cynthia Weil and Phil Spector
Copyright © 1964, 1965 Screen Gems-EMI Music Inc. and Mother Bertha
Music
Copyright Renewed
All Rights Administered by Sony/ATV Music Publishing LLC,
424 Church Street, Suite 1200, Nashville, TN 37219
International Copyright Secured All Rights Reserved

Apache License 2.0

Copyright (c) 2009-2018 Arm Limited. All rights reserved.

SPDX-License-Identifier: Apache-2.0

Licensed under the Apache License, Version 2.0 (the License); you may not use this file except in compliance with the License. You may obtain a copy of the License at www.apache.org/licenses/LICENSE-2.0

Unless required by applicable law or agreed to in writing, software distributed under the License is distributed on an AS IS BASIS, WITHOUT WARRANTIES OR CONDITIONS OF ANY KIND, either express or implied. See the License for the specific language governing permissions and limitations under the License.

Modified BSD license

COPYRIGHT(c) 2016 STMicroelectronics

Redistribution and use in source and binary forms, with or without modification, are permitted provided that the following conditions are met:

1. Redistributions of source code must retain the above copyright notice, this list of conditions and the following disclaimer.
2. Redistributions in binary form must reproduce the above copyright notice, this list of conditions and the following disclaimer in the documentation and/or other materials provided with the distribution.
3. Neither the name of STMicroelectronics nor the names of its contributors may be used to endorse or promote products derived from this software without specific prior written permission.

THIS SOFTWARE IS PROVIDED BY THE COPYRIGHT HOLDERS AND CONTRIBUTORS "AS IS" AND ANY EXPRESS OR IMPLIED WARRANTIES, INCLUDING, BUT NOT LIMITED TO, THE IMPLIED WARRANTIES OF MERCHANTABILITY AND FITNESS FOR A PARTICULAR PURPOSE ARE DISCLAIMED. IN NO EVENT SHALL THE COPYRIGHT HOLDER OR CONTRIBUTORS BE LIABLE FOR ANY DIRECT, INDIRECT, INCIDENTAL, SPECIAL, EXEMPLARY, OR CONSEQUENTIAL DAMAGES (INCLUDING, BUT NOT LIMITED TO, PROCUREMENT OF SUBSTITUTE GOODS OR SERVICES; LOSS OF USE, DATA, OR PROFITS; OR BUSINESS INTERRUPTION) HOWEVER CAUSED AND ON ANY THEORY OF LIABILITY, WHETHER IN CONTRACT, STRICT LIABILITY, OR TORT (INCLUDING NEGLIGENCE OR OTHERWISE) ARISING IN ANY WAY OUT OF THE USE OF THIS SOFTWARE, EVEN IF ADVISED OF THE POSSIBILITY OF SUCH DAMAGE.



Important Notice: U.S. LIMITED WARRANTY for Customers in the United States

For detailed information about this Yamaha product and warranty service, please either visit the following website address (printable file is available at our website) or contact Customer Service at the address or telephone number identified below.

Website Address:
yamaha.io/PSeriesWarranty

Customer Service:
Yamaha Corporation of America
6600 Orangethorpe Avenue, Buena Park, CA 90620-1273
Telephone: 800-854-1569

Important Notice: Guarantee Information for customers in European Economic Area (EEA) and Switzerland

| | |
|---|----------------|
| <p>Important Notice: Guarantee Information for customers in EEA* and Switzerland</p> <p>For detailed guarantee information about this Yamaha product, and Pan-EEA* and Switzerland warranty service, please either visit the website address below (Printable file is available at our website) or contact the Yamaha representative office for your country. * EEA: European Economic Area</p> | English |
| <p>Wichtiger Hinweis: Garantie-Information für Kunden in der EWR* und der Schweiz</p> <p>Für nähere Garantie-Information über dieses Produkt von Yamaha, sowie über den Pan-EWR*- und Schweizer Garantieservice, besuchen Sie bitte entweder die folgend angegebene Internetadresse (eine druckfähige Version befindet sich auch auf unserer Webseite), oder wenden Sie sich an den für Ihr Land zuständigen Yamaha-Vertrieb. *EWR: Europäischer Wirtschaftsraum</p> | Deutsch |
| <p>Remarque importante: informations de garantie pour les clients de l'EEE et la Suisse</p> <p>Pour des informations plus détaillées sur la garantie de ce produit Yamaha et sur le service de garantie applicable dans l'ensemble de l'EEE ainsi qu'en Suisse, consultez notre site Web à l'adresse ci-dessous (le fichier imprimable est disponible sur notre site Web) ou contactez directement Yamaha dans votre pays de résidence. * EEE : Espace Economique Européen</p> | Français |
| <p>Belangrijke mededeling: Garantie-informatie voor klanten in de EER* en Zwitserland</p> <p>Voor gedetailleerde garantie-informatie over dit Yamaha-product en de garantieservice in heel de EER* en Zwitserland, gaat u naar de onderstaande website (u vindt een afdrukbaar bestand op onze website) of neemt u contact op met de vertegenwoordiging van Yamaha in uw land. * EER: Europese Economische Ruimte</p> | Nederlands |
| <p>Aviso importante: información sobre la garantía para los clientes del EEE* y Suiza</p> <p>Para una información detallada sobre este producto Yamaha y sobre el soporte de garantía en la zona EEE* y Suiza, visite la dirección web que se incluye más abajo (la versión del archivo para imprimir esta disponible en nuestro sitio web) o póngase en contacto con el representante de Yamaha en su país. * EEE: Espacio Económico Europeo</p> | Español |
| <p>Avviso importante: informazioni sulla garanzia per i clienti residenti nell'EEA* e in Svizzera</p> <p>Per informazioni dettagliate sulla garanzia relativa a questo prodotto Yamaha e l'assistenza in garanzia nei paesi EEA* e in Svizzera, potete consultare il sito Web all'indirizzo riportato di seguito (è disponibile il file in formato stampabile) oppure contattare l'ufficio di rappresentanza locale della Yamaha. * EEA: Area Economica Europea</p> | Italiano |
| <p>Aviso importante: informações sobre as garantias para clientes da AEE* e da Suíça</p> <p>Para obter uma informação pormenorizada sobre este produto da Yamaha e o serviço de garantia na AEE* e na Suíça, visite o site a seguir (o arquivo para impressão está disponível no nosso site) ou entre em contato com o escritório de representação da Yamaha no seu país. * AEE: Área Económica Européia</p> | Português |
| <p>Σημαντική σημείωση: Πληροφορίες εγγύησης για τους πελάτες στον ΕΟΧ* και Ελλάδα</p> <p>Για λεπτομερείς πληροφορίες εγγύησης σχετικά με το παρόν προϊόν της Yamaha και την κάλυψη εγγύησης σε όλες τις χώρες του ΕΟΧ και την Ελλάδα, επισκεφτείτε την παρακάτω ιστοσελίδα (Εκτυπώσιμη μορφή είναι διαθέσιμη στην ιστοσελίδα μας) ή απευθυνθείτε στην αντιπροσωπεία της Yamaha στη χώρα σας. * ΕΟΧ: Ευρωπαϊκός Οικονομικός Χώρος</p> | Ελληνικά |
| <p>Viktigt: Garantiinformation för kunder i EES-området* och Schweiz</p> <p>För detaljerad information om denna Yamahaprodukt samt garantiservice i hela EES-området* och Schweiz kan du antingen besöka nedanstående webbadress (en utskriftsvänlig fil finns på webbplatsen) eller kontakta Yamahas officiella representant i ditt land. * EES: Europeiska Ekonomiska Samarbetsområdet</p> | Svenska |
| <p>Viktig merknad: Garantiinformasjon for kunder i EØS* og Sveits</p> <p>Detaljert garantiinformasjon om dette Yamaha-produktet og garantiservice for hele EØS-området* og Sveits kan fås enten ved å besøke nettstedene nedenfor (utskriftsversjon finnes på våre nettsider) eller kontakte Yamahas kontoret i landet der du bor. *EØS: Det europeiske økonomiske samarbeidsområdet</p> | Norsk |
| <p>Vigtig oplysning: Garantioplysninger til kunder i EØO* og Schweiz</p> <p>De kan finde detaljerede garantioplysninger om dette Yamaha-produkt og den fælles garantiserviceordning for EØO* (og Schweiz) ved at besøge det websted, der er angivet nedenfor (der findes en fil, som kan udskrives, på vores websted), eller ved at kontakte Yamahas nationale repræsentationskontor i det land, hvor De bor. * EØO: Det Europæiske Økonomiske Område</p> | Dansk |
| <p>Tärkeä ilmoitus: Takuutiedot Euroopan talusalueen (ETA)* ja Sveitsin asiakkaille</p> <p>Tämän Yamaha-tuotteen sekä ETA-alueen ja Sveitsin takuuta koskevat yksityiskohtaiset tiedot saatte alla olevasta nettiosoitteesta. (Tulostettava tiedosto saatavissa sivustollamme.) Voitte myös ottaa yhteyttä paikalliseen Yamaha-edustajaan. *ETA: Euroopan talusalue</p> | Suomi |
| <p>Ważne: Warunki gwarancyjne obowiązujące w EOG* i Szwajcarii</p> <p>Aby dowiedzieć się więcej na temat warunków gwarancyjnych tego produktu firmy Yamaha i serwisu gwarancyjnego w całym EOG* i Szwajcarii, należy odwiedzić wskazaną poniżej stronę internetową (Plik gotowy do wydruku znajduje się na naszej stronie internetowej) lub skontaktować się z przedstawicielstwem firmy Yamaha w swoim kraju. * EOG — Europejski Obszar Gospodarczy</p> | Polski |
| <p>Důležité oznámení: Záruční informace pro zákazníky v EHS* a ve Švýcarsku</p> <p>Podrobné záruční informace o tomto produktu Yamaha a záručním servisu v celém EHS* a ve Švýcarsku naleznete na níže uvedené webové adrese (soubor k tisku je dostupný na našich webových stránkách) nebo se můžete obrátit na zastoupení firmy Yamaha ve své zemi. * EHS: Evropský hospodářský prostor</p> | Česky |
| <p>Fontos figyelemzetés: Garancia-információk az EGT* területén és Svájcban élő vásárlók számára</p> <p>A jelen Yamaha termékre vonatkozó részletes garancia-információk, valamint az EGT*-re és Svájcra kiterjedő garanciális szolgáltatás tekintetében keresse fel webhelyünket az alábbi címen (a webhelyen nyomtatható fájl is talál), vagy pedig lépjen kapcsolatba az országában működő Yamaha képviselői irodával. * EGT: Európai Gazdasági Térség</p> | Magyar |
| <p>Oluline märkus: Garantiteave Euroopa Majanduspiirkonna (EMP)* ja Šveitsi klientidele</p> <p>Täpsema teabe saamiseks selle Yamaha toote garantii ning kogu Euroopa Majanduspiirkonna ja Šveitsi garantiiteeninduse kohta, külastage palun veebisaiti alljärgneval aadressil (meie saidil on saadaval printitav fail) või pöörduge Teie regiooni Yamaha esinduse poole. * EMP: Euroopa Majanduspiirkond</p> | Eesti keel |
| <p>Svarīgs paziņojums: garantijas informācija klientiem EEZ* un Šveicē</p> <p>Lai saņemtu detalizētu garantijas informāciju par šo Yamaha produktu, kā arī garantijas apkalpošanu EEZ* un Šveicē, lūdzam apmeklējiet zemāk norādīto tīmekļa vietnes adresi (tīmekļa vietni ir pieejams drukājams fails) vai sazinieties ar jūsu valsti apkalpojošo Yamaha pārstāvniecību. * EEZ: Eiropas Ekonomikas zona</p> | Latviešu |
| <p>Démesio: informacija dėl garantijos pirkėjams EEE* ir Šveicarijoje</p> <p>Jei reikia išsamios informacijos apie šį „Yamaha“ produktą ir jo techninę priežiūrą visoje EEE* ir Šveicarijoje, apsilankykite mūsų svetainėje toliau nurodytu adresu (svetainėje yra spausdintinas failas) arba kreipkitės į „Yamaha“ atstovybę savo šaliai. *EEE – Europos ekonominė erdvė</p> | Lietuvių kalba |
| <p>Dôležité upozornenie: Informácie o záruke pre zákazníkov v EHP* a Švajčiarsku</p> <p>Podrobné informácie o záruke týkajúce sa tohto produktu od spoločnosti Yamaha a garančnom servise v EHP* a Švajčiarsku nájdete na webovej stránke uvedenej nižšie (na našej webovej stránke je k dispozícii súbor na tlač) alebo sa obráťte na zástupcu spoločnosti Yamaha vo svojej krajine. * EHP: Európsky hospodársky priestor</p> | Slovenčina |
| <p>Pomembno obvestilo: Informacije o garanciji za kupce v EGP* in Švici</p> <p>Za podrobnejše informacije o tem Yamahinem izdelku ter garancijskem servisu v celotnem EGP in Švici, obiščite spletno mesto, ki je navedeno spodaj (natisljiva datoteka je na voljo na našem spletnem mestu), ali se obrnite na Yamahinega predstavnika v svoji državi. * EGP: Evropski gospodarski prostor</p> | Slovenščina |
| <p>Важно съобщение: Информация за гаранцията за клиенти в ЕИП* и Швейцария</p> <p>За подробна информация за гаранцията за този продукт на Yamaha и гаранционното обслужване в паневропейската зона на ЕИП* и Швейцария или посетете посочения по-долу уеб сайт (на нашия уеб сайт има файл за печат), или се свържете с представителния офис на Yamaha във вашата страна. * ЕИП: Европейско икономическо пространство</p> | Български език |
| <p>Notificare importantă: Informații despre garanție pentru clienții din SEE* și Elveția</p> <p>Pentru informații detaliate privind acest produs Yamaha și serviciul de garanție Pan-SEE* și Elveția, vizitați site-ul la adresa de mai jos (fișierul imprimabil este disponibil pe site-ul nostru) sau contactați biroul reprezentanței Yamaha din țara dumneavoastră. * SEE: Spațiul Economic European</p> | Limba română |
| <p>Važna obavijest: Informacije o jamstvu za države EGP-a i Švicarske</p> <p>Za detaljne informacije o jamstvu za ovaj Yamahin proizvod te jamstvenom servisu za cijeli EGP i Švicarsku, molimo Vas da posjetite web-stranicu navedenu u nastavku ili kontaktirate ovlaštenog Yamahinog dobavljača u svojoj zemlji. * EGP: Evropski gospodarski prostor</p> | Hrvatski |

<https://europe.yamaha.com/warranty/>

For details of products, please contact your nearest Yamaha representative or the authorized distributor listed below.

Pour plus de détails sur les produits, veuillez-vous adresser à Yamaha ou au distributeur le plus proche de vous figurant dans la liste suivante.

Die Einzelheiten zu Produkten sind bei Ihrer unten aufgeführten Niederlassung und bei Yamaha Vertragshändlern in den jeweiligen Bestimmungsländern erhältlich.

Para detalles sobre productos, contacte su tienda Yamaha más cercana o el distribuidor autorizado que se lista debajo.

NORTH AMERICA

CANADA

Yamaha Canada Music Ltd.
135 Milner Avenue, Toronto, Ontario M1S 3R1,
Canada
Tel: +1-416-298-1311

U.S.A.

Yamaha Corporation of America
6600 Orangethorpe Avenue, Buena Park, CA 90620,
U.S.A.
Tel: +1-714-522-9011

CENTRAL & SOUTH AMERICA

MEXICO

Yamaha de México, S.A. de C.V.
Av. Insurgentes Sur 1647 Piso 9, Col. San José
Insurgentes, Delegación Benito Juárez, México,
D.F., C.P. 03900, México
Tel: +52-55-5804-0600

BRAZIL

Yamaha Musical do Brasil Ltda.
Praça Professor José Lannes, 40, Cjs 21 e 22, Brooklin
Paulista Novo CEP 04571-100 – São Paulo – SP,
Brazil
Tel: +55-11-3704-1377

ARGENTINA

**Yamaha Music Latin America, S.A.,
Sucursal Argentina**
Olga Cossetini 1553, Piso 4 Norte,
Madero Este-C1107CEK,
Buenos Aires, Argentina
Tel: +54-11-4119-7000

PANAMA AND OTHER LATIN AMERICAN REGIONS/ CARIBBEAN REGIONS

Yamaha Music Latin America, S.A.
Edificio Torre Davivienda, Piso: 20
Avenida Balboa, Marbella, Corregimiento de Bella
Vista, Ciudad de Panamá, Rep. de Panamá
Tel: +507-269-5311

EUROPE

THE UNITED KINGDOM/IRELAND

Yamaha Music Europe GmbH (UK)
Sherbourne Drive, Tilbrook, Milton Keynes,
MK7 8BL, U.K.
Tel: +44-1908-366700

GERMANY

Yamaha Music Europe GmbH
Siemensstrasse 22-34, 25462 Rellingen, Germany
Tel: +49-4101-303-0

SWITZERLAND/LIECHTENSTEIN

**Yamaha Music Europe GmbH, Branch
Switzerland in Thalwil**
Seestrasse 18a, 8800 Thalwil, Switzerland
Tel: +41-44-3878080

AUSTRIA/CROATIA/CZECH REPUBLIC/ HUNGARY/ROMANIA/SLOVAKIA/ SLOVENIA

Yamaha Music Europe GmbH, Branch Austria
Schleiergasse 20, 1100 Wien, Austria
Tel: +43-1-60203900

POLAND

**Yamaha Music Europe
Sp.z o.o. Oddział w Polsce**
ul. Wielicka 52, 02-657 Warszawa, Poland
Tel: +48-22-880-08-88

BULGARIA

Dinacord Bulgaria LTD.
Bul. Iskarsko Schose 7 Targowski Zentar Ewropa
1528 Sofia, Bulgaria
Tel: +359-2-978-20-25

MALTA

Olimpus Music Ltd.
Valletta Road, Mosta MST9010, Malta
Tel: +356-2133-2093

NETHERLANDS/BELGIUM/ LUXEMBOURG

Yamaha Music Europe, Branch Benelux
Clarissenhof 5b, 4133 AB Vianen, The Netherlands
Tel: +31-347-358040

FRANCE

Yamaha Music Europe
7 rue Ambroise Croizat, Zone d'activités de Pariest,
77183 Croissy-Beaubourg, France
Tel: +33-1-6461-4000

ITALY

Yamaha Music Europe GmbH, Branch Italy
Via Tinelli N.67/69 20855 Gerno di Lesmo (MB),
Italy
Tel: +39-039-9065-1

SPAIN/PORTUGAL

**Yamaha Music Europe GmbH Ibérica, Sucursal
en España**
Ctra. de la Coruña km. 17,200, 28231
Las Rozas de Madrid, Spain
Tel: +34-91-639-88-88

GREECE

Philippos Nakas S.A. The Music House
19th km. Leof. Lavriou 190 02 Peania – Attiki,
Greece
Tel: +30-210-6686260

SWEDEN

**Yamaha Music Europe GmbH Germany filial
Scandinavia**
JA Wettergrensgata 1, 400 43 Göteborg, Sweden
Tel: +46-31-89-34-00

DENMARK

**Yamaha Music Denmark,
Fillial of Yamaha Music Europe GmbH, Tyskland**
Generatorvej 8C, ST. TH., 2860 Søborg, Denmark
Tel: +45-44-92-49-00

FINLAND

F-Musiikki Oy
Antaksentie 4
FI-01510 Vantaa, Finland
Tel: +358 (0)96185111

NORWAY

**Yamaha Music Europe GmbH Germany -
Norwegian Branch**
Grini Næringspark 1, 1332 Østerås, Norway
Tel: +47-6716-7800

ICELAND

Hjodfaerahusid Ehf.
Sidumula 20
IS-108 Reykjavik, Iceland
Tel: +354-525-5050

CYPRUS

Nakas Music Cyprus Ltd.
Nikis Ave 2k
1086 Nicosia
Tel: +357-22-511080
Major Music Center
21 Ali Riza Ave. Ortakoy
P.O.Box 475 Lefkoşa, Cyprus
Tel: (392) 227 9213

RUSSIA

Yamaha Music (Russia) LLC.
Room 37, entrance 7, bld. 7, Kievskaya street,
Moscow, 121059, Russia
Tel: +7-495-626-5005

OTHER EUROPEAN REGIONS

Yamaha Music Europe GmbH
Siemensstrasse 22-34, 25462 Rellingen, Germany
Tel: +49-4101-303-0

AFRICA

Yamaha Music Gulf FZE
JAFZA-16, Office 512, P.O.Box 17328,
Jebel Ali FZE, Dubai, UAE
Tel: +971-4-801-1500

MIDDLE EAST

TURKEY

**Yamaha Music Europe GmbH
Merkezi Almanya Türkiye İstanbul Şubesi**
Mor Sumbul Sokak Varyap Meridian Business
1.Blok No:1 113-114-115
Bati Atasehir Istanbul, Turkey
Tel: +90-216-275-7960

ISRAEL

RBX International Co., Ltd.
P.O Box 10245, Petach-Tikva, 49002
Tel: (972) 3-925-6900

OTHER REGIONS

Yamaha Music Gulf FZE
JAFZA-16, Office 512, P.O.Box 17328,
Jebel Ali FZE, Dubai, UAE
Tel: +971-4-801-1500

ASIA

THE PEOPLE'S REPUBLIC OF CHINA

Yamaha Music & Electronics (China) Co., Ltd.
2F, Yunhedasha, 1818 Xinzha-lu, Jingan-qu,
Shanghai, China
Tel: +86-400-051-7700

HONG KONG

Tom Lee Music Co., Ltd.
11/F., Silvercord Tower 1, 30 Canton Road,
Tsimshatsui, Kowloon, Hong Kong
Tel: +852-2737-7688

INDIA

Yamaha Music India Private Limited
P-401, JMD Megapolis, Sector-48, Sohna Road,
Gurugram-122018, Haryana, India
Tel: +91-124-485-3300

INDONESIA

PT. Yamaha Musik Indonesia (Distributor)
Yamaha Music Center Bldg. Jalan Jend. Gatot
Subroto Kav. 4, Jakarta 12930, Indonesia
Tel: +62-21-520-2577

KOREA

Yamaha Music Korea Ltd.
11F, Prudential Tower, 298, Gangnam-daero,
Gangnam-gu, Seoul, 06253, Korea
Tel: +82-2-3467-3300

MALAYSIA

Yamaha Music (Malaysia) Sdn. Bhd.
No.8, Jalan Perbandaran, Kelana Jaya, 47301
Petaling Jaya, Selangor, Malaysia
Tel: +60-3-78030900

SINGAPORE

Yamaha Music (Asia) Private Limited
Block 202 Hougang Street 21, #02-00,
Singapore 530202, Singapore
Tel: +65-6740-9200

TAIWAN

Yamaha Music & Electronics Taiwan Co., Ltd.
2F., No.1, Yuanlong Rd., Banqiao Dist.,
New Taipei City 22063, Taiwan (R.O.C.)
Tel: +886-2-7741-8888

THAILAND

Siam Music Yamaha Co., Ltd.
3, 4, 15, 16th Fl., Siam Motors Building,
891/1 Rama 1 Road, Wangmai,
Pathumwan, Bangkok 10330, Thailand
Tel: +66-2215-2622

VIETNAM

Yamaha Music Vietnam Company Limited
15th Floor, Nam A Bank Tower, 201-203 Cach
Mang Thang Tam St., Ward 4, Dist.3,
Ho Chi Minh City, Vietnam
Tel: +84-28-3818-1122

OTHER ASIAN REGIONS

[https://asia-latinamerica-mea.yamaha.com/
index.html](https://asia-latinamerica-mea.yamaha.com/index.html)

OCEANIA

AUSTRALIA

Yamaha Music Australia Pty. Ltd.
Level 1, 80 Market Street, South Melbourne,
VIC 3205 Australia
Tel: +61-3-9693-5111

NEW ZEALAND

Music Works LTD
P.O. BOX 6246 Wellesley, Auckland 4680,
New Zealand
Tel: +64-9-634-0099

REGIONS AND TRUST

TERRITORIES IN PACIFIC OCEAN
[https://asia-latinamerica-mea.yamaha.com/
index.html](https://asia-latinamerica-mea.yamaha.com/index.html)

Yamaha Global Site

<https://www.yamaha.com/>

Yamaha Downloads

<https://download.yamaha.com/>

Manual Development Group
© 2020 Yamaha Corporation

Published 10/2020 MWMA*.*- **A0

VDQ8160