

# COLOrband H9 ILS

## User Manual



**TABLE OF CONTENTS**

<b>1. Before You Begin .....</b>	<b>1</b>
What Is Included .....	1
Unpacking Instructions.....	1
Claims .....	1
Text Conventions .....	1
Symbols .....	1
Disclaimer .....	1
Intellectual Property .....	1
Safety Notes.....	2
<b>2. Introduction.....</b>	<b>3</b>
Product Overview.....	3
Product Dimensions.....	3
<b>3. Setup.....</b>	<b>4</b>
AC Power .....	4
Fuse Replacement.....	4
Power Linking.....	4
Mounting .....	5
Orientation.....	5
Rigging .....	5
<b>4. Operation.....</b>	<b>6</b>
Control Panel Operation.....	6
Menu Map .....	6
Configuration (DMX) .....	7
DMX Personality and Starting Address.....	7
D-Fi USB Connectivity .....	7
D-Fi USB Compatibility .....	7
Configuration (D-Fi USB).....	7
D-Fi USB DIP Switch Channels .....	8
DMX Channel Assignments and Values .....	9
Zones for DMX Control .....	9
Single Zone Modes .....	11
Configuration (Standalone) .....	12
Static Color Mode.....	12
Automatic Program .....	12
Auto Program Speed .....	12
Sound-Active Programs .....	12
Sound Sensitivity.....	12
Custom Color Mixing.....	12
Dimmer.....	12
RF Control.....	13
Factory Reset.....	13
Master/Slave Mode (D-Fi USB).....	13
ILS Mode.....	13
<b>5. Maintenance.....</b>	<b>14</b>
Product Maintenance .....	14
<b>6. Technical Specifications.....</b>	<b>15</b>
<b>Warranty &amp; Returns.....</b>	<b>16</b>
Limited Warranty .....	16
Returns.....	16
<b>Contact Us.....</b>	<b>17</b>

# 1. Before You Begin

## What Is Included

- COLORband H9 ILS
- Power cable
- Hanging bracket
- Quick Reference Guide

## Unpacking Instructions

Carefully unpack the product immediately and check the container to make sure all the parts are in the package and are in good condition.

### Claims



If the box or the contents (the product and included accessories) appear damaged from shipping, or show signs of mishandling, notify the carrier immediately, not Chauvet. Failure to report damage to the carrier immediately may invalidate your claim. In addition, keep the box and contents for inspection.

For other issues, such as missing components or parts, damage not related to shipping, or concealed damage, file a claim with Chauvet within 7 days of delivery.

## Text Conventions

Convention	Meaning
<b>1–512</b>	A range of values
<b>50/60</b>	A set of values of which only one can be chosen
<b>Settings</b>	A menu option not to be modified
<b>&lt;ENTER&gt;</b>	A key to be pressed on the product’s control panel
<b>ON</b>	A value to be entered or selected

## Symbols

Symbol	Meaning
	Critical installation, configuration, or operation information. Not following these instructions may make the product not work, cause damage to the product, or cause harm to the operator.
	Important installation or configuration information. The product may not function correctly if this information is not used.
	Useful information.

## Disclaimer

Chauvet believes that the information contained in this manual is accurate in all respects. However, Chauvet assumes no responsibility and specifically disclaims any and all liability to any party for any loss, damage or disruption caused by any errors or omissions in this document, whether such errors or omissions result from negligence, accident or any other cause. Chauvet reserves the right to revise the content of this document without any obligation to notify any person or company of such revision, however, Chauvet has no obligation to make, and does not commit to make, any such revisions. Download the latest version from [www.chauvetdj.com](http://www.chauvetdj.com).

## Intellectual Property

The works of authorship contained in this manual, including, but not limited to, all design, text and images are owned by Chauvet.

© Copyright 2023 Chauvet & Sons, LLC. All rights reserved.

Electronically published by Chauvet in the United States of America.

CHAUVET, the Chauvet logo, and COLORband H9 ILS are registered trademarks or trademarks of Chauvet & Sons LLC (d/b/a Chauvet and Chauvet Lighting) in the United States and other countries. Other company and product names and logos referred to herein may be trademarks of their respective companies.

## Safety Notes

- In the event of a serious operating problem, stop using immediately.
- **DO NOT:**
  - ◆ Open this product or attempt any repairs. It contains no user-serviceable parts.
  - ◆ Look at the light source when the product is on.
  - ◆ Use if the power cord is crimped or damaged.
  - ◆ Disconnect by pulling on the power cord.
  - ◆ Allow flammable materials close to the product when it is operating.
  - ◆ Touch the housing when it is on.
  - ◆ Block any ventilation holes/slots in the housing.
  - ◆ Connect to a dimmer or rheostat.
  - ◆ Carry the product by its power cord.
  - ◆ Operate in temperatures higher than 104°F (40°C).
  - ◆ Expose to environments that exceed the Ingress Protection (IP) rating.
  - ◆ Expose to rain or moisture.
  - ◆ Use outdoors.
  - ◆ Submerge.
  - ◆ Expose to corrosive environmental conditions such as temperature, humidity, salinity, pressure, radiation, or shock.
  - ◆ Set this product on a flammable surface.



- **ALWAYS:**
  - ◆ Connect to a grounded circuit.
  - ◆ Connect to operating voltages as specified on the product's spec sticker.
  - ◆ Disconnect from power before replacing the fuse.
  - ◆ Disconnect from its power source during periods of inactivity.
  - ◆ Use a safety cable when suspending overhead.
  - ◆ Heed all restrictions and warnings on the spec sticker.
  - ◆ Mount in a location with at least 20 in (50 cm) of ventilation.
  - ◆ Replace the fuse with the same type and rating.



Keep this User Manual for future use. If the product is sold to someone else, be sure that they also receive this document.

## 2. Introduction

### Product Overview

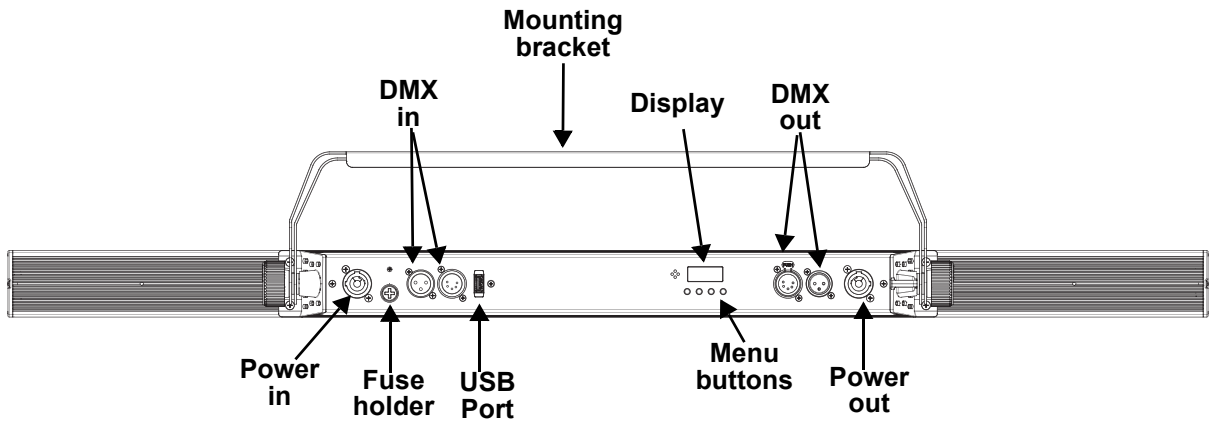

**WARNING! DO NOT** plug anything other than a D-Fi USB into the USB port. Doing so may cause damage to the product.

### Product Dimensions

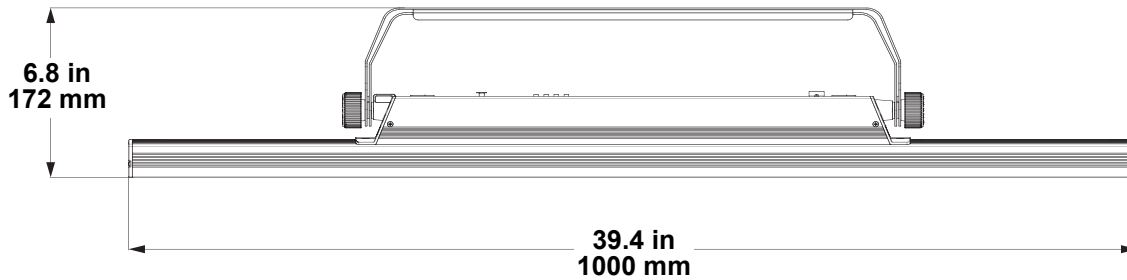

### 3. Setup

#### AC Power

The COLORband H9 ILS has an auto-ranging power supply, and it can work with an input voltage range of 100 to 240 VAC, 50/60 Hz.

To determine the product's power requirements (circuit breaker, power outlet, and wiring), use the current value listed on the label affixed to the product's back panel, or refer to the product's specifications chart.

The listed current rating indicates the product's average current draw under normal conditions.



- **Always connect the product to a protected circuit (a circuit breaker or fuse). Make sure the product has an appropriate electrical ground to avoid the risk of electrocution or fire.**
- **To eliminate unnecessary wear and improve its lifespan, during periods of non-use completely disconnect the product from power via breaker or by unplugging it.**



**Never connect the product to a rheostat (variable resistor) or dimmer circuit, even if the rheostat or dimmer channel serves only as a 0 to 100% switch.**

#### Fuse Replacement

1. Disconnect the product from power.
2. Using a Phillips-head screwdriver, unscrew the fuse holder and pull it straight out.
3. Remove the blown fuse from the holder and replace with a fuse of the exact same type and rating.
4. Re-insert the fuse holder and reconnect power.

#### Power Linking

The product provides power linking via the outlet located in the back of the product. See the diagram below for further explanation.

#### Power Linking Diagram

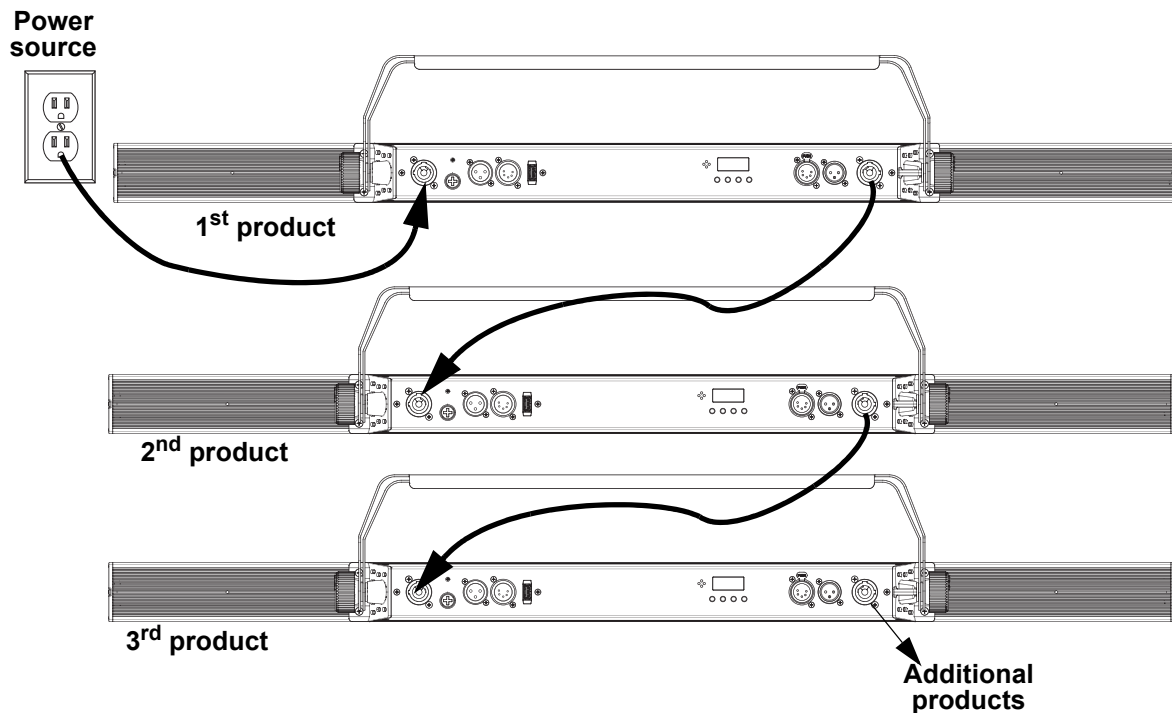

**It is possible to link up to 12 COLORband H9 ILS products on 120 VAC or up to 21 products on 230 VAC.**

## Mounting

Before mounting the product, read and follow the safety recommendations indicated in the [Safety Notes](#).

### Orientation

The COLORband H9 ILS may be mounted in any position; however, make sure adequate ventilation is provided around the product.

### Rigging

- Before deciding on a location, always make sure there is easy access to the product for maintenance and programming.
- Make sure adequate ventilation is provided around the product.
- Make sure that the structure or surface onto which you are mounting the product can support the product's weight (see the [Technical Specifications](#)).
- When mounting the product overhead, always use a safety cable. Mount the product securely to a rigging point, whether an elevated platform or a truss.
- When rigging the product onto a truss, use a mounting clamp of appropriate weight capacity.
- When power linking multiple products, mount the products close enough for power-linking cables to reach.
- The bracket adjustment knobs allow for directional adjustment when aiming the product to the desired angle. Only loosen or tighten the bracket knobs manually. Using tools could damage the knobs.

### Mounting Diagram

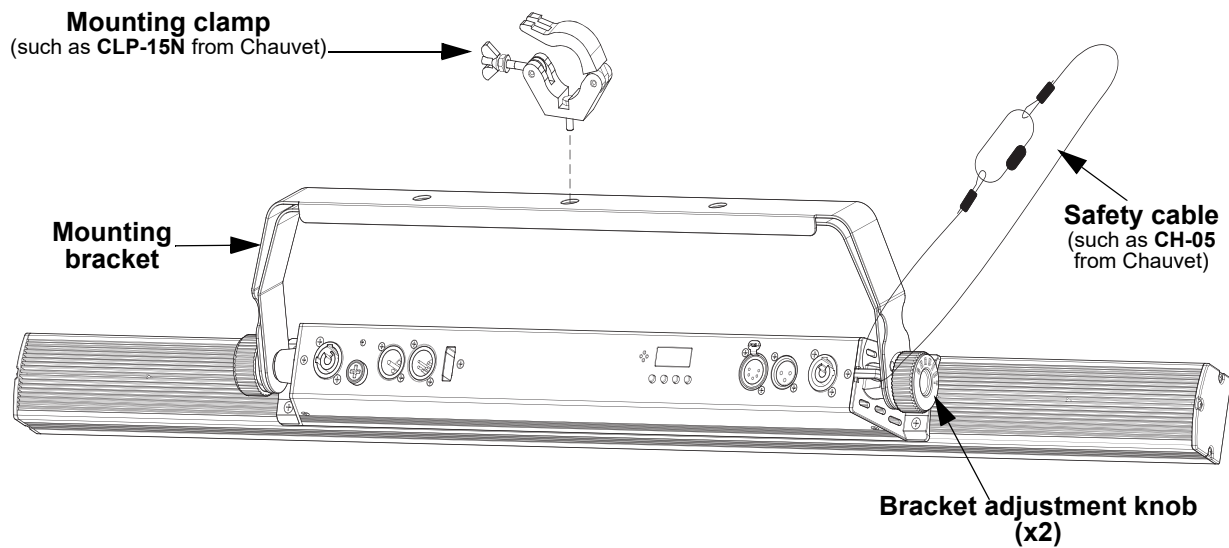

## 4. Operation

### Control Panel Operation

To access the control panel functions, use the four buttons located underneath the display. Refer to the [Product Overview](#) to see the button locations on the control panel.

Button	Function
<MENU>	Exits from the current menu or function
<UP>	Navigates upwards through the menu list or increases a selected numeric value
<DOWN>	Navigates downwards through the menu list or decreases a selected numeric value
<ENTER>	Enables the currently displayed menu or sets a selected value into the selected function

### Menu Map

Refer to the COLORband H9 ILS product page on [www.chauvetdj.com](http://www.chauvetdj.com) for the latest menu map.

Mode	Programming Levels		Description	
DMX Mode	6-Ch	d 1–507	6-channel DMX mode (see <a href="#">Single Zone Modes</a> )	
	9-Ch	d 1–504	9-channel DMX mode (see <a href="#">Single Zone Modes</a> )	
	11Ch	d 1–502	11-channel DMX mode (see <a href="#">Single Zone Modes</a> )	
	18Ch	d 1–495	18-channel DMX mode (see <a href="#">3-Zone Modes</a> )	
	23Ch	d 1–490	23-channel DMX mode (see <a href="#">3-Zone Modes</a> )	
ILS Mode	iLS	iLS1–4	Sets ILS mode	
Static Color	C--	C 1–63	Static colors	
Programs	P--	P 1–14	Automatic programs	
Speed	S--	S. 1–100	Automatic program speed	
Sound Mode	Snd	Snd	Sound-active program	
Sensitivity	Sens	u 0–100	Sound sensitivity	
Manual Mode	U--	r. 0–255	Combine red, green, blue, amber, white, and UV for a custom static color	
		G. 0–255		
		b. 0–255		
		A. 0–255		
		W. 0–255		
		P. 0–255		
Dimmer Speed	dIM	oFF	Sets the dimmer speed	
		dIM1–3		
RF Control	SEt	RF	oFF	Disables RFC remote control
			Link	Link to a single remote by pressing and holding <freeze>, (RFC) or <BLACK OUT> (RFC-XL) until the display shows <b>PASS</b> (success) or <b>ErrO</b> (failure)
			PubL	Public mode, control with any RFC or RFC-XL remote
			GP1–4	Sets to an RFC-XL remote receiving group
		REST	Reset to factory default settings	



### Configuration (DMX)

Set the product in DMX mode to control with a DMX controller.

1. Connect the product to a suitable power outlet.
2. Connect a DMX cable from the DMX output of the DMX controller to the DMX input socket on the product.

### DMX Personality and Starting Address

When selecting a starting DMX address, always consider the number of DMX channels the selected DMX mode uses. If the starting address is set too high, access to some of the product's channels could be restricted.

The COLORband H9 ILS uses up to 23 DMX channels in a 23-Ch DMX mode, which defines the highest configurable address to **490**.

For information about the DMX protocol, download the DMX Primer from [www.chauvetdj.com](http://www.chauvetdj.com).

To select the starting address, do the following:

1. Press **<MENU>** repeatedly until **6Ch**, **9Ch**, **11Ch**, **18Ch**, or **23Ch** shows on the display.
2. Press **<ENTER>** and **d 1-507** will show on the display.
3. Use **<UP>** or **<DOWN>** to select the starting address.
4. Press **<ENTER>**.

### D-Fi USB Connectivity

The COLORband H9 ILS is able to become a D-Fi wireless receiver/transmitter with the use of the D-Fi USB from Chauvet DJ. Simply set the product's DMX Personality and DMX Address, set the DIP switch D-Fi receiving/transmitting channel, then plug it into the D-Fi USB port.



**WARNING! DO NOT plug anything other than a D-Fi USB into the USB port. Doing so may cause damage to the product.**



**Once plugged in, the D-Fi USB will take over the product. Wired DMX and manual display control / menu buttons will be unavailable until you unplug the D-Fi USB. The priority**

**levels are:**

1. **D-Fi USB**
2. **Wired DMX**
3. **Manual Digital Display/Menu Buttons**

### D-Fi USB Compatibility

The D-Fi USB can receive a DMX signal from the D-Fi Hub and the FlareCON Air 2 as well as other D-Fi USB products.

### Configuration (D-Fi USB)

1. Set the DMX Personality and DMX address on the COLORband H9 ILS.
2. Use the Chart provided to set **BOTH**:
  - the Channel, and then
  - The Receiving or Transmitting option

**NOTE: DIP Switch 5 is for Transmitting OR Receiving, please choose carefully.**

### D-Fi USB DIP Switch Channels

Receiving					Receiving					Transmitting					Transmitting								
Ch.	1	2	3	4	T/R	Ch.	1	2	3	4	T/R	Ch.	1	2	3	4	T/R	Ch.	1	2	3	4	T/R
1	■	■	■	■	■	9	■	■	■	■	■	1	■	■	■	■	■	9	■	■	■	■	■
2	■	■	■	■	■	10	■	■	■	■	■	2	■	■	■	■	■	10	■	■	■	■	■
3	■	■	■	■	■	11	■	■	■	■	■	3	■	■	■	■	■	11	■	■	■	■	■
4	■	■	■	■	■	12	■	■	■	■	■	4	■	■	■	■	■	12	■	■	■	■	■
5	■	■	■	■	■	13	■	■	■	■	■	5	■	■	■	■	■	13	■	■	■	■	■
6	■	■	■	■	■	14	■	■	■	■	■	6	■	■	■	■	■	14	■	■	■	■	■
7	■	■	■	■	■	15	■	■	■	■	■	7	■	■	■	■	■	15	■	■	■	■	■
8	■	■	■	■	■	16	■	■	■	■	■	8	■	■	■	■	■	16	■	■	■	■	■

## DMX Channel Assignments and Values

### Zones for DMX Control

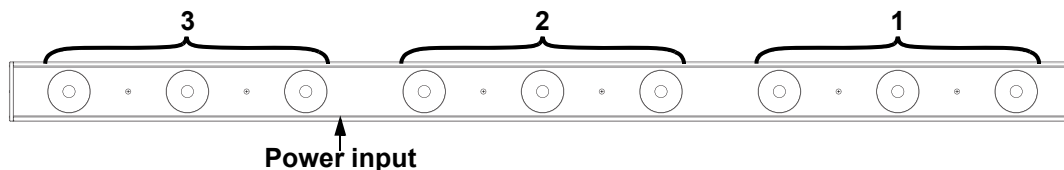

18Ch	23Ch	Function	Value	Percent/Setting
1	1	Red 1	000 ⇔ 255	0–100%
2	2	Green 1	000 ⇔ 255	0–100%
3	3	Blue 1	000 ⇔ 255	0–100%
4	4	Amber 1	000 ⇔ 255	0–100%
5	5	White 1	000 ⇔ 255	0–100%
6	6	Ultraviolet 1	000 ⇔ 255	0–100%
7	7	Red 2	000 ⇔ 255	0–100%
8	8	Green 2	000 ⇔ 255	0–100%
9	9	Blue 2	000 ⇔ 255	0–100%
10	10	Amber 2	000 ⇔ 255	0–100%
11	11	White 2	000 ⇔ 255	0–100%
12	12	Ultraviolet 2	000 ⇔ 255	0–100%
13	13	Red 3	000 ⇔ 255	0–100%
14	14	Green 3	000 ⇔ 255	0–100%
15	15	Blue 3	000 ⇔ 255	0–100%
16	16	Amber 3	000 ⇔ 255	0–100%
17	17	White 3	000 ⇔ 255	0–100%
18	18	Ultraviolet 3	000 ⇔ 255	0–100%
–	19	Color macros	000 ⇔ 014	No function
			015 ⇔ 255	Color macros
–	20	Strobe (when Ch. 21 is 000 ⇔ 031)	000 ⇔ 015	No function
			016 ⇔ 255	Strobe, slow to fast
		Program speed (when Ch. 21 is 032 ⇔ 226)	000 ⇔ 255	Program speed, slow to fast
		Sound sensitivity (when Ch. 21 is 227 ⇔ 255)	000 ⇔ 010	Sound sensitivity off
			011 ⇔ 255	Sound sensitivity, low to high

18Ch	23Ch	Function	Value	Percent/Setting
-	21	Program	000 ⇔ 031	No function
			032 ⇔ 063	Pulse effect, 0-100%
			064 ⇔ 095	Pulse effect, 100-0%
			096 ⇔ 114	Pulse effect, 100-0-100%
			115 ⇔ 122	Automatic program 1
			123 ⇔ 130	Automatic program 2
			131 ⇔ 138	Automatic program 3
			139 ⇔ 146	Automatic program 4
			147 ⇔ 154	Automatic program 5
			155 ⇔ 162	Automatic program 6
			163 ⇔ 170	Automatic program 7
			171 ⇔ 178	Automatic program 8
			179 ⇔ 186	Automatic program 9
			187 ⇔ 194	Automatic program 10
			195 ⇔ 202	Automatic program 11
			203 ⇔ 210	Automatic program 12
211 ⇔ 218	Automatic program 13			
219 ⇔ 226	Automatic program 14			
227 ⇔ 255	Sound-active program			
-	22	Dimmer	000 ⇔ 255	0–100%
-	23	Dimmer speed	000 ⇔ 051	Dimmer speed set from display menu
			052 ⇔ 101	Dimmer speed mode off
			102 ⇔ 152	Dimmer speed mode 1 (fast)
			153 ⇔ 203	Dimmer speed mode 2 (medium)
			204 ⇔ 255	Dimmer speed mode 3 (slow)

Single Zone Modes

6-Ch	9-Ch	11Ch	Function	Value	Percent/Setting
1	1	1	Red	000 ⇔ 255	0–100%
2	2	2	Green	000 ⇔ 255	0–100%
3	3	3	Blue	000 ⇔ 255	0–100%
4	4	4	Amber	000 ⇔ 255	0–100%
5	5	5	White	000 ⇔ 255	0–100%
6	6	6	Ultraviolet	000 ⇔ 255	0–100%
–	–	7	Color macros	000 ⇔ 014	No function
–	–	–		015 ⇔ 255	Color macros
–	7	–	Dimmer	000 ⇔ 255	0–100%
–	8	8	Strobe (when Ch. 9 is 000 ⇔ 031)	000 ⇔ 015	No function
	016 ⇔ 255			Strobe, slow to fast	
	–		–	Program speed (when Ch. 9 is 032 ⇔ 226)	000 ⇔ 255
–	–	8	Sound sensitivity (when Ch. 9 is 227 ⇔ 255)	000 ⇔ 010	Sound sensitivity off
				011 ⇔ 255	Sound sensitivity, low to high
–	–	9	Program	000 ⇔ 031	No function
				032 ⇔ 063	Pulse effect, 0-100%
				064 ⇔ 095	Pulse effect, 100-0%
				096 ⇔ 114	Pulse effect, 100-0-100%
				115 ⇔ 122	Automatic program 1
				123 ⇔ 130	Automatic program 2
				131 ⇔ 138	Automatic program 3
				139 ⇔ 146	Automatic program 4
				147 ⇔ 154	Automatic program 5
				155 ⇔ 162	Automatic program 6
				163 ⇔ 170	Automatic program 7
				171 ⇔ 178	Automatic program 8
				179 ⇔ 186	Automatic program 9
				187 ⇔ 194	Automatic program 10
				195 ⇔ 202	Automatic program 11
203 ⇔ 210	Automatic program 12				
211 ⇔ 218	Automatic program 13				
219 ⇔ 226	Automatic program 14				
227 ⇔ 255	Sound-active program				
–	–	10	Dimmer	000 ⇔ 255	0–100%
–	9	11	Dimmer speed	000 ⇔ 051	Dimmer speed set from display menu
				052 ⇔ 101	Dimmer speed mode off
				102 ⇔ 152	Dimmer speed mode 1 (fast)
				153 ⇔ 203	Dimmer speed mode 2 (medium)
–	–	–	–	204 ⇔ 255	Dimmer speed mode 3 (slow)

## Configuration (Standalone)

Set the product in the standalone mode to control without a DMX controller.



**Never connect a product that is operating in any standalone mode to a DMX string connected to a DMX controller. Products in standalone mode may transmit DMX signals that could interfere with the DMX signals from the controller.**

### Static Color Mode

To run the COLORband H9 ILS on a static color, follow the instructions below.

1. Press **<MENU>** repeatedly until **C--** shows on the display.
2. Press **<ENTER>**.
3. Use **<UP>** or **<DOWN>** to select a static color, from **C 1–63**.
4. Press **<ENTER>**.

### Automatic Program

To run a program on the COLORband H9 ILS, follow the instructions below.

1. Press **<MENU>** repeatedly until **P--** shows on the display.
2. Press **<ENTER>**.
3. Use **<UP>** or **<DOWN>** to select an automatic program, from **P 1–14**.
4. Press **<ENTER>**.

### Auto Program Speed

To adjust the auto program speed on the COLORband H9 ILS, do the following:

1. Press **<MENU>** repeatedly until **S--** shows on the display.
2. Use **<UP>** or **<DOWN>** to increase or decrease the program speed, from **S. 001–100**.
3. Press **<ENTER>**.

### Sound-Active Programs

To run the COLORband H9 ILS with a sound-active program, follow the instructions below.

1. Press **<MENU>** repeatedly until **Snd** shows on the display.
2. Press **<ENTER>**.

### Sound Sensitivity

To set the sound sensitivity on the COLORband H9 ILS, do the following:

1. Press **<MENU>** repeatedly until **SenS** shows on the display.
2. Use **<UP>** or **<DOWN>** to increase or decrease the sound sensitivity, from **U.0–100**.
3. Press **<ENTER>**.

### Custom Color Mixing

To mix a custom color on the COLORband H9 ILS, do the following:

1. Press **<MENU>** repeatedly until **u--** shows on the display.
2. Press **<ENTER>** and one of the following will show on the display:
  - **r. \_\_\_** (red)
  - **G. \_\_\_** (green)
  - **b. \_\_\_** (blue)
  - **A. \_\_\_** (amber)
  - **W. \_\_\_** (white)
  - **P. \_\_\_** (ultraviolet)
3. Press **<ENTER>** to cycle through the options.
4. Use **<UP>** or **<DOWN>** to increase or decrease the selected value, from **0–255**.
5. Repeat steps 3 and 4 until the color is set as desired.

### Dimmer

To set the dimmer value on the COLORband H9 ILS, follow the instructions below.

1. Press **<MENU>** repeatedly until **dim** shows on the display.
2. Press **<ENTER>**.
3. Use **<UP>** or **<DOWN>** to set the dimmer, from **dim1** (fast) to **dim3** (slow) or **OFF**.
4. Press **<ENTER>**.

## Operation

### RF Control

To lock/unlock the touchscreen on the COLORband H9 ILS, do the following:

1. Press **<MENU>** repeatedly until **SEt** shows on the display. Press **<ENTER>**.
2. Use **<UP>** or **<DOWN>** to select **RF**. Press **<ENTER>**.
3. Use **<UP>** or **<DOWN>** to select **Link** (Link to a single remote), **PubL** (Public mode), or **oFF** (deactivates RFC remote control).
4. Press **<ENTER>**.



**Password:** **<UP>**, **<DOWN>**, **<UP>**, **<DOWN>**, **<ENTER>**

### Factory Reset

To reset the COLORband H9 ILS to default factory settings, follow the instructions below:

1. Press **<MENU>** repeatedly until **SEt** shows on the display. Press **<ENTER>**.
2. Use **<UP>** or **<DOWN>** to select **RESt**. Press **<ENTER>**.

### Master/Slave Mode (D-Fi USB)

The D-Fi USB allows a single COLORband H9 ILS product (the “master”) to control the actions of one or more COLORband H9 ILS products (the “slaves”) without the need of a DMX controller or DMX cables. The master (transmitter) product will be set to operate in standalone mode, while the slave (receiver) products will be set to operate in DMX mode. Once set and connected, the slave products will operate in unison with the master product.

Configure the products as indicated below.

#### Slave products:

1. Press **<MENU>** repeatedly until **6-Ch** shows on the display.
2. Press **<ENTER>**.
3. Use **<UP>** or **<DOWN>** to set the starting address to **d 1**.
4. Press **<ENTER>**.
5. Set the D-Fi USB to receive on a specific channel, 1–16.
6. Plug in the D-Fi USB.
7. Finish setting and connecting all the slave products.

#### Master product:

1. Set the master product to operate in standalone mode.
2. Set the D-Fi USB to transmit on the D-Fi channel the slaves are receiving on.
3. Plug in the D-Fi USB.



- **All products must be set to the same DMX personality, DMX address, and D-Fi channel.**
- **Configure all the slave products before configuring the master to transmit.**
- **Never connect a DMX controller to a D-Fi channel configured for Master/Slave operation because the controller may interfere with the signals from the master.**

### ILS Mode

ILS (Integrated Lighting System) provides 4 modes that synchronize with the GigBAR MOVE+ILS: Modes 1 and 3 synchronize with side 1 of the GigBAR MOVE+ILS, whereas modes 2 and 4 synchronize with side 2 of the GigBAR MOVE+ILS. When linked, effects will sync with the most similar effect on the selected side of the GigBAR MOVE+ILS: Kinta effects will sync with one of the kintas, moving heads will sync with one of the moving heads, and wash effects will sync with one of the pars. Laser effects will sync with the laser, and strobe effects will sync with the strobe effects regardless of ILS mode.

This product will synchronize with the par effect on the selected side of the GigBAR MOVE+ILS.

To set the COLORband H9 ILS to respond to an ILS signal:

1. Press **<MENU>** repeatedly until **iLS** shows on the display.
2. Use **<UP>** or **<DOWN>** to select from **iLS1** (side 1), **iLS2** (side 2), **iLS3** (side 1), or **iLS4** (side 2).
3. Press **<ENTER>**.

## 5. Maintenance

### Product Maintenance

Dust build-up reduces light output performance and can cause overheating. This can lead to reduction of the light source's life and/or mechanical wear. To maintain optimum performance and minimize wear, clean your lighting products at least twice a month. However, be aware that usage and environmental conditions could be contributing factors to increase the cleaning frequency.

To clean the product, follow the instructions below:

1. Unplug the product from power.
2. Wait until the product is at room temperature.
3. Use a vacuum (or dry compressed air) and a soft brush to remove dust collected on the external surface/vents.
4. Clean all transparent surfaces with a mild soap solution, ammonia-free glass cleaner, or isopropyl alcohol.
5. Apply the solution directly to a soft, lint-free cotton cloth or a lens-cleaning tissue.
6. Softly drag any dirt or grime to the outside of the transparent surface.
7. Gently polish the transparent surfaces until they are free of haze and lint.



**Always dry the transparent surfaces carefully after cleaning them.**



## 6. Technical Specifications

### Dimensions and Weight

Length	Width	Height	Weight
39.4 in (1000 mm)	2.2 in (56 mm)	6.8 in (172 mm)	7.2 lb (3.3 kg)

**Note:** Dimensions in inches are rounded.

### Power

Power Supply Type	Range	Voltage Selection
Switching (internal)	100 to 240 VAC, 50/60 Hz	Auto-ranging

Parameter	120 V, 60 Hz	230 V, 50 Hz
Consumption	80 W	79 W
Operating current	1.1 A	0.6 A
Power-linking current (products)	12 A (12 products)	12 A (21 products)
Fuse	T1.6L, 250 V	T1.6L, 250 V

Power I/O	U.S./Worldwide	UK/Europe
Power input connector	powerCON® compatible	powerCON® compatible
Power output connector	powerCON® compatible	powerCON® compatible
Power cord plug	Neutrik	Bare wire

### Light Source

Type	Color	Quantity	Power	Current	Lifespan
LED	Hex-color RGBWA+UV	9	10W	1.09 A	50,000 hours

### Photometrics

Beam Angle	Field Angle	Illuminance @ 2 m
23°	41°	3,529 lux

### Thermal

Maximum External Temperature	Cooling System
104 °F (40 °C)	Convection

### DMX

I/O Connector	Channel Range
3-pin and 5-pin XLR	6, 9, 11, 18, or 23

### Ordering

Product Name	Item Code	UPC Number
COLORband H9 ILS	10031950	781462222987



RoHS



## Warranty & Returns

### Limited Warranty

FOR WARRANTY REGISTRATION AND COMPLETE TERMS AND CONDITIONS PLEASE VISIT OUR WEBSITE.

For Customers in the United States and Mexico: [www.chauvetlighting.com/warranty-registration](http://www.chauvetlighting.com/warranty-registration).

For Customers in the United Kingdom, Republic of Ireland, Belgium, the Netherlands, Luxembourg, France, and Germany: [www.chauvetlighting.eu/warranty-registration](http://www.chauvetlighting.eu/warranty-registration).

Chauvet warrants that this product shall be free from defects in material and workmanship under normal use, for the period specified in, and subject to the exclusions and limitations set forth in the full limited warranty on our website. This warranty extends only to the original purchaser of the product and is not transferable. To exercise rights under this warranty, you must provide proof of purchase in the form of an original sales receipt from an authorized dealer that shows the product name and date of purchase.

THERE ARE NO OTHER EXPRESS OR IMPLIED WARRANTIES. This warranty gives you specific legal rights. You may also have other rights that vary from state to state and country to country. This warranty is valid only in the United States, United Kingdom, Republic of Ireland, Belgium, the Netherlands, Luxembourg, France, Germany and Mexico. For warranty terms in other countries, please consult your local distributor.

### Returns

In case you need to get support or return a product:

- If you are located in the U.S., contact Chauvet World Headquarters.
- If you are located in the U.K. or Ireland, contact Chauvet U.K..
- If you are located in Benelux, contact Chauvet Benelux
- If you are located in France, contact Chauvet France.
- If you are located in Germany, contact Chauvet Germany.
- If you are located in Mexico, contact Chauvet Mexico.
- If you are located in any other country, DO NOT contact Chauvet. Instead, contact your local distributor. See [www.chauvetdj.com](http://www.chauvetdj.com) for distributors outside the U.S., U.K., Ireland, Benelux, France, Germany, or Mexico.



**If you are located outside the U.S., U.K., Ireland, Benelux, France, Germany, or Mexico, contact your distributor of record and follow their instructions on how to return Chauvet products to them. Visit our website [www.chauvetdj.com](http://www.chauvetdj.com) for contact details.**

Call the corresponding Chauvet Technical Support office and request a Return Merchandise Authorization (RMA) number before shipping the product. Be prepared to provide the model number, serial number, and a brief description of the cause for the return.

To submit a service request online, go to [www.chauvetdj.com/service-request](http://www.chauvetdj.com/service-request).

Send the merchandise prepaid, in its original box, and with its original packing and accessories. Chauvet will not issue call tags.

Clearly label the package with the RMA number. Chauvet will refuse any product returned without an RMA number.



**Write the RMA number on a properly affixed label. DO NOT write the RMA number directly on the box.**

Before sending the product, clearly write the following information on a piece of paper and place it inside the box:

- Your name
- Your address
- Your phone number
- RMA number
- A brief description of the problem

Be sure to pack the product properly. Any shipping damage resulting from inadequate packaging will be your responsibility. FedEx packing or double-boxing are recommended.



**Chauvet reserves the right to use its own discretion to repair or replace returned product(s).**

## Contact Us

General Information	Technical Support
<b>Chauvet World Headquarters</b>	
Address: 3360 Davie Rd. Davie, FL 33314 Voice: (954) 577-4455 Fax: (954) 929-5560 Toll Free: (800) 762-1084	Voice: (844) 393-7575 Fax: (954) 756-8015 Email: <a href="mailto:chauvetcs@chauvetlighting.com">chauvetcs@chauvetlighting.com</a>  Website: <a href="http://www.chauvetdj.com">www.chauvetdj.com</a>
<b>Chauvet U.K.</b>	
Address: Unit 1C Brookhill Road Industrial Estate Pinxton, Nottingham, UK NG16 6NT Voice: +44 (0) 1773 511115 Fax: +44 (0) 1773 511110	Email: <a href="mailto:UKtech@chauvetlighting.eu">UKtech@chauvetlighting.eu</a>  Website: <a href="http://www.chauvetdj.eu">www.chauvetdj.eu</a>
<b>Chauvet Benelux</b>	
Address: Stokstraat 18 9770 Kruishoutem Belgium Voice: +32 9 388 93 97	Email: <a href="mailto:BNLtech@chauvetlighting.eu">BNLtech@chauvetlighting.eu</a>  Website: <a href="http://www.chauvetdj.eu">www.chauvetdj.eu</a>
<b>Chauvet France</b>	
Address: 3, Rue Ampère 91380 Chilly-Mazarin France Voice: +33 1 78 85 33 59	Email: <a href="mailto:FRtech@chauvetlighting.fr">FRtech@chauvetlighting.fr</a>  Website: <a href="http://www.chauvetdj.eu">www.chauvetdj.eu</a>
<b>Chauvet Germany</b>	
Address: Bruno-Bürger-Str. 11 28759 Bremen Germany Voice: +49 421 62 60 20	Email: <a href="mailto:DEtech@chauvetlighting.de">DEtech@chauvetlighting.de</a>  Website: <a href="http://www.chauvetdj.eu">www.chauvetdj.eu</a>
<b>Chauvet Mexico</b>	
Address: Av. de las Partidas 34 - 3B (Entrance by Calle 2) Zona Industrial Lerma Lerma, Edo. de México, CP 52000 Voice: +52 (728) 690-2010	Email: <a href="mailto:servicio@chauvet.com.mx">servicio@chauvet.com.mx</a>  Website: <a href="http://www.chauvetdj.mx">www.chauvetdj.mx</a>

Visit the applicable website above to verify our contact information and instructions to request support. Outside the U.S., U.K., Ireland, Mexico, France, Germany, or Benelux, contact the dealer of record.