

Installation Instructions

Model AMP04TRP

SELF-AMPLIFIED TRUMPET SPEAKERS



TRP470

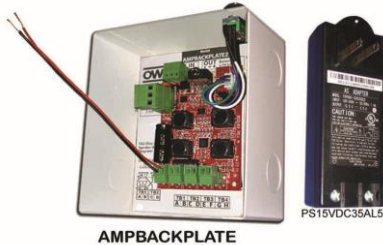

AMPBACKPLATE

PS15VDC35AL5



Established 1978

OWI Incorporated
17141 Kingsview Ave. Carson CA 90746 USA
Tel. 310-515-1900
www.owi-inc.com

Technical Support: 310-515-1900



CAUTION
RISK OF ELECTRIC SHOCK



DO NOT OPEN

**CAUTION: TO REDUCE THE RISK OF ELECTRIC SHOCK
DO NOT REMOVE COVER (OR BACK)
NO USER-SERVICEABLE PARTS INSIDE
REFER SERVICING TO QUALIFIED PERSONNEL**



The lightning flash with arrowhead symbol within an equilateral triangle is intended to alert the user to the presence of uninsulated "dangerous voltage" within the product's enclosure that may be of sufficient magnitude to constitute a risk of electric shock to persons.



The exclamation point within an equilateral triangle is intended to alert the user of the presence of important operating and maintenance (servicing) instructions in the literature accompanying the appliance.

The apparatus shall not be exposed to dripping or splashing and that no objects filled with liquids, such as vases, shall be placed on the apparatus.

IMPORTANT SAFETY INSTRUCTIONS

1. Read these instructions - All the safety and operation instructions should be read before this OWI product is operated.
2. Keep these instructions - The safety and operating instructions should be kept for future reference.
3. Heed all warnings - All warnings on this product and in these operating instructions should be followed.
4. Follow all instructions - All operating and other instructions should be followed.
5. Do not use this apparatus near water - for example, near a bathtub, washbowl, kitchen sink, laundry tub, in a wet basement, near a swimming pool, swamp or salivating St. Bernard dog, etc.
6. Clean only with dry cloth.
7. Do not block any ventilation openings. Install in accordance with the manufacturer's instructions. - This OWI product should be situated so that its location or position does not interfere with its proper ventilation. For example, the Component should not be situated on a bed, sofa, rug, or similar surface that may block any ventilation openings, or placed in a built-in installation such as a bookcase or cabinet that may impede the flow of air through ventilation openings.
8. Do not install near any heat sources such as radiators, heat registers, stoves or other apparatus (including amplifiers) that produce heat.
9. Do not defeat the safety purpose of the polarized or grounding-type plug. A polarized plug has two blades with one wider than the other. A grounding type plug has two blades and a third grounding prong. The wider blade or the third prong are provided for your safety. If the provided plug does not fit into your outlet, consult an electrician for replacement of the obsolete outlet.
10. Protect the power cord from being walked on or pinched particularly at plugs, convenience receptacles, and the point where they exit the apparatus.
11. Only use attachment/accessories specified by the manufactures.
12. Use only with the cart, stand, tripod, bracket or table specified by the manufacturer, or sold with the apparatus. When a cart is used, use caution when moving the cart/apparatus combination to avoid injury from tip-over.



13. Unplug this apparatus during lightning storms or when unused for long periods of time.
14. Refer all servicing to qualified service personnel. Servicing is required when the apparatus has been damaged in any way, such as power-supply cord or plug is damaged, liquid has been spilled or objects have fallen into the apparatus, the apparatus has been exposed to rain or moisture, does not operate normally, or has been dropped. The user should not attempt to service this OWI product beyond those means described in this operating manual. All other servicing should be referred to the OWI Service Department.
15. To reduce the risk of fire or electric shock, do not expose this apparatus to rain or moisture.
16. To prevent electric shock, do not use this polarized plug with an extension cord, receptacle or other outlet unless the blades can be fully inserted to prevent blade exposure.
17. Exposure to extremely high noise levels may cause permanent hearing loss. Individuals vary considerably in susceptibility to noise-induced hearing loss, but nearly everyone will lose some hearing if exposed to sufficiently intense noise for a period of time. The U.S. Government's Occupational Safety and Health Administration (OSHA) has specified the permissible noise level exposures shown in the following chart. According to OSHA, any exposure in excess of these permissible limits could result in some hearing loss. To ensure against potentially dangerous exposure to high sound pressure levels, it is recommended that all persons exposed to equipment capable of producing high sound pressure levels use hearing protectors while the equipment is in operation. Ear plugs or protectors in the ear canals or over the ears must be worn when operating the equipment in order to prevent a permanent hearing loss if exposure is in excess of the limits set forth here.
18. OWI recommends that this apparatus is to be placed on a switched power outlet, one that switches both sides of the line and has contact separation of at least 3mm.

<u>Duration Per Day</u>	<u>Sound Level dab</u>	<u>Typical</u>
In Hours	Slow Response	Example
8	90	Duo in small club
6	92	
4	95	Subway Train
3	97	
2	100	Very loud classical music
1.5	102	
1	105	Patrice screaming at Ron about deadlines
0.5	110	
0.25 or less	115	Loudest parts at a rock concert

Description:

The optional amplifier is housed in an all-metal cap with electronics inside. The amplifier accepts a balanced audio input for maximum noise rejection.

It has a high quality powder coat providing maximum durability. The power kit comes with mounting screws.

Amplifier Specifications:

Description:	40 W Amplifier in a Double Gang Box
Frequency Response:	50 Hz to 15 kHz. HF is Optimized to Enhance Frequency Response of the Speaker
Total Harmonic DIstortion:	< 1%
Signal to Noise Ratio (S/N):	> 90 dB
Input Configuration:	Differential (Noise Reducing)
Min. Common Mode Rejection:	40 dB
Max. Power Output:	40 Watts
At Load Impedance:	4 Ohms (2 Speakers in Parallel or 4 Speakers in Series Parallel)
Min. Power Supply Voltage:	8 Volts
Max. Supply Voltage:	14 Volts
Max. Current Protected:	Yes
Short Circuit Protected:	Yes
One Wire to Ground Protected:	Yes
Min. Load Impedance:	3.2 Ohms
Input Load Impedance:	10 K Ohms
Max. No. of Amps on 1 Line:	10
DImensions (HxWxD / Inches):	4" x 4 5/8" x 2 3/16"
Weight:	3 Lbs. (Including Power Supply)
Color	White or Black
Warranty	1 Year
Color	White or Black
Warranty	1 Year

TECHNICAL SPECIFICATIONS FOR THE NON-AMPLIFIED TRUMPET

MODEL NUMBER: TRP470	
DESCRIPTION:	4" full range
ENCLOSURE MATERIAL:	ABS plastic
OUTDOOR RATED:	Yes
SELECTABLE SWITCH	4 Ohms & 70Volts Combination
70V TRANSFORMER TAP:	1.5, 3.5, 7, 15, 30 Watts (Selector Knob)
SENSITIVITY (1W/1M):	90 dB
POWER HANDLING (4 OHMS)	
MAX POWER:	80 Watts
NOMINAL POWER:	40 Watts
FREQUENCY RESPONSE:	
MUSIC	140 Hz - 20 kHz
SPEECH	250 Hz - 3 kHz
DISPERSION:	120° H x 90° V
THROW (DISTANCE):	60 Feet
OPERATING TEMPERATURE:	14° F to 176° F (-10°C to 80°C)
WOOFER SIZE:	4"
WOOFER MATERIAL:	Coated Paper
GRILL MATERIAL	Aluminum
DIMENSIONS (HxWxD):	10" x 9.8" x 5.9" (254 X 249 X 150 mm)
WEIGHT:	6.80 lbs.
MOUNTING HARDWARE:	Unique "C" Bracket (Included)
TERMINAL COVER PLATE:	Included
SECURITY CABLE:	Included
COLOR(S):	White,Black
PAINTABLE:	Yes
WARRANTY:	5 Years

AMPBACKPLATE AND TRUMPET SPEAKER WIRING AND INSTALLATION INSTRUCTION

MODEL: AMP04TRP

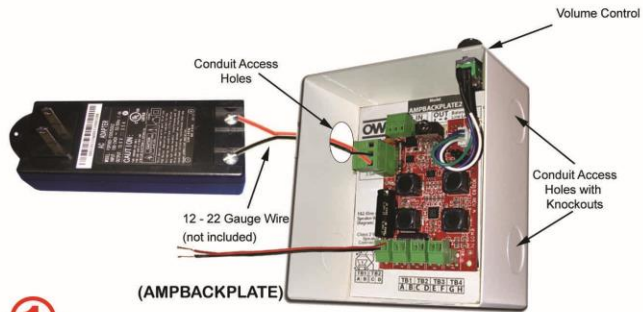
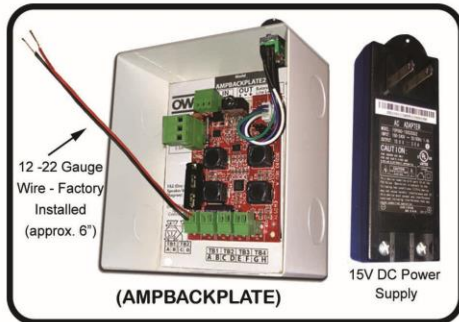

- 1** Get the AMPBACKPLATE and remove the knockout of one of the conduit access hole closer to the POWER IN Phoenix connector as shown above. Insert the other end of the power supply wires through the conduit access hole then connect the positive wire to the positive terminal and the negative wire to the negative terminal of the phoenix connector labeled POWER IN on the AMPBACKPLATE.

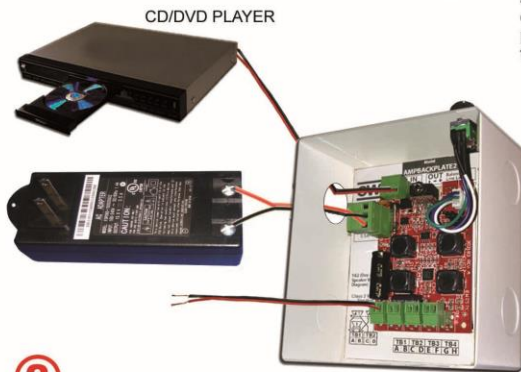

- 2** Insert the incoming wires from the source CD/DVD player and let it pass through the conduit access hole and connect the wire pair to the green detachable connector. If it's balanced, attach the inner wire pair to + and -. Attach the shield to Ground (Sh). Where there is hum. Attach a jumper between - and (Sh). On a CD player with only 2 wires, run hot wire to + and shield to -. Attach a jumper to (Sh) only if there is hum.



- 3** Get the TRP470 and with the use of a screw driver, remove the two screws (A & B) at the back of trumpet speaker to detach the existing cap of the speaker.

- 4** After detaching the cap, remove the two screws on the top left (C) and on the bottom right (D) of the backplate.

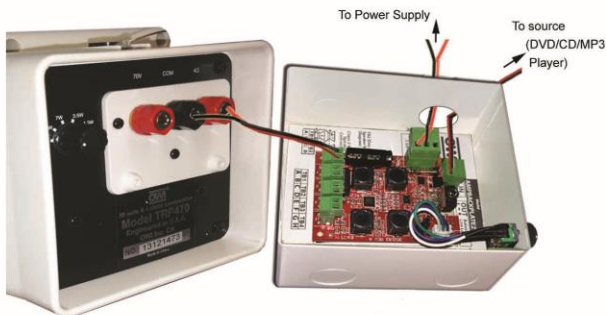

WIRING FOR A SINGLE AMPLIFIED TRUMPET . . .

- 5** Connect the positive (+) wire from the Phoenix connector to the Black 5 way binding post (COM) of the Trumpet Speaker and the negative wire to the Red binding posts (4 Ω) of the TRP470. (For the two and four speaker combination wiring diagram - please see the users manual).

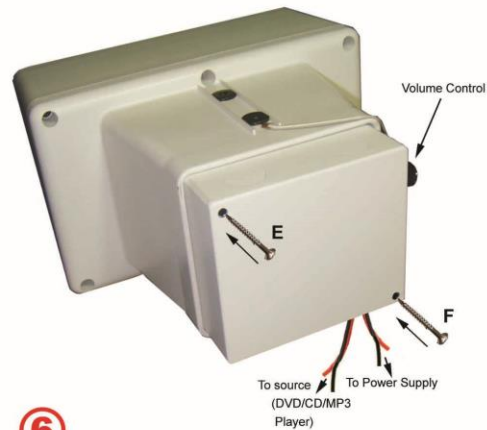

- 6** Position the AMPBACKPLATE to the back of the TRP470 by aligning the two open holes of the AMPBACKPLATE to the two holes vacated by screws C & D in STEP 4. Secure the AMPBACKPLATE to the back of the TRP470 by installing the two provided screws (E & F). Please see the wall, ceiling or pole mounting installation instruction of the TRP470 to complete the installation.

092415

TRUMPET SPEAKER MOUNTING PARTS

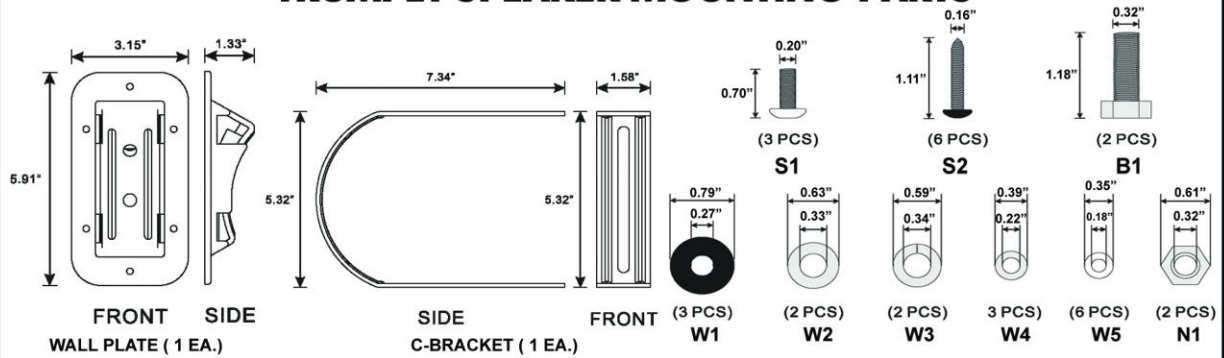

INSTALLATION INSTRUCTION

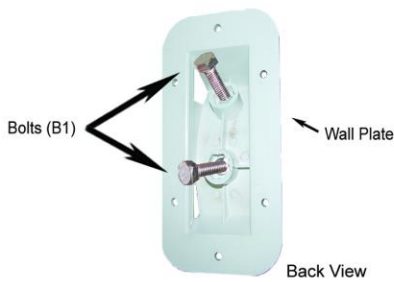

STEP 1. Insert the two bolts (B1) at the two holes at the back of the wall plate as shown on top photo.

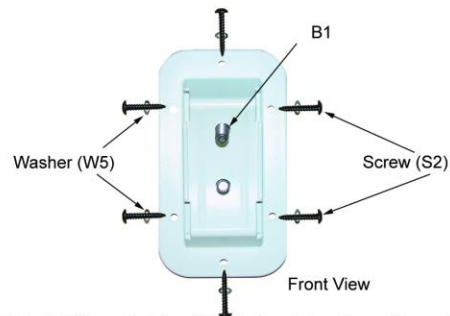

STEP 2. Install the wall plate at the designated wall or ceiling using the six screws (S2) together with the six washers (W5).

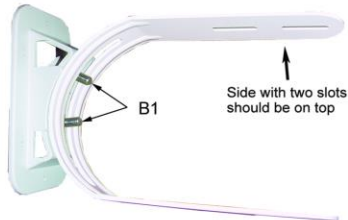

STEP 3. Get the "C" mounting bracket and mount it on the two bolts (B1) on the wall plate as shown.

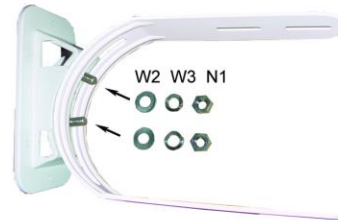

STEP 4. Place the washers and the nuts on the two bolts as shown and then tighten the nuts after determining the vertical angle of the speaker.

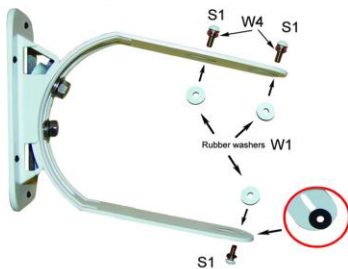

STEP 5. Peel off the white sticker cover on the rubber washer (W1) and stick the washer aligned on the hole of the "C" bracket.

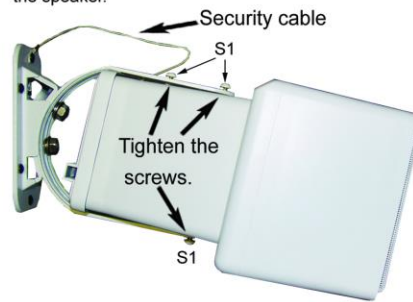

STEP 6. After properly connecting the speaker wires, place the Trumpet Speaker in-between the "C" bracket and tighten the three screws (S1).



AMP04TRP TO ANOTHER AMP04TRP WIRING DIAGRAM

17141 Kingsview Ave.
Carson, CA 90746-1207
T: 310.515.1900
F: 310.515.1606
www.owi-inc.com

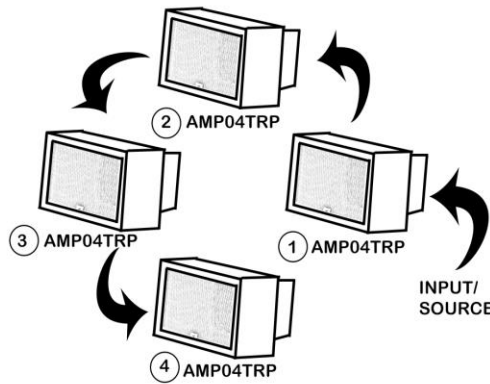
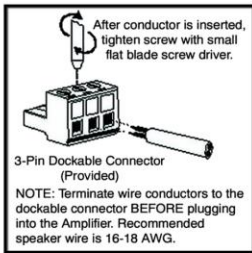
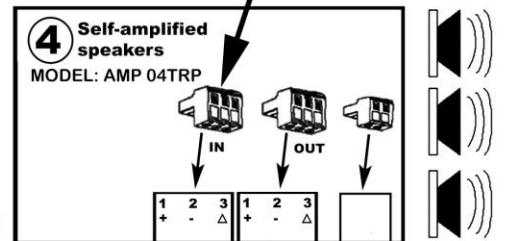
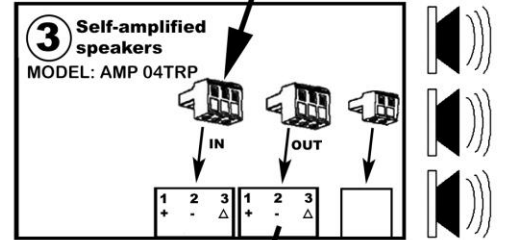
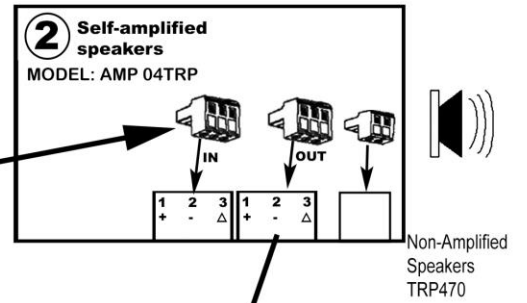
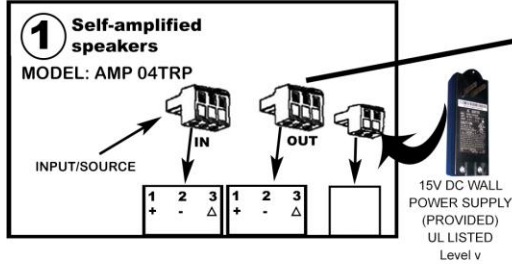

Filename: AMP04TRP TO AMP04TRP WIRING DIAGRAM

Trouble Shooting Guide

1. No output: Disconnect any secondary speakers and check for operation of the primary speaker only. If still there is no output, check for loose screws on the green input connector. It is easy to think the wires are secure in the connector and one wire is not. Tug on each wire to make sure each is tight.
2. Intermittent output: Check for shorted output causing the amplifier to into and output protection. Check each input wire for loose screws.
3. Distortion: Do not power more than one AMP04TRP on one power supply. While it will work, it will cause distortion.
4. No output, check to see that the power on light is on. It is located on the main PCB. If it is off, the power supply is either bad or has come loose in the power socket.
5. Hum, for single ended inputs, there is a need for a jumper between – and the ground screw. Most of the time, the jumper is needed.

LIMITED WARRANTY

1. The AMP04TRP product has been thoroughly tested and inspected at the factory. It is warranted for one (1) year from date of purchase.
IT IS THE OWNERS' RESPONSIBILITY TO ESTABLISH THE DATE OF PURCHASE BY ACCEPTABLE EVIDENCE AT TIME SERVICE IS SOUGHT.
2. Any unit, which in the judgment of OWI INC. is defective or develops defects under normal use will be replaced or repaired without cost within the warranty period.
3. This warranty will be considered void if unit has been dropped, misused, abused, altered in any manner, overdriven with excessive amplification exceeding manufacturer's specification, improperly serviced or accidental damage.
4. OWI Inc. shall have no liability whatsoever for consequential damage. The sole responsibility and discretion of OWI Inc. under this warranty shall be limited to the repair of the product or replacement thereof.
5. IMPORTANT: This warranty is void unless the attached card is completed and mailed to OWI Inc. within 10 days following the date of purchase. Units must be sent to OWI Inc. or to the dealer where purchased.

OWI INCORPORATED
17141 Kingsview Ave
Carson, CA 90746

Date Purchased: _____
Model Number: _____
Serial Number: _____

(Keep this part for your record)

-----CUT AND MAIL-----



OWI INCORPORATED
17141 Kingsview Ave
Carson, CA 90746

LIMITED WARRANTY
(Self-Amplified Speaker)

Model Number: _____

Model Name: _____

Serial No. _____

Date of Purchase: Month: _____ Day _____ Year _____

Owner's Name: _____

Address: _____

City: _____ State _____ Zip _____

Dealer's Name: _____ City _____ State _____

Purchased from (please check one):

Video __, Electronic __, Mail Order __, Mass Merchandiser __, Installer __

Others (please specify) _____

Remarks: _____



OWI INC.

LIMITED FIVE YEAR WARRANTY
(NON-AMPLIFIED TRUMPET TRP470 SPEAKER)

1. Your OWI speakers have been thoroughly tested and inspected at the factory. They are warranted for 5 years from the date of purchase. **It is the owner's responsibility to establish the date of purchase by acceptable evidence at the time service is sought.**
2. If the speaker proves to be defective in materials or workmanship within five years from the date of the original customer purchase, OWI, at its sole option may repair or replace the unit with a current model of equal or greater value. In some cases where a new model is substituted, a modification to the mounting surface may be required. If mounting surface modification is required, OWI assumes no responsibility or liability for such modification.
3. Exclusion of certain damages

Liability for any defective product is limited to repair or replacement of the product at our option. OWI Inc. shall have no liability whatsoever for any incidental or consequential damages of any kind of character because of product defect. **The sole responsibility of OWI Inc. under this warranty shall be limited to the repair of the product or replacement thereof, and is the sole discretion of OWI Inc.** Some states do not allow limitation on how long an implied warranty lasts and/or do not allow the exclusion or limitation of incidental or consequential damages, so the above limitation may not apply.

4. This warranty does not cover:
 - a. Damage caused by abuse, accident, misuse, negligence, improper operation(installation), overdriven with excessive amplification.
 - b. Products that have been altered or modified.
 - c. Any product whose serial number has been altered or removed.
 - d. Normal wear and maintenance.
 - e. Damages caused by shipping. All claims for shipping must be made with the carrier.

5. What OWI Inc. will pay for and what YOU must pay for:

OWI will repair or replace unit(s) covered by this warranty without charge to the customer for labor or materials. **You are responsible for any installation or removal charges and for any initial shipping charges**, if the unit(s) must be shipped for warranty service. However, OWI Inc. will pay the return shipping charges to any destination within the USA, if the repairs are covered by the warranty.

6. Warranty Service

Units for warranty repair must be sent to OWI Inc., or to the dealer where purchased, postage prepaid. Copy of original proof of purchase to be included with the speaker(s).