



Evolution Wireless Digital EW-D | EW-DX

Instruction manual (PDF export of the original HTML manual)

This PDF document is a PDF export of an interactive manual in HTML format.

When displayed in PDF format, it is possible that not all content and interactive elements in the HTML instructions are included, as these cannot be displayed in PDF format.

We recommend using the complete and interactive HTML instructions.

You can find these in the Sennheiser Documentation App, which is available free of charge for iOS and Android. Alternatively, the HTML instructions are also available in the download area of the product page:

www.sennheiser.com/ew-dx

Sennheiser electronic GmbH & Co. KG

Am Labor 1, 30900 Wedemark, Germany, www.sennheiser.com
EW-D | EW-DX - v2.1 (11/2022)

SENNHEISER



PRODUCT INFORMATION

„Products of the EW-D series“

„Sets available for the EW-D series“

„Products of the EW-DX series“

„Sets available for the EW-DX series“

„EW-D Smart Assist app“

„Accessories“

„Frequency ranges“



Products of the EW-D series

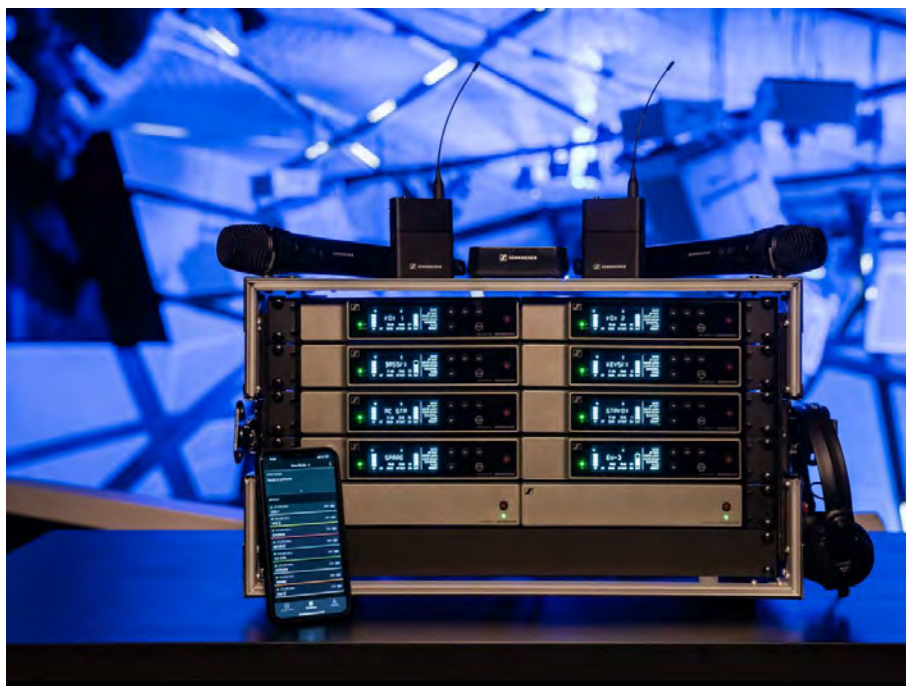

For information about the available **accessories**, see „Accessories“.

For information about the available **sets**, see „Sets available for the EW-D series“.

For information about the **frequency ranges**, see „Frequency ranges“.

You can find technical **specifications** for the series and the individual products under „SPECIFICATIONS“.

You can find information about **starting up** and **operating** the products under „Starting up and operating devices of the Evolution Wireless Digital series“.



EW-D EM rack receiver



The **EW-D EM** rack receiver is available in the following versions:

EW-D EM (Q1-6) | 470.2 – 526 MHz | Art. no. 508800

EW-D EM (R1-6) | 520 – 576 MHz | Art. no. 508801

EW-D EM (R4-9) | 552 – 607.8 MHz | Art. no. 508802

EW-D EM (S1-7) | 606.2 – 662 MHz | Art. no. 508803

EW-D EM (S4-7) | 630 – 662 MHz | Art. no. 508804

EW-D EM (S7-10) | 662 – 693.8 MHz | Art. no. 508805

EW-D EM (U1/5) | 823.2 – 831.8 MHz & 863.2 – 864.8 MHz | Art. no. 508806

EW-D EM (V3-4) | 925.2 – 937.3 MHz | Art. no. 508808

EW-D EM (Y1-3) | 1785.2 – 1799.8 MHz | Art. no. 508809

You can find more detailed information about the EW-D EM in the following sections:

- ▷ **Startup and operation:** „EW-D EM rack receiver“
- ▷ **Specifications:** „EW-D EM rack receiver“



EW-D SKM-S handheld transmitter



The **EW-D SKM-S** handheld transmitter is available in the following versions:

EW-D SKM-S (Q1-6) | 470.2 – 526 MHz | Art. no. 508790

EW-D SKM-S (R1-6) | 520 – 576 MHz | Art. no. 508791

EW-D SKM-S (R4-9) | 552 – 607.8 MHz | Art. no. 508792

EW-D SKM-S (S1-7) | 606.2 – 662 MHz | Art. no. 508793

EW-D SKM-S (S4-7) | 630 – 662 MHz | Art. no. 508794

EW-D SKM-S (S7-10) | 662 – 693.8 MHz | Art. no. 508795

EW-D SKM-S (U1/5) | 823.2 – 831.8 MHz & 863.2 – 864.8 MHz
| Art. no. 508796

EW-D SKM-S (V3-4) | 925.2 – 937.3 MHz | Art. no. 508798

EW-D SKM-S (Y1-3) | 1785.2 – 1799.8 MHz | Art. no. 508799

You can find more detailed information about the EW-D SKM-S in the following sections:

- ▷ **Startup and operation:** „EW-D SKM-S handheld transmitter“
- ▷ **Specifications:** „EW-D SKM-S handheld transmitter“
- ▷ **Compatible microphone modules:** „Replacing the microphone module“



EW-D SK bodypack transmitter



The **EW-D SK** bodypack transmitter is available in the following versions:

EW-D SK (Q1-6) | 470.2 – 526 MHz | Art. no. 508780

EW-D SK (R1-6) | 520 – 576 MHz | Art. no. 508781

EW-D SK (R4-9) | 552 – 607.8 MHz | Art. no. 508782

EW-D SK (S1-7) | 606.2 – 662 MHz | Art. no. 508783

EW-D SK (S4-7) | 630 – 662 MHz | Art. no. 508784

EW-D SK (S7-10) | 662 – 693.8 MHz | Art. no. 508785

EW-D SK (U1/5) | 823.2 – 831.8 MHz & 863.2 – 864.8 MHz | Art. no. 508786

EW-D SKM-S (V3-4) | 925.2 – 937.3 MHz | Art. no. 508788

EW-D SKM-S (Y1-3) | 1785.2 – 1799.8 MHz | Art. no. 508789

You can find more detailed information about the EW-D SK in the following sections:

- ▷ **Startup and operation:** „EW-D SK bodypack transmitter“
- ▷ **Specifications:** „EW-D SK bodypack transmitter“
- ▷ **Compatible microphones:** „Connecting a microphone to the bodypack transmitter“



Sets available for the EW-D series

EW-D ME2 SET | Lavalier Set



The set consists of the following components:

- **EW-D EM** rack receiver
- **EW-D SK** bodypack transmitter
- **ME 2** lavalier microphone

The set is available in the following versions:

EW-D ME2 SET (Q1-6) | 470.2 – 526 MHz | Art. no. 508700

EW-D ME2 SET (R1-6) | 520 – 576 MHz | Art. no. 508701

EW-D ME2 SET (R4-9) | 552 – 607.8 MHz | Art. no. 508702

EW-D ME2 SET (S1-7) | 606.2 – 662 MHz | Art. no. 508703

EW-D ME2 SET (S4-7) | 630 – 662 MHz | Art. no. 508704

EW-D ME2 SET (S7-10) | 662 – 693.8 MHz | Art. no. 508705

EW-D ME2 SET (U1/5) | 823.2 – 831.8 MHz & 863.2 – 864.8 MHz | Art. no. 508706

EW-D ME2 SET (V3-4) | 925.2 – 937.3 MHz | Art. no. 508708

EW-D ME2 SET (Y1-3) | 1785.2 – 1799.8 MHz | Art. no. 508709

You can find more detailed information about the set in the following sections:

- ▷ **Startup and operation:** „Starting up and operating devices of the Evolution Wireless Digital series“
- ▷ **Specifications:** „SPECIFICATIONS“



EW-D ME3 SET | Headmic Set



The set consists of the following components:

- **EW-D EM** rack receiver
- **EW-D SK** bodypack transmitter
- **ME 3** headset microphone

The set is available in the following versions:

EW-D ME3 SET (Q1-6) | 470.2 – 526 MHz | Art. no. 508710

EW-D ME3 SET (R1-6) | 520 – 576 MHz | Art. no. 508711

EW-D ME3 SET (R4-9) | 552 – 607.8 MHz | Art. no. 508712

EW-D ME3 SET (S1-7) | 606.2 – 662 MHz | Art. no. 508713

EW-D ME3 SET (S4-7) | 630 – 662 MHz | Art. no. 508714

EW-D ME3 SET (S7-10) | 662 – 693.8 MHz | Art. no. 508715

EW-D ME3 SET (U1/5) | 823.2 – 831.8 MHz & 863.2 – 864.8 MHz | Art. no. 508716

EW-D ME3 SET (V3-4) | 925.2 – 937.3 MHz | Art. no. 508718

EW-D ME3 SET (Y1-3) | 1785.2 – 1799.8 MHz | Art. no. 508719

You can find more detailed information about the set in the following sections:

- ▷ **Startup and operation:** „Starting up and operating devices of the Evolution Wireless Digital series“
- ▷ **Specifications:** „SPECIFICATIONS“



EW-D ME4 SET | Lavalier Set



The set consists of the following components:

- **EW-D EM** rack receiver
- **EW-D SK** bodypack transmitter
- **ME 4** lavalier microphone

The set is available in the following versions:

EW-D ME4 SET (Q1-6) | 470.2 – 526 MHz | Art. no. 508720

EW-D ME4 SET (R1-6) | 520 – 576 MHz | Art. no. 508721

EW-D ME4 SET (R4-9) | 552 – 607.8 MHz | Art. no. 508722

EW-D ME4 SET (S1-7) | 606.2 – 662 MHz | Art. no. 508723

EW-D ME4 SET (S4-7) | 630 – 662 MHz | Art. no. 508724

EW-D ME4 SET (S7-10) | 662 – 693.8 MHz | Art. no. 508725

EW-D ME4 SET (U1/5) | 823.2 – 831.8 MHz & 863.2 – 864.8 MHz | Art. no. 508726

EW-D ME4 SET (V3-4) | 925.2 – 937.3 MHz | Art. no. 508728

EW-D ME4 SET (Y1-3) | 1785.2 – 1799.8 MHz | Art. no. 508729

You can find more detailed information about the set in the following sections:

- ▷ **Startup and operation:** „Starting up and operating devices of the Evolution Wireless Digital series“
- ▷ **Specifications:** „SPECIFICATIONS“



EW-D CI1 SET | Instrument Set



The set consists of the following components:

- **EW-D EM** rack receiver
- **EW-D SK** bodypack transmitter
- **CI 1** instrument cable

The set is available in the following versions:

EW-D CI1 SET (Q1-6) | 470.2 – 526 MHz | Art. no. 508730

EW-D CI1 SET (R1-6) | 520 – 576 MHz | Art. no. 508731

EW-D CI1 SET (R4-9) | 552 – 607.8 MHz | Art. no. 508732

EW-D CI1 SET (S1-7) | 606.2 – 662 MHz | Art. no. 508733

EW-D CI1 SET (S4-7) | 630 – 662 MHz | Art. no. 508734

EW-D CI1 SET (S7-10) | 662 – 693.8 MHz | Art. no. 508735

EW-D CI1 SET (U1/5) | 823.2 – 831.8 MHz & 863.2 – 864.8 MHz
| Art. no. 508736

EW-D CI1 SET (V3-4) | 925.2 – 937.3 MHz | Art. no. 508738

EW-D CI1 SET (Y1-3) | 1785.2 – 1799.8 MHz | Art. no. 508739

You can find more detailed information about the set in the following sections:

- ▷ **Startup and operation:** „Starting up and operating devices of the Evolution Wireless Digital series“
- ▷ **Specifications:** „SPECIFICATIONS“



EW-D SK BASE SET | Base Set



The set consists of the following components:

- **EW-D EM** rack receiver
- **EW-D SK** bodypack transmitter

The set is available in the following versions:

EW-D SK BASE SET (Q1-6) | 470.2 – 526 MHz | Art. no. 508740

EW-D SK BASE SET (R1-6) | 520 – 576 MHz | Art. no. 508741

EW-D SK BASE SET (R4-9) | 552 – 607.8 MHz | Art. no. 508742

EW-D SK BASE SET (S1-7) | 606.2 – 662 MHz | Art. no. 508743

EW-D SK BASE SET (S4-7) | 630 – 662 MHz | Art. no. 508744

EW-D SK BASE SET (S7-10) | 662 – 693.8 MHz | Art. no. 508745

EW-D SK BASE SET (U1/5) | 823.2 – 831.8 MHz & 863.2 – 864.8 MHz | Art. no. 508746

EW-D SK BASE SET (V3-4) | 925.2 – 937.3 MHz | Art. no. 508748

EW-D SK BASE SET (Y1-3) | 1785.2 – 1799.8 MHz | Art. no. 508749

You can find more detailed information about the set in the following sections:

- ▷ **Startup and operation:** „Starting up and operating devices of the Evolution Wireless Digital series“
- ▷ **Specifications:** „SPECIFICATIONS“



EW-D 835-S SET | Handheld Set



The set consists of the following components:

- **EW-D EM** rack receiver
- **EW-D SKM-S** handheld transmitter
- **MMD 835** microphone module

The set is available in the following versions:

EW-D 835-S SET (Q1-6) | 470.2 – 526 MHz | Art. no. 508750

EW-D 835-S SET (R1-6) | 520 – 576 MHz | Art. no. 508751

EW-D 835-S SET (R4-9) | 552 – 607.8 MHz | Art. no. 508752

EW-D 835-S SET (S1-7) | 606.2 – 662 MHz | Art. no. 508753

EW-D 835-S SET (S4-7) | 630 – 662 MHz | Art. no. 508754

EW-D 835-S SET (S7-10) | 662 – 693.8 MHz | Art. no. 508755

EW-D 835-S SET (U1/5) | 823.2 – 831.8 MHz & 863.2 – 864.8 MHz | Art. no. 508756

EW-D 835-S SET (V3-4) | 925.2 – 937.3 MHz | Art. no. 508758

EW-D 835-S SET (Y1-3) | 1785.2 – 1799.8 MHz | Art. no. 508759

You can find more detailed information about the set in the following sections:

- ▷ **Startup and operation:** „Starting up and operating devices of the Evolution Wireless Digital series“
- ▷ **Specifications:** „SPECIFICATIONS“



EW-D SKM-S BASE SET | Base Set



The set consists of the following components:

- **EW-D EM** rack receiver
- **EW-D SKM-S** handheld transmitter

The set is available in the following versions:

EW-D SKM-S BASE SET (Q1-6) | 470.2 – 526 MHz | Art. no. 508760

EW-D SKM-S BASE SET (R1-6) | 520 – 576 MHz | Art. no. 508761

EW-D SKM-S BASE SET (R4-9) | 552 – 607.8 MHz | Art. no. 508762

EW-D SKM-S BASE SET (S1-7) | 606.2 – 662 MHz | Art. no. 508763

EW-D SKM-S BASE SET (S4-7) | 630 – 662 MHz | Art. no. 508764

EW-D SKM-S BASE SET (S7-10) | 662 – 693.8 MHz | Art. no. 508765

EW-D SKM-S BASE SET (U1/5) | 823.2 – 831.8 MHz & 863.2 – 864.8 MHz | Art. no. 508766

EW-D SKM-S BASE SET (V3-4) | 925.2 – 937.3 MHz | Art. no. 508768

EW-D SKM-S BASE SET (Y1-3) | 1785.2 – 1799.8 MHz | Art. no. 508769

You can find more detailed information about the set in the following sections:

- ▷ **Startup and operation:** „Starting up and operating devices of the Evolution Wireless Digital series“
- ▷ **Specifications:** „SPECIFICATIONS“



EW-D ME2/835-S SET | Combo Set



The set consists of the following components:

- **EW-D EM** rack receiver
- **EW-D SK** bodypack transmitter
- **EW-D SKM-S** handheld transmitter
- **ME 2** lavalier microphone
- **MMD 835** microphone module

The set is available in the following versions:

EW-D ME2/835-S SET (Q1-6) | 470.2 – 526 MHz | Art. no. 508770

EW-D ME2/835-S SET (R1-6) | 520 – 576 MHz | Art. no. 508771

EW-D ME2/835-S SET (R4-9) | 552 – 607.8 MHz | Art. no. 508772

EW-D ME2/835-S SET (S1-7) | 606.2 – 662 MHz | Art. no. 508773

EW-D ME2/835-S SET (S4-7) | 630 – 662 MHz | Art. no. 508774

EW-D ME2/835-S SET (S7-10) | 662 – 693.8 MHz | Art. no. 508775

EW-D ME2/835-S SET (U1/5) | 823.2 – 831.8 MHz & 863.2 – 864.8 MHz | Art. no. 508776

EW-D ME2/835-S SET (V3-4) | 925.2 – 937.3 MHz | Art. no. 508778

EW-D ME2/835-S SET (Y1-3) | 1785.2 – 1799.8 MHz | Art. no. 508779

You can find more detailed information about the set in the following sections:

- ▷ **Startup and operation:** „Starting up and operating devices of the Evolution Wireless Digital series“
- ▷ **Specifications:** „SPECIFICATIONS“



Products of the EW-DX series



For information about the available **accessories**, see „Accessories“.

For information about the available **sets**, see „Sets available for the EW-DX series“.

For information about the **frequency ranges**, see „Frequency ranges“.

You can find technical **specifications** for the series and the individual products under „SPECIFICATIONS“.

You can find information about **starting up** and **operating** the products under „Starting up and operating devices of the Evolution Wireless Digital series“.



EW-DX EM 2 rack receiver



The **EW-DX EM 2** rack receiver is available in the following versions:

EW-DX EM 2 (Q1-9) | 470.2 – 550 MHz | Art. no. 509342

EW-DX EM 2 (R1-9) | 520 – 607.8 MHz | Art. no. 509343

EW-DX EM 2 (S1-10) | 606.2 – 693.8 MHz | Art. no. 509344

EW-DX EM 2 (S2-10) | 614.2 – 693.8 MHz | Art. no. 509347

EW-DX EM 2 (S4-10) | 630 – 693.8 MHz | Art. no. 509348

EW-DX EM 2 (U1/5) | 823.2 – 831.8 MHz & 863.2 – 864.8 MHz
| Art. no. 509349

EW-DX EM 2 (V3-4) | 925.2 – 937.3 MHz | Art. no. 509351

EW-DX EM 2 (V5-7) | 941.7 – 951.8 MHz & 953.05 – 956.05
MHz & 956.65 – 959.65 MHz | Art. no. 509352

EW-DX EM 2 (Y1-3) | 1785.2 – 1799.8 MHz | Art. no. 509355

You can find more detailed information about the EW-DX EM 2 in the following sections:

- ▷ **Startup and operation:** „EW-DX EM 2 rack receiver“
- ▷ **Specifications:** „EW-DX EM 2 rack receiver“



EW-DX SKM | EW-DX SKM-S handheld transmitter



The **EW-DX SKM** handheld transmitter without mute switch is available in the following versions:

EW-DX SKM (Q1-9) | 470.2 – 550 MHz | Art. no. 509426

EW-DX SKM (R1-9) | 520 – 607.8 MHz | Art. no. 509427

EW-DX SKM (S1-10) | 606.2 – 693.8 MHz | Art. no. 509428

EW-DX SKM (S2-10) | 614.2 – 693.8 MHz | Art. no. 509431

EW-DX SKM (S4-10) | 630 – 693.8 MHz | Art. no. 509432

EW-DX SKM (U1/5) | 823.2 – 831.8 MHz & 863.2 – 864.8 MHz | Art. no. 509433

EW-DX SKM (V3-4) | 925.2 – 937.3 MHz | Art. no. 509435

EW-DX SKM (V5-7) | 941.7 – 951.8 MHz & 953.05 – 956.05 MHz & 956.65 – 959.65 MHz | Art. no. 509436

EW-DX SKM (Y1-3) | 1785.2 – 1799.8 MHz | Art. no. 509439



The **EW-DX SKM-S** handheld transmitter with mute switch is available in the following versions:

EW-DX SKM-S (Q1-9) | 470.2 – 550 MHz | Art. no. 509412

EW-DX SKM-S (R1-9) | 520 – 607.8 MHz | Art. no. 509413

EW-DX SKM-S (S1-10) | 606.2 – 693.8 MHz | Art. no. 509414

EW-DX SKM-S (S2-10) | 614.2 – 693.8 MHz | Art. no. 509417

EW-DX SKM-S (S4-10) | 630 – 693.8 MHz | Art. no. 509418

EW-DX SKM-S (U1/5) | 823.2 – 831.8 MHz & 863.2 – 864.8 MHz
| Art. no. 509419

EW-DX SKM-S (V3-4) | 925.2 – 937.3 MHz | Art. no. 509421

EW-DX SKM-S (V5-7) | 941.7 – 951.8 MHz & 953.05 – 956.05
MHz & 956.65 – 959.65 MHz | Art. no. 509422

EW-DX SKM-S (Y1-3) | 1785.2 – 1799.8 MHz | Art. no. 509423

You can find more detailed information about the EW-DX SKM and EW-DX SKM-S in the following sections:

- ▷ **Startup and operation:** „EW-DX SKM | EW-DX SKM-S handheld transmitter“
- ▷ **Specifications:** „EW-DX SKM | EW-DX SKM-S handheld transmitter“
- ▷ **Compatible microphone modules:** „Replacing the microphone module“



EW-DX SK | EW-DX SK 3-PIN bodypack transmitter



EW-DX SK



EW-DX SK 3-PIN

The **EW-DX SK** bodypack transmitter is available in the following versions:

EW-DX SK (Q1-9) | 470.2 – 550 MHz | Art. no. 509384

EW-DX SK (R1-9) | 520 – 607.8 MHz | Art. no. 509385

EW-DX SK (S1-10) | 606.2 – 693.8 MHz | Art. no. 509386

EW-DX SK (S2-10) | 614.2 – 693.8 MHz | Art. no. 509389

EW-DX SK (S4-10) | 630 – 693.8 MHz | Art. no. 509390

EW-DX SK (U1/5) | 823.2 – 831.8 MHz & 863.2 – 864.8 MHz | Art. no. 509391

EW-DX SK (V3-4) | 925.2 – 937.3 MHz | Art. no. 509393

EW-DX SK (V5-7) | 941.7 – 951.8 MHz & 953.05 – 956.05 MHz & 956.65 – 959.65 MHz | Art. no. 509394

EW-DX SK (Y1-3) | 1785.2 – 1799.8 MHz | Art. no. 509397



The **EW-DX SK 3-PIN** bodypack transmitter is available in the following versions:

EW-DX SK 3-PIN (Q1-9) | 470.2 – 550 MHz | Art. no. 509398

EW-DX SK 3-PIN (R1-9) | 520 – 607.8 MHz | Art. no. 509399

EW-DX SK 3-PIN (S1-10) | 606.2 – 693.8 MHz | Art. no. 509400

EW-DX SK 3-PIN (S2-10) | 614.2 – 693.8 MHz | Art. no. 509403

EW-DX SK 3-PIN (S4-10) | 630 – 693.8 MHz | Art. no. 509404

EW-DX SK 3-PIN (U1/5) | 823.2 – 831.8 MHz & 863.2 – 864.8 MHz | Art. no. 509405

EW-DX SK 3-PIN (V3-4) | 925.2 – 937.3 MHz | Art. no. 509407

EW-DX SK 3-PIN (V5-7) | 941.7 – 951.8 MHz & 953.05 – 956.05 MHz & 956.65 – 959.65 MHz | Art. no. 509408

EW-DX SK 3-PIN (Y1-3) | 1785.2 – 1799.8 MHz | Art. no. 509411

You can find more detailed information about the EW-DX SK and EW-DX SK 3-PIN in the following sections:

- ▷ **Startup and operation:** „EW-DX SK | EW-DX SK 3-PIN bodypack transmitter“
- ▷ **Specifications:** „EW-DX SK | EW-DX SK 3-PIN bodypack transmitter“
- ▷ **Compatible microphones:** „Connecting a microphone to the bodypack transmitter“



Sets available for the EW-DX series

EW-DX 835-S SET | Handheld Set



The set consists of the following components:

- **EW-DX EM 2** rack receiver
- 2x **EW-DX SKM-S** handheld transmitters
- 2x **MMD 835** microphone modules
- 2x **BA 70** rechargeable batteries

The set is available in the following versions:

EW-DX 835-S SET (Q1-9) | 470.2 – 550 MHz | Art. no. 509300

EW-DX 835-S SET (R1-9) | 520 – 607.8 MHz | Art. no. 509301

EW-DX 835-S SET (S1-10) | 606.2 – 693.8 MHz | Art. no. 509302

EW-DX 835-S SET (S2-10) | 614.2 – 693.8 MHz | Art. no. 509305

EW-DX 835-S SET (S4-10) | 630 – 693.8 MHz | Art. no. 509306

EW-DX 835-S SET (U1/5) | 823.2 – 831.8 MHz & 863.2 – 864.8 MHz | Art. no. 509307

EW-DX 835-S SET (V3-4) | 925.2 – 937.3 MHz | Art. no. 509309

EW-DX 835-S SET (V5-7) | 941.7 – 951.8 MHz & 953.05 – 956.05 MHz & 956.65 – 959.65 MHz | Art. no. 509310

EW-DX 835-S SET (Y1-3) | 1785.2 – 1799.8 MHz | Art. no. 509313

You can find more detailed information about the set in the following sections:

- ▷ **Startup and operation:** „Starting up and operating devices of the Evolution Wireless Digital series“
- ▷ **Specifications:** „SPECIFICATIONS“



EW-DX MKE 2 SET | Lavalier Set



The set consists of the following components:

- **EW-DX EM 2** rack receiver
- 2x **EW-DX SK** bodypack transmitters
- 2x **MKE 2** lavalier microphones
- 2x **BA 70** rechargeable batteries

The set is available in the following versions:

EW-DX MKE 2 SET (Q1-9) | 470.2 – 550 MHz | Art. no. 509314

EW-DX MKE 2 SET (R1-9) | 520 – 607.8 MHz | Art. no. 509315

EW-DX MKE 2 SET (S1-10) | 606.2 – 693.8 MHz | Art. no. 509316

EW-DX MKE 2 SET (S2-10) | 614.2 – 693.8 MHz | Art. no. 509319

EW-DX MKE 2 SET (S4-10) | 630 – 693.8 MHz | Art. no. 509320

EW-DX MKE 2 SET (U1/5) | 823.2 – 831.8 MHz & 863.2 – 864.8 MHz | Art. no. 509321

EW-DX MKE 2 SET (V3-4) | 925.2 – 937.3 MHz | Art. no. 509323

EW-DX MKE 2 SET (V5-7) | 941.7 – 951.8 MHz & 953.05 – 956.05 MHz & 956.65 – 959.65 MHz | Art. no. 509324

EW-DX MKE 2 SET (Y1-3) | 1785.2 – 1799.8 MHz | Art. no. 509327

You can find more detailed information about the set in the following sections:

- ▷ **Startup and operation:** „Starting up and operating devices of the Evolution Wireless Digital series“
- ▷ **Specifications:** „SPECIFICATIONS“



EW-DX MKE 2-835-S SET | Combo Set



The set consists of the following components:

- **EW-DX EM 2** rack receiver
- 1x **EW-DX SK** bodypack transmitters
- 1x **MKE 2** lavalier microphones
- 1x **EW-DX SKM-S** handheld transmitters
- 1x **MMD 835** microphone modules
- 2x **BA 70** rechargeable batteries

The set is available in the following versions:

EW-DX MKE 2-835-S SET (Q1-9) | 470.2 – 550 MHz | Art. no. 509328

EW-DX MKE 2-835-S SET (R1-9) | 520 – 607.8 MHz | Art. no. 509329

EW-DX MKE 2-835-S SET (S1-10) | 606.2 – 693.8 MHz | Art. no. 509330

EW-DX MKE 2-835-S SET (S2-10) | 614.2 – 693.8 MHz | Art. no. 509333

EW-DX MKE 2-835-S SET (S4-10) | 630 – 693.8 MHz | Art. no. 509334

EW-DX MKE 2-835-S SET (U1/5) | 823.2 – 831.8 MHz & 863.2 – 864.8 MHz | Art. no. 509335

EW-DX MKE 2-835-S SET (V3-4) | 925.2 – 937.3 MHz | Art. no. 509337

EW-DX MKE 2-835-S SET (V5-7) | 941.7 – 951.8 MHz & 953.05 – 956.05 MHz & 956.65 – 959.65 MHz | Art. no. 509338

EW-DX MKE 2-835-S SET (Y1-3) | 1785.2 – 1799.8 MHz | Art. no. 509341



You can find more detailed information about the set in the following sections:

- ▷ **Startup and operation:** „Starting up and operating devices of the Evolution Wireless Digital series“
- ▷ **Specifications:** „SPECIFICATIONS“



EW-DX SK-SKM-S BASE SET | Base Set



The set consists of the following components:

- **EW-DX EM 2** rack receiver
- 1x **EW-DX SK** bodypack transmitters
- 1x **EW-DX SKM-S** handheld transmitters
- 2x **BA 70** rechargeable batteries

The set is available in the following versions:

EW-DX SK-SKM-S BASE SET (Q1-9) | 470.2 – 550 MHz | Art. no. 509462

EW-DX SK-SKM-S BASE SET (R1-9) | 520 – 607.8 MHz | Art. no. 509463

EW-DX SK-SKM-S BASE SET (S1-10) | 606.2 – 693.8 MHz | Art. no. 509464

EW-DX SK-SKM-S BASE SET (S2-10) | 614.2 – 693.8 MHz | Art. no. 509467

EW-DX SK-SKM-S BASE SET (S4-10) | 630 – 693.8 MHz | Art. no. 509468

EW-DX SK-SKM-S BASE SET (U1/5) | 823.2 – 831.8 MHz & 863.2 – 864.8 MHz | Art. no. 509469

EW-DX SK-SKM-S BASE SET (V3-4) | 925.2 – 937.3 MHz | Art. no. 509471

EW-DX SK-SKM-S BASE SET (V5-7) | 941.7 – 951.8 MHz & 953.05 – 956.05 MHz & 956.65 – 959.65 MHz | Art. no. 509472

EW-DX SK-SKM-S BASE SET (Y1-3) | 1785.2 – 1799.8 MHz | Art. no. 509475

You can find more detailed information about the set in the following sections:

- ▷ **Startup and operation:** „Starting up and operating devices of the Evolution Wireless Digital series“
- ▷ **Specifications:** „SPECIFICATIONS“



EW-D Smart Assist app

You can operate your products easily and intuitively using the **EW-D Smart Assist** app for iOS and Android.

You can make all device settings in the app, as well as use other functions that are not available on the devices themselves.



The app offers you the following benefits:

- Use all products easily and intuitively
- Update the firmware of all devices
- Easily configure multi-channel systems with automatic frequency setup
- Assign names and color labels to wireless links
- Get tips and support



Accessories

BA 70 rechargeable battery and L 70 USB charger

BA 70 | Rechargeable battery | Art. no. 508860

L 70 USB | Charger | Art. no. 508861

EW-D CHARGING SET | L 70 USB charger with two BA 70 rechargeable batteries | Art. no. 508862

Startup and operation: „Charging the BA 70 rechargeable battery in the L 70 USB charger“

Specifications: „BA 70 rechargeable battery“ | „L 70 USB charger“

CHG 70N network-enabled charger

CHG 70N | Charger | Art. no. 509455

CHG 70N + PSU KIT | CHG 70N charger with NT 12-35 CS power supply unit | Art. no. 509456

Startup and operation: „Charging the EW-DX SKM(-S) handheld transmitter, the EW-DX SK (3-PIN) bodypack transmitter or the BA 70 rechargeable battery in the CHG 70N charger“

Specifications: „BA 70 rechargeable battery“ | „CHG 70N charger“



EW-D ASA antenna splitter

EW-D ASA active antenna splitter

Product versions:

EW-D ASA (Q-R-S) | 470 – 694 MHz | Art. no. 508879

EW-D ASA CN/ANZ (Q-R-S) | 470 – 694 MHz | Art. no. 508998

EW-D ASA (T-U-V-W) | 694 – 1075 MHz | Art. no. 508880

EW-D ASA (X-Y) | 1350 – 1805 MHz | Art. no. 508881

Startup and operation: „EW-D ASA antenna splitter“

Specifications: „EW-D ASA antenna splitter“

EW-D AB antenna booster

Product versions:

EW-D AB (Q) | 470 – 550 MHz | Art. no. 508873

EW-D AB (R) | 520 – 608 MHz | Art. no. 508874

EW-D AB (S) | 606 – 694 MHz | Art. no. 508875

EW-D AB (U) | 823 – 865 MHz | Art. no. 508876

EW-D AB (V) | 902 – 960 MHz | Art. no. 508877

EW-D AB (Y) | 1785 – 1805 MHz | Art. no. 508878

Use: „Information on antenna amplifiers and cable lengths“

Specifications: „EW-D AB antenna booster“



Antennas

Rod antennas

Product versions:

Half Wave Dipole (Q) | 470 – 550 MHz | Art. no. 508868

Half Wave Dipole (R) | 520 – 608 MHz | Art. no. 508869

Half Wave Dipole (S) | 606 – 694 MHz | Art. no. 508870

Half Wave Dipole (U) | 823 – 865 MHz | Art. no. 508871

Half Wave Dipole (V) | 902 – 960 MHz | Art. no. 508966

Half Wave Dipole (Y) | 1785 – 1805 MHz | Art. no. 508872

ADP UHF passive directional antenna (470 – 1075 MHz)

ADP UHF | 470 – 1075 MHz | Art. no. 508863

Specifications: „ADP UHF passive directional antenna (470 – 1075 MHz)“

AD 1800 passive directional antenna

AD 1800 | 1400 – 2400 MHz | Art. no. 504916

Accessories for rack mounting

GA 3 rack mount kit

19" rack adapter for mounting the EW-D EM, EW-DX EM 2 or EW-D ASA in a 19" rack.

Art. no. 503167

AM 2 antenna front mount kit



Antenna front mount kit for installing antenna connections on the front of the rack when using the EW-D EM, EW-DX EM 2 or EW-D ASA together with the GA 3 rack mount kit.

Art. no. 009912

Color Coding Sets

EW-D COLOR CODING SET | For EM, SKM-S, SK | Art. no. 508989

EW-D SK COLOR CODING | For SK | Art. no. 508990

EW-D SKM COLOR CODING | For SKM-S | Art. no. 508991

EW-D EM COLOR CODING | For EM | Art. no. 508992

- ▷ „Using EW-D Color Coding Sets to label transmission paths“



Frequency ranges

Frequency tables with the factory presets for all available frequency ranges can be found in the download area of the Sennheiser website at:

www.sennheiser.com/download

- ▷ Enter **EW-D** in the search bar to show the frequency tables.

EW-D

The **EW-D EM**, **EW-D SKM-S** and **EW-D SK** products are available in the following frequency ranges:

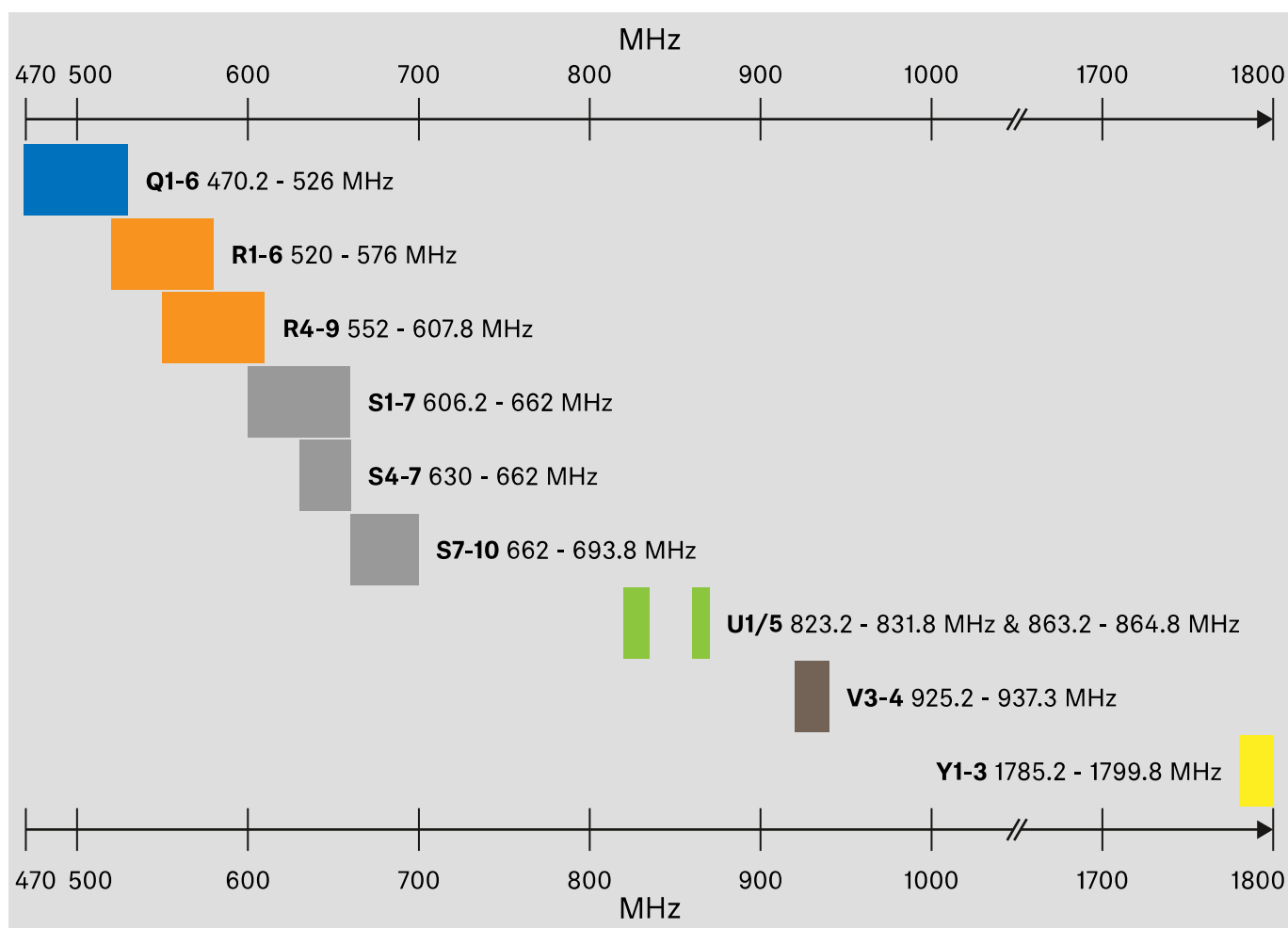



EW-DX

The **EW-DX EM 2**, **EW-DX SKM**, **EW-DX SKM-S**, **EW-DX SK** and **EW-D SK 3-PIN** products are available in the following frequency ranges:

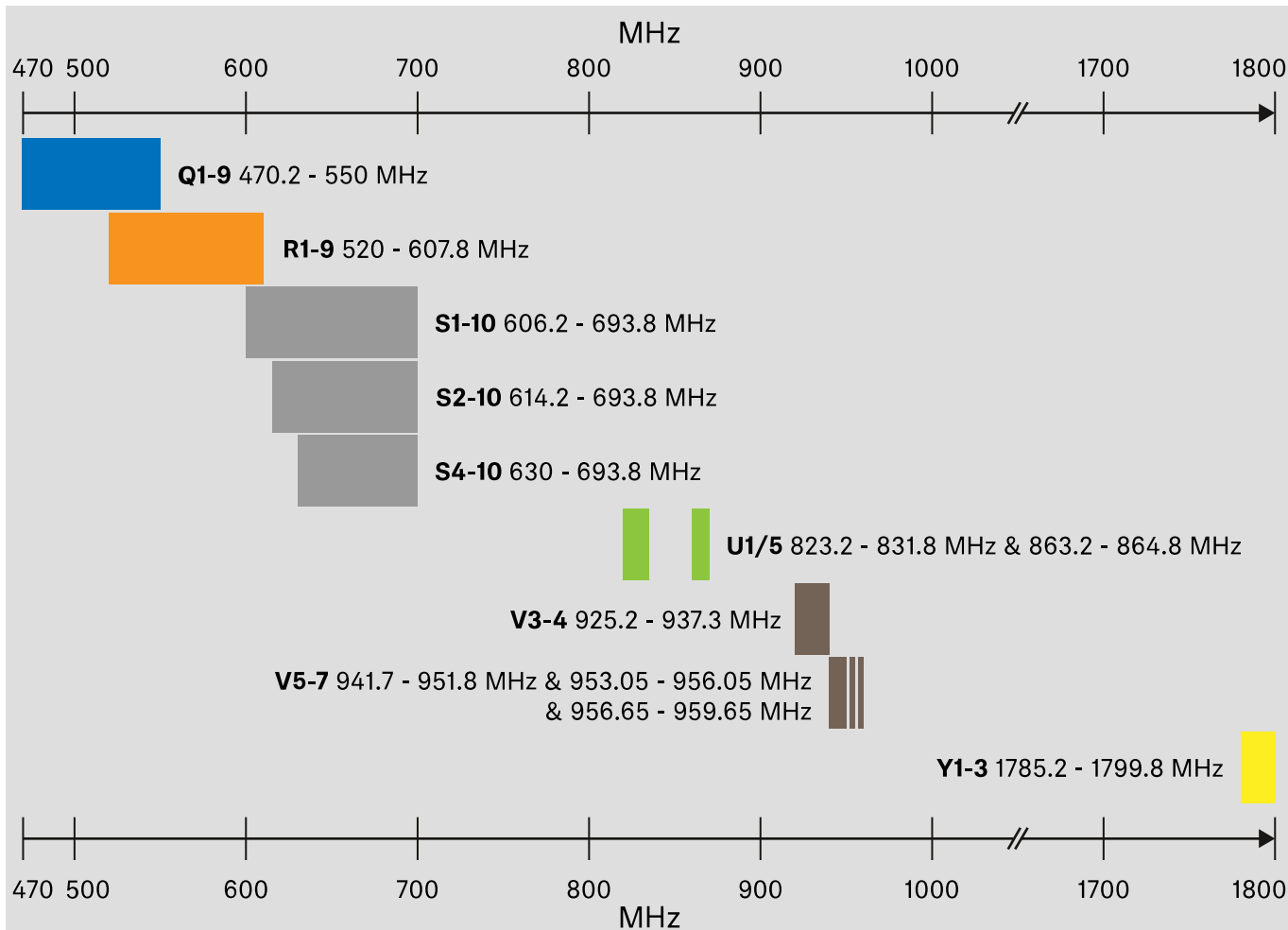



Accessories

The **EW-D AB** antenna booster and the **Half Wave Dipole** rod antennas are available in the following frequency ranges:

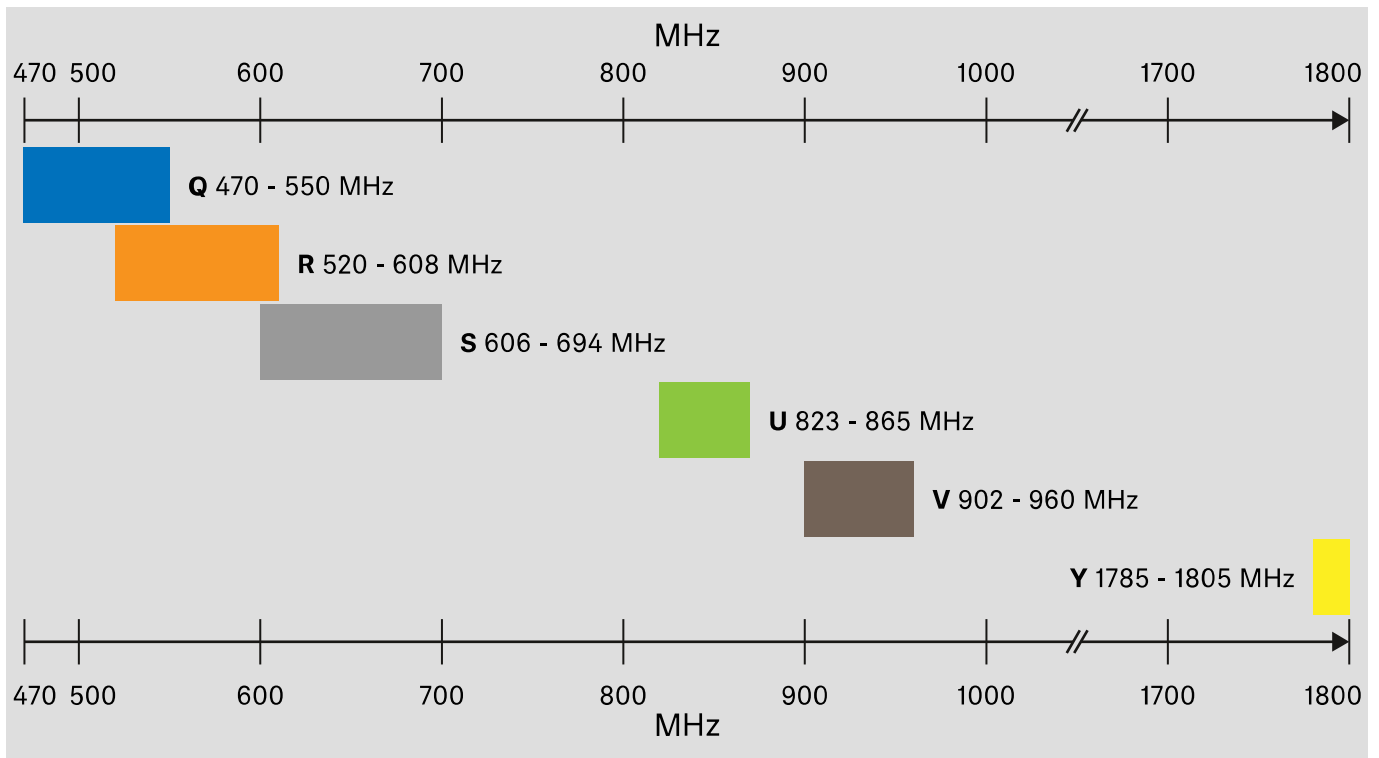

The **EW-D ASA** antenna splitter is available in the following frequency ranges:

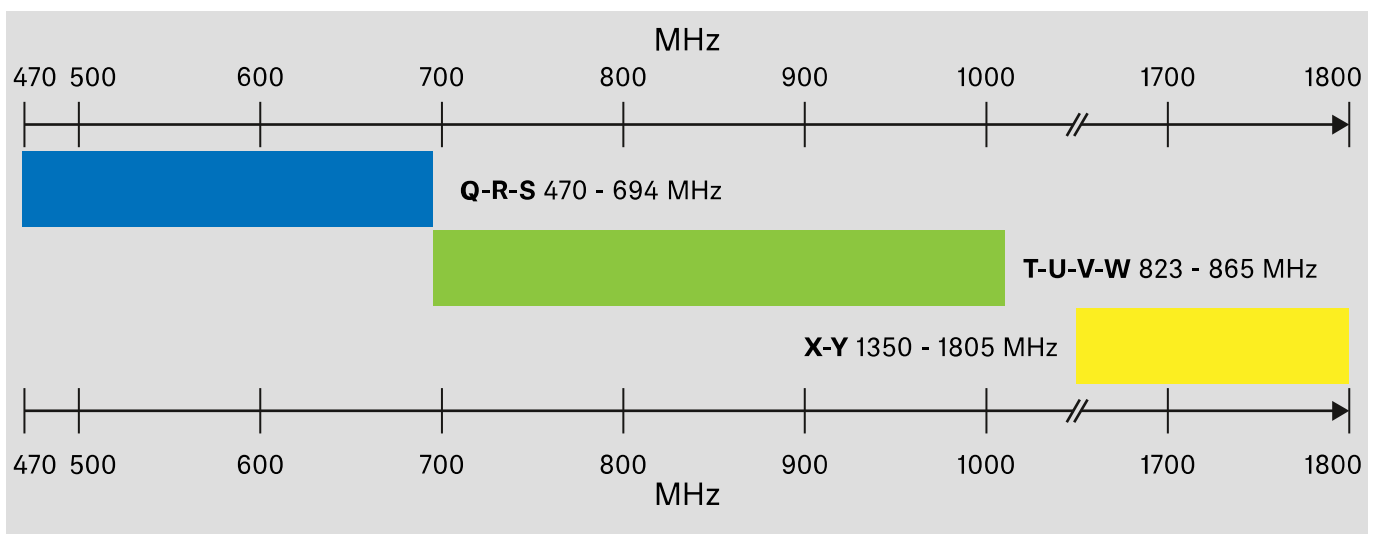



INSTRUCTION MANUAL

Starting up and operating devices of the Evolution Wireless Digital series

Products of the EW-D series

- ▷ „EW-D EM rack receiver“
- ▷ „EW-D SKM-S handheld transmitter“
- ▷ „EW-D SK bodypack transmitter“

Products of the EW-DX series

- ▷ „EW-DX EM 2 rack receiver“
- ▷ „EW-DX SKM | EW-DX SKM-S handheld transmitter“
- ▷ „EW-DX SK | EW-DX SK 3-PIN bodypack transmitter“

Establishing a radio link and synchronizing devices / Compatibility between EW-D and EW-DX

„Establishing a radio link | Synchronizing the receiver and transmitter“

Accessories

- ▷ „Charging the BA 70 rechargeable battery in the L 70 USB charger“
- ▷ „Charging the EW-DX SKM(-S) handheld transmitter, the EW-DX SK (3-PIN) bodypack transmitter or the BA 70 rechargeable battery in the CHG 70N charger“
- ▷ „EW-D ASA antenna splitter“

Cleaning and maintenance

- ▷ „Cleaning and maintenance“



EW-D EM rack receiver

Connectors and controls

Front

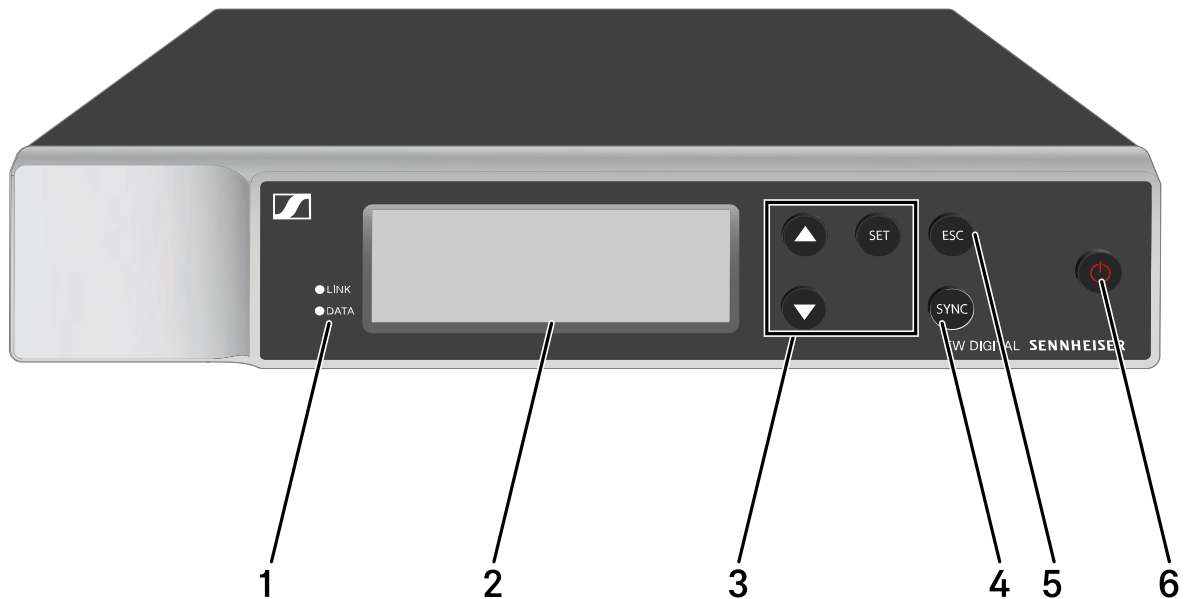

- 1 **LINK** and **DATA** LEDs to indicate connection status and Bluetooth status
 - See „Meaning of the LEDs“
- 2 Display for status information and operating menu
 - See „Displays on the receiver’s display panel“
- 3 **UP/DOWN/SET** menu buttons for navigating the operating menu
 - See „Making settings in the menu“
- 4 **SYNC** button for synchronizing the transmitter and receiver
 - See „Establishing a radio link | Synchronizing the receiver and transmitter“
- 5 **ESC** button for canceling an action in the menu
 - See „Making settings in the menu“
- 6 **ON/OFF** button for switching the device on and off
 - See „Switching the receiver on and off“



Back

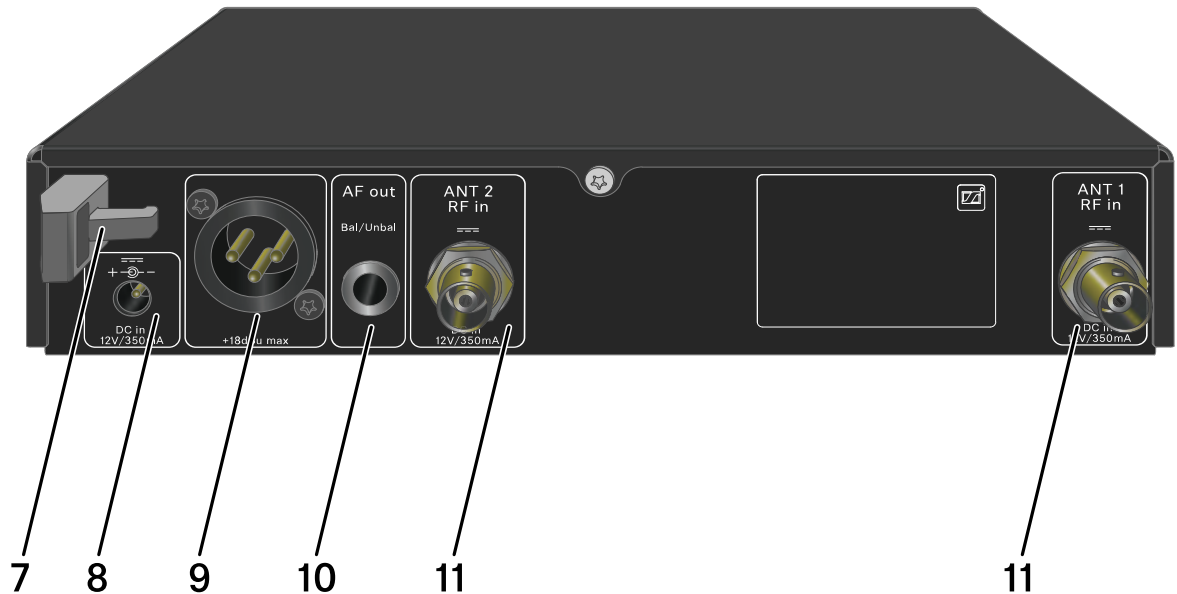

- 7 Strain relief for the connection cable of the power supply unit
 - See „Connecting/disconnecting the receiver to/from the power supply system“
- 8 **DC in** connection socket for the power supply unit
 - See „Connecting/disconnecting the receiver to/from the power supply system“
- 9 XLR-3 socket **AF out Bal** for audio output
 - See „Outputting audio signals“
- 10 6.3 mm jack socket **AF out Unbal** for audio output
 - See „Outputting audio signals“
- 11 BNC sockets **ANT 1 RF in** and **ANT 2 RF in** for antenna inputs
 - See „Connecting antennas“



Connecting/disconnecting the receiver to/from the power supply system

Only use the supplied power supply unit. It is designed for your receiver and ensures safe operation.

You will find the power supply unit and the country adapters in the packaging under the tray:

To connect the receiver to the power supply system:

- ▷ Insert the plug of the power supply unit into the **DC in** socket on the receiver.
- ▷ Pass the cable of the power supply unit through the strain relief.
- ▷ Slide the supplied country adapter onto the power supply unit.
- ▷ Plug the power supply unit into the wall socket.

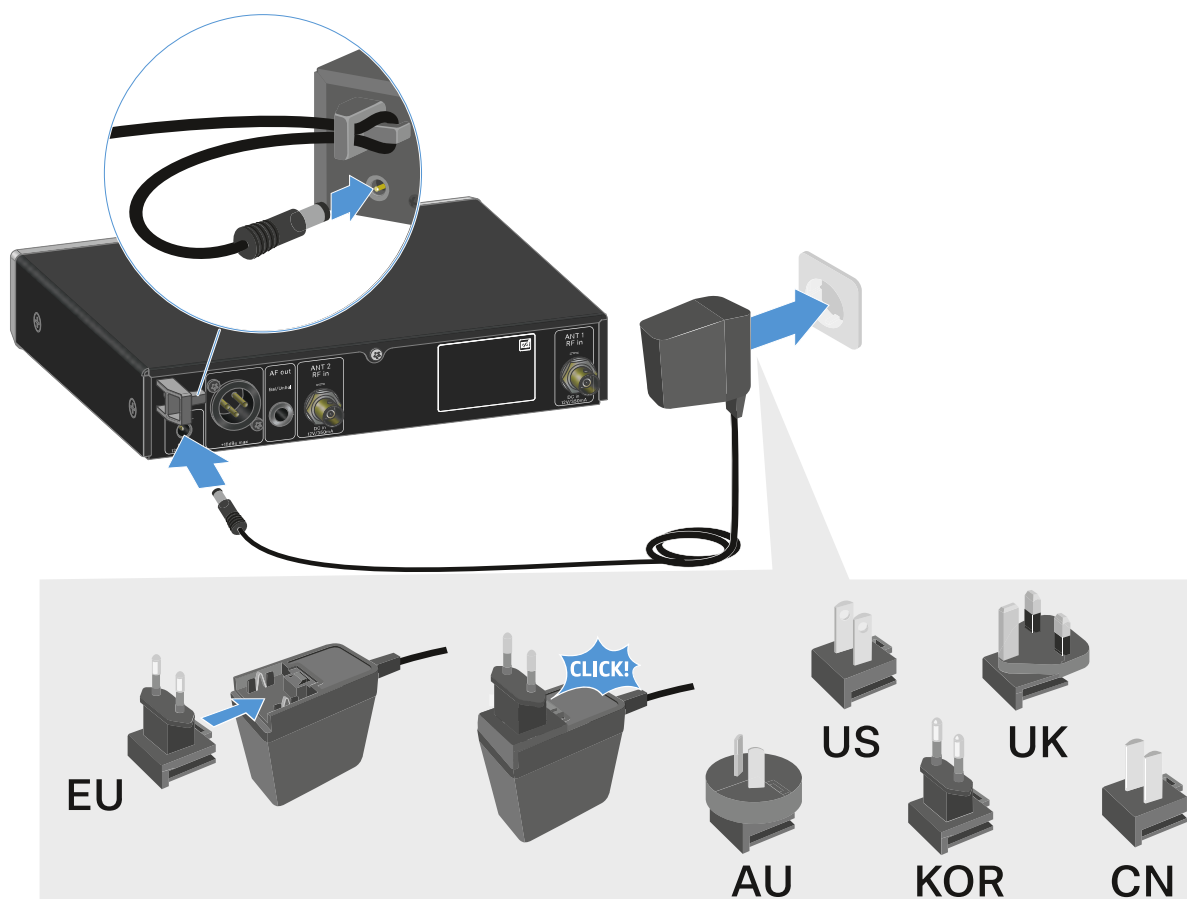

To completely disconnect the receiver from the power supply system:

- ▷ Unplug the power supply unit from the wall socket.
- ▷ Unplug the power supply unit from the **DC in** socket on the receiver.



Connecting antennas

Connecting rod antennas

To connect the supplied rod antennas:

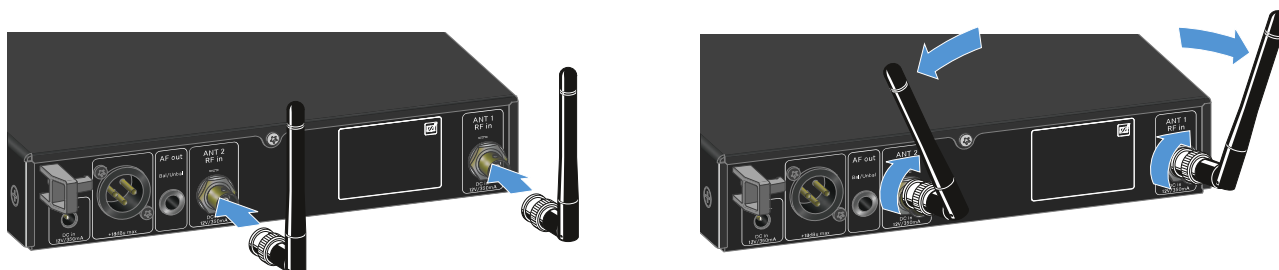

- ▷ Connect the antennas to the two antenna inputs on the receiver as shown in the figure.
- ▷ Slightly angle the antennas to the left and right as shown in the figure.

Connecting remote antennas

To connect remote antennas:

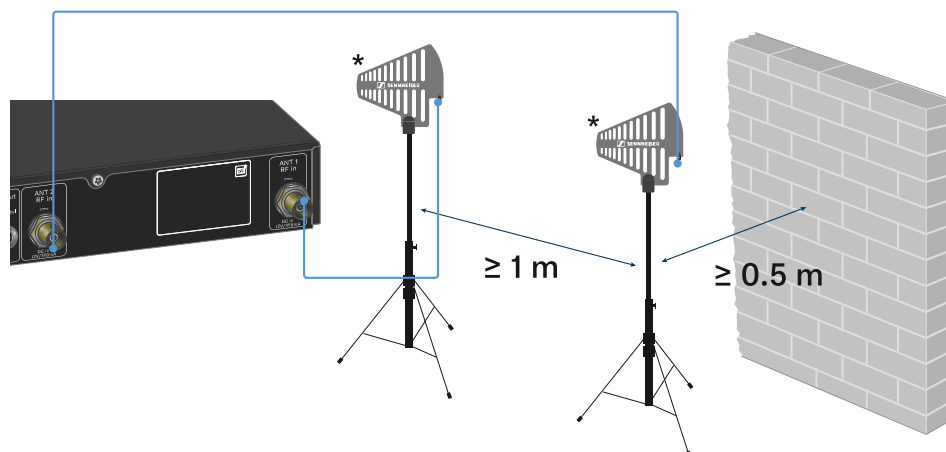

- ▷ Connect the antennas to the two antenna inputs on the receiver as shown in the figure.
- ▷ Observe the specified minimum spacing.

*Recommended antennas:

- **ADP UHF** | 470 – 1075 MHz
- **AD 1800** | 1400 – 2400 MHz

If you are using more than one receiver, we recommend using remote antennas and possibly the EW-D ASA antenna splitter („EW-D ASA antenna splitter“).



Outputting audio signals

The EW-D EM has a balanced XLR-3M output socket and an unbalanced 6.3 mm jack output socket.

- ▷ Always use only one of the two output sockets.

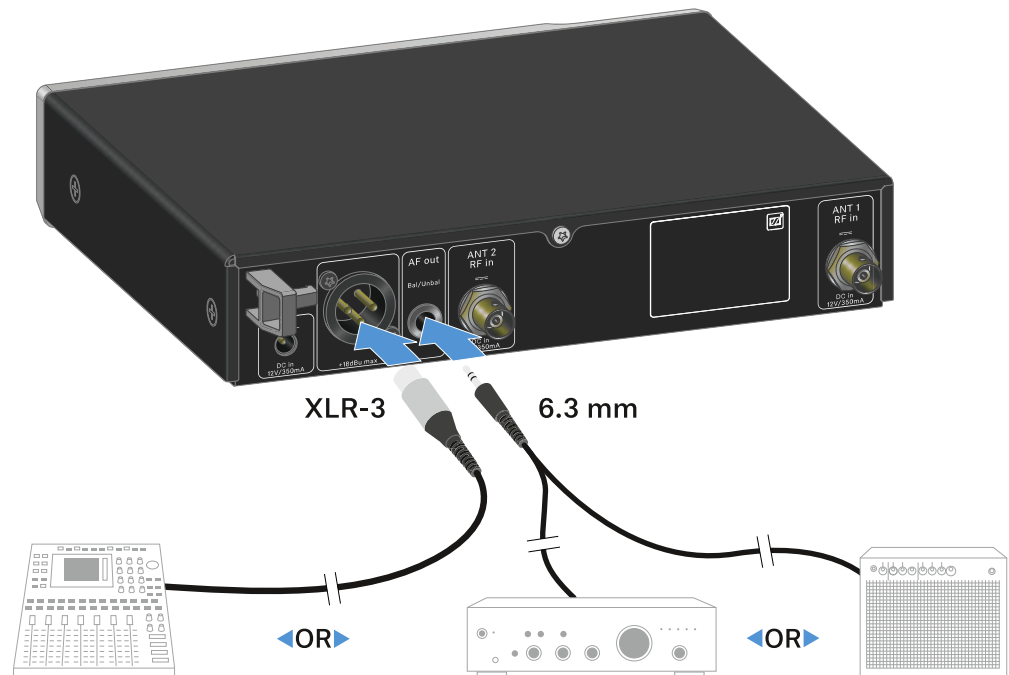

To connect an XLR cable:

- ▷ Plug the XLR cable into the **AF out Bal** socket on the EW-D EM.

To connect a jack cable:

- ▷ Plug the jack cable into the **AF out Unbal** socket on the EW-D EM.



Installing receivers in a rack

Observe the following instructions when mounting the receiver in a rack.

The mounting brackets for installing the receiver in the rack can be found in the packaging under the tray.

CAUTION!

Rack mounting poses risks

When installing the device in a closed 19" rack or multi-rack assembly, please consider that, during operation, the ambient temperature, the mechanical load and the electrical potentials will be different from those of devices which are not mounted into a rack.

- ▷ Make sure that the ambient temperature within the rack does not exceed the permissible temperature limit stated in the specifications. See „SPECIFICATIONS“.
- ▷ Ensure sufficient ventilation; if necessary, provide additional ventilation.
- ▷ Make sure that the mechanical load of the rack is even.
- ▷ When connecting to the power supply system, observe the information indicated on the type plate. Avoid overloading the circuits. If necessary, provide overcurrent protection.
- ▷ When mounting in a rack, please note that intrinsically harmless leakage currents of the individual power supply units may accumulate, thereby exceeding the permissible limit value. As a remedy, ground the rack via an additional ground connection.



Mounting a single receiver in a rack

- ▷ Connect the mounting brackets to the sides of the receiver as shown.

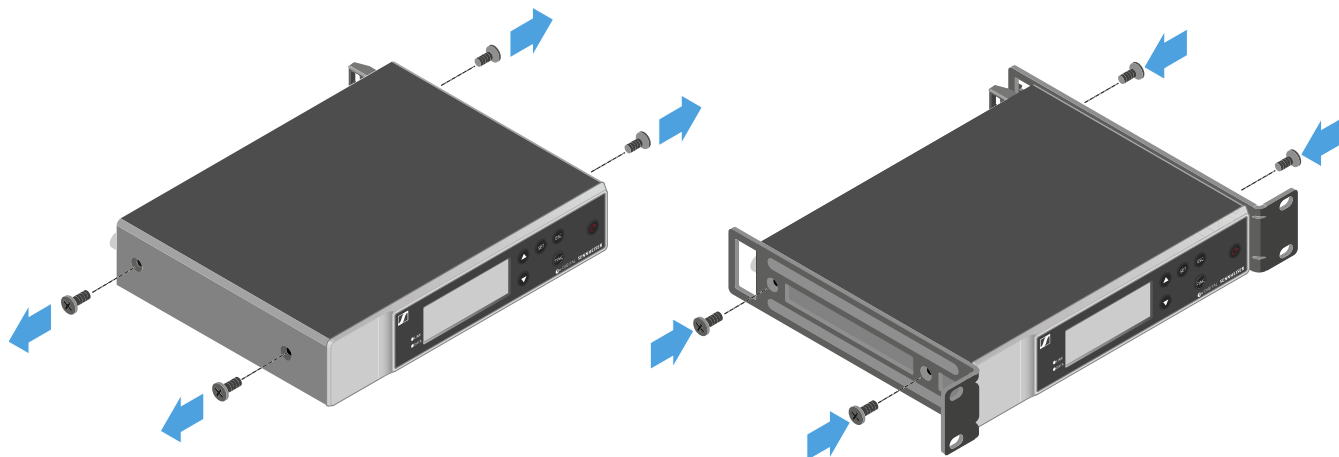

- ▷ Attach the front panel as shown.
- ▷ If desired, attach the antennas to the front panel as shown. This requires the optional AM 2 antenna front mount kit (see „Accessories for rack mounting“).

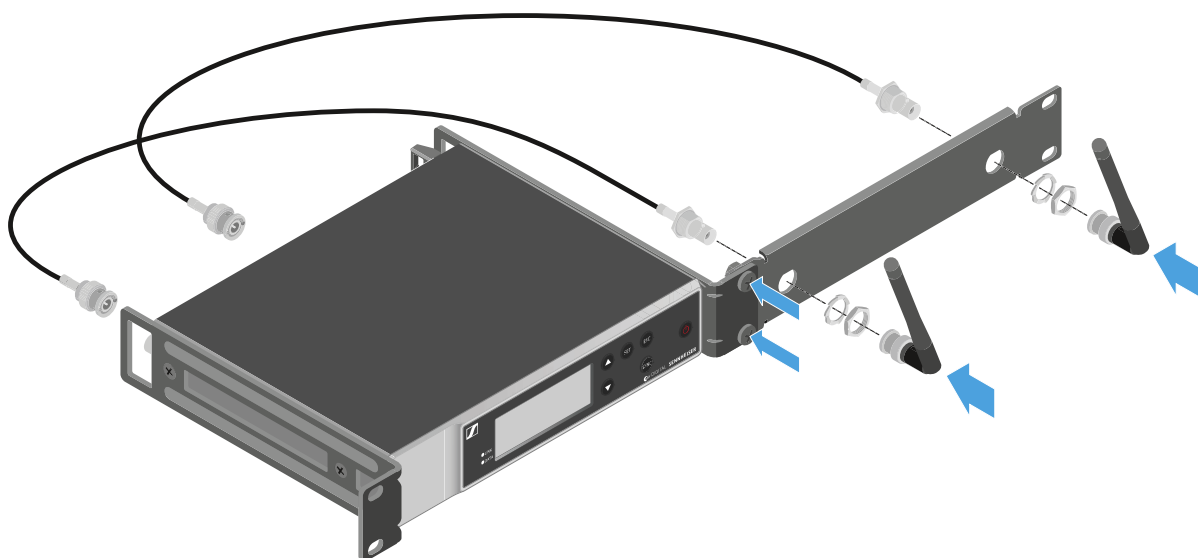



Mounting two receivers side by side in a rack

- ▷ Place both receivers upside down and side by side on an even surface.
- ▷ Tighten the jointing plate as shown.
- ▷ Attach the mounting brackets as shown.

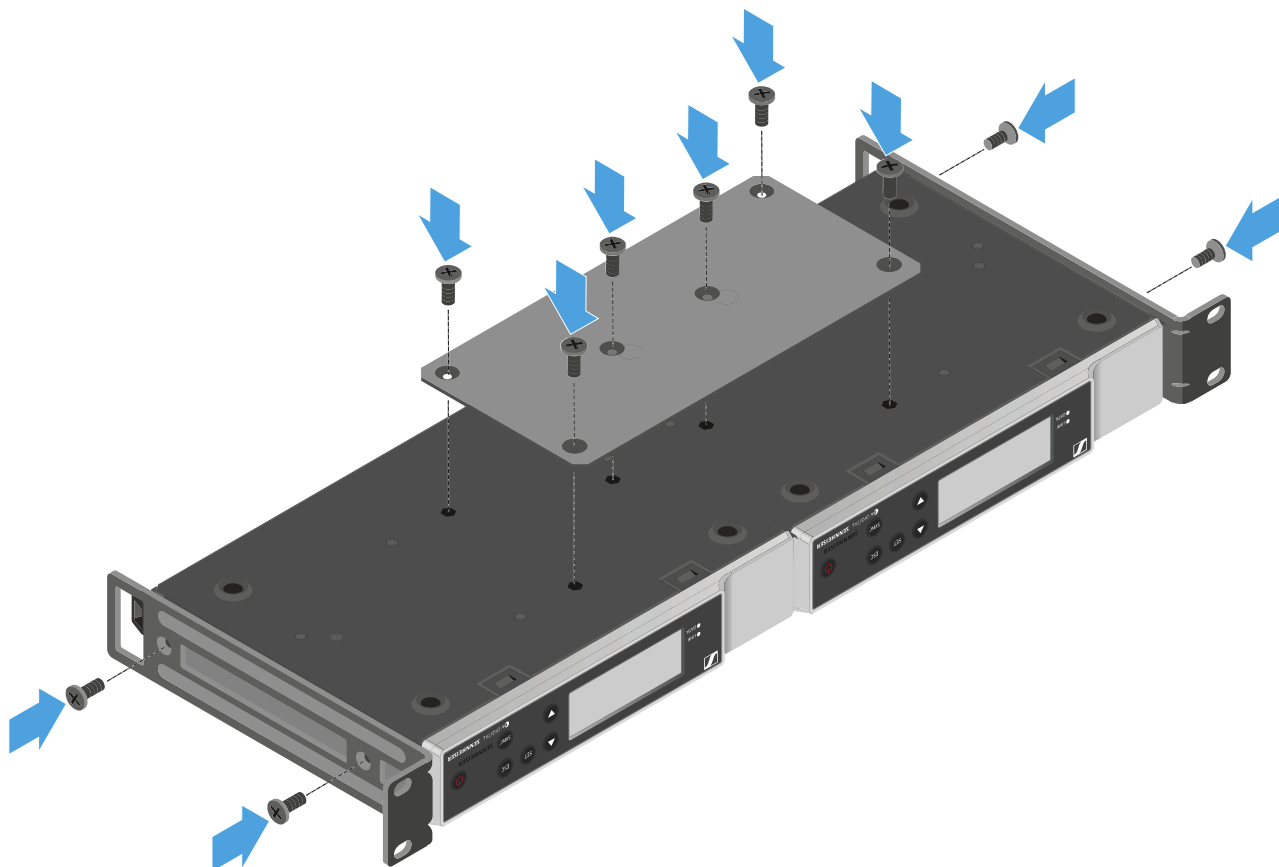



Switching the receiver on and off

To switch the receiver **on**:

- ▷ Short-press the **ON/OFF** button.
The receiver switches on.

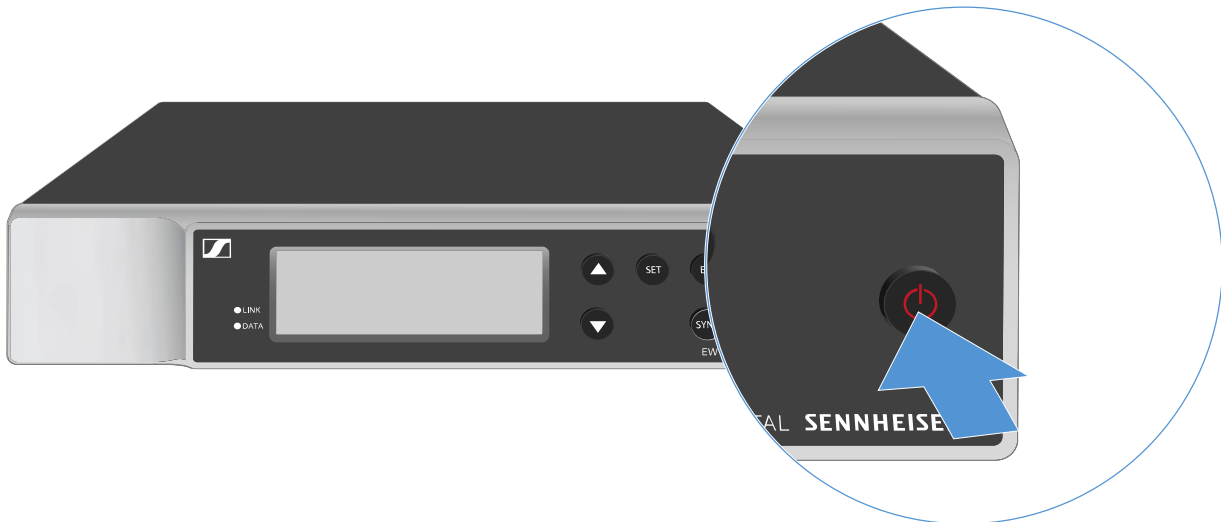

To switch the receiver to **standby mode**:

- ▷ If necessary, deactivate the lock-off function (see „Lock-off function“).
- ▷ Hold down the **ON/OFF** button until the display switches off.

To **switch the receiver off completely**:

- ▷ Disconnect the receiver from the power supply system by unplugging the power supply unit from the wall socket.



Lock-off function

To activate the key lock:

- ▷ Press the **UP** and **DOWN** buttons simultaneously. Key lock is activated and the lock icon is shown on the display.

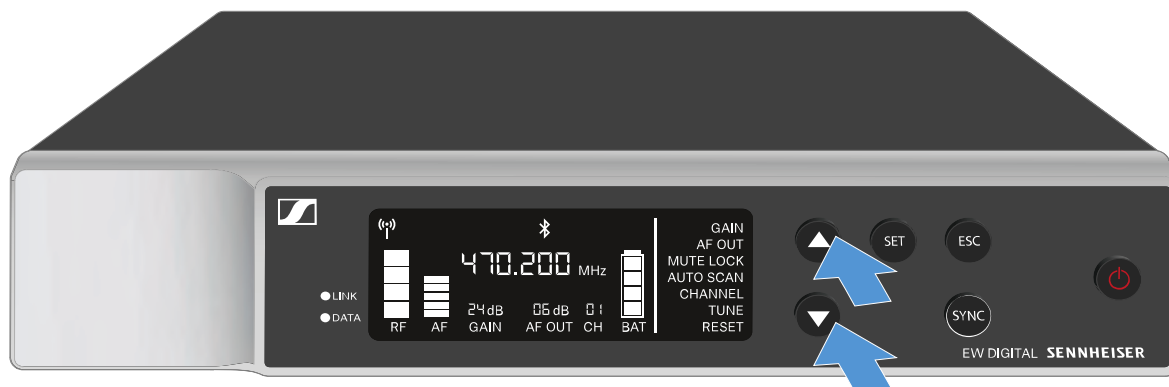

To deactivate the key lock:

- ▷ Simultaneously press the **UP** and **DOWN** buttons again. Key lock is deactivated and the lock icon disappears from the display.

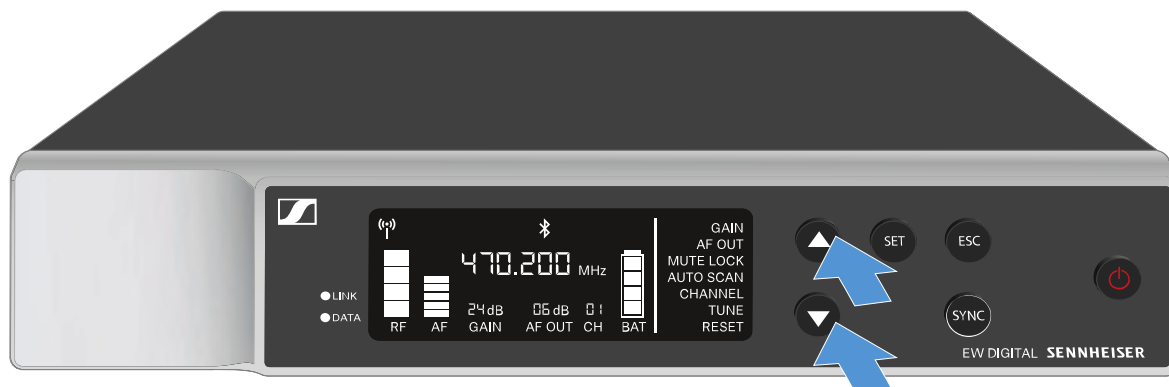



Meaning of the LEDs

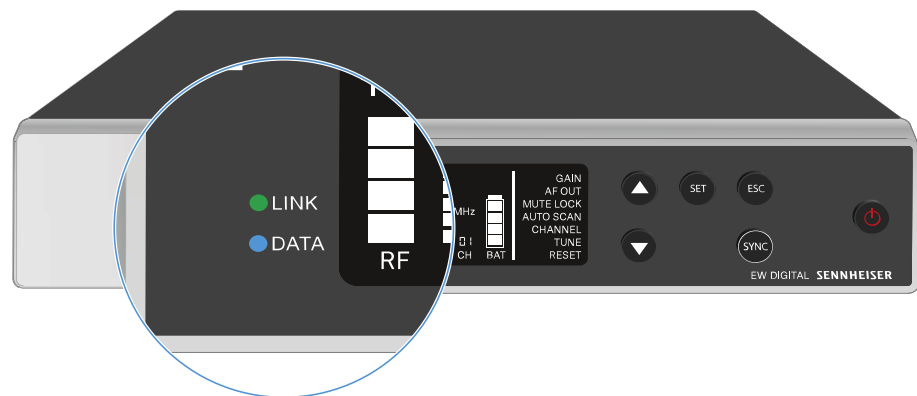

The **LINK** and **DATA** LEDs on the front of the receiver can indicate the following information.

LINK LED

The **LINK** LED provides information about the status of the radio link between the transmitter and receiver, as well as status information for the paired transmitter.

The LED is green:

- ▷ The link between the transmitter and receiver is established.
- ▷ The audio signal is active.

The LED is yellow:

- ▷ The link between the transmitter and receiver is established.
 - ▷ The audio signal is muted.
- or
- ▷ No microphone module is mounted on the SKM-S handheld transmitter.
-



The LED is flashing yellow:

- ▷ The link between the transmitter and receiver is established.
 - ▷ The audio signal is overdriven (clipping).
-

The LED is continuously red:

- ▷ No link between the transmitter and receiver.
-

The LED is flashing red:

- ▷ The link between the transmitter and receiver is established.
 - ▷ The battery/rechargeable battery in the paired transmitter is low.
-

DATA LED

The **DATA** LED provides information on the receiver's **Bluetooth Low Energy** link to the **EW-D Smart Assist** app and on the synchronization of transmitters and receivers.

The LED is flashing blue:

- ▷ The **Bluetooth Low Energy** link is being established between the receiver and a smartphone or tablet with the **EW-D Smart Assist** app.
 - or
 - ▷ The receiver is being synchronized with a transmitter.
-

The LED is continuously blue:

- ▷ The firmware is being updated.
-

The LED is off:

- ▷ Normal operation
 - ▷ There is currently no active data link.
-



Displays on the receiver's display panel

Status information such as frequency, reception quality, battery status and audio level is shown on the display.

The display also shows the operating menu, which you can use to configure all of the settings (see „Making settings in the menu“).

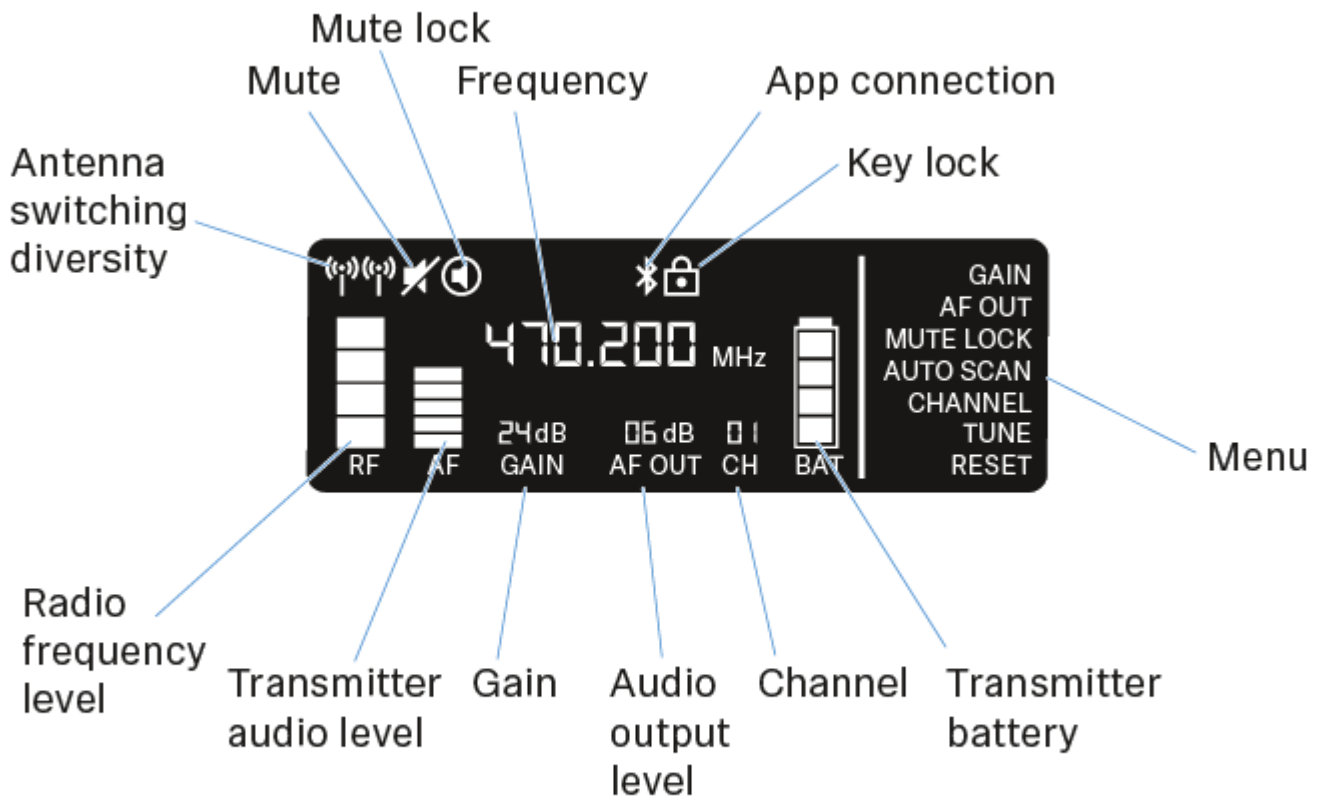

Further information

Antenna switching diversity / radio level: „Establishing a radio link | Synchronizing the receiver and transmitter“

Mute / mute lock: „MUTE LOCK menu item“ | „Muting the handheld transmitter“ | „Muting the bodypack transmitter“



Frequency: „AUTO SCAN menu item“ | „CHANNEL menu item“
| „TUNE menu item“

Connecting to the app „EW-D Smart Assist app“

Key lock: „Lock-off function“

Menu: „Making settings in the menu“

Transmitter battery: SKM-S -> „Inserting and removing the
batteries/rechargeable batteries“ | SK -> „Inserting and re-
moving the batteries/rechargeable batteries“

Channel: „CHANNEL menu item“

Audio output level: „AF OUT menu item“

Gain: „GAIN menu item“

Transmitter audio level: „GAIN menu item“



Making settings in the menu

Buttons for navigating the menu

Use the following buttons to navigate through the receiver's operating menu.

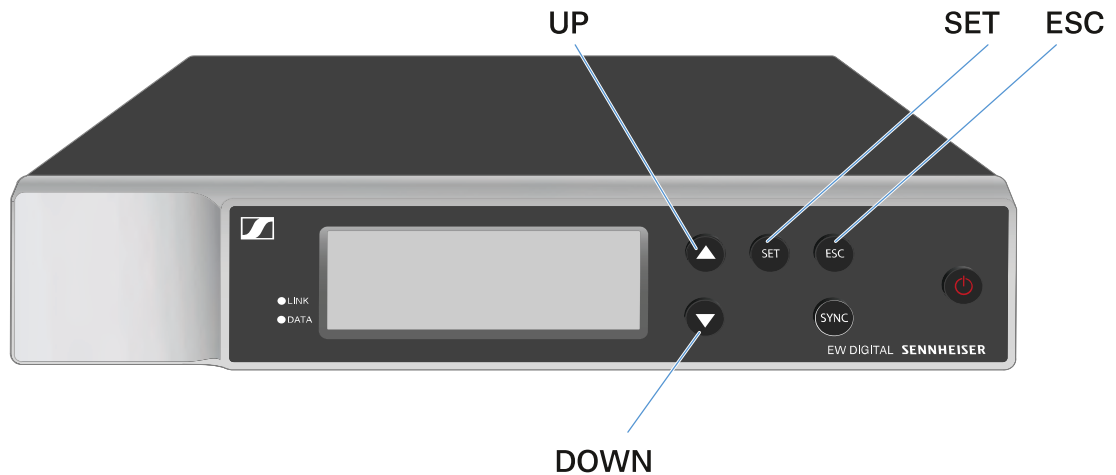

Press the **SET** button

- Open the menu
 - Save settings in a menu item
-

Press the **UP** or **DOWN** button

- Changes to the previous or next menu item
 - Changes the setting of a menu item
-

Press the **ESC** button

- Cancel input
-



Opening the menu and navigating the menu items

To open the menu:

- ▷ Press the **SET** button.
The first menu item **GAIN** flashes.

To navigate the menu items:

- ▷ Press the **UP** and **DOWN** buttons.
The currently active menu item flashes.

To open a menu item:

- ▷ Navigate to the desired menu item until it flashes.
- ▷ Press the **SET** button to open the selected menu item.

GAIN menu item

Under the **GAIN** menu item, you can set the level of the audio signal coming from the coupled transmitter (e.g. vocals via EW-D SKM-S or guitar via EW-D SK).

- ▷ Open the **GAIN** menu item.
The item flashes on the display as follows.

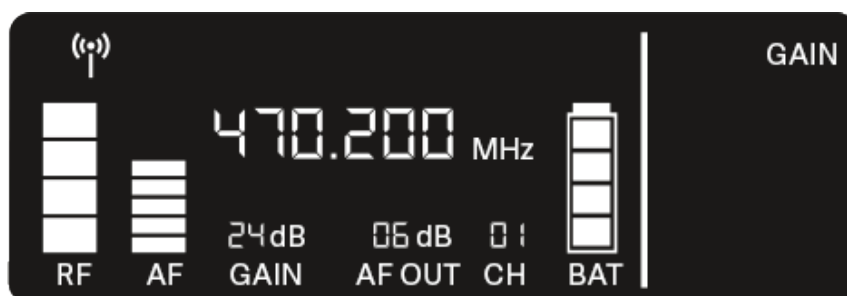

- ▷ Press the **UP** or **DOWN** button to adjust the value.
Make sure that the level indicator **AF** on the display is not too high. The **LINK** LED flashes yellow when the signal is overdriven.
- ▷ Press the **SET** button to save the set value.

Recommended settings for a unity gain link:

Unity gain refers to the configuration where the audio signal arriving at a device leaves the device with the same level.

Example: If you are using an EW-D wireless link instead of a guitar cable, with **unity gain** settings, the volume of the



guitar in the guitar amplifier will be as high as it would be if using a guitar cable.

Possible **unity gain** settings:

- ▷ **AF Out 18 dB | Gain 27 dB**
- ▷ **AF Out 12 dB | Gain 33 dB**
- ▷ **AF Out 6 dB | Gain 39 dB**

AF OUT menu item

Under the **AF OUT** menu item, you can set the level of the audio signal coming from the receiver's audio outputs (**AF out Bal/Unbal**). This audio signal can be output to a mixing console or an amplifier, for example.

- ▷ Open the **AF OUT** menu item.
The item flashes on the display as follows.

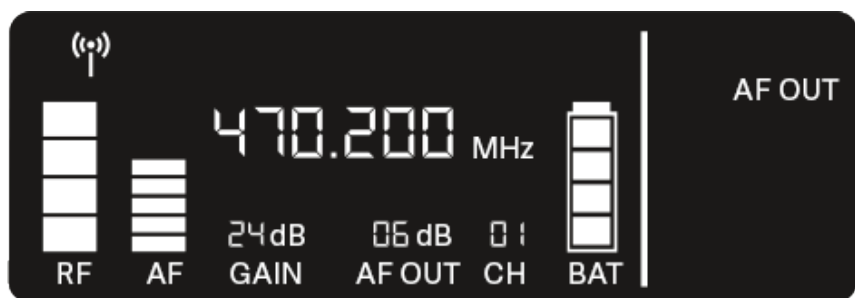

- ▷ Press the **UP** or **DOWN** button to adjust the value.
Make sure that the signal in the next device in the signal chain (e.g. mixing console, power amplifier, guitar amplifier, etc.) is not overdriven.
- ▷ Press the **SET** button to save the set value.

Recommended settings for a unity gain link:

Unity gain refers to the configuration where the audio signal arriving at a device leaves the device with the same level.

Example: If you are using an EW-D wireless link instead of a guitar cable, with **unity gain** settings, the volume of the guitar in the guitar amplifier will be as high as it would be if using a guitar cable.

Possible **unity gain** settings:

- ▷ **AF Out 18 dB | Gain 27 dB**
- ▷ **AF Out 12 dB | Gain 33 dB**
- ▷ **AF Out 6 dB | Gain 39 dB**



MUTE LOCK menu item

Under the **MUTE LOCK** menu item, you can disable the mute switch on the paired transmitter.

The transmitter can then no longer be muted.

- ▷ Open the **MUTE LOCK** menu item.
The item flashes on the display as follows.

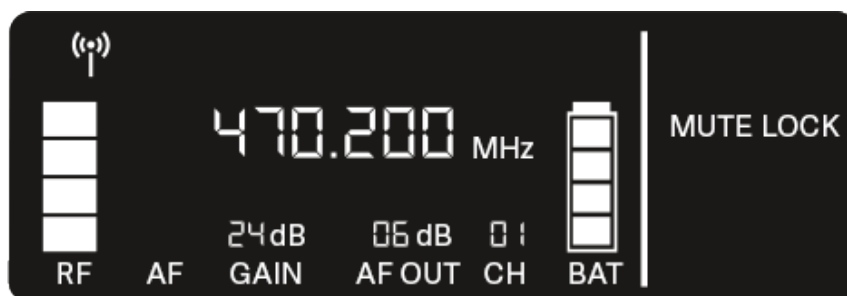

- ▷ Press the **UP** or **DOWN** button to enable or disable the function.

If the following icon appears on the display, the transmitter's mute switch is disabled.

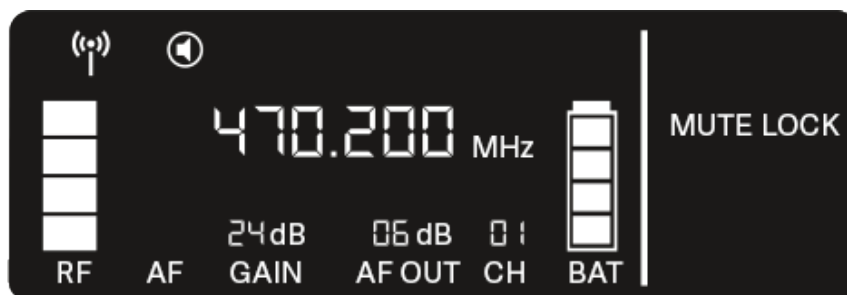

- ▷ Press the **SET** button to save the set value.



AUTO SCAN menu item

Under the **AUTO SCAN** menu item, you can perform an automatic frequency scan of your area. This enables you to easily find and assign free radio frequencies.

The scan starts at the lowest frequency in the device's frequency range.

- ▷ Open the **AUTO SCAN** menu item.
The scan starts automatically. The next free frequency is shown on the display.

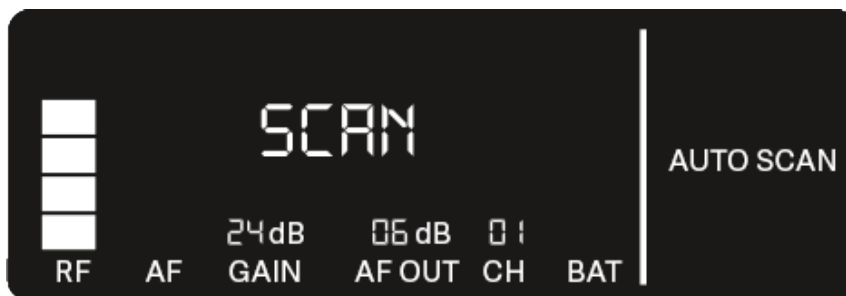

- ▷ Press the **SET** button to accept the displayed frequency.
or
- ▷ Press the **UP** or **DOWN** button to display the next free frequency.
or
- ▷ Press the **ESC** button to cancel the scan.
The previous frequency remains unchanged.

If you have set a new frequency, you must still **synchronize** the **receiver** with the **transmitter** to establish the radio link (see „Establishing a radio link | Synchronizing the receiver and transmitter“).



CHANNEL menu item

Under the **CHANNEL** menu item, you can set the radio frequency by selecting a preset channel.

If you are not sure whether the selected frequency is free, we recommend performing a scan to detect all free frequencies: „AUTO SCAN menu item“.

- ▷ Open the **CHANNEL** menu item.
The item flashes on the display as follows.

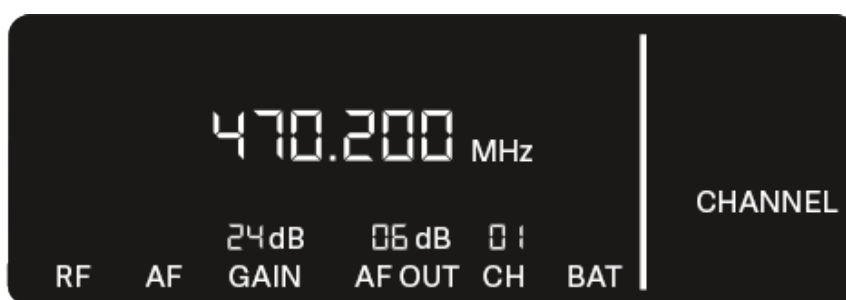

- ▷ Press the **UP** or **DOWN** button to select a preset channel.
- ▷ Press the **SET** button to accept the displayed frequency.
- or
- ▷ Press the **ESC** button to cancel the setting.
The previous frequency remains unchanged.

If you have set a new frequency, you must still **synchronize** the **receiver** with the **transmitter** to establish the radio link (see „Establishing a radio link | Synchronizing the receiver and transmitter“).



TUNE menu item

Under the **TUNE** menu item, you can manually set the radio frequency independently of the preset channels.

If you are not sure whether the selected frequency is free, we recommend performing a scan to detect all free frequencies: „AUTO SCAN menu item“.

- ▷ Open the **TUNE** menu item.
The item flashes on the display as follows.

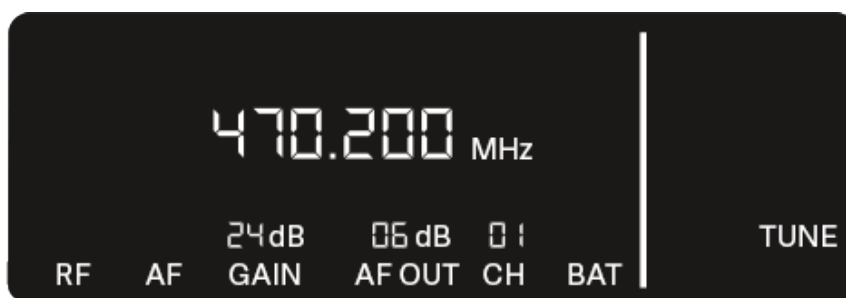

- ▷ Press the **UP** or **DOWN** button to set the frequency in the megahertz range.
- ▷ Press the **SET** button to save the set value.
The item flashes on the display as follows.

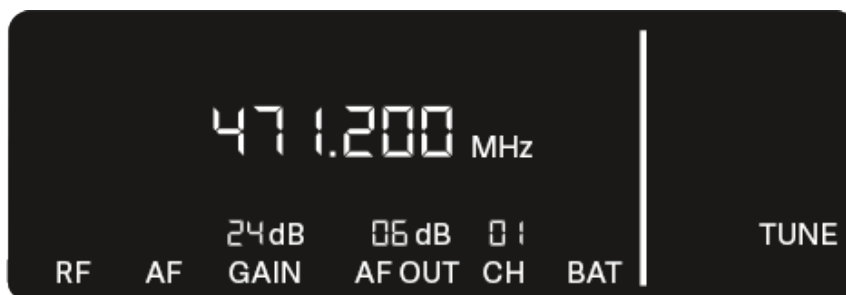

- ▷ Press the **UP** or **DOWN** buttons to finely adjust the frequency in the kilohertz range.
- ▷ Press the **SET** button to accept the displayed frequency.
or
- ▷ Press the **ESC** button to cancel the setting.
The previous frequency remains unchanged.

If you have set a new frequency, you must still **synchronize** the **receiver** with the **transmitter** to establish the radio link (see „Establishing a radio link | Synchronizing the receiver and transmitter“).



RESET menu item

Under the **RESET** menu item, you can reset the receiver to its factory settings.

- ▷ Open the **RESET** menu item.
The item flashes on the display as follows.

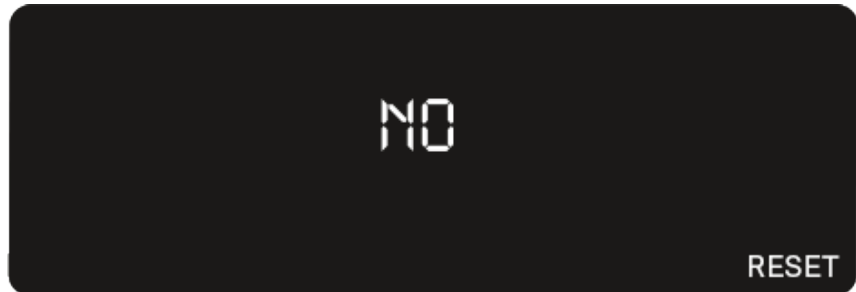

- ▷ Press the **UP** or **DOWN** button to switch between the options **YES** and **NO**.

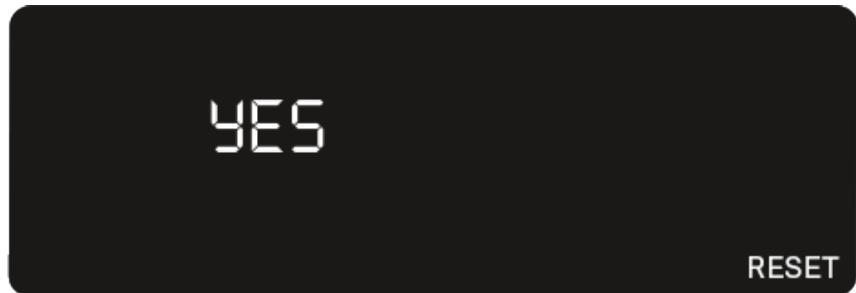

YES: The receiver is reset to its factory settings.

NO: The receiver is not reset.

- ▷ Press the **SET** button to save the set value.



Using EW-D Color Coding Sets to label transmission paths

You can use the **EW-D Color Coding Sets** (see „Color Coding Sets“) to identify which transmitters belong to which receivers. This makes it easier to match up the individual devices, especially in multi-channel systems.

You can also assign colors to the devices in the **EW-D Smart Assist** app.

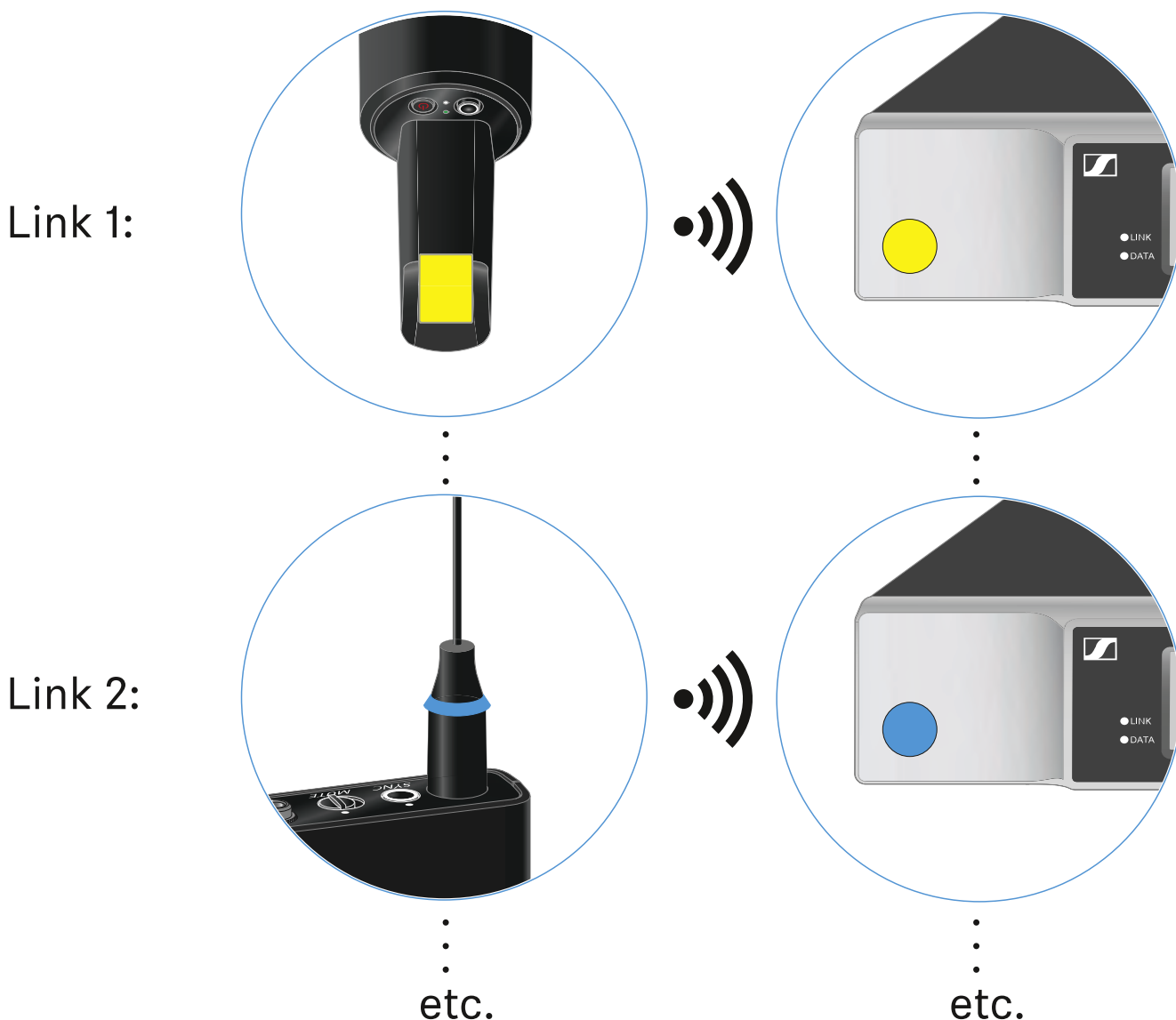



EW-D SKM-S handheld transmitter

Product overview

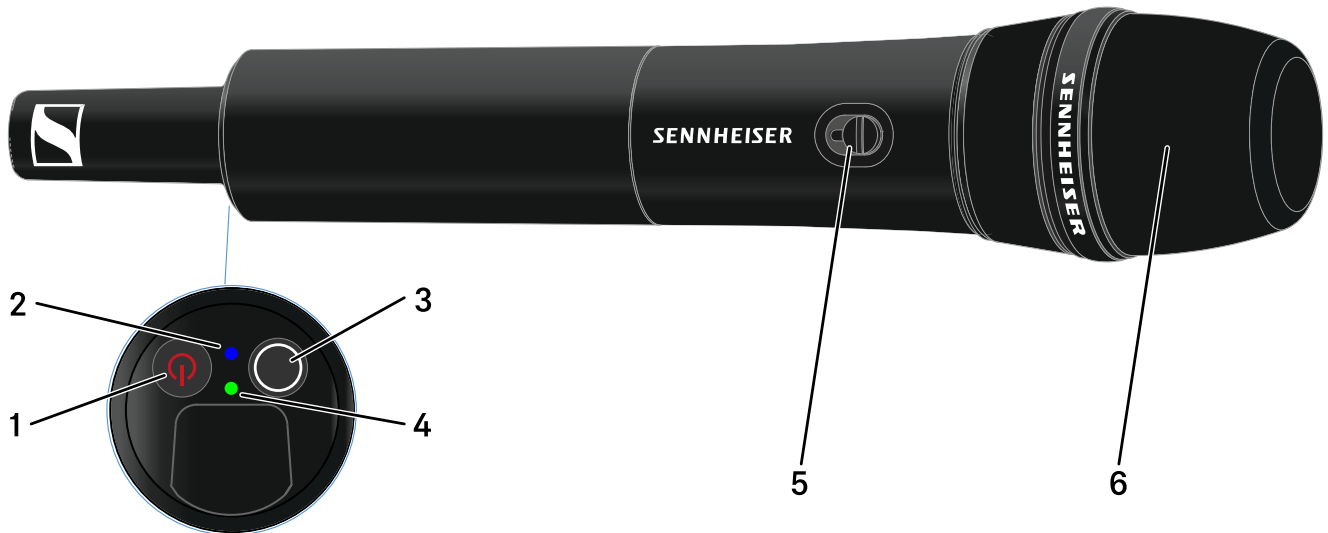

- 1 **ON/OFF** button
 - See „Switching the handheld transmitter on and off“
- 2 **DATA** LED
 - See „Meaning of the LEDs“
- 3 **SYNC** button
 - See „Establishing a radio link | Synchronizing the receiver and transmitter“
- 4 **LINK** LED
 - See „Meaning of the LEDs“
- 5 Mute switch
 - See „Muting the handheld transmitter“
- 6 Microphone module
 - See „Replacing the microphone module“



Inserting and removing the batteries/rechargeable batteries

You can operate the handheld transmitter either with batteries (AA, 1.5 V) or with the rechargeable Sennheiser BA 70 battery.



- ▷ Unscrew the microphone housing as shown in the figure and pull it down as far as it will go.
- ▷ Insert the batteries or the BA 70 rechargeable battery as indicated in the battery compartment. Observe correct polarity.
- ▷ Screw the microphone housing back on.

Note about the BA 70 rechargeable battery

- ▷ Make sure that the **BA 70** rechargeable battery is inserted as follows:

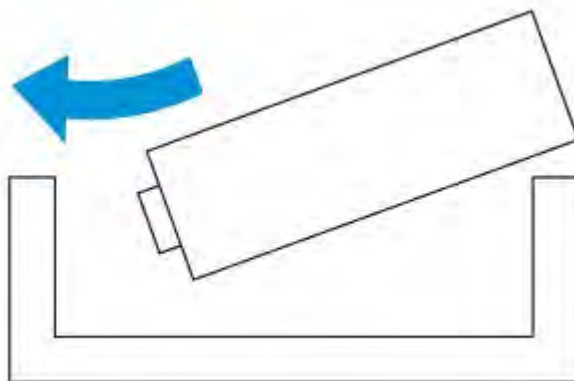



Replacing the microphone module

To replace the microphone module:

- ▷ Unscrew the microphone module.
- ▷ Screw the desired microphone module on.
- ▷ Do not touch the wireless microphone contacts or the microphone module contacts. If you touch the contacts, they may become dirty or bent.

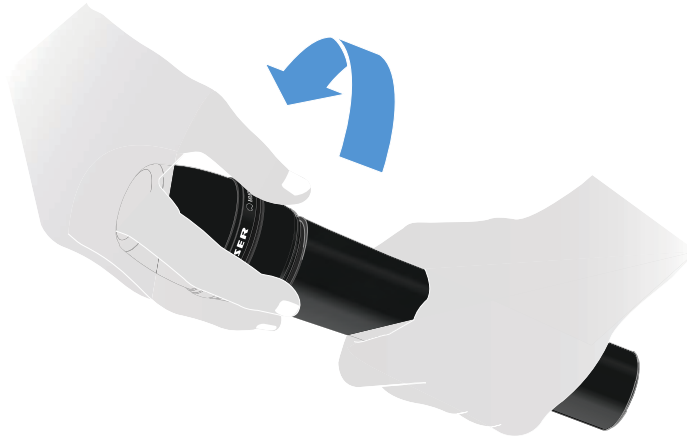

Compatible microphone modules

The following microphone modules are compatible with the handheld transmitter:

- **MMD 835-1** | Dynamic microphone module with cardioid pattern
- **MMD 845-1** | Dynamic microphone module with super-cardioid pick-up pattern
- **MME 865-1** | Condenser microphone module with super-cardioid pick-up pattern
- **MMD 935-1** | Dynamic microphone module with cardioid pattern



- **MMD 945-1** | Dynamic microphone module with super-cardioid pick-up pattern
- **MMK 965-1** | Condenser microphone module with selectable pattern: cardioid and super-cardioid
- **MMD 42-1** | Dynamic microphone module with omni-directional pattern
- **Neumann KK 204** | Condenser microphone module with cardioid pattern
- **Neumann KK 205** | Condenser microphone module with super-cardioid pick-up pattern
- **MM 435** | Dynamic microphone module with cardioid pattern
- **MM 445** | Dynamic microphone module with super-cardioid pick-up pattern
- **ME 9002** | Condenser microphone module with omni-directional pattern
- **ME 9004** | Condenser microphone module with cardioid pattern
- **ME 9005** | Condenser microphone module with super-cardioid pick-up pattern



Using EW-D Color Coding Sets to label transmission paths

You can use the **EW-D Color Coding Sets** (see „Color Coding Sets“) to identify which transmitters belong to which receivers. This makes it easier to match up the individual devices, especially in multi-channel systems.

You can also assign colors to the devices in the **EW-D Smart Assist** app.

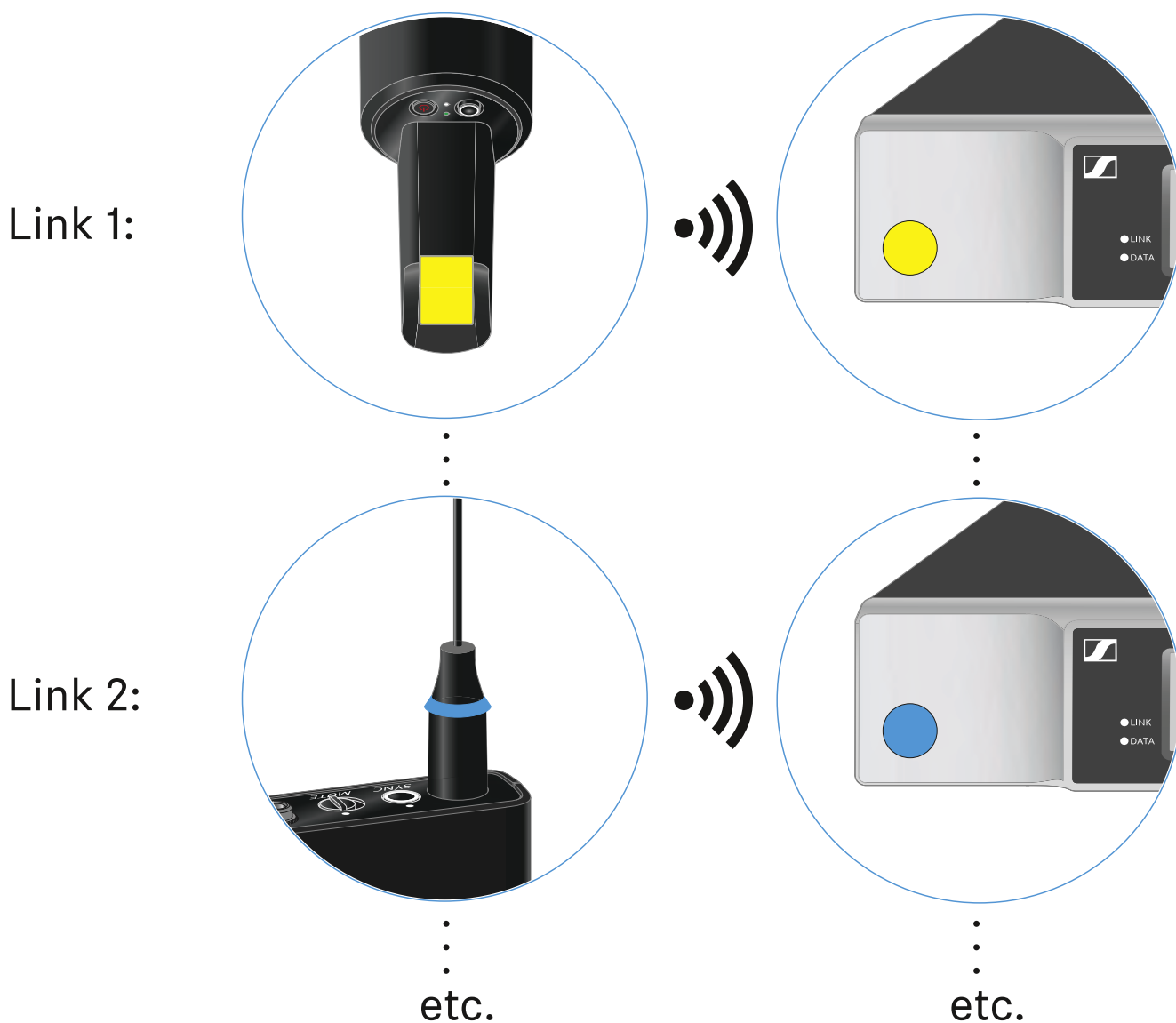



Switching the handheld transmitter on and off

To switch the handheld transmitter on:

- ▶ Short-press the **ON/OFF** button.
The **LINK** LED lights up and the transmitter switches on.



To switch the handheld transmitter off:

- ▶ Hold down the **ON/OFF** button until the LEDs switch off.





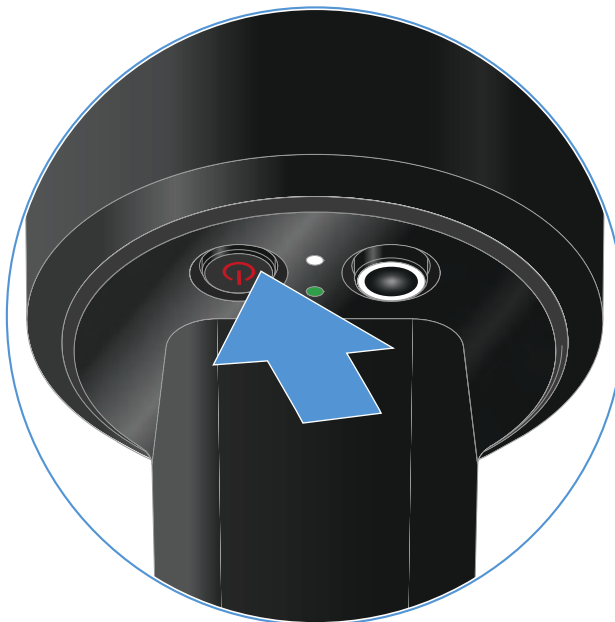

Checking the battery status of the transmitter (Check function)

To check the battery status of the transmitter:

- ▷ Short-press the **ON/OFF** button on the transmitter.



The transmitter's **LINK LED** flashes to indicate the current charge level of the battery or the BA 70 rechargeable battery.

LINK LED	
	≤ 100 %
	≤ 60 %
	≤ 20 %

Pressing the transmitter's **ON/OFF** button will simultaneously trigger the Identify function: „Identifying the paired receiver (Identify function)“.



Identifying the paired receiver (Identify function)

In multi-channel systems, you can use the **Check** function to quickly identify to which receiver the transmitter is paired.

Both the transmitter and receiver must be switched on.

- ▷ Short-press the **ON/OFF** button on the transmitter.

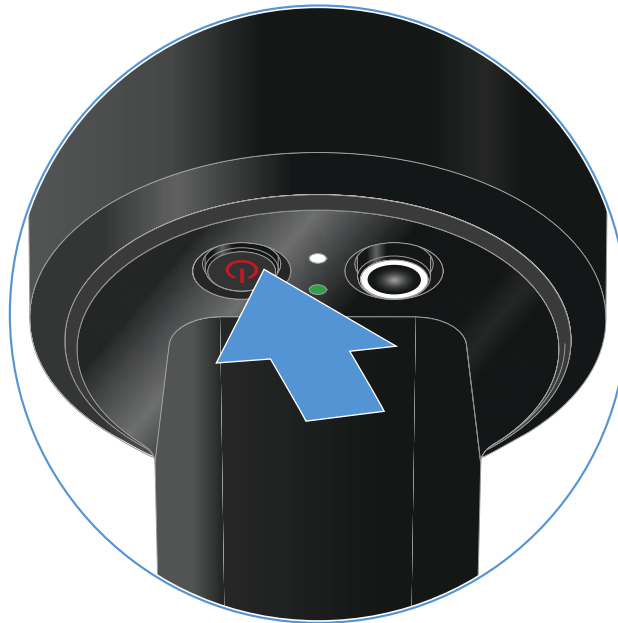

The display on the paired receiver starts flashing.

Pressing the transmitter's **ON/OFF** button will simultaneously trigger the Check function: „Checking the battery status of the transmitter (Check function)“.



Meaning of the LEDs

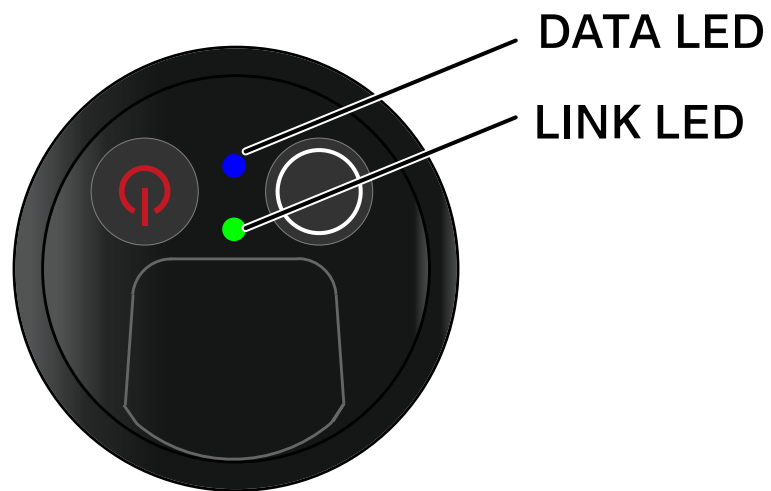

The **LINK** and **DATA** LEDs on the bottom of the transmitter can indicate the following information.

LINK LED

The **LINK** LED provides information about the status of the radio link between the transmitter and receiver, as well as status information for the transmitter.

The LED is green:

- ▷ The link between the transmitter and receiver is established.
- ▷ The audio signal is active.

The LED is yellow:

- ▷ The link between the transmitter and receiver is established.
 - ▷ The audio signal is muted.
 - or
 - ▷ No microphone module is mounted on the SKM-S handheld transmitter.
-



The LED is flashing yellow:

- ▷ The link between the transmitter and receiver is established.
 - ▷ The audio signal is overdriven (clipping).
-

The LED is continuously red:

- ▷ No link between the transmitter and receiver.
-

The LED is flashing red:

- ▷ The link between the transmitter and receiver is established.
 - ▷ The battery/rechargeable battery in the transmitter is low.
-

The LED is off:

- ▷ No link between the transmitter and receiver.
 - ▷ The transmitter is switched off.
-

DATA LED

The **DATA** LED provides information about the synchronization of transmitters and receivers.

The LED is flashing blue:

- ▷ The transmitter is being synchronized with a receiver.
-

The LED is continuously blue:

- ▷ The firmware is being updated.
-

The LED is off:

- ▷ There is currently no active data link.
-



Establishing a connection to the receiver

To establish a radio link between the transmitter and the receiver, the devices must be synchronized.

See „Establishing a radio link | Synchronizing the receiver and transmitter“.

Conditions and restrictions for using frequencies

There may be special conditions and restrictions for using frequencies in your country.

Before putting the product into operation, find the information for your country at the following address:

www.sennheiser.com/sifa

Muting the handheld transmitter

You can mute the audio signal using the mute switch.

- ▷ Slide the mute switch to the desired position to mute or activate the audio signal.

You can disable the mute switch by activating the **MUTE LOCK** option on the receiver (see „MUTE LOCK menu item“).



EW-D SK bodypack transmitter

Product overview

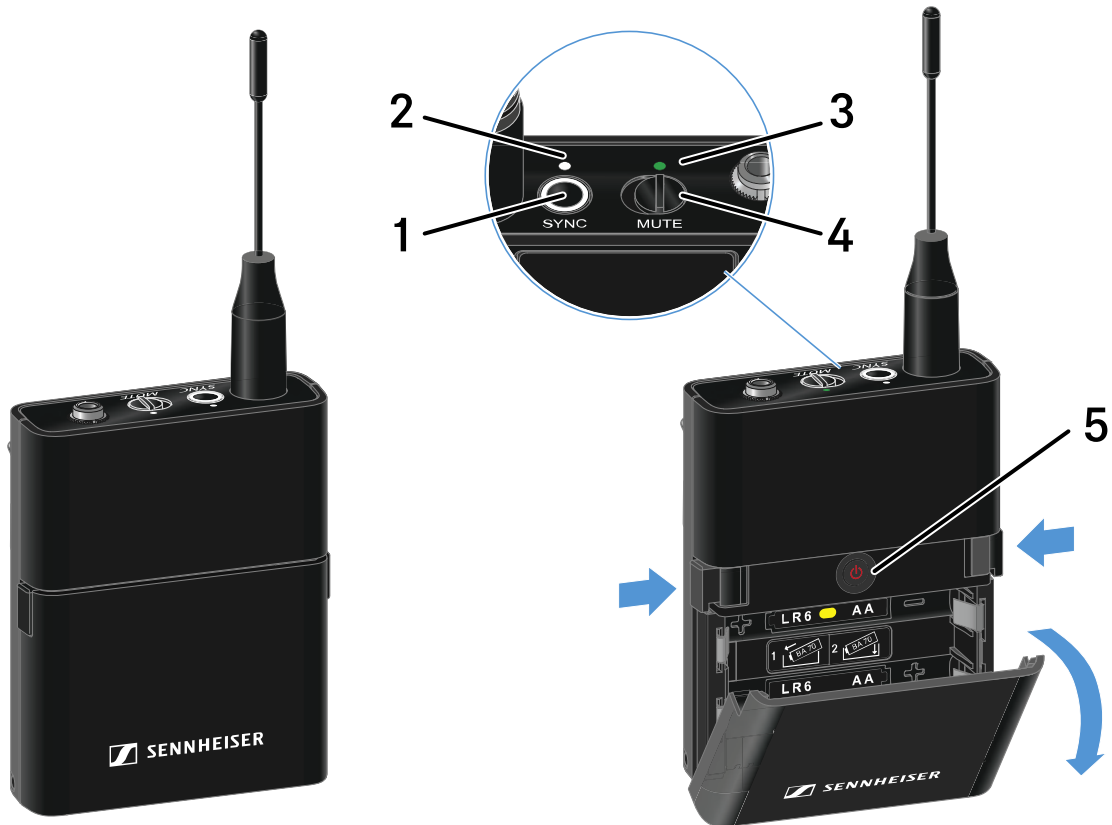

1 **SYNC** button

- See „Establishing a radio link | Synchronizing the receiver and transmitter“

2 **DATA** LED

- See „Meaning of the LEDs“

3 **LINK** LED

- See „Meaning of the LEDs“

4 Mute switch

- See „Muting the bodypack transmitter“

5 **ON/OFF** button

- See „Switching the bodypack transmitter on and off“



Inserting and removing the batteries/rechargeable batteries

You can operate the bodypack transmitter either with batteries (AA, 1.5 V) or with the rechargeable Sennheiser BA 70 battery.



- ▷ Press the two catches and open the battery compartment cover.
- ▷ Insert the batteries or the BA 70 rechargeable battery as indicated in the battery compartment. Observe correct polarity.
- ▷ Close the battery compartment.
The cover locks into place with an audible click.

Note about the BA 70 rechargeable battery

- ▷ Make sure that the **BA 70** rechargeable battery is inserted as follows:

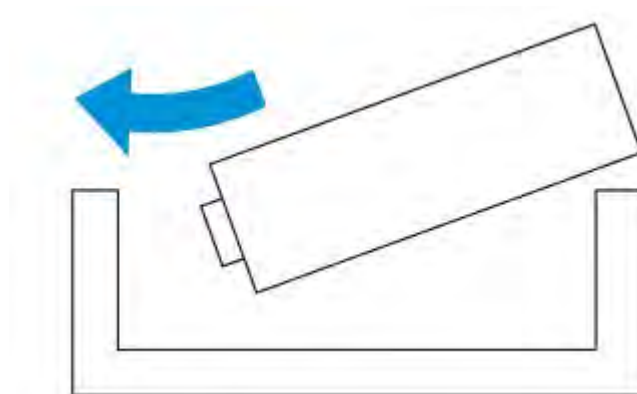



Connecting a microphone to the bodypack transmitter

To connect a microphone to the bodypack transmitter:

- ▷ Insert the cable's 3.5 mm jack plug into the socket on the bodypack transmitter as shown in the diagram.
- ▷ Screw the plug's coupling ring onto the audio socket thread of the bodypack transmitter.



Compatible microphones

The following microphones are compatible with the bodypack transmitter:

Lavalier microphones:

- **ME 2** | Lavalier microphone with omni-directional pattern (models from 2021 and later with gold-plated plug*)



- **ME 4** | Lavalier microphone with cardioid pattern (models from 2021 and later with gold-plated plug*)
- **MKE Essential Omni** | Lavalier microphone with omni-directional pattern
- **MKE 2 Gold** | Lavalier microphone with omni-directional pattern (models from 2018 and later with blue serial number label)
- **MKE 1** | Lavalier microphone with omni-directional pattern

Headset microphones:

- **ME 3** | Headset microphone with cardioid pattern (models from 2021 and later with gold-plated plug*)
- **HSP Essential Omni** | Headset microphone with omni-directional pattern
- **HSP 2** | Headset microphone with omni-directional pattern (models from March 2020 and later with code 1090 or higher)
- **HS 2** | Headset microphone with omni-directional pattern (models from 2021 and later with gold-plated plug*)
- **SL Headmic 1** | Headset microphone with omni-directional pattern

*Pre-2021 models with a nickel plug are not recommended. They can pick up noise if they are placed too close to the transmitter.



Connecting an instrument or line source to the bodypack transmitter

You can connect instruments or audio sources with a line level to the bodypack transmitter.

To do this, you will need the **CI 1** (6.3 mm jack plug on a lockable 3.5 mm jack plug) or **CL 2** (XLR-3F plug on a lockable 3.5 mm jack plug) Sennheiser cables.

To connect an instrument or line source to bodypack transmitter:

- ▷ Insert the cable's 3.5 mm jack plug into the socket on the bodypack transmitter as shown in the diagram.
- ▷ Screw the plug's coupling ring onto the audio socket thread of the bodypack transmitter.





Using EW-D Color Coding Sets to label transmission paths

You can use the **EW-D Color Coding Sets** (see „Color Coding Sets“) to identify which transmitters belong to which receivers. This makes it easier to match up the individual devices, especially in multi-channel systems.

You can also assign colors to the devices in the **EW-D Smart Assist** app.

Link 1:

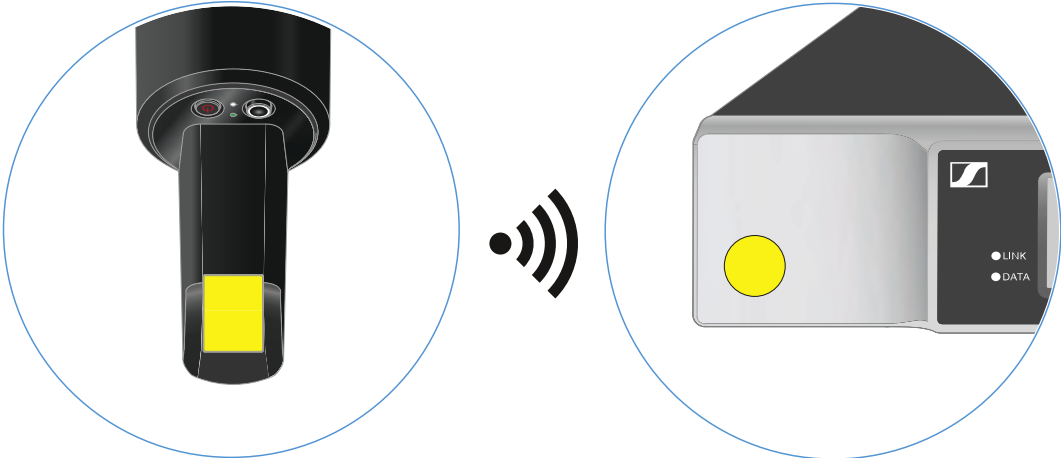

⋮

⋮

Link 2:

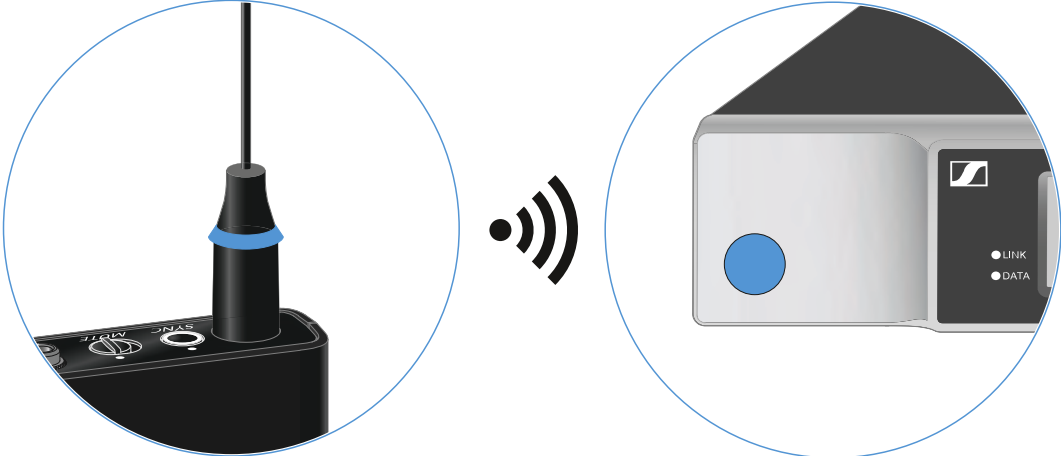

⋮

⋮

etc.

etc.



Changing the belt clip

You can change the belt clip on the bodypack transmitter or flip it over depending on how you want to wear it.

To remove the belt clip:

- ▷ Carefully loosen the belt clip with a small screwdriver as shown in the figure.
- ▷ Be very careful not to scratch the housing.

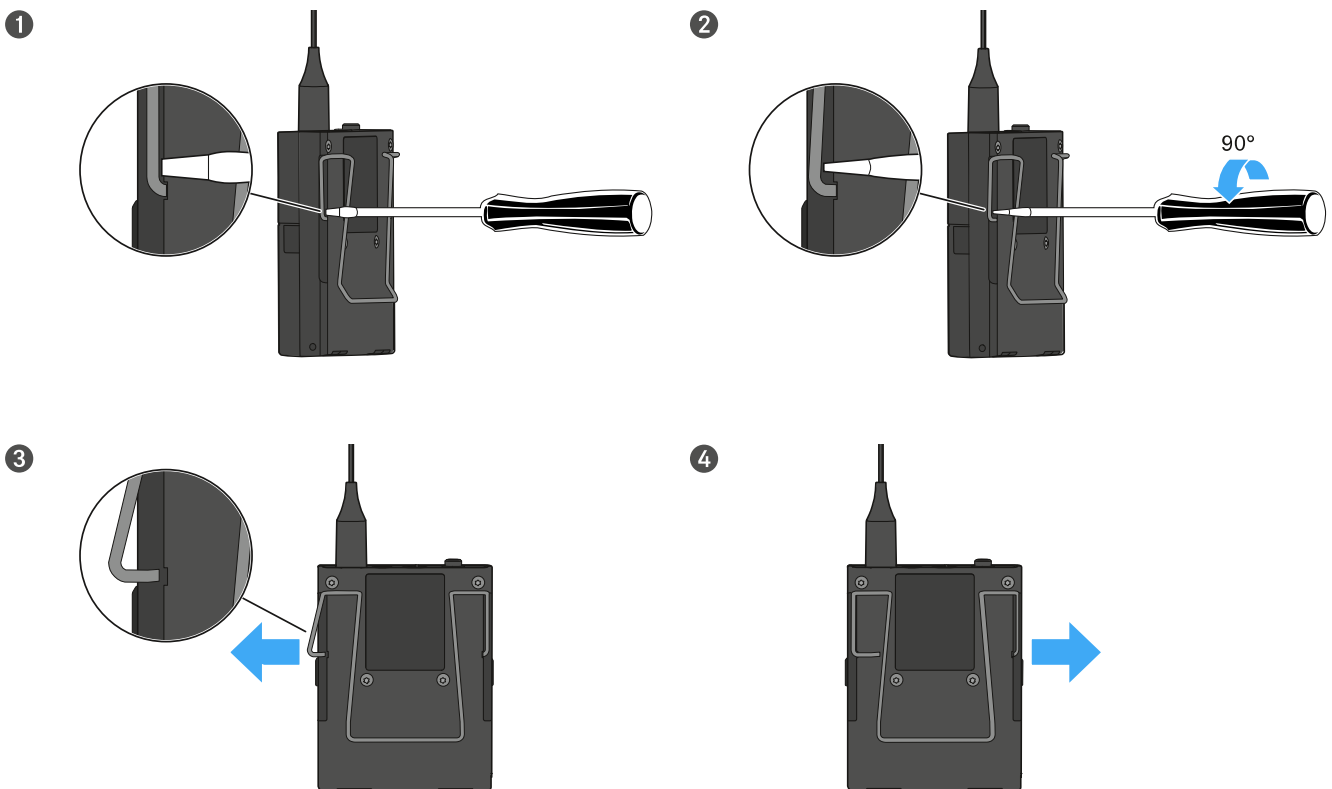



To insert the belt clip:

- ▷ Insert one side of the belt clip first as shown in the figure.
- ▷ Then insert the second side of the belt clip.
- ▷ Gently press the belt clip all the way in on both sides.
- ▷ Always insert one side before the other, not at the same time, as otherwise the belt clip could bend.

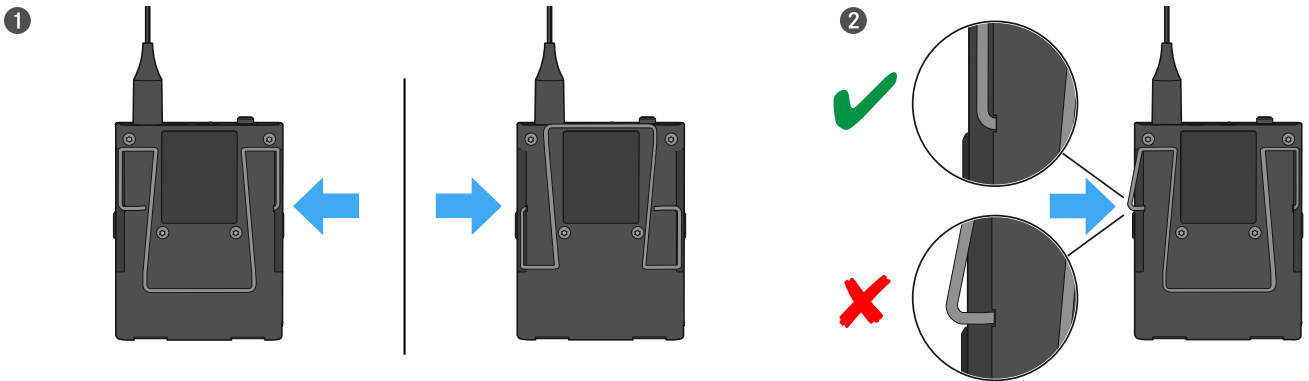



Switching the bodypack transmitter on and off

To switch the bodypack transmitter on:

- ▶ Short-press the **ON/OFF** button.
The **LINK** LED lights up and the transmitter switches on.

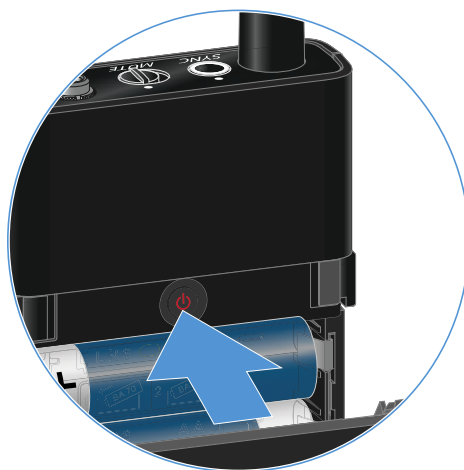

To switch the bodypack transmitter off:

- ▶ Hold down the **ON/OFF** button until the LEDs switch off.





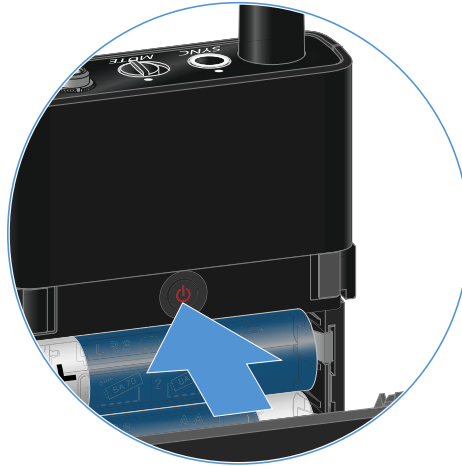

Checking the battery status of the transmitter (Check function)

To check the battery status of the transmitter:

- ▷ Short-press the **ON/OFF** button on the transmitter.



The transmitter's **LINK LED** flashes to indicate the current charge level of the battery or the BA 70 rechargeable battery.

LINK LED	
	≤ 100 %
	≤ 60 %
	≤ 20 %

Pressing the transmitter's **ON/OFF** button will simultaneously trigger the Identify function: „Identifying the paired receiver (Identify function)“.



Identifying the paired receiver (Identify function)

In multi-channel systems, you can use the **Check** function to quickly identify to which receiver the transmitter is paired.

Both the transmitter and receiver must be switched on.

- ▷ Short-press the **ON/OFF** button on the transmitter.

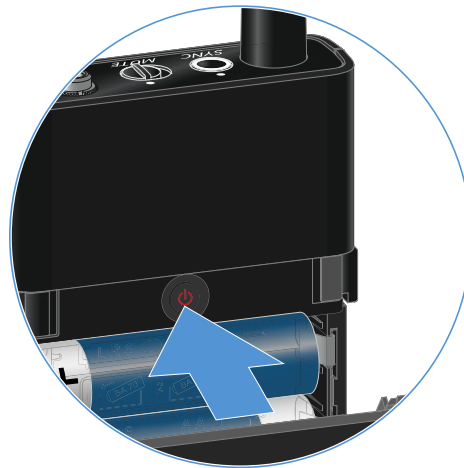

The display on the paired receiver starts flashing.

Pressing the transmitter's **ON/OFF** button will simultaneously trigger the Check function: „Checking the battery status of the transmitter (Check function)“.



Meaning of the LEDs

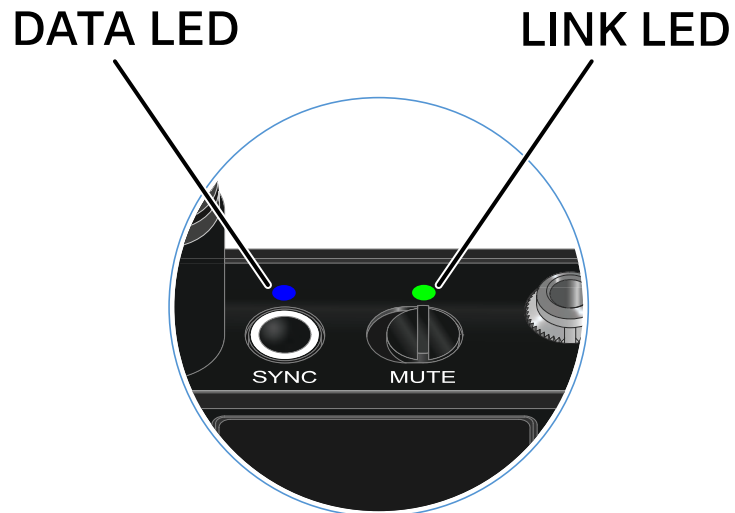

The **LINK** and **DATA** LEDs on the top of the transmitter can indicate the following information.

LINK LED

The **LINK** LED provides information about the status of the radio link between the transmitter and receiver, as well as status information for the transmitter.

The LED is green:

- ▷ The link between the transmitter and receiver is established.
- ▷ The audio signal is active.

The LED is yellow:

- ▷ The link between the transmitter and receiver is established.
- ▷ The audio signal is muted.

The LED is flashing yellow:

- ▷ The link between the transmitter and receiver is established.
- ▷ The audio signal is overdriven (clipping).



The LED is continuously red:

- ▷ No link between the transmitter and receiver.
-

The LED is flashing red:

- ▷ The link between the transmitter and receiver is established.
 - ▷ The battery/rechargeable battery in the transmitter is low.
-

The LED is off:

- ▷ No link between the transmitter and receiver.
 - ▷ The transmitter is switched off.
-

DATA LED

The **DATA** LED provides information about the synchronization of transmitters and receivers.

The LED is flashing blue:

- ▷ The transmitter is being synchronized with a receiver.
-

The LED is continuously blue:

- ▷ The firmware is being updated.
-

The LED is off:

- ▷ There is currently no active data link.
-



Establishing a connection to the receiver

To establish a radio link between the transmitter and the receiver, the devices must be synchronized.

See „Establishing a radio link | Synchronizing the receiver and transmitter“.

Conditions and restrictions for using frequencies

There may be special conditions and restrictions for using frequencies in your country.

Before putting the product into operation, find the information for your country at the following address:

www.sennheiser.com/sifa

Muting the bodypack transmitter

You can mute the audio signal using the mute switch.

- ▷ Slide the mute switch to the desired position to mute or activate the audio signal.

You can disable the mute switch by activating the **MUTE LOCK** option on the receiver (see „MUTE LOCK menu item“).



EW-DX EM 2 rack receiver

Connectors and controls

Front

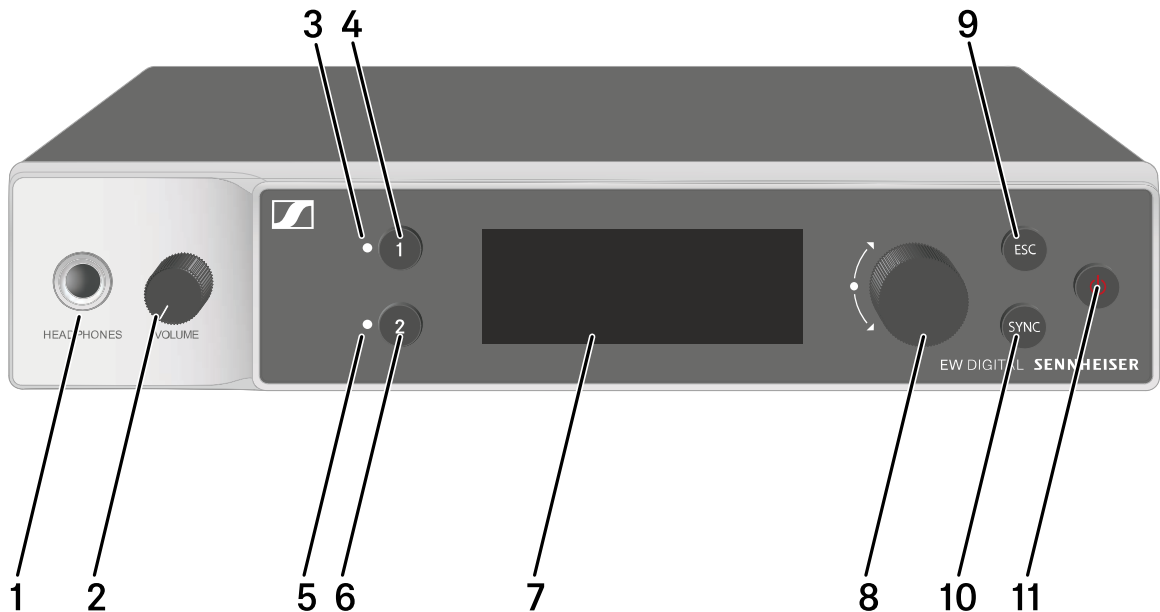

- 1 Headphone socket
 - See „Using the headphone output“
- 2 Volume control for the headphone socket
 - See „Using the headphone output“
- 3 **CH 1** LED to indicate the status of channel 1
 - See „Meaning of the LEDs“
- 4 **CH 1** button for selecting channel 1
 - See „Displays on the receiver’s display panel“
 - See „Buttons for navigating the menu“
- 5 **CH 2** LED to indicate the status of channel 1
 - See „Meaning of the LEDs“
- 6 **CH 2** button for selecting channel 1
 - See „Displays on the receiver’s display panel“
 - See „Buttons for navigating the menu“
- 7 Display for status information and operating menu
 - See „Displays on the receiver’s display panel“



- 8 **Jog dial (UP/DOWN/SET)** for navigating the operating menu
 - See „Buttons for navigating the menu“
- 9 **ESC** button for canceling an action in the menu
 - See „Buttons for navigating the menu“
- 10 **SYNC** button for synchronizing the transmitter and receiver
 - See „Establishing a radio link | Synchronizing the receiver and transmitter“
- 11 **ON/OFF** button for switching the device on and off
 - See „Switching the receiver on and off“

Back

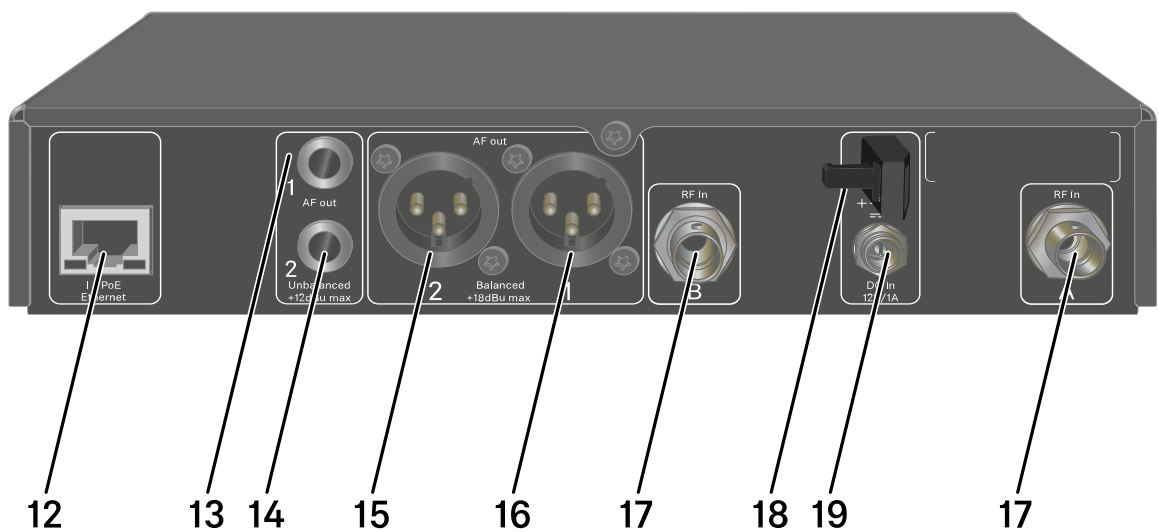

- 12 **PoE/Ethernet** RJ-45 socket for controlling the device over the network and for Power over Ethernet power supply
 - See „Connecting receivers in a network“
 - See „Connecting/disconnecting the receiver to/from the power supply system“
- 13 6.3 mm jack socket for **AF out Unbalanced** audio output for channel 1
 - See „Outputting audio signals“
- 14 6.3 mm jack socket for **AF out Unbalanced** audio output for channel 2
 - See „Outputting audio signals“



- 15 XLR-3 socket for **AF out Balanced** audio output for channel 2
 - See „Outputting audio signals“
- 16 XLR-3 socket for **AF out Balanced** audio output for channel 1
 - See „Outputting audio signals“
- 17 BNC sockets **ANT 1 RF in** and **ANT 2 RF in** for antenna inputs
 - See „Connecting antennas“
- 18 Strain relief for the connection cable of the power supply unit
 - See „Connecting/disconnecting the receiver to/from the power supply system“
- 19 **DC in** connection socket for the power supply unit
 - See „Connecting/disconnecting the receiver to/from the power supply system“



Connecting/disconnecting the receiver to/from the power supply system

You can operate the receiver using either the included power supply unit or with Power over Ethernet (PoE IEEE 802.3af Class 0). Please refer to the following information.

Power from the power supply unit

If using a power supply unit, use only the power supply unit included with the device. It is designed for your receiver and ensures safe operation.

You will find the power supply unit and the country adapters in the packaging under the tray.

To connect the receiver to the power supply system:

- ▷ Insert the plug of the power supply unit into the **DC in** socket on the receiver.
- ▷ Pass the cable of the power supply unit through the strain relief.
- ▷ Slide the supplied country adapter onto the power supply unit.
- ▷ Plug the power supply unit into the wall socket.

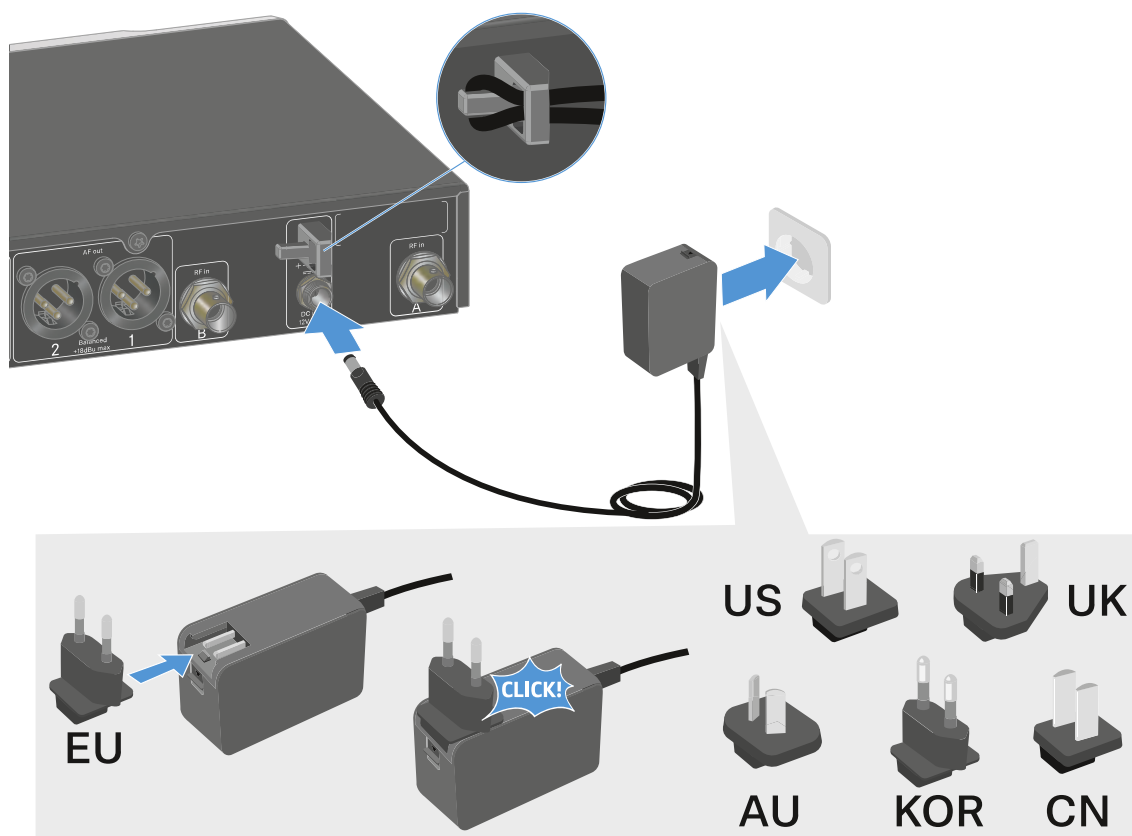



To completely disconnect the receiver from the power supply system:

- ▷ Unplug the power supply unit from the wall socket.
- ▷ Unplug the power supply unit from the **DC in** socket on the receiver.

Power over Ethernet (PoE)

The receiver can be powered via **Power over Ethernet** (PoE IEEE 802.3af Class 0).

- ▷ Connect the receiver to a **PoE-enabled** network switch.

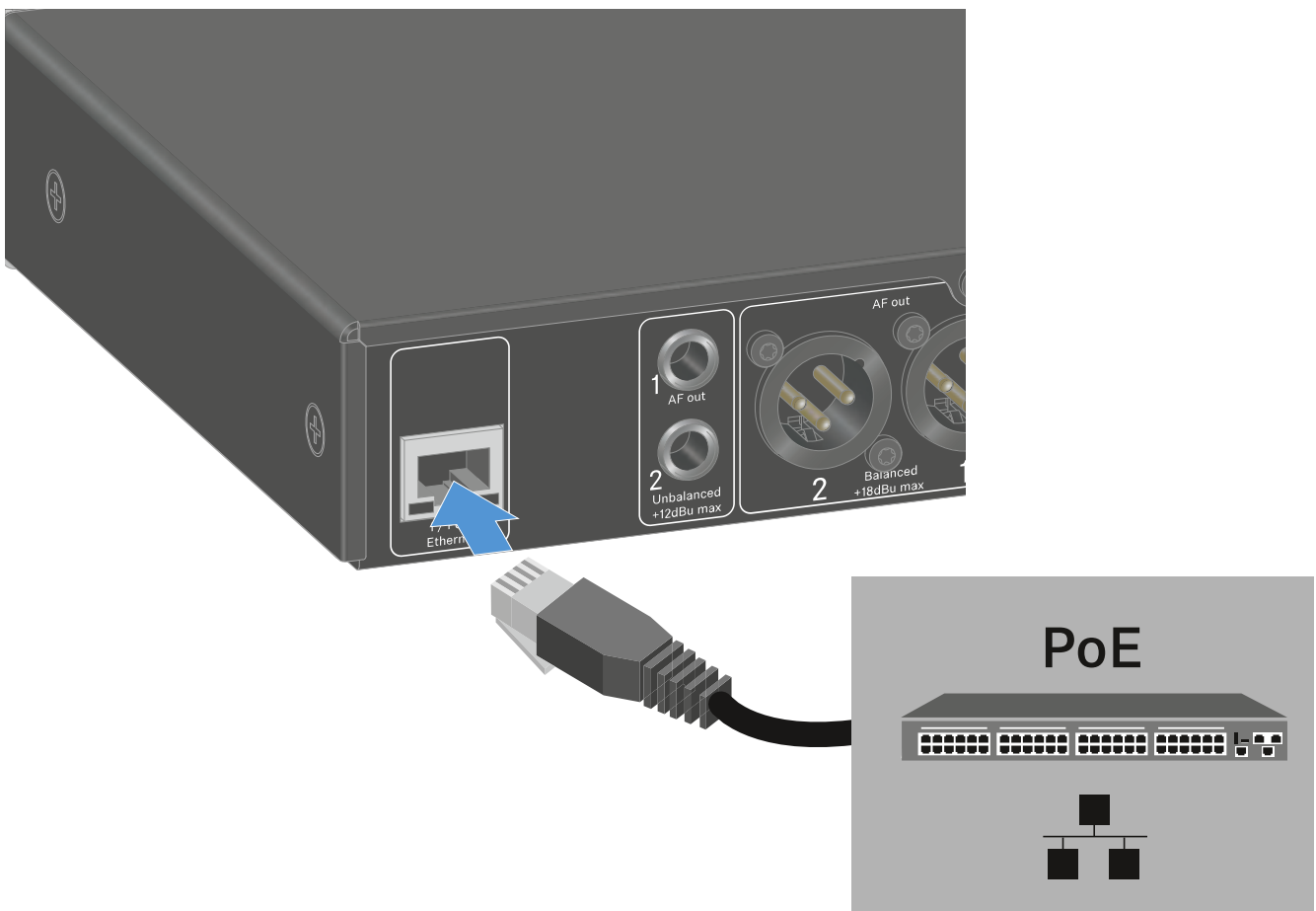



Connecting receivers in a network

You can monitor and control one or more receivers via a network connection using the **Sennheiser Wireless Systems Manager (WSM)** or **Sennheiser Control Cockpit (SCC)** software.

The network does not have to be a homogeneous network including only receivers. You can integrate the receiver into your existing network infrastructure with any other types of devices.

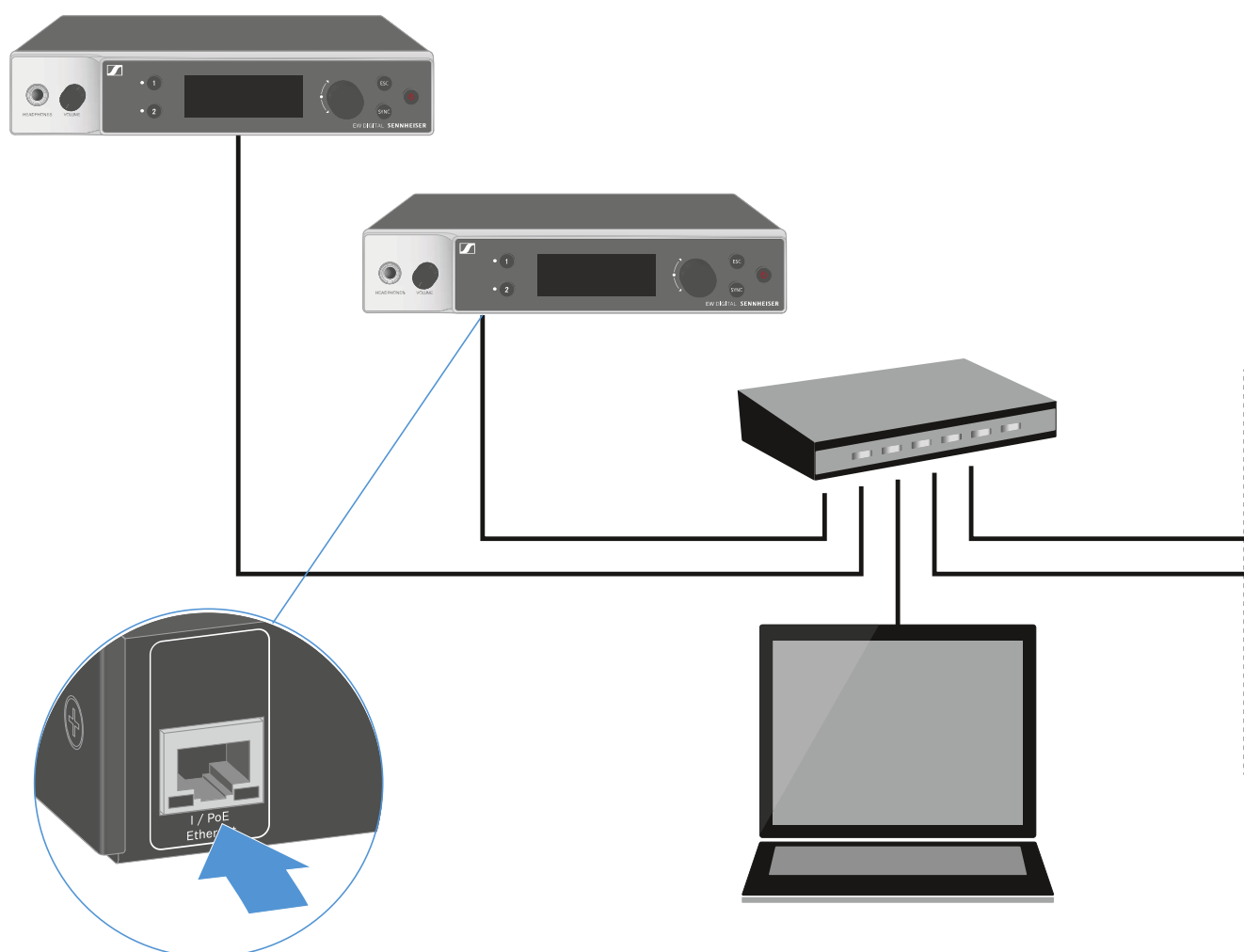

For more information about controlling devices via the Sennheiser Wireless Systems Manager or Sennheiser Control Cockpit software, refer to the instruction manual for the software. You can download the software here:
www.sennheiser.com/wsm
www.sennheiser.com/control-cockpit-software



Connecting antennas

Connecting rod antennas

To connect the supplied rod antennas:

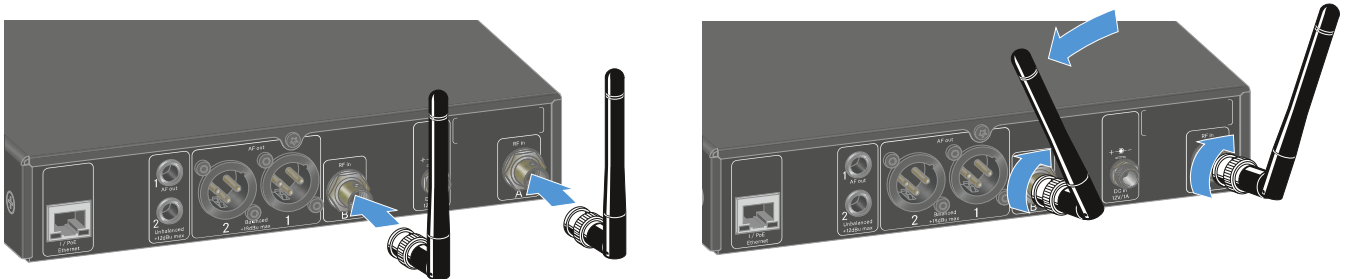

- ▷ Connect the antennas to the two antenna inputs on the receiver as shown in the figure.
- ▷ Slightly angle the antennas to the left and right as shown in the figure.

Connecting remote antennas

To connect remote antennas:

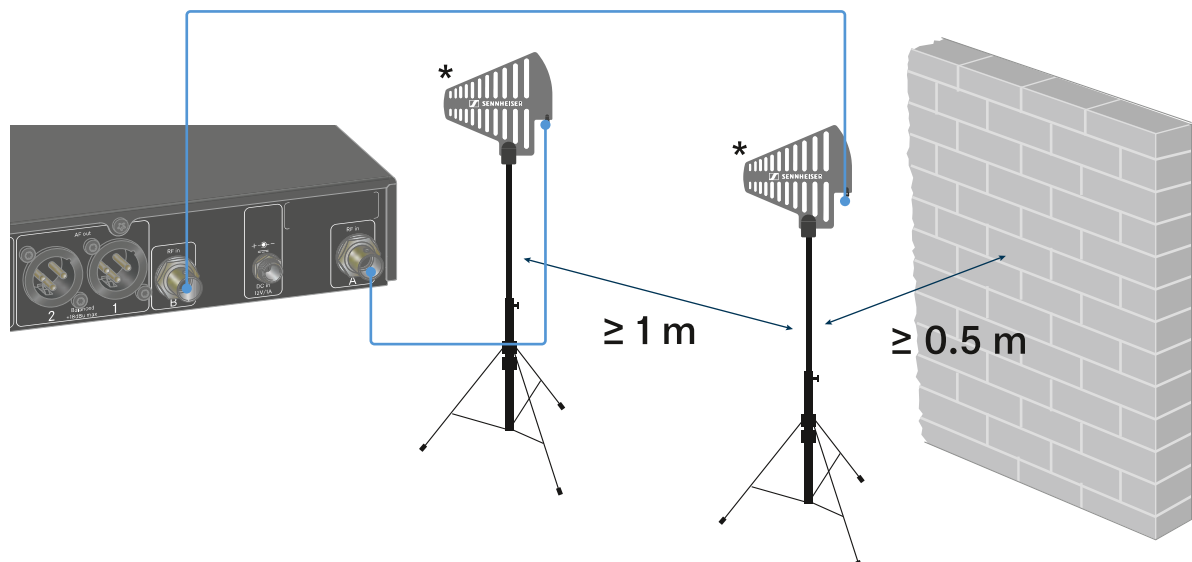

- ▷ Connect the antennas to the two antenna inputs on the receiver as shown in the figure.
- ▷ Observe the specified minimum spacing.

*Recommended antennas:

- **ADP UHF** | 470 – 1075 MHz
- **AD 1800** | 1400 – 2400 MHz

If you are using more than one receiver, we recommend using remote antennas and possibly the EW-D ASA antenna splitter („EW-D ASA antenna splitter“).



Outputting audio signals

Each of the two channels on the EW-DX EM 2 has both a balanced XLR-3M output socket and an unbalanced 6.3 mm (1/4") jack output socket.

- ▷ Always use only one of the two output sockets for each channel.

To connect an XLR cable:

- ▷ Plug the XLR cable into the **AF out Balanced** socket for the respective channel on the EW-DX EM 2.

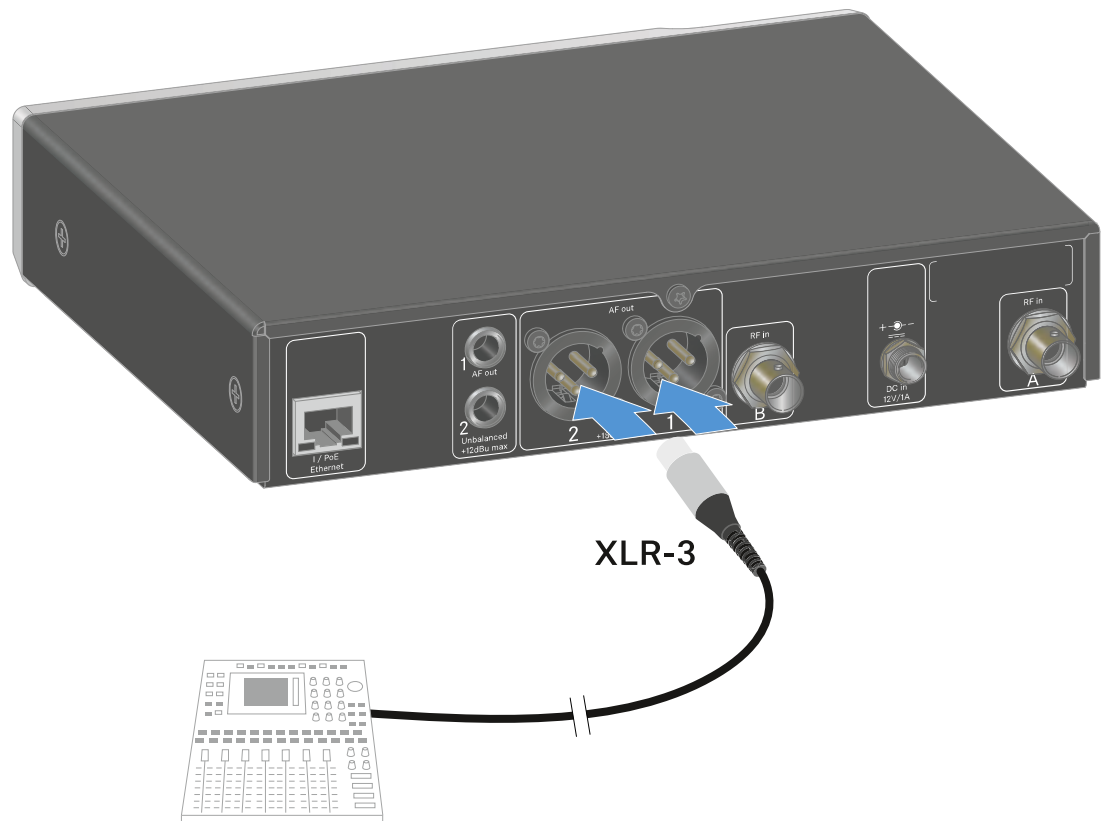



To connect a jack cable:

- ▶ Plug the jack cable into the **AF out Unbalanced** socket for the respective channel on the EW-DX EM 2.

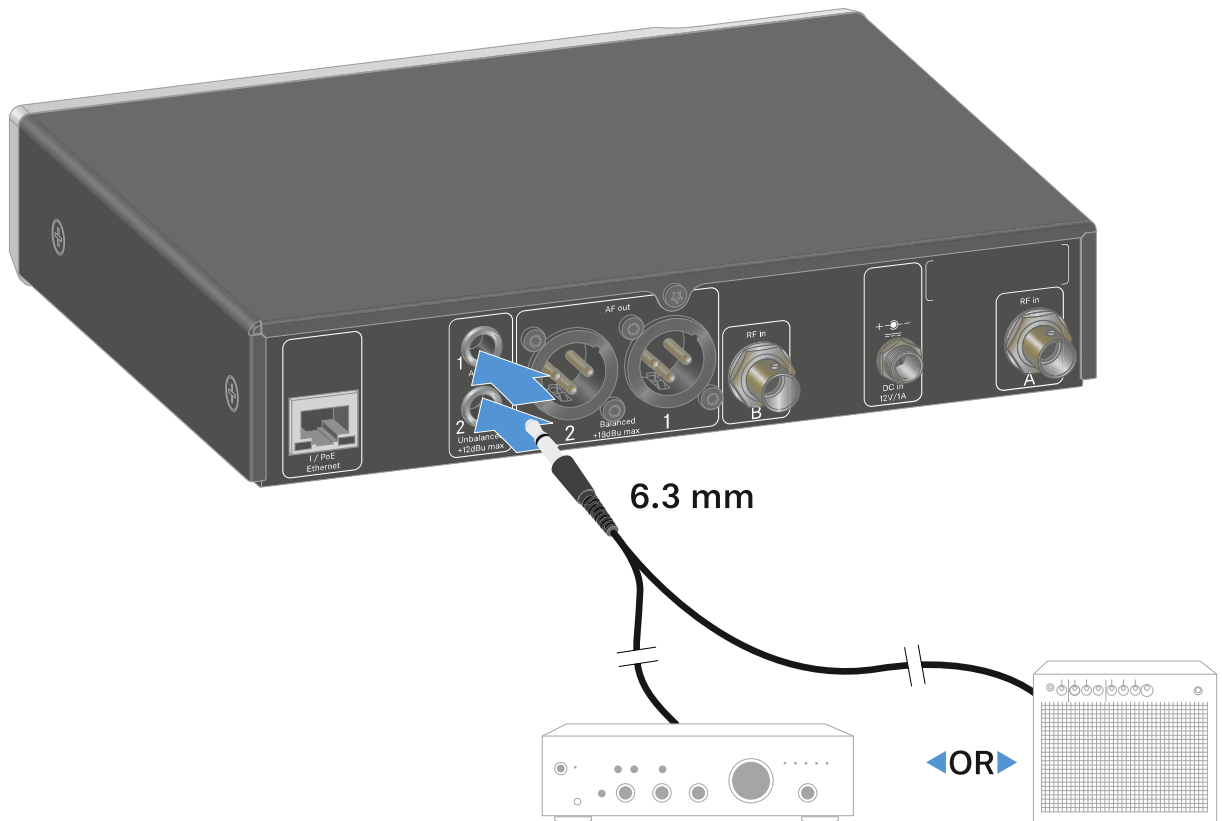



Installing receivers in a rack

Observe the following instructions when mounting the receiver in a rack.

The mounting brackets for installing the receiver in the rack can be found in the packaging under the tray.

CAUTION!

Rack mounting poses risks

When installing the device in a closed 19" rack or multi-rack assembly, please consider that, during operation, the ambient temperature, the mechanical load and the electrical potentials will be different from those of devices which are not mounted into a rack.

- ▷ Make sure that the ambient temperature within the rack does not exceed the permissible temperature limit stated in the specifications. See „SPECIFICATIONS“.
- ▷ Ensure sufficient ventilation; if necessary, provide additional ventilation.
- ▷ Make sure that the mechanical load of the rack is even.
- ▷ When connecting to the power supply system, observe the information indicated on the type plate. Avoid overloading the circuits. If necessary, provide overcurrent protection.
- ▷ When mounting in a rack, please note that intrinsically harmless leakage currents of the individual power supply units may accumulate, thereby exceeding the permissible limit value. As a remedy, ground the rack via an additional ground connection.



Mounting a single receiver in a rack

- ▷ Connect the mounting brackets to the sides of the receiver as shown.

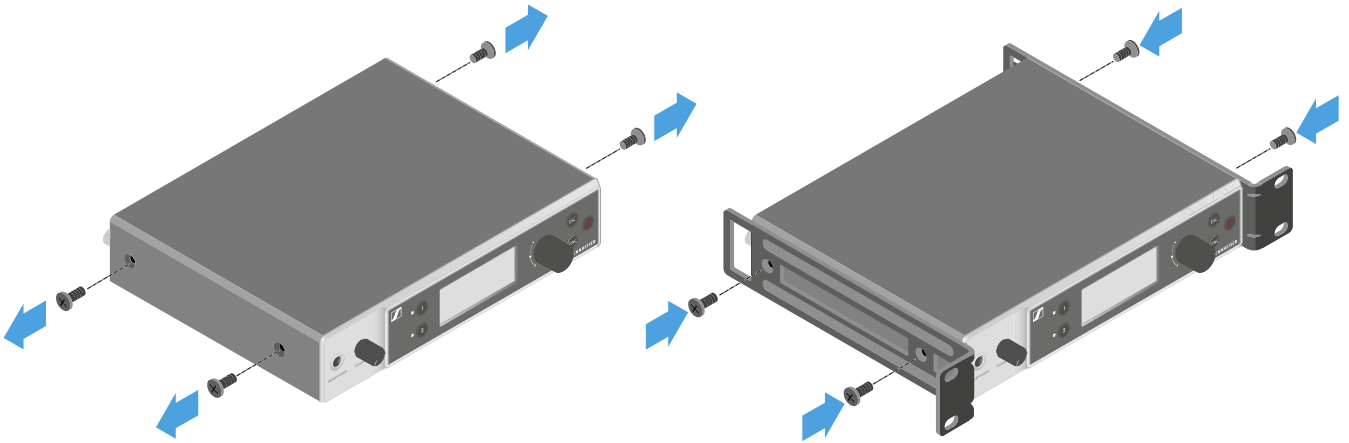

- ▷ Attach the front panel as shown.
- ▷ If desired, attach the antennas to the front panel as shown. This requires the optional AM 2 antenna front mount kit (see „Accessories for rack mounting“).

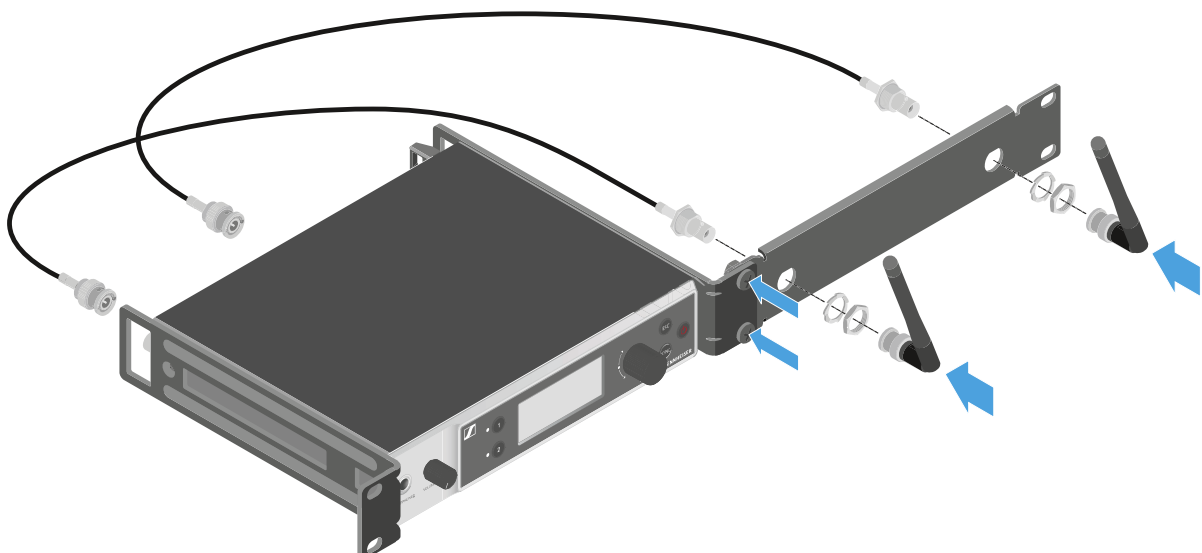



Mounting two receivers side by side in a rack

- ▷ Place both receivers upside down and side by side on an even surface.
- ▷ Tighten the jointing plate as shown.
- ▷ Attach the mounting brackets as shown.

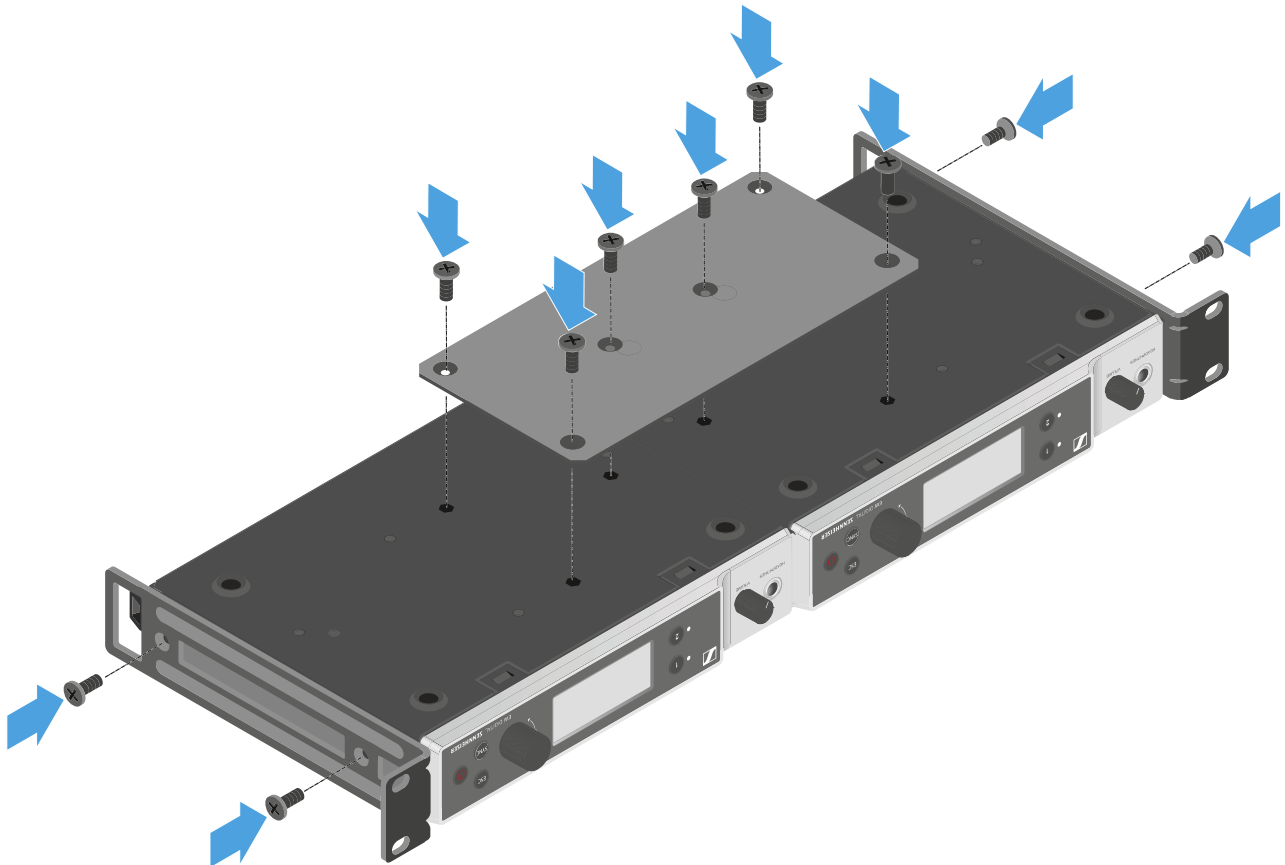



Switching the receiver on and off

To switch the receiver **on**:

- ▷ Short-press the **ON/OFF** button.
The receiver switches on.

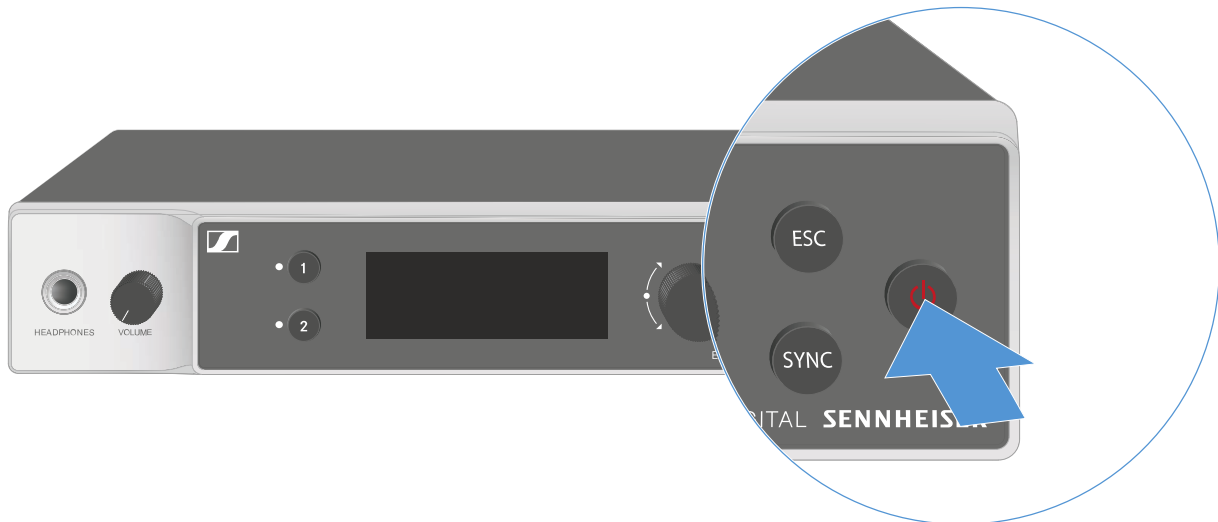

To switch the receiver to **standby mode**:

- ▷ Hold down the **ON/OFF** button until the display switches off.

To **switch the receiver off completely**:

- ▷ Disconnect the receiver from the power supply system by unplugging the power supply unit from the wall socket or disconnecting the PoE connection.



Using the headphone output

You can use the headphone output on the front of the receiver (6.3 mm jack) to listen to the audio signals of the two channels.

CAUTION

Danger due to high volume levels

Volume levels that are too high may damage your hearing.

- ▷ Turn down the volume of the headphone output before you put on the headphone.
-

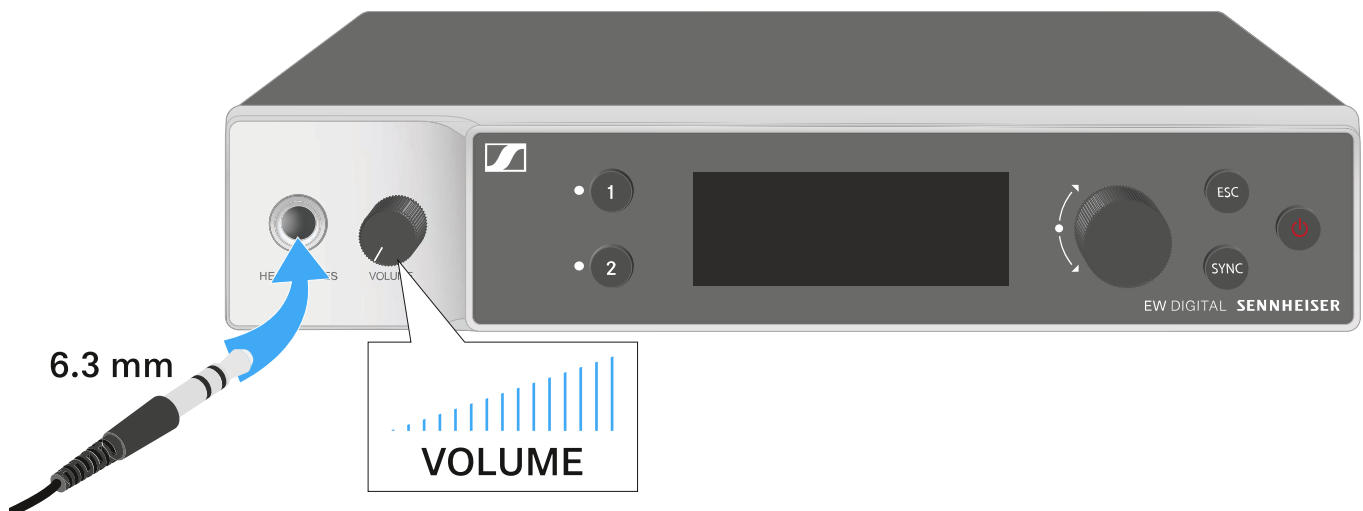

- ▷ Connect the headphone to the headphone output.
- ▷ Press the **CH 1** or **CH 2** button to listen to the audio signal from channel 1 or channel 2.
The headphone icon on the display indicates which channel is currently active on the headphone output.
By default, the signal from channel 1 is active on the headphone output.
- ▷ You can control the volume by turning the volume knob next to the headphone output.



Meaning of the LEDs

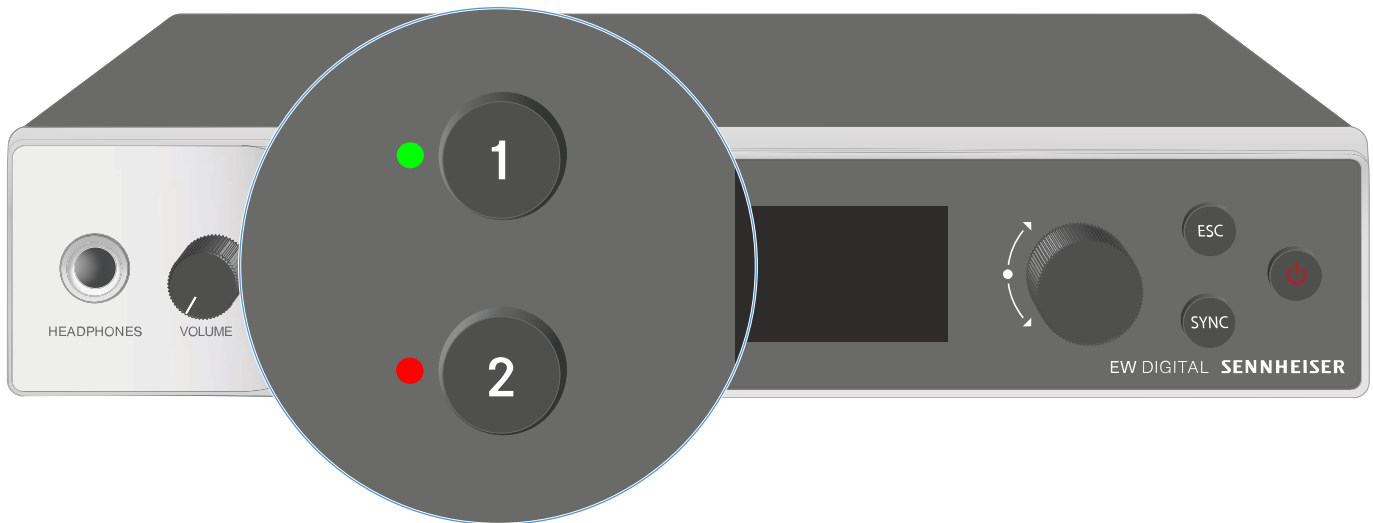

The two LEDs on the front of the receiver indicate the following information for channel 1 and channel 2.

The LED is green:

- ▷ The link between the transmitter and receiving channel is established.
- ▷ The audio signal is active.

The LED is yellow:

- ▷ The link between the transmitter and receiving channel is established.
- ▷ The audio signal is muted.
- or
- ▷ No microphone module is mounted on the handheld transmitter.

The LED is flashing yellow:

- ▷ The link between the transmitter and receiving channel is established.
 - ▷ The audio signal is overdriven (clipping).
-



The LED is continuously red:

- ▷ No link between the transmitter and receiving channel.
-

The LED is flashing red:

- ▷ The link between the transmitter and receiving channel is established.
 - ▷ The battery/rechargeable battery in the paired transmitter is low.
-

The LED is flashing blue:

- ▷ The **Bluetooth Low Energy** link is being established between the receiver and a smartphone or tablet with the **EW-D Smart Assist** app.
or
 - ▷ The receiving channel is being synchronized with a transmitter.
-

The LED is continuously blue:

- ▷ The firmware is being updated.
-



Displays on the receiver's display panel

Status information such as frequency, reception quality, battery status and audio level is shown on the display.

The display also shows the operating menu, which you can use to configure all of the settings (see „Buttons for navigating the menu“).

Home screen

The home screen is the default view on the display. The following information for both receiving channels is displayed here.

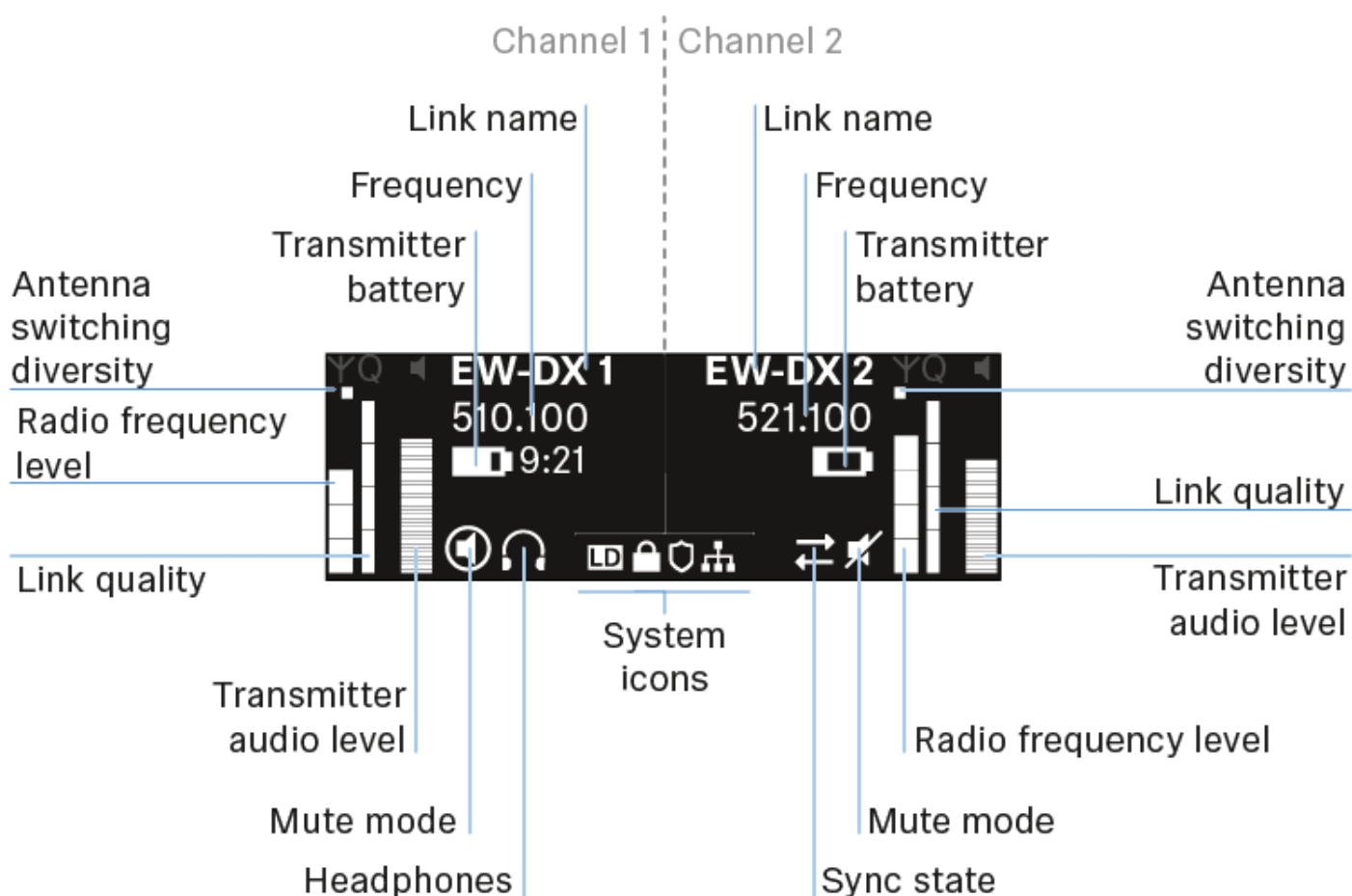

Further information

Antenna switching diversity:

Indicates which of the two antennas is currently active (left or right).



Radio frequency level:

Displays the RF signal strength for the respective channel.

Link quality:

Displays the transmission quality for the respective channel.

On the one hand, the transmission quality depends on the field strength (RF level indicator on the display). However, on the other hand, it also depends on external sources of interference that cannot be identified on the RF level indicator (for example, they may be on the same frequency or a very close neighboring frequency or may not affect the field strength).

As a basic principle, a value significantly higher than 50 % should be achieved for a secure transmission.

Link name:

You can assign a name to the radio link in the receiver menu (see „Ch 1 / Ch 2 -> Name menu item“).

Frequency:

You can set the frequency of the radio link manually or using the Auto-Setup function.

- See „Ch 1 / Ch 2 -> Frequency menu item“
 - See „Ch 1 / Ch 2 -> Scan / Auto Setup menu item“
-

Transmitter audio level:

Displays the audio input level for the respective channel (see „Ch 1 / Ch 2 -> Gain menu item“).

This level is separate from the audio level that is output from the receiver (see „Ch 1 / Ch 2 -> AF Out menu item“).

Transmitter battery:

Indicates the charging status of the transmitter's BA 70 rechargeable battery or batteries.



When using the BA 70 rechargeable battery, the remaining runtime is also displayed in hours and minutes.

Mute mode:



The mute switch is deactivated on the received transmitter.



The mute switch on the received transmitter is set to **AF Mute** and the audio signal is muted.

- ▷ **EW-DX SKM-S:** „Configuring mute mode and muting the handheld transmitter (EW-DX SKM-S only)“
 - ▷ **EW-DX SK:** „Configuring mute mode and muting the bodypack transmitter“
-

Headphones:



The headphones icon indicates which channel is currently active on the headphone output (see „Using the headphone output“).

Sync state

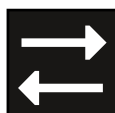

This icon indicates that different values are set for the receiving channel of the receiver and the transmitter. These values can be synchronized (see „Connecting to the EW-DX EM 2 receiver / synchronizing the EW-DX EM 2“).

System icons:



The LD icon is displayed when Link Density mode is activated. See „System -> Link Density menu item“.



The network icon appears when a network connection is successfully established. See „Connecting receivers in a network“.



The shield icon is displayed when AES 256 encryption is enabled. See „System -> Encryption menu item“.



Home screens 2 and 3

- ▷ Turn the **jog dial** on the home screen to the right.
The second home screen appears with network information for the device.
- ▷ Turn the **jog dial** to the right again.
The third home screen appears with information about the software and hardware.

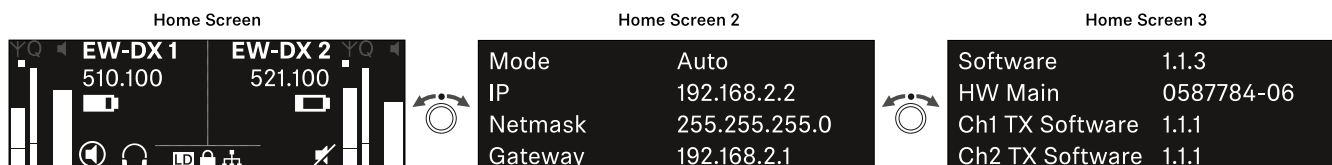

Channel 1

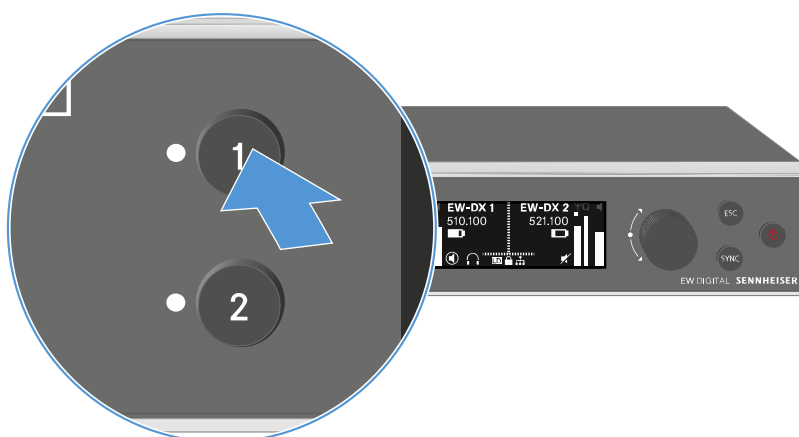

- ▷ On the receiver's home screen, press the **CH 1** button.
The home screen for channel 1 appears.

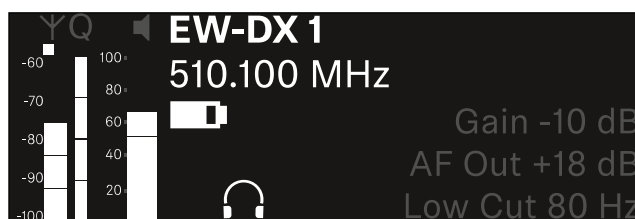

In addition to the status information displayed on the home screen, information about the channel's audio settings is also displayed.

- ▷ Turn the **jog dial** to the right to view more information about the received transmitter.

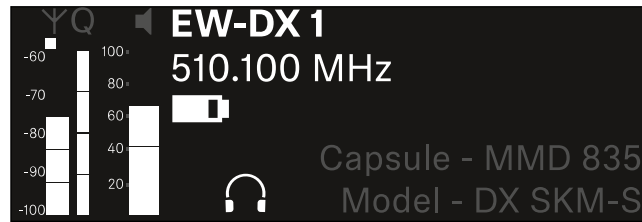

- ▷ Turn the **jog dial** further to the right to mute or unmute the channel's audio signal.

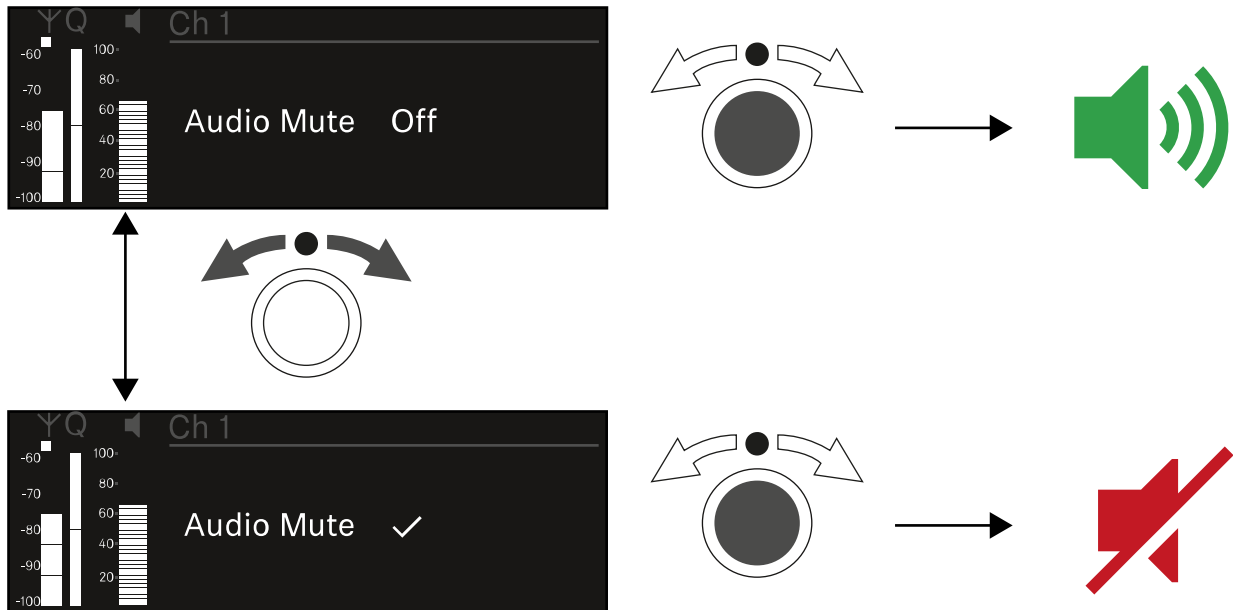

- ▷ Press the **jog dial** to confirm your selection.

Channel 2

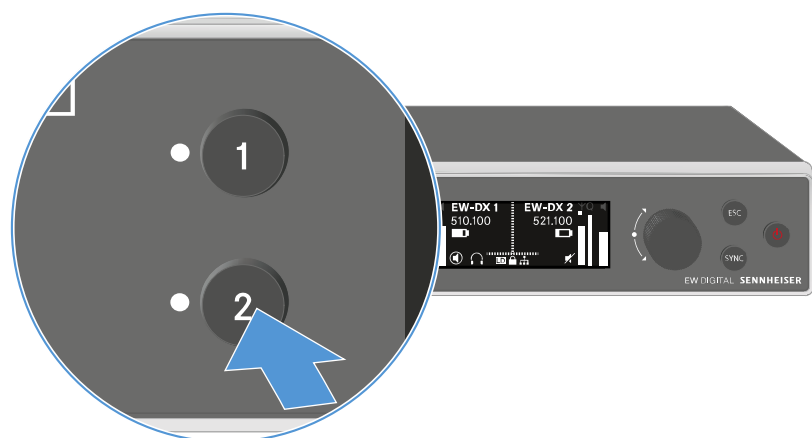

- ▷ On the receiver's home screen, press the **CH 2** button. The home screen for channel 2 appears.

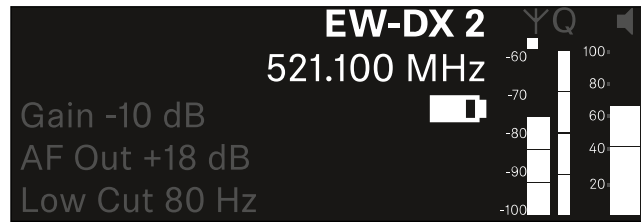

You can view and configure the same information as for channel 1.



Buttons for navigating the menu

Use the following buttons to navigate through the receiver's operating menu.

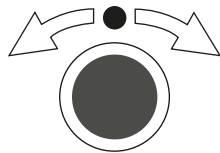
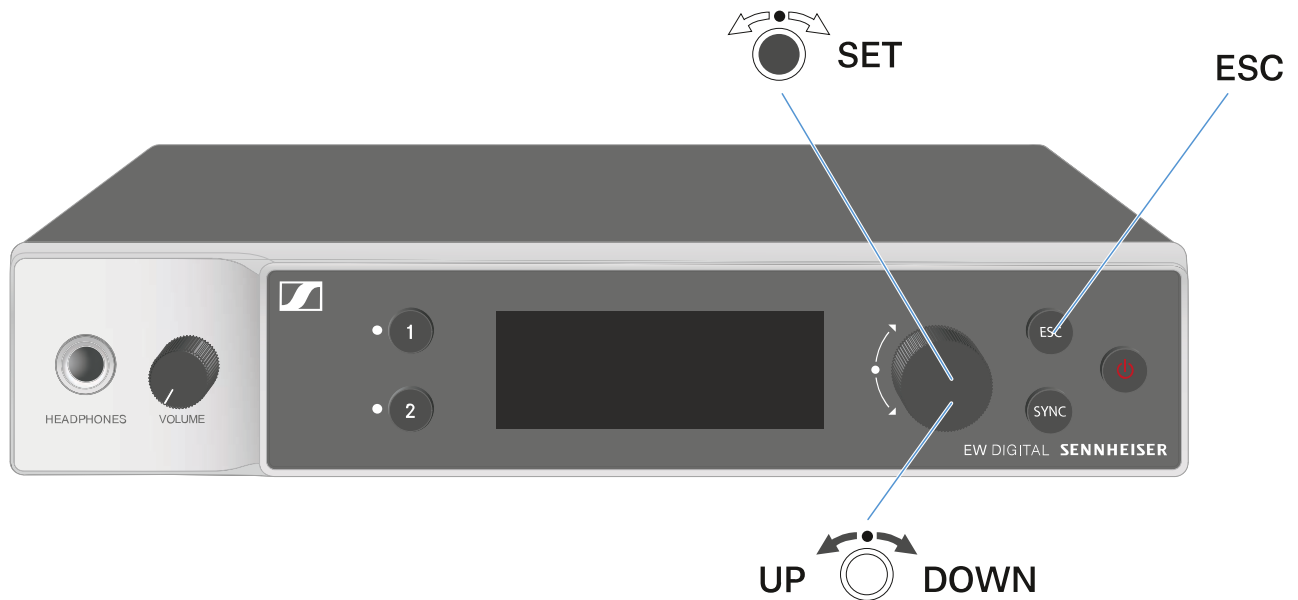

Press the **jog dial**

- Jumps from the home screen to the operating menu
- Calls up a menu item
- Changes to a submenu
- Saves settings

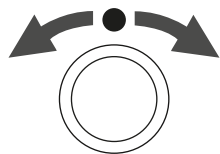

Turn the **jog dial**

- Selects a standard display (see „Displays on the receiver's display panel“)
- Changes to the previous or next menu item
- Changes the setting of a menu item



Press the **ESC** button

- Cancels the entry and returns to the previous display

Opening the menu and navigating the menu items

To open the menu:

- ▷ Press the **jog dial** when you are on the **home screen**.

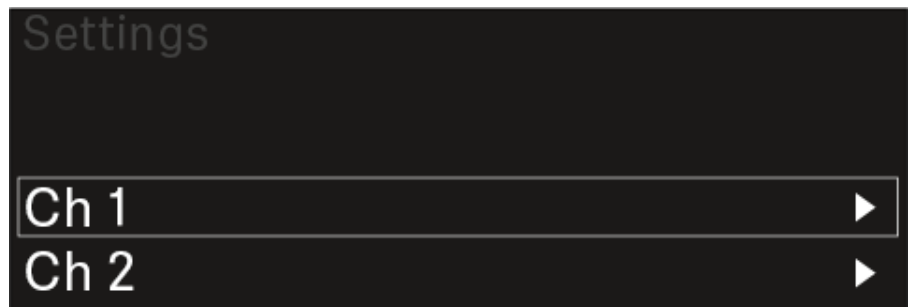

- ▷ Turn the **jog dial** to navigate to your desired menu item.
- ▷ Press the **jog dial** to open the selected menu item.

To exit the menu:

- ▷ Press the **ESC** button to exit the menu and return to the **home screen**.

Changes that were not previously saved by pressing the **jog dial** will be lost.



Menu structure

The figure shows the complete menu structure in an overview.

Version: firmware 1.1.3

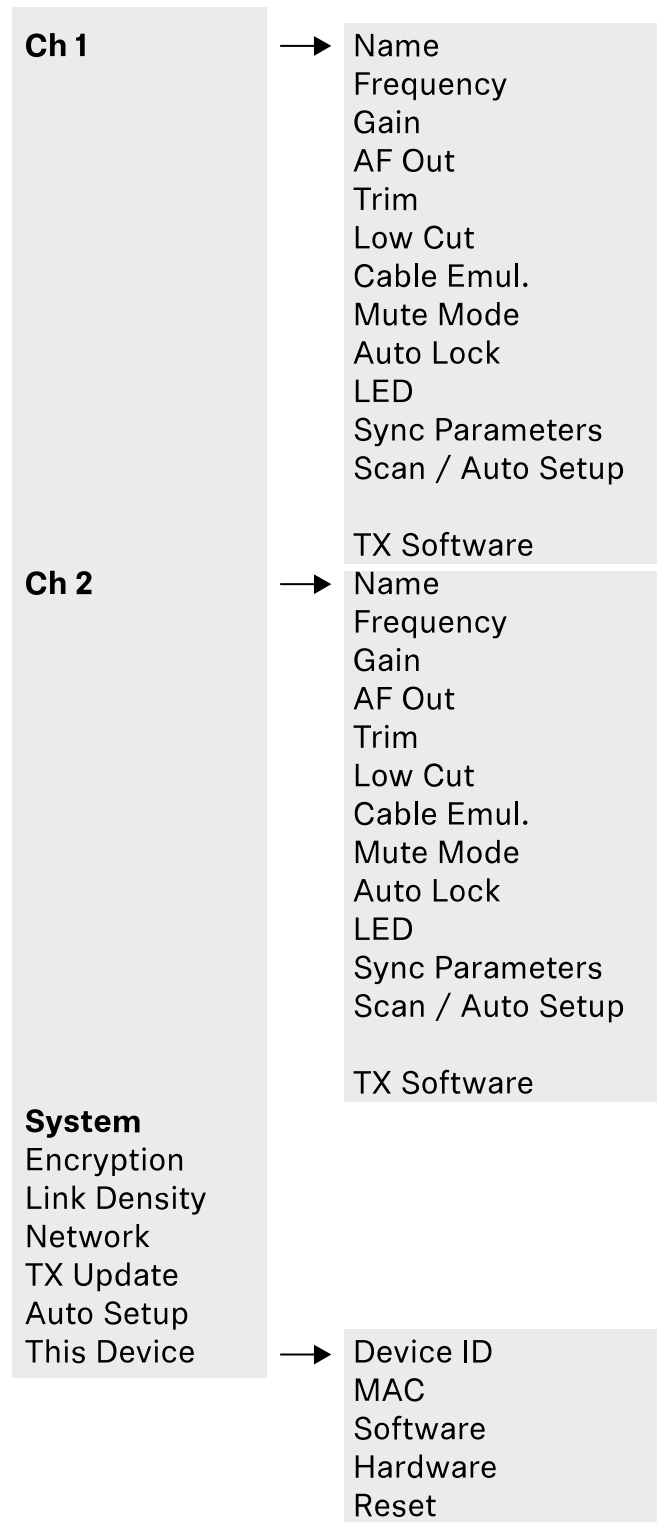



Setting options in the menu

In the receiver menu, you can configure the following settings.

Changing the name of the radio link

- ▷ „Ch 1 / Ch 2 -> Name menu item“
-

Adjusting frequencies

- ▷ „Ch 1 / Ch 2 -> Frequency menu item“
-

Adjusting the gain of the wireless link

- ▷ „Ch 1 / Ch 2 -> Gain menu item“
-

Setting the output level of the audio signal

- ▷ „Ch 1 / Ch 2 -> AF Out menu item“
-

Adjusting the trim of the connected transmitter

- ▷ „Ch 1 / Ch 2 -> Trim menu item“
-

Adjusting the low-cut filter

- ▷ „Ch 1 / Ch 2 -> Low Cut menu item“
-

Configuring cable emulation for the bodypack transmitter

- ▷ „Ch 1 / Ch 2 -> Cable Emul. menu item“
-

Setting the function of the transmitter's mute switch

- ▷ „Ch 1 / Ch 2 -> Mute Mode menu item“
-



Enabling the transmitter's automatic lock-off function

- ▷ „Ch 1 / Ch 2 -> Auto Lock menu item“
-

Configuring the behavior of the transmitter's LEDs

- ▷ „Ch 1 / Ch 2 -> LED menu item“
-

Activating/deactivating the parameters to be synchronized on the transmitters

- ▷ „Ch 1 / Ch 2 -> Sync Parameters menu item“
-

Performing a frequency scan and automatic frequency set-up

- ▷ „Ch 1 / Ch 2 -> Scan / Auto Setup menu item“
-

Viewing the software version of the connected transmitters

- ▷ „Ch 1 / Ch 2 -> TX Software menu item“
-

Configuring different system settings

- Enabling AES 256 encryption
 - Setting transmission mode
 - Configuring network settings
 - Updating the firmware for the transmitters
 - Activating the Auto Setup function
 - Changing device names
 - ▷ „System menu item“
-

You can find an overview of the entire menu structure under „Menu structure“.



Ch 1 / Ch 2 -> Name menu item

In the **Name** menu item, you can define the name of the link for the channel in question.

This name is the name of the radio link between the transmitter and receiving channel. You can set the name of the receiver as it will appear in a network from the **This Device** menu in the system menu. See „System -> This Device menu item“.

To open the **Name** menu item:

- ▷ In the menu, navigate to the **Name** menu item for the desired channel.

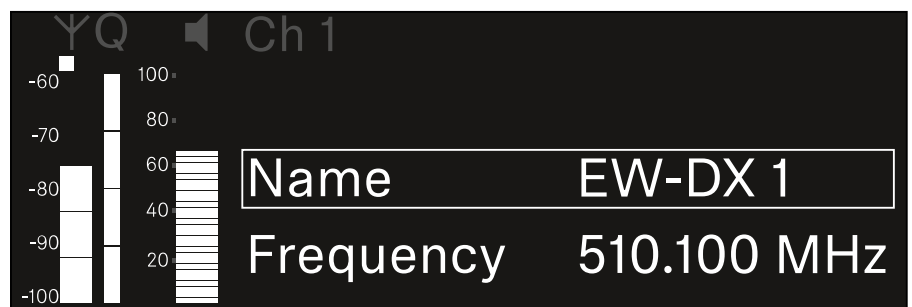

- ▷ Press the **jog dial** to open the menu.
The following view is displayed:

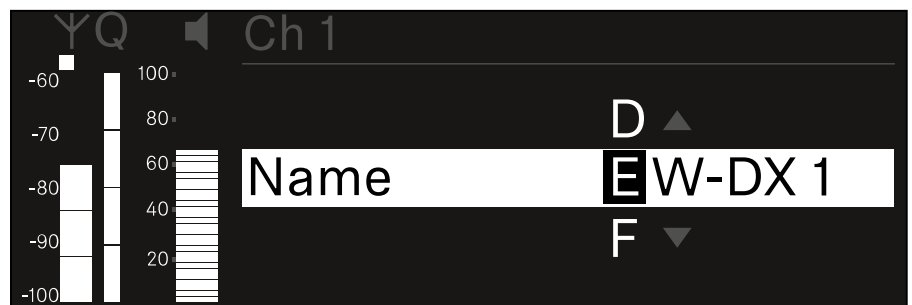

To enter the desired link name:

- ▷ Turn the **jog dial** to select the desired character.
- ▷ Press the **jog dial** to go to the next position.
- ▷ At the last position, press the **jog dial** to save the selected name.
- or
- ▷ Press the **ESC** button to cancel the entry without saving the setting.

For the chosen link name to appear on the display of the received transmitter, you must synchronize the channel („Connecting to the EW-DX EM 2 receiver / synchronizing the EW-DX EM 2“).



Ch 1 / Ch 2 -> Frequency menu item

In the **Frequency** menu item, you can adjust the frequency for the channel in question.

You can select a frequency from the predefined list or set the frequency manually.

To open the **Frequency** menu item:

- ▷ In the menu, navigate to the **Frequency** menu item for the desired channel.

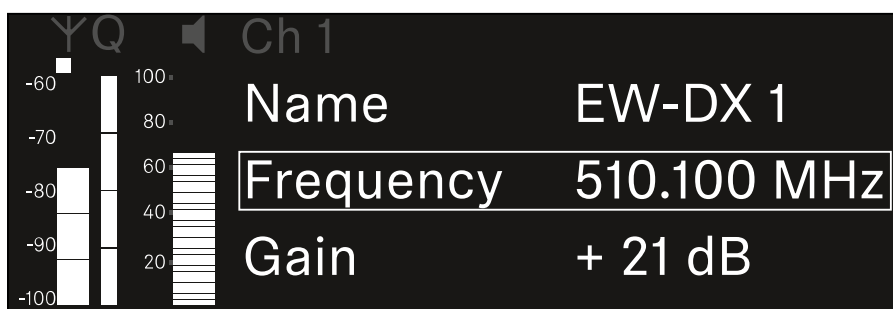

- ▷ Press the **jog dial** to open the menu.
The following view is displayed:

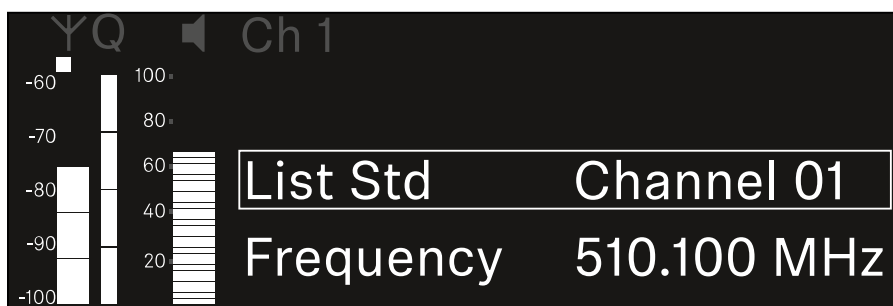

- ▷ Rotate the **jog dial** to select between the **List** and **Frequency** subitems.
The **List** subitem allows you to select a frequency from the predefined list.
The **Frequency** subitem lets you set the desired frequency manually.



Selecting a frequency from a predefined list

To select a frequency from a predefined list:

- ▷ Open the **List** subitem.

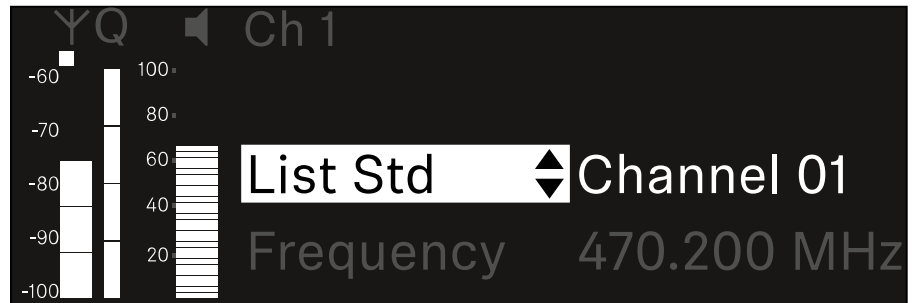

- ▷ Rotate the **jog dial** to choose between the predefined list (**List Std**) and the user-defined list (**List Usr**).

You can create a custom list using the **Wireless Systems Manager (WSM)** software and upload it to the receiver. For more information on the **WSM** software, see: www.sennheiser.com/wsm

- ▷ Press the **jog dial** to confirm your selection.

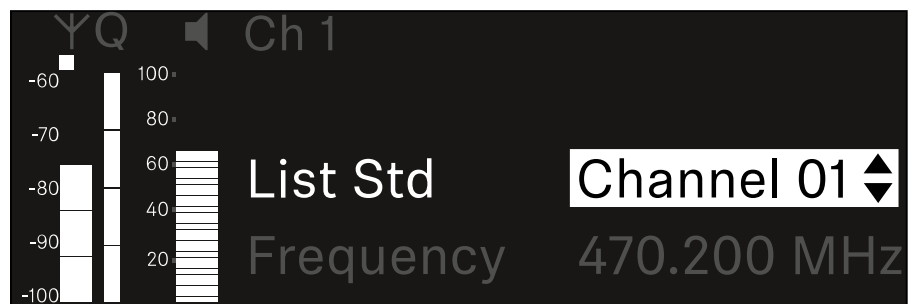

- ▷ Rotate the **jog dial** to select the desired channel from the list.
The frequency assigned to the channel is displayed.
- ▷ Press the **jog dial** to save the selected channel.
or
- ▷ Press the **ESC** button to cancel the entry without saving the setting.



Setting the frequency manually

To set the frequency manually:

- ▷ Open the **Frequency** subitem.

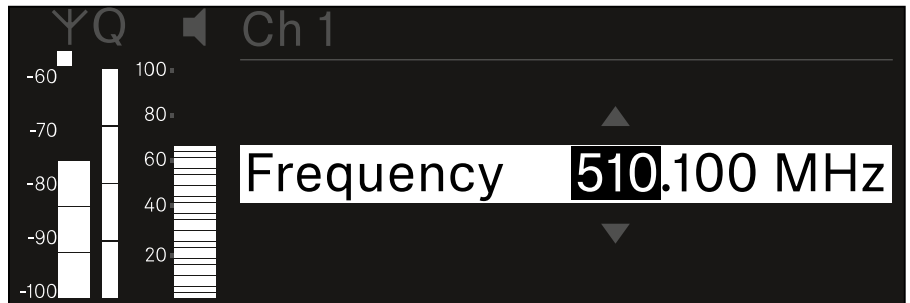

- ▷ Turn the **jog dial** to set the MHz range for the frequency.
- ▷ Press the **jog dial** to confirm your selection.

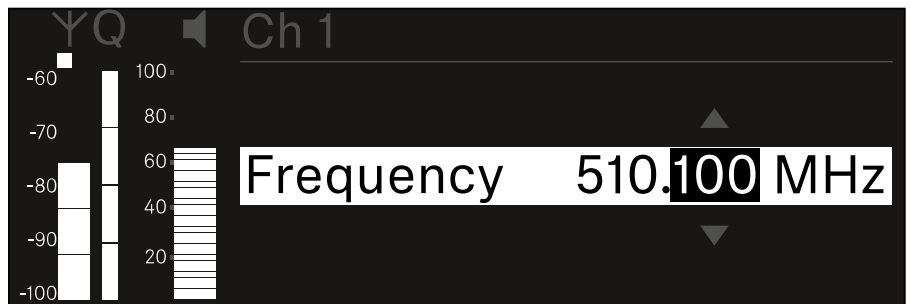

- ▷ Turn the **jog dial** to set the kHz range for the frequency.
- ▷ Press the **jog dial** to save your selected frequency.
- or
- ▷ Press the **ESC** button to cancel the entry without saving the setting.



Ch 1 / Ch 2 -> Gain menu item

Under the **Gain** menu item, you can set the audio level of the audio signal coming from the received transmitter (e.g. vocals or speech via EW-DX SKM or guitar via EW-DX SK).

- Setting range: **3 dB** to **+42 dB** in increments of 3 dB

To open the **Gain** menu item:

- ▷ In the menu, navigate to the **Gain** menu item for the desired channel.

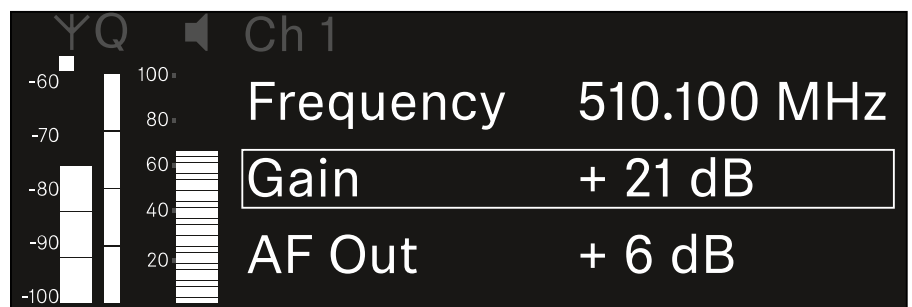

- ▷ Press the **jog dial** to open the menu.
The following view is displayed:

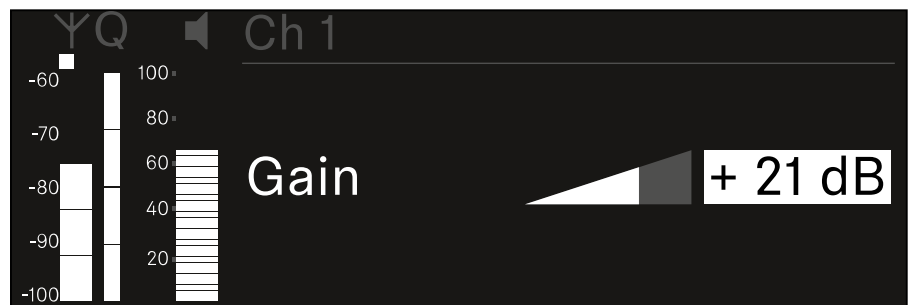

- ▷ Turn the **jog dial** to set the desired value.
- ▷ Press the **jog dial** to save your setting.
or
- ▷ Press the **ESC** button to cancel the entry without saving the setting.



Ch 1 / Ch 2 -> AF Out menu item

In the **AF Out** menu item, you can set the audio level that is output via the audio outputs of the particular receiving channel.

To open the **AF Out** menu item:

- ▷ In the menu, navigate to the **AF Out** menu item for the desired channel.



- ▷ Press the **jog dial** to open the menu.
The following view is displayed:

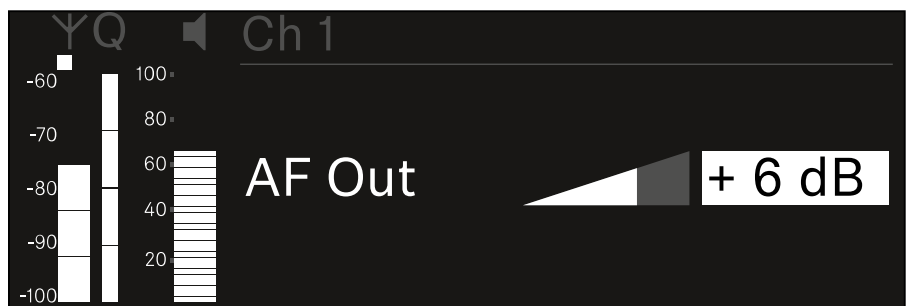

- ▷ Turn the **jog dial** to set the desired value.
- ▷ Press the **jog dial** to save your setting.
or
- ▷ Press the **ESC** button to cancel the entry without saving the setting.



Ch 1 / Ch 2 -> Trim menu item

In the **Trim** menu item, you can adjust the audio level of the received transmitter to input signals of different volumes.

For example, if you are using multiple transmitters in alternation for a single receiving channel, you can adjust the transmitters to the different input signals using the trim setting. You do not need to change the channel's gain setting.

- Setting range: **-12 dB** to **+6 dB** in increments of 1 dB

To open the **Trim** menu item:

- ▷ In the menu, navigate to the **Trim** menu item for the desired channel.



- ▷ Press the **jog dial** to open the menu.
The following view is displayed:

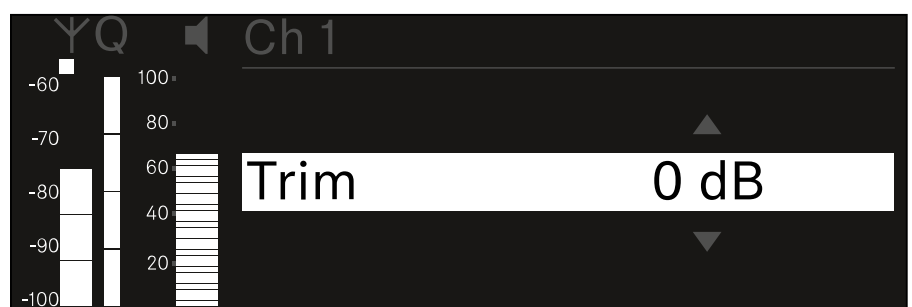

- ▷ Turn the **jog dial** to set the desired value.
- ▷ Press the **jog dial** to save your setting.
or
- ▷ Press the **ESC** button to cancel the entry without saving the setting.

For the set value to be applied to the received transmitter, you must synchronize the channel („Connecting to the EW-DX EM 2 receiver / synchronizing the EW-DX EM 2“).



Ch 1 / Ch 2 -> Low Cut menu item

In the **Low Cut** menu item, you can set the value of the low cut filter for the respective channel.

- Setting range:
 - for **EW-DX SK | EW-DX SK 3-PIN**: Off, 30 Hz, 60 Hz, 80 Hz, 100 Hz, 120 Hz
 - for **EW-DX SKM | EW-DX SKM-S**: 60 Hz, 80 Hz, 100 Hz, 120 Hz

To open the **Low Cut** menu item:

- ▷ In the menu, navigate to the **Low Cut** menu item for the desired channel.

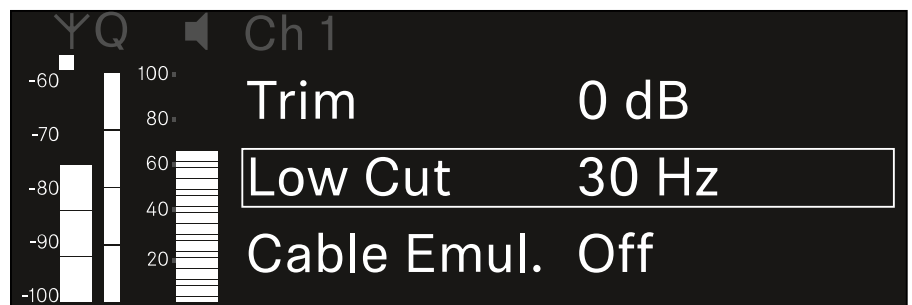

- ▷ Press the **jog dial** to open the menu.
The following view is displayed:

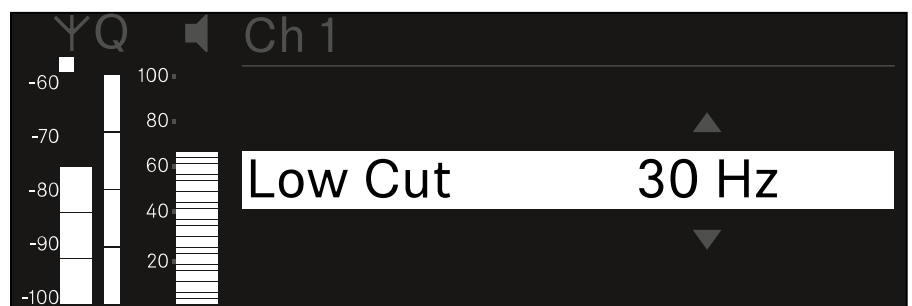

- ▷ Turn the **jog dial** to set the desired value.
- ▷ Press the **jog dial** to save your setting.
or
- ▷ Press the **ESC** button to cancel the entry without saving the setting.

For the set value to be applied to the received transmitter, you must synchronize the channel („Connecting to the EW-DX EM 2 receiver / synchronizing the EW-DX EM 2“).



Ch 1 / Ch 2 -> Cable Emul. menu item

In the **Cable Emul.** menu item, you can emulate instrument cable lengths:

- Setting range: Off, Type 1, Type 2, Type 3

To open the **Cable Emul.** menu item:

- ▷ In the menu, navigate to the **Cable Emul.** menu item for the desired channel.

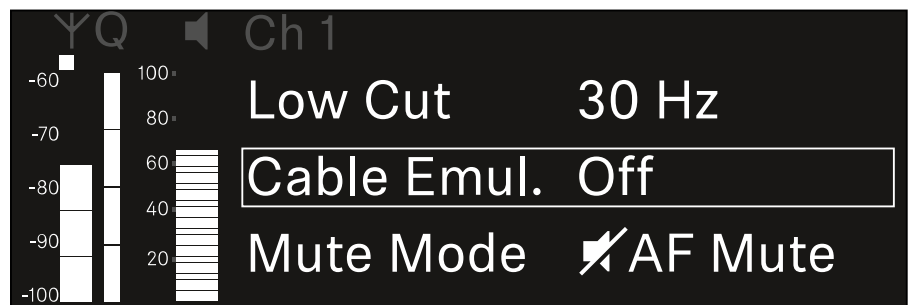

- ▷ Press the **jog dial** to open the menu.
The following view is displayed:

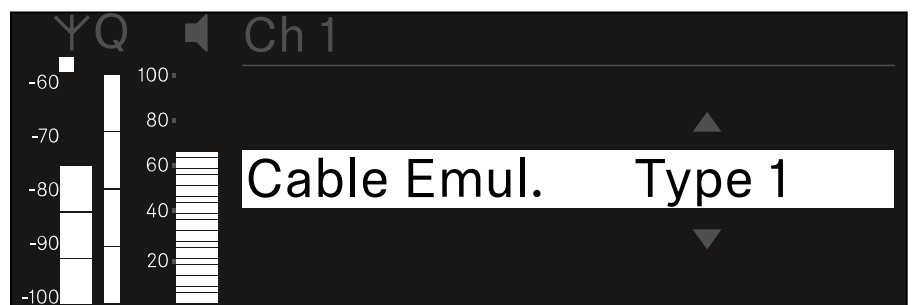

- ▷ Turn the **jog dial** to set the desired value.
- ▷ Press the **jog dial** to save your setting.
or
- ▷ Press the **ESC** button to cancel the entry without saving the setting.



Ch 1 / Ch 2 -> Mute Mode menu item

In the **Mute Mode** menu item, you can set the function of the mute switch on the connected transmitter (EW-DX SK, EW-DX SK 3-PIN, EW-DX SKM-S).

- Setting range:
 - **Disabled:** The mute switch has no function.
 - **RF Mute:** The RF signal is deactivated when the mute switch is on.
 - **AF Mute:** The audio signal is muted when the mute switch is on.

To open the **Mute Mode** menu item:

- ▷ In the menu, navigate to the **Mute Mode** menu item for the desired channel.

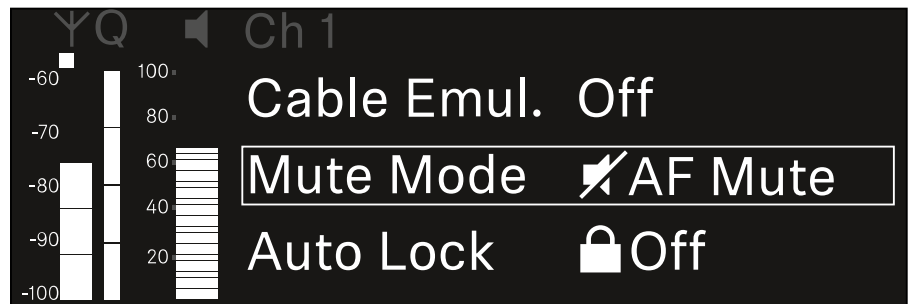

- ▷ Press the **jog dial** to open the menu.
The following view is displayed:

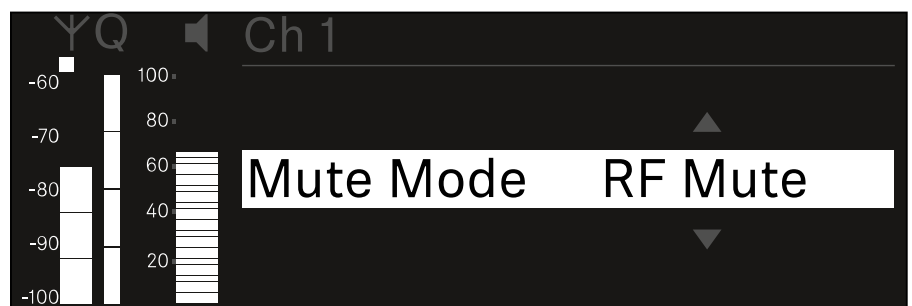

- ▷ Turn the **jog dial** to set the desired value.
- ▷ Press the **jog dial** to save your setting.
- or
- ▷ Press the **ESC** button to cancel the entry without saving the setting.

For the set value to be applied to the received transmitter, you must synchronize the channel („Connecting to the EW-DX EM 2 receiver / synchronizing the EW-DX EM 2“).



Ch 1 / Ch 2 -> Auto Lock menu item

In the **Auto Lock** menu item, you can activate or deactivate the lock-off for the received transmitter.

The lock-off prevents the transmitter from being unintentionally switched off and also prevents any changes to the transmitter's menu.

If you want to change settings in the transmitter's menu while the lock-off is active, you have to temporarily disable the lock-off:

- ▷ EW-DX SKM: „Lock-off function“
- ▷ EW-DX SK: „Lock-off function“

To open the **Auto Lock** menu item:

- ▷ In the menu, navigate to the **Auto Lock** menu item for the desired channel.

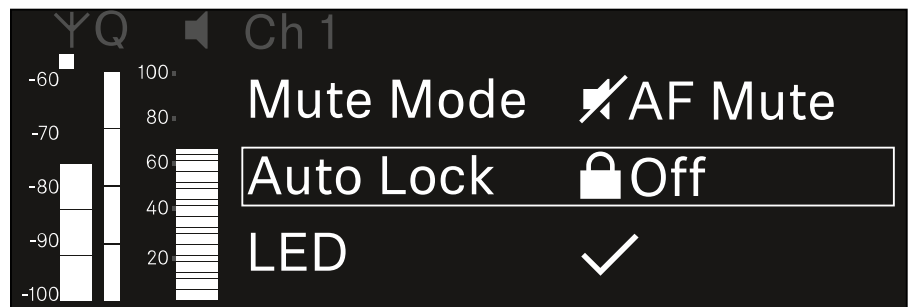

- ▷ Press the **jog dial** to open the menu.
The following view is displayed:

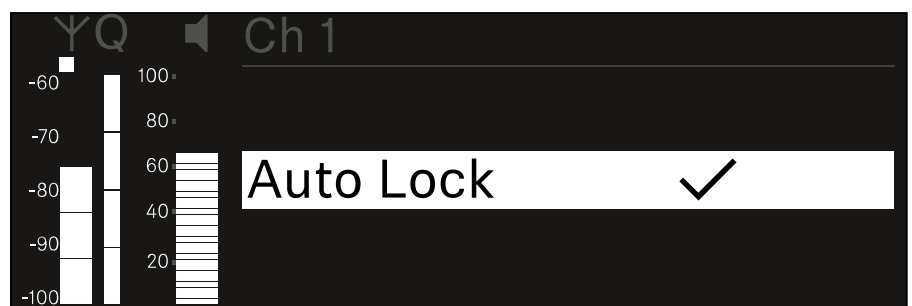

- ▷ Turn the **jog dial** to set the desired value.
- ▷ Press the **jog dial** to save your setting.
- or
- ▷ Press the **ESC** button to cancel the entry without saving the setting.

For the set value to be applied to the received transmitter, you must synchronize the channel („Connecting to the EW-DX EM 2 receiver / synchronizing the EW-DX EM 2“).



Ch 1 / Ch 2 -> LED menu item

The **LED** menu item allows you to set the behavior of the LINK LED on the received transmitter.

- Setting range:
 - **ON**: The LINK LED remains continuously lit.
 - **OFF**: The LINK LED switches off while the lock-off function is active.

For this to occur, the automatic lock-off function must be enabled in the Auto Lock menu item (see „Ch 1 / Ch 2 -> Auto Lock menu item“).

To open the **LED** menu item:

- ▷ In the menu, navigate to the **LED** menu item for the desired channel.

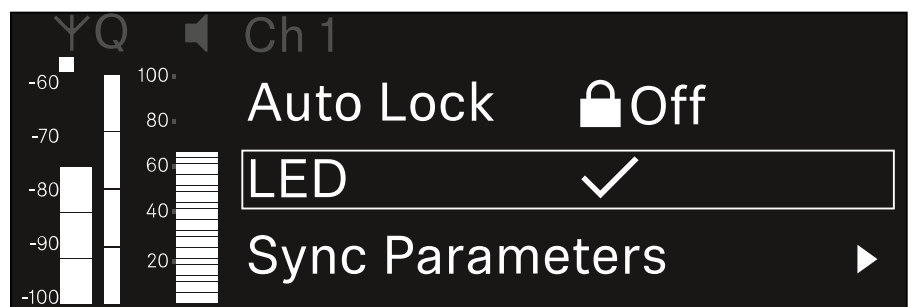

- ▷ Press the **jog dial** to open the menu.
The following view is displayed:

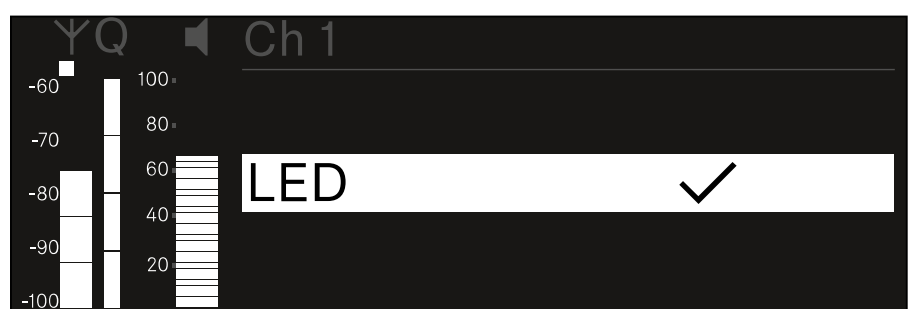

- ▷ Turn the **jog dial** to set the desired value.
- ▷ Press the **jog dial** to save your setting.
- or
- ▷ Press the **ESC** button to cancel the entry without saving the setting.

For the set value to be applied to the received transmitter, you must synchronize the channel („Connecting to the EW-DX EM 2 receiver / synchronizing the EW-DX EM 2“).



Ch 1 / Ch 2 -> Sync Parameters menu item

In the **Sync Parameters** menu item, you can choose which settings for the transmitter you want to transfer from the receiver to the transmitter during the synchronization.

All of the settings can also be set separately in the menu on the transmitter. During synchronization, the values set in the transmitter are overwritten with the values set in the receiver.

The following parameters can be enabled or disabled for transmission.

- **Name**
- **Frequency**
- **Trim**
- **Low Cut**
- **Cable Emul.**
- **Mute Mode**
- **Auto Lock**
- **LED**

To open the **Sync Settings** menu item:

- ▷ In the menu, navigate to the **Sync Settings** menu item for the desired channel.

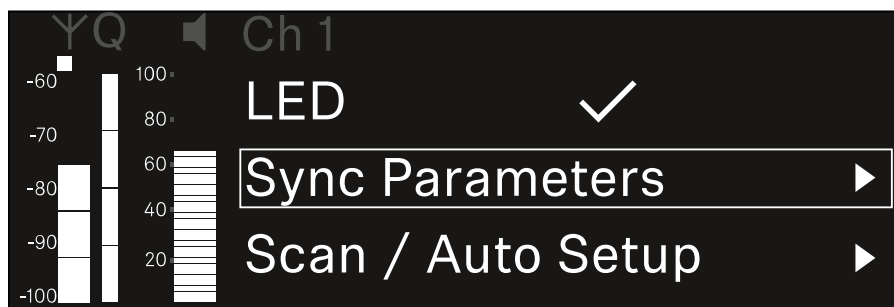

- ▷ Press the **jog dial** to open the menu.
The following view is displayed:

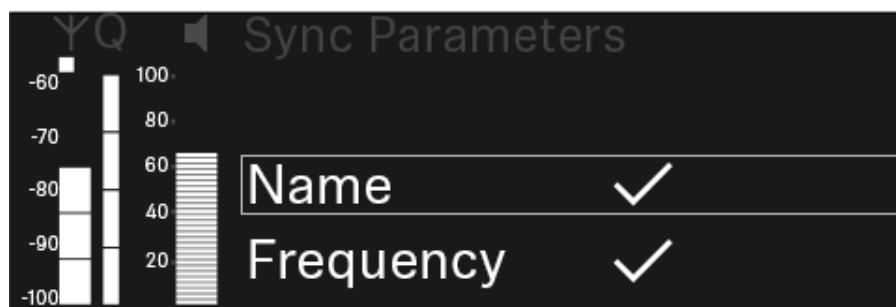

- ▷ Turn the **jog dial** to choose between the options.
- ▷ Press the **jog dial** to open your selected option.

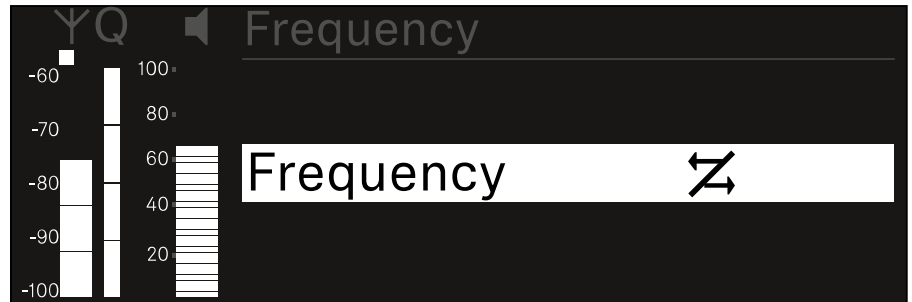
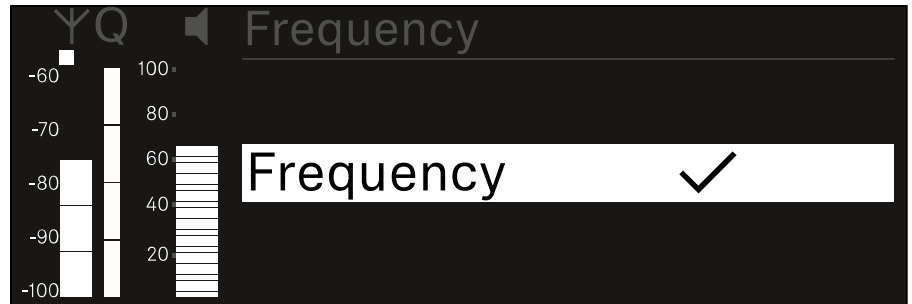

- ▷ For each option, select whether it will be synchronized or not.
 - ✓ The value set for this function will be transferred during synchronization.
 - ✗ The value set for this function will not be transferred during synchronization.
- ▷ Press the **jog dial** to save your setting.



Ch 1 / Ch 2 -> Scan / Auto Setup menu item

The receiver lets you scan the frequency spectrum and display all of the free frequencies in the selected frequency range. The automatic frequency setup can be used to distribute the free frequencies to all of the EW-DX EM 2 devices available in the network automatically.

- ▷ Switch off all transmitters before you perform the scan. If transmitters are still switched on, they are detected as unavailable frequencies and the frequencies that are actually available cannot then be used.

To perform the automatic frequency setup for all devices in the network, the Auto Setup function must be enabled in the receiver's system menu: „System -> Auto Setup menu item“.

To open the **Scan / Auto Setup** menu item:

- ▷ In the menu, navigate to the **Scan / Auto Setup** menu item for the desired channel.

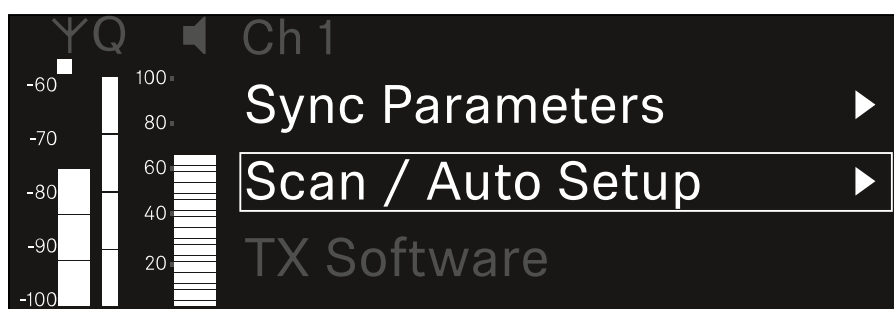

- ▷ Press the **jog dial** to open the menu. The following view is displayed:

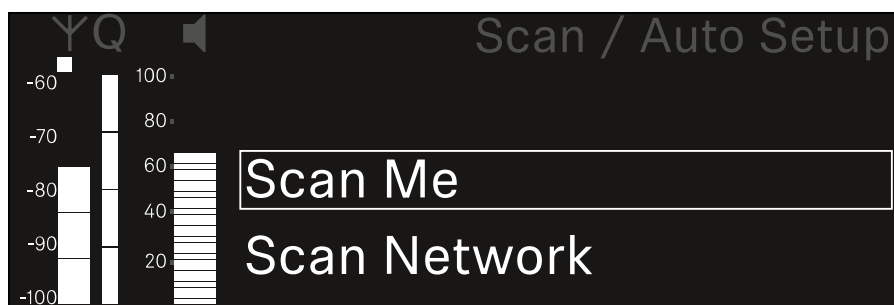

- ▷ Turn the **jog dial** to choose between the **Scan Me** and **Scan Network** options.
 - **Scan Me:** The frequency scan and the frequency setup are performed only for the selected receiving channel.
 - **Scan Network:** The frequency scan and the frequency



setup are performed for both channels of the receiver as well as for all other receivers available in the network.

- ▷ Press the **jog dial** to open your selected option.

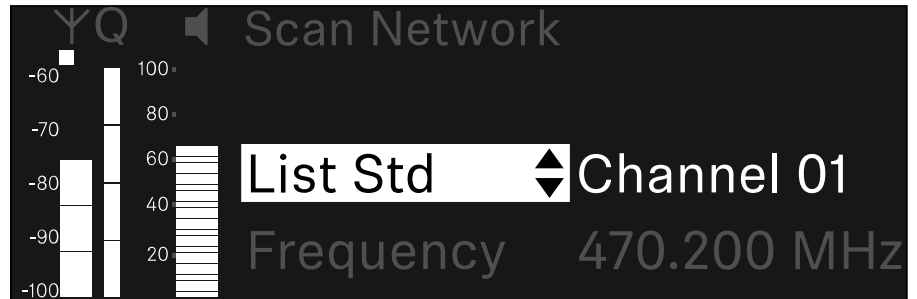

- ▷ Select a frequency from which to start the scan.
- ▷ Press the **jog dial** to start the scan.
The spectrum is scanned for free frequencies above the selected frequency.

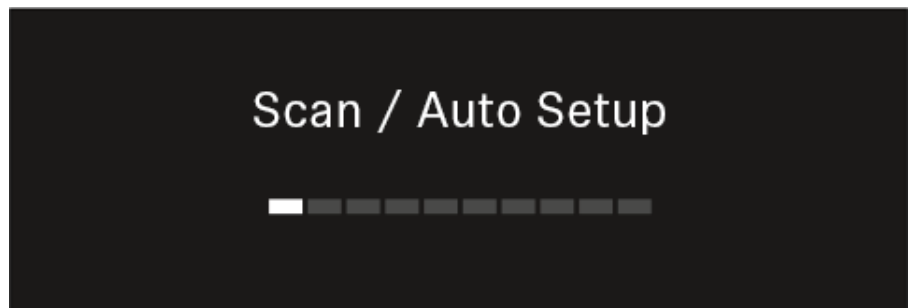

After the scan free frequencies are displayed, which you can then assign to the channels.

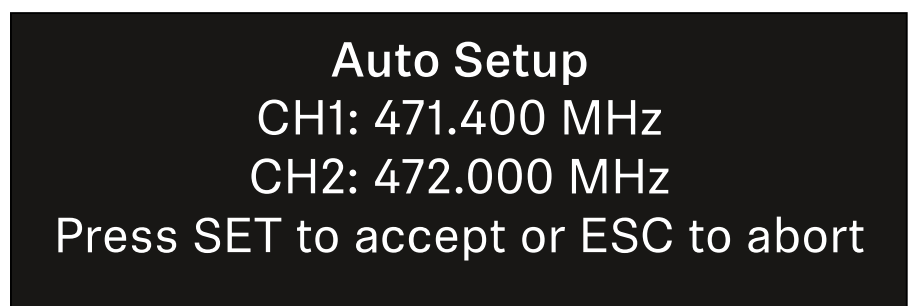

- ▷ Press the **jog dial** to assign the free frequencies to the receiving channels.
or
- ▷ Press the **ESC** key to cancel and not assign new frequencies.
- ▷ Next, synchronize the receiving channels with the corresponding transmitters to establish the radio link at the new selected frequencies („Synchronizing the receiver and transmitter“).



Ch 1 / Ch 2 -> TX Software menu item

The **TX Software** menu item displays the software version of the received transmitter.

You cannot open this menu item to make settings.

- ▷ In the menu, navigate to the **TX Software** menu item for the desired channel.

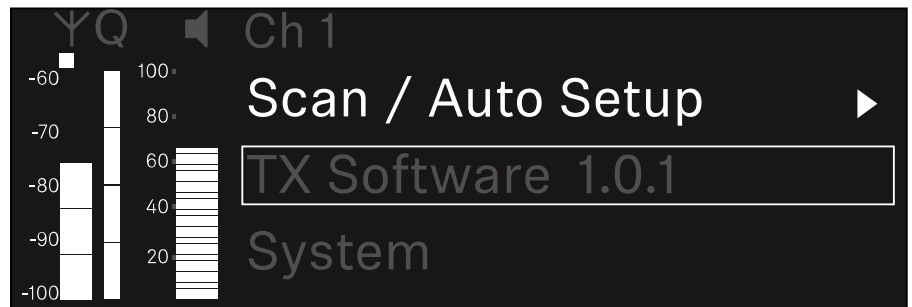

The version number of the transmitter software is shown on the display.

The transmitter must be switched on for this to be displayed.

You can find information about updating the transmitter firmware in section „System -> TX Update menu item“.



System menu item

In the System menu, you can make system-wide settings that will affect the entire device and not only the respective receiving channel.

The following menu items are available:

Encryption

This menu item lets you secure the radio link with AES 256 encryption.

- ▷ „System -> Encryption menu item“
-

Link Density

In this menu item, you can set the required transmission mode.

- ▷ „System -> Link Density menu item“
-

Network

In this menu item, you can configure the settings for the network connection.

- ▷ „System -> Network menu item“
-

TX Update

This menu item lets you perform a firmware update for the transmitters.

- ▷ „System -> TX Update menu item“
-

Auto Setup

This menu item allows you to activate automatic frequency setup for the receiver.

- ▷ „System -> Auto Setup menu item“
-



This Device

This menu item allows you to enter a device name and display information about the receiver's hardware and software.

- ▷ „System -> This Device menu item“

System -> Encryption menu item

You can secure the radio link between the transmitter and receiver using AES 256 encryption.

To open the **Encryption** menu item:

- ▷ In the System menu, navigate to the **Encryption** menu item.



- ▷ Press the **jog dial** to open the menu.
The following view is displayed:

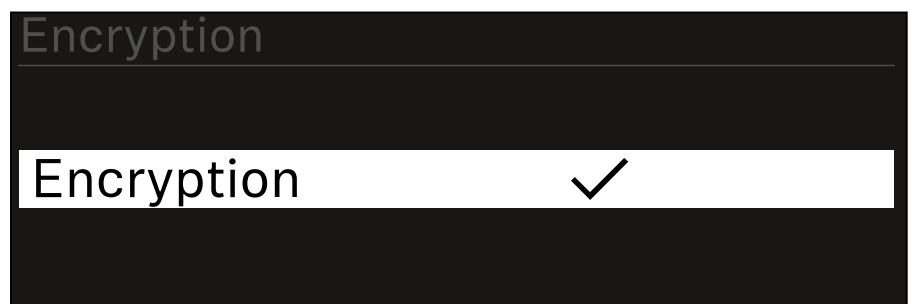

- ▷ Turn the **jog dial** to choose between the **On** and **Off** options.
- ▷ Press the **jog dial** to save your setting.

After enabling AES 256 encryption, the connected transmitter must be resynchronized with the receiver to enable encryption on the transmitter as well.



System -> Link Density menu item

Link Density mode (LD mode)

LD mode doubles the number of usable carrier frequencies in the available spectrum, as the minimum distance for the equidistant frequency grid is halved.

This is achieved by reducing the modulation bandwidth of the transmitter. This means that a much smaller frequency spacing between neighboring frequencies can be selected, and therefore more frequencies can be used in the same available spectrum without intermodulation.

LD mode is recommended if the following criteria are met:

- The required number of channels cannot be achieved using the normal mode, as there may be only a small spectrum available.
- The distance between the transmitters and the antennas is not too great.

To open the **Link Density** menu item:

- ▷ In the System menu, navigate to the **Link Density** menu item.

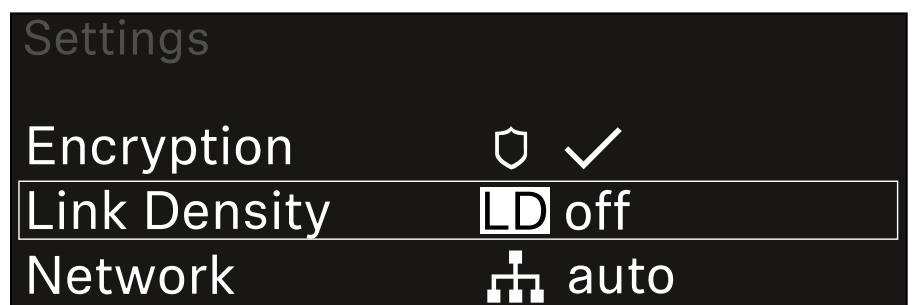

- ▷ Press the **jog dial** to open the menu.
The following view is displayed:

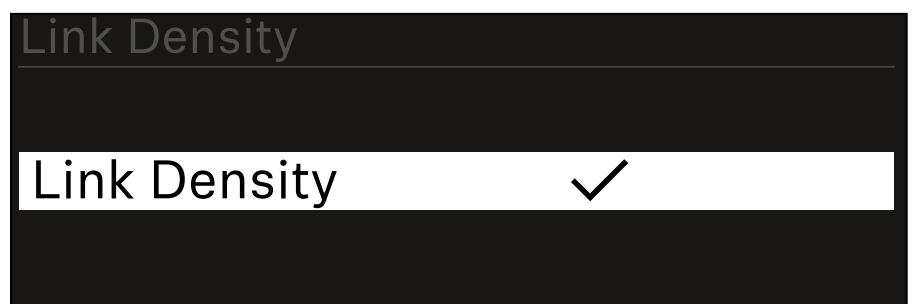

- ▷ Turn the **jog dial** to choose between the **On** and **Off** options.
- ▷ Press the **jog dial** to save your setting.
- ▷ If you have enabled LD mode, the receiver must be restarted.



LD Mode changed!
Restart required

Press SET to apply or ESC to cancel

- ▷ Press the **jog dial** to restart the receiver.
or
- ▷ Press the **ESC** button to cancel the mode change.

After enabling LD mode and restarting the receiver, the connected transmitter must be resynchronized with the receiver to enable LD mode on the transmitter as well.



System -> Network menu item

In this menu item, you can configure the settings for the network connection.

To open the **Network** menu item:

- ▷ In the System menu, navigate to the **Network** menu item.



- ▷ Press the **jog dial** to open the menu.
- ▷ Rotate the **jog dial** to navigate through the **Network** menu and select the desired menu item.



You can make the following settings here:

Mode

- **Auto:** The network configuration is performed automatically.
- **Manual:** The network configuration can be performed manually.

mDNS

You can enable or disable this option if you want to use mDNS for automatic device detection in the network.



IP

- If the **Mode** option is set to **Auto**, the automatically assigned IP address is displayed here.
- If the **Mode** option is set to **Manual**, you can set the IP address here.

Netmask

- If the **Mode** option is set to **Auto**, the automatically assigned netmask is displayed here.
- If the **Mode** option is set to **Manual**, you can set the netmask here.

Gateway

- If the **Mode** option is set to **Auto**, the automatically assigned gateway is displayed here.
- If the **Mode** option is set to **Manual**, you can set the gateway here.

Saving settings

To save the settings you have made:

- ▷ Turn the **jog dial** until **Apply** appears in the selection frame.

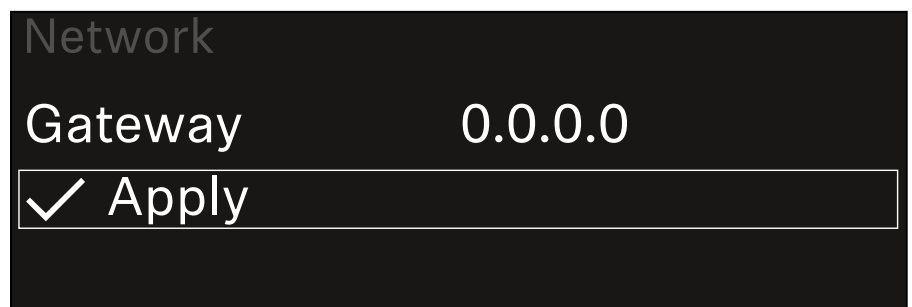

- ▷ Press the **jog dial** to save your settings.



System -> TX Update menu item

This menu item lets you perform a firmware update for the transmitters. This update is recommended after you perform a firmware update for the receiver (see „Updating the firmware of the receiver“).

The firmware versions currently installed on the connected transmitter can be viewed under the TX Software menu item for the respective channel (see „Ch 1 / Ch 2 -> TX Software menu item“).

To open the **TX Update** menu item:

- ▷ In the System menu, navigate to the **TX Update** menu item.

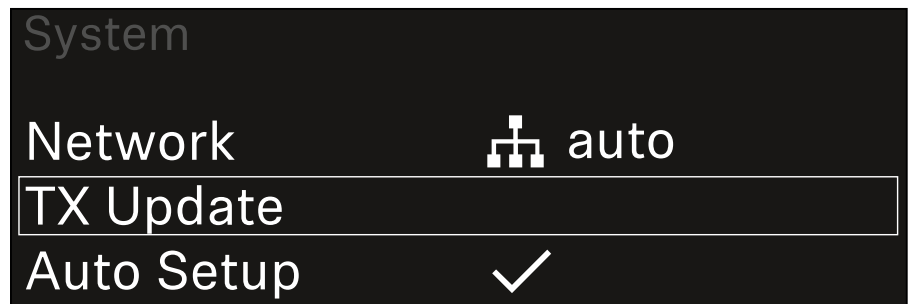

- ▷ Press the **jog dial** to open the menu.
The available sender firmware is displayed:

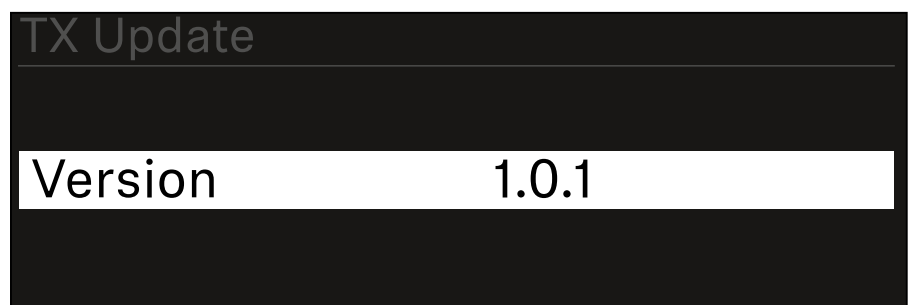

- ▷ Press the **jog dial** to start the firmware update.

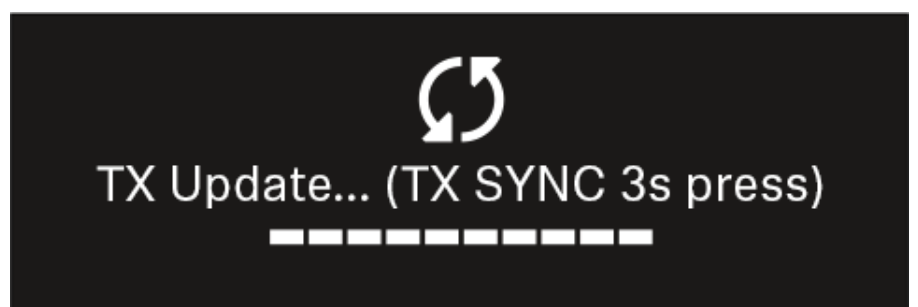

- ▷ Press the **SYNC** button on the connected transmitter for 3 seconds.



You have about 20 seconds to do this. The progress bar shows the remaining time.

The system carries out the firmware update for the transmitter.

The progress of the update is shown on the receiver's display.

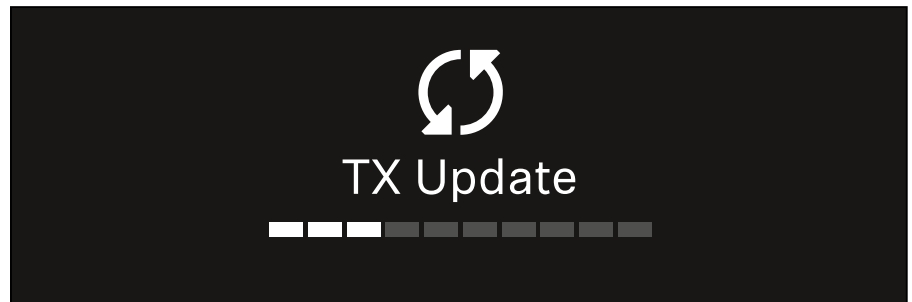

The transmitter's display shows that the firmware update is in progress.

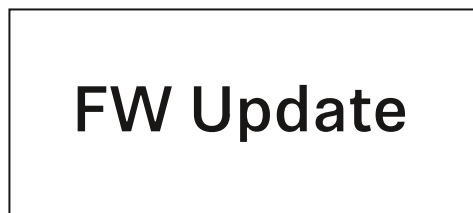

ATTENTION

Canceling the update can impair the function of the transmitter

If the transmitter is turned off during the firmware update, the update may fail and the transmitter may cease to function correctly.

- ▷ Do not turn off the transmitter during the update.
- ▷ Do not remove the batteries or rechargeable battery pack during the update.
- ▷ Make sure that the transmitter's (rechargeable) batteries are sufficiently charged before updating.



System -> Auto Setup menu item

In this menu item, you can activate the **Auto Setup** function for the receiver.

If the function is activated here, you can perform an automatic frequency setup for both channels of this receiver via the **Scan / Auto Setup** menu item.

See „Ch 1 / Ch 2 -> Scan / Auto Setup menu item“.

The receiver will also be enabled for automatic frequency set-up in a network consisting of multiple receivers.

If the function is disabled here, you can only assign a frequency to the selected channel of the receiver via the **Scan / Auto Setup** menu item.

To open the **Auto Setup** menu item:

- ▷ In the System menu, navigate to the **Auto Setup** menu item.

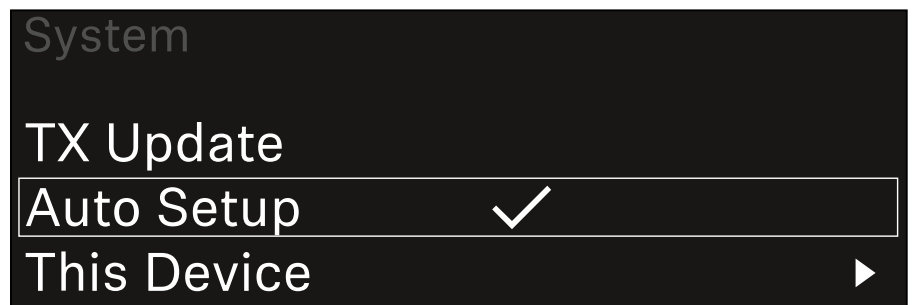

- ▷ Press the **jog dial** to open the menu.
The following view is displayed:

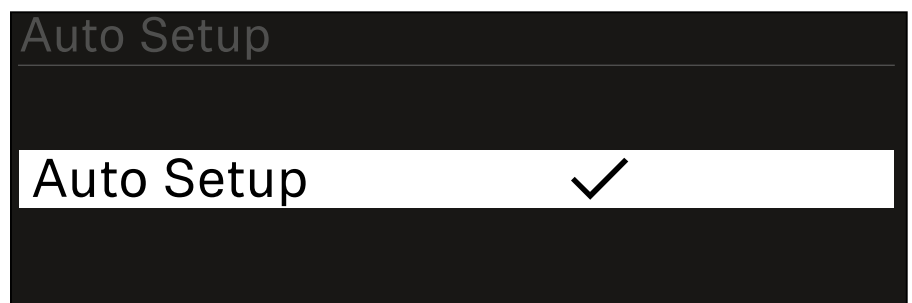

- ▷ Turn the **jog dial** to choose between the **On** and **Off** options.
- ▷ Press the **jog dial** to save your setting.



System -> This Device menu item

This menu item allows you to change the device name, view software and hardware information, or reset the device to factory settings.

To open the **This Device** menu item:

- ▷ In the System menu, navigate to the **This Device** menu item.

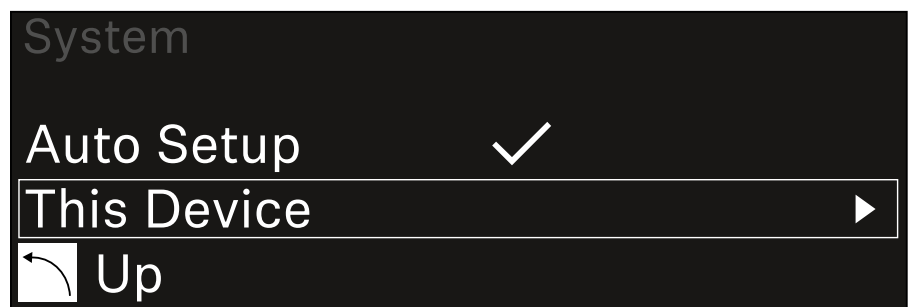

- ▷ Press the **jog dial** to open the menu.
The following view is displayed:

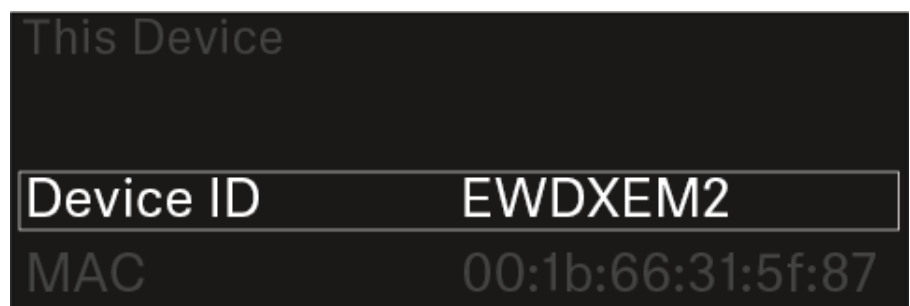

- ▷ Choose from the following:
 - **Device ID:** Open this menu item to change the device name. This receiver will be displayed in the network under this name.
 - **MAC:** Shows the MAC address of the receiver.
 - **Software:** Shows the software version of the receiver.
 - **HW Main/HW Front/HW Tuner:** Displays the hardware versions of the boards installed in the receiver.
 - **Reset:** Resets the receiver to factory settings.



Updating the firmware of the receiver

You can update the receiver firmware using the **Sennheiser Control Cockpit** software or the **Wireless Systems Manager** software.

- ▷ To do so, connect the receiver to a network (see „Connecting receivers in a network“) and establish the connection with the software.

For more information about controlling devices with the **Sennheiser Control Cockpit** or **Wireless Systems Manager** software, refer to the software help.

You can download the software here:

www.sennheiser.com/control-cockpit-software

www.sennheiser.com/wsm

To update the transmitter's firmware, go to System -> TX Update in the menu on the receiver. See „System -> TX Update menu item“.



EW-DX SKM | EW-DX SKM-S handheld transmitter

Product overview

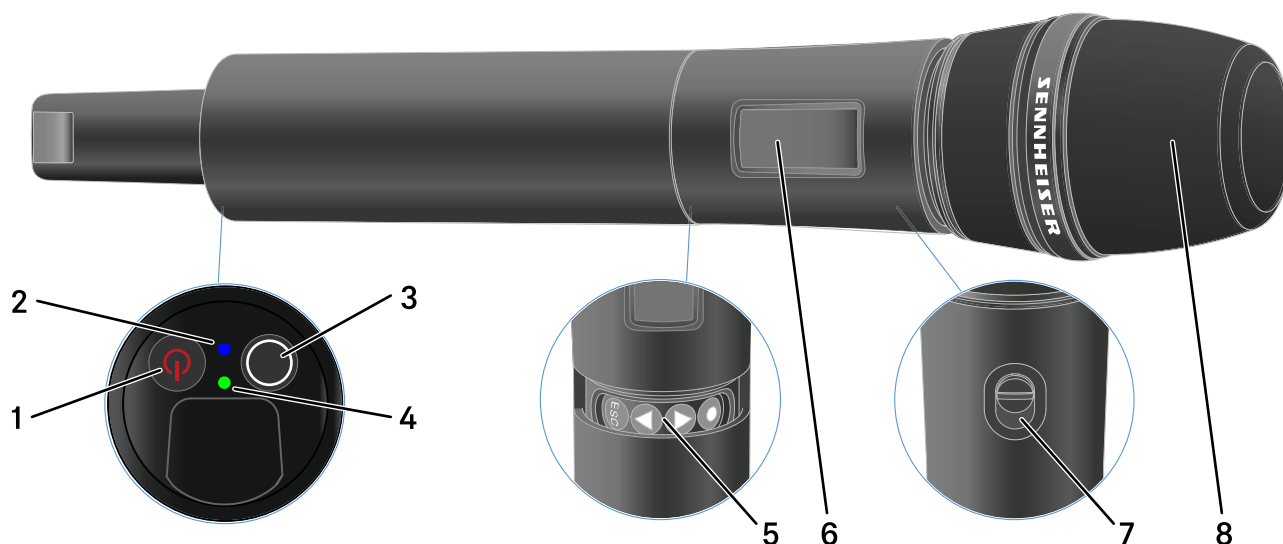

- 1 **ON/OFF** button
 - See „Switching the handheld transmitter on and off“
- 2 **DATA** LED
 - See „Meaning of the LEDs“
- 3 **SYNC** button
 - See „Establishing a connection to the receiver“
- 4 **LINK** LED
 - See „Meaning of the LEDs“
- 5 Function buttons for navigating the menu
 - See „Buttons for navigating the handheld transmitter’s menu“
- 6 Display panel
 - See „Information on the handheld transmitter’s display“
- 7 Mute switch (EW-DX SKM-S only)
 - See „Configuring mute mode and muting the handheld transmitter (EW-DX SKM-S only)“
- 8 Microphone module
 - See „Replacing the microphone module“



Inserting and removing the batteries/rechargeable batteries

You can operate the handheld transmitter either with batteries (AA, 1.5 V) or with the rechargeable Sennheiser BA 70 battery.

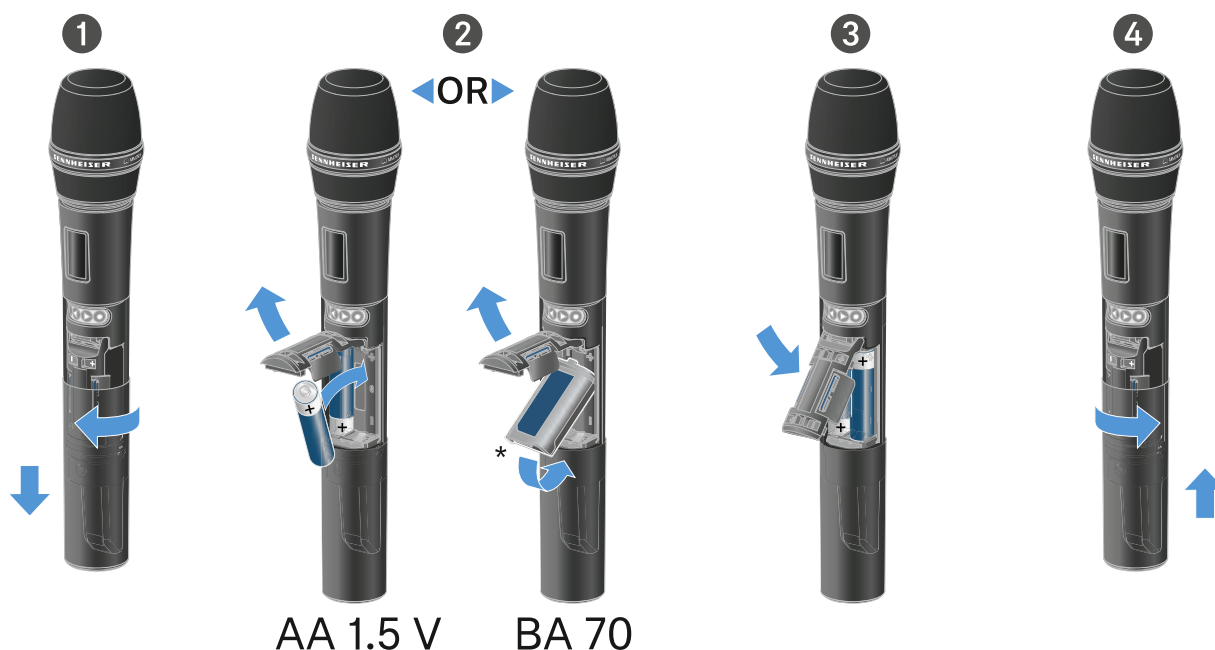

- ▷ Unscrew the microphone housing as shown in the figure and pull it down as far as it will go.
- ▷ Insert the batteries or the BA 70 rechargeable battery as indicated in the battery compartment. Observe correct polarity.
- ▷ Screw the microphone housing back on.

Note about the BA 70 rechargeable battery

- ▷ Make sure that the **BA 70** rechargeable battery is inserted as follows:

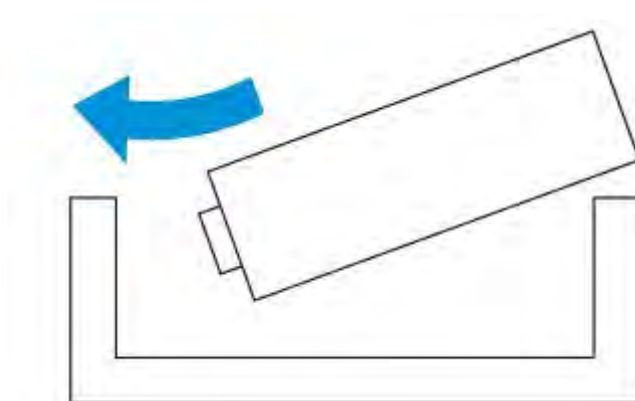



Replacing the microphone module

To replace the microphone module:

- ▷ Unscrew the microphone module.
- ▷ Screw the desired microphone module on.
- ▷ Do not touch the wireless microphone contacts or the microphone module contacts. If you touch the contacts, they may become dirty or bent.



Compatible microphone modules

The following microphone modules are compatible with the handheld transmitter:

- **MMD 835-1** | Dynamic microphone module with cardioid pattern
- **MMD 845-1** | Dynamic microphone module with super-cardioid pick-up pattern
- **MME 865-1** | Condenser microphone module with super-cardioid pick-up pattern
- **MMD 935-1** | Dynamic microphone module with cardioid pattern



- **MMD 945-1** | Dynamic microphone module with super-cardioid pick-up pattern
- **MMK 965-1** | Condenser microphone module with selectable pattern: cardioid and super-cardioid
- **MMD 42-1** | Dynamic microphone module with omni-directional pattern
- **Neumann KK 204** | Condenser microphone module with cardioid pattern
- **Neumann KK 205** | Condenser microphone module with super-cardioid pick-up pattern
- **MM 435** | Dynamic microphone module with cardioid pattern
- **MM 445** | Dynamic microphone module with super-cardioid pick-up pattern
- **ME 9002** | Condenser microphone module with omni-directional pattern
- **ME 9004** | Condenser microphone module with cardioid pattern
- **ME 9005** | Condenser microphone module with super-cardioid pick-up pattern



Switching the handheld transmitter on and off

To switch the handheld transmitter on:

- ▶ Short-press the **ON/OFF** button.
The **LINK** LED lights up and the transmitter switches on.

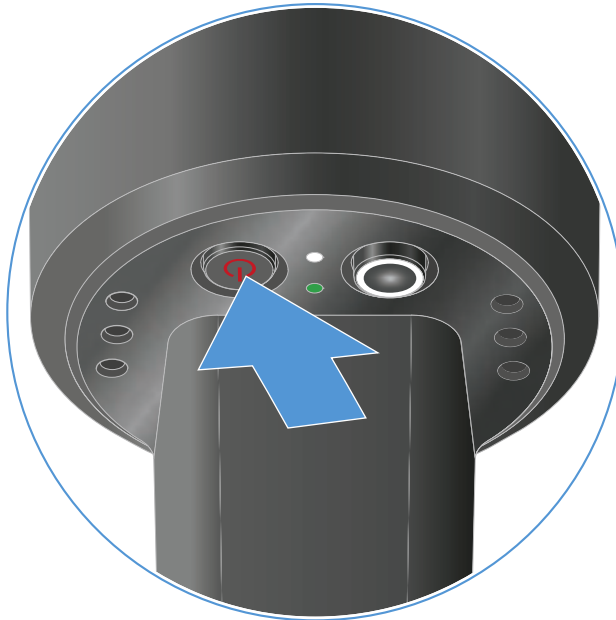

To switch the handheld transmitter off:

- ▶ Hold down the **ON/OFF** button until the LEDs switch off.

Note that the transmitter's permanent E-Ink display still displays the parameters after it is switched off.





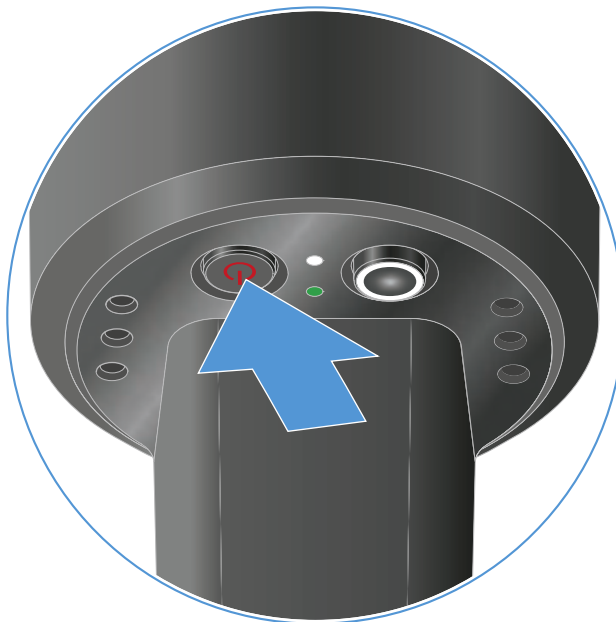

Checking the battery status of the transmitter (Check function)

To check the battery status of the transmitter:

- ▷ Short-press the **ON/OFF** button on the transmitter.



The transmitter's **LINK LED** flashes to indicate the current charge level of the battery or the BA 70 rechargeable battery.

LINK LED	
	≤ 100 %
	≤ 60 %
	≤ 20 %

In addition, the battery status is displayed on the transmitter display for approx. 5 seconds.

Pressing the transmitter's **ON/OFF** button will simultaneously trigger the Identify function: „Identifying the paired receiver (Identify function)“.



Identifying the paired receiver (Identify function)

In multi-channel systems, you can use the **Check** function to quickly identify to which receiver the transmitter is paired.

Both the transmitter and receiver must be switched on.

- ▷ Short-press the **ON/OFF** button on the transmitter.

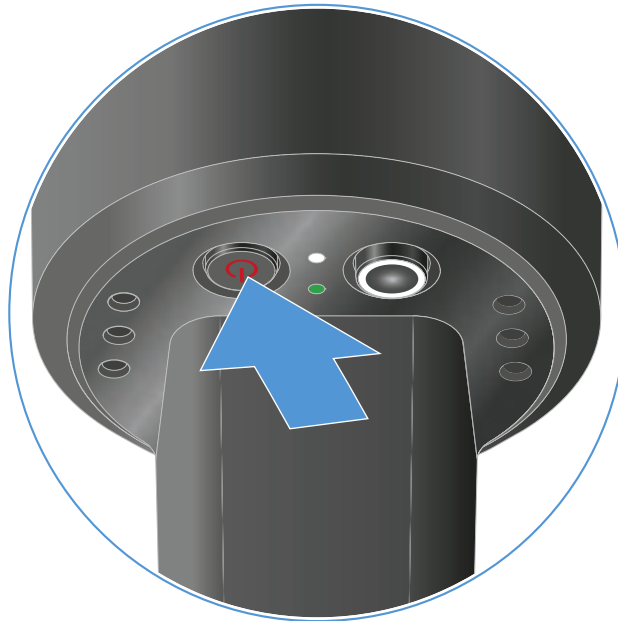

An eye flashes next to the respective receiving channel on the coupled receiver's display.



Pressing the transmitter's **ON/OFF** button will simultaneously trigger the Check function: „Checking the battery status of the transmitter (Check function)“.



Meaning of the LEDs

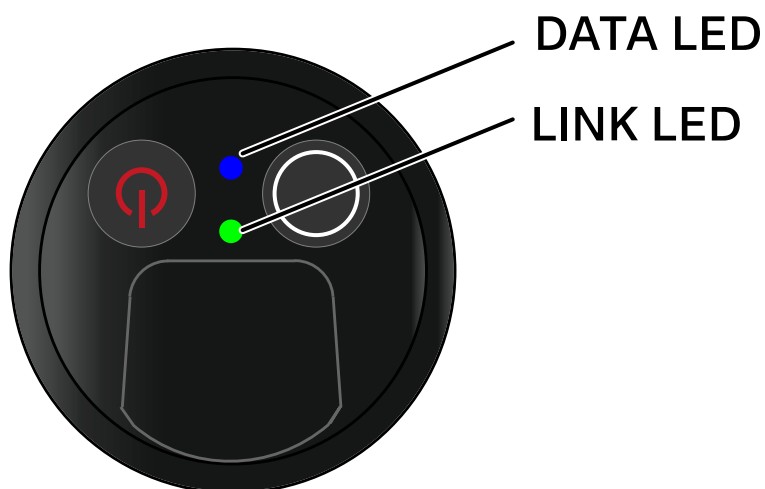

The **LINK** and **DATA** LEDs on the bottom of the transmitter can indicate the following information.

LINK LED

The **LINK** LED provides information about the status of the radio link between the transmitter and receiver, as well as status information for the transmitter.

The LED is green:

- ▷ The link between the transmitter and receiver is established.
- ▷ The audio signal is active.

The LED is yellow:

- ▷ The link between the transmitter and receiver is established.
 - ▷ The audio signal is muted.
- or
- ▷ No microphone module is mounted on the SKM-S handheld transmitter.
-



The LED is flashing yellow:

- ▷ The link between the transmitter and receiver is established.
 - ▷ The audio signal is overdriven (clipping).
-

The LED is continuously red:

- ▷ No link between the transmitter and receiver.
-

The LED is flashing red:

- ▷ The link between the transmitter and receiver is established.
 - ▷ The battery/rechargeable battery in the transmitter is low.
-

The LED is off:

- ▷ No link between the transmitter and receiver.
 - ▷ The transmitter is switched off.
-

DATA LED

The **DATA** LED provides information about the synchronization of transmitters and receivers.

The LED is flashing blue:

- ▷ The transmitter is being synchronized with a receiver.
-

The LED is continuously blue:

- ▷ The firmware is being updated.
-

The LED is off:

- ▷ There is currently no active data link.
-



Establishing a connection to the receiver

To establish a radio link between the transmitter and the receiver, the two devices must be set to the same frequency.

See „Establishing a radio link | Synchronizing the receiver and transmitter“.

Conditions and restrictions for using frequencies

There may be special conditions and restrictions for using frequencies in your country.

Before putting the product into operation, find the information for your country at the following address:

www.sennheiser.com/sifa



Information on the handheld transmitter's display

You can view the following information on the transmitter display.

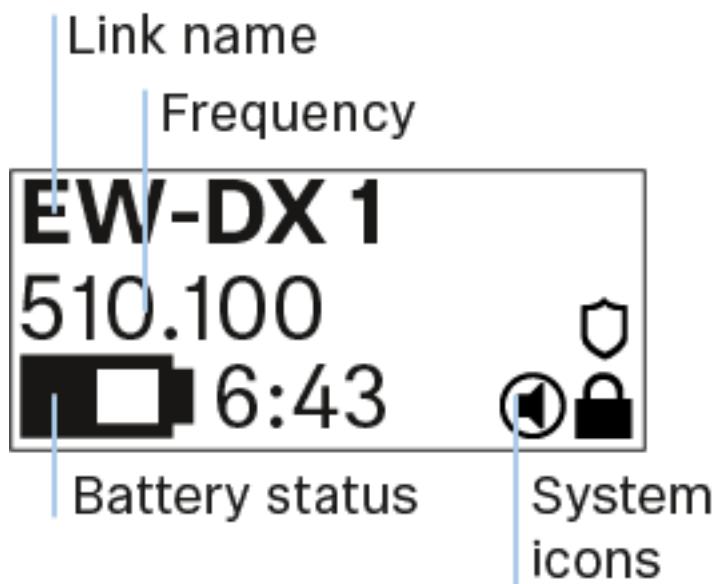

Further information

Link name:

You can assign a name to the radio link in the transmitter's menu (see „**Name** menu item“).

Alternatively, you can assign the name in the receiver's menu and then synchronize it to the transmitter (see „Ch 1 / Ch 2 -> Name menu item“).

Frequency:

You can manually set the frequency of the radio link in the transmitter's menu (see „**Frequency** menu item“).

The frequency of the radio link can also be set manually in the receiver's menu (see „Ch 1 / Ch 2 -> Frequency menu item“) or via the **Auto Setup** function (see „Ch 1 / Ch 2 -> Scan / Auto Setup menu item“) and then synchronized to the transmitter.



Battery status:

Displays the charging status of the batteries or the BA 70 battery pack.

When using the BA 70 rechargeable battery, the remaining runtime is also displayed in hours and minutes.

The battery status is hidden in the display's default state. Short-press the **On/Off** button on the transmitter (Check function, see „Checking the battery status of the transmitter (Check function)“) to display the battery status for approx. 5 seconds.

System icons:



The transmitter's mute switch is deactivated. See „**Mute Button** menu item (only EW-DX SKM-S)“.



The **Auto Lock** function is activated. See „**Auto Lock** menu item“.



AES 256 encryption is enabled. See „System -> Encryption menu item“.

Note that the transmitter's permanent E-Ink display still displays the parameters after it is switched off.



Buttons for navigating the handheld transmitter's menu

Use the following buttons to navigate through the transmitter's operating menu.

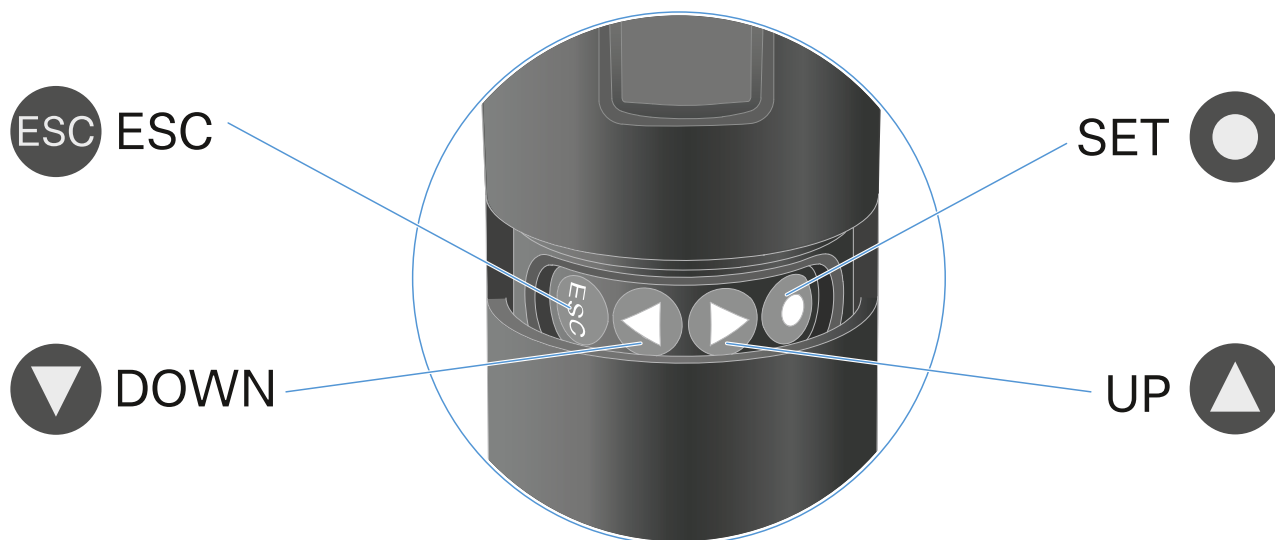

Press the **SET** button

- Jumps from the home screen to the operating menu
- Calls up a menu item
- Saves settings



Press the **UP** or **DOWN** button

- Changes to the previous or next menu item
- Changes the setting of a menu item



Press the **ESC (ON/OFF)** button

- Cancels the entry and returns to the previous display
-



Making settings in the menu of the handheld transmitter

Navigating through the menu

To open the menu:

- ▷ Press the **SET** button.

The operating menu is shown on the transmitter display panel.

To open a menu item:

Press the **UP** or **DOWN** buttons to navigate through the individual menu items.

Press the **SET** button to open the selected menu item.

„Buttons for navigating the menu of the bodypack transmitter“

Making changes in a menu item

After you open a menu item, you can make changes as follows:

- ▷ Press the **UP** or **DOWN** buttons to set the displayed value.
- ▷ Press the **SET** button to save the setting.
- ▷ Press the **ESC** button to leave the menu item without saving the setting.

„Buttons for navigating the menu of the bodypack transmitter“

Menu item overview

In the menu items, you can configure the settings below and display information.

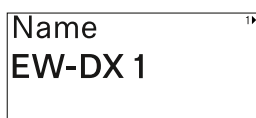

Name menu item

You can enter the name of the link in this menu item.

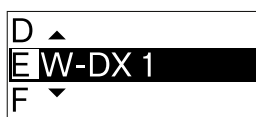

- ▷ Press the **UP** or **DOWN** buttons to select a character.



- ▷ Press the **SET** button to go to the next position.
- ▷ At the last position, press the **SET** button to save the selected name.

If you enter a name for the radio link in the **Name** menu item on the receiver and then synchronize the receiving channel with the transmitter, the name entered in the transmitter is overwritten with the name entered in the receiver.

Frequency 2)
 510.100 MHz

Frequency menu item

In this menu item, you can set the transmitter's transmission frequency.

▲
 510.100 MHz
 ▼

- ▷ Press the **UP** or **DOWN** button to set the frequency's MHz range.
- ▷ Press the **SET** button to confirm your selection.

▲
 510.100 MHz
 ▼

- ▷ Press the **UP** or **DOWN** button to set the frequency's kHz range.
- ▷ Press the **SET** button to save the set frequency.

If you set a frequency for the channel using the **Frequency** menu item on the receiver or via the **Scan / Auto Setup** function and then synchronize the receiving channel with the transmitter, the frequency entered in the transmitter is overwritten by the frequency set in the receiver.



Low Cut
60 Hz

120 Hz

100 ▲
80 Hz
60 ▼

Low Cut menu item

In this menu item, you can adjust the value for the low cut filter.

- Setting range: 60 Hz, 80 Hz, 100 Hz,

- ▷ Press the **UP** or **DOWN** button to set the desired value.
- ▷ Press the **SET** button to confirm your selection.

If you set a value for the channel's low cut filter using the **Low Cut** menu item on the receiver and then synchronize the receiving channel with the transmitter, the value entered in the transmitter is overwritten by the value set in the receiver.

Trim
0 dB

Trim menu item

In this menu item, you can adjust the audio level of the transmitter as well as the gain of the wireless link (can be set only on the receiver) to suit input signals of different volumes.

- Setting range: **-12 dB** to **+6 dB** in increments of 1 dB

1 ▲
0 dB
-1 ▼

- ▷ Press the **UP** or **DOWN** button to set the desired value.
- ▷ Press the **SET** button to confirm your selection.

If you set a value for the channel in the **Trim** menu item on the receiver and then synchronize the receiving channel with the transmitter, the value entered in the transmitter is overwritten with the value entered in the receiver.

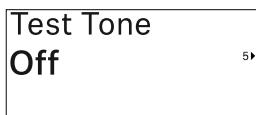

Test Tone menu item

In this menu item, you can activate a test tone that the transmitter transmits instead of the input signal. You can use

this feature to level out the system, for example.

- Setting range: **Off**, **-90 dB** to **0 dB** in 6 dB increments

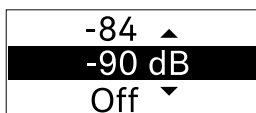

- ▷ Press the **UP** or **DOWN** button to set the desired value.
- ▷ Press the **SET** button to confirm your selection.



Mute Button menu item (only EW-DX SKM-S)

This function is only available for the EW-DX SKM-S version, not for the EW-

DX SKM version.

In this menu item you can set the function of the transmitter's mute switch.

- Setting range:
 - **Disabled:** The mute switch has no function.
 - **RF Mute:** The RF signal is deactivated when the mute switch is on.
 - **AF Mute:** The audio signal is muted when the mute switch is on.



- ▷ Press the **UP** or **DOWN** button to set the desired value.
- ▷ Press the **SET** button to confirm your selection.

If you set a function for the transmitter's mute switch in the **Mute Mode** menu item on the receiver and then synchronize the receiving channel with the transmitter, the value entered in the transmitter is overwritten with the value entered in the receiver.

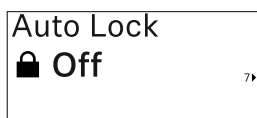

Auto Lock menu item

In this menu item, you can activate or deactivate the automatic lock-off for the transmitter.

The lock-off prevents the transmitter from being unintentionally switched off and also prevents any changes to the transmitter's menu.

If you want to change settings in the transmitter's menu while the lock-off is active, you have to temporarily disable the lock-off. See .



- ▷ Press the **UP** or **DOWN** button to set the desired value.
- ▷ Press the **SET** button to confirm your selection.

If you set a value for the transmitter's automatic lock-off in the **Auto Lock** menu item on the receiver and then synchronize the receiving channel with the transmitter, the value entered in the transmitter is overwritten with the value entered in the receiver.



Brightness menu item

In this menu item, you can adjust the brightness of the transmitter's display.

You can turn off the backlight completely or set it to one of five brightness levels.



- ▷ Press the **UP** or **DOWN** button to set the desired value.
- ▷ Press the **SET** button to confirm your selection.



LED menu item

This menu item allows you to set the behavior of the transmitter's LINK LED.

•Setting range:

- **ON:** The LINK LED remains continuously lit.
- **OFF:** The LINK LED switches off while the lock-off function is active.

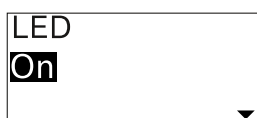

- ▷ Press the **UP** or **DOWN** button to set the desired value.
- ▷ Press the **SET** button to confirm your selection.

If you set a function for the transmitter's LINK LED in the **LED** menu item on the receiver and then synchronize the receiving channel with the transmitter, the value entered in the transmitter is overwritten with the value entered in the receiver.

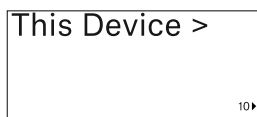

This Device menu item

In this menu item you can view information about the transmitter's software and hardware and reset the transmitter to the factory settings.

Show software

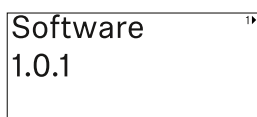



Shore hardware

```
Hardware 2>
1082000062
0592161_003
```

Reset to factory settings

```
Reset > 3>
```

- ▷ Press the **SET** button to open the Reset menu item.

```
Factory reset
No ▼
```

```
Factory reset
Yes ▲
```

- ▷ Press the **UP** or **DOWN** button to set the desired value.
- ▷ Press the **SET** button to confirm your selection.



Lock-off function

You can enable or disable the automatic lock-off function in the **Auto Lock** menu item (see „**Auto Lock** menu item“).

The lock-off function prevents the transmitter from being unintentionally switched off and also prevents any unintentional changes to the transmitter's configuration.

If you have enabled the **Auto Lock** function, you will have to temporarily deactivate the lock-off function to operate the transmitter.

To temporarily deactivate the lock-off function:

- ▷ Press the **SET** button.
Locked appears in the display panel.
- ▷ Press the **UP** or **DOWN** button.
Unlock? appears in the display panel.
- ▷ Press the **SET** button.
Lock-off function is now temporarily deactivated.



The lock-off function remains deactivated while you are actively working in the operating menu.

After 10 seconds of inactivity, it automatically activates again.



Configuring mute mode and muting the handheld transmitter (EW-DX SKM-S only)

This function is only available for the EW-DX SKM-S version, not for the EW-DX SKM version.

You can mute the handheld transmitter by using the mute switch to turn off either the audio signal (**AF Mute**) or the RF signal (**RF Mute**).

To do this, you must configure the function of the mute switch in the **Mute Mode** menu item.

- ▷ On the receiver: „Ch 1 / Ch 2 -> Mute Mode menu item“
- ▷ On the transmitter: „**Mute Button** menu item (only EW-DX SKM-S)“

AF Mute

- ▷ Slide the mute switch to the desired position to mute or activate the audio signal.

RF Mute

- ▷ Slide the mute switch to the desired position to activate or deactivate the RF signal.

Updating the firmware of the transmitter

The transmitter firmware is updated via the receiver.

- ▷ Update the transmitter firmware using the **TX Update** menu item in the receiver's System menu. See „System -> TX Update menu item“.



EW-DX SK | EW-DX SK 3-PIN bodypack transmitter

Product overview

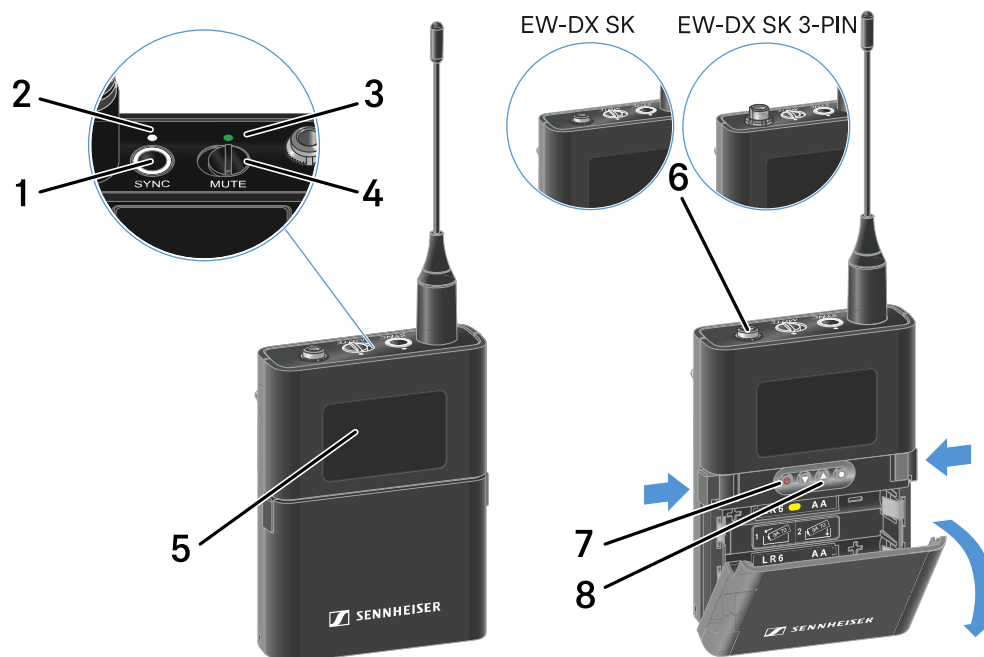

1 **SYNC** button

- See „Establishing a radio link | Synchronizing the receiver and transmitter“

2 **DATA** LED

- See „Meaning of the LEDs“

3 **LINK** LED

- See „Meaning of the LEDs“

4 Mute switch

- See „Configuring mute mode and muting the bodypack transmitter“

5 Display panel

- See „Information on the bodypack transmitter’s display“

6 **EW-DX SK**: 3.5 mm jack socket

EW-DX SK 3-PIN: 3-pin socket

- See „Connecting a microphone to the bodypack transmitter“
- See „Connecting an instrument or line source to the bodypack transmitter“



7 ON/OFF button

- See „Switching the bodypack transmitter on and off“

8 Function buttons for navigating the menu

- See „Buttons for navigating the menu of the bodypack transmitter“

Inserting and removing the batteries/rechargeable batteries

You can operate the bodypack transmitter either with batteries (AA, 1.5 V) or with the rechargeable Sennheiser BA 70 battery.

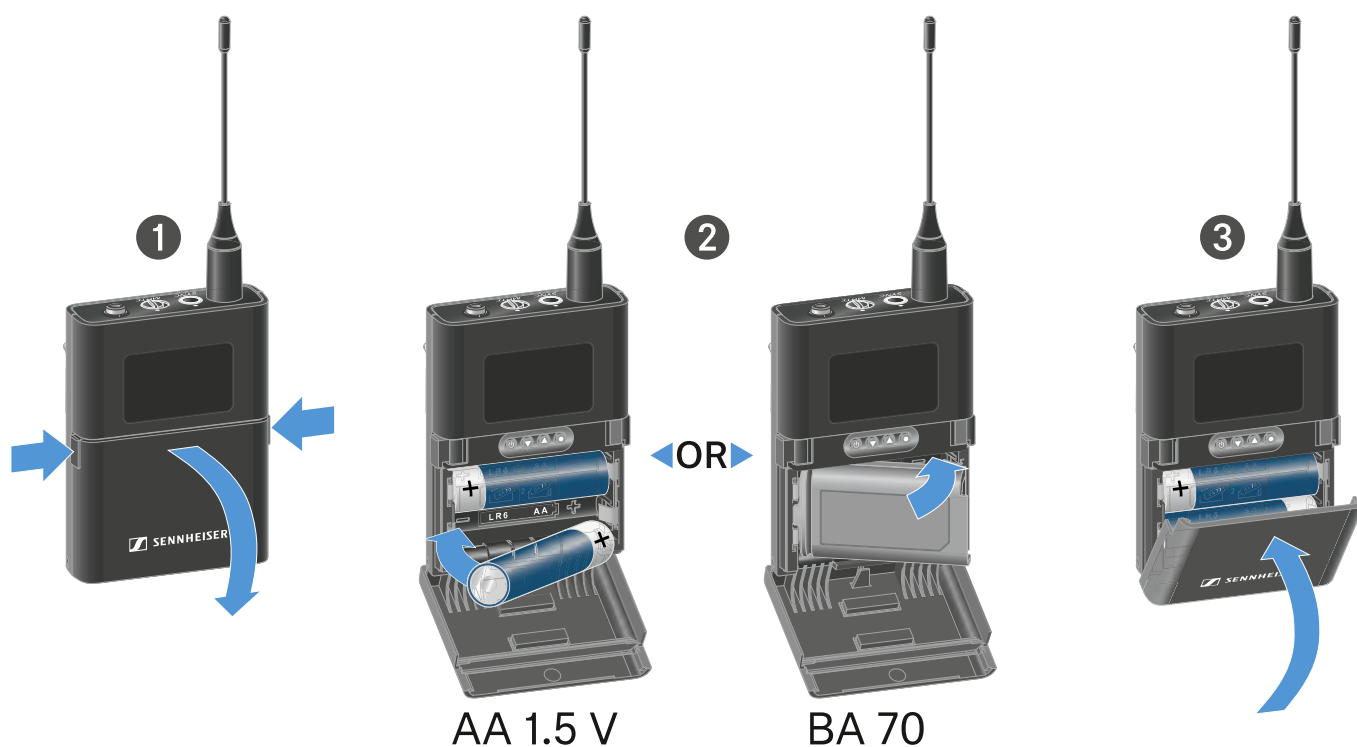

- ▷ Press the two catches and open the battery compartment cover.
- ▷ Insert the batteries or the BA 70 rechargeable battery as indicated in the battery compartment. Observe correct polarity.
- ▷ Close the battery compartment.
The cover locks into place with an audible click.



Note about the BA 70 rechargeable battery

- ▷ Make sure that the **BA 70** rechargeable battery is inserted as follows:

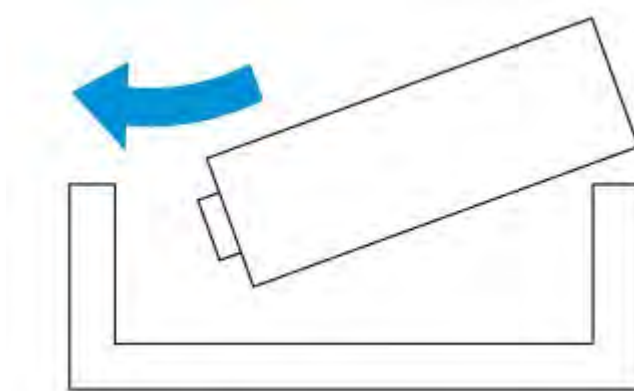



Connecting a microphone to the bodypack transmitter

Connecting a microphone to the EW-DX SK

To connect a microphone to the EW-DX SK bodypack transmitter:

- ▷ Insert the cable's 3.5 mm jack plug into the socket on the bodypack transmitter as shown in the diagram.
- ▷ Screw the plug's coupling ring onto the audio socket thread of the bodypack transmitter.



Compatible microphones

The following microphones are compatible with the EW-DX SK bodypack transmitter:

**Lavalier microphones:**

- **ME 2** | Lavalier microphone with omni-directional pattern (models from 2021 and later with gold-plated plug*)
- **ME 4** | Lavalier microphone with cardioid pattern (models from 2021 and later with gold-plated plug*)
- **MKE Essential Omni** | Lavalier microphone with omni-directional pattern
- **MKE 2 Gold** | Lavalier microphone with omni-directional pattern (models from 2018 and later with blue serial number label)
- **MKE 1** | Lavalier microphone with omni-directional pattern
- **MKE mini** | Lavalier microphone with omni-directional pattern

Headset microphones:

- **ME 3** | Headset microphone with cardioid pattern (models from 2021 and later with gold-plated plug*)
- **HSP Essential Omni** | Headset microphone with omni-directional pattern
- **HSP 2** | Headset microphone with omni-directional pattern (models from March 2020 and later with code 1090 or higher)
- **HS 2** | Headset microphone with omni-directional pattern (models from 2021 and later with gold-plated plug*)
- **SL Headmic 1** | Headset microphone with omni-directional pattern

*Pre-2021 models with a nickel plug are not recommended. They can pick up noise if they are placed too close to the transmitter.



Connecting a microphone to the EW-DX SK 3-PIN

To connect a microphone to the EW-DX SK 3-PIN bodypack transmitter:

- ▷ Insert the cable's three-pin plug into the socket on the bodypack transmitter as shown in the diagram.
- ▷ Screw the plug's coupling ring onto the audio socket thread of the bodypack transmitter.



Compatible microphones

The following microphones are compatible with the EW-DX SK 3-PIN bodypack transmitter:

Lavalier microphones:

- **MKE 1-4** | Lavalier microphone with omni-directional pattern
- **MKE 2-4** | Lavalier microphone with omni-directional pattern



- **MKE 40-4** | Lavalier microphone with cardioid pattern
- **MKE Essential Omni Black-3-Pin** | Lavalier microphone with omni-directional pattern
- **MKE Essential Omni Beige-3-Pin** | Lavalier microphone with omni-directional pattern

Headset microphones:

- **HSP Essential Omni Black-3-Pin** | Headset microphone with omni-directional pattern
- **HSP Essential Omni Beige-3-Pin** | Headset microphone with omni-directional pattern
- **HSP 2** | Headset microphone with omni-directional pattern
- **HSP 4** | Headset microphone with cardioid pattern
- **SL Headmic 1-4** | Headset microphone with omni-directional pattern



Connecting an instrument or line source to the bodypack transmitter

Connecting an instrument or line source to the EW-DX SK

You can connect instruments or audio sources with a line level to the bodypack transmitter.

To do this, you will need the **CI 1** (6.3 mm jack plug on a lockable 3.5 mm jack plug) or **CL 2** (XLR-3F plug on a lockable 3.5 mm jack plug) Sennheiser cables.

To connect an instrument or line source to bodypack transmitter:

- ▷ Insert the cable's 3.5 mm jack plug into the socket on the bodypack transmitter as shown in the diagram.
- ▷ Screw the plug's coupling ring onto the audio socket thread of the bodypack transmitter.

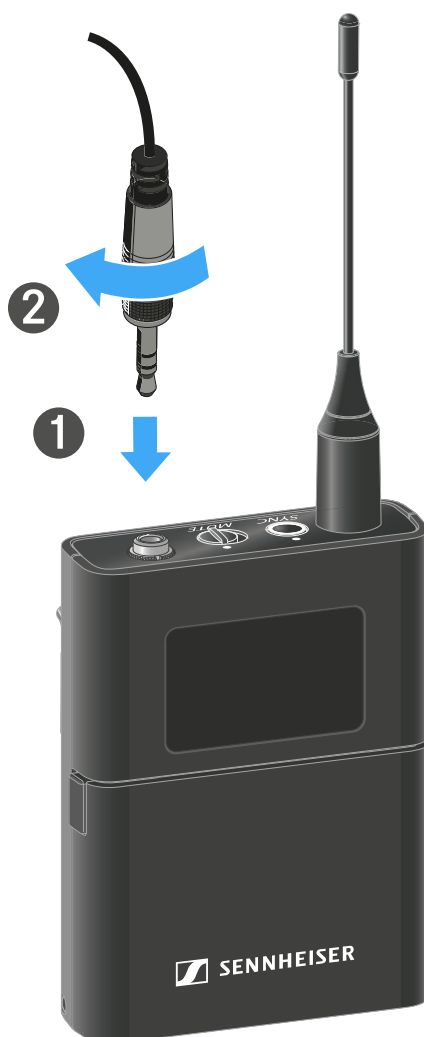



Connecting an instrument or line source to the EW-DX SK 3-PIN

You can connect instruments or audio sources with a line level to the bodypack transmitter.

To do so, you require the Sennheiser **CI 1-4** cable (6.3 mm (1/4") jack plug to screw-on 3-pin audio connector).

To connect an instrument or line source to bodypack transmitter:

- ▷ Insert the cable's three-pin plug into the socket on the bodypack transmitter as shown in the diagram.
- ▷ Screw the plug's coupling ring onto the audio socket thread of the bodypack transmitter.





Changing the belt clip

You can change the belt clip on the bodypack transmitter or flip it over depending on how you want to wear it.

To remove the belt clip:

- ▷ Carefully loosen the belt clip with a small screwdriver as shown in the figure.
- ▷ Be very careful not to scratch the housing.

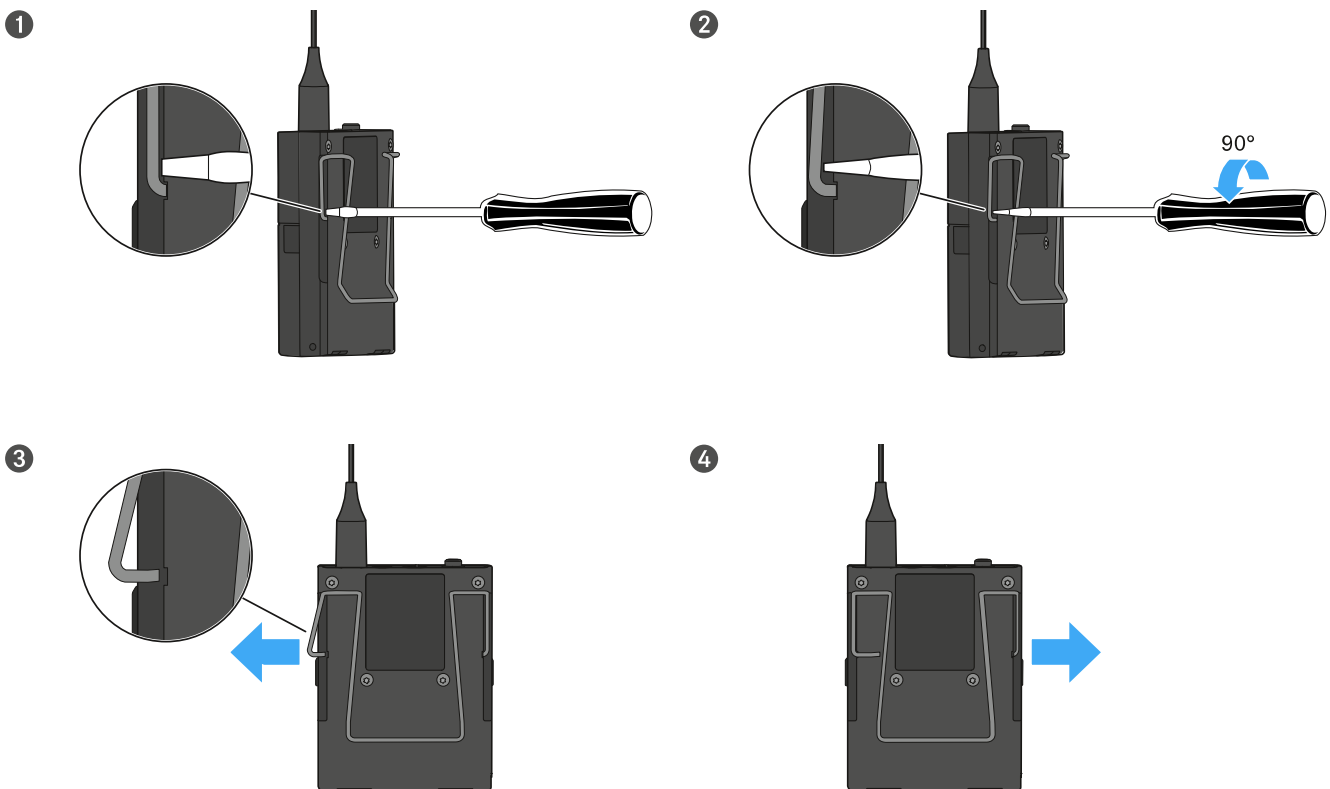



To insert the belt clip:

- ▷ Insert one side of the belt clip first as shown in the figure.
- ▷ Then insert the second side of the belt clip.
- ▷ Gently press the belt clip all the way in on both sides.
- ▷ Always insert one side before the other, not at the same time, as otherwise the belt clip could bend.

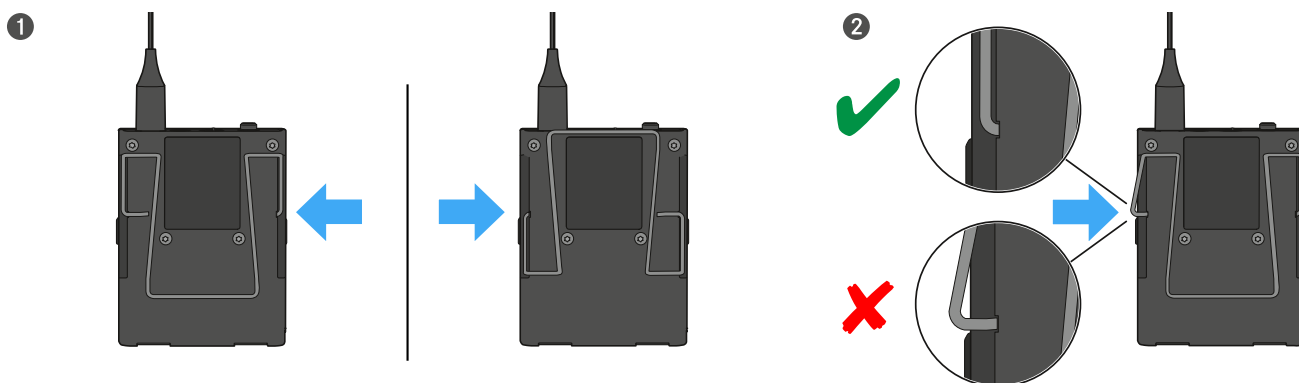



Switching the bodypack transmitter on and off

To switch the bodypack transmitter on:

- ▶ Short-press the **ON/OFF** button.
The **LINK** LED lights up and the transmitter switches on.

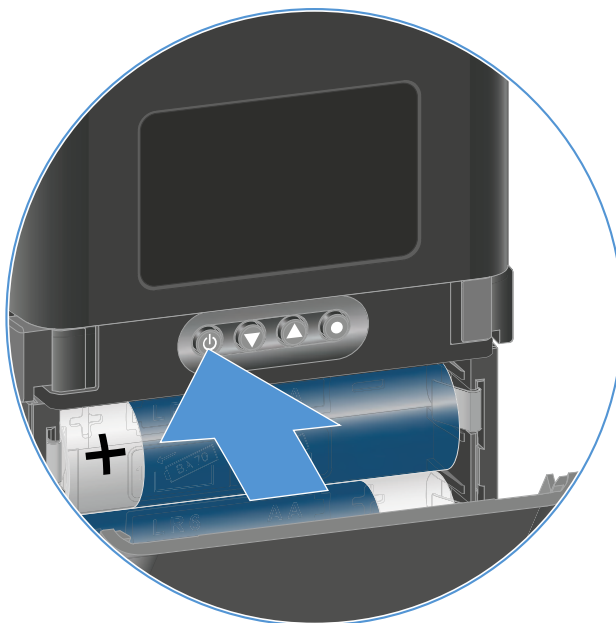

To switch the bodypack transmitter off:

- ▶ Hold down the **ON/OFF** button until the LEDs switch off.

Note that the transmitter's permanent E-Ink display still displays the parameters after it is switched off.





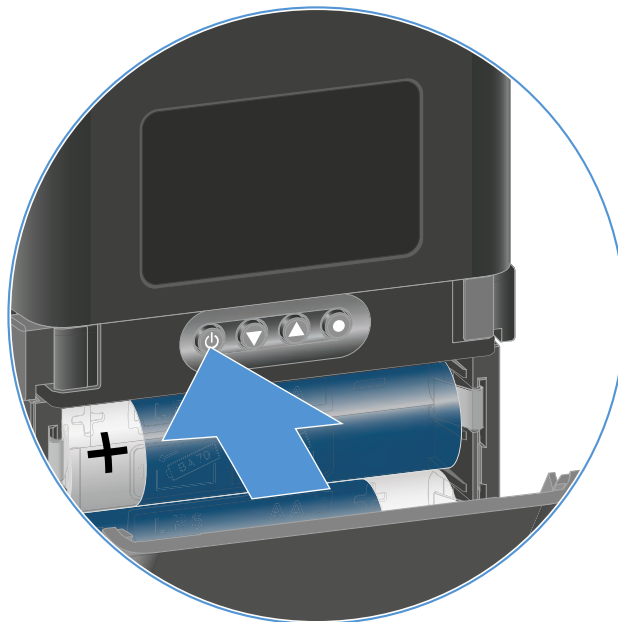

Checking the battery status of the transmitter (Check function)

To check the battery status of the transmitter:

- ▷ Short-press the **ON/OFF** button on the transmitter.



The transmitter's **LINK LED** flashes to indicate the current charge level of the battery or the BA 70 rechargeable battery.

LINK LED	
	≤ 100 %
	≤ 60 %
	≤ 20 %

In addition, the battery status is displayed on the transmitter display for approx. 5 seconds.

Pressing the transmitter's **ON/OFF** button will simultaneously trigger the Identify function: „Identifying the paired receiver (Identify function)“.



Identifying the paired receiver (Identify function)

In multi-channel systems, you can use the **Check** function to quickly identify to which receiver the transmitter is paired.

Both the transmitter and receiver must be switched on.

- ▷ Short-press the **ON/OFF** button on the transmitter.

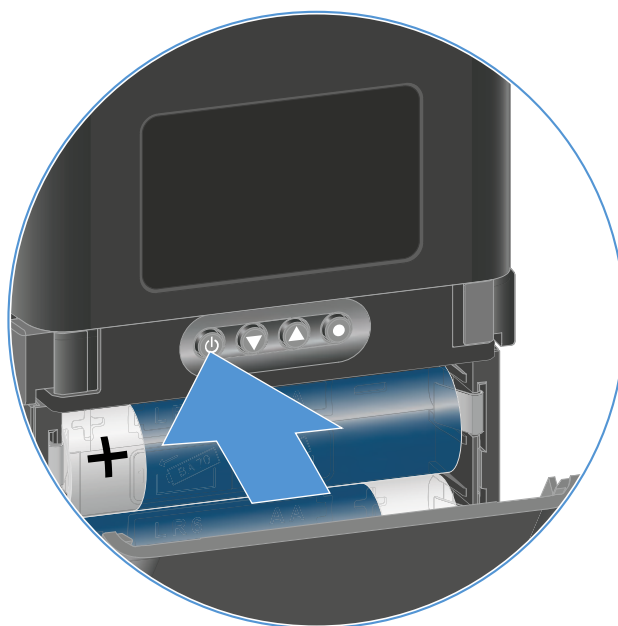

An eye flashes next to the respective receiving channel on the coupled receiver's display.



Pressing the transmitter's **ON/OFF** button will simultaneously trigger the Check function: „Checking the battery status of the transmitter (Check function)“.



Meaning of the LEDs

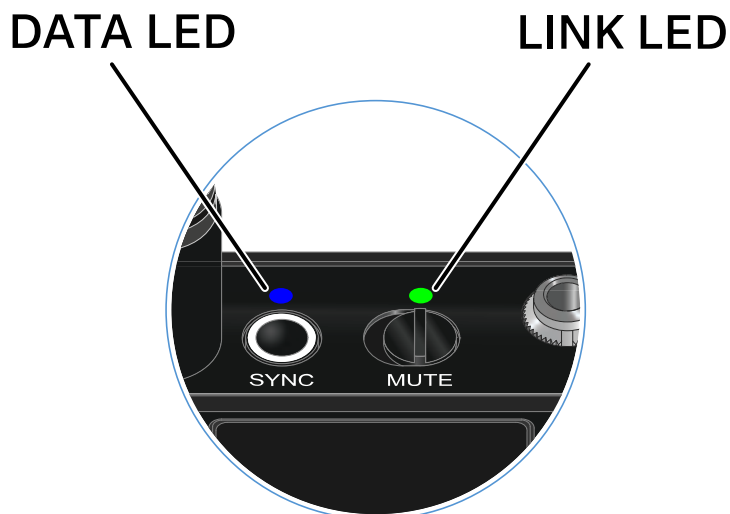

The **LINK** and **DATA** LEDs on the top of the transmitter can indicate the following information.

LINK LED

The **LINK** LED provides information about the status of the radio link between the transmitter and receiver, as well as status information for the transmitter.

The LED is green:

- ▷ The link between the transmitter and receiver is established.
- ▷ The audio signal is active.

The LED is yellow:

- ▷ The link between the transmitter and receiver is established.
- ▷ The audio signal is muted.

The LED is flashing yellow:

- ▷ The link between the transmitter and receiver is established.
- ▷ The audio signal is overdriven (clipping).



The LED is continuously red:

- ▷ No link between the transmitter and receiver.
-

The LED is flashing red:

- ▷ The link between the transmitter and receiver is established.
 - ▷ The battery/rechargeable battery in the transmitter is low.
-

The LED is off:

- ▷ No link between the transmitter and receiver.
 - ▷ The transmitter is switched off.
-

DATA LED

The **DATA** LED provides information about the synchronization of transmitters and receivers.

The LED is flashing blue:

- ▷ The transmitter is being synchronized with a receiver.
-

The LED is continuously blue:

- ▷ The firmware is being updated.
-

The LED is off:

- ▷ There is currently no active data link.
-



Establishing a connection to the receiver

To establish a radio link between the transmitter and the receiver, the two devices must be set to the same frequency.

See „Establishing a radio link | Synchronizing the receiver and transmitter“.

Conditions and restrictions for using frequencies

There may be special conditions and restrictions for using frequencies in your country.

Before putting the product into operation, find the information for your country at the following address:

www.sennheiser.com/sifa



Information on the bodypack transmitter's display

You can view the following information on the transmitter display.

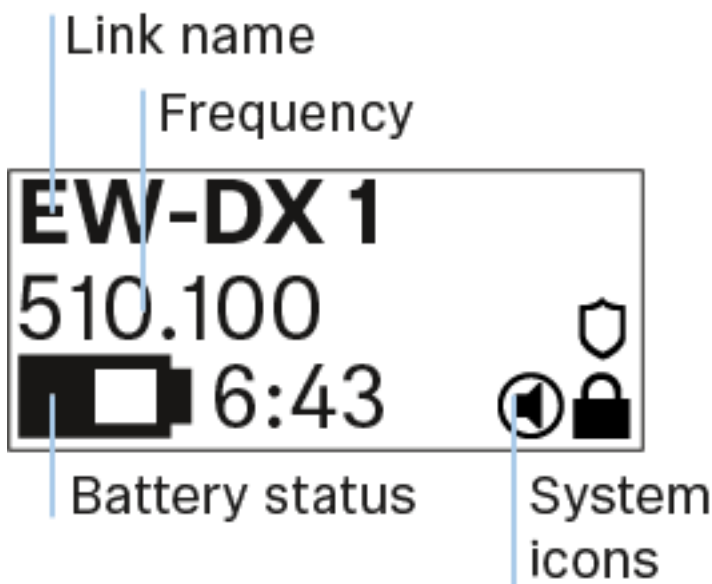

Further information

Link name:

You can assign a name to the radio link in the transmitter's menu (see „**Name** menu item“).

Alternatively, you can assign the name in the receiver's menu and then synchronize it to the transmitter (see „Ch 1 / Ch 2 -> Name menu item“).

Frequency:

You can manually set the frequency of the radio link in the transmitter's menu (see „**Frequency** menu item“).

The frequency of the radio link can also be set manually in the receiver's menu (see „Ch 1 / Ch 2 -> Frequency menu item“) or via the **Auto Setup** function (see „Ch 1 / Ch 2 -> Scan / Auto Setup menu item“) and then synchronized to the transmitter.



Battery status:

Displays the charging status of the batteries or the BA 70 battery pack.

When using the BA 70 rechargeable battery, the remaining runtime is also displayed in hours and minutes.

The battery status is hidden in the display's default state. Short-press the **On/Off** button on the transmitter (Check function, see „Checking the battery status of the transmitter (Check function)“) to display the battery status for approx. 5 seconds.

System icons:



The transmitter's mute switch is deactivated. See „**Mute Button** menu item“.



The **Auto Lock** function is activated. See „**Auto Lock** menu item“.



AES 256 encryption is enabled. See „System -> Encryption menu item“.

Note that the transmitter's permanent E-Ink display still displays the parameters after it is switched off.



Buttons for navigating the menu of the bodypack transmitter

Use the following buttons to navigate through the transmitter's operating menu.

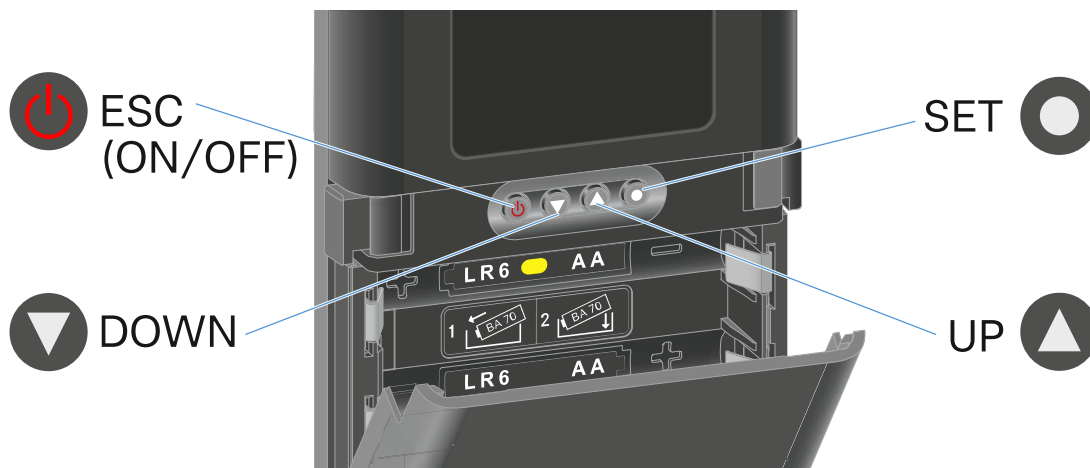

Press the **SET** button

- Jumps from the home screen to the operating menu
- Calls up a menu item
- Saves settings



Press the **UP** or **DOWN** button

- Changes to the previous or next menu item
- Changes the setting of a menu item



Press the **ESC (ON/OFF)** button

- Cancels the entry and returns to the previous display
-



Making settings in the menu of the bodypack transmitter

Navigating through the menu

To open the menu:

- ▷ Press the **SET** button.
The operating menu is shown on the transmitter display panel.

To open a menu item:

Press the **UP** or **DOWN** buttons to navigate through the individual menu items.

Press the **SET** button to open the selected menu item.

„Buttons for navigating the menu of the bodypack transmitter“

Making changes in a menu item

After you open a menu item, you can make changes as follows:

- ▷ Press the **UP** or **DOWN** buttons to set the displayed value.
- ▷ Press the **SET** button to save the setting.
- ▷ Press the **ESC** button to leave the menu item without saving the setting.

„Buttons for navigating the menu of the bodypack transmitter“

Menu item overview

In the menu items, you can configure the settings below and display information.

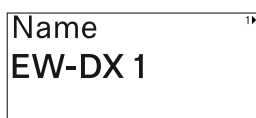

Name menu item

You can enter the name of the link in this menu item.

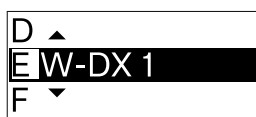

- ▷ Press the **UP** or **DOWN** buttons to select a character.



- ▷ Press the **SET** button to go to the next position.
- ▷ At the last position, press the **SET** button to save the selected name.

If you enter a name for the radio link in the **Name** menu item on the receiver and then synchronize the receiving channel with the transmitter, the name entered in the transmitter is overwritten with the name entered in the receiver.

Frequency 2)
 510.100 MHz

Frequency menu item

In this menu item, you can set the transmitter's transmission frequency.

▲
 510.100 MHz
 ▼

- ▷ Press the **UP** or **DOWN** button to set the frequency's MHz range.
- ▷ Press the **SET** button to confirm your selection.

▲
 510.100 MHz
 ▼

- ▷ Press the **UP** or **DOWN** button to set the frequency's kHz range.
- ▷ Press the **SET** button to save the set frequency.

If you set a frequency for the channel using the **Frequency** menu item on the receiver or via the **Scan / Auto Setup** function and then synchronize the receiving channel with the transmitter, the frequency entered in the transmitter is overwritten by the frequency set in the receiver.



Low Cut
30 Hz

100 Hz, 120 Hz

60 ▲
30 Hz
Off ▼

Low Cut menu item

In this menu item, you can adjust the value for the low cut filter.

- Setting range: Off, 30 Hz, 60 Hz, 80 Hz,

- ▷ Press the **UP** or **DOWN** button to set the desired value.
- ▷ Press the **SET** button to confirm your selection.

If you set a value for the channel's low cut filter using the **Low Cut** menu item on the receiver and then synchronize the receiving channel with the transmitter, the value entered in the transmitter is overwritten by the value set in the receiver.

Trim
0 dB

Trim menu item

In this menu item, you can adjust the audio level of the transmitter as well as the gain of the wireless link (can be set only

on the receiver) to suit input signals of different volumes.

- Setting range: **-12 dB** to **+6 dB** in increments of 1 dB

1 ▲
0 dB
-1 ▼

- ▷ Press the **UP** or **DOWN** button to set the desired value.
- ▷ Press the **SET** button to confirm your selection.

If you set a value for the channel in the **Trim** menu item on the receiver and then synchronize the receiving channel with the transmitter, the value entered in the transmitter is overwritten with the value entered in the receiver.



Cable Emulation
Type 2 ^{5*}

3

Cable Emulation menu item

In this menu item, you can emulate instrument cable lengths.

- Setting range: Off, Type 1, Type 2, Type

Cable Emulation
Type 2 ▲
▼

- ▷ Press the **UP** or **DOWN** button to set the desired value.
- ▷ Press the **SET** button to confirm your selection.

If you set a value for the channel in the **Cable Emul.** menu item on the receiver and then synchronize the receiving channel with the transmitter, the value entered in the transmitter is overwritten with the value entered in the receiver.

Test Tone
Off ^{6*}

Test Tone menu item

In this menu item, you can activate a test tone that the transmitter transmits instead of the input signal. You can use

this feature to level out the system, for example.

- Setting range: **Off**, **-90 dB** to **0 dB** in 6 dB increments

-84 ▲
-90 dB
Off ▼

- ▷ Press the **UP** or **DOWN** button to set the desired value.
- ▷ Press the **SET** button to confirm your selection.

Mute Button
⏸ disabled ^{7*}

Mute Button menu item

In this menu item you can set the function of the transmitter's mute switch.



- Setting range:
 - **Disabled:** The mute switch has no function.
 - **RF Mute:** The RF signal is deactivated when the mute switch is on.
 - **AF Mute:** The audio signal is muted when the mute switch is on.



- ▷ Press the **UP** or **DOWN** button to set the desired value.
- ▷ Press the **SET** button to confirm your selection.

If you set a function for the transmitter's mute switch in the **Mute Mode** menu item on the receiver and then synchronize the receiving channel with the transmitter, the value entered in the transmitter is overwritten with the value entered in the receiver.



Auto Lock menu item

In this menu item, you can activate or deactivate the automatic lock-off for the transmitter.

The lock-off prevents the transmitter from being unintentionally switched off and also prevents any changes to the transmitter's menu.

If you want to change settings in the transmitter's menu while the lock-off is active, you have to temporarily disable the lock-off. See .



- ▷ Press the **UP** or **DOWN** button to set the desired value.
- ▷ Press the **SET** button to confirm your selection.

If you set a value for the transmitter's automatic lock-off in the **Auto Lock** menu item on the receiver and then synchronize the receiving channel with the transmitter, the value entered in the transmitter is overwritten with the value entered in the receiver.



Brightness menu item

In this menu item, you can adjust the brightness of the transmitter's display.

You can turn off the backlight completely or set it to one of five brightness levels.



- ▷ Press the **UP** or **DOWN** button to set the desired value.
- ▷ Press the **SET** button to confirm your selection.



LED menu item

This menu item allows you to set the behavior of the transmitter's LINK LED.

•Setting range:

- **ON**: The LINK LED remains continuously lit.
- **OFF**: The LINK LED switches off while the lock-off function is active.



- ▷ Press the **UP** or **DOWN** button to set the desired value.
- ▷ Press the **SET** button to confirm your selection.

If you set a function for the transmitter's LINK LED in the **LED** menu item on the receiver and then synchronize the receiving channel with the transmitter, the value entered



in the transmitter is overwritten with the value entered in the receiver.

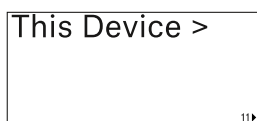

This Device menu item

In this menu item you can view information about the transmitter's software and hardware and reset the transmitter to the factory settings.

Show software

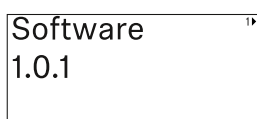

Show hardware

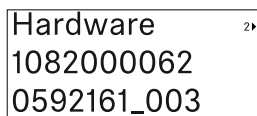

Reset to factory settings

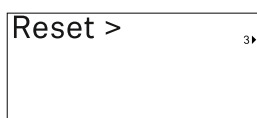

- ▷ Press the **SET** button to open the Reset menu item.

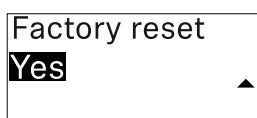
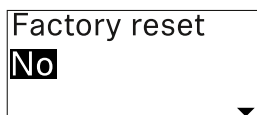

- ▷ Press the **UP** or **DOWN** button to set the desired value.
- ▷ Press the **SET** button to confirm your selection.



Lock-off function

You can enable or disable the automatic lock-off function in the **Auto Lock** menu item (see „**Auto Lock** menu item“).

The lock-off function prevents the transmitter from being unintentionally switched off and also prevents any unintentional changes to the transmitter's configuration.

If you have enabled the **Auto Lock** function, you will have to temporarily deactivate the lock-off function to operate the transmitter.

To temporarily deactivate the lock-off function:

- ▷ Press the **SET** button.
Locked appears in the display panel.
- ▷ Press the **UP** or **DOWN** button.
Unlock? appears in the display panel.
- ▷ Press the **SET** button.
Lock-off function is now temporarily deactivated.

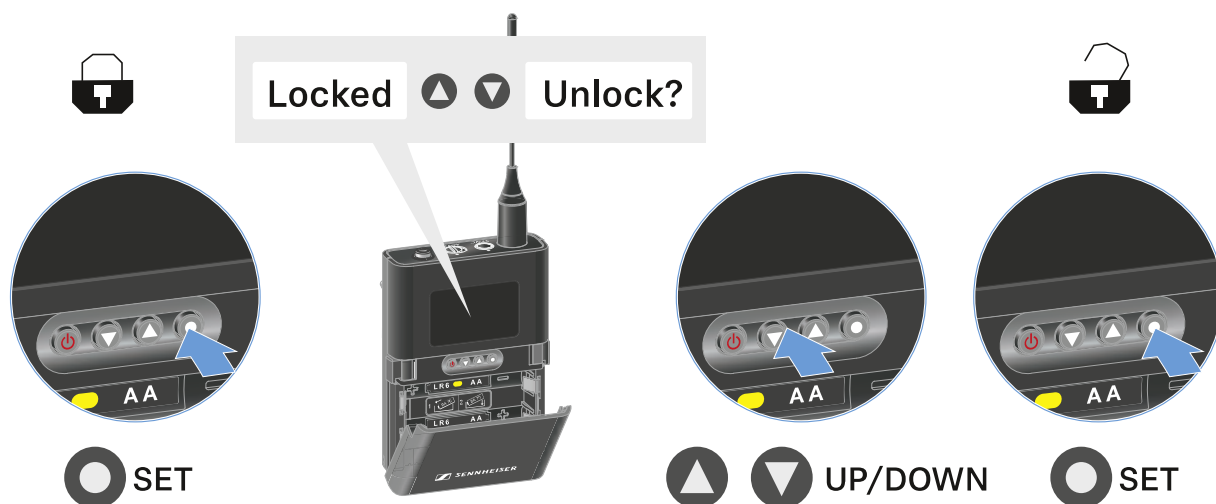

The lock-off function remains deactivated while you are actively working in the operating menu.

After 10 seconds of inactivity, it automatically activates again.



Configuring mute mode and muting the bodypack transmitter

You can mute the bodypack transmitter by using the mute switch to turn off either the audio signal (**AF Mute**) or the RF signal (**RF Mute**).

To do this, you must configure the function of the mute switch in the **Mute Mode** menu item.

- ▷ On the receiver: „Ch 1 / Ch 2 -> Mute Mode menu item“
- ▷ ON the transmitter: „**Mute Button** menu item“

AF Mute

- ▷ Slide the mute switch to the desired position to mute or activate the audio signal.

RF Mute

- ▷ Slide the mute switch to the desired position to activate or deactivate the RF signal.

Updating the firmware of the transmitter









The transmitter firmware is updated via the receiver.

- ▷ Update the transmitter firmware using the **TX Update** menu item in the receiver's System menu. See „System -> TX Update menu item“.



Establishing a radio link | Synchronizing the receiver and transmitter

Information on compatibility between EW-D and EW-DX

	EW-D EM 	EW-DX EM 2 
EW-D SKM-S  EW-D SK		
EW-DX SKM EW-DX SKM-S  EW-DX SK EW-DX SK 3-PIN		

 The transmitter and the receiver are fully compatible with each other.

 The transmitter and the receiver are compatible with each other. Some features may not be available.

Conditions and restrictions for using frequencies

There may be special conditions and restrictions for using frequencies in your country.

Before putting the product into operation, find the information for your country at the following address:
www.sennheiser.com/sifa



Connecting to the EW-D EM receiver / synchronizing the EW-D EM

To establish a radio link between the transmitter and receiver, we recommend the following procedure.

In order to establish a connection between a receiver and transmitters of the EW-D series, the devices must always be synchronized with each other.

To successfully connect a receiver and a transmitter, both devices must have the same frequency range.

Step 1: Set a free frequency

We recommend using the **AUTO SCAN** function, as this is the most reliable way to identify free frequencies (see „AUTO SCAN menu item“).

If you know free frequencies in your area, you can also set the frequency manually (see „CHANNEL menu item“ or „TUNE menu item“).

Step 2: Pairing a receiver with a transmitter

- ▷ Short-press the **SYNC** button on the receiver.
The blue **DATA** LED flashes.



- ▷ Short-press the **SYNC** button on the transmitter.
The blue **DATA** LED flashes.





The transmitter and receiver will be paired. Once the link is established, the **LINK** LED on both units will light up green.

Be sure to press the **SYNC** button on all devices only briefly (less than 2 seconds). Holding the **SYNC** button longer than this will start the firmware update mode and cancel the synchronization process.



Connecting to the EW-DX EM 2 receiver / synchronizing the EW-DX EM 2

To establish a radio link between the transmitter and receiver, we recommend the following procedure.

In order to establish a connection between a receiver and transmitters of the EW-D series, the devices do not necessarily have to be synchronized with each other.

To successfully connect a receiver and a transmitter, both devices must have the same frequency range.

Set a free frequency

We recommend using the **Auto Setup** function, as this is the most reliable way to identify free frequencies (see „Ch 1 / Ch 2 -> Scan / Auto Setup menu item“).

If you know free frequencies in your area, you can also set the frequency manually.

- ▷ EW-DX EM 2: „Ch 1 / Ch 2 -> Frequency menu item“
- ▷ EW-DX SKM(-S): „Making settings in the menu of the hand-held transmitter“
- ▷ EW-DX SK (3-PIN): „Making settings in the menu of the bodypack transmitter“

Once you have set the same frequency for the desired receiving channel on the receiver and for the transmitter you want to connect, the radio link is established.

To ensure that all settings are transmitted to the transmitter, we recommend synchronizing the transmitter with the receiving channel.



Synchronizing the receiver and transmitter

To synchronize the receiver and the transmitter:

- ▶ On the receiver, press the **CH 1** or **CH 2** button to select the channel you want to synchronize.

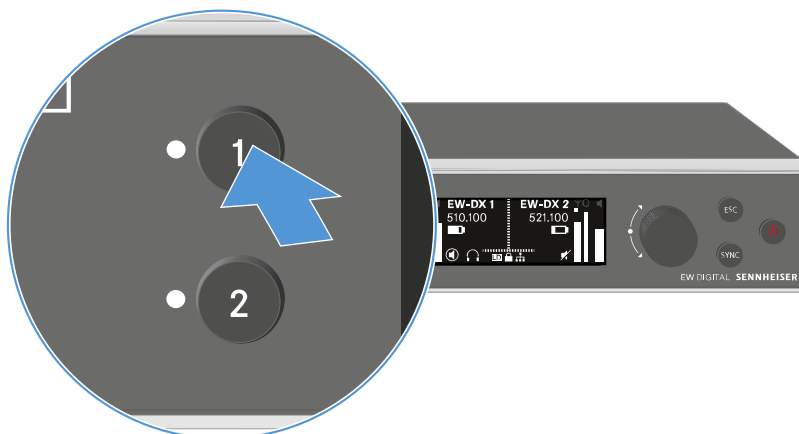

- ▶ Press the **SYNC** button on the receiver.

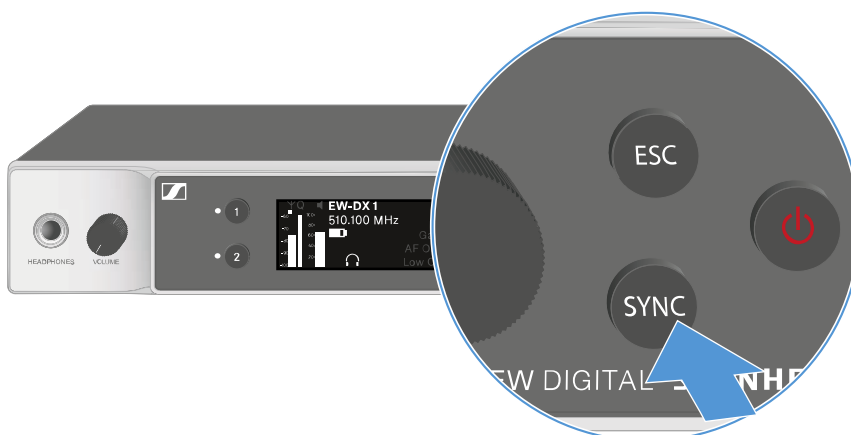

The receiver's display shows that the synchronization process has started.

The LED for the selected receiving channel flashes blue.



- ▶ Short-press the **SYNC** button on the transmitter. The blue **DATA** LED flashes.

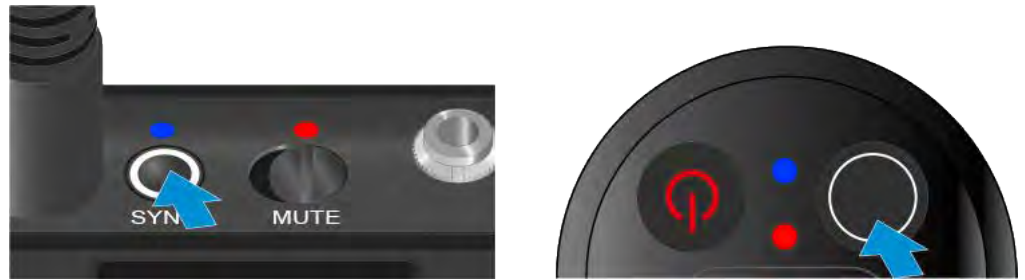

The transmitter and receiver will be synchronized.



Charging the BA 70 rechargeable battery in the L 70 USB charger

Connecting/disconnecting the charger to/from the power supply system

To connect the charger to the power supply system:

- ▷ Use only the **NT 5-20 UCW** power supply unit from Sennheiser.
- ▷ Connect the USB-C plug on the charging cable to the USB-C port on the side of the charger.
- ▷ Plug the power supply unit with the correct country adapter into a suitable power outlet.

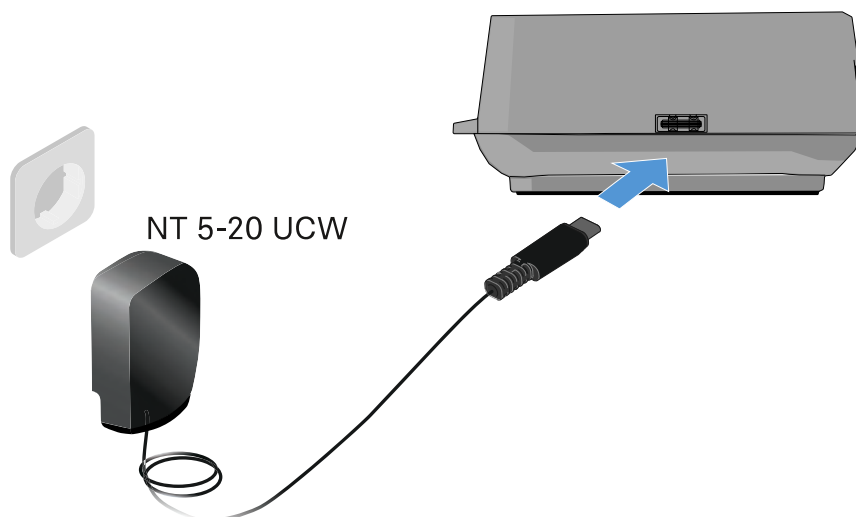

To disconnect the charger from the power supply system:

- ▷ Unplug the power supply unit from the wall socket.
- ▷ Remove the USB-C plug on the charging cable from the USB-C port on the side of the charger.



Charging the rechargeable battery





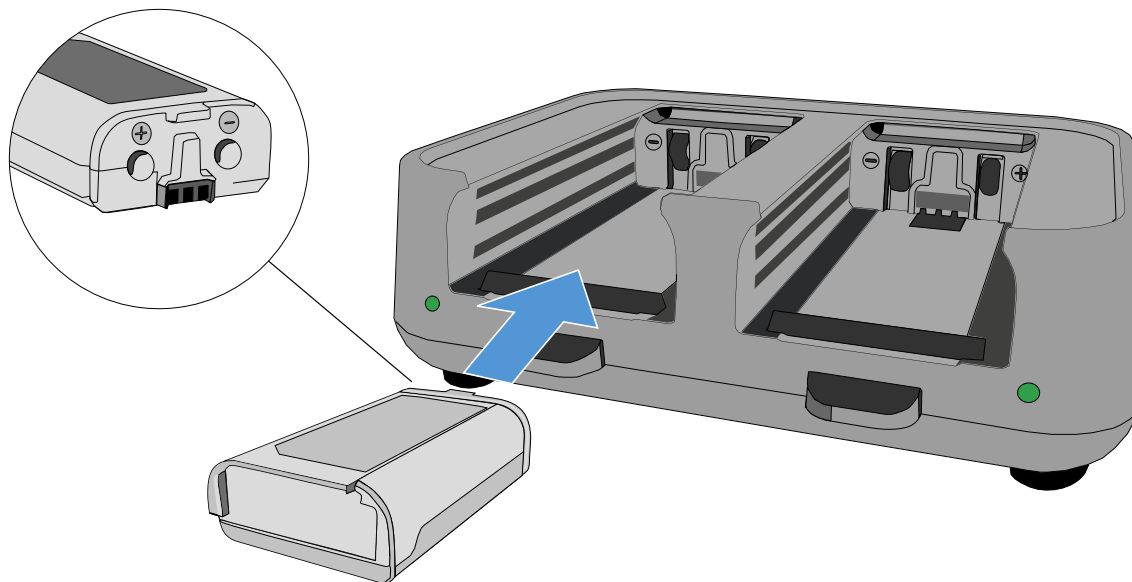

To charge the BA 70 rechargeable battery in the L 70 USB charger:

- ▶ Slide the rechargeable battery completely into the charging slot as shown in the figure.



The rechargeable battery will begin charging.

The LED on the charging slot shows the battery's charge level:

LEDs	
	100 %
	> 60 %
	> 20 %
	> 0 %
	Error



Charging the EW-DX SKM(-S) handheld transmitter, the EW-DX SK (3-PIN) bodypack transmitter or the BA 70 rechargeable battery in the CHG 70N charger

Product overview

Front



Back



- 1 Charging slots
 - See „Charging the rechargeable battery“
- 2 Status LEDs of the charging slots
 - See „Charging the rechargeable battery“
- 3 **Reset** button
 - Press to reset the device’s network settings.
 - See „Connecting a charger in a network“
- 4 **DC in** connection socket for the **NT 12-35 CS** power supply unit
 - See „Connecting/disconnecting the charger to/from the power supply system“
- 5 **PoE/Ethernet** RJ-45 socket for controlling the device over the network and for Power over Ethernet power supply
 - See „Connecting a charger in a network“
 - See „Connecting/disconnecting the charger to/from the power supply system“



Connecting/disconnecting the charger to/from the power supply system

You can operate the charger either with the Sennheiser NT 12-35 CS power supply unit or with Power over Ethernet (PoE IEEE 802.3af Class 0). Please refer to the following information.

Power from the NT 12-35 CS power supply unit

Use only the **NT 12-35 CS** power supply unit from Sennheiser. It is designed for your charger and ensures safe operation.

The power supply unit is available either separately (Sennheiser article number 508995) or together with the charger as a kit (see „CHG 70N network-enabled charger“).

To connect the charger to the power supply system:

- ▷ Connect the hollow jack plug of the power supply unit to the **DC in** socket on the charger.
- ▷ Pass the cable through the strain relief.
- ▷ Plug the power supply unit into the wall outlet using the correct power cable for your country.

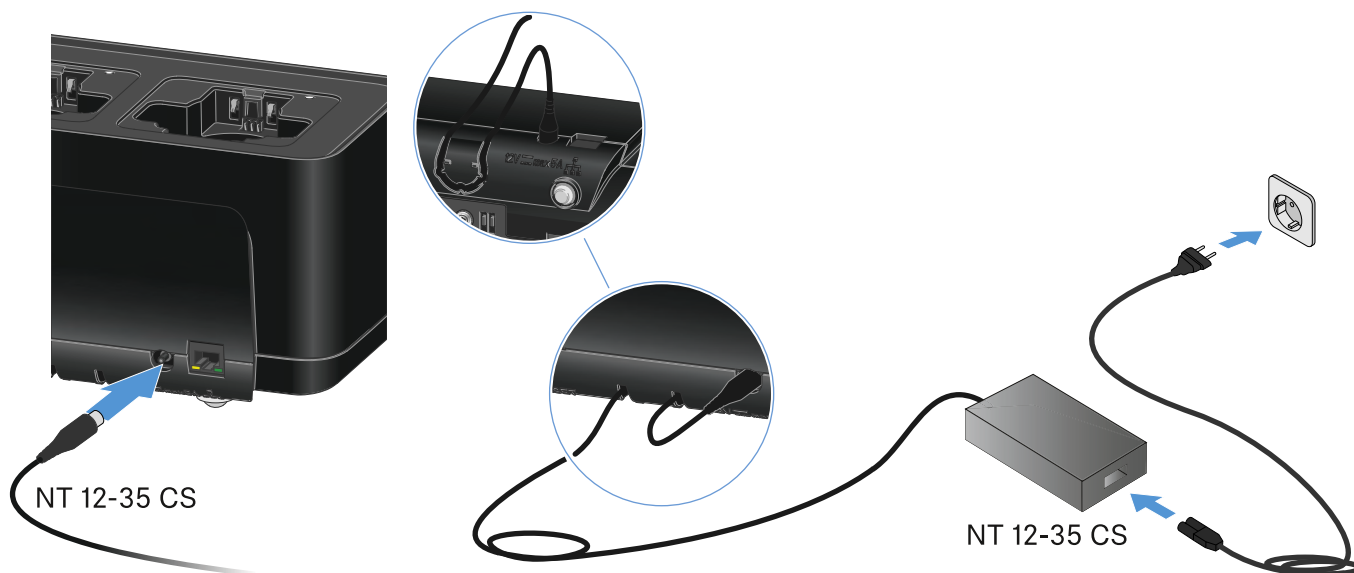

To completely disconnect the charger from the power supply system:

- ▷ Unplug the power cable from the wall socket.
- ▷ Unplug the hollow jack plug of the power supply unit from the **DC in** socket on the charger.



Power over Ethernet (PoE)

The charger can be powered via **Power over Ethernet** (PoE IEEE 802.3af Class 0).

- Connect the charger to a **PoE-enabled** network switch.

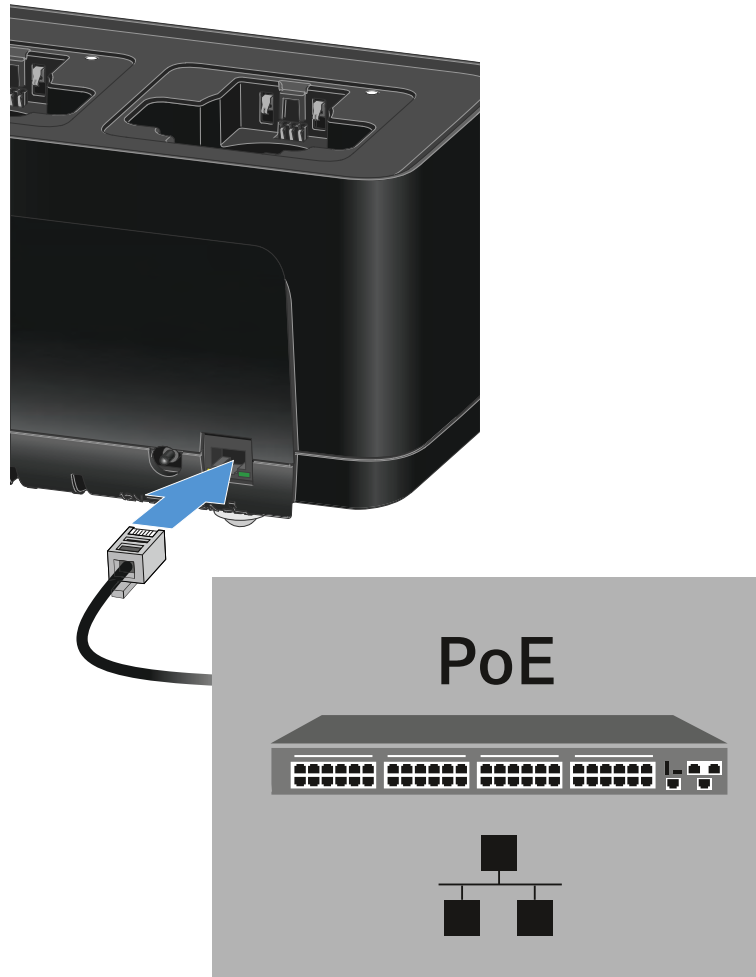



Connecting a charger in a network

You can monitor and control one or more chargers via a network connection using the **Sennheiser Wireless Systems Manager (WSM)** or **Sennheiser Control Cockpit (SCC)** software.

The network does not have to be a homogeneous network including only chargers. You can integrate the charger into your existing network infrastructure with any other types of devices.

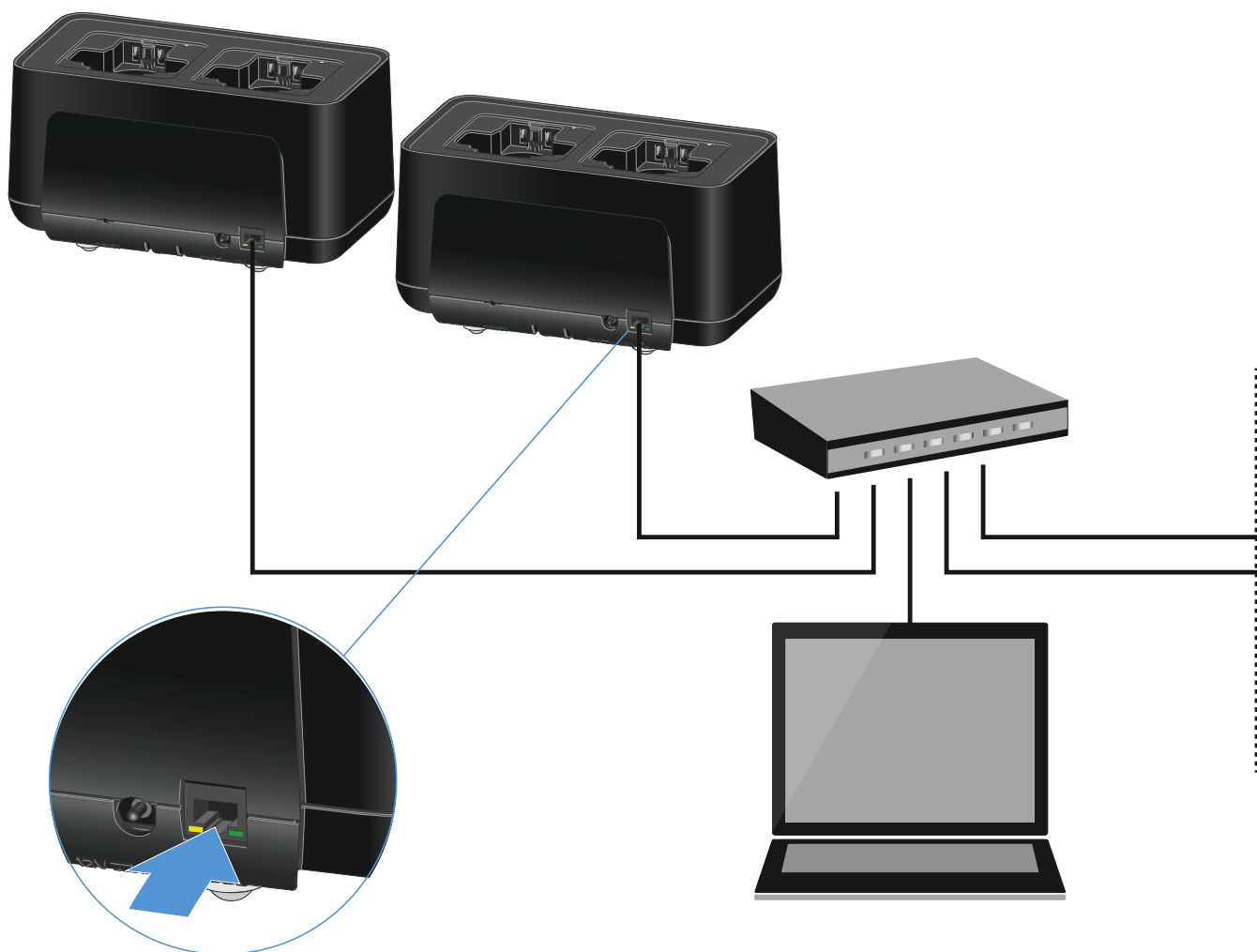

For more information about controlling devices via the Sennheiser Wireless Systems Manager or Sennheiser Control Cockpit software, refer to the instruction manual for the software. You can download the software here:
www.sennheiser.com/wsm
www.sennheiser.com/control-cockpit-software



Charging the rechargeable battery

You can use the CHG 70N charger to charge individual BA 70 rechargeable batteries, or to charge EW-DX SKM, EW-DX SKM-S, EW-DX SK or EW-DX SK 3-PIN transmitters with the BA 70 rechargeable battery already inserted.

To charge the battery:



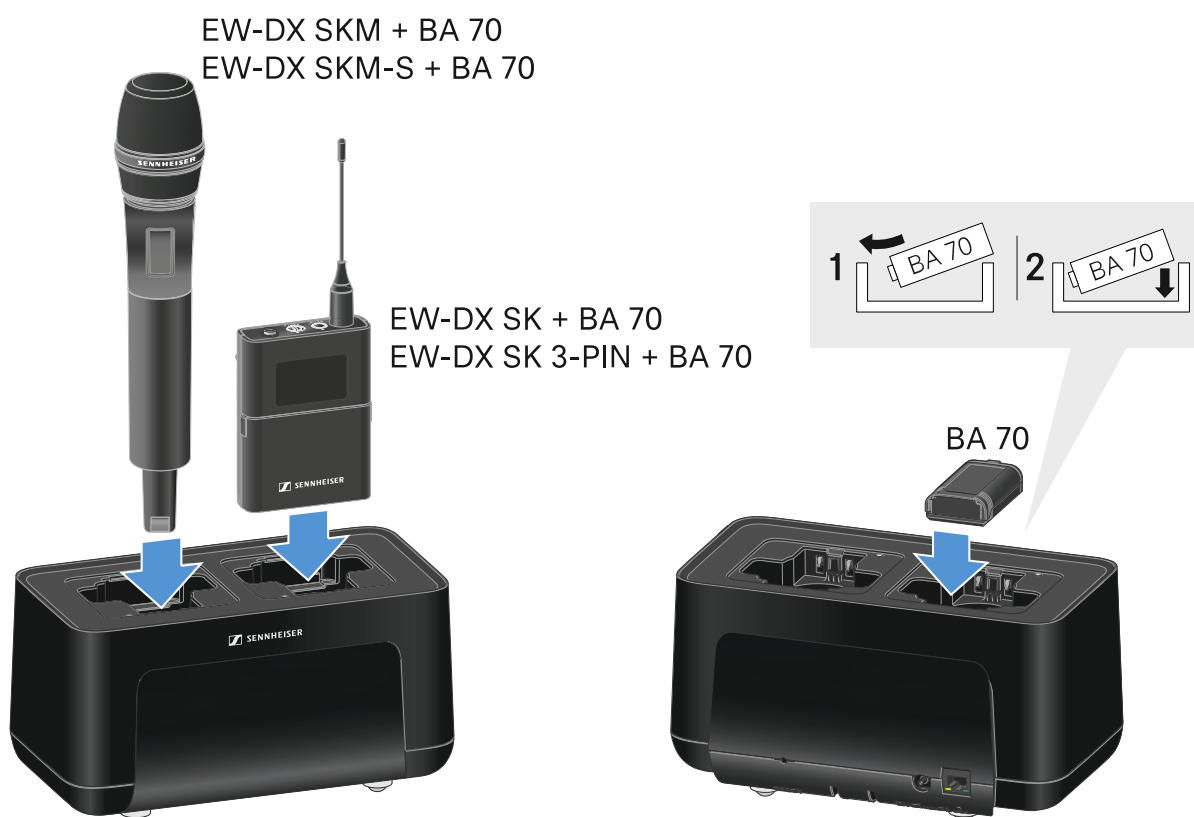



- Insert the individual rechargeable battery or the transmitter with battery already inserted into the charging slot as shown in the figure.



The rechargeable battery will begin charging.



The LED on the charging slot shows the battery's charge level.

LEDs	
	100 %
	> 60 %
	> 20 %
	> 0 %
	Error



EW-D ASA antenna splitter

Product overview

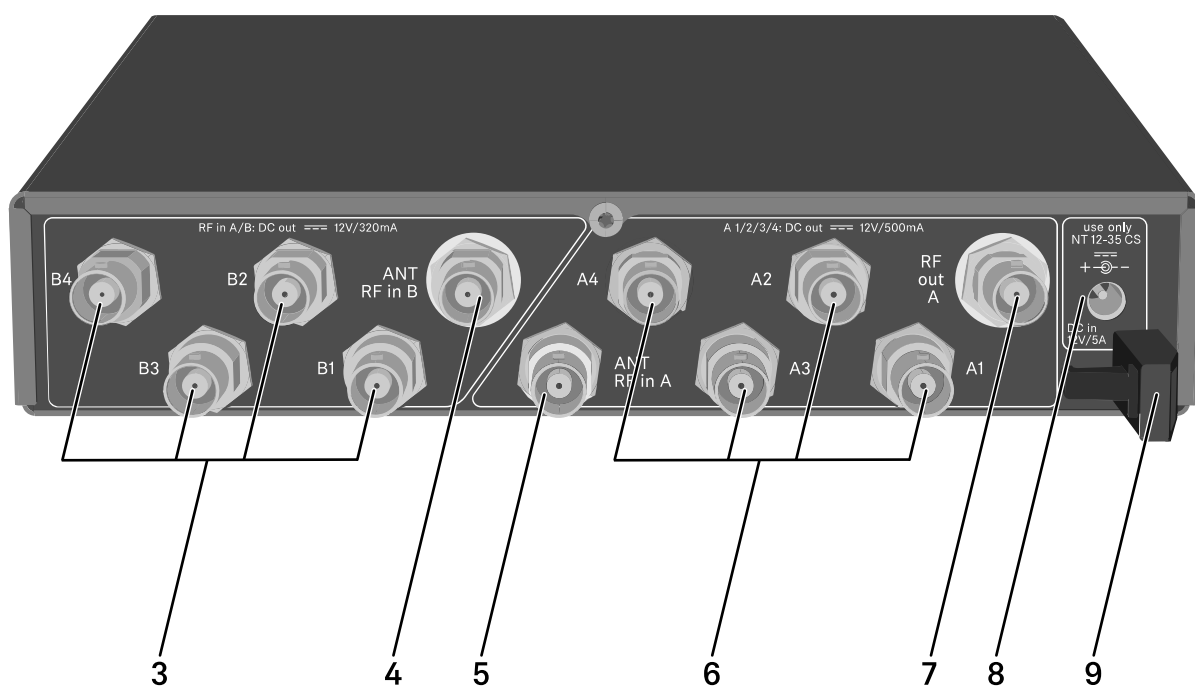

- 1 **STANDBY** button
 - See „Switching the EW-D ASA on and off“
- 2 LED: Operation indicator
 - See „Switching the EW-D ASA on and off“



- 3 4 BNC sockets **B1** to **B4**
 - RF outputs of diversity branch B for connection to the receiver
 - See „Connecting receivers to the EW-D ASA“
- 4 **ANT RF IN B** BNC socket
 - Antenna input of diversity branch B
 - See „Connecting antennas“
- 5 **ANT RF IN A** BNC socket
 - Antenna input of diversity branch A
 - See „Connecting antennas“
- 6 4 BNC sockets **A1** to **A4**
 - RF outputs of diversity branch A for connection to the receiver
 - Each one of these RF outputs can also provide power to an EW-D EM receiver
 - See „Connecting receivers to the EW-D ASA“
- 7 **RF OUT A** BNC socket
 - RF output only for connecting an additional ASA 214 to build an 8-channel diversity system
 - See „Configuring multi-channel systems“
- 8 **DC in** socket
 - To connect the NT 12-35 CS power supply unit
 - See „Connecting/disconnecting the EW-D ASA to/from the power supply system“
- 9 Strain relief for the connection cable of the power supply unit
 - See „Connecting/disconnecting the EW-D ASA to/from the power supply system“

Connecting/disconnecting the EW-D ASA to/from the power supply system

To supply power to the EW-D ASA, the connected receivers (EW-D EM only) and any antenna amplifiers used, you will need the NT 12-35 CS power supply unit.

Use only the supplied NT 12-35 CS power supply unit. It is designed for your antenna splitter and ensures safe operation.

To connect the EW-D ASA antenna splitter to the power supply system:



- ▷ Plug the hollow jack plug of the power supply unit into the **DC in** socket of the antenna splitter.
- ▷ Pass the cable of the power supply unit through the strain relief.
- ▷ Connect one end of the power cord to the power supply unit and the other end to the wall socket.

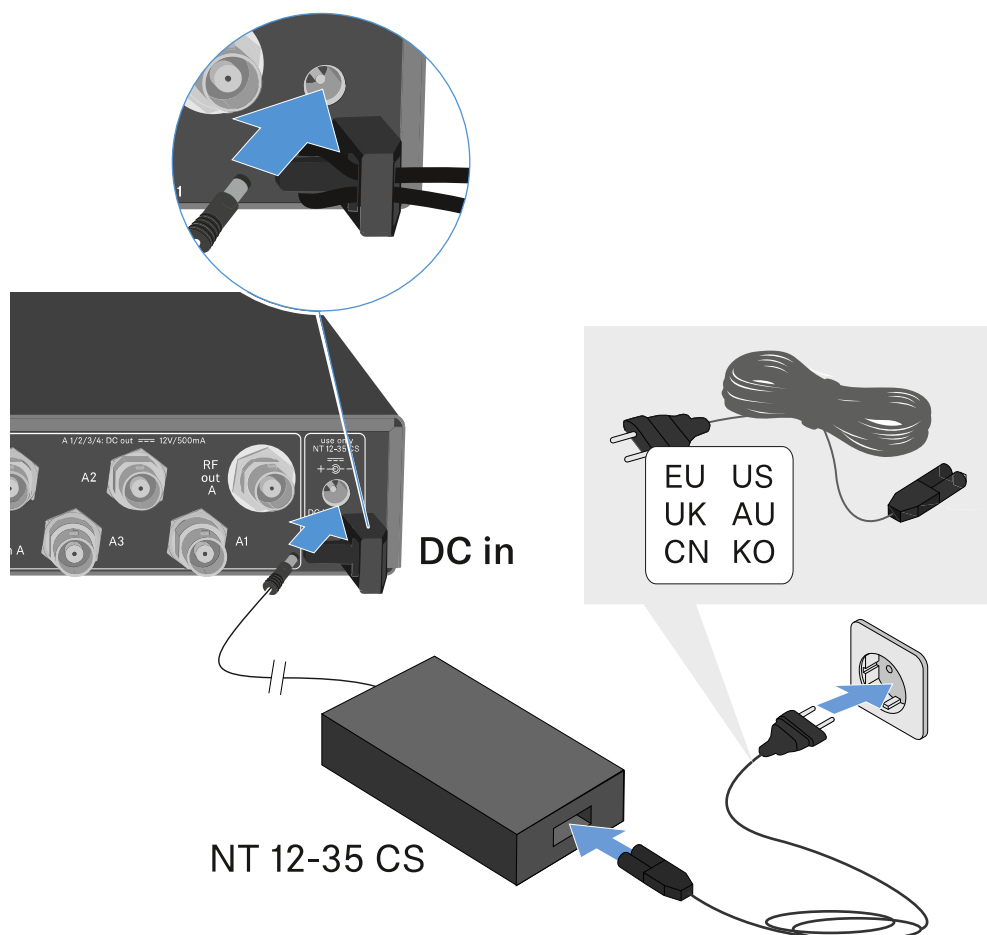

To completely disconnect the EW-D ASA antenna splitter from the power supply system:

- ▷ Unplug the power cable from the wall socket.
- ▷ Unplug the hollow jack plug of the power supply unit from the **DC in** socket of the antenna splitter.



Connecting receivers to the EW-D ASA

You can connect and operate up to four EW-D EM or EW-DX EM 2 rack receivers with the EW-D ASA.

To connect the receivers to the EW-D ASA antenna splitter:

- ▷ Connect one of the receiver's antenna inputs to one of the BNC sockets **A1** to **A4** using one of the supplied BNC cables.

The **EW-D EM** receivers do not require their own power supply. They are powered via the BNC sockets **A1** to **A4**.

The **EW-DX EM 2** receivers cannot be supplied with power via the BNC sockets. They need to be powered by the included power supply unit or by PoE.

- ▷ Connect the receiver's other antenna input to one of the BNC sockets **B1** to **B4** using one of the supplied BNC cables.

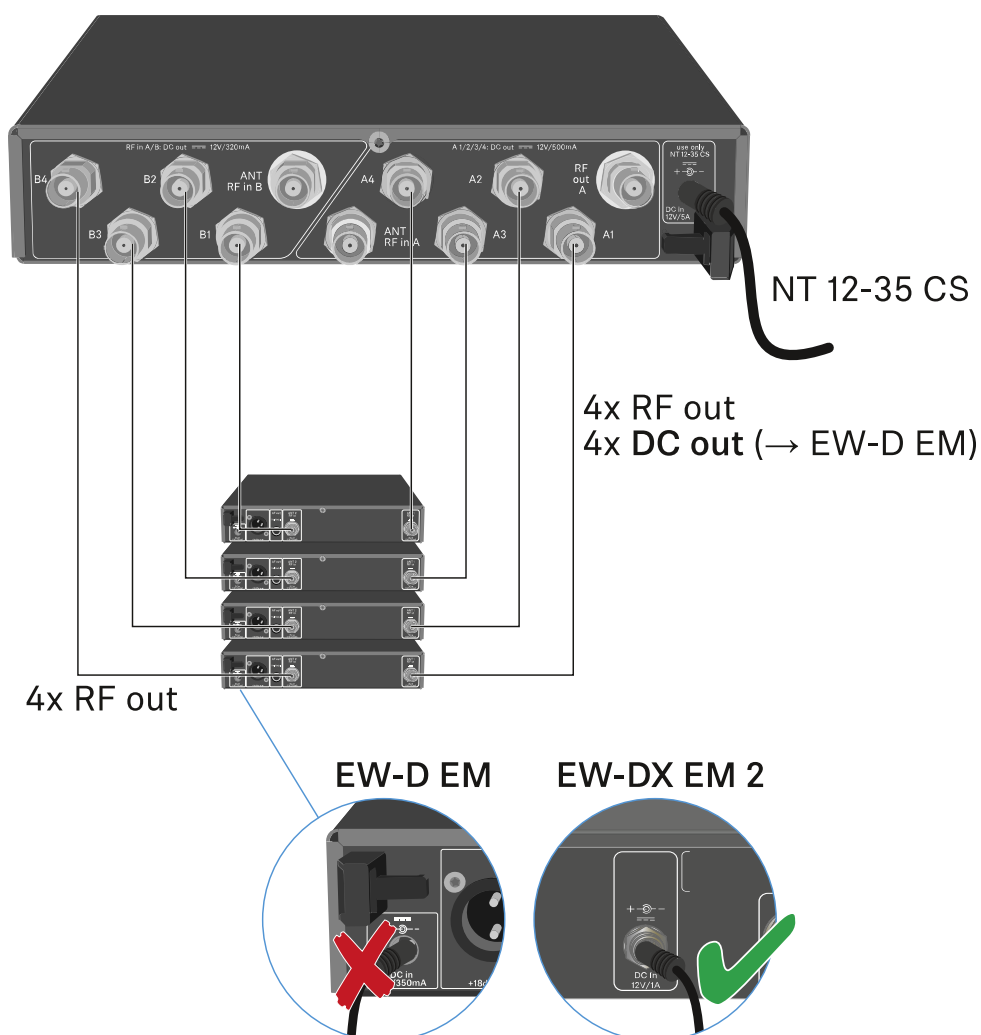



Connecting antennas

To ensure optimal reception even in the case of poor reception conditions, we recommend using remote antennas.

Connecting remote antennas

- ▷ Mount an antenna each or a combination of an antenna and an antenna amplifier to the BNC sockets **ANT RF IN A** and **ANT RF IN B**.
- ▷ Refer to the instructions under „Information on antenna amplifiers and cable lengths“.

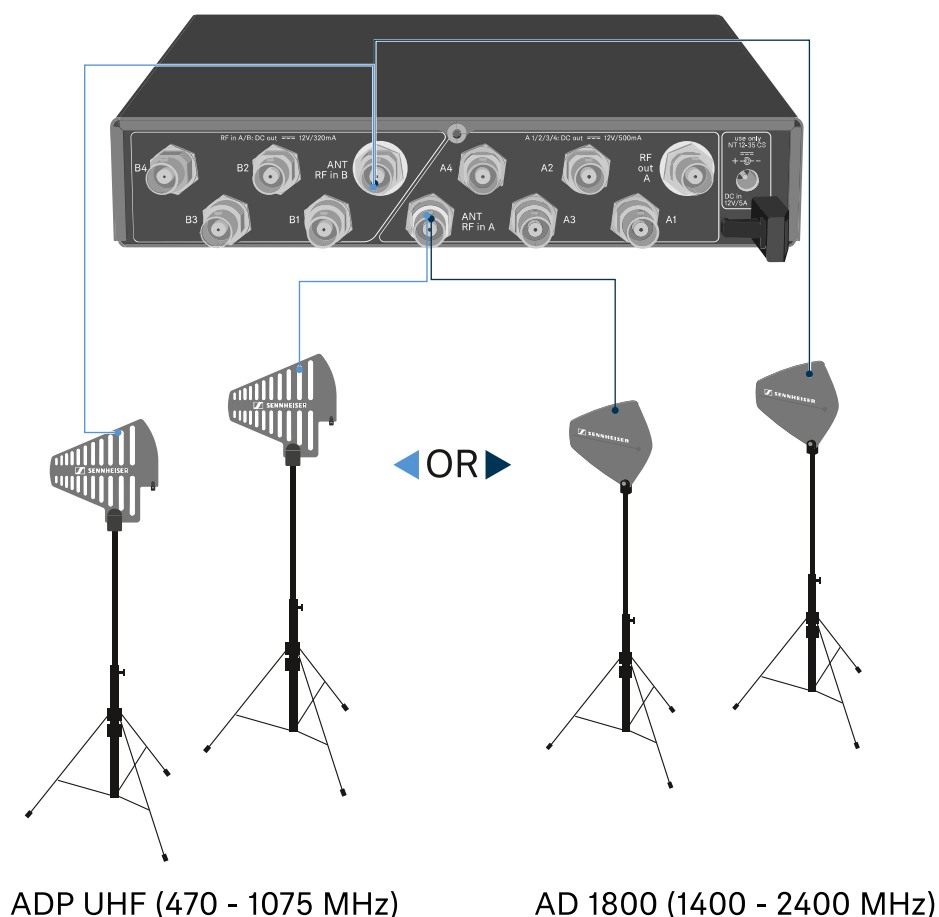



Connecting rod antennas

- ▷ Mount the antennas to the BNC sockets **ANT RF IN A** and **ANT RF IN B**.
- ▷ Align the antennas in a V-shape in order to ensure the best possible reception.

Information on antenna amplifiers and cable lengths

The following table shows which cable lengths require the use of the **EW-D AB** antenna amplifier as well as the maximum recommended cable lengths.

دردر (تقريباً) aprox.	EW-D AB	Cable lengths in meters Cables	
		RG 58	GZL 5000
500 MHz	0	8 m	16 m
	1	36 m	72 m
	2	64 m	128 m
700 MHz	0	7 m	14 m
	1	30 m	60 m
	2	53 m	106 m
900 MHz	0	6 m	12 m
	1	26 m	52 m
	2	46 m	92 m
1800 MHz	0	4 m	8 m
	1	16 m	32 m

Frequency variants of the EW-D AB: „EW-D AB antenna booster“



Configuring multi-channel systems

The following options for connecting multi-channel systems are possible:

Option 1: Two antennas supply a 4-channel system

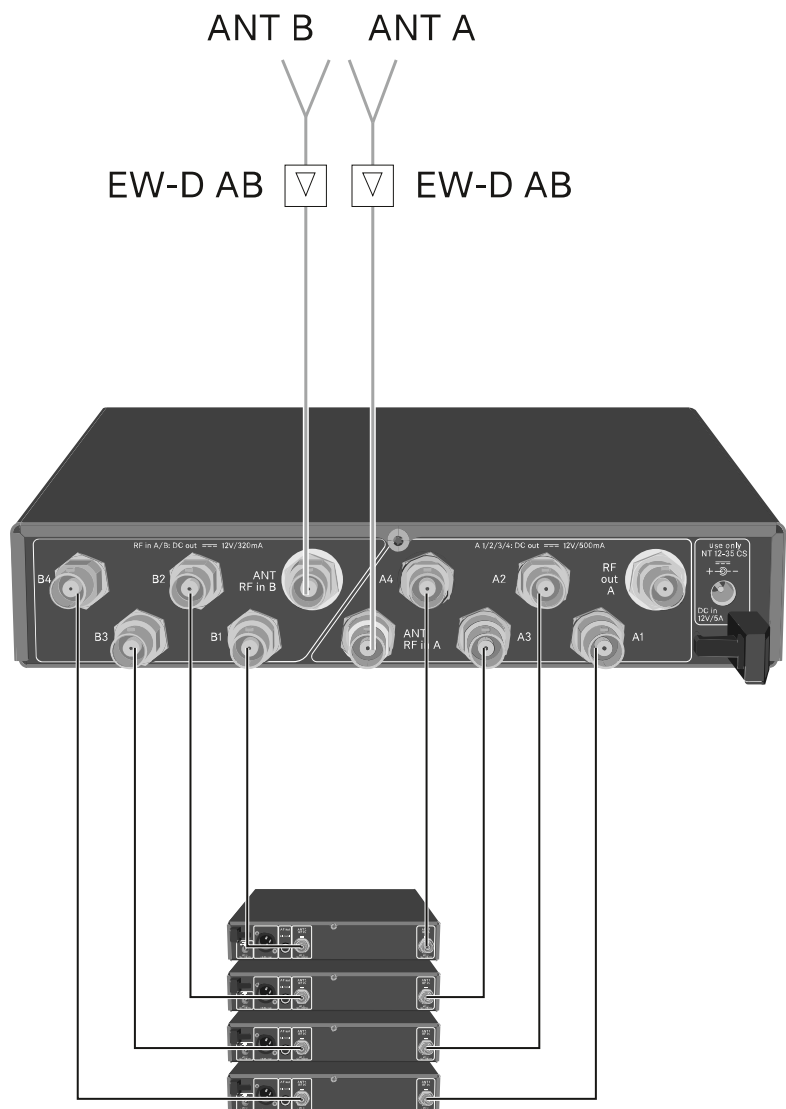



Option 2: Two 4-channel systems are interconnected

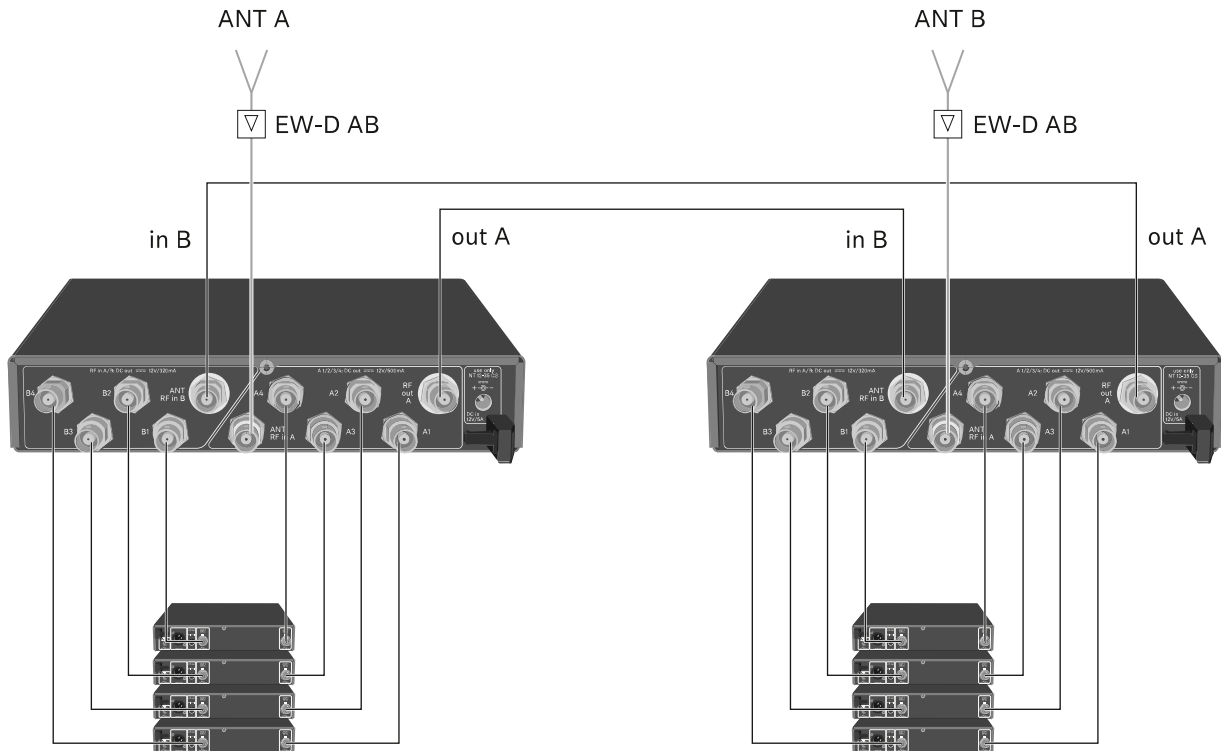



Option 3: Two antennas supply a 8-channel system

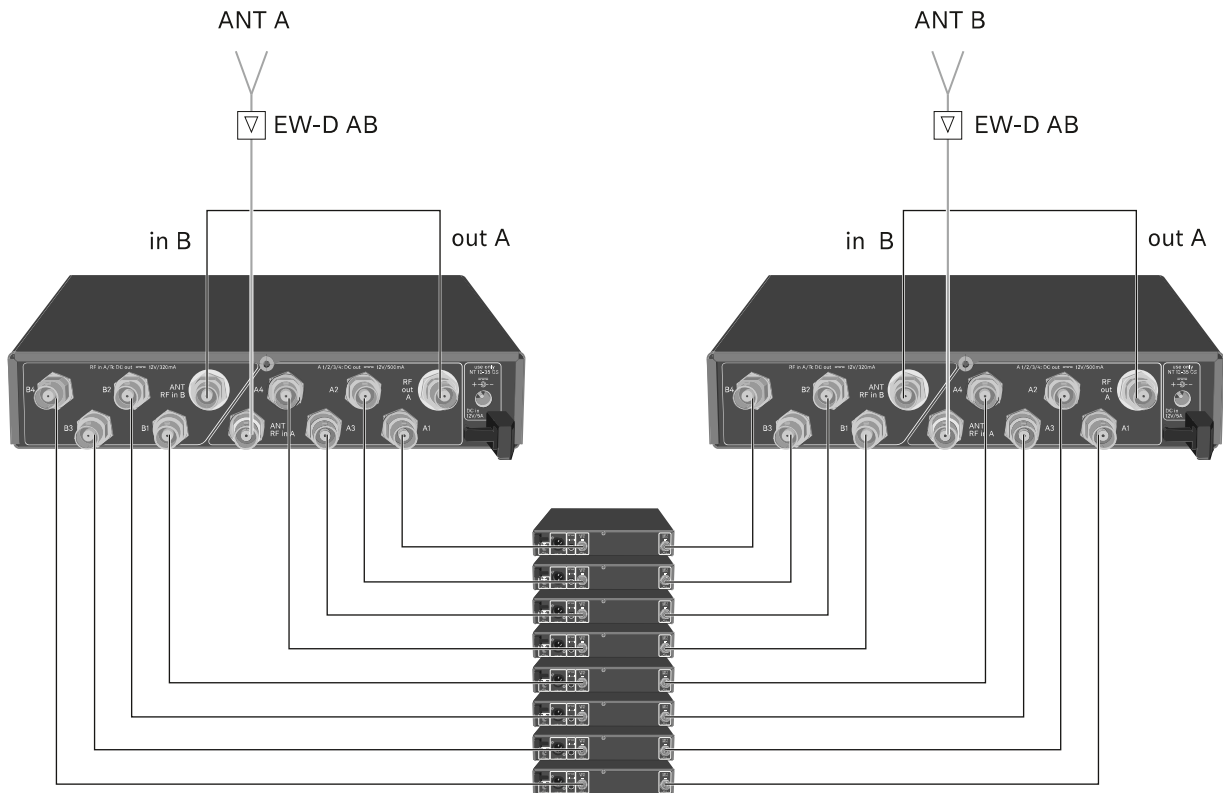



Installing the EW-D ASA in a rack

ATTENTION

Rack mounting poses risks

When installing the device in a closed 19" rack or multi-rack assembly, please consider that, during operation, the ambient temperature, the mechanical load and the electrical potentials will be different from those of devices which are not mounted into a rack.

- ▷ Make sure that the ambient temperature within the rack does not exceed the permissible temperature limit stated in the specifications. See „SPECIFICATIONS“.
- ▷ Ensure sufficient ventilation; if necessary, provide additional ventilation.
- ▷ Make sure that the mechanical load of the rack is even.
- ▷ When connecting to the power supply system, observe the information indicated on the type plate. Avoid overloading the circuits. If necessary, provide overcurrent protection.
- ▷ When mounting in a rack, please note that intrinsically harmless leakage currents of the individual power supply units may accumulate, thereby exceeding the permissible limit value. As a remedy, ground the rack via an additional ground connection.

To mount the antenna splitter in a rack, you will need the GA 3 rack mount kit (optional accessory).

Rack mounting is carried out in the same way as for the EW-D EM receiver: „Installing receivers in a rack“.



Switching the EW-D ASA on and off

To switch on the antenna splitter:

- ▷ Short-press the **STANDBY** button.
The antenna splitter switches on and the power LED turns green.
The RF signals of the connected antennas are distributed to all connected receivers.



To switch the antenna splitter to [standby mode](#):

- ▷ Press the **STANDBY** button for approx. 2 seconds.
The LED turns off. The connected antenna amplifiers are switched off. Connected receivers are switched off if they draw their supply voltage from the BNC sockets A1 to A4 (see „Connecting receivers to the EW-D ASA“).

To [fully switch off](#) the antenna splitter:

- ▷ Disconnect the antenna splitter from the power supply system by unplugging the power supply unit from the wall socket.
The LED turns off.



Cleaning and maintenance

Note the following information when cleaning and maintaining products of the Evolution Wireless Digital series.

ATTENTION

Liquids can damage the products' electronics.

Liquids entering the product housing can cause a short-circuit and damage the electronics.

- ▷ Keep all liquids away from the products.
- ▷ Do not use any solvents or cleansing agents.
- ▷ Disconnect the products from the power supply system and remove rechargeable batteries and batteries before you begin cleaning.
- ▷ Clean all products only with a soft, dry cloth.
- ▷ Note the special cleaning instructions below for the following products.

Cleaning the sound inlet basket of the microphone module

- ▷ Unscrew the top sound inlet basket from the microphone module by turning it counterclockwise.
- ▷ Remove the foam insert.



You can clean the sound inlet basket in two ways:

- Use a slightly damp cloth to clean the top sound inlet basket from the inside and outside.
- Use a brush and rinse with clean water.
- ▷ If necessary, clean the foam insert with a mild detergent or replace the foam insert.
- ▷ Dry the top sound inlet basket and foam insert.



- ▷ Reinsert the foam insert.
- ▷ Screw the sound inlet basket back onto the microphone module.

From time to time, you should also clean the microphone module contacts:

- ▷ Wipe the contacts of the microphone module with a soft, dry cloth.

Clean the transmitter's contacts.

- ▷ Wipe the contacts with a dry cloth.

Cleaning the L 70 USB and CHG 70N chargers

- ▷ Remove all rechargeable batteries from the charging slots.
- ▷ Disconnect the charger from the power supply system before cleaning.
- ▷ Clean the product with a dry cloth.
- ▷ In addition, use a brush to remove dust from the charging slots.
- ▷ Clean the charging contacts from time to time with a cotton swab, for instance.



FREQUENTLY ASKED QUESTIONS

This section contains answers to frequently asked questions and further information about the following topics:

„Radio and frequencies“

„Audio“

„Usability“

„Accessories“

„EW-D Smart Assist app“



Radio and frequencies

Why won't my transmitter synchronize with my receiver?

- Briefly press the SYNC button on both devices, but don't press too long („Establishing a radio link | Synchronizing the receiver and transmitter“)
- The two devices must have the same frequency range („Frequency ranges“)

What is the transmission range of the transmitter?

- Up to 100 m in an ideal environment (without obstacles)

What is the best way to wear the bodypack transmitter?

- Do not kink, bend or cover the antenna
- Avoid skin contact with the antenna
- If possible, attach it to your clothing with the belt clip

How do I know which transmitter is coupled to which receiver?

- EW-D SKM-S: „Identifying the paired receiver (Identify function)“
- EW-D SK: „Identifying the paired receiver (Identify function)“
- EW-DX SKM(-S): „Identifying the paired receiver (Identify function)“
- EW-DX SK (3-PIN): „Identifying the paired receiver (Identify function)“
- Additional option: use color coding („Using EW-D Color Coding Sets to label transmission paths“)

How can I distinguish between my wireless links without displays on the transmitters?

- EW-D SKM-S: „Identifying the paired receiver (Identify function)“
- EW-D SK: „Identifying the paired receiver (Identify function)“
- Additional option: use color coding („Using EW-D Color Coding Sets to label transmission paths“)



The transmitter and receiver are synchronized, but there is no connection.

- Install antennas correctly on the receiver (EW-D EM: „Connecting antennas“ | EW-DX EM 2: „Connecting antennas“)
- EW-D: Use the scan function to find a free channel („AUTO SCAN menu item“) and synchronize the transmitter again („Establishing a radio link | Synchronizing the receiver and transmitter“)
- EW-DX: Using the Auto Setup function, find a free channel („Ch 1 / Ch 2 -> Scan / Auto Setup menu item“) and resynchronize the transmitter („Establishing a radio link | Synchronizing the receiver and transmitter“)

The display on the receiver shows radio levels even though the paired transmitter is not switched on.

- There may be interfering frequencies (e.g. TV channels)
- EW-D: Use the scan function to find a free channel („AUTO SCAN menu item“) and synchronize the transmitter again („Establishing a radio link | Synchronizing the receiver and transmitter“)
- EW-DX: Using the Auto Setup function, find a free channel („Ch 1 / Ch 2 -> Scan / Auto Setup menu item“) and resynchronize the transmitter („Establishing a radio link | Synchronizing the receiver and transmitter“)

Which frequency ranges are available?

- „Frequency ranges“



Audio

Which microphones can I use with my bodypack transmitter?

- EW-D SK: „Connecting a microphone to the bodypack transmitter“
- EW-DX SK (3-PIN): „Connecting a microphone to the bodypack transmitter“

Which microphone modules can I use with my handheld transmitter?

- EW-D SKM-S: „Replacing the microphone module“
- EW-DX SKM(-S): „Replacing the microphone module“

What exactly do the “Gain” and “AF Out” settings do?

- Gain: level of the audio signal coming from the transmitter („GAIN menu item“)
- AF Out: level of the audio signal coming out of the receiver („AF OUT menu item“)

How do I adjust the settings so that my wireless link has the same volume as my guitar cable?

- EW-D: Configure **unity gain** settings under the menu items **GAIN** (volume that reaches the receiver from the guitar through the bodypack transmitter – „GAIN menu item“) and **AF OUT** (volume output from the receiver to the guitar amplifier – „AF OUT menu item“).

Possible **unity gain** settings (depending on the level of the incoming signal):

- ▷ **AF Out 18 dB | Gain 27 dB**
 - ▷ **AF Out 12 dB | Gain 33 dB**
 - ▷ **AF Out 6 dB | Gain 39 dB**
-



How can I adjust sensitivity on the transmitter?

- EW-D: You cannot make any settings on the transmitter. You can adjust the level of the signal coming from the transmitter under the **GAIN** menu item („GAIN menu item“) on the receiver.
- EW-DX: In addition to the gain that is set in the receiver („Ch 1 / Ch 2 -> Gain menu item“), you can also set the trim on the transmitter (EW-DX SKM(-S): „**Trim** menu item“ | EW-DX SK (3-PIN): „**Trim** menu item“) to adjust the sensitivity to the incoming audio signal.

What is the latency?

- 1.9 ms

Which audio outputs are available on the receiver?

- XLR-3 and 6.3 mm jack (EW-D EM: „Outputting audio signals“ | EW-DX EM 2: „Outputting audio signals“)



Usability

Why won't my transmitter synchronize with my receiver?

- Briefly press the SYNC button on both devices, but don't press too long („Establishing a radio link | Synchronizing the receiver and transmitter“)
- The two devices must have the same frequency range („Frequency ranges“)

Is there a way to check the battery status of the transmitter other than on the receiver?

- The Check function allows you to check the battery status on the transmitter.
- EW-D SKM-S: „Checking the battery status of the transmitter (Check function)“
- EW-D SK: „Checking the battery status of the transmitter (Check function)“

How do I know if my transmitter is switched on?

- The transmitter's **LINK LED** lights up.
- EW-D SKM-S: „Meaning of the LEDs“
- EW-D SK: „Meaning of the LEDs“
- EW-DX SKM(-S): „Meaning of the LEDs“
- EW-DX SK (3-PIN): „Meaning of the LEDs“

My LINK LED is steady or flashing yellow. What does that mean?

- EW-D EM: „Meaning of the LEDs“
- EW-D SKM-S: „Meaning of the LEDs“
- EW-D SK: „Meaning of the LEDs“
- EW-DX EM 2: „Meaning of the LEDs“
- EW-DX SKM(-S): „Meaning of the LEDs“
- EW-DX SK (3-PIN): „Meaning of the LEDs“



My LINK LED is steady or flashing red. What does that mean?

- EW-D EM: „Meaning of the LEDs“
- EW-D SKM-S: „Meaning of the LEDs“
- EW-D SK: „Meaning of the LEDs“
- EW-DX EM 2: „Meaning of the LEDs“
- EW-DX SKM(-S): „Meaning of the LEDs“
- EW-DX SK (3-PIN): „Meaning of the LEDs“

Can I also operate an EW-D with desktop applications such as WSM or Control Cockpit?

- No, that is not possible.

Can I also operate an EW-DX with desktop applications such as WSM or Control Cockpit?

- Yes, the EW-DX can be operated with WSM and the Control Cockpit („Connecting receivers in a network“).

Is the EW-D Smart Assist app necessary to operate my devices?

- No, every device can also be operated without the EW-D Smart Assist app. However, the app offers certain advantages (see „EW-D Smart Assist app“).

Can the transmitter and receiver connect to other Bluetooth-capable systems?

- A Bluetooth connection can only be established between a receiver and a smartphone with the EW-D Smart Assist app installed.

How can I turn on my transmitter without it transmitting immediately?

- Press and hold the **SYNC** button and then short-press the **ON/OFF** button (EW-D SKM-S: „Product overview“ / EW-D SK: „Product overview“)



Can the ew G4 and EW-D series be operated together?

- The products in the **ew G4** and **EW-D** series are not compatible with each other. However, you can operate the two series in parallel without any problems.

Are the receivers and transmitters of the EW-D and EW-DX series compatible?

- „Information on compatibility between EW-D and EW-DX“

How can I distinguish between my wireless links without displays on the transmitters?

- EW-D SKM-S: „Identifying the paired receiver (Identify function)“
- EW-D SK: „Identifying the paired receiver (Identify function)“
- Additional option: use color coding („Using EW-D Color Coding Sets to label transmission paths“)

What exactly do the “Gain” and “AF Out” settings do?

- Gain: Level of the audio signal coming from the transmitter (EW-D EM: „GAIN menu item“ | EW-DX EM 2: „Ch 1 / Ch 2 -> Gain menu item“)
- AF Out: Level of the audio signal coming from the receiver (EW-D EM: „AF OUT menu item“ | EW-DX EM 2: „Ch 1 / Ch 2 -> AF Out menu item“)

What is the meaning of the Bluetooth icon on the receiver’s display?

- The receiver is paired to a smartphone, so you can make settings via the EW-D Smart Assist app.
- „Displays on the receiver’s display panel“
- „EW-D Smart Assist app“

I don’t want a smartphone to have access to my receiver.

- Disconnect the Bluetooth pairing in your smartphone’s menu.

**What is the best way to wear the bodypack transmitter?**

- Do not kink, bend or cover the antenna
- Avoid skin contact with the antenna
- If possible, attach it to your clothing with the belt clip

Can you rotate the bodypack transmitter's belt clip so that the antenna points downward?

- Yes, see „Changing the belt clip“



Accessories

Which microphones can I use with my bodypack transmitter?

- EW-D SK: „Connecting a microphone to the bodypack transmitter“
- EW-DX SK (3-PIN): „Connecting a microphone to the bodypack transmitter“

Which microphone modules can I use with my handheld transmitter?

- EW-D SKM-S: „Replacing the microphone module“
- EW-DX SKM(-S): „Replacing the microphone module“

Which batteries can I use for my transmitter?

- 2 x AA 1.5 V
or
- Sennheiser BA 70 rechargeable battery („BA 70 rechargeable battery and L 70 USB charger“)
- EW-D SKM-S: „Inserting and removing the batteries/rechargeable batteries“
- EW-D SK: „Inserting and removing the batteries/rechargeable batteries“
- EW-DX SKM(-S): „Inserting and removing the batteries/rechargeable batteries“
- EW-DX SK (3-PIN): „Inserting and removing the batteries/rechargeable batteries“

Can I use accessories that I already have from other microphone series?

- You can use passive devices without a power supply (e.g. AD 1800 or A 1031-U antennas).
- You may already have compatible microphones or microphone modules:
 - EW-D SK: „Connecting a microphone to the bodypack transmitter“
 - EW-DX SK (3-PIN): „Connecting a microphone to the bodypack transmitter“
 - EW-D SKM-S: „Replacing the microphone module“
 - EW-DX SKM(-S): „Replacing the microphone module“



- We always recommend using the accessories that are optimized for the EW-D: „Accessories“.

Which antennas can I use with my receiver?

- In principle, you can use all antennas with BNC connectors that cover the frequency ranges of the EW-D series („Frequency ranges“)
- Recommended: „Antennas“

What are the advantages of the Half Wave Dipole rod antennas (available as accessories) compared to the shorter rod antennas included with delivery?

- The **Half Wave Dipole** rod antennas have a higher antenna gain and therefore provide greater transmission range in low-scatter and low-reflection environments („Rod antennas“).

My set is missing the power supply unit and the rack mounting bracket.

- Take out the packaging insert.



EW-D Smart Assist app

Is the EW-D Smart Assist app necessary to operate my devices?

- No, every device can also be operated without the EW-D Smart Assist app. However, the app offers certain advantages (see „EW-D Smart Assist app“).

I want to see if the app is right for me before registering. Where can I get more information?

- In the app's demo mode or on the website:

<https://www.sennheiser.com/evolution-wireless-digital-app>

In which languages is the app available?

- English
- German
- French
- Spanish
- Portuguese
- Russian
- Chinese
- Korean
- Arabic

Can I pair multiple smartphones with a single receiver?

- No, you can pair only one smartphone with the receiver.

How many devices can I operate with my app?

- Up to 16 channels

How do I create a setup with 2 or more devices?

- Use the **Add Device** and **Auto Scan** functions. The app will lead you step by step through the process.

**Can I set a specific frequency range for the Auto Scan function?**

- No, the function scans the entire available frequency spectrum.

Why can't I access a receiver?

- The receiver may be switched off or out of Bluetooth range.

How are the app and the receivers connected to the app secured against possible misuse?

- To pair a receiver and a smartphone, both devices must be physically present. Only after successful pairing can values in the receiver be changed via the smartphone.

Can I use a Bluetooth dongle to operate the app on a computer?

- No. The app is only available for iOS and Android.

How can I display the app on a larger screen?

- You can use a mirroring service such as QuickTime. However, you still control the app from the smartphone.



SPECIFICATIONS

System

Audio-Link EW-D frequency ranges

- **Q1-6:** 470.2 – 526 MHz
- **R1-6:** 520 – 576 MHz
- **R4-9:** 552 – 607.8 MHz
- **S1-7:** 606.2 – 662 MHz
- **S4-7:** 630 – 662 MHz
- **S7-10:** 662 – 693.8 MHz
- **U1/5:** 823.2 – 831.8 MHz & 863.2 – 864.8 MHz
- **V3-4:** 925.2 – 937.3 MHz
- **Y1-3:** 1785.2 – 1799.8 MHz

Audio-Link EW-DX frequency ranges

- **Q1-9:** 470.2 – 550 MHz
- **R1-9:** 520 – 607.8 MHz
- **S1-10:** 606.2 – 693.8 MHz
- **S2-10:** 614.2 – 693.8 MHz
- **S4-10:** 630 – 693.8 MHz
- **U1/5:** 823.2 – 831.8 MHz & 863.2 – 864.8 MHz
- **V3-4:** 925.2 – 937.3 MHz
- **V5-7:** 941.7 – 951.8 MHz & 953.05 – 956.05 MHz & 956.65 – 959.65 MHz
- **Y1-3:** 1785.2 – 1799.8 MHz

Bluetooth® Low Energy (BLE) frequency range

2402 – 2480 MHz

Audio frequency response

20 Hz – 20 kHz (-3 dB) @ 3 dBfs

Audio THD

≤ -60 dB for 1 kHz @ -3 dBfs input level

**Dynamic range**

134 dB

System latency

1.9 ms

Operating temperature range

-10 °C – +55 °C (EW-D)

-10 °C – +50 °C (EW-DX)

Relative humidity

5 – 95% (non-condensing)



EW-D EM rack receiver

Input voltage

DC 11 – 13 V

Input current

≤ 300 mA

Transmission power

BLE: max. 10 mW EIRP

Audio output power

18 dBu max.

Dimensions

212 × 44 × 189 mm (1 3/4" x 3 7/8" x 7 3/16")

Weight

Approx. 1000 g (without antennas and power supply unit)



EW-DX EM 2 rack receiver

Input voltage

DC 11 – 13 V or PoE IEEE 802.3af Class 0 (CAT5e or higher)

Input current

≤ 1 A

Transmission power

BLE: max. 10 mW EIRP

Audio output power

18 dBu max.

Headphone output

2x 70 mW @ 32 Ω

Ethernet

RJ-45 socket, IEEE802.3

100Base-TX (half+full duplex)

10Base-T (half+full duplex)

(CAT5e or higher)

Dimensions

212 × 44 × 206 mm (1 3/4" x 3 7/8" x 7 3/16")

Weight

Approx. 1000 g (without antennas and power supply unit)



EW-D SKM-S handheld transmitter

Input voltage

2.0 – 4.35 V

Input current

< 300 mA

Power supply

2 AA batteries 1.5 V (alkali manganese) or BA 70 rechargeable battery pack

Occupied bandwidth

200 kHz

Transmission power

- Audio link: 10 mW ERP (Range Y1-3: 12 mW ERP)
- BLE: max. 10 mW EIRP

Dimensions (diameter x length)

50 x 268 mm (incl. MMD 835 microphone module)

Weight (without batteries)

- Approx. 304 g (incl. MMD 835 microphone module)
- Approx. 195 g (without microphone module)



EW-DX SKM | EW-DX SKM-S handheld transmitter

Input voltage

2.0 – 4.35 V

Input current

< 300 mA

Power supply

2 AA batteries 1.5 V (alkali manganese) or BA 70 rechargeable battery pack

Occupied bandwidth

200 kHz

Transmission power

- Audio link: 10 mW ERP (Range Y1-3: 12 mW ERP)
- LD mode: 10 mW ERP
- BLE: max. 10 mW EIRP

Dimensions (diameter x length)

- 50 x 268 mm (incl. MMD 835 microphone module)
- 40 x 200 mm (without microphone module)

Weight (without batteries)

- Approx. 304 g (incl. MMD 835 microphone module)
- Approx. 195 g (without microphone module)



EW-D SK bodypack transmitter

Input voltage

2.0 – 4.35 V

Input current

< 300 mA

Power supply

2 AA batteries 1.5 V (alkali manganese) or BA 70 rechargeable battery pack

Occupied bandwidth

200 kHz

Transmission power

- Audio link: 10 mW ERP (Range Y1-3: 12 mW ERP)
- BLE: max. 10 mW EIRP

Dimensions

63 x 80 x 20 mm (without antennas)

Weight (without batteries)

Approx. 120 g



EW-DX SK | EW-DX SK 3-PIN bodypack transmitter

Input voltage

2.0 – 4.35 V

Input current

< 300 mA

Power supply

2 AA batteries 1.5 V (alkali manganese) or BA 70 rechargeable battery pack

Occupied bandwidth

200 kHz

Transmission power

- Audio link: 10 mW ERP (Range Y1-3: 12 mW ERP)
- LD mode: 10 mW ERP
- BLE: max. 10 mW EIRP

Dimensions

63.5 x 85 x 20 mm (without antennas)

Weight (without batteries)

approx. 115 – 120 g



EW-D ASA antenna splitter

Frequency ranges

- **EW-D ASA (Q-R-S):** 470 – 694 MHz
- **EW-D ASA CN/ANZ (Q-R-S):** 470 – 694 MHz
- **EW-D ASA (T-U-V-W):** 694 – 1075 MHz
- **EW-D ASA (X-Y):** 1350 – 1805 MHz

EW-D ASA antenna splitter

2 x 1:4 or 1 x 1:8, active

Gain

- in A – out A: 0 ± 1 dB
- in A – out A1 ... A4: 0 ± 1 dB
- in B – out B1 ... B4: 0 ± 1 dB

IIP3

> 25 dBm

Impedance

50 ?

Reflection loss

10 dB (all RF outputs)

Operating voltage

DC +12 V from NT 12-35 CS power supply unit

Current consumption

210 mA

Total current consumption

max. 3 A (with 4 EW-D EM and connected EW-D AB)

**Supply for antenna boosters at ANT RF in A and ANT RF in B**

- DC 12 V
- 320 mA

Supply for receivers at A1 to A4

- DC 12 V
- Typically 350 mA, max. 500 mA

Relative humidity

5 – 95%

Operating temperature range

-10 °C – +55 °C (14 °F – 131 °F)

Storage temperature range

-20 °C – +70 °C (-4 °F – 158 °F)

Dimensions

Approx. 212 x 168 x 43 mm

Weight

Approx. 1100 g

Block diagram

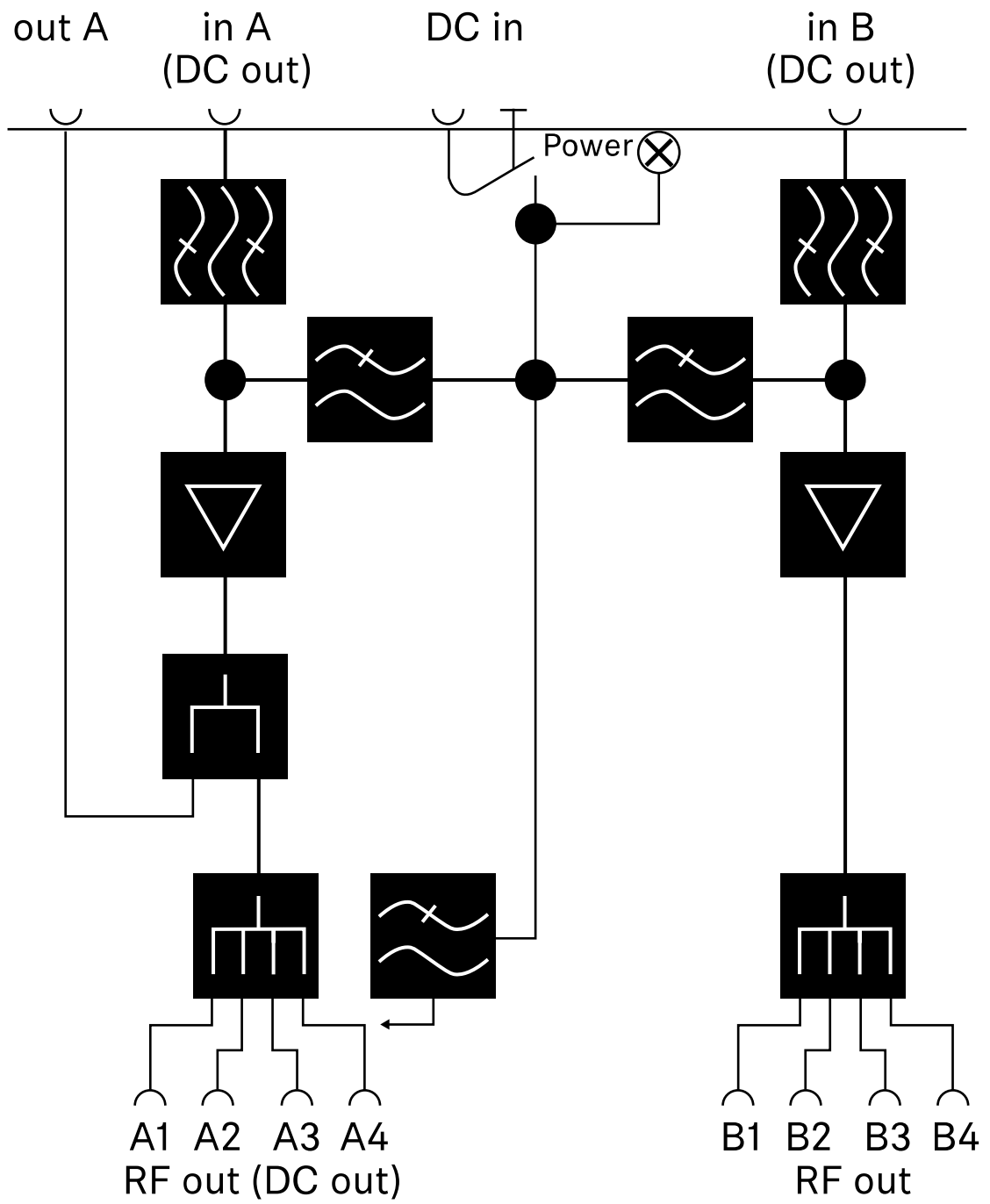



EW-D AB antenna booster

Frequency ranges

- **EW-D AB (Q):** 470 – 550 MHz
- **EW-D AB (R):** 520 – 608 MHz
- **EW-D AB (S):** 606 – 694 MHz
- **EW-D AB (U):** 823 – 865 MHz
- **EW-D AB (V):** 902 – 960 MHz
- **EW-D AB (Y):** 1785 – 1805 MHz

Power supply (DC coupled)

DC 12 V (DC 9 – 18 V) / max. 160 mA @ 12 V, center contact +

IIP3

> 25 dBm

Max. RF input power

+10 dBm

Gain

Typically 12 dB

Impedance

50 ?

Connections

2x BNC female, DC power supply from OUT to ANT

Dimensions

Approx. 95 x 47 x 21 mm

Weight

Approx. 120 g



Operating temperature range

-10 °C – +55 °C (14 °F – 131 °F)

Storage temperature range

-20 °C – +70 °C (-4 °F – 158 °F)

Relative humidity

5 – 95%



ADP UHF passive directional antenna (470 – 1075 MHz)

Frequency range

470 – 1075 MHz

Apex angle (-3 dB)

Approx. 100°

Front-to-back ratio

> 14 dB

Gain

Typically 5 dBi

Impedance

50 ?

Connection

BNC female, no DC path

Threads for tripod mounting

3/8" and 5/8"

Dimensions

319 × 310 mm

Weight

Approx. 320 g

Operating temperature range

-10 °C – +55 °C (14 °F – 131 °F)



Storage temperature range

-20 °C – +85 °C (-4 °F – 158 °F)

Relative humidity

5 – 95%

Typical polar diagram

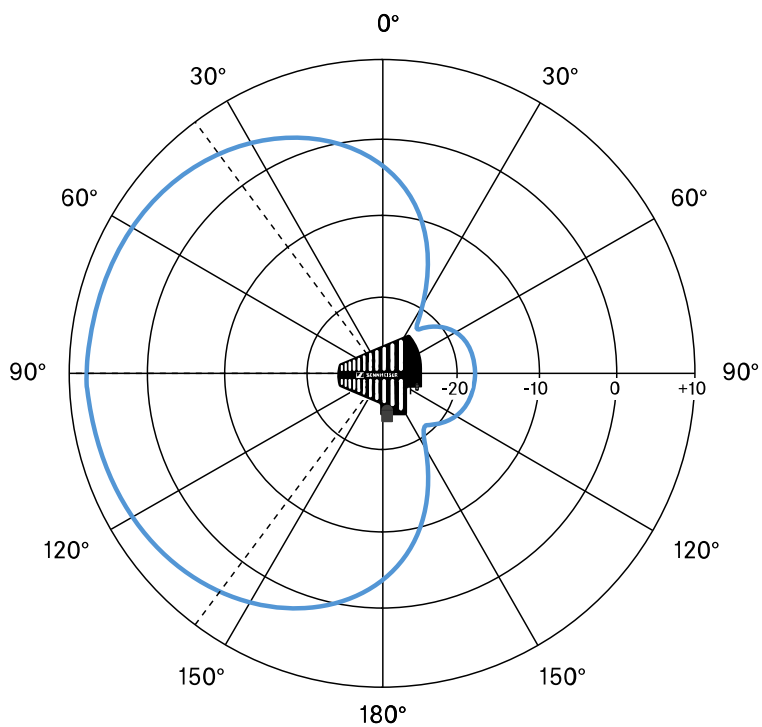



BA 70 rechargeable battery

Rated capacity

1720 mAh

Nominal voltage

3.8 V

Charging voltage

max. 4.35 V

Charging time

Typically 3 h @ room temperature

Dimensions

Approx. 54 x 30 x 15

Weight

Approx. 33 g

Temperature range

- **Charging:** 0 °C – +55 °C (32 °F – 131 °F)
- **Discharging:** -10 °C – +55 °C (14 °F – 131 °F)
- **Storage:** -10 °C – +45 °C (14 °F – 113 °F)

Relative humidity

- **Charging/discharging:** 25 to 95%, non-condensing
- **Storage:** 30 to 70%, non-condensing



L 70 USB charger

Charging capacity

2 Sennheiser BA 70 rechargeable battery packs

Input voltage

Typically 5 V

Input current

max. 2 A

Charging voltage

nominally 4.35 V

Charging current

max. 860 mA per battery pack

Charging time

max. 3.5 h with NT 5-20 UCW power supply unit

Temperature range

- **Charging:** 0 °C – +55 °C (14 °F – 113 °F)
- **Storage:** -20 °C – +70 °C (14 °F – 113 °F)

Relative humidity

max. 95% (non-condensing)

Dimensions

100 × 35 × 70 mm (1 3/4" × 3 7/8" × 7 3/16")

Weight

Approx. 86 g



CHG 70N charger

Power supply

DC 12 V

or

PoE IEEE 802.3af Class 0 (CAT5e or higher)

Current consumption

max. 3.5 A

Ethernet

RJ-45 socket, IEEE802.3

100Base-TX (half+full duplex)

10Base-T (half+full duplex)

Dimensions

Approx. 200 x 104 x 116 mm

Weight

approx. 640 g

Charging slots

2

Charging capacity per slot

BA 70 rechargeable battery

or

EW-DX SK with BA 70

or

EW-DX SKM with BA 70

Charging voltage

4.35 V

**Charging current**

min. 344 mA

max. 860 mA

Full charging time

Max. 3.5 h

Temperature range

- **Charging:** -10 °C to +50 °C
- **Storage:** -20 °C to +70 °C

Relative humidity

max. 95% (non-condensing)