

OTTICA 20x Zoom NDI 1080/60P PTZ Video Camera

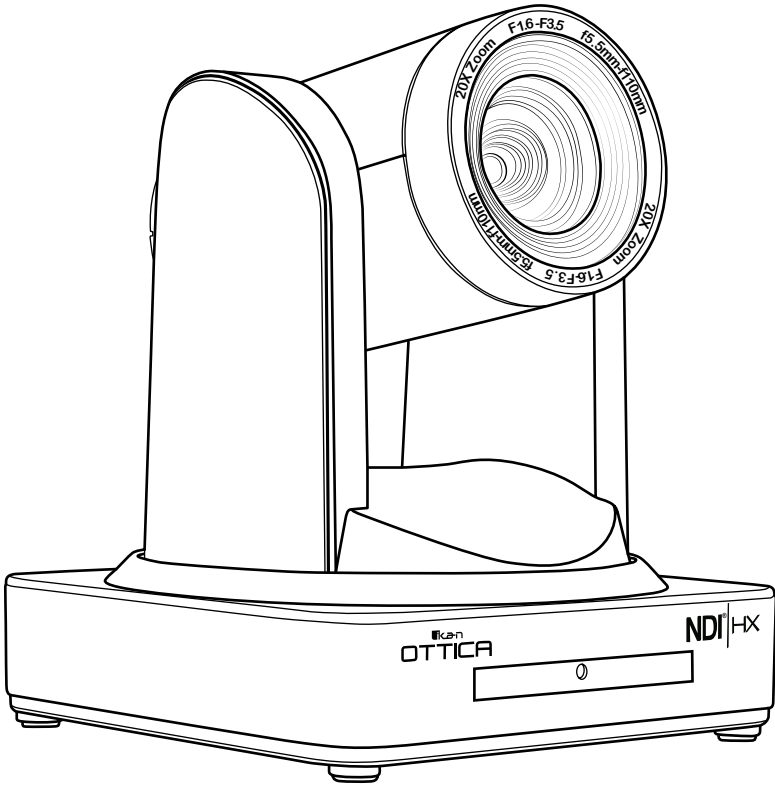

# Table of Contents

1. Getting Started.....	3
1.1 Camera Interface .....	3
1.2 Power-On Initial Configuration.....	4
1.3 Video Output .....	4
1.4 Bracket Mount .....	5
2. Product Overview .....	7
2.1 Product Introduction.....	7
2.1.1 Dimension .....	7
2.1.2 Accessory .....	7
2.2 Main Features .....	8
2.2.1 Camera Performance.....	8
2.2.2 Network Performance .....	8
2.3 Technical Specifications.....	9
2.4 Interface Instructions .....	11
2.4.1 External Interface.....	11
2.4.2 Bottom Dial Switch.....	12
2.4.3 RS-232 Interface .....	12
3. Application Instructions .....	14
3.1 Remote Control.....	14
3.1.1 Keys Introduction .....	14
3.1.2 Applications.....	15
3.2 Menu Settings .....	17
3.2.1 Main Menu .....	17
3.2.2 System Settings .....	17
3.2.3 Camera Settings .....	18
3.2.4 P/T/Z .....	20
3.2.5 Video Format .....	20
3.2.6 Version.....	21
3.2.7 Restore Default .....	21
4. Network Connection.....	22
4.1 Connecting Mode .....	22
4.2 IE Log In .....	23
4.2.1 Web Client .....	23
4.2.2 Preview .....	24
4.2.3 Configuration .....	24
4.2.4 Audio Configuration.....	24
4.2.5 Video Configuration.....	24
4.2.6 Network Configuration .....	28
4.2.7 System Configuration.....	29
4.2.8 Logout .....	31
4.2.9 Wireless Network.....	31

# Table of Contents (cont.)

5. Serial Communication Control .....	32
5.1 VISCA Protocol List .....	32
5.1.1 Camera Return Command .....	32
5.1.2 Camera Control Command .....	33
5.1.3 Inquiry Command .....	38
5.2 Pelco-D Protocol Command List .....	41
5.3 Pelco-P Protocol Command List .....	42
6. Camera Maintenance and Troubleshooting .....	43
6.1 Camera Maintenance .....	43
6.2 Troubleshooting .....	43

---

## 1. Getting Started

### 1.1 Camera Interface

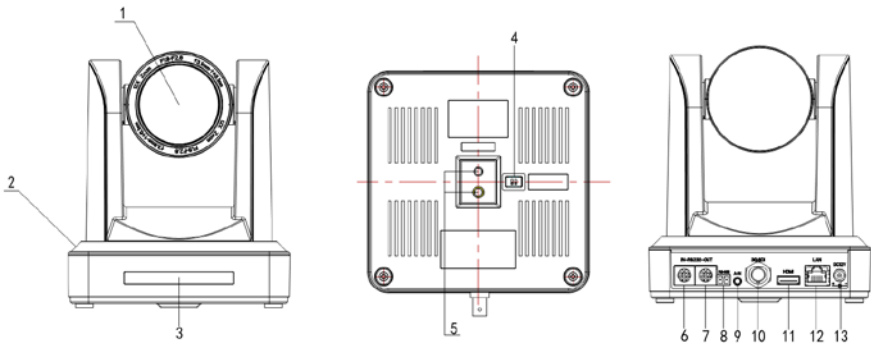

Figure 1.1 Interface of ST (standard) Series

- |    |                                   |     |                                 |
|----|-----------------------------------|-----|---------------------------------|
| 1. | Camera Lens                       | 8.  | RS485 Input (left +,right-)     |
| 2. | Camera Base                       | 9.  | Audio Input Interface           |
| 3. | Remote Controller Receiver Light  | 10. | 3G-SDI interface                |
| 4. | Bottom Dial Switch                | 11. | HDMI Interface                  |
| 5. | Tripod Screw Hole                 | 12. | NDI   HX Interface              |
| 6. | RS232 Control Interface (input )  | 13. | DC12V Input Power Supply Socket |
| 7. | RS232 Control Interface (output ) |     |                                 |

## 1.2 Power-On Initial Configuration

1. Power-On: Connect the DC12V power supply adapter into the power supply socket.
2. Initial Configuration: Upon powering on, the remote control receiver light will turn on and start blinking red. The camera head will move and adjust into the HOME position (intermediate position of both horizontal and vertical). When the remote control receiver light stops blinking red, it will stay on and turn green; this means the self-checking is finished.
  - Note: After the Power-On self-test is completed If you press “set preset” then “0”, the camera head automatically moves to the preset HOME position any time you press “0”.

## 1.3 Video Output

The OTTICA has a variety of video outputs including LAN, HDMI and 3G-SDI.

### 1. Video Output from LAN

A. Network Cable Connection Port: No.12 in Figure1.1;

B. Webpage Login:

- The OTTICA is set to auto DHCP so you'll need to connect the camera to devices that can automatically assign an IP address, such as routers and switches.
- Next, you'll have to use an IP scanning software to find the camera's IP address (visit the OTTICA product page at [www.ikancorp.com](http://www.ikancorp.com) to find a link to our recommended software for IP scanning).
- Copy and paste the camera's IP address and paste it into your web browser's address bar and press “Enter” to proceed into the login page.
- Enter the user name “admin” and password “admin” (factory default) and press “Enter” to proceed into the preview page.
- If you do not have the latest version of Flash installed, click on the button that says “Get ADOBE Flash Player”.
- After you've installed the latest version of flash, the camera feed should be visible and you can now perform PTZ control, video recording, playback, configuration, and other operation.
- NOTE: See chapter 4.1 for more details.

### 2. HDMI Video Output

A. HDMI Video Cable Connection: Refer to No.11 in Figure1.1.

B. Connect the camera and monitor via HDMI video cable.

### 3. 3G-SDI Video Output

A. 3G-SDI video cable connection: Refer to No.10 in Figure1.1

B. Connect the camera and the monitor via 3G-SDI video cable

# 1.4 Bracket Mount

Note: The bracket can only be mounted on a wall or ceiling on either template or concrete wall, but cannot be installed on plasterboard.

## Wall Mount Steps

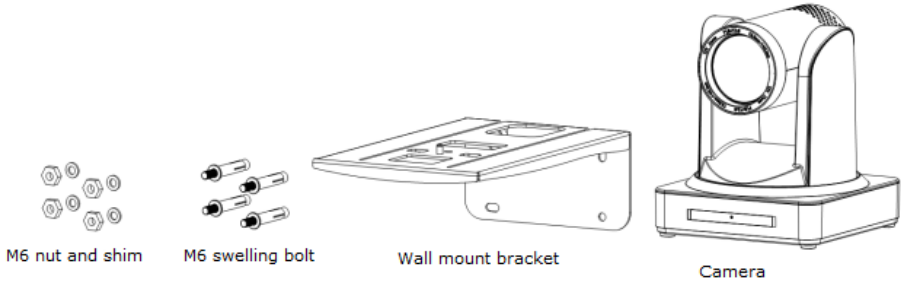

Step 1

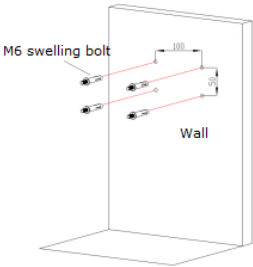

Step2

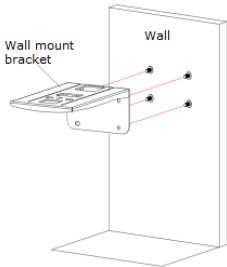

Step3

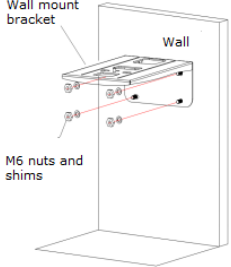

Step4

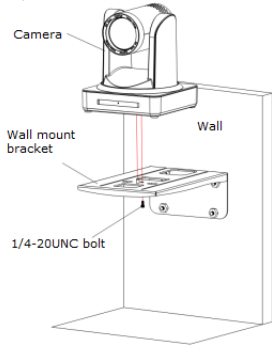

Finish

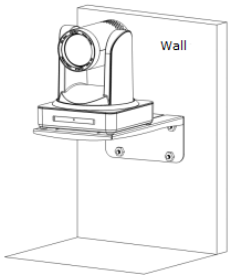

## Upside-down Mount Steps (Ceiling Mount sold separately)

PA3X30 self-tapping screws

PM3X6 screws



Ceiling upper covering plate

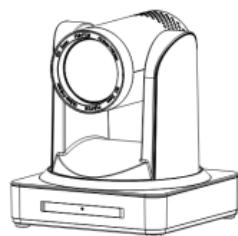

Camera

Screw stopper

1/4-20UNC screw



Ceiling lower covering plate

Step1

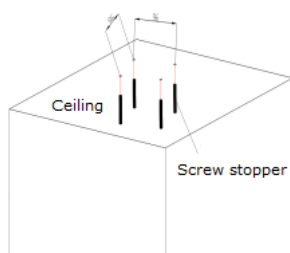

Step2

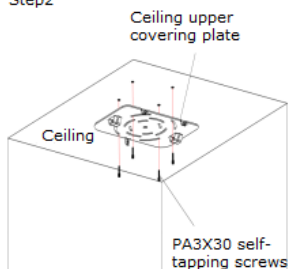

Step3

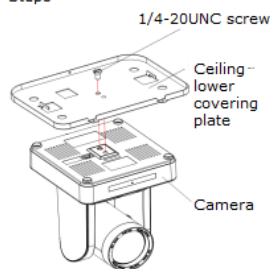

Step4

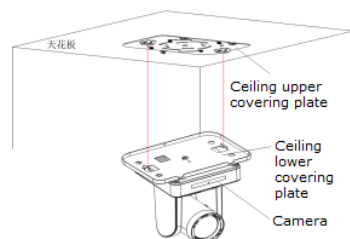

Step5

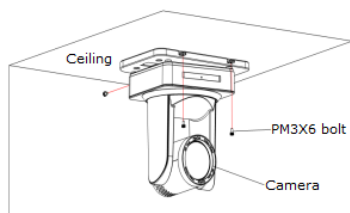

# 2. Product Overview

## 2.1 Product Introduction

### 2.1.1 Dimensions

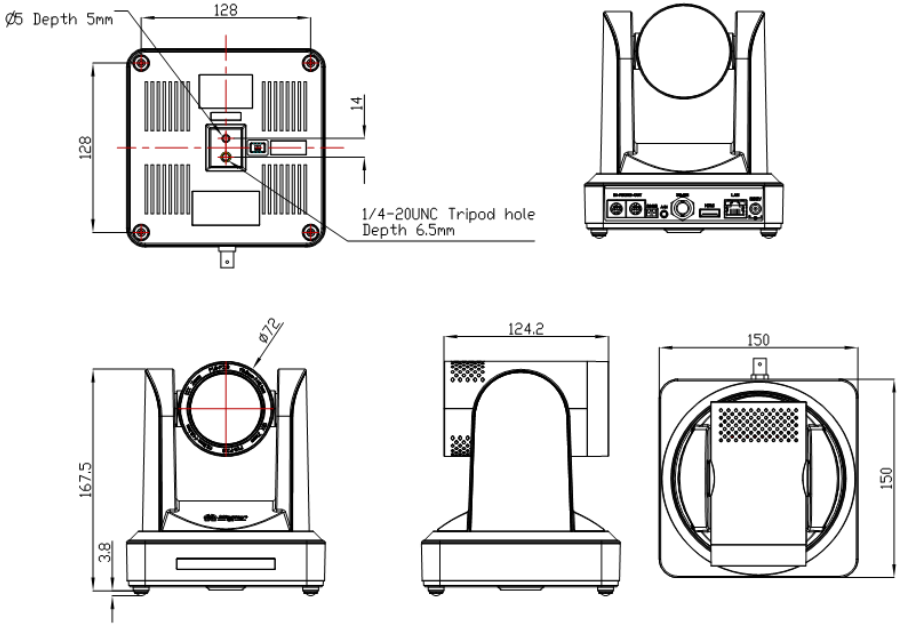

Figure 2.2 Camera Dimensions

### 2.1.2 Accessories

When unboxing, check that all the supplied accessories are included:

- 1 x Power Adapter
- 1 x RS232 Cable
- 1 x IR Remote Controller
- 1 x Wall Mounting Bracket
- 1 x RS485 Connector
- 1 x Cascade Cable

## 2.2 Main Features

### 2.2.1 Camera Performance

The OTTICA's features include advanced ISP processing algorithms to provide vivid images with a strong sense of depth, high resolution and fantastic color rendition. It supports H.265/H.264 encoding which makes motion video fluent and clear even with less than ideal bandwidth conditions.

1. Superb High-definition Image: The OTTICA employs 1/2.8 inch high-quality CMOS sensor and supports resolutions up to 1920x1080 with frame rates up to 60 fps.
2. Various Optical Zoom Lens: 5.5-110mm varifocal lens offers 20x optical zoom and viewing angle range from 3.3° to 54.7°
3. Auto Focus Technology: OTTICA's auto focus algorithm makes the lens fast, accurate, and stable.
4. Low Noise and High SNR: The Low Noise CMOS effectively ensures high SNR of the camera video. Advanced 2D/3D noise reduction technology is also used to further reduce the noise, while ensuring image sharpness.
5. Quiet PTZ: By adopting a high accuracy step-driving motor mechanism, the OTTICA performs smoothly and quietly even when moving quickly to any position.
6. Multi-Format Video Outputs: The OTTICA support HDMI,3G-SDI, wired LAN and wireless LAN interfaces. The 3G-SDI will work up 100m distance with transmission at 1080p60 format.
- 7.Low-power Sleep Function: The OTTICA supports a low-power sleep/wake up function. The consumption is lower than 500mW while in sleep mode.
8. Support Multiple Control Protocol: The OTTICA supports VISCA, PELCO-D, PELCO-P protocols which can also be automatically recognized.
9. RS-232 Cascade Function: The OTTICA supports RS-232 cascade function which is convenient for installing.
11. 255 Presets Positions: Up to 255 presets (10 presets by IR remote).

### 2.2.2 Network Performance

1. Audio Input Interface: 16000, 32000, 44100, 48000 sampling frequency and AAC, MP3, PCM audio coding are supported.
2. Multiple Audio/Video Compression: The OTTICA supports H.264/H.265 video compression of resolutions up to 1920x1080p with frame rates up to 60 fps and 2 channel 1920x1080p with 30 fps. AAC, MP3, and PCM audio compression is supported.
3. Multiple Network Protocol: Support NDIHX; ONVIF, RTSP, RTMP protocols and RTMP push mode, easy to link streaming media server (Wowza, FMS).



## 2.3 Technical Specifications

Camera Parameters	
Sensor	1/2.8 inch high quality HD CMOS sensor
Effective Pixels	16: 9 2.07 megapixel
Video Format	HDMI/SDI Video Format 1080P60/50/30/25/59.94/29.97;1080I60/50/59.94;720P60/50/30/25/59.94/29.97
Optical Zoom	20X Focal range: 5.5-110mm
View Angle	3.3° (tele) 54.7° (wide)
AV	F1.6 – F3.5
Digital Zoom	10X
Minimum Illumination	0.5Lux (F1.8, AGC ON)
DNR	2D & 3D DNR
White Balance	Auto / Manual/ One Push/ 3000K/ 4000K/5000K/6500K
Focus	Auto/Manual
Aperture	Auto/Manual
Electronic Shutter	Auto/Manual
BLC	ON/OFF
WDR	OFF/ Dynamic level adjustment
Video adjustment	Brightness, Color, Saturation, Contrast, Sharpness, B/W mode, Gamma curve
SNR	>55dB

<b>Input / Output Interface</b>	
Video Interfaces	LAN (NDI   HX 4.0), HDMI, 3G-SDI, Audio-in, RS232 (In&Out), RS485
Image Code Stream	Double streams outputs simultaneously
Video Compression format	H.264, H.265
Control Signal Interface	RS-232 Ring through RS232 output, RS-485
Control Protocol	VISCA/Pelco-D/Pelco-P; Baud Rate: 115200/9600/4800/2400bps
Audio input Interface	Double track 3.5mm linear input;
Audio Compression Format	AAC/MP3/PMC Audio compression
HD IP Interface	100M IP Port(100BASE-TX); 5G WiFi (optional), support NDI, IP Visca control protocol
Network Protocol	NDI,RTSP/RTMP,ONVIF
Power Interface	HEC3800 Outlet (DC12V)

<b>PTZ Parameters</b>	
Pan Rotation	$\pm 170^{\circ}$
Tilt Rotation	$-30^{\circ} \sim +90^{\circ}$
Pan Control Speed	0.1 -180°/sec
Tilt Control Speed	0.1-80°/sec
Preset Speed	Pan: 60°/sec, Tilt: 30°/sec
Preset Number	255 presets (10 presets by remote controller)

<b>Other Parameters</b>	
Supply Adapter	AC110V-AC220V to DC12V/2A
Input Voltage	DC12V $\pm$ 10%
Input Current	1A(Max)
Consumption	12W (Max)

Other Parameters	
Store Temperature	14°F to +140°F
Store Humidity	20% - 95%
Working Temperature	14°F to +122°F
Working Humidity	20%--80%
Dimension	150mmX150mmX167.5mm
Weight	3.08 LBS
Working Environment	Indoor
Remote Operation (IP)	Remote Upgrade, Reboot and Reset

## 2.4 Interface Instruction

### 2.4.1 External Interface

1. External Interface: RS232 Input /Output, RS485 Input, Audio Input, 3G-SDI Output, HDMI Output, LAN, DC12V Power Interface.

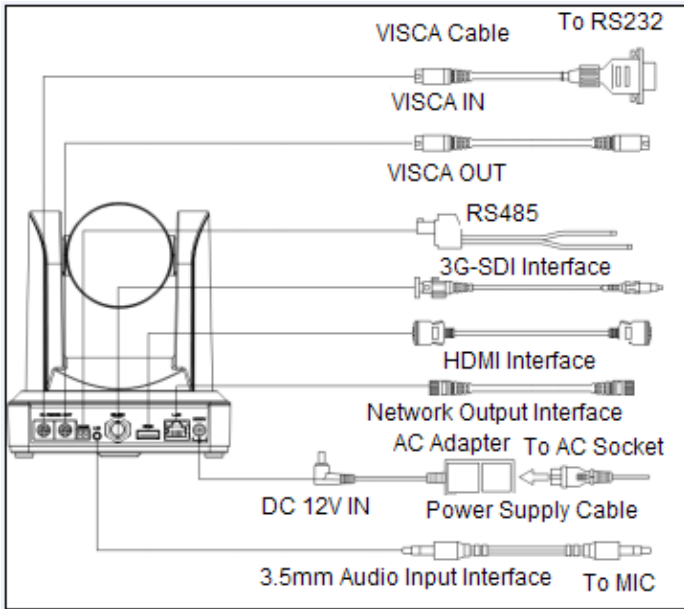

Figure 2.3 External Interface Diagram

## 2.4.2 Bottom Dial Switch

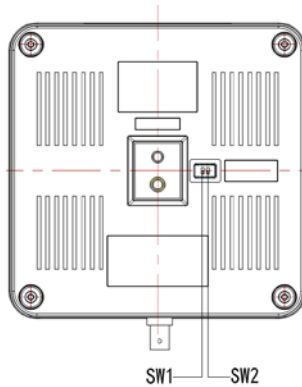

Figure 2.6 Bottom Dial Switch Diagram

Two DIP switches are set to ON or OFF to select different modes of operation.

No.	SW1	SW2	Explanation
1	OFF	ON	Working Mode
2	ON	OFF	Updating Mode

Note: Working mode can be applicable for web upgrade.

## 2.4.3 RS-232 Interface

### 1. RS-232C Interface Specifications

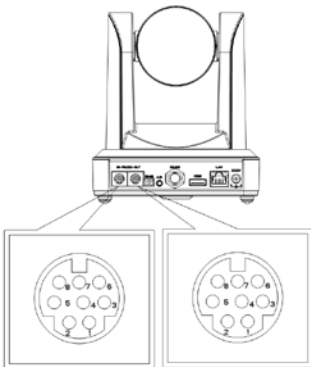

Camera	Windows DB-9
1. DTR	1. DCD
2. DSR	2. RXD
3. TXD	3. TXD
4. GND	4. DTR
5. RXD	5. GND
6. GND	6. DSR
7. IR OUT	7. RTS
8. NC	8. CTS
	9. RI

RS232 IN  
port on  
camera



DB9F



RS232 port on  
PC or Control  
Keyboard

## 2. RS-232 Mini-DIN 8-pin Port Definition

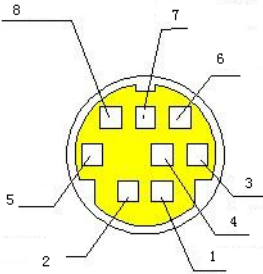

No.	Port	Definition
1	DTR	Data Terminal Ready
2	DSR	Data Set Ready
3	TXD	Transmit Data
4	GND	System Ground
5	RXD	Receive Data
6	GND	System Ground
7	IR OUT	IR Commander Signal
8	NC	No Connection

## 3. RS232 (DB9) Port Definition

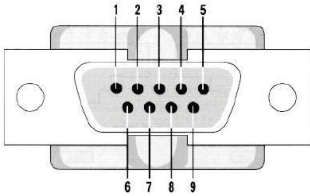

No.	Port	Definition
1	DCD	Data Carrier Detect
2	RXD	Receive Data
3	TXD	Transmit Data
4	DTR	Data Terminal Ready
5	GND	System Ground
6	DSR	Data Set Ready
7	RTS	Request to Send
8	CTS	Clear to Send
9	RI	Ring Indicator

## 4. VISCA networking as shown below:

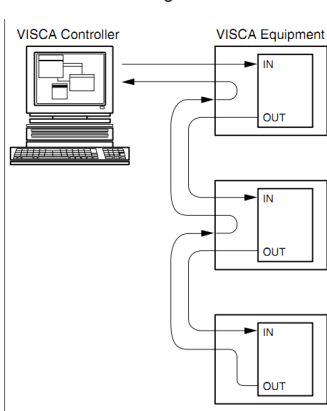

Camera Cascade Connection Method	
Camera 1	Camera 2
1. DTR	1. DTR
2. DSR	2. DSR
3. TXD	3. TXD
4. GND	4. GND
5. RXD	5. RXD
6. GND	6. GND
7. IR OUT	7. OPEN
8. NC	8. OPEN

Note: OTTICA has RS232 input and output interface, so you can cascade as shown above.

# 3. Application Instructions

## 3.1 Remote Control



### 3.1.1 Keys Instruction

- Standby Key**  
After a 3-second long press, the camera will step into standby mode. After pressing the standby key for 3 seconds again, the camera will self-test again and go back to the HOME position.
- Camera Address Selection**  
Select the camera address which wants to be controlled.
- Number Keys**  
Set or run 0-9 presets.
- # + \* Keys**  
Use for key combinations.
- Focus Control Key**  
Auto Focus: Enter into auto focus mode.  
Manual Focus: The camera focus mode is manual  
Switch the camera focus mode to manual focus by pressing [focus +] or [focus -] to adjust.
- Zoom Control Key**  
Zoom +: Zoom In.  
Zoom -: Zoom Out.
- Set or Clear Preset key:**  
Set Preset: Sets preset key + 0-9 number key.  
Clear Preset: Clears preset key + 0-9 number key.
- Pan/Tilt Control Key**  
Press  $\wedge$  Key: Tilts camera upwards.  
Press  $\vee$  Key: Tilts camera downwards.  
Press  $\leftarrow$  Key: Pans camera left.  
Press  $\rightarrow$  Key: Pans camera right.  
"HOME" Key: Returns camera to the middle position. Also used to enter into the next level menu.
- BLC Control Key**  
Back Light ON / OFF: Turn on or off the back light.
- Menu Setting**  
Open or close the on-screen-display menu.  
Enter / exit the on-screen-display menu or return to the previous menu.

## 11. Camera IR Remote Control Address Setting

- [ \* ]+ [ # ]+[ F1 ] : Camera Address No. 1
- [ \* ]+ [ # ]+[ F2 ] : Camera Address No. 2
- [ \* ]+ [ # ]+[ F3 ] : Camera Address No. 3
- [ \* ]+ [ # ]+[ F4 ] : Camera Address No. 4

## 12. Key Combination Functions

[ # ] + [ # ] + [ # ]: Clear all presets	[ * ] + [ # ] + [ 6 ]: Restore factory defaults
[ * ] + [ # ] + [ 9 ]: Flip switch	[ * ] + [ # ] + Auto: Enter into the aging mode
[ * ] + [ # ] + [ 3 ]: Menu set to Chinese	[ * ] + [ # ] + [ 4 ]: Menu set to English
[ * ] + [ # ] + Manual: Restore the default user name, password, and IP address	[ # ] + [ # ] + [ 0 ]: Switch video format to 1080p60
[ # ] + [ # ] + [ 1 ]: Switch video format to 1080p50	[ # ] + [ # ] + [ 2 ]: Switch video format to 1080i60
[ # ] + [ # ] + [ 3 ]: Switch video format to 1080i50	[ # ] + [ # ] + [ 4 ]: Switch video format to 720p60
[ # ] + [ # ] + [ 5 ]: Switch video format to 720p50	[ # ] + [ # ] + [ 6 ]: Switch video format to 1080p30
[ # ] + [ # ] + [ 7 ]: Switch video format to 1080p25	[ # ] + [ # ] + [ 8 ]: Switch video format to 720p30
[ # ] + [ # ] + [ 9 ]: Switch video format to 720p25	

### 3.1.2 Applications

Users can control the pan/tilt/zoom, settings and execute preset positions via the IR remote controller.

Key Instructions:

- In these instructions, “press the key” means a click rather than a long-press. A special note will be given if a long-press for more than one second is required.
- When a key-combination is required, do it in sequence. For example, “[ \* ] + [ # ] + [ F1 ]” means press [ \* ] first, then press [ # ], lastly press { F1 }

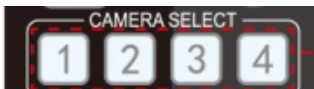

Camera Selection

- Select the camera address to control.

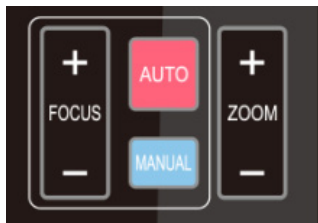

### Focus Control

- Focus (near): Press FOCUS + Key  
(Valid only in manual focus mode)
- Focus (far): Press FOCUS - Key  
(Valid only in manual focus mode)
- Pressing and holding the "+" or "-" keys will result in the action of focus to continue. Release the key to stop the action of focus.
- Auto Focus: Enables auto focus function.
- Manual Focus: Enables manual focus function.

### Zoom Control

- ZOOM IN: Press Zoom + Key
- ZOOM OUT: Press Zoom - Key
- By pressing and holding the key, the camera lens will keep zooming in or zooming out and stops as soon as the key is released.



### Preset Setting

- To set a preset position, press the [ SET PRESET ] key first and then press the number key 0-9 to set a relative preset.
- Note: 10 preset positions in total are available by remote controller.

### Preset Running

- Press a number key 0-9 directly to run a relative preset.
- Note: Action will not be completed if a relative preset position doesn't exist.

### Preset Clearing

- To clear a preset position, press the [ CLEAR PRESET ] key first and then press the number key 0-9 to clear the relative preset.
- Note: press the [ # ] key three times to clear all presets.



### Pan/Tilt Control

- Up: Press Down: Press
- Left: Press Right: Press
- Back to middle position: Press HOME
- Press and hold the up/down/left/right key to pan or tilt the camera. The camera movement will ease from slow to fast until it reaches the endpoint. The pan/tilt movement stops as soon as the key is released.



### BLC ON / OFF

- Enables and/or disables backlight compensation



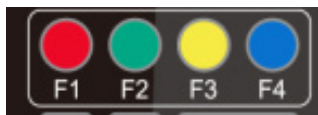

## Remote Controller Address Setting

- [ \* ]+ [ # ]+[ F1 ] : Camera Address No. 1
- [ \* ]+ [ # ]+[ F2 ] : Camera Address No. 2
- [ \* ]+ [ # ]+[ F3 ] : Camera Address No. 3
- [ \* ]+ [ # ]+[ F4 ] : Camera Address No. 4

## 3.2 Menu Setting

### 3.2.1 Main Menu

In normal working mode, press the MENU key to display the menu. Use the scroll arrow to point at or highlight the selected items.

MENU  
=====

Language	English
(Setup)	
(Camera)	
(P/T/Z)	
(Video Format)	
(Version)	
(Restore Default)	

[ ↑ ↓ ] Select    [ ← → ] Change Value

[ MENU ] Back: Press MENU to Return  
 [ HOME ] OK: Press HOME to Confirm  
 Language Setting: English / Chinese  
 Setup: System Settings  
 Camera: Camera Settings  
 PTZ: Pan / Tilt / Zoom Settings

Version: Camera Version Settings  
 Restore Default: Reset Settings

[ ↑ ↓ ] Select: Menu Selection  
 [ ← → ] Change Value: Modify Parameters

### 3.2.2 System Settings

Move the arrow to the SETUP option in the Main Menu and click the HOME key to enter into the SETUP Settings Menu.

SETUP  
=====

Protocol	Auto
Visca Address	1
Visca Address Fix	OFF
PELCO-P Address	1
PELCO-D Address	0
Baud Rate	9600

[ ↑ ↓ ] Select    [ ← → ] Change Value

Protocol: VISCA / PELCO-P / PELCO-D/ AUTO  
 Visca ADDR:            VISCA = 1~7  
                               PELCO-P = 1~255  
                               PELCO-D = 1~255  
 Visca Address Fix: ON / OFF  
 Baud Rate: 2400 / 4800 / 9600 / 115200

### 3.2.3 Camera Settings

Move the arrow to the CAMERA option in the Main Menu and click the HOME key to enter into the CAMERA Settings Menu.

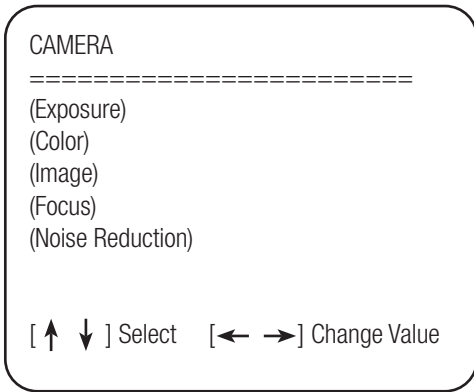

Move the arrow to desired setting (Exposure, Color, etc.) option in the CAMERA menu and click the HOME key to enter.

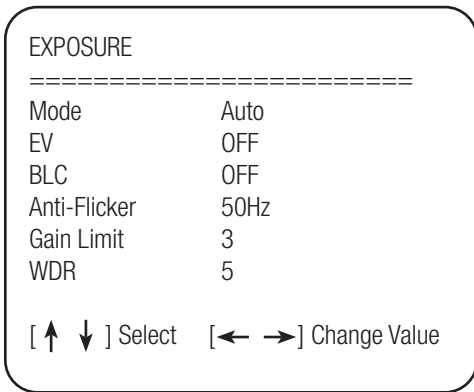

#### 1. EXPOSURE

- Mode: Auto / Manual / Shutter Priority / Iris Priority / Brightness Priority
- EV: ON / OFF (Only available in Auto mode)
- Compensation Level: -7~7 (only available in auto mode when EV is ON)
- BLC: ON/OFF for options (only available in auto mode)
- Anti-Flicker: OFF/50Hz/60Hz for options (only available in Auto/Iris priority/ Brightness priority modes)
- Gain Limit: 0~15(only available in Auto/ Iris Priority /Brightness Priority mode)
- WDR: Off, 1~8
- Shutter Priority: 1/25, 1/30, 1/50, 1/60, 1/90, 1/100, 1/120, 1/180, 1/250, 1/350, 1/500, 1/1000, 1/2000, 1/3000, 1/4000, 1/6000, 1/10000 (only available in Manual and Shutter priority mode)
- IRIS Priority: OFF, F11.0, F9.6, F8.0, F6.8, F5.6, F4.8, F4.0, F3.4, F2.8, F2.4, F2.0, F1.8 (only available in Manual and Iris priority mode)
- Brightness: 0~23 (only available in Brightness Priority mode)

## COLOR

=====

WB Mode	Auto
Saturation	80%
Hue	7
AWB Sensitivity	High
Color Style	Default
Color Temp	Low

[ ↑ ↓ ] Select    [ ← → ] Change Value

## 2. COLOR

- WB Mode: Auto, 3000K, 3500K, 4000K, 4500K, 5000K, 5500K, 6000K, 500K, 7000K, Manual, One Push
- Red Gain: 0~255(only available in Manual mode)
- Blue Gain: 0~255(only available in Manual mode)
- Saturation: 60%, 70%, 80%, 90%, 100%, 110%, 120%, 130%
- Hue: 0~14
- AWB Sensitivity: High/Middle/Low
- Color Style: Default, style1~4
- Color Temp: High/Middle/Low

## IMAGE

=====

Brightness	6
Contrast	8
Sharpness	7
Flip-H	OFF
Flip-V	OFF
B&W-Mode	Color
Gamma	Default
DZoom	OFF
DCI	Close

[ ↑ ↓ ] Select    [ ← → ] Change Value

## 3. IMAGE

- Brightness: 0~14
- Contrast: 0~14
- Sharpness: 0~15
- Flip Horizontal: On/Off
- Flip Vertical: On/Off
- B&W Mode: Color, Black/White
- Gamma: default, 0.47, 0.50, 0.52, 0.55
- Digital zoom options: On/Off
- Dynamic Contrast: Off, 1~8

## FOCUS

=====

Focus Mode	Auto
AF-Zone	Center
AF-Sensitivity	Low

[ ↑ ↓ ] Select    [ ← → ] Change Value

## 4. FOCUS

- Focus Mode: Auto, Manual
- AF-Zone: Up, Middle, Down
- AF-Sensitivity: High, M=Middle, Low

### NOISE REDUCTION

NR-2D Auto  
NR-3D 3  
Dynamic Hot Pixel OFF

[ ↑ ↓ ] Select [ ← → ] Change Value

### 4. NOISE REDUCTION

- 2D Noise Reduction: Auto, Close, 1~7
- 3D Noise Reduction: Close, 1~8
- Dynamic Hot Pixel: Close, 1~5

### 3.2.4 P/T/Z

Move the arrow to the P/T/Z option in the Main Menu and click the HOME key to enter into the P/T/Z Settings Menu.

### P/T/Z

Depth of Field ON  
Zoom Speed 8  
Image Freezing OFF  
Acc Curve Slow

[ ↑ ↓ ] Select [ ← → ] Change Value

- Depth of Field: Only effective for remote controller, On/Off;
- When zoom in, the PT control speed by remoter will become slow),
- Zoom Speed: Set the zoom speed for remote controller, 1~8
- Image Freezing: On/Off
- Accelerating Curve: Fast/slow

### 3.2.5 Video Format

Move the arrow to the VIDEO FORMAT option in the Main Menu and click the HOME key to enter into the VIDEO FORMAT Settings Menu.

### VIDEO FORMAT

1080P60 1080P50  
1080I60 1080I50  
1080P30 1080P25  
720P60 720P50  
720P30 720P25  
1080P59.94 1080I59.94  
1080P29.97 720P59.94  
720P29.97

[ ↑ ↓ ] Select [ Menu ] Back

- S Version: 1080P60, 1080P50, 1080P30, 1080P25, 1080I60, 1080I50, 720P60, 720P50, 720P30, 720P25, 1080P59.94, 1080I59.94, 1080P29.97, 720P59.94, 720P29.97 Optional
- M Version: 1080P30, 1080P25, 1080I60, 1080I50, 720P60, 720P50 Optional

Notes:

- S: 1080P60 Downward Compatibility
- M: 1080P30 Downward Compatibility
- Exiting the menu will save the modification of the parameter. Restart device for parameter modification to be enabled.

### 3.2.6 Version

Move the arrow to the VERSION option in the Main Menu and click the HOME key to enter into the VERSION Settings Menu.

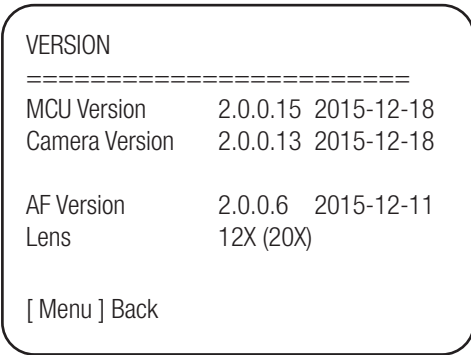

- MCU Version: Display MCU version information
- Camera Version: Display camera version information
- AF Version: Display the focus version information
- Lens: Display the lens zoom

### 3.2.6 Restore Default

Move the arrow to the RESTORE DEFAULT option in the Main Menu and click the HOME key to enter into the RESTORE DEFAULT Settings Menu.

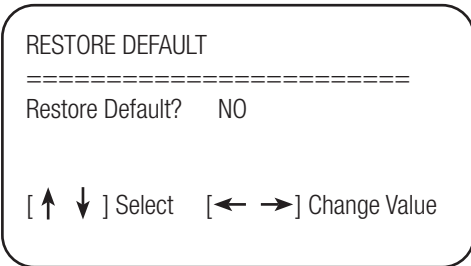

- Restore default: options: Yes/No; after restoring default, the video format won't be restored.
- Note: If the address of former remote is 2, 3, or 4, the corresponding camera address will restore to 1 when all parameters or system parameters are restored. User should change the remote address to be 1 (press No.1 according to the camera to get normal operation)

# 4. Network Connection

## 4.1 Obtain Camera IP Address Based on Auto DHCP

The OTTICA is set to Auto DHCP, so you'll need to obtain camera IP address before connecting to a network. See 2 common solutions to obtain the camera IP address.

Solution 1:

1. Connect the camera to a device that can automatically assign an IP address, such as routers and switches.
2. Use an IP Search Tool to search LAN segment, such as "192.168.5.0~192.168.5.255". We suggest using "SoftPerfect Network Scanner" software to get the search results.
3. Then search the results and refer to the MAC address pasted on the bottom of the camera to obtain the camera IP address.

Reference Image:

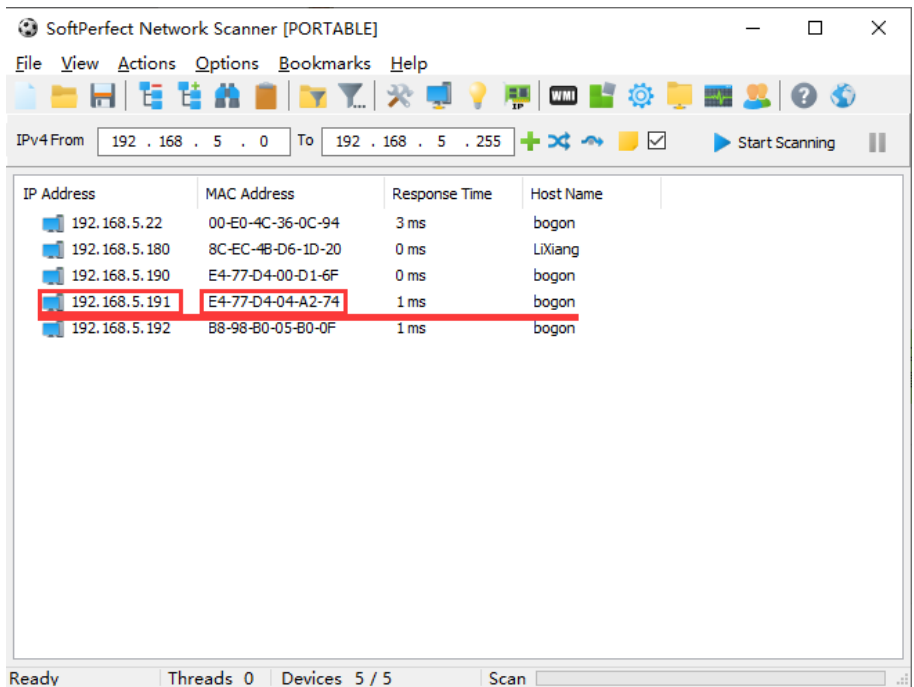

Solution 2:

1. Connect the camera to devices that can automatically assign IP address, such as routers and switches.
2. Enter into the Management Interface of the router or switch and obtain the camera IP address with reference to the MAC address pasted on the bottom of the camera.

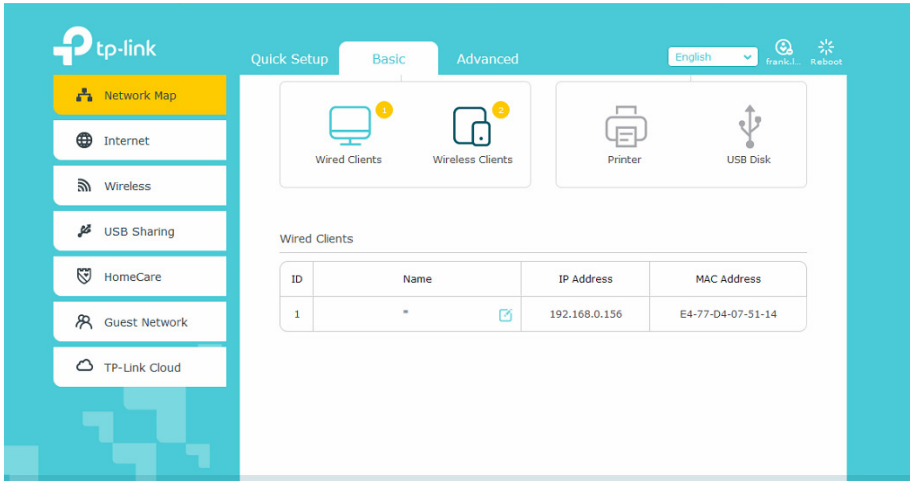

## 4.2 IE Log In

### 4.2.1 Web Client

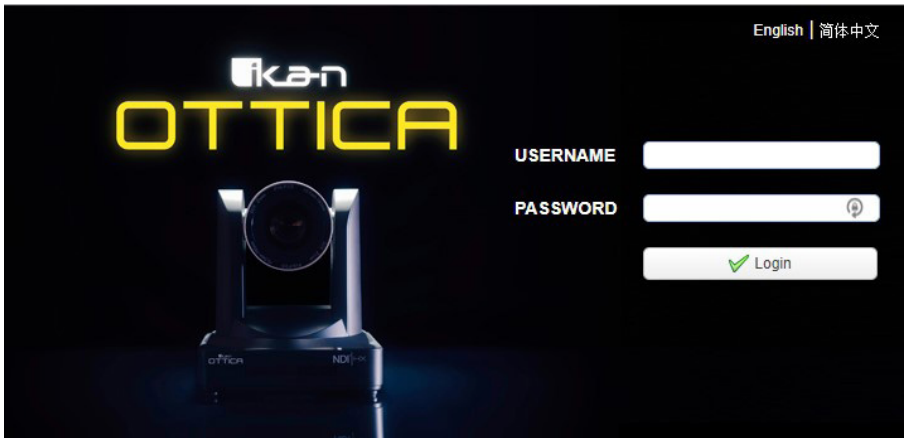

#### Web Client Log In

- Input the camera IP address (the IP address you obtain through Search Tool) in the address field of your browser and click the "Enter" button to proceed to the Web Client login page.

- You can login as the administrator and normal user. If logging in as an administrator, fill out the required fields with the following: Username: admin. Password: admin.
- Administrator users can preview, playback, cancel, and configure in the Web Client; If logging in as a normal user, the default User name/Password is: user1 or user2. Normal users can only preview playback and cancel. There is no option for configuration.
- NOTE: If you do not have the latest version of Flash installed, click on the button that says "Get ADOBE Flash Player. After you've installed the latest version of flash, the camera feed should be visible and you can now perform PTZ control, video recording, playback, configuration, and other operation

#### **4.2.2 Preview**

After successfully logging into the management interface, the video preview interface will become visible. In this interface, users can control pan, tilt, zoom, focus, video capture, sound, full screen, set the preset position, run, delete, and other operations.

#### **4.2.3 Configuration**

Click Configuration to enter into the settings page.

There are the following options: Audio Configuration, Video Configuration, Network Configuration, System Configuration.

#### **4.2.4 Audio Configuration**

- Switch: Choose to enable the audio or not.
- Encoding Type: Set the audio compressing format and the device will reboo automatically after the change (default: MP3. optional: PCM & AAC).
- Sample Rate: Set the sampling frequency and the device will reboot automatically after change (default: 48000. Optional: 16000, 32000 and 44100)
- Sampling Bits: Set the sampling precision (Default: 16bits)
- Bit Rate: Set the audio compressing code rate (Default: 64kbps; Optional: 32, 48, 96, 128kbps)
- Channel: Set the audio channel (default: stereo. optional: mono)
- Input Volume: Set the volume level (default: 2). Note: Click "SAVE" and it will remind" Enable has changed. Restart the device to take effect after the success of the save.", then please reboot the camera to make new setting effect.

#### **4.2.5 Video Configuration**

##### **1. Video Encoding**

- Code stream: Stream: Different video output mode settings are available: Main Stream & Secondary Stream
- Compression Format: You can set the video compression format. Save and reboot to activate the new format (primary / secondary stream default is set to H.264. H.265 is optional).
- Profile: Profile Mode Setting (default is set to HP. BP & MP are optional).
- Video Size: You can set the video image resolution. Save and reboot to activate the new



format (main stream default: 1080p. 720p is optional).

- Stream Rate control: You can set the rate control mode. Save and reboot to activate the new mode (primary / secondary stream default is set to Variable Rate. Fixed rate is optional).
- Image Quality: You can set the image quality. The image quality can be changed only when the stream rate control is set to Variable Rate.
- Bit Rate (Kb/s): You can set the video bit rate  
(Main stream default: 4096kb/s. Optional: 64-12288kb/s)  
(Secondary stream default: 1024kb/s. Optional: 64-10240kb/s)
- Frame Rate (fps): Set the video frame rate (primary / secondary stream default is 25fps. primary stream 5-60fps is optional, secondary stream 5-30fps is optional).
- Frame Interval: You can set the key frame interval (primary / secondary stream default setting is 75f. Primary / stream 1-300f is optional. Secondary stream 1-150F is optional).
- Stream Name: When streaming via rtp or rtmp, you can modify the stream name. Main Stream (live/av0), sub stream (live/av1)
- Click the "Save" button to display the "saved successfully" message. The new settings will then be activated.
- Switch: To turn on/off the main / secondary stream.
- Protocol: Primary / secondary stream applies RTMP protocol.
- Host Port: Server port number (Default: 1935; Optional: 0-65535) Host Address: Server IP addresses (Default: 192.168.5.11)
- Stream Name: Choose a different stream name (live / av0, live / av1 optional).
- User: Set the user name.

## 2. Stream Publish

- Switch: To turn on/off the main / sub stream.
- Protocol Type: Primary / secondary stream applies RTMP protocol.
- Host Address: Server IP addresses (Default: 192.168.5.11)
- Host Port: Server port number (Default 1935: Optional: 0-65535)
- Stream Name: Choose a different stream name (live / av0, live / av1 optional).
- User Name: Set the user name.
- Password: Set the password.
- Click on the "Save" button to display the "Save successful" message. The new settings will then be activated.
- Method of obtaining RTSP: rtp:// device IP address: 554 / live / av0 (av0 main stream; av1 secondary stream).

## 3. Multicast

- Switch: To turn on/off the main / sub stream.
- Protocol Type: RTP or TS
- Multicast Address: Default 224.1.2.3. (Can be edited)
- Multicast Port: Main Stream Default Port: 4000, Sub Stream Default Port: 4002

## 4. Video Parameters

### A. Focus Settings

- Focus Mode: Auto (default), Manual & OnePush (optional).
- AF-Zone: All (default), Top, Center, Bottom (optional).
- Focus Sensitivity: Low (default), High & Medium (optional).

### B. Exposure

- Mode: Auto (default), Manual, SAE, AAE, Bright (optional). Shutter Priority, Aperture Priority, Brightness Priority (optional).
- Exposure Compensation: Exposure Compensation settings are activated only when
- EV: Off (default), On (optional)
- EV Level: 0 (default) -7 through 7 (optional)
- BLC: Settings are activated only when Exposure Mode is set to Automatic (Default: OFF).
- Flicker: Settings are activated only when Exposure Mode is set to Automatic, Aperture, or Brightness Priority. (Default: 50Hz. Optional: Off & 60Hz).
- Gain Limit: (Default: 3; Optional: 0-15).
- Dynamic Range: (Default: 4; Optional: 0-8).
- Shutter Speed: Settings are activated only when Exposure Mode is set to Manual or Shutter-Priority (Default: 1/100. Optional: 1/25, 1/30, 1/50, 1/60, 1/90, 1/100, 1/120, 1/180, 1/250, 1/350, 1/500, 1/1000, 1/2000, 1/3000, 1/4000, 1/6000, 1/10000).
- Iris: Settings are activated only when Exposure Mode is set to Manual or Aperture-Priority (Default: F1.8; Optional: Closed, F1, F9.6, F8.0, F6.8, F5.6, F4.8, F4.0, F3.4, F2.8, F2.4, F2.0, F1.8).
- Brightness: Settings are activated only when Exposure Mode is set to Brightness Priority (Default: 7; Optional: 0-23).

### C. Color

- White Balance Modes: (Default: Automatic; Optional: Manual, OnePush, Variable)
- Variable Color Temperatures: 2400K - 7100K
- Red Gain: (Default: 255; Optional: 0-255).
- Blue Gain: (Default: 199; Optional: 0-255).
- Saturation: (Default: 100%; Optional: 60%, 70%, 80%, 90%, 110%, 120%, 130%).
- Hue: (Default: 7; Optional: 0-14).
- Auto White Balance Sensitivity: (Default: High; Optional: Low & Medium)

### D. Image

- Brightness: (Default: 6; Optional: 0-14).
- Contrast: (Default: 8; Optional: 0-14).
- Sharpness: (Default: 7; Optional: 0-15).
- Black and White Mode: (Default: Color; Optional: Black & White).
- Gamma: (Default: 0.45; Optional: 0.50, 0.52, 0.55).
- Flip Horizontal: (Default: OFF; Optional: ON).

- Flip Vertical: (Default: OFF; Optional: ON).
- DCI: (Default: OFF; Optional: ON).
- DZoom: (Default: OFF; Optional: ON).
- Low-Light Mode: (Default: OFF; Optional: ON).

#### E. Noise Reduction

- 2D Noise Reduction: (Default: 1; Optional: 2-7, AUTO, and OFF).
- 3D Noise Reduction: (Default: 3; Optional: 1-8 and OFF).
- Dynamic Dead Pixel Correction: (Default: OFF; Optional: 1-5).

#### F. Style

- Style Option: (Default: Default; Optional: Normal, Clarity, Bright, Soft)

### 4. Character-Overlapping

- Display Date and Time: Set whether to display the time and date (default display).
- Display Title: Set whether to display the title (default display).
- Font Color of Time: (Default: White; Optional: Black, Yellow, Red, Blue).
- Font Color of Title: (Default: White; Optional: Black, Yellow, Red, Blue).
- Moving Characters: You can set the display position of moving date, time and title, click on the “Up, Down, Left, Right” buttons to move the corresponding character position.
- Title Content: You can set Title Content (default is set to CAMERA1).
- Time Content: You can set Time Content (default is set to 1970/01/10 05:36:00).
- After clicking on the “Save” button, the “Save Successful” message will be displayed. Your selected time settings will now be visible.

### 5. Character Size

- Switch: Enable “Scale Size Automatically” function.
- Master Stream OSD Font Size: Set the character size of the display, the device will restart automatically after changed and saved (Default: 48).
- Slave Stream OSD Font Size: You can set the Character Size on the display. The device will restart automatically after changed and saved (Default: 48).
- After clicking on the “Save” button, the configuration will be validated when you see the “Parameter Saved Successfully” message displayed.

### 6. Video Output

- Default: 1080P29.97
- Optional: 1080P60, 1080P50, 1080P30, 1080P25, 1080I60, 1080I50, 720P60, 720P50, 720P30, 720P25, 1080P59.94, 1080I59.94, 720P59.94, 720P29.97
- By clicking on the “Save” button, the configuration will be validated when you see the “Save successful” message displayed.

## 4.2.6 Network Configuration

### 1. Network Port

- Data port: You can set the Data Port. The device will restart automatically after it's changed (Default: 3000; Optional: 0-65535).
- Web Port: You can set the Web Port. The device will restart automatically after changed (Default: 80; Optional: 0-65535).
- Onvif Port: You can set the Onvif Port. The device will restart automatically after changed (Default: 2000; Optional: 0-65535).
- Soap Port: You can set the Soap Port (Default: 1936; Optional: 0-65535).
- RTMP Port: You can set the RTMP Port (Default: 1935; Optional: 0-65535).
- RTSP Port: You can set the RTSP Port. The device will restart automatically after changed (Default: 554; Optional: 0-65535).
- Visca Port: You can set the Visca Port. The device will restart automatically after changed (Default: 1259; Optional: 0-65535).
- By clicking on the "Save" button, the configuration will be validated when you see the display message: "Save successful".
- RTMP access: RTMP: // equipment IP address: 1935 / live/av0 (av0 main stream; av1 second stream)
- RTMP Access: rtmp://equipment IP address: 1935 / live/av0 (av0 main stream; av1 second stream)

### 2. Ethernet Parameters

- DHCP: Enable or disable the option to obtain IP automatically can be set. By clicking on the "Save" button and rebooting the device, a display saying "Save successful" will be shown. The configuration will now be validated ( Default is set to ON).
- IP Address: You can set the IP Address. By clicking on the "Save" button and rebooting the device, a display saying "Save successful" will be shown. The configuration will now be validated. (Default is now set to 192.168.5.163). Note: This IP address is the same with the one used to login to the web page.
- Subnet Mask: You can set the Subnet Mask (Default is set to 255.255.255.0).
- Default Gateway: You can set the Default Gateway (Default is set to 0.0.0.0).
- MAC Address: You can set the Physical Address (The parameter is read-only and can not be modified).
- By clicking on the "Save" button, the configuration will be validated when you see the display message: "Save successful".

### 3. DNS Parameters

- Preferred DNS Server: You can set the preferred DNS server (Default is set to 0.0.0.0).
- Alternate DNS Server: Alternate DNS server settings (Default is set to 0.0.0.0).
- By clicking on the "Save" button, the configuration will be validated when you see the display message: "Save successful".

## 4. NDI

- Switch: Set NDI function on or off.  
NDI Name: User can change the NDI Name  
NDI Group: User can change the NDI Group
- By clicking on the “Save” button, the configuration will be validated when you see the display message: “Save successful”.

### 4.2.7 System Configuration

#### 1. System Attributes

- Device Name: Set the device name (Default is CAMERA-1. User can create their own).
- Device ID: Set the device ID (default is set to 1. Read-Only).
- System Language: Set the system language (Default: English; Optional: Simplified Chinese). Re-login after modification and save the setting.
- By clicking on the “Save” button, the configuration will be validated when you see the display message: “Save successful”

#### 2. System Time

- Date Format: You can set the Date Format (YYYY-MM-DD).
- Date Separator: (Default: “/” Optional: “.” and “-”).
- Time Zone: You can set the Time Zone.
- Hour Type: (Default: 24 hours; Optional: 12 hours).
- NTP Enable: Click the checkbox to turn the “NTP Enable” function on or off.
- Update Interval: You can set the NTP server to automatically update the time interval. Valid after setting NTP server synchronization (Default: One Day; Optional: 2-10 days).
- Host URL: You can set NTP server address or domain name (default time.nits.gov). Valid after setting NTP server synchronization.
- Host Port: You can set the NTP server port (Default: 123). Valid after setting NTP server synchronization.
- Set the time manually. Effective when set manually.
- Time Setting: You can set the Time Mode (choose the computer time synchronization, NTP server time synchronization, or set manually).
- Computer Time: You can set the Computer Time.
- By clicking on the “Save” button, the configuration will be validated when you see the display message: “Save successful”.

### 3. User Settings

- Authority: You can set the User Type (the default is set to Administrator. Common User 1, Common User 2 are optional)
- User name: You can set the User Name (Select User Administrator default admin; select a common user1 default user1; to select a common user 2 default user2; user can modify their own)
- Password: You can set a Password (Select User Administrator default admin; select a common user1 default user1; to select a common user 2 default user2; user can modify their own).
- Password Confirmation: Confirm the input passwords are the identical.
- By clicking on the “Save” button, the configuration will be validated when you see the display message: “Save successful”.
- Note: User name and Password are case-sensitive.

### 4. Version Upgrade

MCU version V2.0.0.16 2015-12-18

Camera version V2.0.0.16 2015-12-18

Focus version V2.0.0.6 2015-12-11.

Update File:

- Click “Browse ...” installation, to select the upgrade file in the pop-up window.
- Click on the “Upgrade” button. The upgrade dialog will appear. The device will reboot automatically after the update is successful. Make sure the power and network remains connected during the upgrading process.
- Note: If you need to restore factory defaults, choose one of the three options:
  - A. Through web to restore the factory default configuration.
  - B. Through the recovery menu.
  - C. Remote control shortcut: \* # 6.

### 5. Restore Factory Setting

- Click on “Restore Factory Defaults” button and choose “yes” or “no”, then the device will restart automatically and restore factory setting.

### 6. Reboot

- Click on the “Reboot” button and choose “yes” or “no”.
- The device will restart automatically.

## 4.2.8 Logout

Click “Logout.” When the pop-up “Confirmation” dialog appears, select “Yes” or “No”. Choose “Yes” to exit the current page and return to the user login interface again.

## 4.2.9 Wireless Network

If the user's equipment has a wireless network module, the web page “Network Configuration” has a “Wireless Network” configuration page. The specific configuration is as follows:

### 1. Network Settings

#### Wireless Network Configuration

- Enable Network Interface: You can check, to set the following items after checked.
- DHCP: If checked, it can obtain IP automatically.
- IP address: set wireless WIFI IP (default is set to 192.168.1.250. If checked DHCP, IP will be assigned automatically).

Note: Wireless IP address cannot be in the same segment with wired IP address.

- Subnet Mask: You can set the wireless IP subnet mask (Default: 255.255.255.0)
- Default Gateway: You can set the wireless IP default gateway (Default: 192.168.1.1)
- SSID: The user can modify their own (the default test).
- Encryption: Able to be checked. The password can be set after checked.
- Password: You can set the password. Password can be changed only if encryption is checked.

After clicking on the “Save” button, character settings will be validated when the “Parameter Saved Successfully” message is displayed.

Note: SSID and password should be filled in correctly; otherwise, if restarted after powered off, the wireless Wi-Fi connection will not be successful.

### 2. Wi-Fi Hot Link

- Click on the “search” button to search the WIFI hotspot.
- Double-click the dialog box after you've searched the user WIFI hotspot. Then input password to connect to WIFI. It will connect successfully after showing the “Successful Connect” window.

### 3. Wireless Wi-Fi Login Page

- If you do not check the above DHCP configuration (automatically obtain IP), then open the browser, enter the wireless network IP address in the address bar (Default: 192.168.1.250), press Enter to log construction.
- If you checked DHCP, then you will obtain IP automatically, just login specific router or switch user interface settings to view the allocation of IP address.

# 5. Serial Communication Control

Under common working condition, the camera could be controlled through RS232/RS485 interface (VISCA), RS232C serial parameter are as follows:

Baud rate: 2400/4800/9600/115200 bits / sec;

Start bit: 1; data bits: 8; Stop bit: 1; Parity: None.

## 5.1 VISCA Protocol List

### 5.1.1 Camera Return Command

ACK/Completion Message		
	Command Packet	Note
ACK	z0 41 FF	Returned when the command is accepted.
Completion	z0 51 FF	Returned when the command has been executed.

Error Messages		
	Command Packet	Note
Syntax Error	z0 60 02 FF	Returned when the command format is different or when a command with illegal command parameters is accepted
Command Not Executable	z0 61 41 FF	Returned when a command cannot be executed due to current conditions. For example,when commands controlling the focus manually are received during auto focus.



### 5.1.2 Camera Control Command

Command	Function	Command Packet	Notes
AddressSet	Broadcast	88 30 0p FF	p: Address setting
IF_Clear	Broadcast	88 01 00 01 FF	I/F Clear
CommandCancel		8x 21 FF	
CAM_Power	On	8x 01 04 00 02 FF	Power ON/OFF
	Off	8x 01 04 00 03 FF	
CAM_Zoom	Stop	8x 01 04 07 00 FF	p = 0(low) - F(high) pqrs: Zoom Position
	Tele(Standard)	8x 01 04 07 02 FF	
	Wide(Standard)	8x 01 04 07 03 FF	
	Tele(Variable)	8x 01 04 07 2p FF	
	Wide(Variable)	8x 01 04 07 3p FF	
	Direct	8x 01 04 47 0p 0q 0r 0s FF	
CAM_Focus	Stop	8x 01 04 08 00 FF	p = 0(low) - F(high) pqrs: Focus Position
	Far(Standard)	8x 01 04 08 02 FF	
	Near(Standard)	8x 01 04 08 03 FF	
	Far(Variable)	8x 01 04 08 2p FF	
	Near (Variable)	8x 01 04 08 3p FF	
	Direct	8x 01 04 48 0p 0q 0r 0s FF	
	Auto Focus	8x 01 04 38 02 FF	
	One Push Mode	8x 01 04 38 04 FF	
	Manual Focus	8x 01 04 38 03 FF	
CAM_Zoom Focus	Direct	8x 01 04 47 0p 0q 0r 0s 0t 0u 0v 0w FF	pqrs: Zoom Position tuvw: Focus Position
CAM_WB	Auto	8x 01 04 35 00 FF	
	3000K	8x 01 04 35 01 FF	
	4000k	8x 01 04 35 02 FF	
	One Push Mode	8x 01 04 35 03 FF	
	5000k	8x 01 04 35 04 FF	

Command	Function	Command Packet	Notes
CAM-WB (continued)	Manual	8x 01 04 35 05 FF	
	6500k	8x 01 04 35 06 FF	
	3500K	8x 01 04 35 07 FF	
	4500K	8x 01 04 35 08 FF	
	5500K	8x 01 04 35 09 FF	
	6000K	8x 01 04 35 0A FF	
	7000K	8x 01 04 35 0B FF	
CAM_RGain	Reset	8x 01 04 03 00 FF	Manual Control of R Gain
	Up	8x 01 04 03 02 FF	
	Down	8x 01 04 03 03 FF	
	Direct	8x 01 04 43 00 0p 0q FF	pq: R Gain
CAM_Bgain	Reset	8x 01 04 04 00 FF	Manual Control of B Gain
	Up	8x 01 04 04 02 FF	
	Down	8x 01 04 04 03 FF	
	Direct	8x 01 04 44 00 0p 0q FF	pq: B Gain
CAM_AE	Full Auto	8x 01 04 39 00 FF	Automatic Exposure mode
	Manual	8x 01 04 39 03 FF	Manual Control mode
	Shutter priority	8x 01 04 39 0A FF	Shutter Priority Automatic Exposure mode
	Iris Priority	8x 01 04 39 0B FF	Iris Priority Automatic Exposure mode
	Bright	8x 01 04 39 0D FF	Bright mode
CAM_Shutter	Reset	8x 01 04 0A 00 FF	Shutter Setting
	Up	8x 01 04 0A 02 FF	
	Down	8x 01 04 0A 03 FF	
	Direct	8x 01 04 4A 00 0p 0q FF	pq: Shutter Position
CAM_Iris	Reset	8x 01 04 0B 00 FF	Iris Setting
	Up	8x 01 04 0B 02 FF	
	Down	8x 01 04 0B 03 FF	
	Direct	8x 01 04 4B 00 0p 0q FF	pq: Iris Position
CAM_Gain Limit	Gain Limit	8x 01 04 2C 0p FF	p: Gain Positon

Command	Function	Command Packet	Notes
CAM_Bright	Reset	8x 01 04 0D 00 FF	Bright Setting
	Up	8x 01 04 0D 02 FF	
	Down	8x 01 04 0D 03 FF	
	Direct	8x 01 04 4D 00 00 0p 0q FF	pq: Bright Positon
CAM_ExpComp	On	8x 01 04 3E 02 FF	Exposure Compensation ON/OFF
	Off	8x 01 04 3E 03 FF	
	Reset	8x 01 04 0E 00 FF	Exposure Compensation Amount Setting
	Up	8x 01 04 0E 02 FF	
	Down	8x 01 04 0E 03 FF	
	Direct	8x 01 04 4E 00 00 0p 0q FF	pq: ExpComp Position
CAM_Back Light	On	8x 01 04 33 02 FF	Back Light Compensation
	Off	8x 01 04 33 03 FF	
CAM_WDRStrength	Reset	8x 01 04 21 00 FF	WDR Level Setting
	Up	8x 01 04 21 02 FF	
	Down	8x 01 04 21 03 FF	
	Direct	8x 01 04 51 00 00 00 0p FF	p: WDR Level Positon
CAM_NR (2D)		8x 01 04 53 0p FF	P=0-7 0:OFF
CAM_NR (3D)		8x 01 04 54 0p FF	P=0-8 0:OFF
CAM_Gamma		8x 01 04 5B 0p FF	p = 0 – 4 0: Default 1: 0.47 2: 0.50 3: 0.52 4: 0.55
CAM_Flicker	OFF	8x 01 04 23 00 FF	OFF
	50HZ	8x 01 04 23 01 FF	50HZ
	60HZ	8x 01 04 23 02 FF	60HZ
CAM_Aperture	Reset	8x 01 04 02 00 FF	Aperture Control
	Up	8x 01 04 02 02 FF	
	Down	8x 01 04 02 03 FF	
	Direct	8x 01 04 42 00 00 0p 0q FF	pq: Aperture Gain

Command	Function	Command Packet	Notes
CAM_Memory	Reset	8x 01 04 3F 00 pq FF	pq: Memory Number(=0 to 254) Corresponds to 0 to 9 on the Remote Commander
	Set	8x 01 04 3F 01 pq FF	
	Recall	8x 01 04 3F 02 pq FF	
CAM_LR_Reverse	On	8x 01 04 61 02 FF	Image Flip Horizontal ON/OFF
	Off	8x 01 04 61 03 FF	
CAM_PictureFlip	On	8x 01 04 66 02 FF	Image Flip Vertical ON/OFF
	Off	8x 01 04 66 03 FF	
CAM_ColorSaturation	Direct	8x 01 04 49 00 00 00 0p FF	P=0-7 0:60% 1:70% 2:80% 3:90% 4:100% 5:110% 6:120% 7:130%
CAM_IDWrite		8x 01 04 22 0p 0q 0r 0s FF	pqrs: Camera ID (=0000 to FFFF)
SYS_Menu	ON	8x 01 04 06 06 02 FF	Turn on the menu screen
	OFF	8x 01 04 06 06 03 FF	Turn off the menu screen
IR_Receive	ON	8x 01 06 08 02 FF	IR (remote commander) receive On/Off
	OFF	8x 01 06 08 03 FF	
IR_ReceiveReturn	On	8x 01 7D 01 03 00 00 FF	IR(remote commander) receive message via the VISCA communication ON/ OFF
	Off	8x 01 7D 01 13 00 00 FF	
CAM_SettingvReset	Reset	8x 01 04 A0 10 FF	Reset Factory Setting
CAM_Brightness	Direct	8x 01 04 A1 00 00 0p 0q FF	pq: Brightness Position
CAM_Contrast	Direct	8x 01 04 A2 00 00 0p 0q FF	pq: Contrast Position
CAM_Flip	OFF	8x 01 04 A4 00 FF	Single Command For Video Flip
	Flip-H	8x 01 04 A4 01 FF	
	Flip-V	8x 01 04 A4 02 FF	
	Flip-HV	8x 01 04 A4 03 FF	

Command	Function	Command Packet	Notes
CAM_VideoSystem	Set camera video system	8x 01 06 35 00 0p FF	P: 0~E Video Format 0:1080P60 5:720P50 1:1080P50 6:1080P30 2:1080i60 7:1080P25 3:1080i50 8:720P30 4:720P60 9:720P25  A: 1080P59.94 B: 1080i59.94 C: 720P59.94 D: 1080P29.97 E: 720P29.97
Pan_tiltDrive	Up	8x 01 06 01 W WW 03 01 FF	WV: Pan speed 0x01 (low speed) to 0x18 (high speed)  WW: Tilt speed 0x01 (low speed) to 0x14 (high speed)  YYYY: Pan Position  ZZZZ: Tilt Position
	Down	8x 01 06 01 W WW 03 02 FF	
	Left	8x 01 06 01 W WW 01 03 FF	
	Right	8x 01 06 01 W WW 02 03 FF	
	Upleft	8x 01 06 01 W WW 01 01 FF	
	Upright	8x 01 06 01 W WW 02 01 FF	
	DownLeft	8x 01 06 01 W WW 01 02 FF	
	DownRight	8x 01 06 01 W WW 02 02 FF	
	Stop	8x 01 06 01 W WW 03 03 FF	
	AbsolutePo- sition	8x 01 06 02 W WW 0Y 0Y 0Y 0Y 0Z 0Z 0Z 0Z FF	
	RelativePosition	8x 01 06 03 W WW 0Y 0Y 0Y 0Y 0Z 0Z 0Z 0Z FF	
	Home	8x 01 06 04 FF	
Reset	8x 01 06 05 FF		

Command	Function	Command Packet	Notes
Pan-tiltLimitSet	Set	8x 01 06 07 00 0W 0Y 0Y 0Y 0Y 0Z 0Z 0Z 0Z FF	W:1 UpRight 0:DownLeft  YYYY: Pan Limit Position(TBD)
	Clear	8x 01 06 07 01 0W 07 0F 0F 0F 07 0F 0F 0F FF	ZZZZ: Tilt Limit Position(TBD)

### 5.1.3 Inquiry Command

Command	Function	Command Packet	Notes
CAM_PowerInq	8x 09 04 00 FF	y0 50 02 FF	On
		y0 50 03 FF	Off(Standby)
CAM_ZoomPosInq	8x 09 04 47 FF	y0 50 0p 0q 0r 0s FF	pqrs: Zoom Position
CAM_FocusAFModelInq	8x 09 04 38 FF	y0 50 02 FF	Auto Focus
		y0 50 03 FF	Manual Focus
		y0 50 04 FF	One Push Mode
CAM_FocusPosInq	8x 09 04 48 FF	y0 50 0p 0q 0r 0s FF	pqrs: Focus Position
CAM_WBModelInq	8x 09 04 35 FF	y0 50 00 FF	Auto
		y0 50 01 FF	3000K
		y0 50 02 FF	4000K
		y0 50 03 FF	One Push Mode
		y0 50 04 FF	5000K
		y0 50 05 FF	Manual
		y0 50 00 FF	6500K
		y0 50 06 FF	6500K
		y0 50 07 FF	3500K
		y0 50 08 FF	4500K
		y0 50 09 FF	5500K
		y0 50 0A FF	6000K
		y0 50 0B FF	7000K
CAM_RGainInq	8x 09 04 43 FF	y0 50 00 00 0p 0q FF	pq: R Gain
CAM_BGainInq	8x 09 04 44 FF	y0 50 00 00 0p 0q FF	pq: B Gain

Command	Function	Command Packet	Notes
CAM_AEModelInq	8x 09 04 39 FF	y0 50 00 FF	Full Auto
		y0 50 03 FF	Manual
		y0 50 0A FF	Shutter Priority
		y0 50 0B FF	Iris Priority
		y0 50 0D FF	Bright
CAM_ShutterPosInq	8x 09 04 4A FF	y0 50 00 00 0p 0q FF	pq: Shutter Position
CAM_IrisPosInq	8x 09 04 4B FF	y0 50 00 00 0p 0q FF	pq: Iris Position
CAM_Gain LimitInq	8x 09 04 2C FF	y0 50 0p FF	p: Gain Positon
CAM_BrightPosInq	8x 09 04 4D FF	y0 50 00 00 0p 0q FF	pq: Bright Position
CAM_ExpCompModelInq	8x 09 04 3E FF	y0 50 02 FF	On
		y0 50 03 FF	Off
CAM_ExpCompPosInq	8x 09 04 4E FF	y0 50 00 00 0p 0q FF	pq: ExpComp Position
CAM_BacklightModelInq	8x 09 04 33 FF	y0 50 02 FF	On
		y0 50 03 FF	Off
CAM_WDRStrengthInq	8x 09 04 51 FF	y0 50 00 00 00 0p FF	p: WDR Strength
CAM_NRLevel(2D) Inq	8x 09 04 53 FF	y0 50 0p FF	P: 2DNRLevel
CAM_NRLevel(3D) Inq	8x 09 04 54 FF	y0 50 0p FF	P:3D NRLevel
CAM_FlickerModelInq	8x 09 04 55 FF	y0 50 0p FF	p: Flicker Settings(0: OFF,1: 50Hz,2:60Hz)
CAM_ApertureInq	8x 09 04 42 FF	y0 50 00 00 0p 0q FF	pq: Aperture Gain
CAM_PictureEffectModelInq	8x 09 04 63 FF	y0 50 00 FF	Off
		y0 50 04 FF	B&W
CAM_MemoryInq	8x 09 04 3F FF	y0 50 0p FF	p: Memory number last operated.
SYS_MenuModelInq	8x 09 06 06 FF	y0 50 02 FF	On
		y0 50 03 FF	Off
CAM_LR_ReverseInq	8x 09 04 61 FF	y0 50 02 FF	On
		y0 50 03 FF	Off
CAM_PictureFlipInq	8x 09 04 66 FF	y0 50 02 FF	On
		y0 50 03 FF	Off

Command	Function	Command Packet	Notes
CAM_ColorSaturationInq	8x 09 04 49 FF	y0 50 00 00 00 0p FF	p: Color Gain setting 0h (60%) to Eh (130%)
CAM_IDInq	8x 09 04 22 FF	y0 50 0p FF	p: Gamma ID
IR_ReceiveInq	8x 09 06 08 FF	y0 50 02 FF	On
		y0 50 03 FF	Off
IR_ReceiveReturn		y0 07 7D 01 04 00 FF	Power ON/OFF
		y0 07 7D 01 04 07 FF	Zoom tele/wide
		y0 07 7D 01 04 38 FF	AF ON/OFF
		y0 07 7D 01 04 33 FF	Camera _Backlight
		y0 07 7D 01 04 3F FF	Camera _Memery
		y0 07 7D 01 06 01 FF	Pan_titleDriver
CAM_BrightnessInq	8x 09 04 A1 FF	y0 50 00 00 0p 0q FF	pq: Brightness Position
CAM_ContrastInq	8x 09 04 A2 FF	y0 50 00 00 0p 0q FF	pq: Contrast Position
CAM_FlipInq	8x 09 04 A4 FF	y0 50 00 FF	Off
		y0 50 01 FF	Flip-H
		y0 50 02 FF	Flip-V
		y0 50 03 FF	Flip-HV
CAM_GammaInq	8x 09 04 5B FF	y0 50 0p FF	p: Gamma setting
CAM_VersionInq	8x 09 00 02 FF	y0 50 ab cd mn pq rs tu vw FF	ab cd: - vendor ID ( 0220) mn pq: - model ID ST (0950) U3 (3950) rs tu: - ARM Version vw: - Reserve



Command	Function	Command Packet	Notes
VideoSystemInq	8x 09 06 23 FF	y0 50 0p FF	P: 0~E Video format 0:1080P60 1:1080P50 2:1080i60 3:1080i50 4:720P60 5:720P50 6:1080P30 7:1080P25 8:720P30 9:720P25 A: 1080P59.94 B: 1080i59.94 C: 720P59.94 D: 1080P29.97 E: 720P29.97
Pan-tiltMaxSpeedInq	8x 09 06 11 FF	y0 50 ww zz FF	ww: Pan Max Speed zz: Tilt Max Speed
Pan-tiltPosInq	8x 09 06 12 FF	y0 50 0w 0w 0w 0w 0z 0z 0z 0z FF	www: Pan Position zzzz: Tilt Position

## 5.2 Pelco-D Protocol Command List

Function	Byte1	Byte2	Byte3	Byte4	Byte5	Byte6	Byte7
Up	0xFF	Address	0x00	0x08	Pan Speed	Tilt Speed	SUM
Down	0xFF	Address	0x00	0x10	Pan Speed	Tilt Speed	SUM
Left	0xFF	Address	0x00	0x04	Pan Speed	Tilt Speed	SUM
Right	0xFF	Address	0x00	0x02	Pan Speed	Tilt Speed	SUM
Upleft	0xFF	Address	0x00	0x0C	Pan Speed	Tilt Speed	SUM
Upright	0xFF	Address	0x00	0x0A	Pan Speed	Tilt Speed	SUM
DownLeft	0xFF	Address	0x00	0x14	Pan Speed	Tilt Speed	SUM
DownRight	0xFF	Address	0x00	0x12	Pan Speed	Tilt Speed	SUM
Zoom In	0xFF	Address	0x00	0x20	0x00	0x00	SUM
Zoom Out	0xFF	Address	0x00	0x40	0x00	0x00	SUM
Focus Far	0xFF	Address	0x00	0x80	0x00	0x00	SUM
Focus Near	0xFF	Address	0x01	0x00	0x00	0x00	SUM

Function	Byte1	Byte2	Byte3	Byte4	Byte5	Byte6	Byte7
Set Preset	0xFF	Address	0x00	0x03	0x00	Preset ID	SUM
Clear Preset	0xFF	Address	0x00	0x05	0x00	Preset ID	SUM
Call Preset	0xFF	Address	0x00	0x07	0x00	Preset ID	SUM
Query Pan Position	0xFF	Address	0x00	0x51	0x00	0x00	SUM
Query Pan Position Response	0xFF	Address	0x00	0x59	Value High Byte	Value Low Byte	SUM
Query Tilt Position	0xFF	Address	0x00	0x53	0x00	0x00	SUM
Query Tilt Position Response	0xFF	Address	0x00	0x5B	Value High Byte	Value Low Byte	SUM
Query Zoom Position	0xFF	Address	0x00	0x55	0x00	0x00	SUM
Query Zoom Position Response	0xFF	Address	0x00	0x5D	Value High Byte	Value Low Byte	SUM

### 5.3 Pelco-P Protocol Command List

Function	Byte1	Byte2	Byte3	Byte4	Byte5	Byte6	Byte7	Byte8
Up	0xA0	Address	0x00	0x08	Pan Speed	Tilt Speed	0xAF	XOR
Down	0xA0	Address	0x00	0x10	Pan Speed	Tilt Speed	0xAF	XOR
Left	0xA0	Address	0x00	0x04	Pan Speed	Tilt Speed	0xAF	XOR
Right	0xA0	Address	0x00	0x02	Pan Speed	Tilt Speed	0xAF	XOR
Upleft	0xA0	Address	0x00	0x0C	Pan Speed	Tilt Speed	0xAF	XOR
Upright	0xA0	Address	0x00	0x0A	Pan Speed	Tilt Speed	0xAF	XOR
DownLeft	0xA0	Address	0x00	0x14	Pan Speed	Tilt Speed	0xAF	XOR
DownRight	0xA0	Address	0x00	0x12	Pan Speed	Tilt Speed	0xAF	XOR
Zoom In	0xA0	Address	0x00	0x20	0x00	0x00	0xAF	XOR
Zoom Out	0xA0	Address	0x00	0x40	0x00	0x00	0xAF	XOR
Focus Far	0xA0	Address	0x01	0x00	0x00	0x00	0xAF	XOR
Focus Near	0xA0	Address	0x02	0x00	0x00	0x00	0xAF	XOR

Function	Byte1	Byte2	Byte3	Byte4	Byte5	Byte6	Byte7	Byte8
Set Preset	0xA0	Address	0x00	0x03	0x00	Preset ID	0xAF	XOR
Clear Preset	0xA0	Address	0x00	0x05	0x00	Preset ID	0xAF	XOR
Call Preset	0xA0	Address	0x00	0x07	0x00	Preset ID	0xAF	XOR
Query Pan Position	0xA0	Address	0x00	0x51	0x00	0x00	0xAF	XOR
Query Pan Position Response	0xA0	Address	0x00	0x59	Value High Byte	Value Low Byte	0xAF	XOR
Query Tilt Position	0xA0	Address	0x00	0x53	0x00	0x00	0xAF	XOR
Query Tilt Position Response	0xA0	Address	0x00	0x5B	Value High Byte	Value Low Byte	0xAF	XOR
Query Zoom Position	0xA0	Address	0x00	0x55	0x00	0x00	0xAF	XOR
Query Zoom Position Response	0xA0	Address	0x00	0x5D	Value High Byte	Value Low Byte	0xAF	XOR

## 6. Camera Maintenance and Troubleshooting

### 6.1 Camera Maintenance

1. If the camera hasn't been used for long time, please turn off the power adapter switch and AC plug.
2. Use a soft cloth or tissue to clean the camera cover.
3. Use soft cloth to clean the lens. Do not use strong or corrosive cleanser and avoiding scuffing.

### 6.2 Troubleshooting

1. No Video Output
  - A. Check whether the camera power supply is connected, that the voltage is normal, and that the power indicator is lit.
  - B. Check to see if the camera performs the self-inspection after restarted.
  - C. Check whether the bottom of the DIP switch is in the normal operating mode (see Table 2.2 pg 12)
  - D. Check whether the video output cable or video display is normal.

## 2. Image Dithering When Zooming In or Out

- A. Check whether the camera installation position is solid.
- B. Whether there is shaking machine or objects around the camera.

## 3. Remote Controller Not Working

- A. The remote control address could be set to 1 (if the has been set back to the factory defaults, the remote control addresses need to be set back to 1 also).
- B. Check if the batteries are low or if they are installed properly in the remote controller.
- C. Check if the camera working mode is the normal operating mode (see Table 2.2 pg 12).
- D. Check whether the menu is closed. Camera control through the remote controller is only available after exiting the menu. If video is being output from LAN, the menu will not be displayed. After the menu automatically exists 30 seconds later, it can be controlled by remote controller.

## 4. Serial Port Cannot Work

- A. Check if the camera serial device protocol, baud rate, and address are all consistent.
- B. Check if the control cable is connected properly.
- C. Check if the camera working mode is in the normal operating mode (see Table 2.2 pg 12)

# Learn More at [www.ikancorp.com](http://www.ikancorp.com)

## Support

Contact email: [support@ikancorp.com](mailto:support@ikancorp.com)

### **CONDITIONS OF WARRANTY SERVICE**

- Free service for one year from the day of purchase if the problem is caused by manufacturing errors.
- The components and maintenance service fee will be charged if the warranty period is expired.

**Free service will not be provided in the Following Situations: (\*Even if the product is still within the warranty period.)**

- Damage caused by abuse or misuse, dismantling, or changes to the product not made by the company.
- Damage caused by natural disaster, abnormal voltage, and environmental factors, etc.

©2020 Ikan International. All rights reserved.