

VERISMO™

FRESNEL WW



Blizzard Lighting, LLC
<http://www.blizzardpro.com>
Waukesha, WI USA
Copyright (c) 2022

TABLE OF CONTENTS

1. Getting Started	3
What's In The Box?	3
Getting It Out Of the Box	3
Powering Up!	3
Getting A Hold Of Us	3
Safety Instructions	4
2. Meet the Verismo™ Fresnel WW	5
Main Features	5
DMX Quick Reference	5
Verismo™ Fresnel WW Pin-Up Picture	6
The Rear Connections	6
3. Setup	7
Fuse Replacement	7
Connecting A Bunch of Verismo™ Fresnel Fixtures	7
Data/DMX Cabling	7
Cable Connectors	8
3-Pin??? 5-Pin??? Huh?!?	8
Take It To The Next Level: Setting Up DMX Control	8
Fixture Linking	9
Mounting & Rigging	9
4. Operating Adjustments	10
The Control Panel	10
Control Panel Menu Structure	11
Static Mode	12
Dimming Curves	12
Dimming Speed	12
Dimming Frequency	13
DMX Fail	13
Fan Settings	13
System Reset	13
DMX Values In-Depth	13
5. Appendix	14
Keeping Your Verismo™ Fresnel As Good As New	14
Returns (Gasp!)	14
Shipping Issues	14
Tech Specs!	15

1. GETTING STARTED

What's In The Box?

- Verismo™ Fresnel WW Fixture
- Power Cable
- This Lovely User Manual

Getting It Out Of the Box

Congratulations on purchasing the Verismo™ Profile WW. Now that you've got your fixture, you should carefully unpack the box and check the contents to ensure that all parts are present and in good condition. If anything looks as if it has been damaged in transit, notify the shipper immediately and keep the packing material for inspection. Again, please save the carton and all packing materials. If a fixture must be returned to the factory, it is important that the fixture be returned in the original factory box and packing.

Powering Up!

All fixtures must be powered directly off a switched circuit and **cannot be run off a rheostat (variable resistor) or dimmer circuit, even if the rheostat or dimmer channel is used solely for a 0% to 100% switch.**

Warning! All fixtures must be connected to circuits with a suitable Ground (Earthing).

Getting A Hold Of Us

If something happens to go wrong, visit blizzardpro.com/support and open a support ticket. We'll be happy to help, honest.

Disclaimer: The information contained in this document are subject to change without notice. Blizzard Lighting™ assumes no responsibility or liability for any errors or omissions that may appear in this user manual. We reserve the right to update the existing, or create a new document to correct any errors or omissions at any time. You can download the latest version of this document from www.blizzardpro.com.

Author:	Date:	Last Edited:	Date:
J. Thomas	1/24/2022	J. Thomas	7/13/2022

Safety Instructions



Please read these instructions carefully. They include important information about the installation, usage and maintenance of this product.

- Please keep this User Guide for future use. If you sell the unit to someone else, be sure that they also receive this User Guide.
- ALWAYS make sure that you are connecting to the proper voltage, and that the line voltage you are connecting to is not higher than that stated on the decal or rear panel of the fixture.
- This product is intended for indoor use only.
- To prevent risk of fire or shock, do not expose fixture to rain or moisture.
- Make sure there are no flammable materials close to the unit while operating.
- The unit must be installed in a location with adequate ventilation, at least 20in (50cm) from adjacent surfaces. Be sure that no ventilation slots are blocked.
- ALWAYS disconnect from the power source before servicing or replacing fuse and be sure to replace with same fuse size and type.
- ALWAYS secure fixture using a safety chain. NEVER carry the fixture by its head. Use its carrying handles.
- DO NOT operate at ambient temperatures higher than 104°F (40°C).
- In the event of a serious operating problem, stop using the unit immediately. NEVER try to repair the unit by yourself. Repairs carried out by unskilled people can lead to damage or malfunction. Please contact the nearest authorized technical assistance center. Always use the same type spare parts.
- NEVER connect the device to a dimmer pack.
- Make sure the power cord is never crimped or damaged.
- Never disconnect the power cord by pulling or tugging on the cord.
- Avoid direct eye exposure to the light source while it is on.

Caution! There are no user serviceable parts inside the unit. Do not open the housing or attempt any repairs yourself. In the unlikely event your unit may require service, please open a support ticket at www.blizzardpro.com/support.

2. MEET THE VERISMO™ FRESNEL WW

Main Features

- Light source: 300W WW COB LED
- Color temperature: 3200K, CRI: 97
- 18°-65° motorized zoom
- 16-bit dimming, with 4 user-selectable dimming curves
- User selectable dimming speeds (low/medium/high)
- 1-25Hz strobe effects
- Flicker-free resolution, perfect for video
- Adjustable LED refresh rates (1000-8000 Hz)
- Aluminum housing (black)
- PowerCON® TRUE1™ compatible in/out power connectors
- 3/5-pin male/female XLR input & output connections

Control

- Control system: STM32 control chip, DMX-512
- DMX channels: 2/3/4/6-channels
- Easy-to-use 4-button control panel with OLED display
- Operating modes: DMX-512, standalone

DMX Quick Reference (2/3/4/6-Channel Modes)

2-CH	3-CH	4-CH	6-CH	What It Does
1	1	1	1	Dimmer (0% <--> 100%)
--	2	2	2	Dimmer Fine (0% <--> 100%)
2	3	3	3	Zoom (wide <--> narrow)
--	--	4	4	Strobe (slow <--> fast)
--	--	--	5	Dimming Speed
--	--	--	6	Dimming Curves

Verismo™ Fresnel WW Pin-Up Picture



The Rear Connections

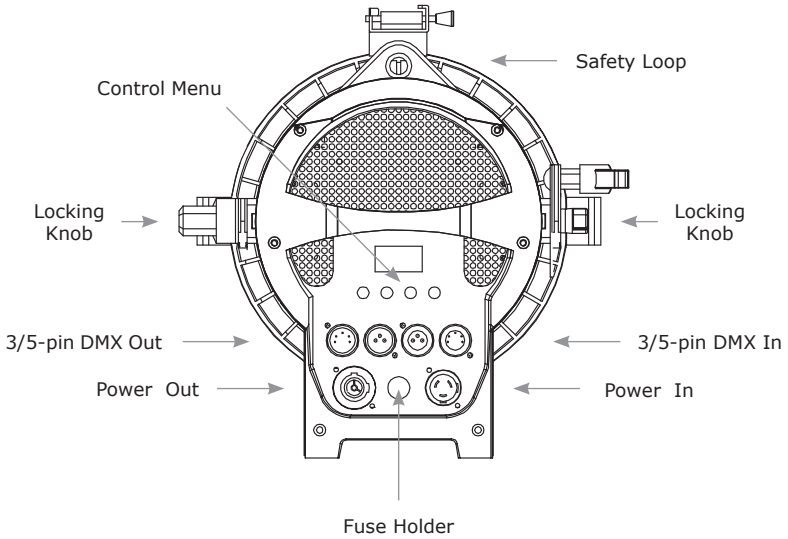

3. SETUP



Before replacing the fuse, disconnect the power cord.
ALWAYS replace it with the same type and rating.

Fuse Replacement

Remove the fuse holder from of its housing. Then take out the damaged fuse from its holder and replace with exact same type of fuse. Reattach the fuse holder, and then reconnect power.

Connecting A Bunch of Verismo™ Fresnel Fixtures

You can use a serial data link to run light shows when using a DMX-512 controller with two or more fixtures. The combined number of channels required by all the fixtures on a serial data link determines the number of fixtures the data link can support.

Fixtures on a serial data link must be daisy chained in one single line. Also, connecting more than 32 fixtures on one serial data link without the use of a DMX optically-isolated splitter may result in deterioration of the digital DMX signal. The maximum recommended cable-run distance is 500 meters (1640 ft). The maximum recommended number of fixtures on a serial data link is 32 fixtures.

Data/DMX Cabling

To link fixtures together you'll need data cables. You should use data-grade cables that can carry a high quality signal and are less prone to electromagnetic interference.

For instance, Belden© 9841 meets the specifications for EIA RS-485 applications. Standard microphone cables will "probably" be OK, but note that they cannot transmit DMX data as reliably over long distances. The cable should have the following characteristics:

- 2-conductor twisted pair plus a shield
- Maximum capacitance between conductors – 30 pF/ft.
- Maximum capacitance between conductor & shield – 55 pF/ft.
- Maximum resistance of 20 ohms / 1000 ft.
- Nominal impedance 100 – 140 ohms

Cable Connectors

Cables must have a male XLR connector on one end and a female XLR connector on the other end. (Duh!)

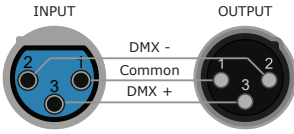

A Word on Termination:

DMX is a resilient communication protocol, however errors still occasionally occur. Termination reduces signal errors, and therefore best practices include use of a terminator in all circumstances. If you are experiencing problems with erratic fixture behavior, especially over long signal cable runs, a terminator may help improve performance.

To build your own DMX Terminator:

Obtain a 120-ohm, 1/4-watt resistor, and wire it between pins 2 & 3 of the last fixture. They are also readily available from specialty retailers.

CAUTION: Do not allow contact between the common and the fixture's chassis ground. Grounding the common can cause a ground loop, and your fixture may perform erratically. Test cables with an ohm meter to verify correct polarity and to make sure the pins are not grounded or shorted to the shield or each other.

3-Pin??? 5-Pin??? Huh?!?

This fixture is equipped with both 3-pin and 5-pin XLR sockets for DMX input and output. The sockets are wired in parallel. Only use a shielded twisted pair cable designed for RS-485 and 3/5-pin XLR connectors to connect the controller to the fixture, or the fixture to another fixture.

Conductor	3-Pin Female (Output)	5-Pin Male (Input)
Ground/Shield	Pin 1	Pin 1
Data 1- (Primary Data Link)	Pin 2	Pin 2
Data 1+ (Primary Data Link)	Pin 3	Pin 3
Data 2- (Optional Secondary Data Link)	--	Pin 4 - Do Not Use
Data 2+ (Optional Secondary Data Link)	--	Pin 5 - Do Not Use

Take It To The Next Level: Setting Up DMX Control

Step 1: Connect the male connector of the DMX cable to the female connector (output) on the controller.

Step 2: Connect the female connector of the DMX cable to the first fixture's male connector (input).

Note: It doesn't matter which fixture address is the first one connected. We recommend connecting the fixtures in terms of their proximity to the controller, rather than connecting the lowest fixture number first, and so on.

Step 3: Connect other fixtures in the chain from output to input as above. Place a DMX terminator on the output of the final fixture to ensure best communication.

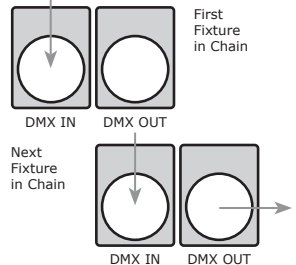

Fixture Linking

1. Connect the male connector side of the DMX cable to the output female connector of the first fixture.

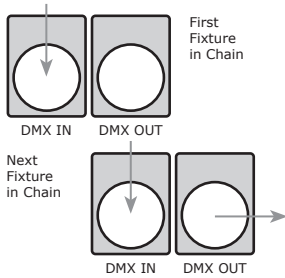

2. Connect the end of the cable coming from the first fixture which will have a female connector to the input connector of the next fixture consisting of a male connector. Then, proceed to connect from the output as stated above to the input of the following fixture and so on.

Mounting & Rigging

This fixture may be mounted in any SAFE position provided there is enough room for ventilation. The fan or vent pathway must never be obstructed.

IMPORTANT: Regardless of the rigging option you choose for your fixtures, always be sure to secure your fixture with a safety cable.

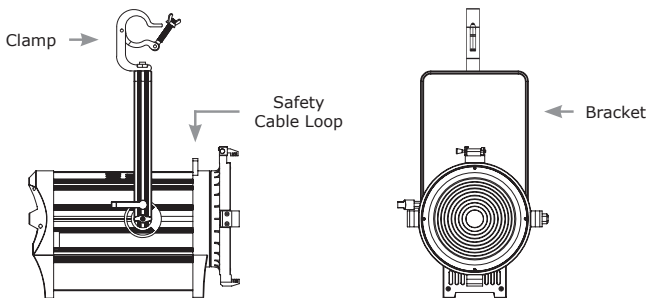

Mount the fixture using a suitable "C" or "O" type clamp. The clamp should be rated to hold at least 10x the fixture's weight to ensure structural stability. Do not mount to surfaces of unknown strength, and ensure properly rated rigging is used when mounting fixtures overhead.

Overhead mounting requires extensive experience, which includes calculating working load limits, knowledge of the installation material being used, and periodic safety inspections. If you lack these qualifications, do not attempt the installation yourself.

4. OPERATING ADJUSTMENTS

The Control Panel

All the features and different modes possible with the Verismo™ Fresnel are accessed by using the control panel on the rear of the fixture. There are 4 control buttons under the menu display which allow you to navigate through the various control panel menus.

<MENU>

Is used to navigate to the previous higher-level menu item.

<UP>

Scrolls through menu items and numbers in ascending order.

<DOWN>

Scrolls through menu items and numbers in descending order.

<ENTER>

Is used to select and confirm/store the current selection.

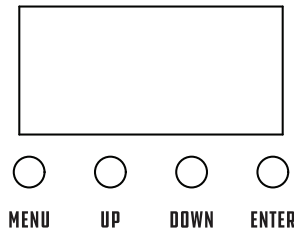

The control panel display shows the menu items you select from the menu map on page #11. When a menu function is selected, the display will show immediately the first available option for the selected menu function. To select a menu item, press **<ENTER>**.

Use the **<UP>** and **<DOWN>** buttons to navigate the menu options. Press the **<ENTER>** button to select the menu function currently displayed, or to enable a menu option. To return to the previous option or menu without changing the value, press the **<MENU>** button.

Control Panel Menu Structure

DMX	Address	Set the starting address (1-512)	
	Control Mode	2-CH	
		3-CH	
		4-CH	
6-CH			
Static	Dimmer	Dimmer (0% <--> 100%)	
	Dimmer Fine	Fine dimming (0% <--> 100%)	
	Strobe	Strobe (slow <--> fast)	
	Zoom	Zoom (wide <--> narrow)	
Personality	Dim Curve	Linear	
		Square law	
		Inv square law	
		S Curve	
	Dim Speed	Off	
		Low	
		Medium	
		High	
	Frequency	1000Hz	
		1200Hz	
		1500Hz	
		2000Hz	
		4000Hz	
		8000Hz	
	Fan Mode	Full	
		Auto	
Silent			
DMX Fail	Hold		
	Blackout		
Info	Version	Shows current firmware version	
	RDM UID	Unique RDM ID	
	Usage Time	Power on	Total running hrs.
		LED total	LED running hrs.
	Temperature	Celsius (°C)	
Fahrenheit (°F)			
Reset	Yes/No	Load factory defaults	

DMX Mode

Allows the unit to be controlled by any universal DMX controller.

Select the Channel Mode

- 1.) Navigate the menu to reach **DMX**, and press **<ENTER>**.
- 2.) Use the **<UP/DOWN>** buttons to select **Control Mode**, then **<ENTER>**.
- 3.) Then use the **<UP/DOWN>** buttons to select **CH-2, CH-3, CH-4, or CH-6**, and press **<ENTER>** to confirm.

Select the Starting DMX Address

- 1.) Navigate the menu to reach **DMX**, and press **<ENTER>**.
- 2.) Use the **<UP/DOWN>** buttons to select **Address**, then **<ENTER>**.
- 3.) Then use the **<UP/DOWN>** buttons to select a value from 1-512, and press **<ENTER>** to confirm.

Static Mode

- 1.) Navigate the menu to reach **Static**, and press **<ENTER>**.
- 2.) Use the **<UP/DOWN>** buttons highlight **Dimmer, Dimmer Fine, Strobe, or Zoom** and press **<ENTER>**.
- 3.) The **Dimmer** values will increase/decrease the brightness from 0% to 100%, **Strobe** values will change the effect (slow to fast), and **Zoom** will adjust the zoom level (wide to narrow).

Dimming Curves

- 1.) Navigate the menu to reach **Personality**, and press **<ENTER>**.
- 2.) Use **<UP/DOWN>** to highlight **Dim Curve**, and press **<ENTER>**.
- 3.) Then use the **<UP/DOWN>** buttons to select **Linear, Square Law, Inv Square Law, or S Curve**, and press **<ENTER>**.

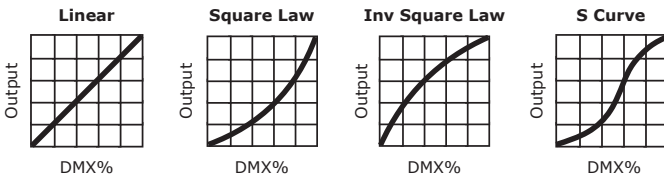

Note: Smoother (and slower) dimming capabilities can be achieved with use of the 4 available dimming curve settings.

Dimming Speed

Allows you to set a fade speed of either Low, Medium, or High. This can help simulate fade speeds of incandescent lamps.

- 1.) Navigate the menu to reach **Personality**, and press **<ENTER>**.
- 2.) Use the **<UP/DOWN>** buttons to select **Dim Speed**. Press **<ENTER>**.
- 3.) Then use the **<UP/DOWN>** buttons highlight **Off, Low, Medium, or High**, then press the **<ENTER>** button.

Dimming Frequency

- 1.) Navigate the menu to reach **Personality**, and press **<ENTER>**.
- 2.) Use the **<UP/DOWN>** buttons to select **Frequency**, then **<ENTER>**.
- 3.) Then use the **<UP/DOWN>** buttons to select a dimming frequency ranging from **1000Hz-8000Hz**, and press **<ENTER>** to confirm.

DMX Fail

This setting allows you to choose to either hold the last received signal or blackout the fixture if the DMX signal is lost.

- 1.) Navigate the menu to reach **Personality**, and press **<ENTER>**.
- 2.) Use the **<UP/DOWN>** buttons to select **DMX Fail**, then **<ENTER>**.
- 3.) Then use the **<UP/DOWN>** buttons to select **Hold** or **Blackout**, and press **<ENTER>** to confirm.

Fan Settings

- 1.) Navigate the menu to reach **Personality**, and press **<ENTER>**.
- 2.) Use the **<UP/DOWN>** buttons to select **Fan Mode**, then **<ENTER>**.
- 3.) Then use the **<UP/DOWN>** buttons to highlight **Full**, **Auto**, or **Silent**, and press **<ENTER>** to confirm.

System Reset

- 1.) Navigate the menu to reach **Reset**, and press **<ENTER>**.
- 2.) Then use the **<UP/DOWN>** buttons to highlight **Yes** or **No**, and press **<ENTER>** to confirm, or **<MENU>** to exit.

DMX Values In-Depth (2/3/4/6-Channel Modes)

2-CH	3-CH	4-CH	6-CH	Value	What It Does
1	1	1	1	000 <-> 255	Dimmer (0% <--> 100%)
--	2	2	2	000 <-> 255	Dimmer Fine (0% <--> 100%)
2	3	3	3	000 <-> 255	Zoom (wide <--> narrow)
--	--	4	4	000 <-> 005 006 <-> 255	Strobe No function Strobe (slow <--> fast)
--	--	--	5	000 <-> 030 031 <-> 060 061 <-> 090 091 <-> 255	Dimming Speed No Function Low Medium High
--	--	--	6	000 <-> 050 051 <-> 100 101 <-> 150 151 <-> 255	Dimming Curves Linear Square law Inverse square law S curve

5. APPENDIX

Keeping Your Verismo™ Fresnel As Good As New

The fixture you've received is a rugged, tough piece of pro lighting equipment, and as long as you take care of it, it will take care of you. That said, you'll need to take care of it if you want it to operate as designed. You should keep the fixture clean, especially if you are using it in an environment with a lot of dust, fog, haze, wild animals, wild teenagers or spilled drinks.

Cleaning the optics routinely with a suitable glass cleaner will greatly improve the quality of light output. Keeping the fans free of dust and debris will keep the fixture running cool and prevent damage from overheating.

In transit, keep the fixtures in cases. You wouldn't throw a prized guitar, drumset, or other piece of expensive gear into a gear trailer without a case, and similarly, you shouldn't even think about doing it with your shiny new light fixtures.

Common sense and taking care of your fixtures will be the single biggest thing you can do to keep them running at peak performance and let you worry about designing a great light show, putting on a great concert, or maximizing your client's satisfaction and "wow factor." That's what it's all about, after all!

Returns (Gasp!)

We've taken a lot of precautions to make sure you never even have to worry about sending a defective unit back, or sending a unit in for service. But, like any complex piece of equipment designed and built by humans, once in a while, something doesn't go as planned. If you find yourself with a fixture that isn't behaving like a good little fixture should, you'll need to obtain a Return Authorization (RA).

Don't worry, this is easy. Just visit www.blizzardpro.com/support and open a support ticket, and we'll issue you an RA. Then, you'll need to send the unit to us using a trackable, pre-paid freight method. We suggest using USPS Priority or UPS. Make sure you carefully pack the fixture for transit, and whenever possible, use the original box & packing for shipping.

When returning your fixture for service, be sure to include the following:

- 1.) Your contact information (Name, Address, Phone Number, Email address).
- 2.) The RA# issued to you
- 3.) A brief description of the problem/symptoms.

We will, at our discretion, repair or replace the fixture. Please remember that any shipping damage which occurs in transit to us is the customer's responsibility, so pack it well!

Shipping Issues

Damage incurred in shipping is the responsibility of the shipper, and must be reported to the carrier immediately upon receipt of the items. Claims must be made within seven (7) days of receipt.

Tech Specs!

Weight & Dimensions	
Dimensions	17" x 12" x 18" (430 x 303 x 457 mm)
Weight	21 lbs. (9.5 kg)
Power	
Operating Voltage	100-240VAC, 50-60 Hz
Power	283W 2.33A, PF: .99
Fuse	3A 250V
Light Source	
LED	300W WW COB LED
Optical	
Luminous Intensity	22,034 Lux @ 2.5M (narrow), 9,886 Lux @ 2.5M (wide) 5,540 Lux @ 5M (narrow), 2,768 Lux @ 5M (wide)
Color Temperature	3200K, CRI: 97
Control	
Protocol	USITT DMX-512
DMX Channels	2/3/4/6-channel
Input/Output	3/5-pin XLR male/female
Operating Modes	DMX-512, standalone
Warranty	2-year limited warranty, does not cover malfunction caused by damage to LEDs.

Dimensional Drawings

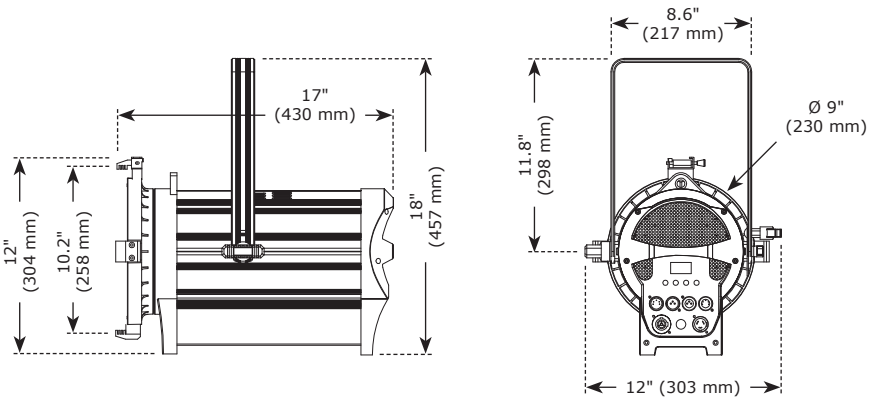



**Enjoy your product!
Our sincerest thanks for your purchase!
--The team @ Blizzard Lighting**