

Panasonic®

Operating Instruction

Operations and Settings

HD Integrated Camera

Model No. **AW-HE20KP**
Model No. **AW-HE20WP**
Model No. **AW-HE20KE**
Model No. **AW-HE20WE**
Model No. **AW-HE20KED**
Model No. **AW-HE20WED**

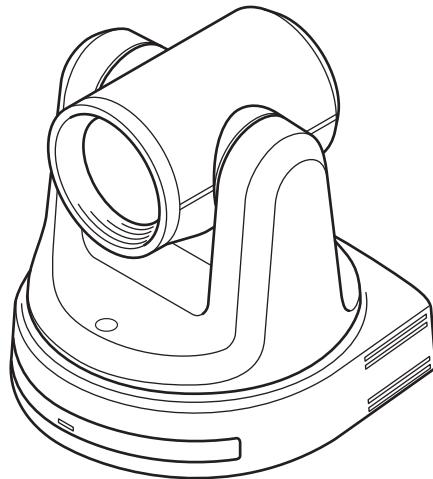

HDMI™

Operations and Settings
Operating Instructions

This "Operations and Settings" describes how to operate the unit and how to establish its settings.
For more information on how to perform basic operation and installation, refer to the Operating Instructions "Basics".

Read this first! (For AW-HE20KP, AW-HE20WP)

ENGLISH

WARNING:

- To reduce the risk of fire or electric shock, do not expose this equipment to rain or moisture.
- To reduce the risk of fire or electric shock, keep this equipment away from all liquids. Use and store only in locations which are not exposed to the risk of dripping or splashing liquids, and do not place any liquid containers on top of the equipment.

WARNING:

Always keep the main unit mounting screw, bracket mounting screws and drop-prevention wire mounting screw out of the reach of infants and small children.

WARNING:

Installation should only be performed by qualified installation personnel. Improper installation may result in the entire apparatus falling down and causing injury.

CAUTION:

Do not remove panel covers by unscrewing. To reduce the risk of electric shock, do not remove the covers.
No user serviceable parts inside.
Refer servicing to qualified service personnel.

CAUTION:

This apparatus can be operated at a voltage in the range of 100 – 240 V AC. Voltages other than 120 V are not intended for U.S.A. and Canada.
Operation at a voltage other than 120 V AC may require the use of a different AC plug. Please contact either a local or foreign Panasonic authorized service center for assistance in selecting an alternate AC plug.

CAUTION:

The mains plug of the power supply cord shall remain readily operable. The AC receptacle (mains socket outlet) shall be installed near the equipment and shall be easily accessible. To completely disconnect this equipment from the AC mains, disconnect the power cord plug from the AC receptacle.

CAUTION:

In order to maintain adequate ventilation, do not install or place this unit in a bookcase, built-in cabinet or any other confined space. To prevent risk of electric shock or fire hazard due to overheating, ensure that curtains and any other materials do not obstruct the ventilation.

CAUTION:

To reduce the risk of fire or electric shock and annoying interference, use the recommended accessories only.

CAUTION:

Check the installation at least once a year. An improper installation could cause the unit to fall off resulting in personal injury.

CAUTION:

To reduce the risk of fire or electric shock caused by damage to the power supply cord, do not squeeze, bend, or pull the power supply cord when using the apparatus.

 indicates safety information.

FCC NOTICE (USA)

Supplier's Declaration of

Conformity Trade Name: Panasonic

Model Number: AW-HE20KP/AW-HE20WP

Responsible Party: Panasonic Corporation of North America Two Riverfront Plaza, Newark, NJ 07102

Support contact: 1-800-524-1448

This device complies with part 15 of the FCC Rules. Operation is subject to the following two conditions:

(1) This device may not cause harmful interference, and (2) this device must accept any interference received, including interference that may cause undesired operation.

FCC Warning:

To assure continued FCC emission limit compliance, follow the attached installation instructions and the user must use only shielded interface cables when connecting to host computer or peripheral devices. Also, any unauthorized changes or modifications to this equipment could void the user's authority to operate this device.

FCC CAUTION:

This equipment has been tested and found to comply with the limits for a class A digital device, pursuant to Part 15 of the FCC Rules. These limits are designed to provide reasonable protection against harmful interference when the equipment is operated in a commercial environment. This equipment generates, uses, and can radiate radio frequency energy and, if not installed and used in accordance with the instruction manual, may cause harmful interference to radio communications.

Operation of this equipment in a residential area is likely to cause harmful interference in which case the user will be required to correct the interference at his own expense.

NOTIFICATION (Canada)

CAN ICES-003 (A)/NMB-003(A)

 indicates safety information.

■ The symbols on this product (including the accessories) represent the following. (Some symbols are not displayed on this unit.)

I ON

 Standby (OFF)

~ AC

== DC

 Class II equipment (The construction of the product is double-insulated.)

WARNING:

- To reduce the risk of fire or electric shock, do not expose this equipment to rain or moisture.
- To reduce the risk of fire or electric shock, keep this equipment away from all liquids. Use and store only in locations which are not exposed to the risk of dripping or splashing liquids, and do not place any liquid containers on top of the equipment.

WARNING:

Always keep the main unit mounting screw, bracket mounting screws and drop-prevention wire mounting screw out of the reach of infants and small children.

WARNING:

This equipment is compliant with Class A of CISPR 32.
In a residential environment this equipment may cause radio interference.

WARNING:

Installation should only be performed by qualified installation personnel.
Improper installation may result in the entire apparatus falling down and causing injury.

CAUTION:

Do not remove panel covers by unscrewing.
To reduce the risk of electric shock, do not remove the covers. No user serviceable parts inside.
Refer servicing to qualified service personnel.

CAUTION:

The mains plug of the power supply cord shall remain readily operable.
The AC receptacle (mains socket outlet) shall be installed near the equipment and shall be easily accessible. To completely disconnect this equipment from the AC mains, disconnect the power cord plug from the AC receptacle.

CAUTION:

In order to maintain adequate ventilation, do not install or place this unit in a bookcase, built-in cabinet or any other confined space. To prevent risk of electric shock or fire hazard due to overheating, ensure that curtains and any other materials do not obstruct the ventilation.

CAUTION:

To reduce the risk of fire or electric shock and annoying interference, use the recommended accessories only.

CAUTION:

Check the installation at least once a year. An improper installation could cause the unit to fall off resulting in personal injury.

 indicates safety information.

Turkey Only
AEEE Yönetmeliğine Uygundur.
AEEE Complies with Directive of Turkey.

Caution for AC Mains Lead

FOR YOUR SAFETY PLEASE READ THE FOLLOWING TEXT CAREFULLY.

This product is equipped with 2 types of AC mains cable. One is for continental Europe, etc. and the other one is only for U.K.

Appropriate mains cable must be used in each local area, since the other type of mains cable is not suitable.

FOR CONTINENTAL EUROPE, ETC.

Not to be used in the U.K.



FOR U.K. ONLY

If the plug supplied is not suitable for your socket outlet, it should be cut off and appropriate one fitted.

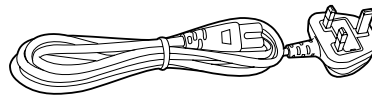



FOR U.K. ONLY

This appliance is supplied with a moulded three pin mains plug for your safety and convenience.

A 13 amp fuse is fitted in this plug.

Should the fuse need to be replaced please ensure that the replacement fuse has a rating of 13 amps and that it is approved by ASTA or BSI to BS1362.

Check for the ASTA mark  or the BSI mark on  the body of the fuse.

If the plug contains a removable fuse cover you must ensure that it is refitted when the fuse is replaced.

If you lose the fuse cover the plug must not be used

until a replacement cover is obtained.

A replacement fuse cover can be purchased from your local Panasonic Dealer.

How to replace the fuse

1. Open the fuse compartment with a screwdriver.

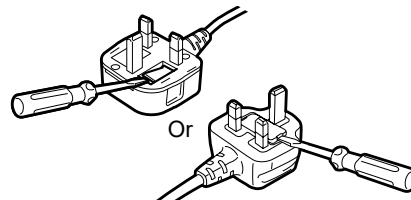

2. Replace the fuse.

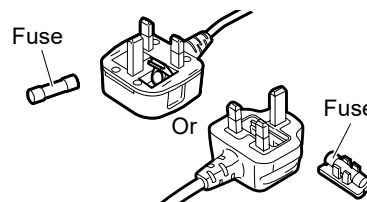

 indicates safety information.

Importer for UK:

Panasonic Connect UK,

a branch of Panasonic Connect Europe GmbH,

Maxis 2, Western Road, Bracknell, Berkshire, RG12 1RT

UK
CA

EMC NOTICE FOR THE PURCHASER/USER OF THE APPARATUS

1. Pre-requisite conditions to achieving compliance with the above standards

<1> Peripheral equipment to be connected to the apparatus and special connecting cables

- The purchaser/user is urged to use only equipment which has been recommended by us as peripheral equipment to be connected to the apparatus.
- The purchaser/user is urged to use only the connecting cables described below.

<2> For the connecting cables, use shielded cables which suit the intended purpose of the apparatus.

- **Video signal connecting cables**
Use double shielded coaxial cables, which are designed for 75-ohm type high-frequency applications, for SDI (Serial Digital Interface).
Coaxial cables, which are designed for 75-ohm type high-frequency applications, are recommended for analog video signals.
- **Audio signal connecting cables**
If your apparatus supports AES/EBU serial digital audio signals, use cables designed for AES/EBU.
Use shielded cables, which provide quality performance for high-frequency transmission applications, for analog audio signals.
- **Other connecting cables (IEEE1394, USB)**
Use double shielded cables, which provide quality performance for high-frequency applications, as connecting cables.
- When connecting to the DVI signal terminal, use a cable with a ferrite core.
- If your apparatus is supplied with ferrite core(s), they must be attached on cable(s) following instructions in this manual.

2. Performance level

The performance level of the apparatus is equivalent to or better than the performance level required by these standards.

However, the apparatus may be adversely affected by interference if it is being used in an EMC environment, such as an area where strong electromagnetic fields are generated (by the presence of signal transmission towers, cellular phones, etc.). In order to minimize the adverse effects of the interference on the apparatus in cases like this, it is recommended that the following steps be taken with the apparatus being affected and with its operating environment:

1. Place the apparatus at a distance from the source of the interference.
2. Change the direction of the apparatus.
3. Change the connection method used for the apparatus.
4. Connect the apparatus to another power outlet where the power is not shared by any other appliances.

Manufactured by: Panasonic Connect Co., Ltd.

4-1-62 Minoshima, Hakata-ku, Fukuoka 812-8531, Japan

Importer: Panasonic Connect Europe GmbH

Authorized Representative in EU: Panasonic Testing Centre



Winsbergring 15, 22525 Hamburg, Germany

Read this first!

(For AW-HE20KE, AW-HE20WE, AW-HE20KED, AW-HE20WED) (continued)

ENGLISH

- The symbols on this product (including the accessories) represent the following. (Some symbols are not displayed on this unit.)

I	ON
	Standby (OFF)
~	AC
==	DC
	Class II equipment (The construction of the product is double-insulated.)



Disposal of Old Equipment

Only for European Union and countries with recycling systems

This symbol on the products, packaging, and/or accompanying documents means that used electrical and electronic products must not be mixed with general household waste.

For proper treatment, recovery and recycling of old products, please take them to applicable collection points in accordance with your national legislation.

By disposing of them correctly, you will help to save valuable resources and prevent any potential negative effects on human health and the environment. For more information about collection and recycling, please contact your local authority, dealer or supplier.

Penalties may be applicable for incorrect disposal of this waste, in accordance with national legislation.

Trademarks and Registered Trademarks

- Microsoft[®], Windows[®], Windows[®] 7, Windows[®] 10, Microsoft Edge, and Internet Explorer[®] are either registered trademarks or trademarks of Microsoft Corporation in the United States and other countries.
- Apple, Mac, macOS, OS X, Safari are registered trademarks of Apple Inc., in the United States and other countries.
- Google Chrome[™] browser trademarks of Google LLC.
- Intel[®] and Intel[®] Core[™] are trademarks or registered trademarks of Intel Corporation in the United States and other countries.
- Adobe[®] and Reader[®] are either registered trademarks or trademarks of Adobe Systems Incorporated in the United States and/or other countries.
- The terms HDMI and HDMI High-Definition Multimedia Interface, and the HDMI Logo are trademarks or registered trademarks of HDMI Licensing Administrator, Inc. in the United States and other countries.
- Other names of companies and products contained in these Operating Instructions may be trademarks or registered trademarks of their respective owners.

About Copyright and License

Distributing, copying, disassembling, reverse compiling, reverse engineering, and also exporting in violation of export laws of the software provided with this unit are expressly prohibited.

Abbreviations

For the purposes of this manual, the model numbers of the units are given as listed in the table below.

Model number of unit	Model number given in manual
AW-HE20KP, AW-HE20WP AW-HE20KE, AW-HE20WE AW-HE20KED, AW-HE20WED	AW-HE20
AW-RP60	AW-RP60
AW-RP150G	AW-RP150

Illustrations and screen displays featured in the manual

What is shown in the manual's illustrations and screen displays may differ from how it is actually appears.

Disclaimer of Warranty

IN NO EVENT SHALL Panasonic Connect Co., Ltd. BE LIABLE TO ANY PARTY OR ANY PERSON, EXCEPT FOR REPLACEMENT OR REASONABLE MAINTENANCE OF THE PRODUCT, FOR THE CASES, INCLUDING BUT NOT LIMITED TO BELOW:

1. ANY DAMAGE AND LOSS, INCLUDING WITHOUT LIMITATION, DIRECT OR INDIRECT, SPECIAL, CONSEQUENTIAL OR EXEMPLARY, ARISING OUT OF OR RELATING TO THE PRODUCT;
2. PERSONAL INJURY OR ANY DAMAGE CAUSED BY INAPPROPRIATE USE OR NEGLIGENT OPERATION OF THE USER;
3. UNAUTHORIZED DISASSEMBLE, REPAIR OR MODIFICATION OF THE PRODUCT BY THE USER;
4. INCONVENIENCE OR ANY LOSS ARISING WHEN IMAGES ARE NOT DISPLAYED, DUE TO ANY REASON OR CAUSE INCLUDING ANY FAILURE OR PROBLEM OF THE PRODUCT;
5. ANY PROBLEM, CONSEQUENTIAL INCONVENIENCE, OR LOSS OR DAMAGE, ARISING OUT OF THE SYSTEM COMBINED BY THE DEVICES OF THIRD PARTY;
6. ANY DEMANDS FOR COMPENSATION, CLAIMS, ETC. OCCASIONED BY THE INFRINGEMENT OF PRIVACY BY INDIVIDUALS OR ORGANIZATIONS WHOSE IMAGES WERE SHOT BY THE USER BECAUSE THESE IMAGES (INCLUDING THE RECORDINGS MADE) WERE MADE AVAILABLE BY THE USER BECAUSE IN THE PUBLIC DOMAIN. FOR SOME REASON OR OTHER OR BECAUSE THE IMAGES ENDED UP BEING USED FOR PURPOSES OTHER THAN THE ONE DESCRIBED ABOVE;
7. LOSS OF REGISTERED DATA CAUSED BY ANY FAILURE.

Contents

Operating Instructions.....	2
Read this first! (For AW-HE20KP, AW-HE20WP).....	2
Disclaimer of Warranty.....	9
Getting Started.....	14
Required Personal Computer Environment.....	14
Network security.....	15
Characteristics.....	16
Accessories.....	18
Optional Accessories.....	18
Operating Precautions.....	19
Parts and Functions.....	21
Wireless Remote Control (optional accessory).....	25
Network Settings.....	29
Use the Easy IP setup Software.....	29
Use the EasyIP Setup Tool Plus Software to Establish the Unit's Settings.....	31
Setting the Initial Account.....	33
Basic Shooting Operation.....	35
Power on and Power Off the Camera Unit.....	36
Power on the Camera Unit.....	36
Power off the Camera Unit.....	36
Priority Mode.....	37
Selecting the Scene Mode.....	39
Scene Mode Types.....	39
How to select the Scene mode.....	39
Operating the Camera unit.....	41
Control the Picture's Direction (using the wireless remote control).....	41
Zoom In/Out Function (using the wireless remote control).....	41
Switching the Direction or Zoom Speed (using the wireless remote control).....	41
Control the Picture's Direction (using the controller).....	41
Zoom In/Out Function (using the controller).....	41
Switching the Direction or Zoom Speed (using the controller).....	41
What to do when Encountering Problems in the Basic Shooting Operations.....	42
Advanced Operations.....	43
Preset Memories.....	43
Adjust the White Balance.....	44
Automatic Adjustment (AWB: AWB A or AWB B).....	44
Auto Tracking White Balance Adjustment (ATW).....	45
3200K and 5600K Presets.....	45
Menu Operation.....	46
Operations Table.....	46

When performing the operations using the wireless remote control	46
Menu Items	48
Main Menu Screen	48
Camera Menu	48
Scene	49
Picture Level	49
AGC MaxGain	49
Slow Shutter	50
Iris Mode	50
Shutter Mode	50
Gain	51
Frame Mix	51
Auto F. Mix Max Gain	51
Chroma Level	51
White Balance Mode	52
R Gain	52
B Gain	52
Pedestal	52
Detail	53
Contrast	53
DRS	53
Back Light COMP	53
DNR	53
System Menu	54
Priority Mode	54
Frequency	55
Format	56
Install Position	57
Preset Speed Table	57
Preset Speed	57
Preset Scope	57
Speed with Zoom Position	58
Focus Mode	58
Focus Adjust With PTZ	58
Zoom Mode	58
Max Digital Zoom	59
Digital Extender	59
Tally	59
Wireless ID	60
OSD off with Tally	60
Color Bar	60
Audio	60

Input Type.....	61
Volume Level.....	61
Plugin Power	61
Serial Com. Protocol.....	61
Connector Select.....	61
Baud Rate	62
Camera Address.....	62
Language	63
Firmware Version	63
IP Address	64
Subnet Mask	64
Default Gateway.....	64
MAC Address	64
Initialize	65
Menu Table	66
Web Screen Start-up	69
Switching between Live and Setup Screen	71
Web Live Screen Operation.....	72
Select the Setup Screen.....	75
Basic Settings.....	76
Selecting Priority Mode.....	76
Live Page (Camera Title).....	77
Date & Time.....	78
Image/Audio Settings	79
Video over IP	79
Audio	81
System Settings	91
User Mng. (User Management).....	97
User auth. (User authentication).....	97
Network Settings	99
Network	99
RTMP Setting	103
NTP	104
Maintenance Settings	106
Language	106
Product Info.....	107
Default Reset.....	109
System Log	110
Backup	112
Controllable functions.....	113
Troubleshooting	115
Operation.....	115

Video	117
IP images	118
USB	118
Specification	119
Index.....	123

Getting Started

Required Personal Computer Environment

CPU	Intel® Core™ i5 3.2 GHz or higher (Skylake 6500 or later)
Memory	4 GB or more
Network function	100BASE-T/TX or 1000BASE-T, RJ-45 connector
Image display	Resolution: 1920 x 1080 pixels or more Color generation: True Color 24-bit or more
Supported operating systems and web browsers	For Windows: Microsoft® Windows® 10 Windows® Internet Explorer® 11 64-bit/32-bit Microsoft Edge Google Chrome
	For Mac: macOS 10.15 macOS 10.14 macOS 10.13 macOS 10.12 OS X 10.11 Safari Google Chrome
Other	Graphics card support hardware acceleration (for decode H.264/H.265/JPEG streaming) Adobe® Reader® (for viewing the operating instructions available on the website)

IMPORTANT

Failure to provide the required personal computer environment may slow down the delineation of the images on the screen, make it impossible for the web browser to work and cause other kinds of problems.

[Note]

- Depending on the software version of the unit, an update may be necessary.
- For the latest information on compatible operating systems, and web browsers, visit the support site at the website: <https://pro-av.panasonic.net/>

Network security

As you will use the unit connected to a network, your attention is called to the following security risks.

- 1) Leakage or theft of information through the unit
- 2) Use of the unit for illegal operations by persons with malicious intent
- 3) Interference with or stoppage of the unit by persons with malicious intent

It is your responsibility to take precautions such as those described below to protect yourself against the above network security risks.

- Enable user authentication from web screen.
- Use the unit in a network secured by a firewall, etc.
- If the unit is connected to a network that includes personal computers, make sure that the system is not infected. By computer viruses or other malicious entities (using a regularly updated antivirus program, anti-spyware program, etc.)."
- Protect your network against unauthorized access by restricting users to those who log in with an authorized user name and password.
- After accessing the unit as an administrator, be sure to close all web browsers.
- Change the administrator password periodically.
- To avoid passwords that can be guessed easily by third parties, set a password of at least 8 characters in length, including at least 3 different types of characters, such as upper case, lower case, numbers, and symbols
- Restrict access to the unit by authenticating the users, for example, to prevent setting information stored on the unit from leaking over the network.
- Do not install the camera in locations where the camera or the cables can be destroyed or damaged by persons with malicious intent.
- Avoid connections that use public lines.

[Note]

- **Notes on user authentication**

User authentication on the unit can be performed via digest authentication or basic authentication. If basic authentication is used without the use of a dedicated authentication device, password leaks may occur. We recommend using digest authentication.

- **Usage restrictions**

Use of the same segment is recommended for the network in which the unit and personal computer are connected. If the equipment uses connections with different segments, events based on the settings inherent to the network equipment, for instance, may occur so check this thoroughly prior to operation.

Characteristics

Characteristics

Multiple number of formats supported

You can switch between the following formats via the camera menus or a web browser.

[50Hz]

1080/50p, 1080/25p,
1080/50i,
720/50p

[59.94Hz]

1080/59.94p, 1080/29.97p,
1080/59.94i,
720/59.94p

[60Hz]

1080/60p, 1080/30p,
1080/60i,
720/60p

1/2.8-type MOS sensor and 12× zoom lens featured

- 1/2.8-type MOS sensor and DSP (digital signal processor) are incorporated. High-quality pictures are obtained by video processing in many different kinds of ways.
- In addition to its optical 12× zoom lens, the unit comes with a 4× digital zoom to achieve high-quality images that overflow with ambiance.
- The unit is equipped with functions that allow clean and clear reproduction of images in a wide range of applications, such as dynamic range stretch (DRS) functions that compensate for overexposure and loss of dark detail and a digital noise reduction (DNR) function that allows you to shoot scenes clearly by minimizing image lag even in dark locations.

Standard serial communication support

- Connect up to seven cameras to a commercially available controller via RS-232C interface.

Integrated pan-tilt head unit, camera and lens to facilitate installation

- By designing the camera, lens and pan-tilt head as a single integrated unit, the time taken for the installation work has been drastically reduced.

Flexible camera layout enabled by simple connection and installation

- The unit features excellent connectivity and installability thanks to the IP control; a lightweight main unit, and the turn-lock mechanism, which enables the user to install it on his or her own (only when used indoors).

[Note]

Bear in mind that the unit is designed to be used indoors only: It cannot be used outdoors.

- The compact camera unit realizes space-saving installation. The unit is suitable for replacing an existing camera or for expanding the current system.

Use in online meetings

The unit supports UVC so the video and audio signals can be output over USB. By using the PTZ virtual USB Driver software and connecting with a LAN cable, it is possible to use the unit as a usb camera.

Easy operation of unit enabled by its integration with a high-performance pan-tilt head unit

- High-speed operations with maximum speed of 200°/s during preset, and 100°/s during manual
- Wide rotational angles with a panning range of ±170° and a tilting range from -30° to +90°
- Storage of up to 100 positions in the preset memory (The number of preset memories that can be used varies from one controller to another.)

IP video output function featured

- The unit is equipped with image compression and IP transmission LSI capabilities. In addition, output at up to 60 fps for Full HD images is possible.
- Employing the functions of this chip together with IP control opens the door to uses in a wide range of applications including the control of the camera from a remote location.

Use of easy-to-operate wireless remote control (optional accessory) is possible

- A wireless remote control capable of operating up to four units can be used.

It can easily be used to set the various functions or switch between them while viewing the menu screens.

High degree of compatibility with Panasonic's currently available controllers, enabling a flexible system to be put together

- A maximum of five units can be operated by serial control from one of Panasonic's currently available controllers (AW-RP60, AW-RP150).

The unit can also be used together with the cameras and pan-tilt head unit systems currently available from Panasonic Connect Co., Ltd. so that an existing system can be used to advantage to put together a system that is even more flexible.

[Note]

- It may be necessary to upgrade the version of the controller in order to support the unit.
- The maximum distances between the units and controller is 1000 meters (3280 ft). (when serial control is exercised)

Use of an external device or some other means must be provided separately in order to extend the video signal connections.

PoE+ *1 eliminates need for camera power configurations

- Configurations for camera's power supply are not necessary when the unit is connected to a network device that supports the PoE+ standard (IEEE802.3at compliant)*2.

[Note]

- If the AC adaptor and a PoE+ power supply are connected simultaneously, the AC adaptor will have priority.
- Use a category 5e cable or higher when using a PoE+ power supply.
The maximum length of the cable between the power supply unit and the unit is 100 meters (328 ft). Using a cable that is lower than category 5e may result in reduced power supply capabilities.

*1: Power over Ethernet Plus.

Referred to as "PoE+" in this manual.

*2: For details on PoE+ power supply devices for which operation has been verified, consult your local dealer.

Accessories

Check that the following accessories are present and accounted for.

After removing the product from its container, dispose of packing materials in an appropriate manner.

AC Adaptor

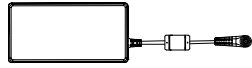

Power Cable

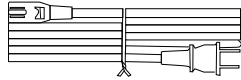

Drop-prevention wire



**Mount bracket
for installation
surface**

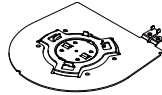

Cable Ties (x2)

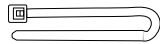

Cable fixing bracket

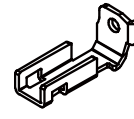

Lens cap



**Bracket mounting
screws**

M4 x 10 mm

(4 screws)

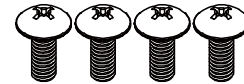

**Main unit mounting
screws**

M4 x 6 mm

(2 screws)

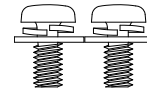

**Screw for
cable fixing bracket**



M2.6 x 5 mm

(1 screw)

Optional Accessories

- Wireless remote control AW-RM50AG (Size "AA" dry battery x 2, obtained separately)
- Direct ceiling mount bracket WV-Q105A"

[Note] For details on optional accessories, refer to the catalog or consult your local dealer.

Operating Precautions

■ Shoot under the proper lighting conditions.

To produce pictures with eye-pleasing colors, shoot under the proper lighting conditions. The pictures may not appear with their proper colors when shooting under fluorescent lights. Select the proper lighting as required.

■ To ensure a stable performance in the long term

Using the unit for prolonged periods in locations where the temperature and humidity levels are high will cause its parts to deteriorate, resulting in a reduction of its service life. (Recommended temperature: Max. 35 °C (95 °F))

Ensure that a cooling unit or heating unit will not blow any air directly toward the installation location.

■ Do not point the camera at strong lights.

When parts of the MOS sensor are exposed to spotlights or other strong lights, blooming (a phenomenon where the edges of strong lights become blurred) may occur.

■ What happens with high-brightness subjects

Flare may occur if an extremely bright light source is pointed at the lens. In a case like this, change the angle or take some other remedial action.

■ Color bars

Color bars are used to adjust the color phase, and the widths and positions of these bars may differ from other models.

■ Concerning PoE+ power supply

The unit complies with the IEEE802.3at standard. Use a compatible Ethernet hub and PoE+ injector to use a PoE+ power supply.

■ Turn off the power before connecting or disconnecting the cables.

Always be sure to turn off the power before connecting or disconnecting the cables.

■ When using the automatic functions

In the [Scene] such as the camera menu, the initial settings on some items has been set to auto, making it impossible for these items to be operated manually. To operate them manually, switch from the auto settings to the manual settings as required. When using the ATW (auto tracking white adjustment) function under fluorescent lights, the white balance may vary.

■ Operating temperature range

Avoid using the unit in cold locations where the temperature drops below 0 °C (32 °F) or hot locations where the temperature rises above 40 °C (104 °F) since these temperatures downgrade the picture quality and adversely affect the internal parts. Also, it may take a few minutes to stabilize the image when used in low temperatures. We recommend that you turn on this unit before use.

■ Concerning the HDMI interface standard

This unit has been certified as HDMI-compatible, but on rare occasions images may not be displayed depending on the HDMI device which has been connected to the unit.

■ When the unit is not in use

Turn off the unit's power when it is not in use. When the unit is no longer going to be used, do not leave it lying around, but be absolutely sure to dispose of it properly.

■ Do not touch the optical system.

Under no circumstances must they be touched. In the unlikely event that they have become dusty, remove the dust by using a camera blower or by wiping them gently with a lens cleaning paper.

■ Do not point the camera directly at the sun or a laser beam, no matter whether it is turned on or not.

Taking images of the sun, laser beams, or other brightly lit subjects for prolonged periods of time may damage the MOS sensor.

■ Personal computer used

If the same image is displayed for a prolonged period on a PC monitor, the monitor may be damaged. Use of a screen saver is recommended.

■ Concerning the IP address setting

Do not run the Easy IP Setup Software on a multiple number of personal computers for a single camera and set the IP address at the same time. Otherwise, you will be unable to complete the proper procedure and set the IP address correctly.

■ **H.264/H.265 patent pool licensing**

This product is licensed based on the AVC Patent Portfolio License, and the license does not extend beyond uses by users, who engage in the acts described below, for their own personal and non-profit applications.

- (i) Recoding of image information in compliance with the AVC standard (hereafter, "AVC videos")
- (ii) Playing of AVC videos recorded by consumers engaging in personal activities or AVC videos acquired from licensed providers

For details, visit MPEG LA, LLC website (<http://www.mpegla.com>).

■ **Handle the unit carefully.**

Do not drop the unit or subject it to strong impact or vibration. Doing so may cause the unit to malfunction.

■ **Keep the unit away from water**

Avoid all direct contact with water. Otherwise, problems may occur.

■ **Do not use the unit in oily-smoky or dusty places.**

Performance may be adversely affected if small particles or other foreign objects get inside the product.

Take extra care in environments where a special effect such as theatrical smoke is used.

■ **Do not allow foreign matter to make contact with the rotating parts.**

Failure to obey may cause the unit to malfunction.

■ **Disposal of the unit**

When the unit has reached the end of its service life and is to be disposed of, asks a qualified contractor to dispose of the unit properly in order to protect the environment.

■ **Maintenance**

Turn off the unit's power before proceeding with maintenance. Otherwise, you may injure yourself. Wipe the surfaces using a soft dry cloth. Avoid all contact with benzene, paint thinners and other volatile substances, and avoid using these substances. Otherwise, the casing may become discolored.

■ **Use the unit in an environment with minimal moisture and dust.**

Avoid using the unit in an environment with high concentration of moisture or dust since these conditions will damage the internal parts.

■ **Zooming and focusing**

When the focus is set manually, out-of-focusing may occur during zooming.

After zooming, if necessary, either adjust the focus or set the focus to auto.

When using the focus at the manual setting, proceed with zooming after setting the focus position at the Tele end where the focusing accuracy is higher.

(However, if the distance from the unit to the object is less than 1.5 meters (4.9 ft), the subject may shift out of focus at the Wide end.)

If zooming is performed to the Tele end after having adjusted the focus at the Wide end, out-of-focusing may occur.

■ **Information on software used with this product**

This product incorporates the following software:

- (1) the software developed independently by or for Panasonic Connect Co., Ltd.,
- (2) the software owned by third party and licensed to Panasonic Connect Co., Ltd.,
- (3) the software licensed under the GNU General Public License, Version 2.0 (GPL V2.0),
- (4) the software licensed under the GNU LESSER General Public License, Version 2.1 (LGPL V2.1), and/or
- (5) open source software other than the software licensed under the GPL V2.0 and/or LGPL V2.1.

The software categorized as (3) - (5) are distributed in the hope that it will be useful, but WITHOUT ANY WARRANTY, without even the implied warranty of MERCHANTABILITY or FITNESS FOR A PARTICULAR PURPOSE. Please refer to the detailed terms and conditions that can be downloaded from the web screen

At least three (3) years from delivery of this product, Panasonic will give to any third party who contacts us at the contact information provided below, for a charge no more than our cost of physically performing source code distribution, a complete machine-readable copy of the corresponding source code covered under GPL V2.0, LGPL V2.1 or the other licenses with the obligation to do so, as well as the respective copyright notice thereof.

<https://pro-av.panasonic.net>

However, do not contact Panasonic for questions regarding obtained source codes.

Parts and Functions

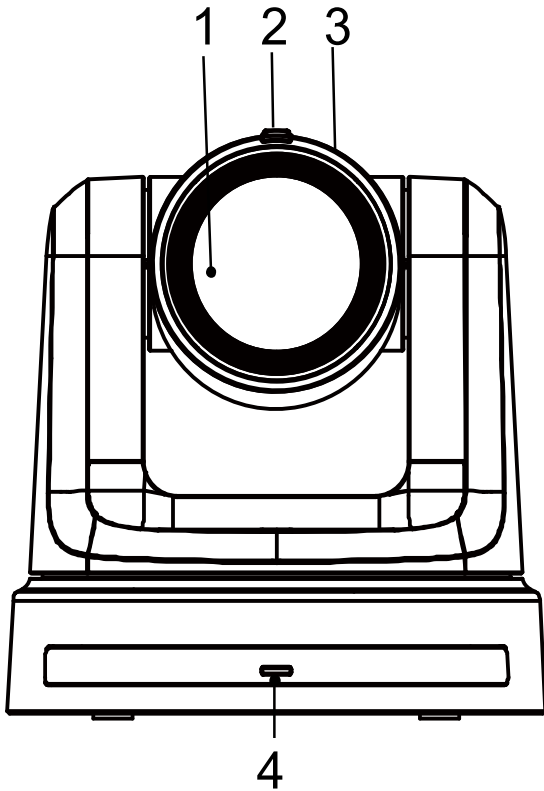

1. Lens

2. Tally status indicator

- Red light: The unit is receiving tally command.
- Red light flashing once (1Hz): The unit's pan/tilt limit is being configured.
- Red light flashing twice (1Hz): The unit's pan/tilt limit is being cancelled.
- Blue light: USB Video Class/Audio Class is in operation.

3. Camera head

4. Power status indicator

- Orange light: Standby mode
- Green light: The unit is turned on
- Flashing green light (1Hz): The unit is receiving a wireless remote control signal with a matching remote control ID
- Flashing(1Hz) orange light: The unit is receiving a wireless remote control signal with a different remote control ID
- Flashing (5Hz) green light: After Initialization 1 and Initialization 2 via DipSW
- High speed (5Hz) flashing orange light: When a signal from the wireless remote control is received while the wireless control is set to "Disable" from the web screen menu.
- Flash (1Hz) red light: Firmware updating
- Red light: Firmware update failure or other abnormality.

5. LAN indicator(LINK/ACT)

Lights up when data is transmitted/received via LAN.

6. LAN connector

Use a category 5e or above LAN cable with a maximum length of 100 m (328 ft.)

[Note]:

Use of an STP (shielded twisted pair) cable is recommended.

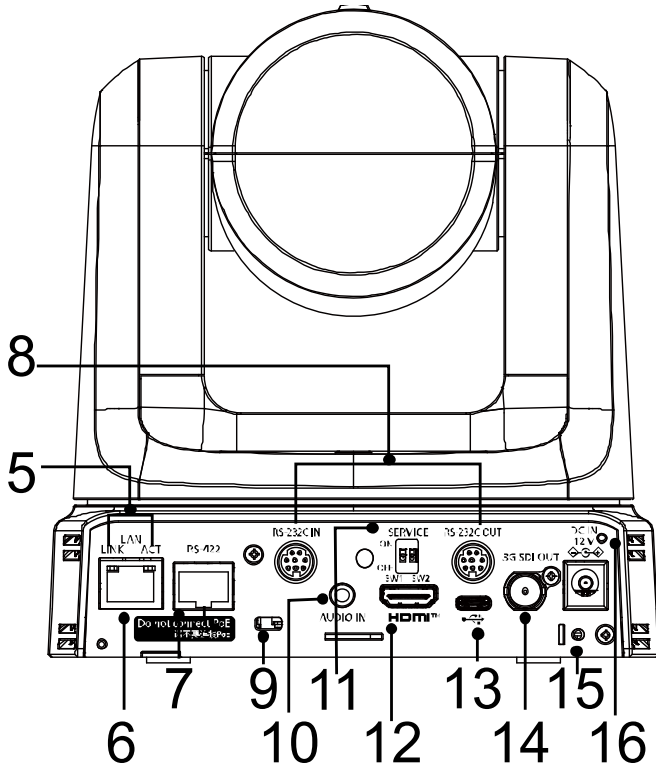

7. RS-422 connector [RS-422]

This RS-422 connector (RJ-45) is connected when exercising serial control over the unit from an external device.

Use a cable with the following specifications for the connection to this connector.

[Note]:

- LAN cable* (category 5 or above, straight cable), max. 1000 meters [3280 ft]
 - Use of an STP (shielded twisted pair) cable is recommended.

1 3 5 7
2 4 6 8

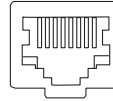

Pin No.	Signal	Pin No.	Signal
1	GND	5	TXD +
2	—	6	RXD +
3	RXD -	7	—
4	TXD -	8	—

8. RS-232C connectors [RS-232C IN/OUT]

Connect to RS-232C cables.

RS-232C IN/OUT connector

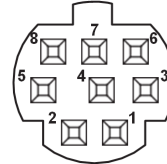

Mini DIN 8-pin (JST)

RS-232C IN		RS-232C OUT	
Pin No.	Signal	Pin No.	Signal
1	DTR_IN	1	DTR_OUT
2	DSR_IN	2	DSR_OUT
3	TXD_IN	3	TXD_OUT
4	GND	4	GND
5	RXD_IN	5	RXD_OUT
6	GND	6	GND
7	IR OUT R	7	NC
8	IR OUT L	8	NC

[Note]:

Be aware that the polarities (+/-) of the serial data may be different depending on the specifications of the device to be connected.

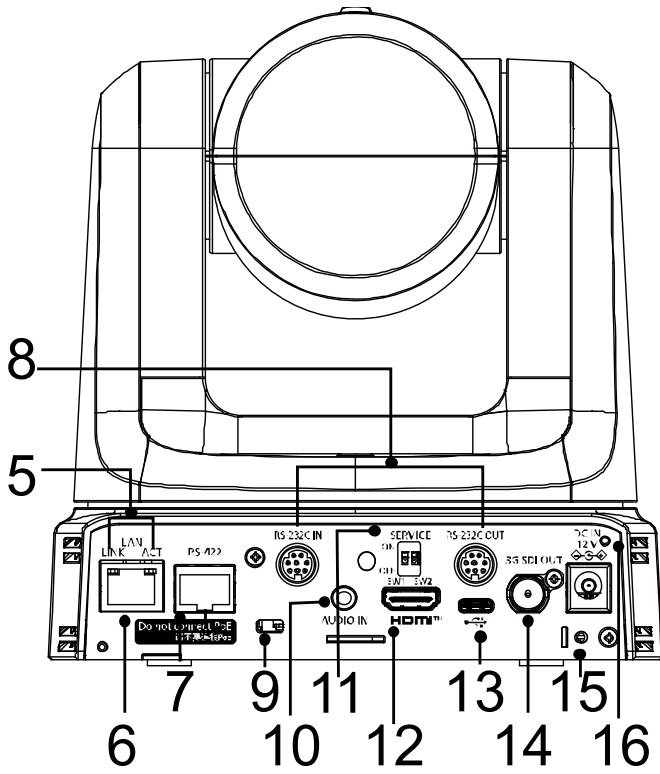

9. Anti-theft wire mounting hole

Use this hole to attach the wire bracket (commercially available).

10. Audio input connector [AUDIO IN]

Inputs external audio (microphone, line).

11. Service Switch

- **Default:** a full reset

The unit is in its default mode.

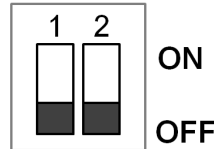

- **Initialization 1:**

Reset the user authentication settings for network connection. (This will delete all the registered user information (IDs/passwords).

After configuring the SERVICE switch in the manner of the following illustration, power on the unit.

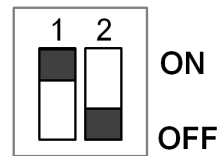

[Note]:

1. Once Initialization 1 is configured properly, the unit's status indicator LED blinks green.
2. Restore the SERVICE switch to its previous setting. (Both SW1 and SW2 are set to OFF.)
3. Restart the unit to fully accomplish the setting of Initialization 1.

- **Initialization 2**

Initialization 2 restores the unit to its factory default, including the setting of the menu, and the Network Configuration. After configuring the SERVICE switch in the manner of the following illustration, power on the unit.

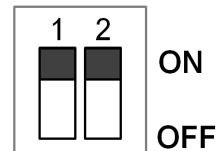

[Note]:

1. Once Initialization 2 is configured properly, the unit's status indicator LED in front of the unit blinks green.
2. Restore the SERVICE switch to its previous setting. (Both SW1 and SW2 are set to OFF.)
3. Restart the unit to fully accomplish the setting of Initialization 2.

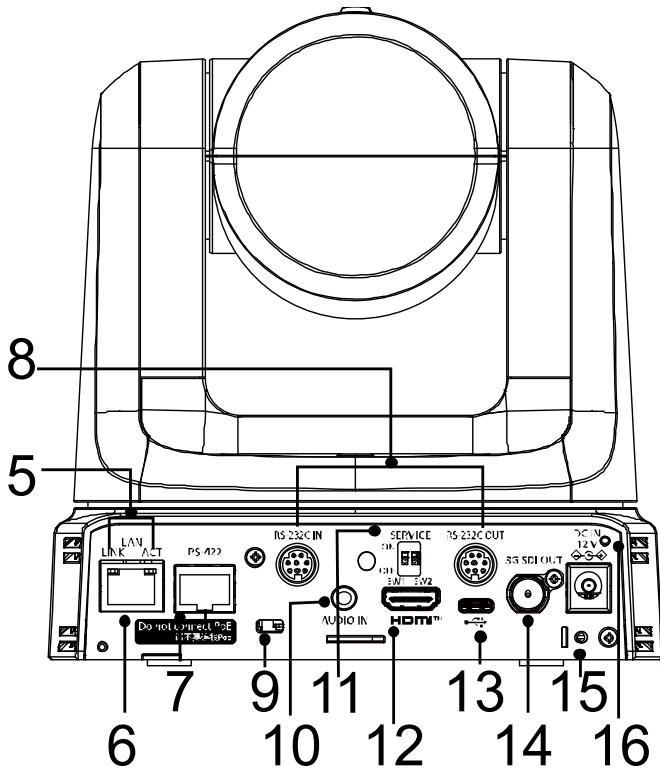

12.HDMI connector

This is the HDMI video signal output connector. For limitations that pertain when simultaneously outputting HDMI and SDI signals, refer to page 38.

13.USB Type-C terminal [🔌]

The unit can be used as a Web camera by connecting the unit and a personal computer with USB Video Class.

14.SDI OUT connector [3G-SDI OUT]

This is the SDI video signal output connector. For limitations that pertain when simultaneously outputting HDMI and SDI signals, refer to page 38.

15.Screw hole for cable fixing bracket

16.DC IN connector [12V \ominus \oplus IN \ominus \oplus]

Connect the AC adaptor supplied with the unit to this connector to supply the DC 12 V voltage to the unit.

[Note]

System will reboot as you plug in/out the AC adapter in/out even when the power is supplied from a PoE+ switch.

Wireless Remote Control (optional accessory)

You can operate the unit with the optional wireless remote control (AW-RM50AG).

Consult your dealer concerning the purchase of a wireless remote control.

Buttons used for operating this unit are described.

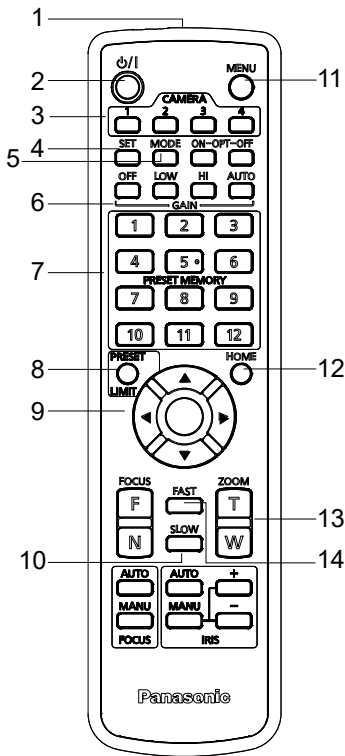

1	Signal transmission window
2	ON/STANDBY button Each time this is pressed for 2 seconds, operation switches between turning on the unit's power and establishing the standby status.
3	[CAMERA 1] to [CAMERA 4] buttons Selects a camera to be operated. Once a button has been selected, the unit corresponding to the selected button can be operated.
4	SET button If this button is pressed when the [AWB A] memory or [AWB B] memory has been selected for the white balance adjustment, the white balance is automatically adjusted and registered in the selected memory.
5	MODE button Each time you press the button, the signal switches between the color bar signal output and the camera image output.
6	GAIN buttons [OFF] [LOW] [HI] [AUTO] These are used to set the gain. The gain increase can be set in three steps using the [OFF], [LOW] and [HI] buttons. [OFF] is set to 0 dB, [LOW] is set to 9 dB, and [HI] is set to 18 dB. When the [AUTO] button is pressed, the AGC function is activated, and the gain is adjusted automatically depending on the light quantity. The maximum gain of the AGC function can be set using the camera menu.
7	1 to 12 buttons These are used to call the information on the unit's directions and other settings, which have been registered in the units preset memories No.1 to No.12, and reproduce those settings. Setting in preset memories No.13 and above cannot be called from the wireless remote control.
8	PRESET button Press this button and any of the buttons from 1 to 12 simultaneously to register a preset memory.

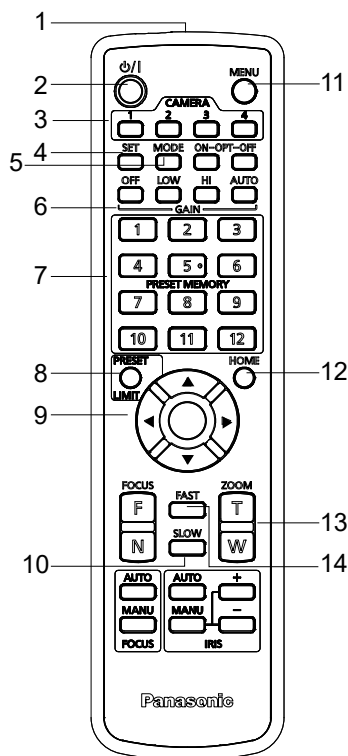

<p>9</p>	<p>Pan-tilt buttons and menu operation buttons</p> <p>(1) These are used to change the unit's direction. The unit is tilted in the up/down direction using the [▲] and [▼] buttons and panned in the left/right direction using the [◀] and [▶] buttons.</p> <p>The [○] button does not work during tilting and panning.</p> <p>When the [▲] or [▼] and [◀] or [▶] buttons are pressed at the same time, the unit moves diagonally.</p> <p>(2) The buttons are used for menu operations when the unit displays the camera menus.</p> <p>Use the [▲] and [▼] buttons to select the menu items.</p> <p>When a selected item has a sub-menu, the sub-menu will be displayed by pressing the [○] or [▶] button.</p> <p>When the [○] or [▶] button is pressed on the setting menu at the bottom hierarchical level, the new setting is entered.</p>
<p>10</p>	<p>SLOW button</p> <p>This is used to change the movement speed at which the panning, tilting, zooming and focusing operations are performed to the low speed.</p>
<p>11</p>	<p>MENU button</p> <p>Press and hold for 2 seconds to display the camera menu of the unit.</p>
<p>12</p>	<p>HOME button</p> <p>When this is pressed for 2 seconds, the unit's direction (panning or tilting) returns to the front of the unit and the zoom level of the unit is changed back to x1.</p>
<p>13</p>	<p>ZOOM button</p> <p>These are used to adjust the digital zoom.</p> <p>The zoom is adjusted in the wide-angle using the [W] button and in the telephoto using the [T] button</p>
<p>14</p>	<p>FAST button</p> <p>This is used to change the movement speed at which the panning, tilting, zooming and focusing operations are performed to the high speed.</p>

This unit can be operated by remote control using a wireless remote control (model number: AW-RM50AG) purchased separately. Check out the following points before using the wireless remote control.

- **Point the wireless remote control at the unit's wireless remote control signal light-sensing area (front side and back side), and operate it within a range of 10 meters (32.8 ft.) from the area.**
- **Refer to <Layout of wireless remote control signal light-sensing areas> on the below.**
- **The signal sensing distance is reduced if the angle at which the wireless remote control signals are sensed is increased.**

The light-sensing sensitivity is reduced to about one-half when the wireless remote control is pointed at an angle of 40 degrees from each position in front of a wireless remote control signal light-sensing area (front panel or back panel).

- **If the unit is installed near fluorescent lights, plasma monitors or other such products or if the unit is exposed to sunlight, the effects of the light may make it impossible for the unit to be operated using the wireless remote control.**

Be sure to follow the steps below for installation and use.

- ✓ Take steps to ensure that the wireless remote control signal light-sensing area will not be exposed to the light from fluorescent lights, plasma monitors or other such products or from the sun.
- ✓ Install the unit away from fluorescent lights, plasma monitors and other such products.

- For about 10 minutes even after the batteries have been removed from the wireless remote control, the selection of the operation to be performed (the [CAMERA 1], [CAMERA 2], [CAMERA 3], or [CAMERA 4], button which was pressed last) will remain stored in the memory.
When a longer period of time elapses, however, the selection is reset to the status established when the [CAMERA 1] button was pressed.
- The unit's status indicator LED blinks green when a signal matched by the wireless remote control ID has been received, and it blinks orange when a signal that is not matched by the wireless remote control ID has been received.
- When the wireless control in the web screen menu is set to "Off", you cannot operate with the wireless remote control. The power status indicator flashes orange rapidly (5Hz).
When operating with the wireless remote control, set the wireless control in the web screen menu to "On".

● <Layout of wireless remote control signal light-sensing areas>

[Note] The arrows in the figure below show the light-sensing directions in which the wireless remote control signals travel.

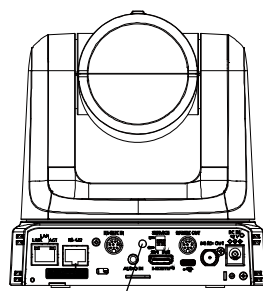
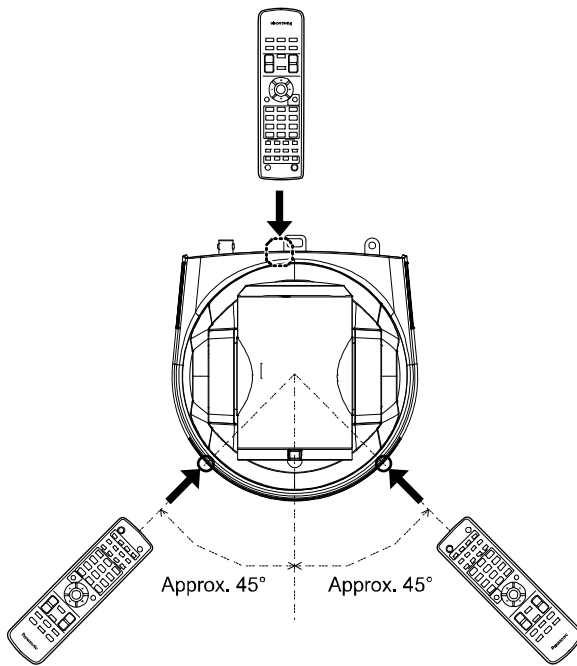
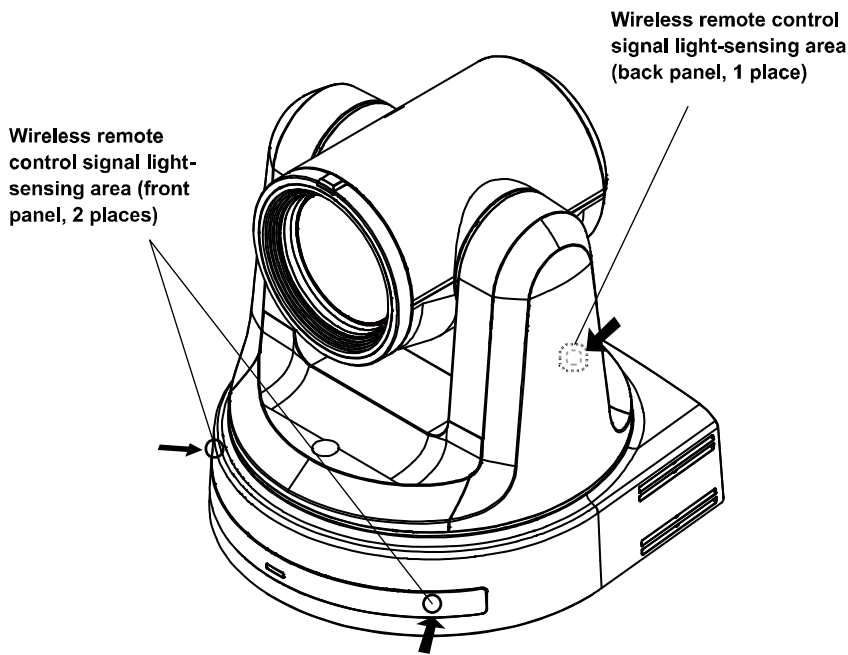

Network Settings

Use the Easy IP setup Software to Establish the Unit's Settings

The settings related to the unit's network can be established using the Easy IP Setup Software. You can obtain Easy IP Setup Software (EasyIPSetup.exe) by downloading it from the following website.
<https://pro-av.panasonic.net/>

To establish the settings for a multiple number of units, the settings must be selected for each camera involved. If the settings cannot be established using the Easy IP Setup Software, select the settings separately for the unit and personal computer on the Network setup screen [Network] of the setting menu.

[Note]

- If, after the network settings have been established, another device in the same network has the same IP address, the network operations will not be performed properly.
- Set the IP address in such a way that it does not duplicate an existing IP address.
- Do not establish network settings from a multiple number of Easy IP Setup Software programs at the same time for a single camera. Similarly, do not perform the "Auto IP setting" operation of the remote camera controller AW-RP150 or AW-RP60 at the same time.
- The IP address settings may no longer be recognized as a result.
- To enhance the security of the Easy IP Setup Software, it will not be possible to make network settings for the target camera once about 20 minutes or more have elapsed after turning the power of the camera on. (When the [Easy IP Setup accommodate period] setting is [20min])
- The Easy IP Setup Software cannot be used from a different subnet via a router.

1. Start the Easy IP Setup Software.
2. Click the [Search] button.

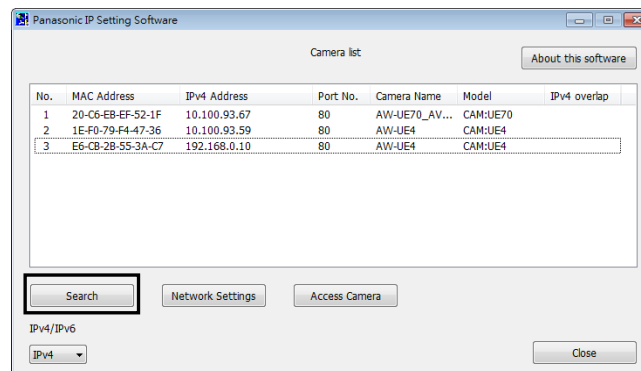

3. Click the MAC address/IPv4 address of the camera to be set, and click the [Network Settings] button.

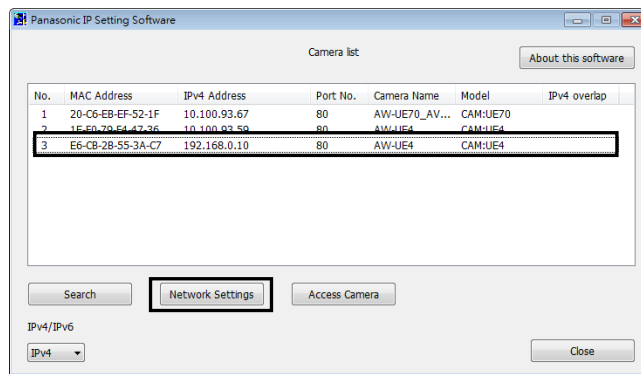

[Note]

- When a DHCP server is being used, the IP address allocated to the unit can be checked by clicking the [Search] button of the Easy IP Setup Software.
- If the same IP address is used for any additional cameras, the numbers of the additional cameras will be displayed in the [IPv4 overlap] column of the cameras concerned.
- When the [Access Camera] button is clicked, the live screen of the selected camera is displayed.

4. Input the network items, and click the [Save] button.

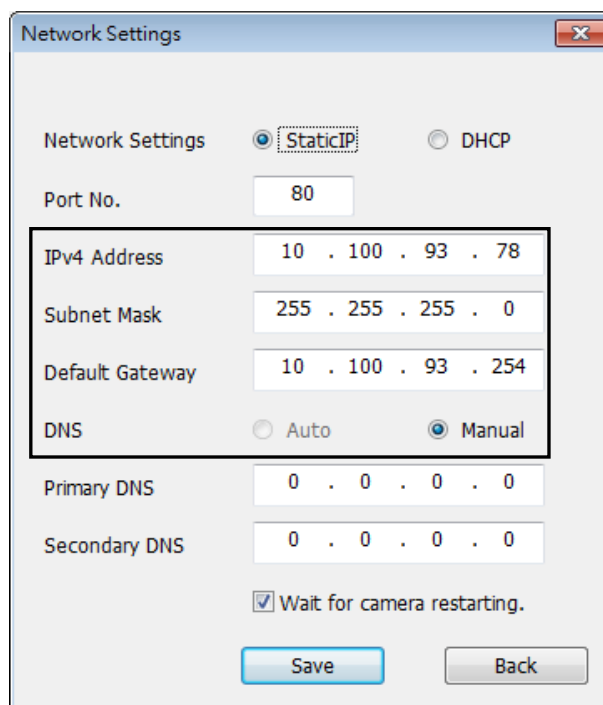

[Note]

- When a DHCP server is being used, [DNS] of the Easy IP Setup Software can be set to [Auto].
- After the [Save] button is clicked, it takes about 1 minute for the settings in the unit to be completed. If the AC adaptor or LAN cable is disconnected before the settings are completed, the settings will be canceled. In this case, repeat the steps to establish the settings.
- When a firewall (including software) has been introduced, enable access to all the UDP ports.

Use the EasyIP Setup Tool Plus Software to Establish the Unit's Settings

The settings related to the unit's network can be established using the EasyIP Setup Tool Plus Software. You can obtain EasyIP Setup Tool Plus Software (EasyIPSetupToolPlus.exe) by downloading it from the following website: <https://pro-av.panasonic.net/>

- To establish the settings for a multiple number of units, the settings must be selected for each camera involved.
 - If the settings cannot be established using the EasyIP Setup Tool Plus Software, select the settings separately for the unit and personal computer on the Network setup screen [Network] of the setting menu.
-
- [Note]
 - If, after the network settings have been established, another device in the same network has the same IP address, the network operations will not be performed properly.
 - Set the IP address in such a way that it does not duplicate an existing IP address.
 - Do not establish network settings from a multiple number of Easy IP Setup Software programs at the same time for a single camera. Similarly, do not perform the "Auto IP setting" operation of the remote camera controller AW-RP150 or AW-RP60 at the same time. The IP address settings may no longer be recognized as a result.
 - To enhance the security of the EasyIP Setup Tool Plus Software, it will not be possible to make network settings for the target camera once about 20 minutes or more have elapsed after turning the power of the camera on. (When the [Easy IP Setup accommodate period] setting is [20min].)
 - The EasyIP Setup Tool Plus Software cannot be used from a different subnet via a router.

1 Double-click EasyIPSetupToolPlus.exe to start the Easy IP Setup Software.

2 Click the [Search] button.

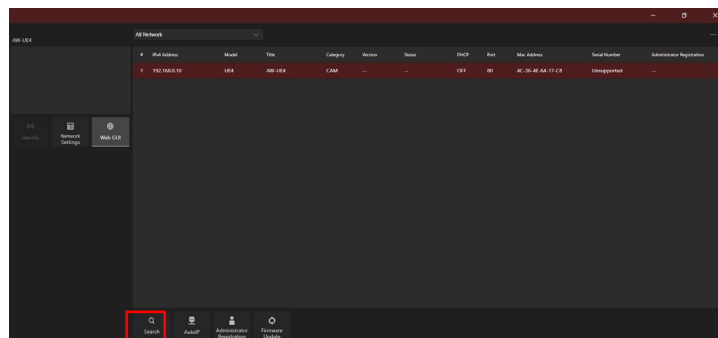

3 Click the MAC address/IPv4 address of the camera to be set, and click the [Network settings] button.

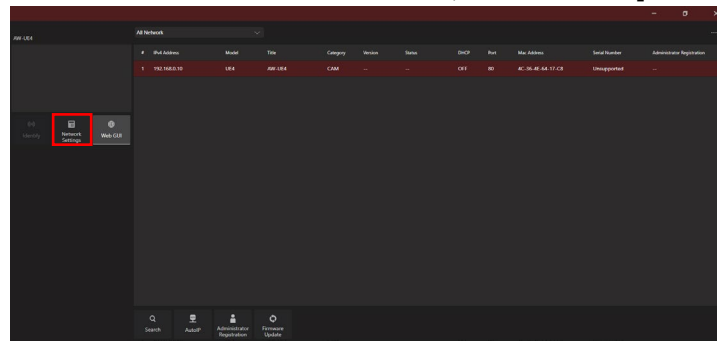

- When a DHCP server is being used, the IP address allocated to the unit can be checked by clicking the [Search] button of the Easy IP Setup Software.
- If the same IP address is used for any additional cameras, the numbers of the additional cameras will be displayed in the “IPv4 overlap” column of the cameras concerned.
- When the [Web GUI] button is clicked, the Live screen of the selected camera is displayed.
- The screen display of EasyIP Setup Tool Plus may vary by its version.

4 Input the network items, and click the [Setup] button.

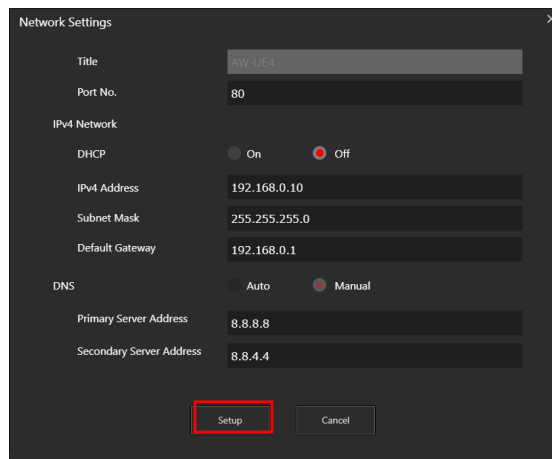

- When a DHCP server is being used, [DNS] of the Easy IP Setup Software can be set to [Auto].
- After the [Save] button is clicked, it takes about 1 minute for the settings in the unit to be completed.
- If the AC adaptor or LAN cable is disconnected before the settings are completed, the settings will be canceled. In this case, repeat the steps to establish the settings.
- When a firewall (including software) has been introduced, enable access to all the UDP ports.

Setting the Initial Account

1. Set the initial account.

In the initial state, the initial account setting screen is displayed when the web screen is displayed. Set a user name and password.

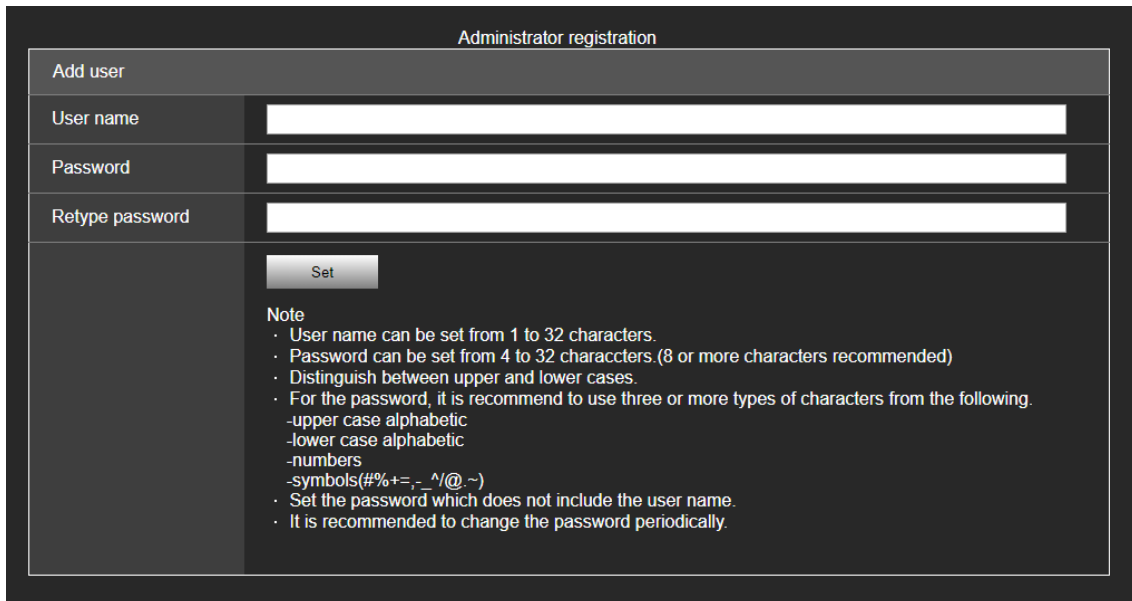

The image shows a screenshot of the 'Administrator registration' screen. It features a title bar 'Administrator registration' and a main area with the following elements:

- A header bar labeled 'Add user'.
- Three input fields: 'User name', 'Password', and 'Retype password'.
- A 'Set' button.
- A 'Note' section with the following text:
 - User name can be set from 1 to 32 characters.
 - Password can be set from 4 to 32 characters. (8 or more characters recommended)
 - Distinguish between upper and lower cases.
 - For the password, it is recommended to use three or more types of characters from the following.
 - upper case alphabetic
 - lower case alphabetic
 - numbers
 - symbols(#%+,-_^/@.~)
 - Set the password which does not include the user name.
 - It is recommended to change the password periodically.

[Note]

- The usable symbols for user name is following (# % + = , - _ ^ / @ . ~)
- Do not set character strings that can be easily guessed by third parties.
- Change the password at regular intervals.
- The password must use at least 3 of the following 4 character types and be 8 characters or longer.
 - Alphabet upper cases
 - Alphabet lower cases
 - Numerals
 - Symbols (# % + = , - _ ^ / @ . ~)
- When a password is set that does not adhere to the above policy, take responsibility for use of the device with due consideration for the security risks in the installation environment, etc.
- A warning is displayed if the set password goes against the recommended setting policy. When changing the password, click the [Back] button and set the password again.
- When continuing with the setting with full understanding of the security risks, click [Continue] to complete the setting.
- If you forget the account information that was set, use the switches for initialization of service switches to reset the user information used for connecting to the network. (→ page 23)

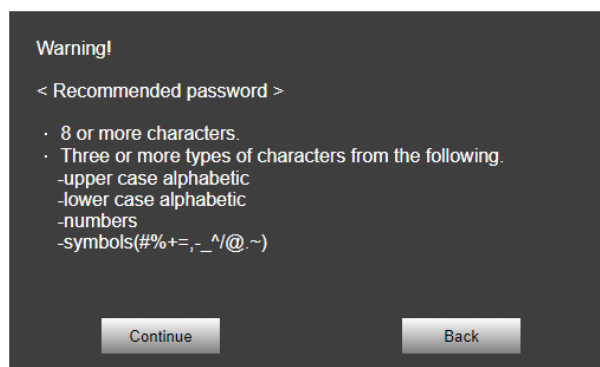

The image shows a 'Warning!' dialog box with the following content:

< Recommended password >

- 8 or more characters.
- Three or more types of characters from the following.
 - upper case alphabetic
 - lower case alphabetic
 - numbers
 - symbols(#%+,-_^/@.~)

At the bottom, there are two buttons: 'Continue' and 'Back'.

2. Completing registration of the initial account

After completing registration of the initial account, the following registration completed screen is displayed.

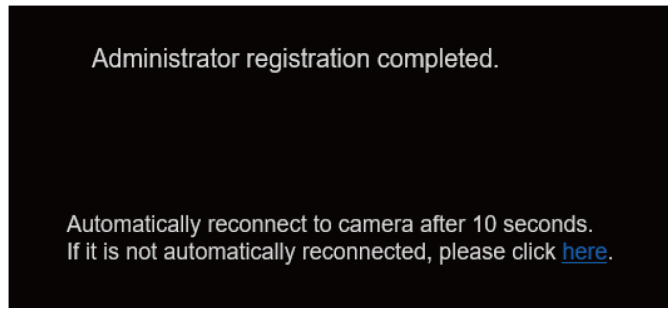

The live screen [Live] is automatically displayed after about 10 seconds elapse after the completed screen is displayed. If the live screen [live] is not displayed after 10 seconds elapse, manually move to the live screen [Live] by clicking the “please click here” link.

This completes the process of registering the initial account.

Basic Shooting Operation

With the basic operations, it is assumed that the white balance will be adjusted automatically (as per the factory settings).

1. Make sure the subject brightness is in the appropriate level.
2. Make sure the unit and all devices are well connected and power on.
3. Press one of the **[CAMERA 1]** to **[CAMERA 4]** buttons on the wireless remote control to select the unit if using the wireless remote control. Even when using only one unit, it must still be selected from the wireless remote control or controller.

4. Select the scene (shooting) mode.

One of the three shooting modes (**Full Auto**, **Scene1**, **Scene2**)— whichever one will best suit the shooting conditions — can be selected.

The shooting modes are set by the user.

For details of the factory settings, refer to pages 66 to 68.

Select the mode that satisfies the shooting conditions and suits your preferences.

When continuing to shoot in the same circumstances, there is no need to select another mode.

5. Start shooting.

[Note]

Due to the characteristics of the lens, the edge of the image is distorted.

If using a controller, please upgrade the unit with the latest firmware version.

Power on and Power Off the Camera Unit

Power on the Camera Unit

When performing the operations using the wireless remote control.

Set all the power switches of the units and devices connected in the system to ON.

When the power is supplied, the status display lamp lights orange.

After the initial setting is completed, it switches to green and the power turns on.

[Note]

- During the initial settings operation, the unit cannot be operated.
- The unit stores its STANDBY / POWER ON mode status in the memory.
- If the power supply is cut off while the operation is in POWER ON mode, the operation will transfer to the POWER ON mode the next time power is supplied.
- When transferring to the STANDBY mode
 - Status indicator LED: Orange
 - The current pan-tilt position is stored in the memory (as a POWER ON preset), and the panning/tilting moves so that the camera points in the backward-facing direction.
- When transferring to the POWER ON mode
 - Status indicator LED: Green (after the initial setting operation is completed)
 - The pan/tilt position is moved to the position which was stored in the memory when the transition to the STANDBY mode was made.
- POWER ON preset
 - The pan/tilt position return to the place just before entering STANDBY mode when returning from STANDBY mode to POWER ON mode.
- If the power is turned off without transferring to the STANDBY mode, the pan/tilt unit position will not be stored in the memory or reflected in the POWER ON preset. The previous POWER ON preset will be applied.

When performing the operations using the controller (AW-RP60/AW-RP150).

For details, refer to the operating instructions for the controller.

Power off the Camera Unit

When performing the operations using the wireless remote control

1. Press one of the [CAMERA 1] to [CAMERA 4] buttons on the wireless remote control to select the unit.
2. Press the [ON/STANDBY] button on the wireless remote control for 2 seconds.
The unit enters STANDBY mode.
3. The unit's status display lamp now lights up orange.
4. If a multiple number of units are used, repeat steps 1 and 2 as required.
5. Set all the power switches of the units and devices connected in the system to OFF.

When performing the operations using the controller (AW-RP60/ AW-RP150).

For details, refer to the operating instructions for the controller.

Priority Mode

Changing the priority mode enables the unit to perform operation for various applications.

- **HDMI/USB:** HD format video is output to an external monitor connected via an HDMI/SDI cable. Enables the unit to be used as a Web camera. The camera can also be controlled from a personal computer.
- **IP:** HD format video is output to an external monitor connected via an HDM/SDI cable. Enables IP image transmission. The IP transmission of H.264/H.265 images is also supported. This unit cannot display H.264/H.265 format images on the Live screen. To display H.264/H.265 images, use an external device or external software that supports H.264/H.265 images.
- **USB (Video Conference):** Enables the unit to be used as a Web camera. The camera can also be controlled from a personal computer. In this mode, you cannot output video via HDMI or SDI, and you cannot output video via IP transmission. (Video output will not be possible except via USB). Also, in this mode, the audio output is forcibly turned off.

Functions that can be and functions that cannot be controlled simultaneously.

Priority Mode	Output terminal				
	HDMI	3G-SDI	USB	LAN	
				RTSP/RTMP	Web (HTTP)
HDMI/USB	[50Hz] 1080/50p, 1080/25p, 720/50p,1080/50i [59.94Hz] 1080/59.94p, 1080/29.97p, 720/59.94p, 1080/59.94i [60Hz] 1080/60p, 1080/30p, 720/60p,1080/60i	[50Hz] 1080/50p, 1080/25p, 720/50p,1080/50i [59.94Hz] 1080/59.94p, 1080/29.97p, 720/59.94p,1080/59.94i [60Hz] 1080/60p, 1080/30p, 720/60p,1080/60i	H264: [50Hz] 1080/50fps、25fps、10fps、 5fps、720/50fps、25fps、 10fps、5fps、360/50fps、 25fps、10fps、5fps [59.94Hz/60Hz] 1080/60fps、30fps、15fps、 5fps、720/60fps、30fps、 15fps、5fps、360/60fps、 30fps、15fps、5fps MJPEG: [50Hz] 1080/25fps、10fps、5fps、 720/25fps、10fps、5fps、 360/25fps、10fps、5fps [59.94Hz/60Hz] 1080/30fps、15fps、5fps、 720/30fps、15fps、5fps、 360/30fps、15fps、5fps YUV: [50Hz] 360/10fps [59.94Hz/60Hz] 360/15fps	—	MJPEG: [50Hz] 720/10fps、360/25fps 、10fps [59.94Hz/60Hz] 720/10fps、360/30fps 、10fps
IP	[50Hz] 1080/25p [59.94Hz] 1080/29.97p [60Hz] 1080/30p	[50Hz] 1080/25p [59.94Hz] 1080/29.97p [60Hz] 1080/30p	—	H264 or H.265: [50Hz] 1080/50fps, 25fps, 10fps, 5fps, 720/50fps, 25fps, 10fps, 5fps, 360/50fps, 25fps, 10fps, 5fps [59.94Hz/60Hz] 1080/60fps, 30fps, 15fps、 5fps, 720/60fps, 30fps, 15fps, 5fps, 360/60fps, 30fps, 15fps, 5fps	MJPEG: [50Hz] 720/10fps, 360/25fps 、10fps [59.94Hz, 60Hz] 720/10fps, 360/30fps 、10fps
USB (Video Conference)	—	—	MJPEG: [50Hz] 1080/25fps、10fps、5fps、 720/25fps、10fps、5fps、 360/25fps、10fps、5fps [59.94Hz/60Hz] 1080/30fps、15fps、5fps、 720/30fps、15fps、5fps、 360/30fps、15fps、5fps YUV: [50Hz] 360/25fps [59.94Hz/60Hz] 360/30fps	—	—

Selecting the Camera Unit

When performing the operations using the wireless remote control

Press the [CAMERA 1], [CAMERA 2], [CAMERA 3] or [CAMERA 4] button.

The camera unit's status indicator LED blinks green when a signal matched by the remote control ID has been received, and it blinks orange when a signal that is not matched by the remote control ID has been received.

When performing the operations using the controller (AW-RP60/AW-RP150).

For details, refer to the operating instructions for the controller.

Network connection with AW-RP60/AW-RP150 requires setup of an initial account. When an initial account is not setup, AW-RP60/AW-RP150 can detect but cannot control this unit.

Selecting the Scene Mode

Scene Mode Types

The unit has three preset scene modes, each of which corresponds to a set of circumstances in which the subject will be shot.

Select the mode that satisfies the shooting conditions and suits your preferences.

The settings can be changed by menu operations.

The results of the white balance and other adjustments are stored in the memory separately by shooting mode. Be absolutely sure to select the shooting mode before making any adjustments.

■ Full Auto

Under [Brightness], you can set Picture Level, AGC MaxGain, and Slow Shutter.

■ Scene 1/Scene 2

Under [Brightness], you can set Picture Level, Iris Mode, Shutter Mode, Gain, and Frame Mix.

How to select the Scene mode

When performing the operations using the wireless remote control

- 1 Press the [CAMERA 1], [CAMERA 2], [CAMERA 3] or [CAMERA 4] button to select the unit.
- 2 Press the [MENU] button for 2 seconds.
The menu is displayed.
- 3 Press the [▲] or [▼] button to bring the highlight to "CAMERA".

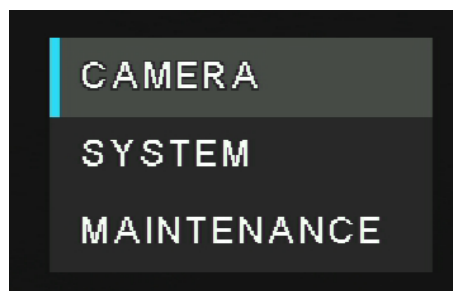

When performing the operations using the controller (AW-RP60/AW-RP150).

For details, refer to the operating instructions for the controller.

4 Press the [○] button.

The "CAMERA" sub-menu is displayed on the monitor.

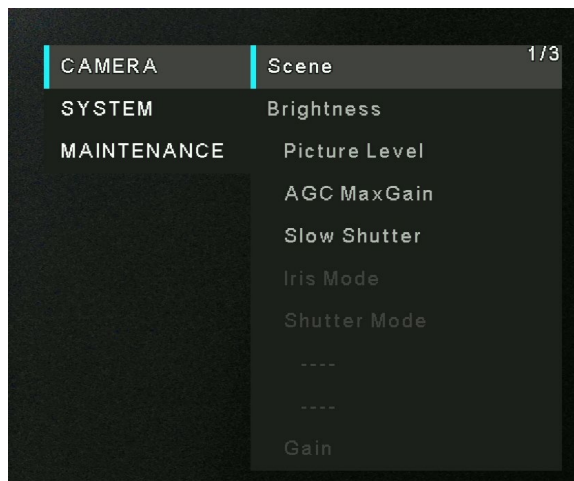

5 Press the [▲] or [▼] button to bring the highlight to "Scene".

6 Press the [○] button.

7 Press the [▲] or [▼] button to select the scene mode (Full Auto, Scene1, or Scene2) and press the [○] button to confirm the selection. The selected scene mode has a mark sign within.

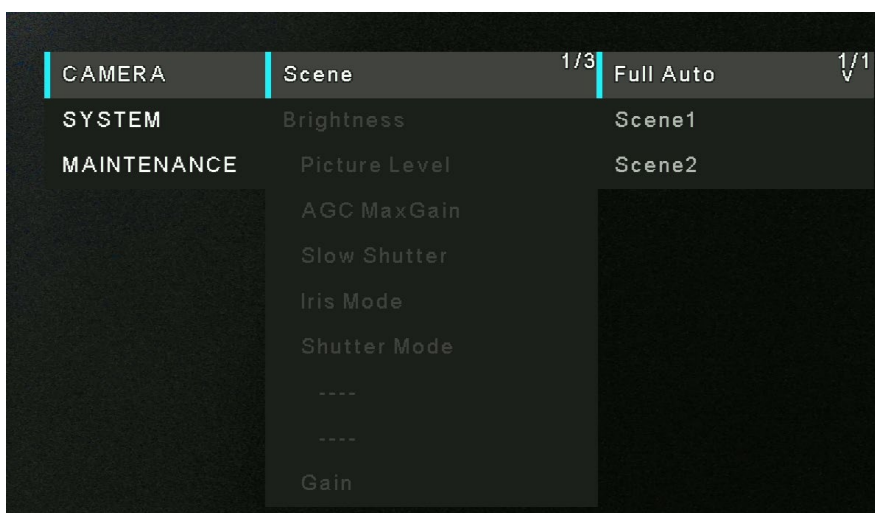

8 Press [◀] to leave from scene mode menu.

9 Press the [MENU] button for 2 seconds to exit from the menu.

Operating the Camera unit

When performing the operations using the wireless remote control

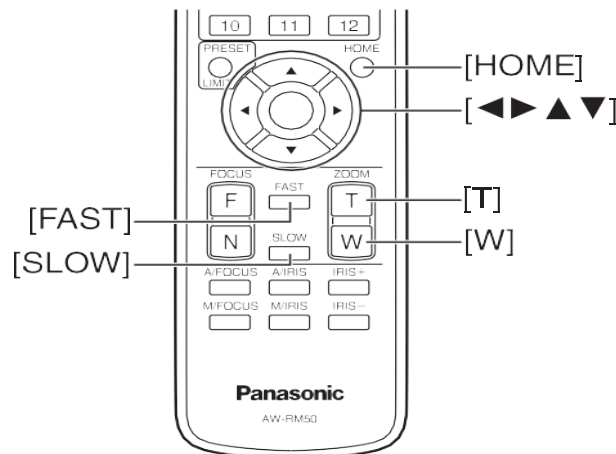

Control the Picture's Direction (using the wireless remote control)

- Moving the picture toward the left or right (panning): Press the [◀] or [▶] button.
- Moving the picture up or down (tilting): Press the [▲] or [▼] button.
- Moving the picture diagonally: Press the [▲] or [▼] button and [◀] or [▶] button at the same time.
- Returning the picture to the reference position: Press the [HOME] button for 2 seconds.

Zoom In/Out Function (using the wireless remote control)

- Zooming in (the subject becomes magnified in size): Press the [T] button of [ZOOM].
- Zooming out (the subject becomes reduced in size): Press the [W] button of [ZOOM].

Switching the Direction or Zoom Speed (using the wireless remote control)

- Changing the direction or zoom at high speed: Press the [FAST] button.
- Changing the direction or zoom at low speed: Press the [SLOW] button.

When performing the operations using the controller (AW-RP60/AW-RP150)

Control the Picture's Direction (using the controller)

- Moving the picture toward the left or right (panning): Tilt the <PAN/TILT> lever toward L or R.
- Moving the picture up or down (tilting): Tilt the <PAN/TILT> lever toward UP or DOWN.
- Moving the picture diagonally: Tilt the <PAN/TILT> lever diagonally.

Zoom In/Out Function (using the controller)

- Zooming in (the subject becomes magnified in size): Tilt the <ZOOM> lever toward the TELE direction.
- Zooming out (the subject becomes reduced in size): Tilt the <ZOOM> lever toward the WIDE direction.

Switching the Direction or Zoom Speed (using the controller)

For details, refer to the operating instructions for the controller.

What to do when Encountering Problems in the Basic Shooting Operations

If the trouble is not resolved by taking the action suggested below, refer to “**Troubleshooting**” section.

When performing the operations using the wireless remote control

■ **The unit does not move.**

- Press the [CAMERA 1], [CAMERA 2], [CAMERA 3] or [CAMERA 4] button to select the unit which is to be operated.
- If only one unit is being used, it is normally selected using the [CAMERA 1] button.
- Check that the Wireless ID has been set correctly.
- If the unit's status display lamp is off or lights up orange, it means that the unit's power is not on.
- Refer to “**Power on the Camera Unit**” section.
- If the unit's status display lamp does not blink even when the wireless remote control is operated near the unit's wireless remote control signal light-sensing area, it means that the wireless remote control's batteries have run down. Replace the batteries.

■ **Multiple color bands (color bars) are displayed.**

Press the [MODE] button to switch to the camera picture.

■ **The menu screen is displayed.**

Press the [MENU] button for 2 seconds to exit the camera menu.

■ **Something is wrong with the coloring of the pictures.**

Refer to “**Auto tracking white adjustment (ATW)**” and switch to “**ATW**”.

When performing operations from a controller (AW-RP60/AW-RP150).

■ **The unit does not move.**

- Select the unit to be operated by referring to the operating instructions for the controller.
- if the unit's status display lamp is off or lights up orange, it means that the unit's power is not on. Refer to "Turn the power on", and turn on the power.
- Check that the account settings for this unit have been set correctly.
- Network connection with AW-RP60/AW-RP150 requires setup of an initial account. When an initial account is not set up, AW-RP60/AW-RP150 can detect but cannot control this unit.

■ **Multiple color bands (color bars) are displayed.**

Switch to the camera image by pressing the <BARS> button.

■ **Something is wrong with the coloring of the camera pictures.**

Refer to "Auto tracking white adjustment (ATW)", and switch to [ATW].

Advanced Operations

In the following will description more operations and setting of the camera unit.

Preset Memories

The camera unit enables up to 100 settings for the camera direction (panning and tilting), zoom to be registered in its preset memories, and called. However, the number of settings that can be registered and called depends on the type of wireless remote control or controller that is used for operation.

[Note]

- The recalling of a preset can be performed while the recalling of a preset can be performed while manual operations, such as pan, tilt, zoom.
- Nothing will occur if a preset memory number to which a preset has not been registered is recalled.

When performing the operations using the wireless remote control

Twelve settings (preset No.1 to No.12) can be registered and called using the wireless remote control.

The [1] to [12] buttons correspond to the unit's preset memories No.1 to No.12.

■ Registering the settings in the preset memories

- 1 Display the picture to be shot on the monitor. Operate the pan, tilt or zoom buttons to determine the camera view.**
- 2 While holding down the [PRESET] button, press the button corresponding to the preset memory number.**
If a preset memory number with an already registered setting has been selected, the existing setting will be erased and replaced with the new one.

■ Calling the settings of the preset memories

Press the button in which the preset memory setting has been registered.

When performing operations from a controller (AW-RP60/AW-RP150).

UP to 100 entries can be registered/recalled.

For details, refer to the operating instructions for the controller.

Adjust the White Balance

In order for the white to be reproduced accurately, the ratio between the three primary colors (RGB) is adjusted. If the white balance has shifted out of adjustment, not only will the white be reproduced poorly but the color tones of the entire screen will also be degraded.

- This adjustment must be performed when using the unit for the first time or when the unit has not been used for a prolonged period.
- It must be performed when the lighting conditions or brightness has changed.
- Once the white balance values have been adjusted, their setup procedure will be completed simply by selecting them using the menus, web settings or by pressing the buttons on the controller; provided that they are going to be used under the same conditions as the ones established when the values were set. There is no need to set it again.
- Once a new setting is entered, the previous setting will be erased.

[Note] For details, refer to “**Selecting the Scene Mode**” section.

Automatic Adjustment (AWB: AWB A or AWB B)

When performing the operations using the wireless remote control

1. Shoot a white subject (such as a white wall or handkerchief) so that it fills the screen.
Do not shoot shiny or very bright objects.

Steps 2 through 6 represent the procedure for selecting the “AWB A” or “AWB B” memory. They need not be taken if a selection has already been made.

2. Select a scene mode by following the procedure in “Selecting the Scene Mode” section.



3. Press the [▲] or [▼] button to bring the highlight to “**White Balance Mode**”. Press the [○] button to enter White Balance mode menu.

4. Press the [▲] or [▼] button to change the White Balance Mode to be used to “AWB A” or “AWB B”, and press the [○] button to confirm the selection. The selected selection will have a mark sign within.

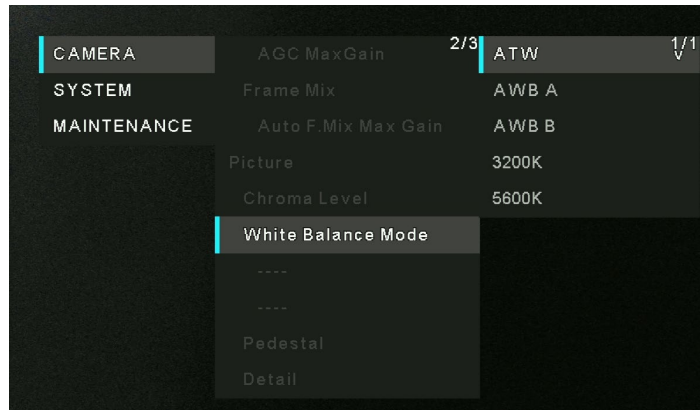

5. Press the [MENU] button for 2 seconds to exit from menu.

6. Press the <SET> button.

The auto white balance adjustment (AWB) is performed, and the white balance setting is entered.

[Note]

- The white balance cannot be adjusted when color bars are displayed. Press the [MODE] button to switch to the camera picture.
- White balance may not be correctly set if the lighting of the object is too weak.
- Since the unit has a built-in memory, the set white balance will remain in the memory even if power is turned off. Therefore, it is not necessary to reset the white balance if the color temperature of those objects remains unchanged. However, it must be reset if the color temperature changes, such as when you move from indoors to outside, or vice versa.

When performing the operations using the controller (AW-RP60/AW-RP150).

For details, refer to the operating instructions for the controller.

Auto Tracking White Balance Adjustment (ATW)

When white balance adjustment is set to “ATW”, the white balance will be corrected automatically, even if the light source or color temperature changes.

This function works when “ATW” is selected instead of “AWB A” or “AWB B” by following the steps for “Automatic adjustment” in “**Automatic Adjustment (AWB: AWB A or AWB B)**” (page 44).

[Note]

- ATW might not function properly when high brightness light (ex. fluorescent lamp) beams into a screen.
- White balance may not be accurately set if there is no white object in the scene being shot.
- The white balance may shift out of adjustment when a different kind of light source such as sunlight or fluorescent lighting applies.

3200K and 5600K Presets

When “3200K” or “5600K” is selected for the white balance, the white balance is set using a color temperature of 3200K (equivalent to halogen light) or 5600K (equivalent to daylight), respectively.

This function works when “3200K” or “5600K” is selected instead of “AWB A” or “AWB B” in the “Automatic adjustment” procedure in “**Automatic Adjustment (AWB: AWB A or AWB B)**”.

Menu Operation

Menus are displayed on the monitor when the unit's settings are to be selected.

The monitor is connected to the video signal output connector.

The basic camera menu operations involve displaying sub-menus from the main menu items, and selecting settings on the sub-menus.

Some sub-menus have menu items for performing more detailed settings.

The menu operations are conducted using the wireless remote control.

Described below are the basic operations for changing the camera menu item settings using the wireless remote control.

Only the steps taken using the wireless remote control will be described here for the operations conducted to select and set the items.

Operations Table

Menu operation	Wireless remote control
Selecting the unit to be operated	Press the [CAMERA 1], [CAMERA 2], [CAMERA 3] or [CAMERA 4] button.
Displaying the main Menu	Press the [MENU] button for 2 seconds.
Selecting the items	Press the [▲] or [▼] ([◀] or [▶]) button.
Displaying the sub-menus	Press the [○] button.
Returning to the previous menu	Move the highlight at the "Return" position, press the [○] button.
Changing the settings	With the highlight at the item to be changed, press the [○] button to select it. Use the [▲], [▼], [◀] and [▶] buttons to change the value, and press the [○] button to enter the change.
Canceling the setting change	Press the [MENU] button.
Exiting the menu operations	Press the [MENU] button for 2 seconds.

[NOTE]

When AW-RP60/AW-RP150 is connected, refer to the operating instructions for the controller.

When performing the operations using the wireless remote control

1. Press the [CAMERA 1], [CAMERA 2], [CAMERA 3] or [CAMERA 4] button to select the unit which is to be operated.
2. Press the [MENU] button for 2 seconds.
The main menu is displayed.
3. Press the [▲] or [▼] button to bring the cursor to the item to be selected.
Each time the [▲] or [▼] button is pressed, the cursor moves. The cursor can be moved in the same way using the [◀] and [▶] buttons.
4. Press the [○] button.
The sub-menu of the selected item is displayed. (Some sub-menu items have a sub-menu of their own.)
5. Press the [▲] or [▼] button to bring the cursor to the item to be set.
Each time the [▲] or [▼] button is pressed, the cursor moves.
The cursor can be moved in the same way using the [◀] and [▶] buttons.
With the cursor at the "Return" position, press the [○] button to return to the previous menu.

6. Press the [○] button.

The value of the item to be selected or confirmed.

7. Press the [▲] or [▼] button to change the setting.

The setting can be changed in the same way using the [◀] and [▶] buttons.

8. Press the [○] button.

The value of the item to be set is entered, and it has a mark sing within.

9. After the setting has been completed, press the [MENU] button for 2 seconds.

The menu display is exited.

Menu Items

■ Setting the menu items

When the unit's settings are to be selected, the camera menus are displayed on the monitor.

The monitor is connected to the video signal output connector.

The basic camera menu operations involve displaying sub-menus from the Top Menu items, and selecting settings on the sub-menus.

Some sub-menus have menu items for performing more detailed settings.

Main Menu Screen

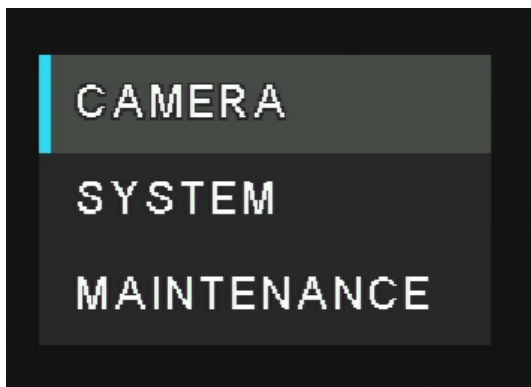

■ Camera

Select this to open the camera menu relating to the camera images.

■ System

Displays the System menu in which the camera's output image settings are configured.

■ Maintenance

Displays the Maintenance menu which concerns checking the unit's firmware versions, checking the IP address and initialize the settings.

[Note]

The main Menu does not have a "Return" setting.

Camera Menu

This menu is for the camera image settings. The functions will be varied by selected "scene" mode (Full Auto, Scene1, and Scene2).

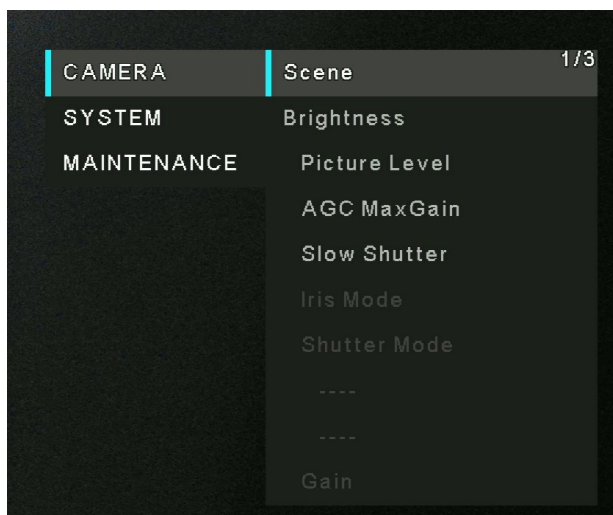

Scene

There are three scene modes – Full Auto, Scene 1, and Scene 2.

- Full Auto:** In this mode, for menu items under [Brightness], the optimum settings and adjustments for the shooting conditions at hand are automatically established. But user still can adjust the value of *Picture Level*, *AGC MaxGain*, and *Slow Shutter*.
- Scene1 and Scene2:** One of two shooting modes (Scene1 and Scene2)—whichever one will best suit the shooting conditions—can be selected. The shooting modes are set by the user.

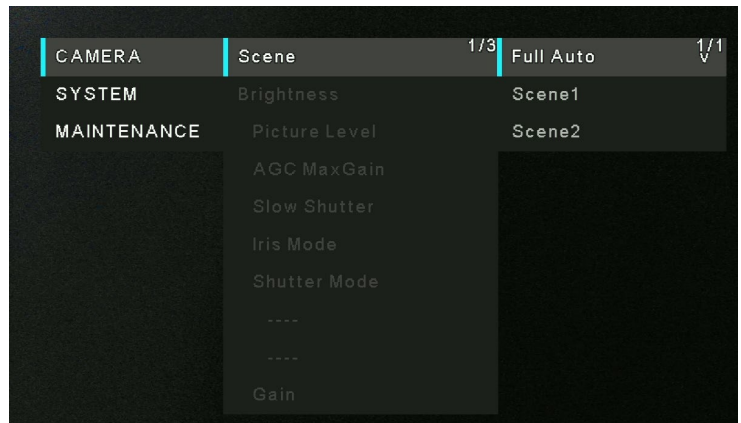

Factory settings: **Full Auto**

For details of the factory setting, refer to pages 66 to 68.

Picture Level

[-4~4]

Adjust the brightness level.

Factory settings: 0

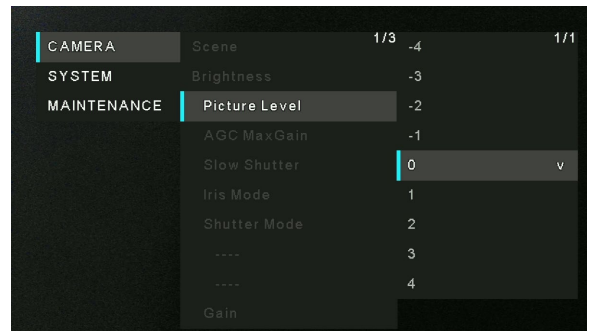

AGC MaxGain

[24dB, 30dB, 36dB, 42dB]

If you select **CAMERA < Scene < Full Auto**, you can set up the maximum gain-up amount value.

If you select **CAMERA < Scene < Scene1/Scene2**, when “Auto” is selected as the “Gain” setting, the maximum gain-up amount can be set as (24 dB, 30 dB, 36 dB, 42 dB).

Factory settings: 24 dB.

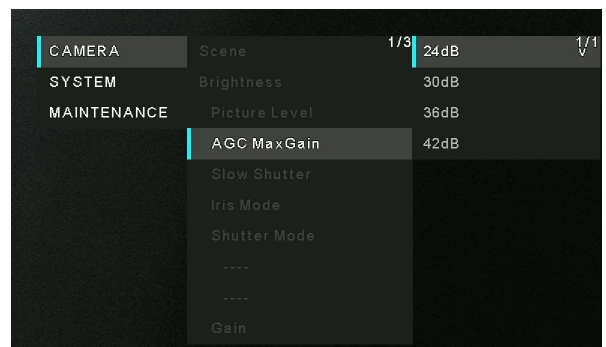

Slow Shutter

[Off, On]

Set slow shutter function to “On” or “Off”.

Factory settings: Off

[Note]:

This is only enabled when [Scene] is set to [Full Auto].

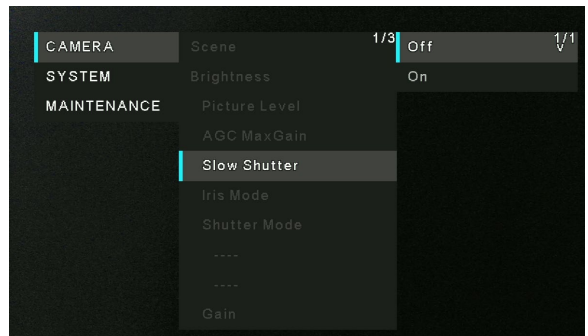

Iris Mode

[Auto, Manual]

You can choose to manually or automatically adjust iris.

Manual	The iris is adjusted manually.
Auto	Auto exposure compensation is performed so that the target level which was set using [Picture Level] is reached.

Factory settings: Auto

[Note]:

This is only enabled when [Scene] is set to [Scene1] or [Scene2].

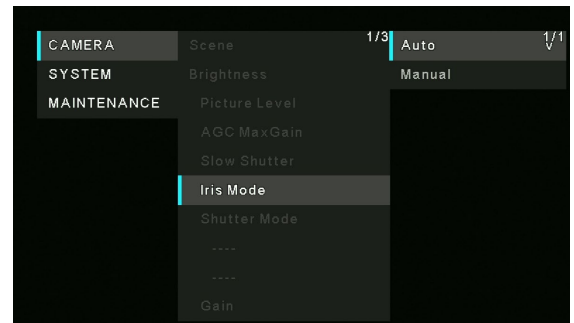

Shutter Mode

[Off, Step, Synchro]

Factory settings: Off

- When “Step” is selected as the “Shutter Mode”
 [50Hz]
 1/1, 1/2, 1/3, 1/6, 1/12, 1/25, 1/50, 1/100, 1/250, 1/500, 1/1000, 1/2000, 1/4000, 1/8000, 1/16000

 [59.94Hz/60Hz]
 1/1, 1/2, 1/3, 1/7, 1/15, 1/30, 1/60, 1/120, 1/240, 1/480, 1/1000, 1/2000, 1/4000, 1/8000, 1/16000
- When “Synchro” is selected as the “Shutter Mode”
 [59.94p/29.97p]
 60.0Hz~660.0Hz
 [50p/25p]
 50.0Hz~570.1Hz

[Note]:

Shutter Mode is only enabled when [Scene] is set to [Scene1] or [Scene2].

The Synchro value can be set up to 255 steps in the above range.

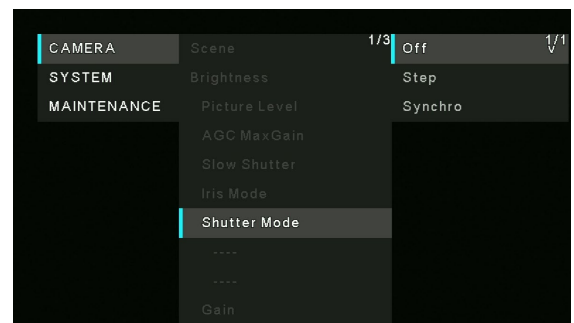

Gain

[Auto, 0dB, 3dB, 6dB, 9dB, 12dB, 15dB, 18dB, 21dB, 24dB, 27dB, 30dB, 33dB, 36dB, 39dB, 42dB]

In locations which are too dark, adjust the gain upward; conversely, in locations which are too bright, adjust it downward. When “Auto” mode is set, the light quantity is adjusted automatically.

The noise increases when the gain is increased.

Factory settings: 0



Frame Mix

[Auto, Off, 6dB, 12dB, 18dB, 24dB]

Select for frame addition (gain-up using sensor storage) amount.

When frame addition is performed, it will appear as if the images are missing some frames.

Factory settings: Off

[Note]:

[Frame Mix] is only enabled when [Shutter Mode] is set to [Off].

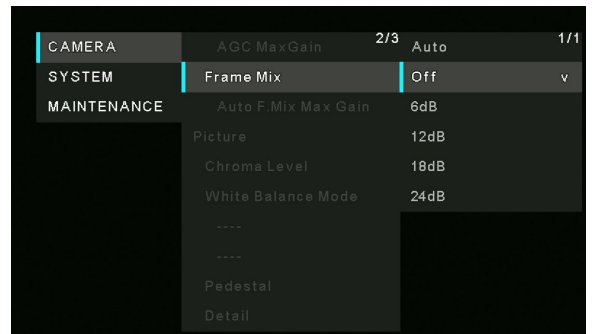

Auto F. Mix Max Gain

[0 dB, 6dB, 12dB, 18dB]

Sets the maximum amount of frames that can be added when [Frame Mix] is running in [Auto] mode.

When frame addition is performed in [Auto] mode, it will appear as if the images are missing some frames.

Factory settings: 0

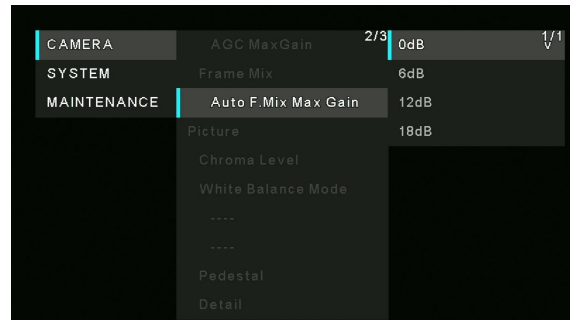

Chroma Level

[0~10]

Set the color intensity (Chroma level) of the images, 0-10.

Factory settings: 5

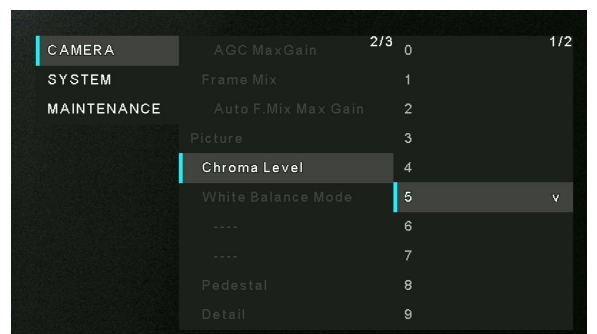

White Balance Mode

Select the mode when the coloring is not natural because of the nature of the light source or other factors. If the white color serving as the reference can be recognized, subjects can be shot with natural coloring.

- **ATW:** This mode automatically corrects the white balance, even if the light source or color temperature changes.
- **AWB A, AWB B:** When AWB A or AWB B is selected and the white balance is executed, the adjustment results obtained are stored in the memory selected.
- When AWB A or AWB B is then selected, the white balance stored in the selected memory can be recalled.
- **3200K:** This white balance mode is ideal when a 3200K halogen light is used as the light source.
- **5600K:** This white balance mode is ideal when 5600K sunlight or fluorescent lighting is used as the light source.

Factory settings: ATW

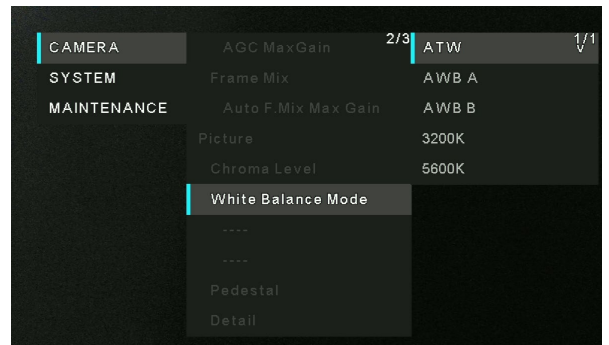

R Gain

[-30 ~ +30]

This enables the R Gain to be adjusted.

Its setting takes effect when [AWB A] or [AWB B] has been selected as the [White Balance Mode] setting.

Factory settings: 0

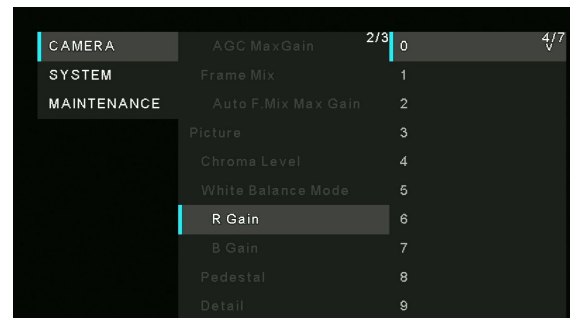

B Gain

[-30 ~ +30]

This enables the B Gain to be adjusted.

The function takes effect when [AWB A] or [AWB B] has been selected as the [White Balance Mode] setting.

Factory settings: 0

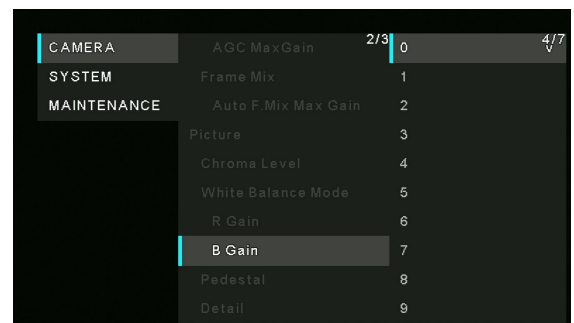

Pedestal

[-10 ~ +10]

This item is used to adjust the black level (adjust the pedestal).

These parts become darker when a negative setting is selected and, conversely, lighter when a positive setting is selected.

Factory settings: 0

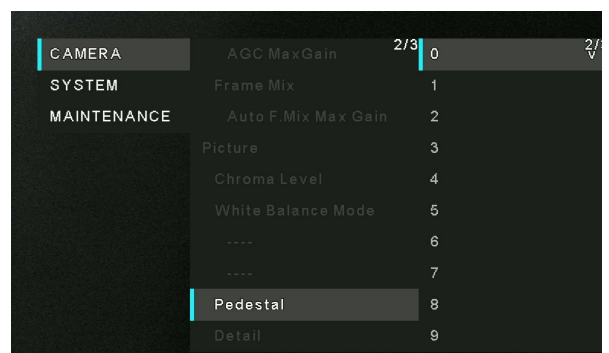

Detail

[0~3]

Adjust the sharpness of the image.

Factory settings: 2

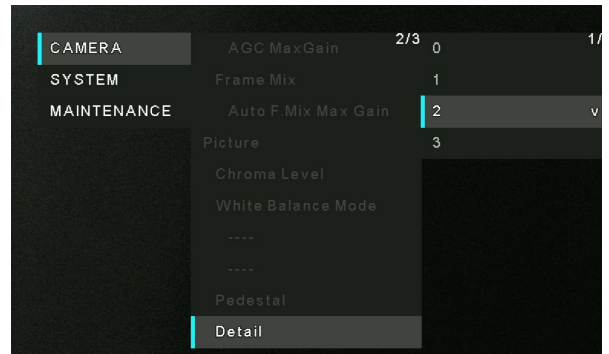

Contrast

[0~4]

Adjust the contrast level of the image.

Factory settings: 2

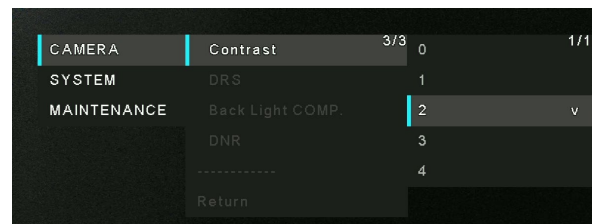

DRS

[Off, On]

Set here is the DRS function which provides just the right amount of compensation when images with significant light/dark differences are displayed.

Depending on the shooting conditions, however, the picture quality may drop with increased noise.

Factory settings: Off

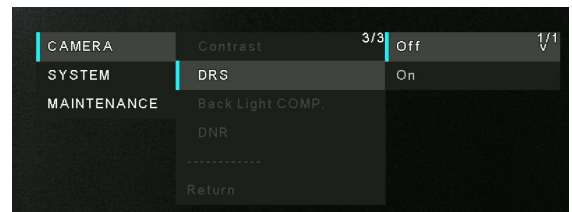

Back Light COMP

[Off, On]

Set backlight compensation function to "On" or "Off".

Under backlight conditions, the function prevents darkening as a result of light striking the backs of subjects, and makes it possible to shoot images in shade or shadow more brightly.

Factory settings: Off

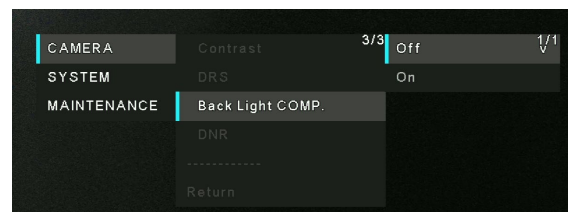

DNR

[Off, Low, High]

Set the level of the digital noise reduction effect so that light, noise-free and clear images will be output even at night and in other low-brightness environments.

When "Low" or "High" is selected, noise can be eliminated.

However, there is an increased possibility that afterimages may occur.

Factory settings: Low

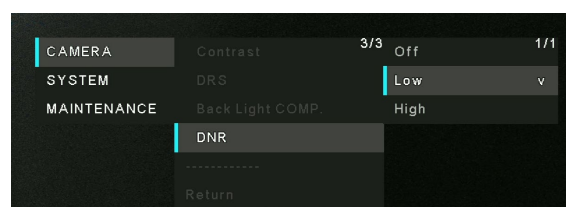

System Menu

The following will describe the each function in System menu.

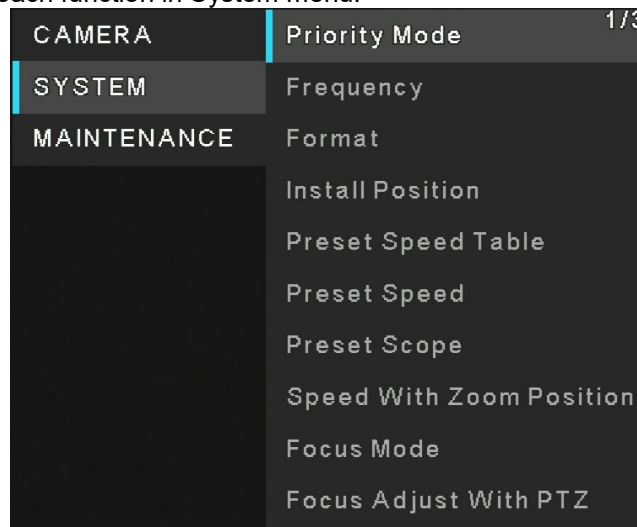

Priority Mode

Configure the setting for the priority output of video.

- **HDMI/USB:** HD format video is output to an external monitor connected via an HDMI/SDI cable. Enables the unit to be used as a Web camera. The camera can also be controlled from a personal computer.
- **IP:** HD format video is output to an external monitor connected via an HDMI/SDI cable. Enables IP image transmission. The IP transmission of H.264/H.265 images is also supported. This unit cannot display H.264/H.265 format images on the Live screen. To display H.264/H.265 images, use an external device or external software that supports H.264/H.265 images.
- **USB (Video Conference):** Enables the unit to be used as a Web camera. Specially tuned for online meetings, the unit automatically goes into the Standby mode when an online meeting comes to an end; if an online meeting starts while the unit is in the Standby on mode, the unit automatically switches into the Power ON mode.

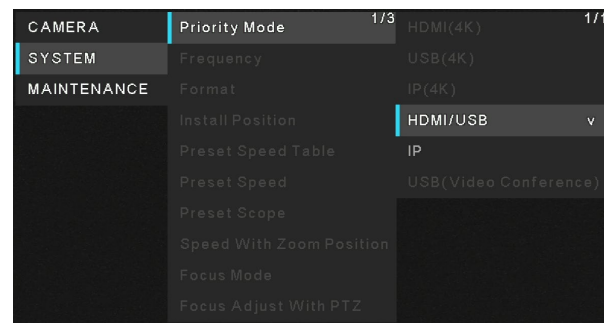

Factory settings: HDMI/USB

Frequency

[50Hz, 59.94Hz, 60Hz]

Set the frame frequency – 50Hz, 59.94Hz, or 60Hz.

When the frequency is switched, “Format” is set as following:

Frequency	50Hz	59.94Hz	60Hz
Format HDMI	1080/50p	1080/59.94p	1080/60p
	1080/25p	1080/29.97p	1080/30p
	720/50p	720/59.94p	720/60p
	1080/50i	1080/59.94i	1080/60i
Format SDI	1080/50p,	1080/59.94p,	1080/60p,
	1080/25p,	1080/29.97p,	1080/30p,
	720/50p	720/59.94p	720/60p
	1080/50i	1080/59.94i	1080/60i

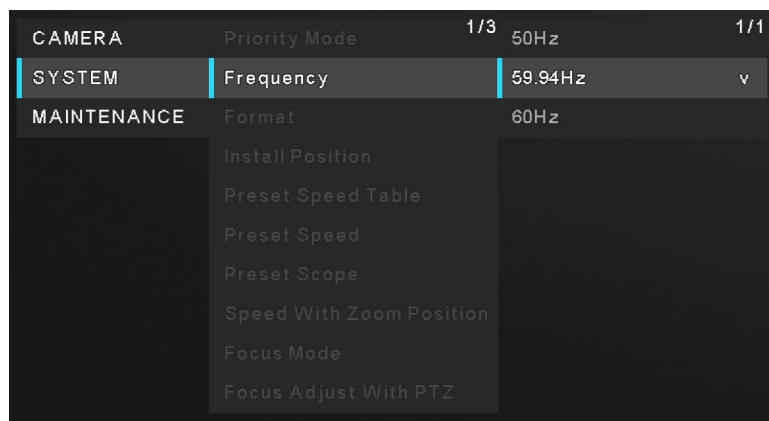

When changing the frequency, select “OK” to confirm the changing.

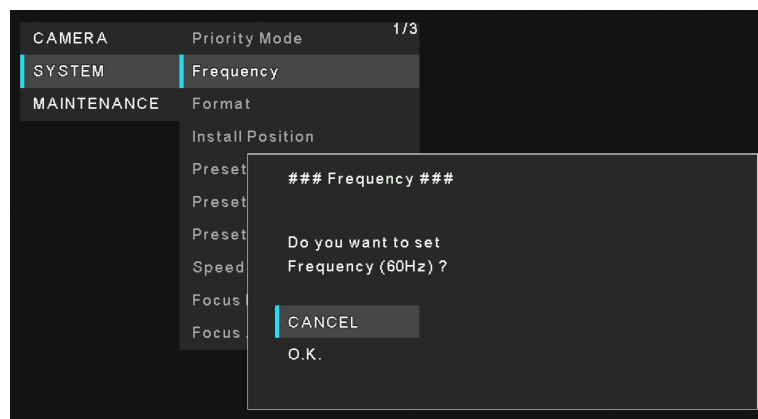

[Note]

When using a monitor that does not support 59.94Hz/50Hz/60Hz frequencies, images may not be displayed after the frequency is changed. Before changing the frequency, verify that your monitor supports that frequency.

When Frequency is changed, the unit restarts.

Factory settings: 59.94Hz (AW-UE20KP, AW-UE20WP)

50Hz (AW-UE20KE, AW-UE20WE, AW-UE20KED, AW-UE20WED)

Format

Change the image format. The image format can differ by the frequency.

Frequency	50Hz	59.94Hz	60Hz
Format HDMI	1080/50p 1080/25p 720/50p 1080/50i	1080/59.94p 1080/29.97p 720/59.94p 1080/59.94i	1080/60p 1080/30p 720/60p 1080/60i
Format SDI	1080/50p, 1080/25p, 720/50p 1080/50i	1080/59.94p, 1080/29.97p, 720/59.94p 1080/59.94i	1080/60p, 1080/30p, 720/60p 1080/60i

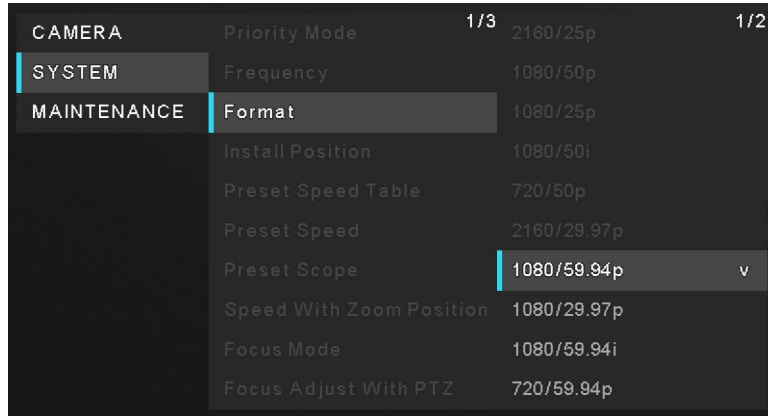

When changing the format, select “OK” to confirm the changing. Finally, select “Yes” to accept the changes.

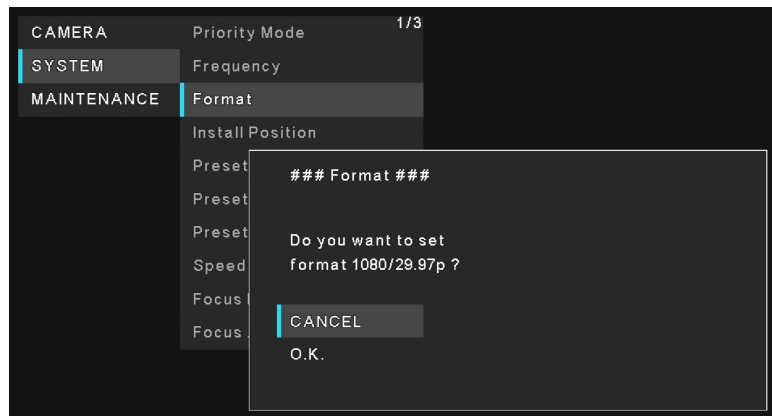

Factory settings:

[50Hz] 1080/50p

[59.94Hz] 1080/59.94p

[60Hz] 1080/60p

Install Position

[Desktop, Hanging]

“Desktop” or “Hanging” is selected here as the method used to install the unit.

When “Hanging” has been selected, the top, bottom, left and right of the images will be reversed and up/down/left/right control for panning and tilting will also be reversed.

Factory settings: Desktop

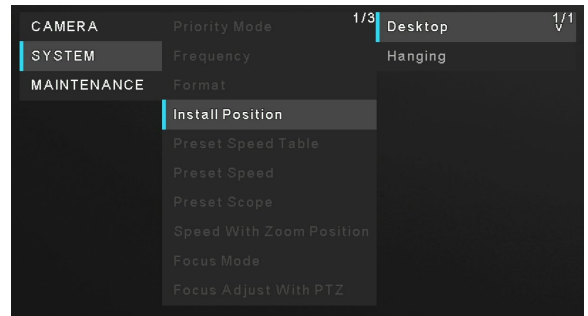

Preset Speed Table

[Slow, Fast]

Set the preset speed table (Slow, Fast).

During preset playback, preset actions are performed at Preset Speed (1 to 30) values that are based on the table set here.

Factory settings: Fast

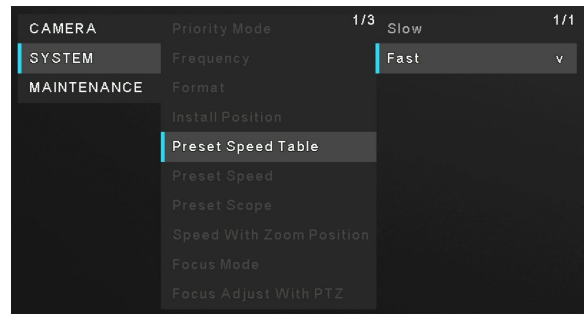

Preset Speed

[1~30]

Set the pan/tilt operation speed in 30 steps when playing back the preset memory.

Factory settings: 20

[Note]

If a high value is selected for the Preset Speed setting, the image on the screen may shake when operation stops.

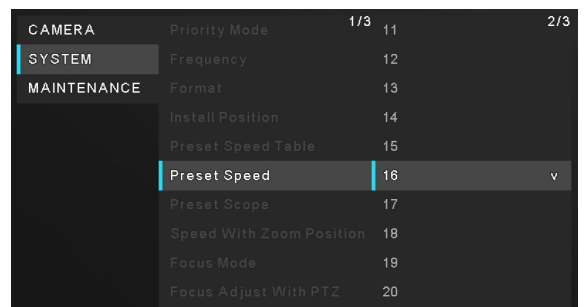

Preset Scope

[Mode A, Mode B, Mode C]

Selected here are the setting items to be recalled when the contents of the preset memory are regenerated.

Mode A	Pan, Tilt, Zoom (including digital zoom), Focus, Iris, Gain, White Balance
Mode B	Pan, Tilt, Zoom (including digital zoom), Focus, Iris
Mode C	Pan, Tilt, Zoom (including digital zoom), Focus

Factory settings: Mode A

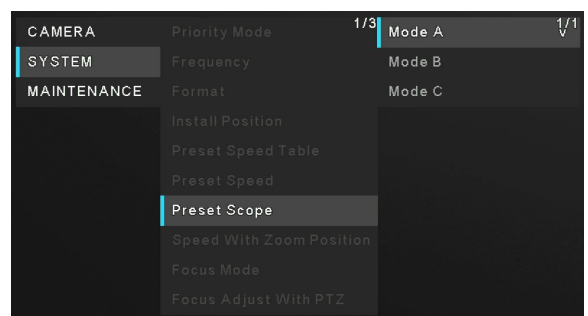

Speed with Zoom Position

[Off, On]

When [On] is set, if you adjust the zoom in the “Tele” direction, the panning and tilting operations will become slower than usual.

This function has no effect during preset operations.

Factory settings: On

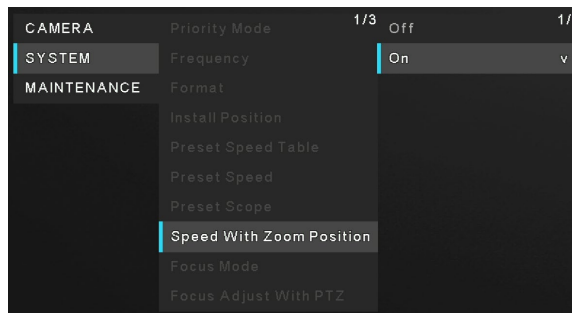

Focus Mode

[Manual, Auto]

“Auto” or “Manual” is set here for the focusing function.

Auto: The subjects are always brought into focus automatically.

Manual: The focus is operated manually.

Factory settings: Auto

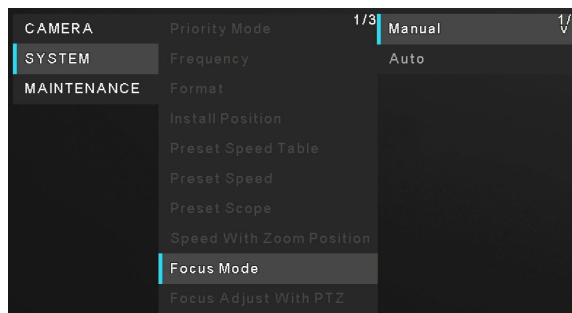

Focus Adjust With PTZ

[Off, On]

“Off” or “On” is set here for the function which compensates for out-of-focusing when it occurs during panning, tilting or zooming operations at the manual focus setting.

This item can be selected only when “Manual” has been selected as the “Focus Mode” setting.

Factory settings: Off

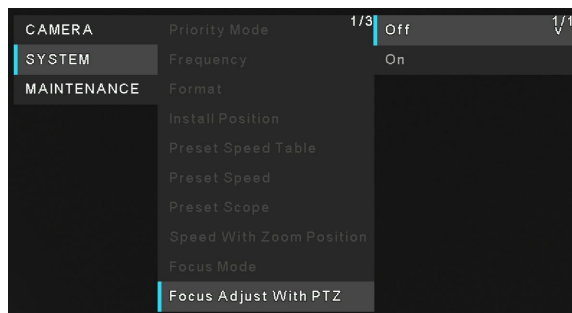

Zoom Mode

[Opt.Zoom, i.Zoom, D.Zoom]

Select a zoom mode.

Opt.Zoom	Use only the optical zoom. Up to 12× optical zoom is possible.
i.Zoom	Enabling this function allows you to perform electronic zoom while reducing drops in picture quality. Combining optical zoom and electronic zoom, up to 15.96× zoom is possible.
D.Zoom:	Enable the digital zoom function. Picture quality degrades as zoom increases with digital zoom.

Factory settings: Opt.Zoom

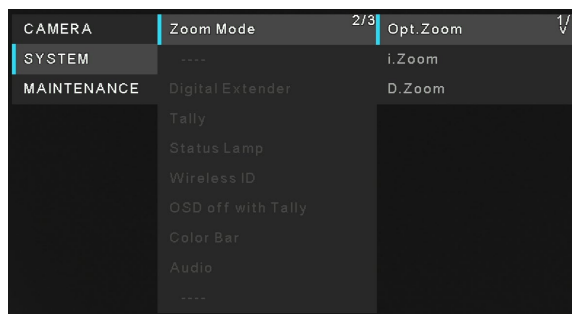

Max Digital Zoom

[×2, ×3, ×4]

Set the maximum digital zoom magnification.

This is only enabled when [Zoom Mode] is set to [D.Zoom].

Factory settings: ×4

[Note]

Higher digital zoom magnifications will result in coarser images.

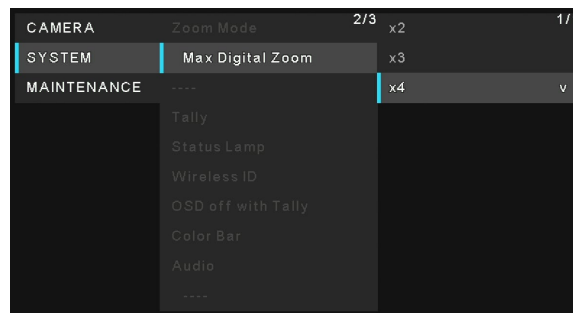

Digital Extender

[Off, ×1.4, ×2.0]

Make settings for the digital extender function.

Off	Turn the digital extender function off.
×1.4	The digital zoom will be fixed at 1.4×.
×2.0	The digital zoom will be fixed at 2.0×.

Factory settings: Off

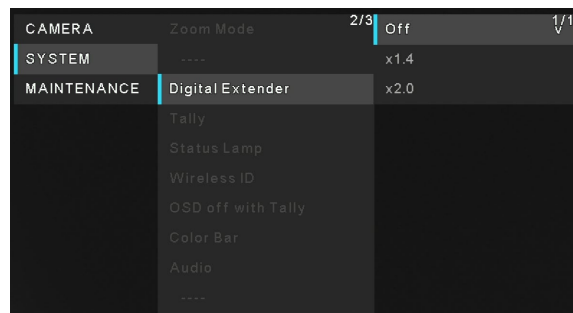

Tally

[Enable, Disable]

“Enable” or “Disable” is set here for the function which turns on or turns off the tally lamp using the tally control signal.

Factory settings: Enable

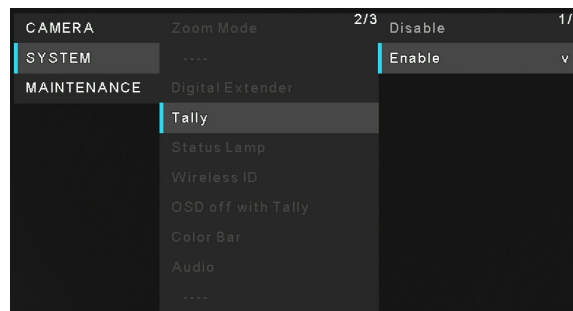

Status Lamp

[Enable, Disable]

[Disable] or [Enable] is set here for the status display lamp.

When you want the status display lamp to stay off while this unit is in operation, set to [Disable].

Factory settings: Enable

[Note]

Even when set to [Disable], the status display lamp may light up when this unit is starting up, updating firmware, or trouble is occurring.

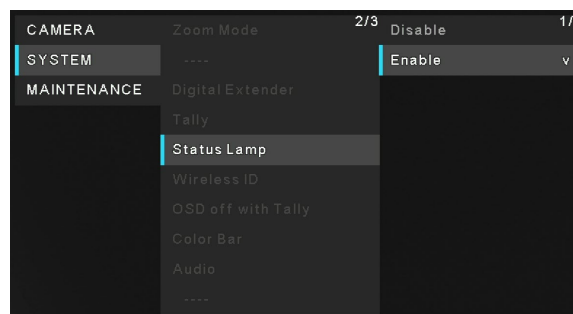

Wireless ID

[1, 2, 3, 4]

Configure the unit's remote control ID. The settings for this item correspond to the [CAMERA 1] to [CAMERA 4] buttons on the wireless remote control.

Factory settings: 1

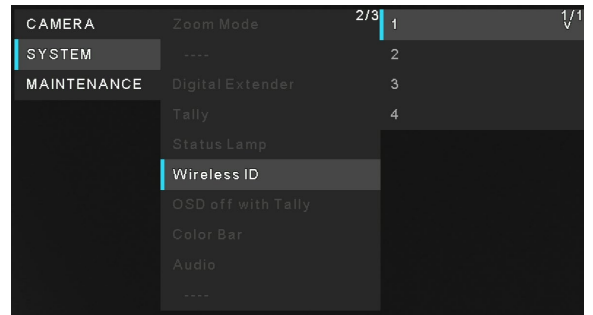

OSD off with Tally

[Off, On]

“Off” or “On” the function that turns off menu and other displays when red tally signals are received via commands.

When the red tally signal releases, the menu display will return.

Factory settings: Off

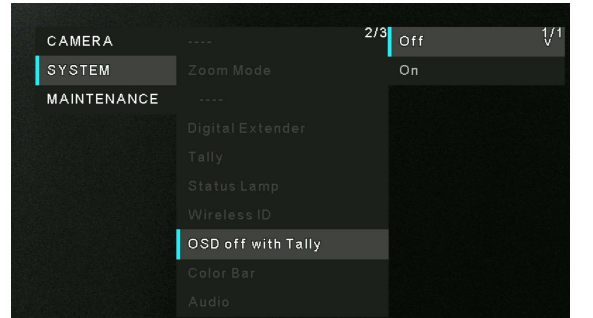

Color Bar

[Off, On]

Switch between color bar display and camera image display.

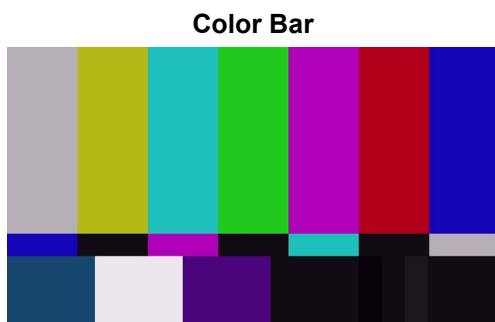

Factory settings: Off

[Note]

Only HDMI and SDI can output color bar.

IP and USB cannot output color bar.

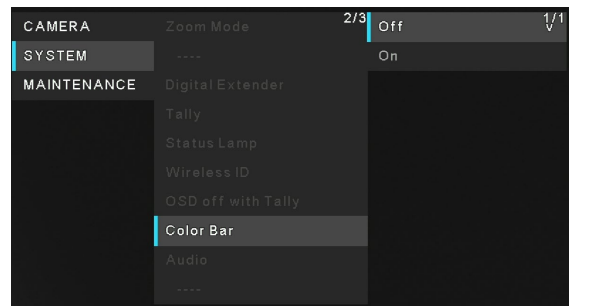

Audio

[Off, On]

Enable/disable the audio input signal from the device connected to the audio input connector.

Factory settings: Off

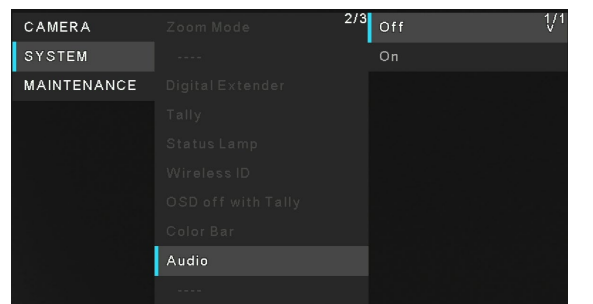

Input Type

[Mic, Line]

Select an Input Type.

Mic	Set the microphone input.
Line	Set the line input.

Factory settings: Line

This is only enabled when [Audio] is set to [On].

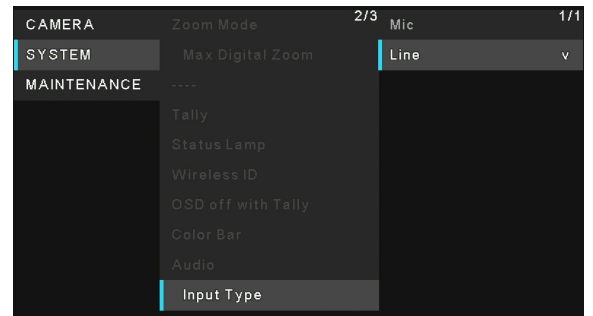

Volume Level

[-36 dB ~ +12 dB]

Set the volume of audio output.

This is only enabled when [Audio] is set to [On].

Factory settings: 0dB

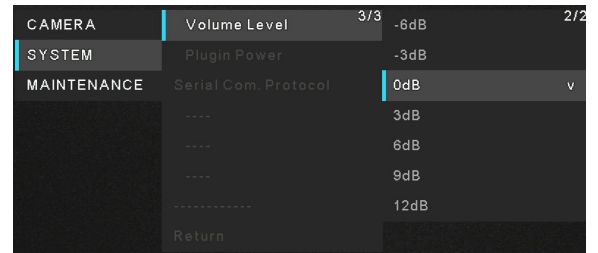

Plugin Power

[Off, On]

Turn the plugin power for the audio off/on.

This is only enabled when [Audio] is set to [On].

This is only enabled when [Input Type] is set to [Mic].

Factory settings: Off

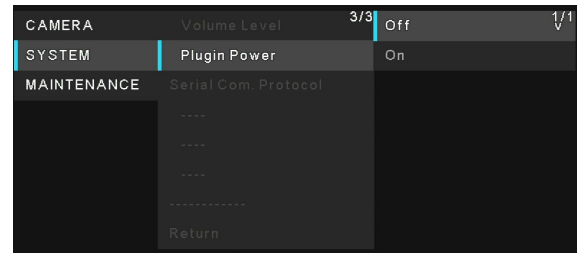

Serial Com. Protocol

[Panasonic, Standard]

Set the serial communication protocol for the RS422 terminal.

You can select either **Panasonic** or **Standard**.

Factory settings: Panasonic

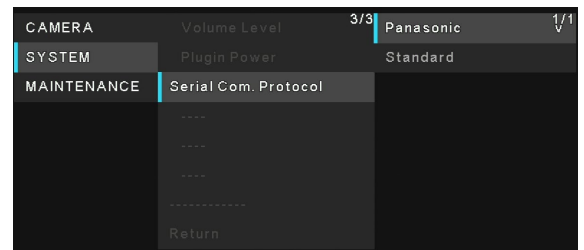

Connector Select

[RS422, RS232C]

You can select either **RS422** or **RS232C**.

Factory settings: RS422

This is only enabled when [Serial Com. Protocol] is set to [Standard].

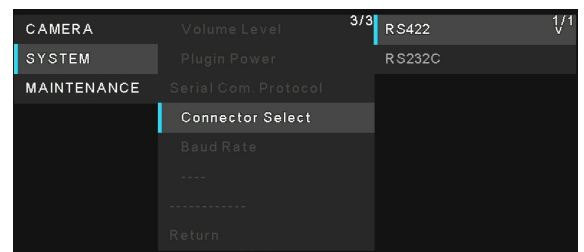

Baud Rate

[9600bps, 38400bps]

You can select a baud rate for serial communication.

Factory settings: 9600bps

This is only enabled when [Serial Com. Protocol] is set to [Standard].

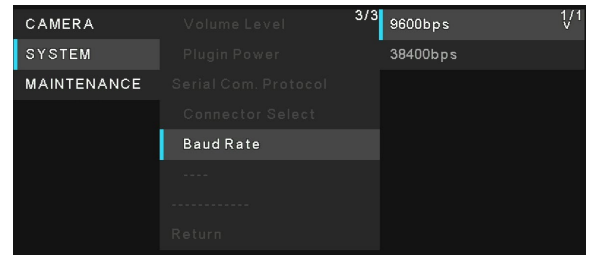

Camera Address

[Auto, 1, 2, 3, 4, 5, 6, 7]

Should you select **Auto**, the unit will be assigned with an IP address based on the order you connected the unit. If you select any number from 1 to 7, it will be assigned to the specified camera number.

Factory settings: Auto

This is only enabled when [Serial Com. Protocol] is set to [Standard] and [Connector Select] is set to [RS232C].

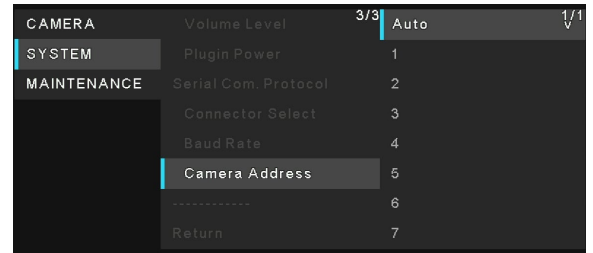

Maintenance Menu

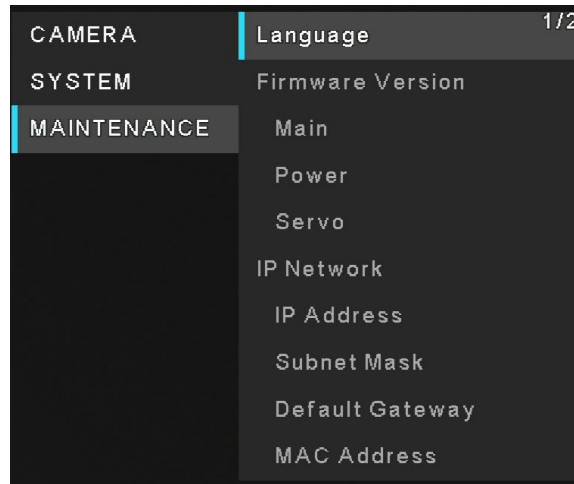

Language

[English, 日本語, 簡中]

The system supports three language – English, Japanese, and Simplified Chinese.

Factory settings: English



Firmware Version

Main: Displays the main software version.

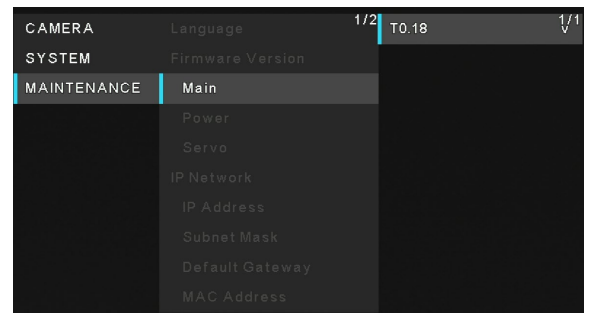

Power: Displays the software version of the power.

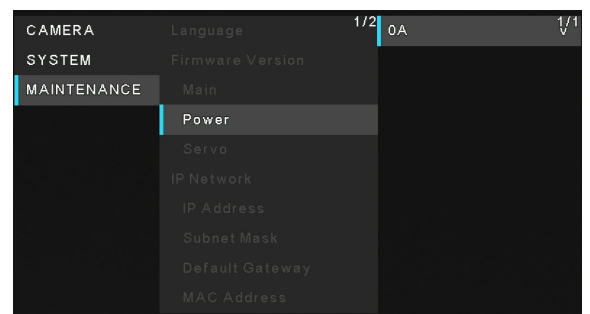

Servo: Displays the software version of the servo.

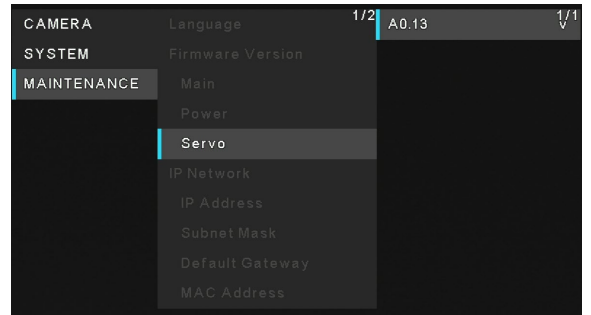

IP Address

Displays the IP address of the unit.

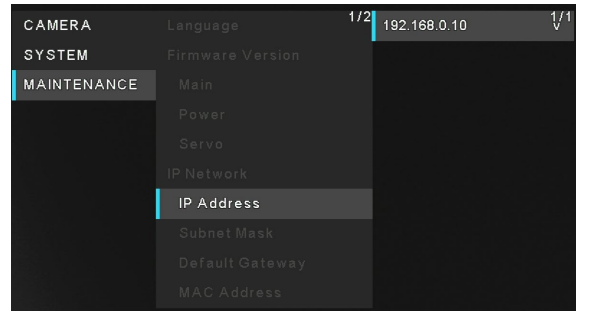

Subnet Mask

Displays the subnet mask of the unit.

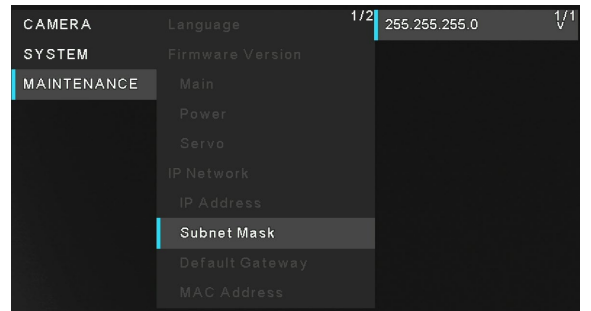

Default Gateway

Displays the default gateway which has been set for the unit.

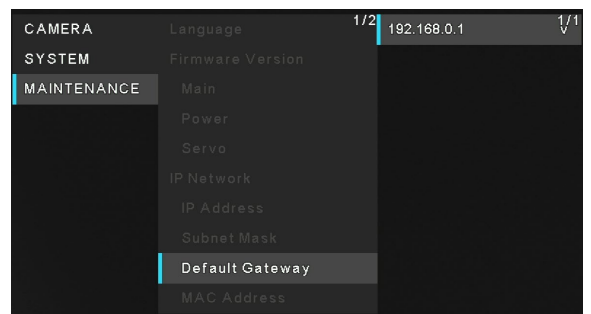

MAC Address

Displays the MAC address of the unit.

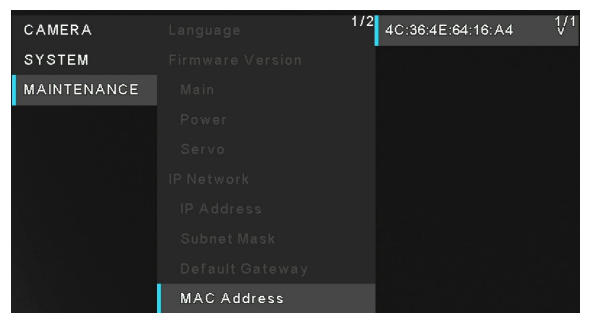

Initialize

[Execute, Cancel]

You can click [Execute] to initialize the menu items of the unit, except for the settings of [Priority Mode], [Frequency], and [Format].

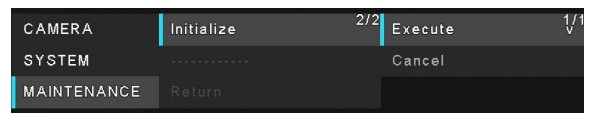

Menu Table

Main menu	Sub menu	Factory default setting			Selection Items
CAMERA	Scene	Full Auto	Scene1	Scene2	Full Auto, Scene1, Scene2
	Brightness				
	Picture Level	0	0	0	-4, -3, -2, -1, 0, +1, +2, +3, +4
	AGC Max Gain	24 dB	24 dB	24 dB	24 dB, 30 dB, 36 dB, 42 dB
	Slow Shutter	Off	---	---	Off, On
	Iris Mode	---	Auto	Auto	Auto, Manual
	Shutter Mode	---	Off	Off	Off, Step, Synchro
	Step	---	[50 Hz] 1/50 [59.94 Hz/60 Hz] 1/60	[50 Hz] 1/50 [59.94 Hz/60 Hz] 1/60	[50Hz] 1/1, 1/2, 1/3, 1/6, 1/12, 1/25, 1/50, 1/100, 1/250, 1/500, 1/1000, 1/2000, 1/4000, 1/8000, 1/16000 [59.94Hz/60Hz] 1/1, 1/2, 1/3, 1/7, 1/15, 1/30, 1/60, 1/120, 1/240, 1/480, 1/1000, 1/2000, 1/4000, 1/8000, 1/16000
	Synchro	---	[50 Hz] 50.0 Hz [59.94 Hz/60 Hz] 60.0 Hz	[50 Hz] 50.0 Hz [59.94 Hz/60 Hz] 60.0 Hz	[59.94p, 29.97p] 60.0 Hz~660.0 Hz [50p, 25p] 50.0 Hz~570.1 Hz
	Gain	---	0 dB	0 dB	Auto, 0 dB, 3 dB, 6 dB, 9 dB, 12 dB, 15 dB, 18 dB, 21 dB, 24 dB, 27 dB, 30 dB, 33 dB, 36 dB, 39 dB, 42 dB
	Frame Mix	---	Off	Off	Auto, Off, 6 dB, 12 dB, 18 dB, 24dB
	Auto F.Mix Max Gain	---	0 dB	0 dB	0 dB, 6 dB, 12 dB, 18 dB
	Picture				
	Chroma Level	5			0~10
	White Balance Mode	ATW			ATW, AWB A, AWB B, 3200K, 5600K
	R Gain	0			-30~+30
	B Gain	0			-30~+30
	Pedestal	0			-10~+10
	Detail	2			0, 1, 2, 3
	Contrast	2			0, 1, 2, 3, 4
DRS	Off			Off, On	
Back light COMP.	Off			Off, On	
DNR	Low			Off, Low, High	

Main menu	Sub menu	Factory default setting	Selection Items
SYSTEM	Priority mode	HDMI/USB	HDMI/USB, USB (Video Conference), IP
	Frequency	59.94Hz	50Hz, 59.94Hz, 60Hz
	Format	[50Hz] 1080/50p [59.94Hz] 1080/59.94p [60Hz] 1080/60p	[50Hz] 1080/50p, 1080/25p, 1080/50i, 720/50p [59.94Hz] 1080/59.94p, 1080/29.97p, 1080/59.94i, 720/59.94p [60Hz] 1080/60p, 1080/30p, 1080/60i, 720/60p
	Install Position	Desktop	Desktop, Hanging
	Preset Speed Table	Fast	Fast, Slow
	Preset Speed	20	1~30
	Preset Scope	Mode A	Mode A, Mode B, Mode C
	Speed With Zoom Position	On	Off, On
	Focus Mode	Auto	Manual, Auto
	Focus Adjust With PTZ.	Off	Off, On
	Zoom Mode	Opt.Zoom	Opt.Zoom, i.Zoom, D.Zoom
	Max Digital Zoom	x4	x2, x3, x4
	Digital Extender	Off	Off, x1.4, x2.0
	Tally	Enable	Disable, Enable
	Status Lamp	Enable	Disable, Enable
	Wireless ID	1	1, 2, 3, 4
	OSD off with Tally	Off	Off, On
	Color Bar	Off	Off, On
	Audio	Off	Off, On
	Input Type	Line	Mic, Line
	Volume Level	0 dB	-36 dB~+12 dB (3 dB step)
	Plugin Power	Off	Off, On
	Serial Com. Protocol	Panasonic	Panasonic, Standard
	Connector Select	RS422	RS422, RS232C
	Baud Rate	9600 bps	9600 bps, 38400 bps
	Camera Address	Auto	Auto, 1, 2, 3, 4, 5, 6, 7

Main menu	Sub menu	Factory default setting	Selection Items	
MAINTENANCE	Language	English	English, Japanese (日本語), Simplified Chinese (簡中)	
	FW Version	Version at shipping	---	
	Main	Power	---	---
		Servo	---	---
	IP Network			
	IP Address	Subnet Mask	255.255.255.0	---
		Default Gateway	192.168.0.1	---
		MAC Address	MAC Address of the unit	---
	Initialize	Execute	Execute, Cancel	

Web Screen Start-up

With a personal computer connected to the unit, it is possible to view the camera's IP videos or select various settings from the web browser.

The LAN crossover cable is used when connecting a personal computer directly to the unit's LAN connector for IP control, and the LAN straight cable is used when making the connection through a switching hub.

Select an IP address for the personal computer within the private address range while ensuring that it is different from the address of the unit. Set the subnet mask to the same address as the unit.

Unit's IP address and subnet mask (factory settings)*¹

IP address: 192.168.0.10

Subnet mask: 255.255.255.0

*¹ The factory default for the private address range is between 192.168.0.1 and 192.168.0.255.

If the controller and web browser are being used at the same time, the content selected using the controller may not be reflected on the web browser display.

When using both the controller and web browser, be absolutely sure to check the settings using the controller or menu.

For details of the required personal computer environment, refer to Required Personal Computer Environment.

The procedure is explained here using Windows screens (Internet Explorer). When using other browsers, some screen displays will be different, but the procedure is similar.

1. Start the web browser of the personal computer.

Use one of the web browsers below depending on the operating system installed in the personal computer.

Operating system	Web browser
Windows 10 64bit/32bit	Internet Explorer 11 Microsoft Edge Google Chrome
macOS 10.15 macOS 10.14 macOS 10.13 macOS 10.12 OS X 10.11	Safari Google Chrome

2. Enter the IP address you configured on the Easy IP Setup Software in the address bar of the web browser.

- IPv4 address entry example:
http://URL registered with IPv4 address
http://192.168.0.10/
- IPv6 address entry example:
http://[URL registered with IPv6 address]
http://[2001:db8::10]/

[Note]

- If the HTTP port number has been changed from “80”, enter “http://<camera IP address>:<port number>” in the address bar. Example: http://192.168.0.11:8080
- If the unit is located on the local network, configure proxy server settings on the web browser ([Setup] > [Network]) so that a proxy server is not used for the local address.

3. Display the live screen [Live].

The web screen appears. You can switch to the web setup screen [Setup] when necessary.



[Note]

- Depending on the firewall settings on your personal computer, transmitted images may not be displayed. If this occurs, change the firewall settings and change the settings to permit communications with your web browser.
- When an attempt is made to display multiple IP images on one personal computer, IP videos may not be displayed depending on the performance of the personal computer concerned.
- Images on the web screen are displayed in JPEG.
- The JPEG image frame rate may be slower depending on the network environment, performance of your personal computer, subject of the video, and access volume.

Switching between Live and Setup Screen

When the live screen is displayed, click the [Setup] button.

For details on the web setup screen, see "[Web Screen Configuration](#)" section.



When the web setup screen is displayed, click the [Live] button to switch to live screen.

For details on the live screen, see "[Web Live Screen Operation](#)" section.



[Note]





- During Standby mode, the [Setup] button is disabled, and you cannot switch to the [Setup] screen.
- If the unit is switched to Standby mode from another terminal while the [Setup] screen is displayed, the display will switch to the live screen after a few seconds.

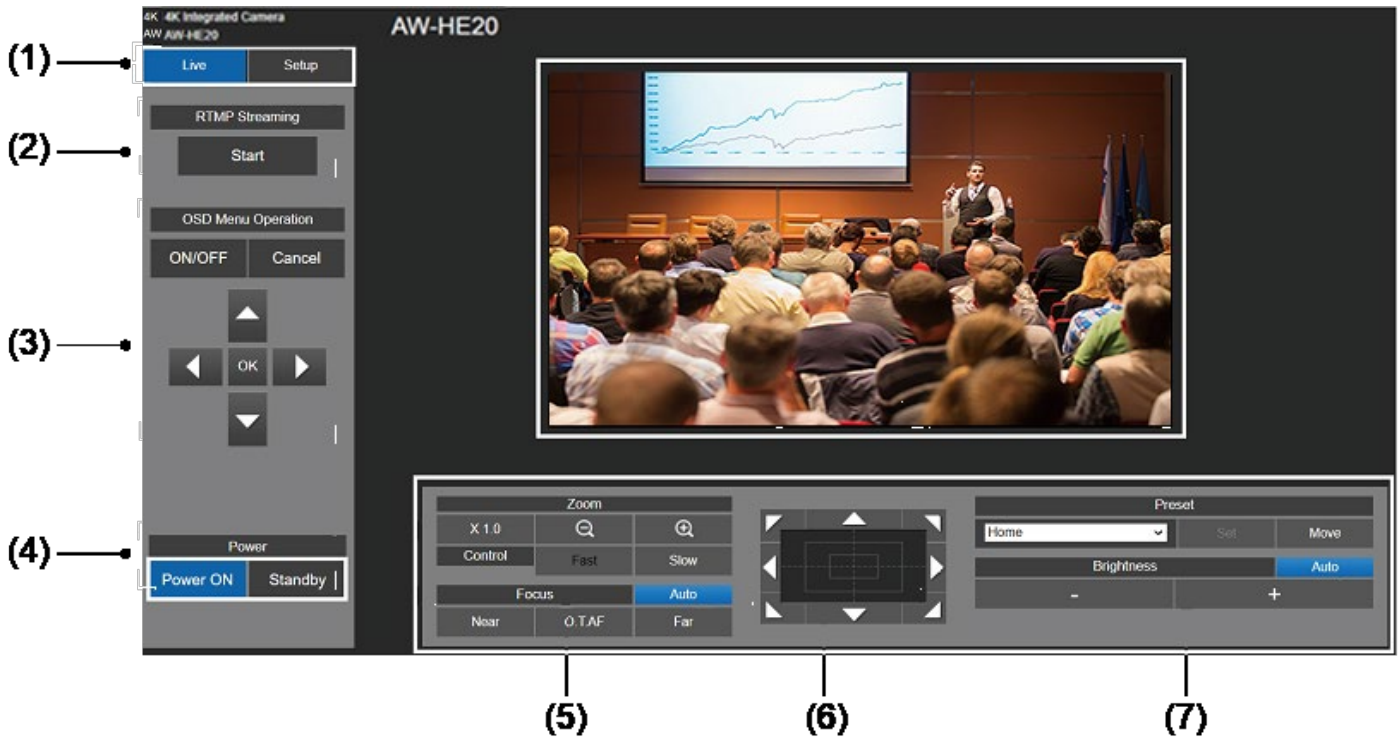

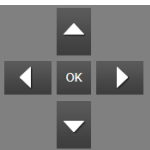
Web Live Screen Operation

You can display images from the camera on a personal computer and perform camera operations, such as pan, tilt, and zoom.

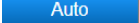
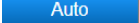
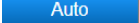
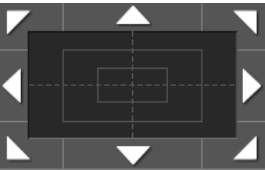

Name	Function
(1) Live/Setup	Click [Live] to switch to live screen. Click [Setup] to switch to setup screen.
(2) RTMP Streaming	Setup for uploading the camera's live view to the broadcasting platform. Click [Start] button to start uploading the live image to pre-registered broadcasting platform. When RTMP starting, the start button will turn into stop button. To stop, click [Stop] button To setup RTMP, please refer " RTMP setting " section.
(3) OSD Menu Operations	<p>ON / OFF : Use this to select whether the camera's on- screen displays are to be shown.</p> <p> : The items are selected using the [▲] [▼] [◀] [▶] buttons. If a selected item has a sub menu, this sub menu is displayed by pressing the [OK] button.</p> <p>Cancel : It cancels the selection of the setting which is being changed. It restores the pre-change setting.</p> <p>[Note] On-screens displays are not displayed on JPEG images on web screens.</p>

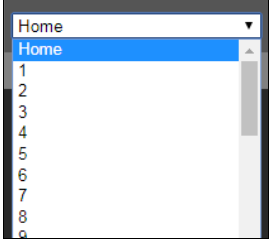
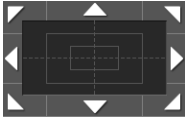
Name	Function					
(4) Power	<p>Power ON : Set the unit to Power ON mode.</p> <p>Standby : Set the unit to Standby mode.</p> <p>In the Standby mode, all the buttons on the live screen except for the [Power ON] button and [Standby] button are disabled.</p> <p>[Note] If [Power ON] or [Standby] is selected too quickly, the status selected and the display shown may not correspond. In a case like this, follow the steps below to restore the correct status display:</p> <p>For Windows: Press the [F5] key on the keyboard of the personal computer.</p> <p>For Mac: Press the [Command] + [R] keys on the keyboard of the personal computer.</p> <p>The pan/tilt position return to the place just before entering STANDBY mode when returning from STANDBY mode to POWER ON mode.</p> <p>If the power is turned off, the pan/tilt position returns to the initial state.</p>					
(5) Zoom and Focus	<p>x 1.0 : Use this to adjust the zoom (magnification) to 1.0x</p> <p> : Use this to adjust the zoom (magnification) in the “Tele” direction.</p> <p> : Use this to adjust the zoom (magnification) in the “Wide” direction.</p>					
	<p>Fast Slow : Select the speed at which zoom operations are to be performed.</p>					
	<table border="1"> <tr> <td data-bbox="486 1055 699 1193"> <p> (auto focus)</p> </td> <td data-bbox="715 1055 1469 1193"> <p>Click Auto to switch between auto and manual focus. Green Auto indicates that the focus is adjusted automatically. White Auto indicates that the focus is adjusted manually.</p> </td> </tr> </table>	<p> (auto focus)</p>	<p>Click Auto to switch between auto and manual focus. Green Auto indicates that the focus is adjusted automatically. White Auto indicates that the focus is adjusted manually.</p>			
	<p> (auto focus)</p>	<p>Click Auto to switch between auto and manual focus. Green Auto indicates that the focus is adjusted automatically. White Auto indicates that the focus is adjusted manually.</p>				
<table border="1"> <tr> <td data-bbox="486 1216 699 1335"> <p> (manual focus)</p> </td> <td data-bbox="715 1216 1469 1335"> <p>Near Near Use this to adjust the focus in the Near direction. It does not work during automatic adjustments.</p> </td> </tr> <tr> <td data-bbox="486 1335 699 1498"></td> <td data-bbox="715 1335 1469 1498"> <p>O.T.AF O.T.AF When this is pressed while the focus is being adjusted manually, the focus will be temporarily adjusted automatically. It does not work during automatic adjustments.</p> </td> </tr> <tr> <td data-bbox="486 1498 699 1626"></td> <td data-bbox="715 1498 1469 1626"> <p>Far Far Use this to adjust the focus in the Far direction. It does not work during automatic adjustments.</p> </td> </tr> </table>	<p> (manual focus)</p>	<p>Near Near Use this to adjust the focus in the Near direction. It does not work during automatic adjustments.</p>		<p>O.T.AF O.T.AF When this is pressed while the focus is being adjusted manually, the focus will be temporarily adjusted automatically. It does not work during automatic adjustments.</p>		<p>Far Far Use this to adjust the focus in the Far direction. It does not work during automatic adjustments.</p>
<p> (manual focus)</p>	<p>Near Near Use this to adjust the focus in the Near direction. It does not work during automatic adjustments.</p>					
	<p>O.T.AF O.T.AF When this is pressed while the focus is being adjusted manually, the focus will be temporarily adjusted automatically. It does not work during automatic adjustments.</p>					
	<p>Far Far Use this to adjust the focus in the Far direction. It does not work during automatic adjustments.</p>					
(6) 	<p>To adjust the image in the horizontal or vertical direction (panning or tilting), left-click the pad and the buttons.</p> <p>It is possible to operate with the central grid pattern in the dragged state, with the speed of the pan/tilt increasing as it approaches the outside of the pad.</p>					

Name	Function	
<p>(7) Preset and Brightness</p> <p>[Note] Brightness is only enabled when [Scene] is set to [Scene1] or [Scene2].</p>		<p>Select a preset number or home position from the drop-down list.</p> <p>Click [Move] to go to a previously-configured preset position.</p> <p>Using  to adjust the unit position and click [Set] to register the preset position.</p>
	<p> (Auto brightness)</p>	<p>Auto</p> <p>Use this to switch the brightness adjustment between auto and manual.</p> <p>Green Auto indicates that the brightness is adjusted automatically.</p> <p>White Auto indicates that the brightness is adjusted manually.</p>
	<p> (Manual brightness)</p>	<div data-bbox="778 792 1353 869" style="border: 1px solid black; padding: 2px;"> <p style="text-align: center;">Brightness Auto</p> <p style="text-align: center;">- +</p> </div> <p>-</p> <p>Use this to make the image darker.</p> <p>It does not work during automatic adjustments.</p> <div data-bbox="778 1010 1353 1086" style="border: 1px solid black; padding: 2px;"> <p style="text-align: center;">Brightness Auto</p> <p style="text-align: center;">- +</p> </div> <p>+</p> <p>Use this to make the image lighter.</p> <p>It does not work during automatic adjustments.</p>

If you click on a part of the area where the live screen image is displayed, pan / tilt will operate so that the clicked position is in the center.

Web Screen Configuration

Select the Setup Screen

In live screen, click the [Setup] button to switch to setup screen.

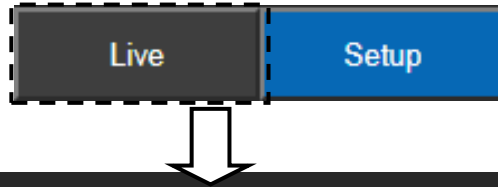

The screenshot shows the web interface for the AW-HE20 camera. At the top left, it says '4K Integrated Camera AW-HE20'. Below this, there are two tabs: 'Live' and 'Setup', with 'Setup' being the active tab. On the left side, there is a 'Setup menu' with several options: 'Basic', 'Image/Audio', 'User mng.', 'Network', and 'Maintenance'. The 'Basic' option is highlighted with a dashed border. Below the menu, there is a 'Power' section with 'Power ON' and 'Standby' buttons. The main content area is titled 'Priority mode' and contains a dropdown menu set to 'HDMI/USB', a 'Set' button, and a note: 'When changed, OSD display and IP streaming may not work.' A dashed box highlights the 'Priority mode' section, and a label 'Functions settings area' points to it. Another label 'Setup menu' points to the left-hand menu. A third label 'Power ON/Standby mode switching' points to the 'Power' section.

Basic Settings

From the Setup menu click [Basic] button to display the Basic settings page.
In basic settings, user can select [Priority mode] and setup name of [Live page], and access [Date & Time].

Selecting Priority Mode

Configure the setting for the priority output of video.

Click [Setup] > [Basic] > [Priority Mode]

Click [Set] to save the configuration.

- **HDMI/USB:** HD format video is output to an external monitor connected via an HDMI/SDI cable. Enables the unit to be used as a Web camera. The camera can also be controlled from a personal computer.
- **IP:** HD format video is output to an external monitor connected via an HDMI/SDI cable. Enables IP image transmission. The IP transmission of H.264/H.265 images is also supported. This unit cannot display H.264/H.265 format images on the Live screen. To display H.264/H.265 images, use an external device or external software that supports H.264/H.265 images.
- **USB (Video Conference):** Enables the unit to be used as a Web camera. Specially tuned for online meetings, the unit automatically goes into the Standby mode when an online meeting comes to an end; if an online meeting starts while the unit is in the Standby on mode, the unit automatically switches into the Power On mode. In this mode, you cannot output video via HDMI or SDI, and you cannot output video via IP transmission. (Video output will not be possible except via USB). Also, in this mode, the audio output is forcibly turned off.

[Note]

- When "Priority Mode" is changed, OSD display and IP streaming may not work, as the unit may reconnect to the RTMP server.
- Under the **USB (Video Conference)** mode, in order to minimize the delay of UVC output, HDMI/SDI video output and video output via IP transmission will be disabled.

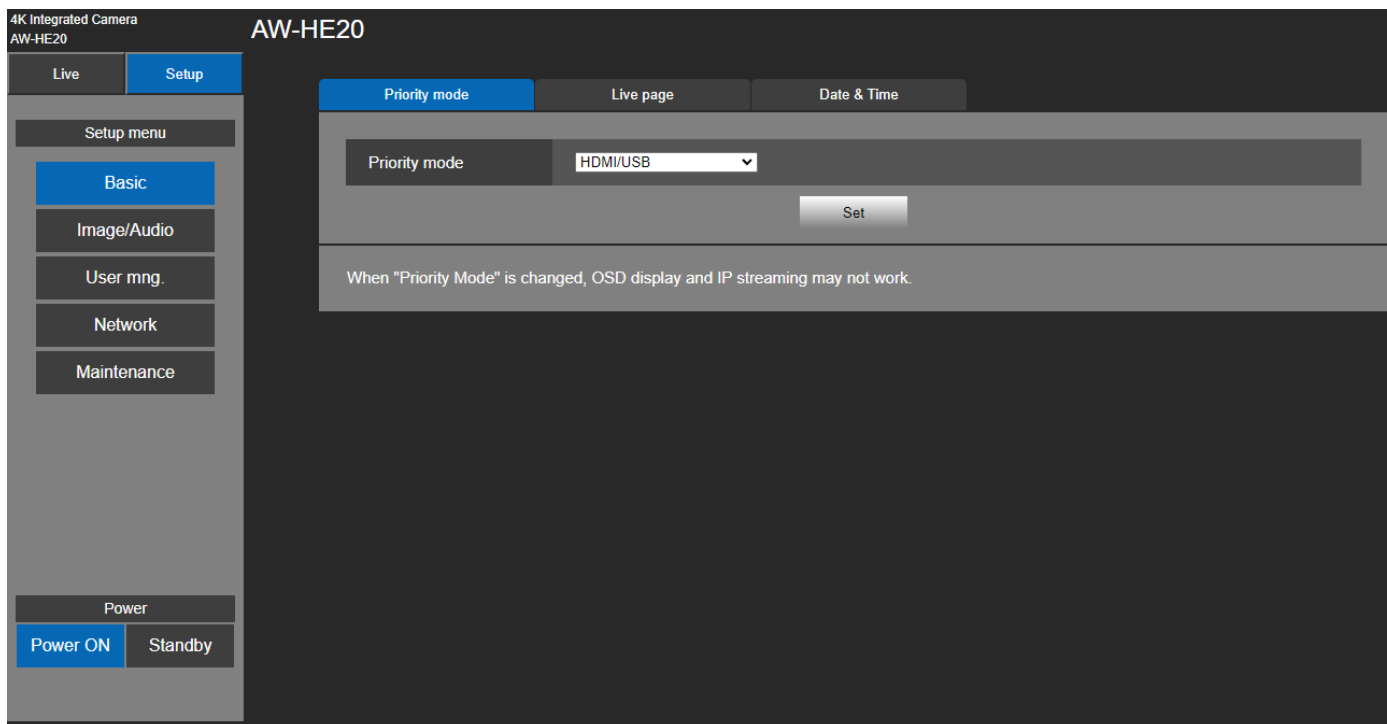

Live Page (Camera Title)

Input the name of the camera here.

Click [Setup] > [Basic] > [Live Page]

When the [Set] button is clicked, the input name appears in the camera title display area.

[Note]

- The factory default setting is the model number of the unit.
- You can enter between 0 to 20 characters.
- The following characters can be displayed.

Numeric characters	0123456789
Alphabetical characters (upper and lower cases)	ABCDEFGHIJKLMNOPQRSTUVWXYZ VWXYZ abcdefghijklmnopqrstuvwxyz
Symbols	#%+=, - _ ^ / @ :

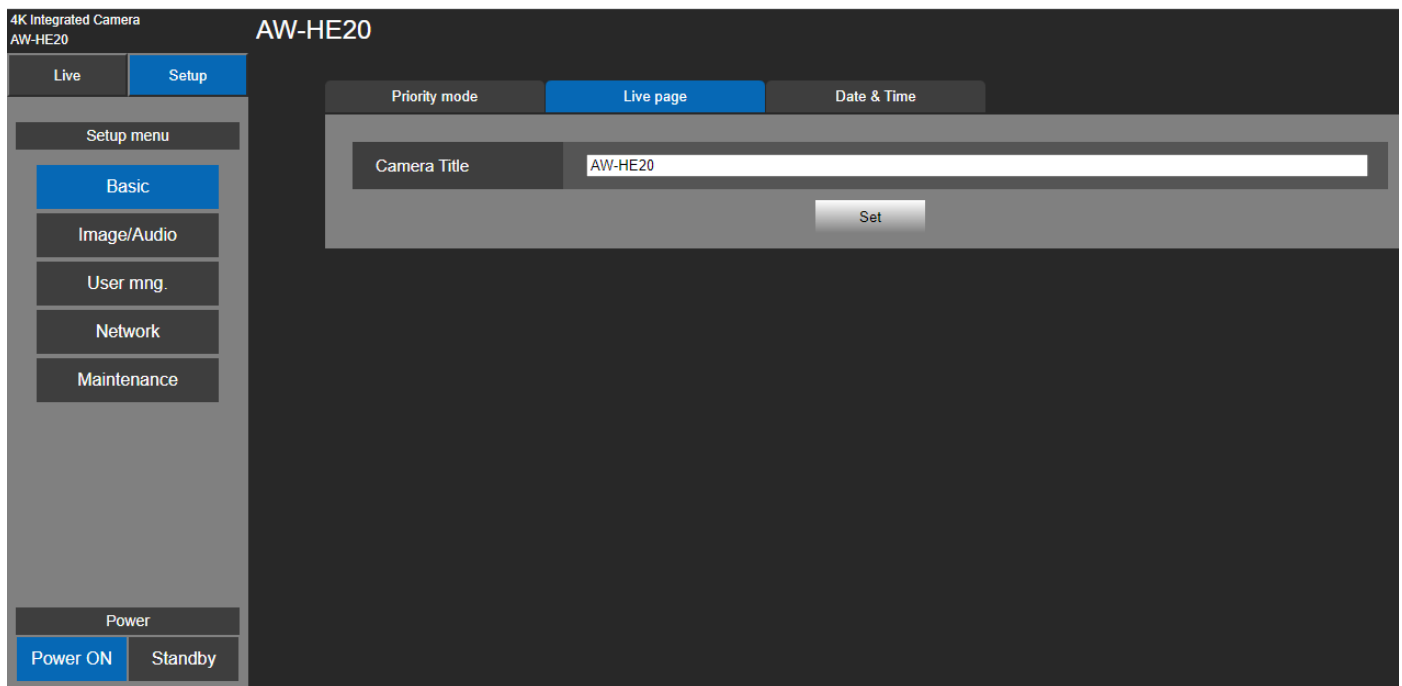

Date & Time

Click [Setup] > [Basic] > [Date & Time]

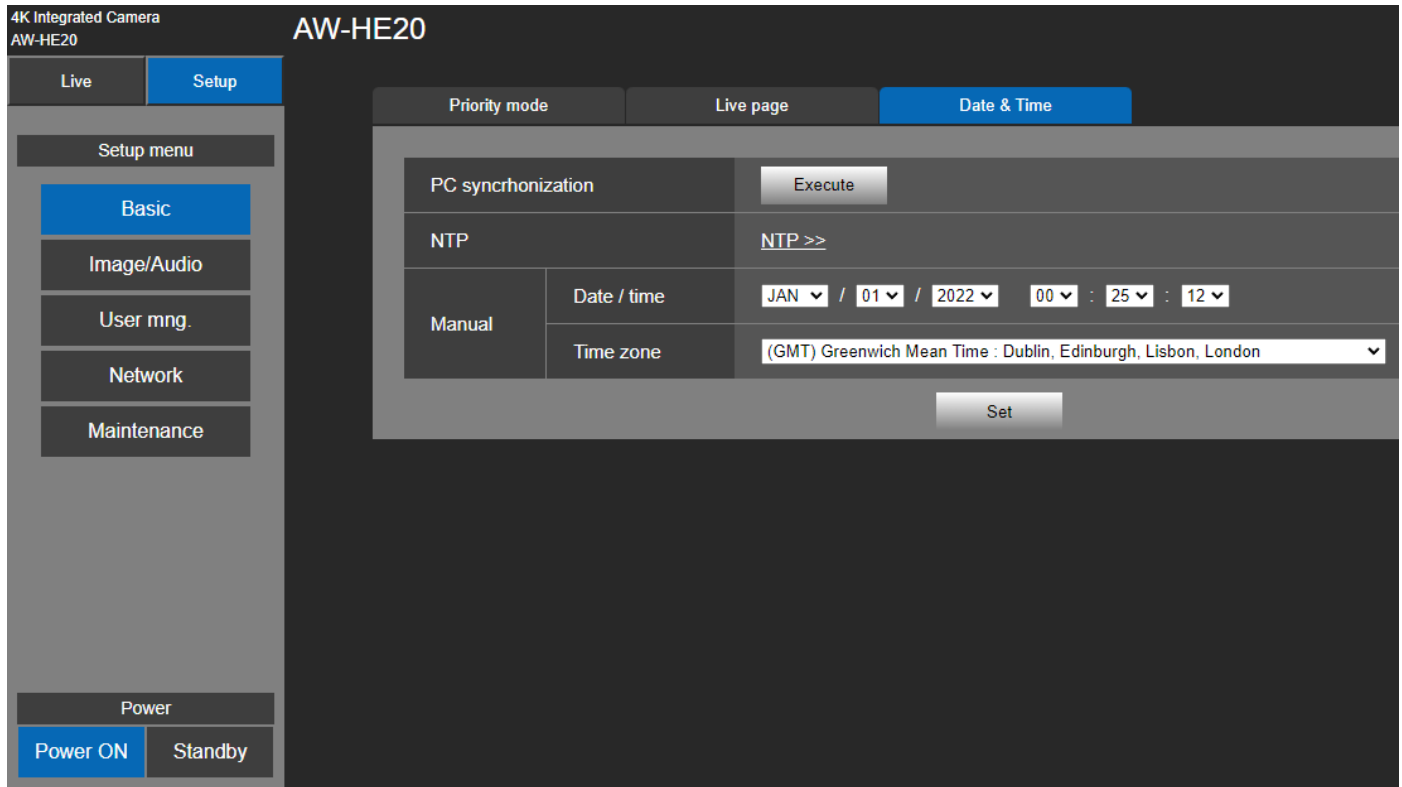

■ PC Synchronization

If you click the [Execute] button, the settings are configured by synchronizing the unit to the date and time of the connected personal computer.

[Note]

The time zone of the personal computer is not reflected on the unit. Set the time zone on the unit.

■ NTP

If you click [NTP>>], the settings screen for the NTP server appears.(→ page 104)

■ Manual - Date/time

Configure the settings for the month, day, and year and for the hour, minute, and second.

[Note]

- The data display format is MM/DD/YYYY.
- The time is in the 24-hour format.

■ Manual - Time zone

Selects the time zone according to the region where the camera is being used.

Factory settings:

(GMT) Greenwich Mean Time: Dublin, Edinburgh, Lisbon, London

Image/Audio Settings

Video over IP

Click [Setup] > [Image/Audio] > [Video over IP]

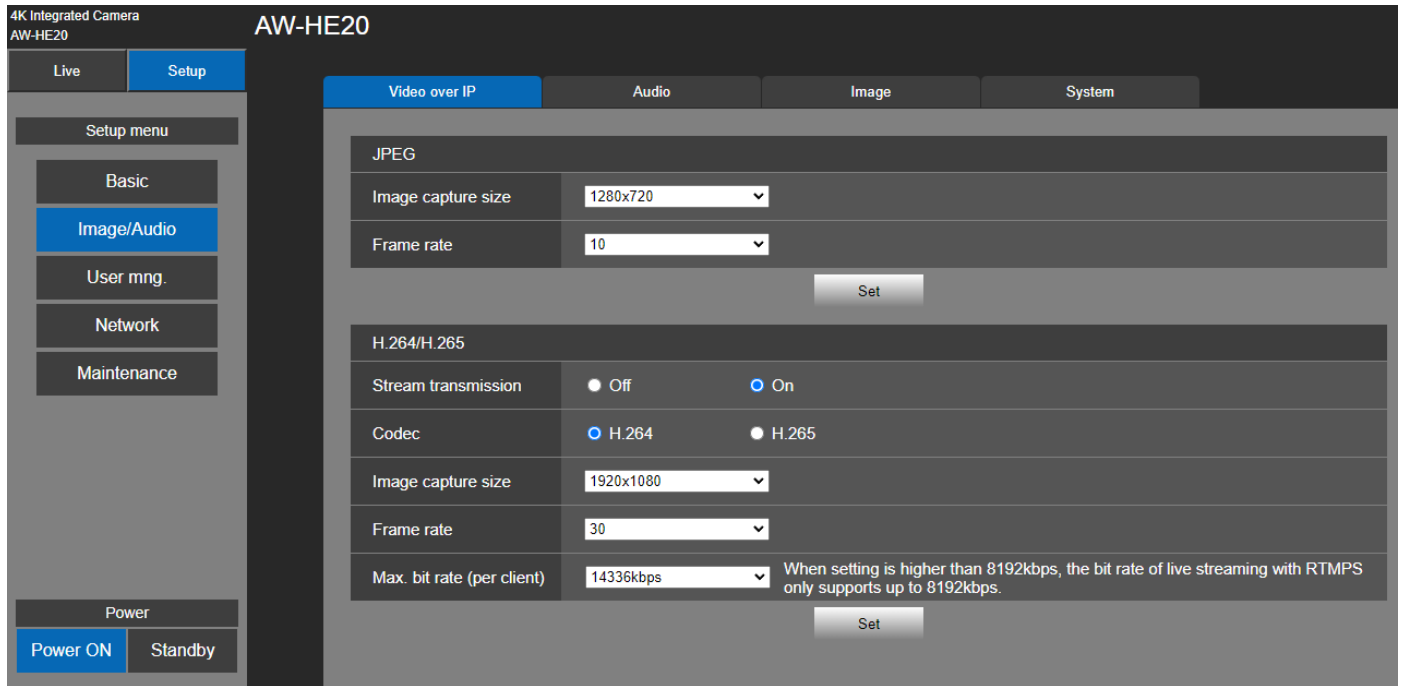

The JPEG image and H.264/H.265 image settings as well as the settings related to image quality are selected in here. Click [Setup] > [Image/Audio] > [Video over IP]

[Note]

- IP control can be performed but if you do not want to perform IP image transmission, set [H.264/H.265 transmission] to [Off].
- Images and audio are not synchronized. Therefore, images and audio may be slightly out of sync.
- Please do not change the following menu items during IP streaming: Priority mode, Frequency, Format, Install Position, Mirror, and Audio.

■ JPEG

Set JPEG image settings.

Click [Set] to save the configuration.

Image capture size

[1280×720, 640×360]

Select the resolution for JPEG images.

Frame rate

[10, 30]

Set the frame rate for JPEG images.

[Note]

When the resolution for **Image capture size** is **1280×720**, the **frame rate** will be **10 fps**.

■ H.264/H.265

Set H.264/H.265 image settings.

Click [Set] to save the configuration.

[Note]

1. This is only enabled when Priority Mode is set to "IP".
2. Only JPEG images can be displayed on web screens.

Stream transmission

[Off, On]

Whether to transmit images is set here. The default is On.

[Note]

[Stream transmission] cannot be configured when the Priority Mode selection is anything other than "IP".

Codec

[H.264, H.265]

Select the H.264 or H.265 as the image codec.

Image capture size

[640x360, 1280x720, 1920x1080]

Select the resolution for H.264/H.265 images.

Frame rate

[5fps, 10fps, 15fps, 25fps, 30fps, 50fps, 60fps]

Set the frame rate for H.264 /H.265 images.

50Hz	5fps, 10fps, 25fps, 50fps
59.94Hz/60Hz	5fps, 15fps, 30fps, 60fps

Max bit rate (per client)

[1024kbps, 1536kbps, 2048kbps, 3072kbps, 4096kbps, 6144kbps, 8192kbps, 10240kbps, 12288kbps, 14336kbps, 16384kbps, 20480kbps, 24576kbps, 32768kbps]

Specify the H.264/H.265 bit rate

The default is 14336kbps.

[Note] When bit rate is set higher than 8192kbps, the bit rate during RTMPS transmission will be 8192kbps.

Audio

Click [Setup] > [Image/Audio] > [Audio]

Click [Set] to enable the configuration.

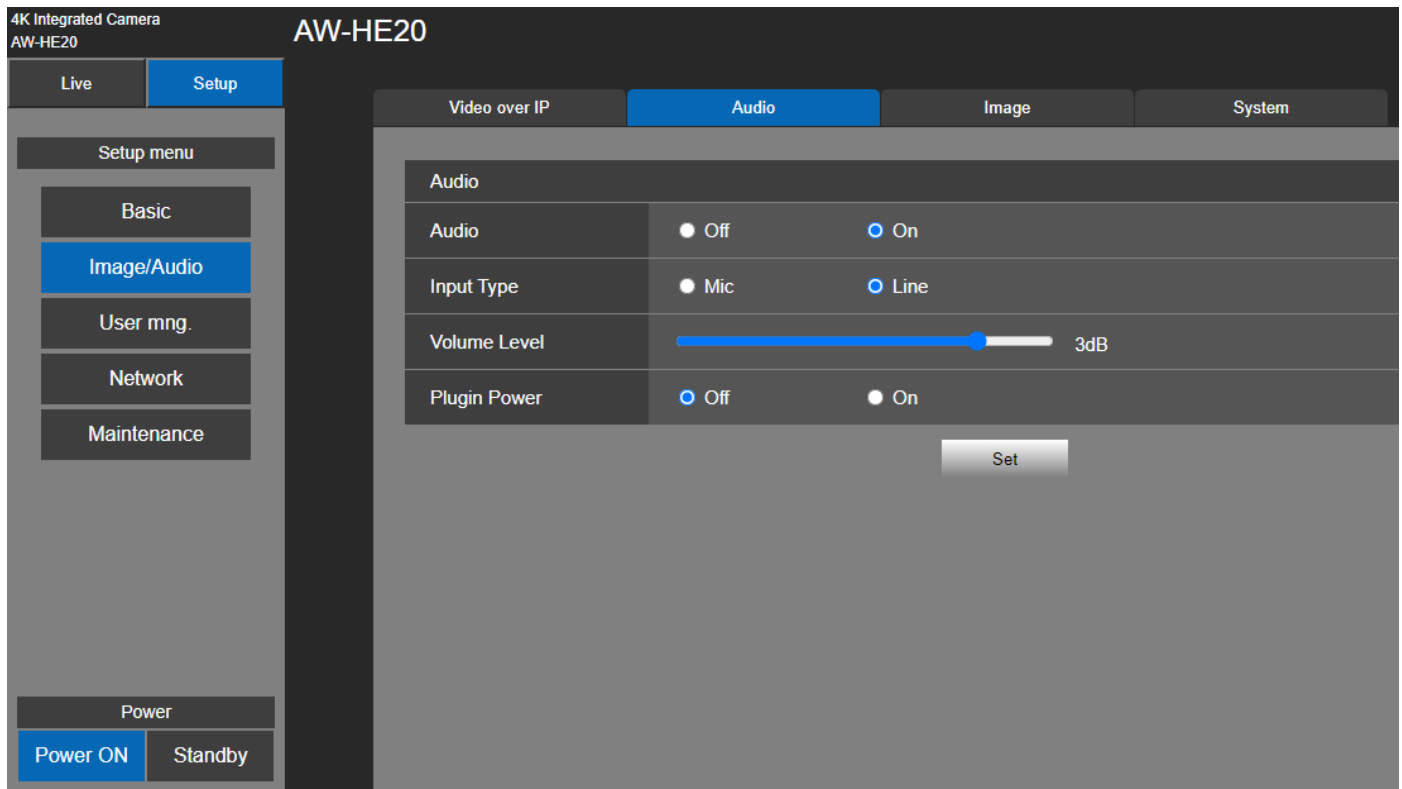

■ Audio

Audio

[Off, On]

Select On or Off to enable or disable audio.

[Note]

1. If you switch audio **On** or **Off** during IP streaming, audio skipping might occur.
2. When Audio is On, RTMP transmission may not start. (Such an occasion arises when the server to which RTMP transmission is delivered requires audio transmission)
3. If you change Audio from **On** to **Off** during RTMP transmission, RTMP transmission may stop.

Input Type

[Mic, Line]

Mic	Set the microphone input.
Line	Set the line input.

Volume Level

[-36 dB to +12 dB]

Set the volume level of audio output.

This is only enabled when [Audio] is set to [On].

Plugin Power

[Off, On]

Turn the plugin power for the audio off/on.

This is only enabled when [Audio] is set to [On].

Image

Image adjustment and preset position setup.

Click [Setup] > [Image/Audio] > [Image]

The screenshot displays the control interface for the AW-HE20 camera. At the top left, it identifies the device as a "4K Integrated Camera AW-HE20". The main interface is divided into several sections:

- Top Bar:** Contains "Live" and "Setup" tabs. Below this are sub-tabs for "Video over IP", "Audio", "Image" (which is currently selected), and "System".
- Left Panel:** A vertical menu with "Setup menu" at the top, followed by "Basic", "Image/Audio" (highlighted in blue), "User mng.", "Network", and "Maintenance". At the bottom of this panel are "Power" controls: "Power ON" (highlighted in blue) and "Standby".
- Central View:** A large video window showing a live feed of a conference room. A presenter is visible at the front, and an audience is seated in the foreground. A large screen at the front of the room displays a line graph.
- Bottom Panel:** Two rows of controls. The first row has "Image adjust" on the left and a "Setup" button on the right. The second row has "Preset position" on the left and a "Setup" button on the right.

■ Image Adjust

Click [Setup] button to call out image adjust dialog.

Click [Close] button to exit from image adjust dialog.

The image mode has three types – Full Auto, Scene1, and Scene2.

The dialogue screen may vary depending on which scene mode you select out of the three (Full Auto, Scene1, and Scene2).

[Note]

Setting data are reflected immediately as soon as they are changed.

Scene: Full Auto	Scene: Scene1/Scene2

Picture Level

[-4~4]

Adjust the picture quality. Move the scroll bar to adjust the value.

Factory settings: 0

Iris Mode

[Auto, Manual]

This menu item is used to select whether the iris is to be adjusted automatically or manually.

Manual	The iris is adjusted manually.
Auto	Auto exposure compensation is performed so that the target level which was set using [Picture Level] is reached.

Factory settings: Auto

Shutter mode

[Off, Step, Synchro]

Off	The shutter is set to OFF.
Step	The step shutter is set (the steps can be changed).
Synchro	The synchro shutter is set (the setting can be changed continuously).

Step/Synchro

This is used to adjust the shutter speed in the mode which was selected as the [Shutter Mode] setting.

When a higher shutter speed is selected, fast-moving subjects do not become blurred easily but the images will be darker.

The shutter speeds that can be set are listed below.

- When "Step" is selected as the "Shutter Mode"

[50Hz]	[59.94Hz/60Hz]
1/1, 1/2, 1/3, 1/6, 1/12, 1/25, 1/50, 1/100, 1/250, 1/500, 1/1000, 1/2000, 1/4000, 1/8000, 1/16000	1/1, 1/2, 1/3, 1/7, 1/15, 1/30, 1/60, 1/120, 1/240, 1/480, 1/1000, 1/2000, 1/4000, 1/8000, 1/16000

- When "Synchro" is selected as the "Shutter Mode"

[59.94p/29.97p]	[50p/25p]
60.0Hz~660.0Hz	50.0Hz~570.1Hz

Factory settings: Off

Slow Shutter

[Off, On]

Set slow shutter function to “Off” or “On”.

■ When Slow Shutter is set to On

[50 Hz]

1/1, 1/2, 1/3, 1/6, 1/12, 1/25, 1/50, 1/100, 1/250, 1/500, 1/1000, 1/2000, 1/4000, 1/8000, 1/16000

[59.94 Hz/60 Hz]

1/1, 1/2, 1/3, 1/7, 1/15, 1/30, 1/60, 1/120, 1/240, 1/480, 1/1000, 1/2000, 1/4000, 1/8000, 1/16000

■ When Slow Shutter is set to Off

[50 Hz]

1/50, 1/100, 1/250, 1/500, 1/1000, 1/2000, 1/4000, 1/8000, 1/16000

[59.94 Hz/60 Hz]

1/60, 1/120, 1/240, 1/480, 1/1000, 1/2000, 1/4000, 1/8000, 1/16000

Factory settings: Off

This can only be configured when “Scene” is set to “Full Auto.”

Gain

[Auto, 0 dB, 3 dB, 6 dB, 12 dB, 15 dB, 18 dB, 21 dB, 24 dB, 27 dB, 30 dB, 33 dB, 36 dB, 39 dB, 42 dB]

In locations which are too dark, adjust the gain upward; conversely, in locations which are too bright, adjust it downward. When “Full Auto” mode is set, the light quantity is adjusted automatically.

The noise increases when the gain is increased.

Factory settings: 0

AGC Max Gain

[24 dB, 30 dB, 36 dB, 42 dB]

Set up the maximum gain-up amount value.

Factory settings: 24 dB

Frame Mix

[Auto, Off, 6 dB, 12 dB, 18 dB, 24 dB]

Select for frame addition (gain-up using sensor storage) amount. When frame addition is performed, it will appear as if the images are missing some frames.

Factory settings: Off

[Note] Under discharge tube illumination, such as fluorescent and mercury-vapor lights, the brightness may change cyclically, colors may change, and horizontal stripes may flow up and down the image.

Auto F.Mix Max Gain

[0 dB, 6 dB, 12 dB, 18 dB]

Sets the maximum amount of frames that can be added when [Frame Mix] is running in [Auto] mode.

When frame addition is performed in [Auto] mode, it will appear as if the images are missing some frames.

Factory settings: 0

Chroma Level

[0, 1, 2, 3, 4, 5, 6, 7, 8, 9, 10]

Set the color intensity (Chroma level) of the images. Move the scroll bar to adjust the value.

Factory settings: 5

White Balance Mode

[ATW, AWB A, AWB B, 3200K, 5600K]

Select the mode when the coloring is not natural because of the nature of the light source or other factors. If the white color serving as the reference can be recognized, subjects can be shot with natural coloring.

Click [Execute] button to apply the setting.

Factory settings: ATW.

- **ATW**: This mode automatically corrects the white balance, even if the light source or color temperature changes.
- **AWB A, AWB B** : When AWB A or AWB B is selected and the white balance is executed, the adjustment results obtained are stored in the memory selected.
When AWB A or AWB B is then selected, the white balance stored in the selected memory can be recalled.
- **3200K**: This white balance mode is ideal when a 3200K halogen light is used as the light source.
- **5600K**: This white balance mode is ideal when 5600K sunlight or fluorescent lighting is used as the light source.

Pedestal

[-10 ~ +10]

This item is used to adjust the black level (adjust the pedestal). These parts become darker when a negative setting is selected and, conversely, lighter when a positive setting is selected.

Factory settings: 0

Detail

[0, 1, 2, 3]

Adjust the sharpness of the image. Move the scroll bar to adjust the value.

Factory settings: 2

Contrast

[0, 1, 2, 3, 4]

Adjust the Contrast level.

Factory settings: 2

DRS

[Off, Low, High]

Set here is the DRS function which provides just the right amount of compensation when images with significant light/dark differences are displayed.

Depending on the shooting conditions, however, the picture quality may drop with increased noise.

Factory settings: Off

Back Light COMP

[Off, On]

Set backlight compensation function to "On" or "Off".

Under backlight conditions, the function prevents darkening as a result of light striking the backs of subjects, and makes it possible to shoot images in shade or shadow more brightly.

Factory settings: Off

DNR

[Off, Low, High]

Set the level of the digital noise reduction effect so that light, noise-free and clear images will be output even at night and in other low-brightness environments.

When "Low" or "High" is selected, noise can be eliminated. However, there is an increased possibility that afterimages may occur.



Factory settings: Low

■ **Preset Position**

Click [Setup] button to call out preset position dialog.

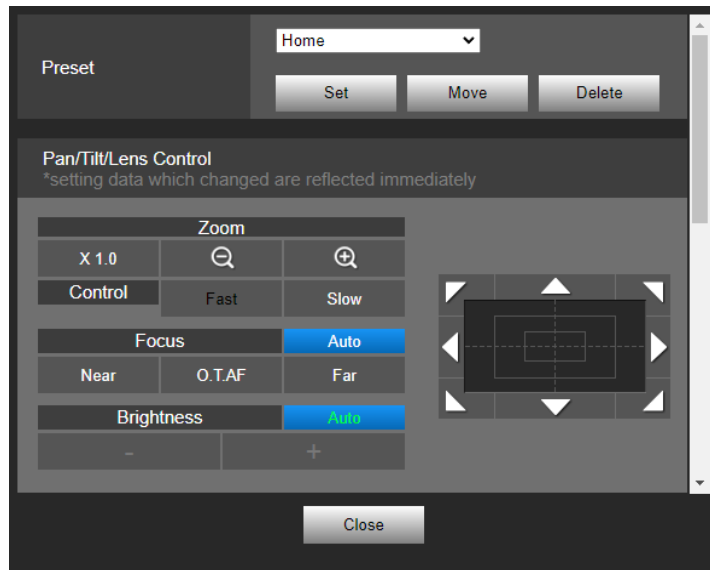
Click [Close] button to exit from image adjust dialog.

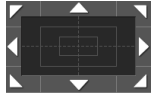

	<p>Select the preset number or home position from drop-down list. Click [Move] to go to the pre-set position.</p> <p>Using  to adjust the unit position and click [Set] to register the preset position.</p>
	<p>To adjust the image in the horizontal or vertical direction (panning or tilting), left-click the pad and the buttons. It is possible to operate with the central grid pattern in the dragged state, with the speed of the pan/tilt increasing as it approaches the outside of the pad.</p>
	<p>X 1.0 : Use this to adjust the zoom (magnification) to 1.0x  : Use this to adjust the zoom (magnification) in the “Tele” direction.  : Use this to adjust the zoom (magnification) in the “Wide” direction.</p>
	<p>Select the speed at which zoom operations are to be performed.</p>
	<p>Click Auto to switch between auto and manual focus. Green Auto indicates that the focus is adjusted automatically. White Auto indicates that the focus is adjusted manually.</p> <p>Click Near to adjust the focus in the Near direction. It does not work during automatic adjustments.</p> <p>Click O.T.A.F while the focus is being adjusted manually, the focus will be temporarily adjusted automatically. It does not work during automatic adjustments.</p> <p>Click Far to adjust the focus in the Far direction. It does not work during automatic adjustments.</p>
	<p>Click Auto to switch between auto and manual adjustment of the brightness. Green Auto indicates that the brightness will be adjusted automatically. White Auto indicates that the brightness can be adjusted manually. This is only enabled only when [Scene1] or [Scene2] has been selected as the [Priority Mode] setting.</p>

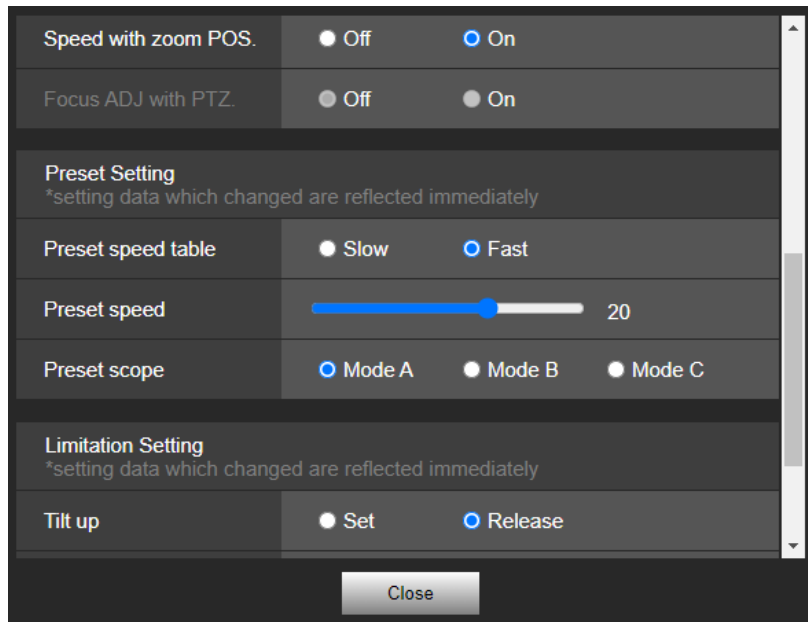

Speed with zoom POS.

[Off, On]

When [On] is set, if you adjust the zoom in the “Tele” direction, the panning and tilting operations will become slower than usual.

This function has no effect during preset operations.

Factory settings: On

Focus ADJ with PTZ.

[Off, On]

“Off” or “On” is set here for the function which compensates for out-of-focusing when it occurs during panning, tilting or zooming operations at the manual focus setting.

This item can be selected only when “Manual” has been selected as the “Focus Mode” setting.

This is only enabled when manual focus has been selected.

Factory settings: Off

■ **Preset Setting**

Preset speed table

[Slow, Fast]

Set the preset speed table (Slow, Fast).

During preset playback, preset actions are performed at Preset Speed (1 to 30) values that are based on the table set here.

Slow: Set the preset speed table to “Slow”.

Fast: Set the preset speed table to “Fast”.

Factory settings: Fast

Preset speed

[1~30]

There are 30 preset pan-tilt operation speeds when regenerating the camera direction and other information which are registered in the preset memory.

Setting range: 1 to 30

[Note]

If a high value is selected for the Preset Speed setting, the image on the screen may shake when operation stops.

Factory settings: 20

Preset scope

[Mode A, Mode B, Mode C]

Selected here are the setting items to be recalled when the contents of the preset memory are regenerated.

Mode A	Pan, Tilt, Zoom (including digital zoom), Focus, Iris, Gain, white balance adjustment value
Mode B	Pan, Tilt, Zoom (including digital zoom), Focus, Iris
Mode C	Pan, Tilt, Zoom (including digital zoom), Focus

[Note]

When registering a preset position, all values are saved.

When recalling a registered preset position, there are certain operation procedures to undergo beforehand so that each value can come into effect:

[Focus]

Firstly, enable manual focus. Then, the focus value of the recalled preset position can come into effect.

[Iris]

Firstly, enable manual iris. Then, the iris value of the recalled preset position can come into effect.

[Gain]

Firstly, set Gain between 0 dB~42 dB. Then, the Gain value of the recalled preset position can come into effect.

[White Balance Mode]

Firstly, set White Balance Mode as AWB A or AWB B. Then, the White Balance Mode value of the recalled preset position can come into effect.

Factory settings: Mode A

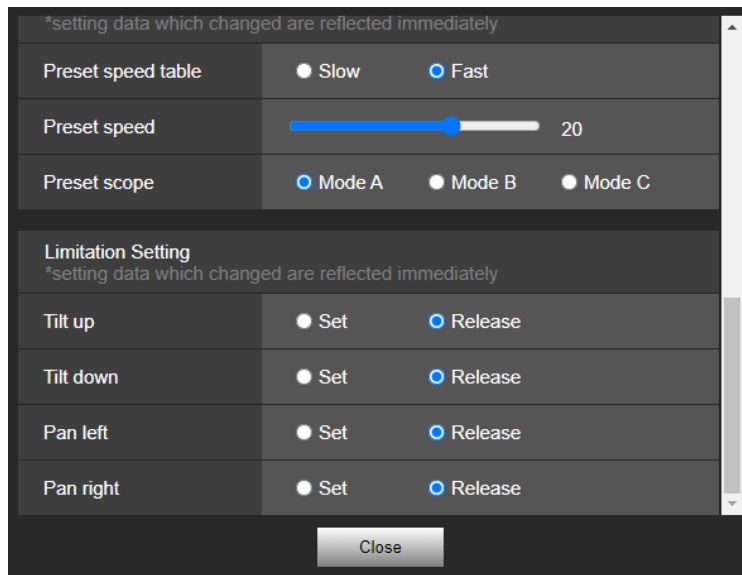

■ Limitation Setting

This establishes the up, down, left and right limit settings of the pan-tilt head.

First, move the pan-tilt head to the desired limit position using the control pad and its buttons.

When the position is determined, select the desired “Set” setting from the list of settings below to set the position.

(Select “Release” to release the setting.)

Tilt Up	Use this to save the current position as the upward limit.
Tilt Down	Use this to save the current position as the downward limit.
Pan Left	Use this to save the current position as the leftward limit.
Pan Right	Use this to save the current position as the rightward limit.

When “Set” or “Release” is selected, the tally lamp of the unit blinks.

When a limiter is set, it blinks red once; when a limiter is released, it blinks red twice.

System Settings

Click [Setup] > [Image/Audio] > [System]

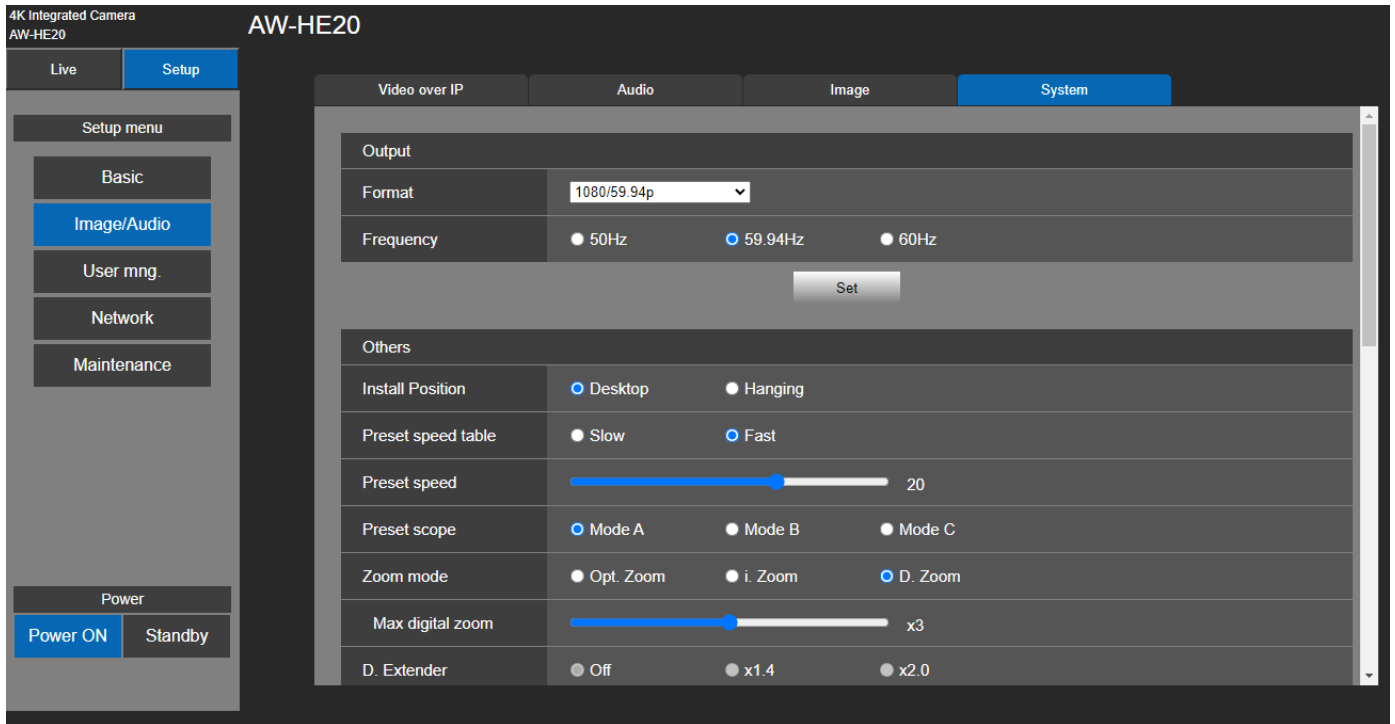

■ Output

Click [Set] button to save the configuration.

Format

Change the image format. The image format can different by the frequency.

Frequency	50Hz	59.94Hz	60Hz
Format HDMI	1080/50p 1080/25p 720/50p 1080/50i	1080/59.94p 1080/29.97p 720/59.94p 1080/59.94i	1080/60p 1080/30p 720/60p 1080/60i
Format SDI	1080/50p, 1080/25p, 720/50p 1080/50i	1080/59.94p, 1080/29.97p, 720/59.94p 1080/59.94i	1080/60p, 1080/30p, 720/60p 1080/60i

Factory settings:

[50Hz] 1080/50p

[59.94Hz] 1080/59.94p

[60Hz] 1080/60p

Frequency

Set the frame frequency – 50Hz, 59.94Hz, or 60Hz.

When the frequency is switched, “Format” is set as following:

Frequency	50Hz	59.94Hz	60Hz
Format HDMI	1080/50p	1080/59.94p	1080/60p
	1080/25p	1080/29.97p	1080/30p
	720/50p	720/59.94p	720/60p
	1080/50i	1080/59.94i	1080/60i
Format SDI	1080/50p,	1080/59.94p,	1080/60p,
	1080/25p,	1080/29.97p,	1080/30p,
	720/50p	720/59.94p	720/60p
	1080/50i	1080/59.94i	1080/60i

Factory settings: 59.94Hz

■ Others

Click [Set] button to save the configuration

Install Position

[Desktop, Hanging]

“Desktop” or “Hanging” is selected here as the method used to install the unit.

When “Hanging” has been selected, the top, bottom, left and right of the images will be reversed and up/down/left/right control for panning and tilting will also be reversed.

Factory settings: Desktop

Preset speed table

[Slow, Fast]

Set the preset speed table (Slow, Fast).

During preset playback, preset actions are performed at Preset Speed (1 to 30) values that are based on the table set here.

Slow: Set the preset speed table to “Slow”.

Fast: Set the preset speed table to “Fast”.

Factory settings: Fast

Preset speed

[1~30]

There are 30 preset pan-tilt operation speeds when regenerating the camera direction and other information which are registered in the preset memory.

[Note]

If a high value is selected for the Preset Speed setting, the image on the screen may shake when operation stops.

Factory settings: 20

Preset scope

[Mode A, Mode B, Mode C]

Selected here are the setting items to be recalled when the contents of the preset memory are regenerated.

Mode A	Pan, Tilt, Zoom (including digital zoom), Focus, Iris, Gain, white balance adjustment value
Mode B	Pan, Tilt, Zoom (including digital zoom), Focus, Iris
Mode C	Pan, Tilt, Zoom (including digital zoom), Focus

[Note]

- When registering a preset position, all values are saved.
- When recalling a registered preset position, there are certain operation procedures to undergo beforehand so that each value can come into effect:

[Focus]

Firstly, enable manual focus. Then, the focus value of the recalled preset position can come into effect.

[Iris]

Firstly, enable manual iris. Then, the iris value of the recalled preset position can come into effect.

[Gain]

Firstly, set Gain between 0 dB~42 dB. Then, the Gain value of the recalled preset position can come into effect.

[White Balance Mode]

Firstly, set White Balance Mode as AWB A or AWB B. Then, the White Balance Mode value of the recalled preset position can come into effect.

Factory settings: Mode A

Zoom Mode

[Opt.Zoom, i.Zoom, D.Zoom]

Configure the maximum zoom magnification.

Opt.Zoom	Use only the optical zoom. Up to 12× optical zoom is possible.
i.Zoom	Enabling this function allows you to perform electronic zoom while reducing drops in picture quality. Combining optical zoom and electronic zoom, up to 15.96× zoom is possible.
D.Zoom	Enable the digital zoom function. Picture quality degrades as zoom increases with digital zoom.

Factory settings: Opt.Zoom

Max Digital Zoom

[×2, ×3, ×4]

Set the maximum digital zoom magnification. This is only enabled when [Zoom Mode] is set to [D.Zoom].

[Note]

Higher digital zoom magnifications will result in coarser images.

Factory settings: ×4

Digital Extender

[Off, ×1.4, ×2.0]

Make settings for the digital extender function.

Off	Turn the digital extender function off.
×1.4	The digital zoom will be fixed at 1.4×.
×2.0	The digital zoom will be fixed at 2.0×.

This is only enabled when [Zoom Mode] is set to [Opt.Zoom].

Factory settings: Off

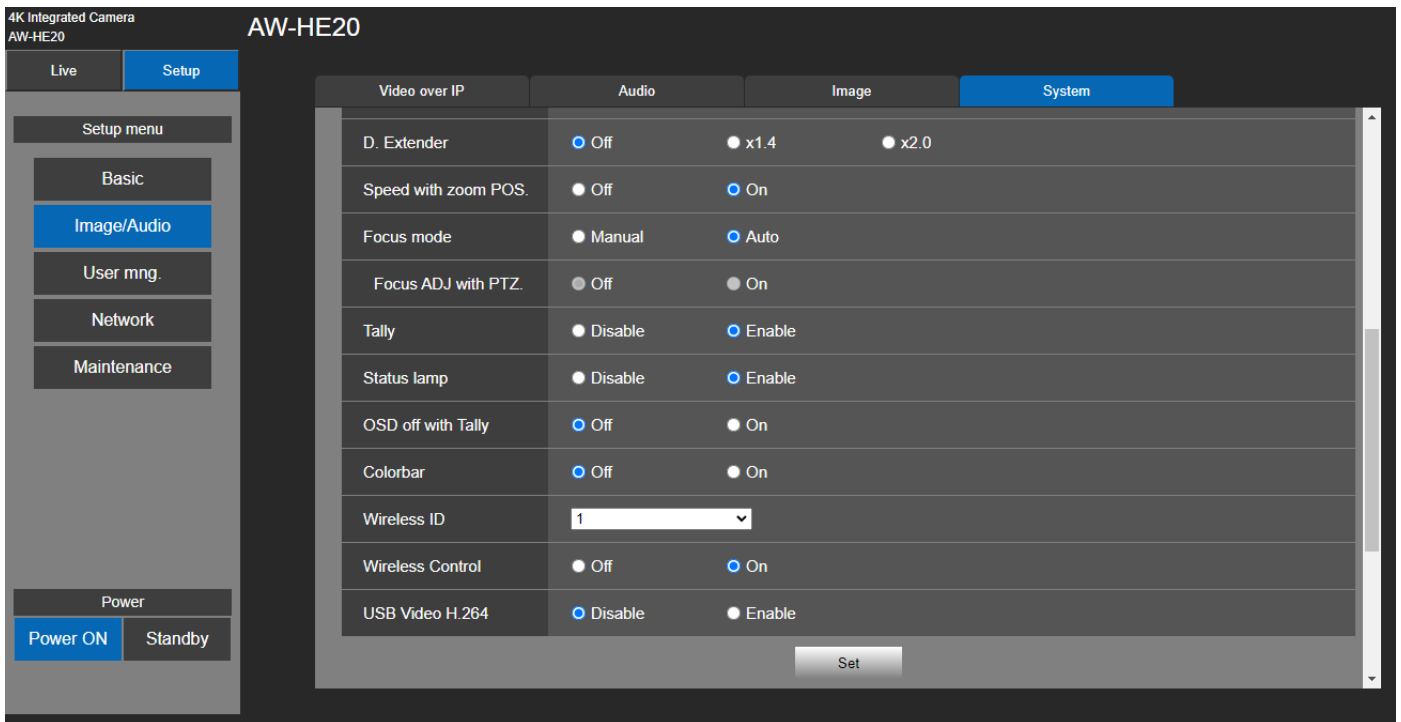

Speed with zoom POS.

[Off, On]

When [On] is set, if you adjust the zoom in the “Tele” direction, the panning and tilting operations will become slower than usual.

Factory settings: On

Focus mode

[Manual, Auto]

“Auto” or “Manual” is set here for the focusing function. Setting value:

Auto	The subjects are always brought into focus automatically.
Manual	The focus is operated manually.

Factory settings: Auto

Focus ADJ with PTZ

[Off, On]

“Off” or “On” is set here for the function which compensates for out-of-focusing when it occurs during panning, tilting or zooming operations at the manual focus setting.

This item can be selected only when “Manual” has been selected as the “Focus Mode” setting.

Factory settings: Off

Tally

[Enable, Disable]

“Enable” or “Disable” is set here for the function which turns on or turns off the tally lamp using the tally control signal.

Factory settings: Enable

Status lamp

[Enable, Disable]

[Disable] or [Enable] is set here for the status display lamp.

When you want the status display lamp to stay off while this unit is in operation, set to [Disable].

Factory settings: Enable

[Note]

Even when set to [Disable], the status display lamp may light up when this unit is starting up, updating firmware, or trouble is occurring.

OSD off with Tally

[Off, On]

This is used to enable or disable the function for clearing the OSD menu displays when the tally signal is received by a command or contact.

When the tally signal is released, the original OSD menu displays are restored.

Factory settings: Off

Colorbar

[Off, On]

Switch between camera images and color bars.

When the color bars are displayed, a test tone is output according to the Audio setting in the camera menu.

Factory settings: Off

Wireless ID

[1, 2, 3, 4]

Configure the unit's remote control ID. The settings for this item correspond to the [CAMERA 1] to [CAMERA 4] buttons on the wireless remote control.

Value: 1, 2, 3, 4

Factory settings: 1

Wireless Control

[Off, On]

Switch the power ON/OFF control with the wireless remote control.

Factory settings: On

USB Video H.264

[Enable, Disable]

Switch the "Enable" or "Disable" of USB Video H.264.

[Note]

Using the USB Video with Skype for Business, set the USB Video H.264 to "Disable".

Factory settings: Disable

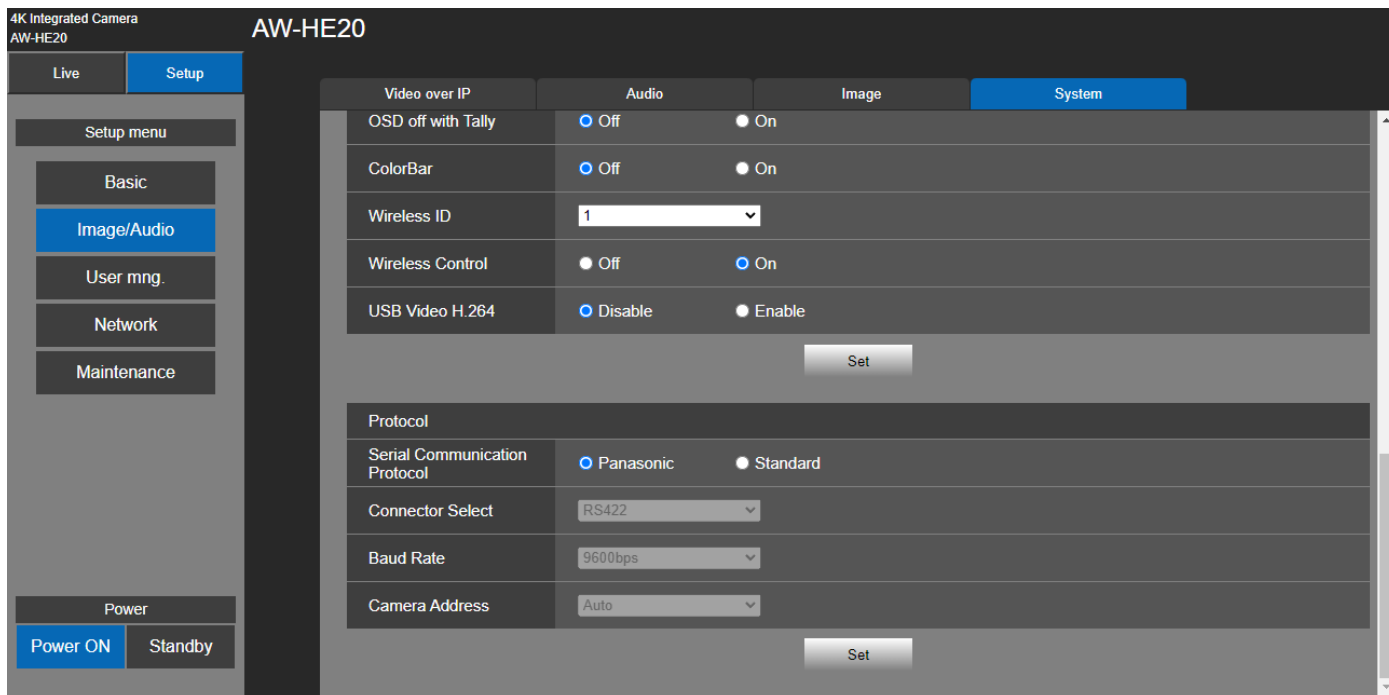

■ Protocol

Click [Set] button to save the configuration.

Serial Communication Protocol

[Panasonic, Standard]

Set the serial communication protocol for the RS422 terminal.

You can select either **Panasonic** or **Standard**.

Factory settings: Panasonic

Connector Selector

[RS422, RS232C]

Select [RS422] or [RS232-C].

[Note]

This can only be configured when [Serial Communication Protocol] is set to [Standard].

Factory settings: RS422

Baud Rate

[9600bps, 38400bps]

You can select a baud rate for serial communication.

[Note]

This can only be configured when [Serial Communication Protocol] is set to [Standard].

Factory settings: 9600bps

Camera Address

[Auto, 1, 2, 3, 4, 5, 6, 7]

Configure the camera ID in Daisy Chain connection to a controller.

Select [Auto] and the camera ID will be assigned automatically based on the order of camera connection.

If you select any number from 1 to 7, it will be assigned to the specified camera number.

[Note]

This can only be configured when [Serial Communication Protocol] is set to [Standard].

Factory settings: Auto

User Mng. (User Management)

Click [Setup] > [User Mng.]

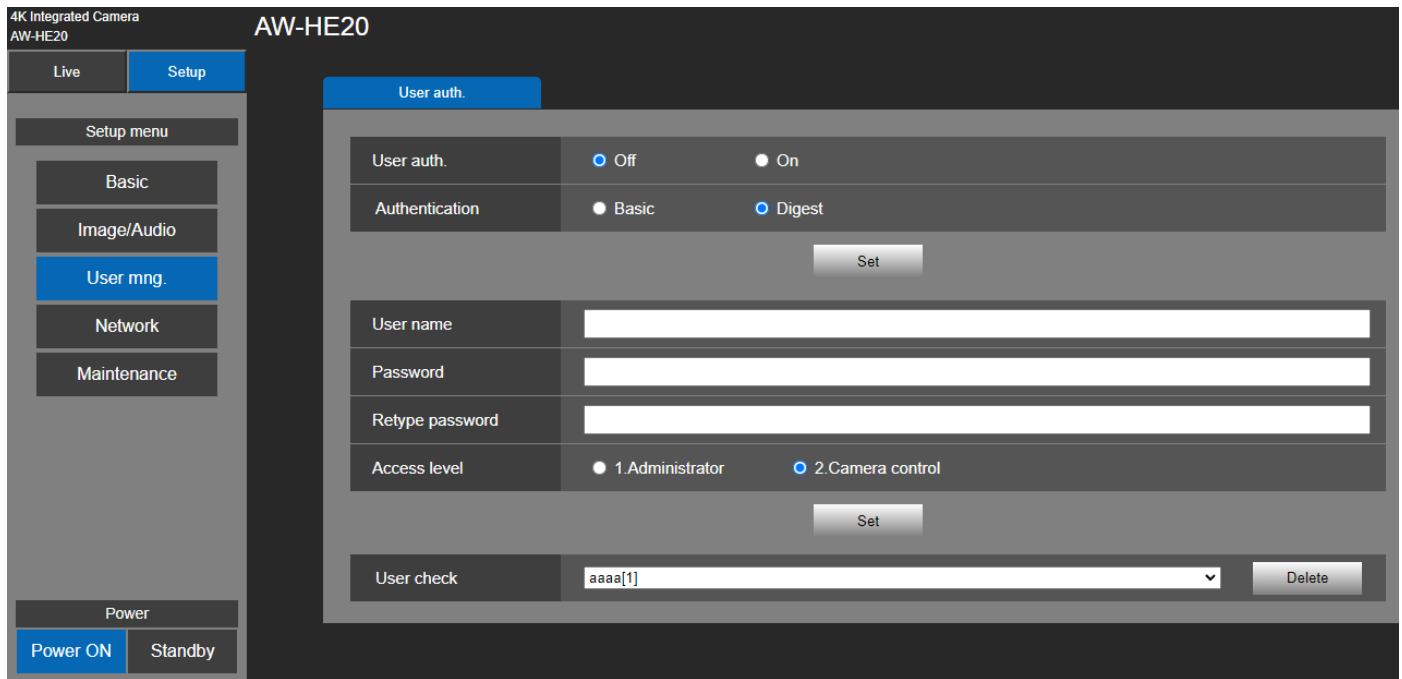

User auth. (User authentication)

Configure the user authentication settings for the personal computers and mobile terminals that can access the unit. Up to 9 users can be registered.

User auth.

[Off, On]

Turn user authentication to off/on. Click [Set] button to save the configuration.
Factory settings: off.

Authentication

[Basic, Digest]

Specify the method of user authentication to use. Click [Set] button to save the configuration.

Factory settings: Digest.

Basic	Use basic authentication.
Digest	Use digest authentication.

User name

Enter the user name here (1 to 32 characters). Click [Set] button to save the configuration. The following characters can be displayed.

Numeric characters	0123456789
Alphabetical characters (upper and lower cases)	ABCDEFGHIJKLMNOPQRSTUVWXYZ abcdefghijklmnopqrstuvwxyz
Symbols	#%+=, - _ ^ / @ . ~

Password/Retype password

Enter the password here (4 to 32 characters). Re-enter the password to confirm.

Access level

[Administrator, Camera control]

Select the user access level.

Factory settings: Camera control

Click [Set] button to save the configuration.

1.Administrator	This access level allows the user to perform all the unit's operations.
2.Camera control	This access level allows only live screen [Live] operations to be performed.

User Check

Delete the user accounts registered in the unit. You can delete selected users by clicking the [Delete] button at the right.

Network Settings

Configure Network, RTMP, and NTP setting in the Network setup screen.
Click [Setup] > [Network].

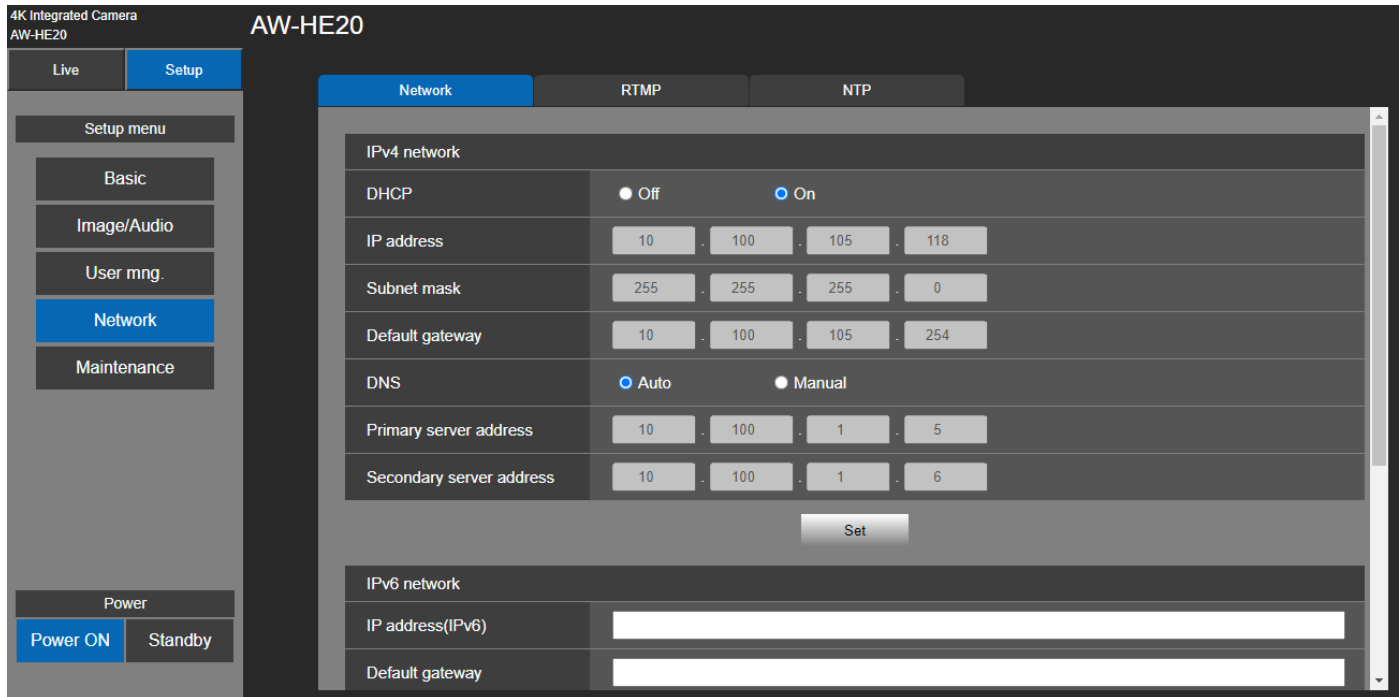

Network

Setup IPv4 and IPv6 network.

Click [Setup] > [Network] > [Network].

■ IPv4 network

Click [Set] button to save the configuration.

DHCP

[Off, On]

Select the method in which the IP address is configured.

Factory settings: off.

IP Address

Input the unit's IP address here when the DHCP function is not going to be used. Input an address that will not duplicate an existing IP address which has been set for a personal computer or another network camera.

Factory settings: 192.168.0.10

[Note]

Multiple IP addresses cannot be used even when the DHCP function is used. For details on the DHCP server settings, consult your network administrator.

Subnet Mask

Input the unit's subnet mask here if the DHCP function is not going to be used.

Factory settings: 255.255.255.0.

Default Gateway

Input the unit's default gateway if the DHCP function is not going to be used.

Factory settings: 192.168.0.1.

[Note]

Multiple IP addresses cannot be used for the default gateway even when the DHCP function is used.

For details on the DHCP server settings, consult your network administrator.

DNS

[Auto, Manual]

Whether the DNS server address is to be acquired automatically (Auto) or manually (Manual) is input here.

Factory settings: Manual.

If [Manual] has been selected, the DNS settings must be established. If [Auto] is selected when the DHCP function is going to be used, the DNS server address is acquired automatically.

For details, consult your system administrator.

Primary Server Address/Secondary Server Address

Input the IP address of the DNS server if the [Manual] setting has been selected for [DNS].

For details on the IP address of the DNS server, consult your system administrator.

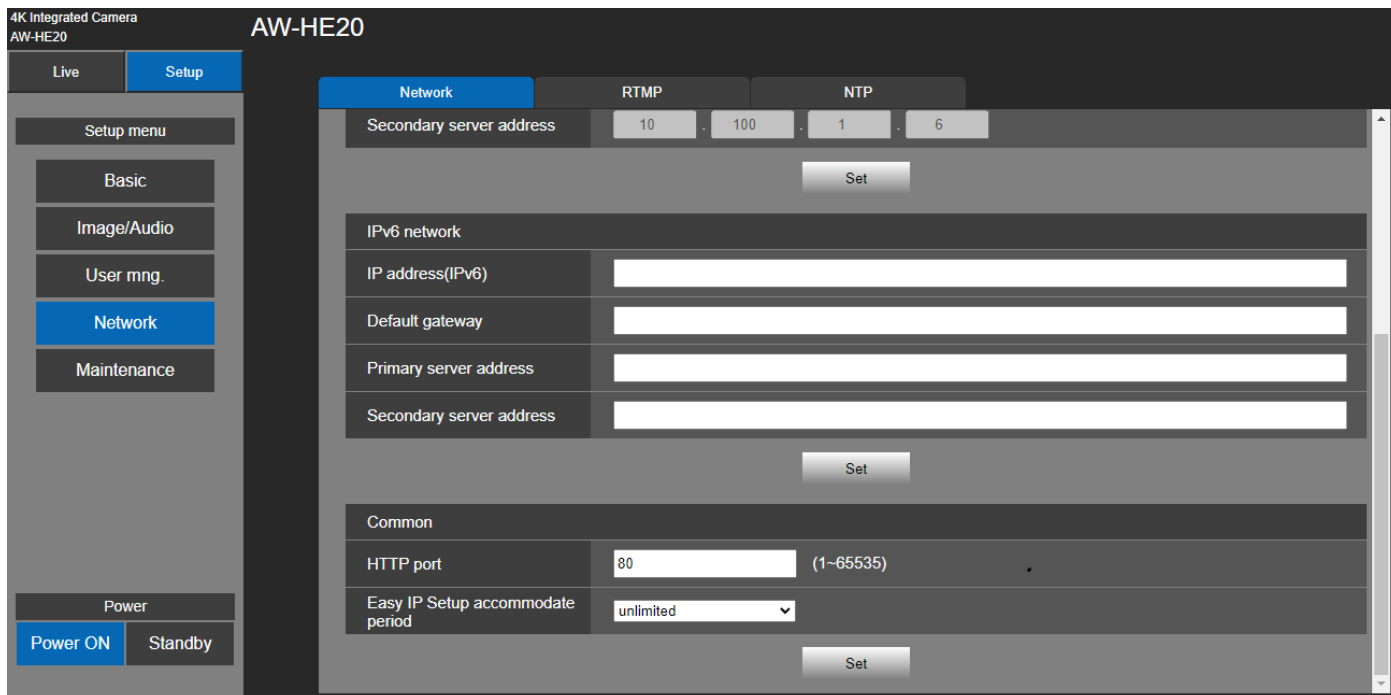

■ IPv6 network

Click [Set] button to save the configuration

IP Address (IPv6)

The IPv6 address must be entered manually.
Be sure to enter an address unique from other devices.

Default Gateway

Enter the default gateway for the unit's IPv6 network.
Factory settings: blank.

Primary server address/Secondary server address

Enter the IPv6 address of the DNS server.
For details on the IPv6 address of the DNS server, consult your system administrator.

■ Common

Click [Set] button to save the configuration

HTTP PORT

Port numbers are allocated separately.
 Setting range: 1 to 65535
 Factory settings: 80

Easy IP Setup accommodate period

[20min, Unlimited]

Select [20min] or [Unlimited] as the time for enabling the operation of the network settings from the Easy IP Setup Software.

20 mins	The setting operations from the Easy IP Setup Software are enabled for 20 minutes after the camera has started operating.
Unlimited	The setting operations from the Easy IP Setup Software are enabled at all times.

Factory settings: Unlimited

[Note]

- The camera screen can be opened because the camera display in the Easy IP Setup Software is constantly enabled.
- For details on the address settings of each server, consult your network administrator.
- The port forwarding function converts a global IP address to a private IP address, and includes “static IP masquerade” and “network address translation (NAT)”. This function is set to the router.
- To access the camera via the Internet after connecting it to a router, it will be necessary to set an individual HTTP port No. for each network camera and to convert the address using the router’s port forwarding function. For details, refer to the operating instructions for the router.

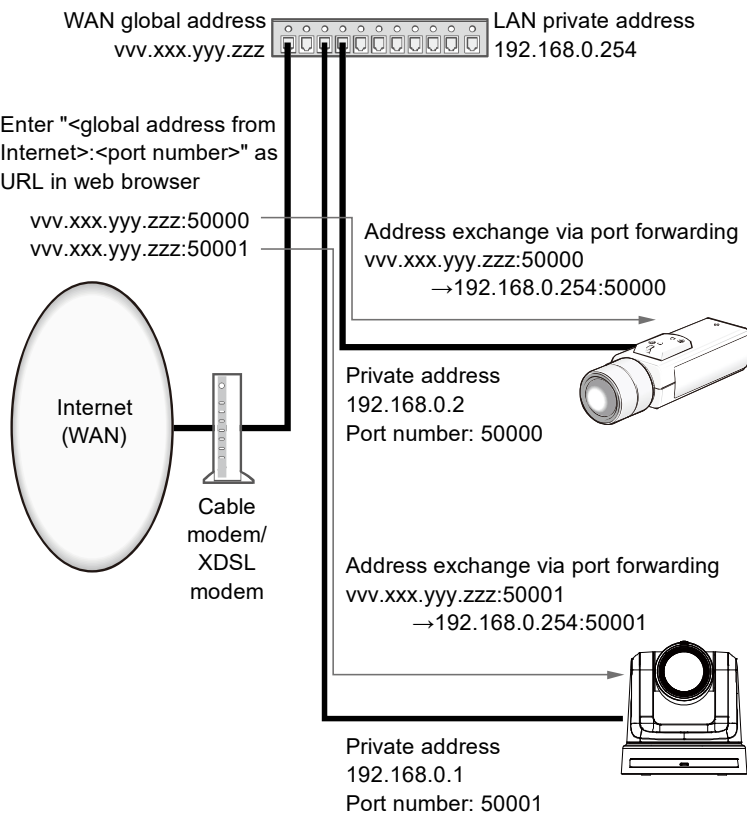

RTMP Setting

Make RTMP transmission settings.

Click [Setup] > [Network] > [RTMP].

Click [Set] button to save the configuration.

[Note]

- Switch to the appropriate method of registering RTMP transmission server information suited to the setting information notified from the RTMP transmission server you are using.
- The Stream Key setting field is displayed only when [Type2] is set.
- Please do not change the following menu items during IP streaming: Priority mode, Frequency, Format, Install Position, and Audio.
- When Audio is On, RTMP transmission may not start. (Such an occasion arises when the server to which RTMP transmission is delivered requires audio transmission.)
- If you change Audio from On to Off during RTMP transmission, RTMP transmission may stop.

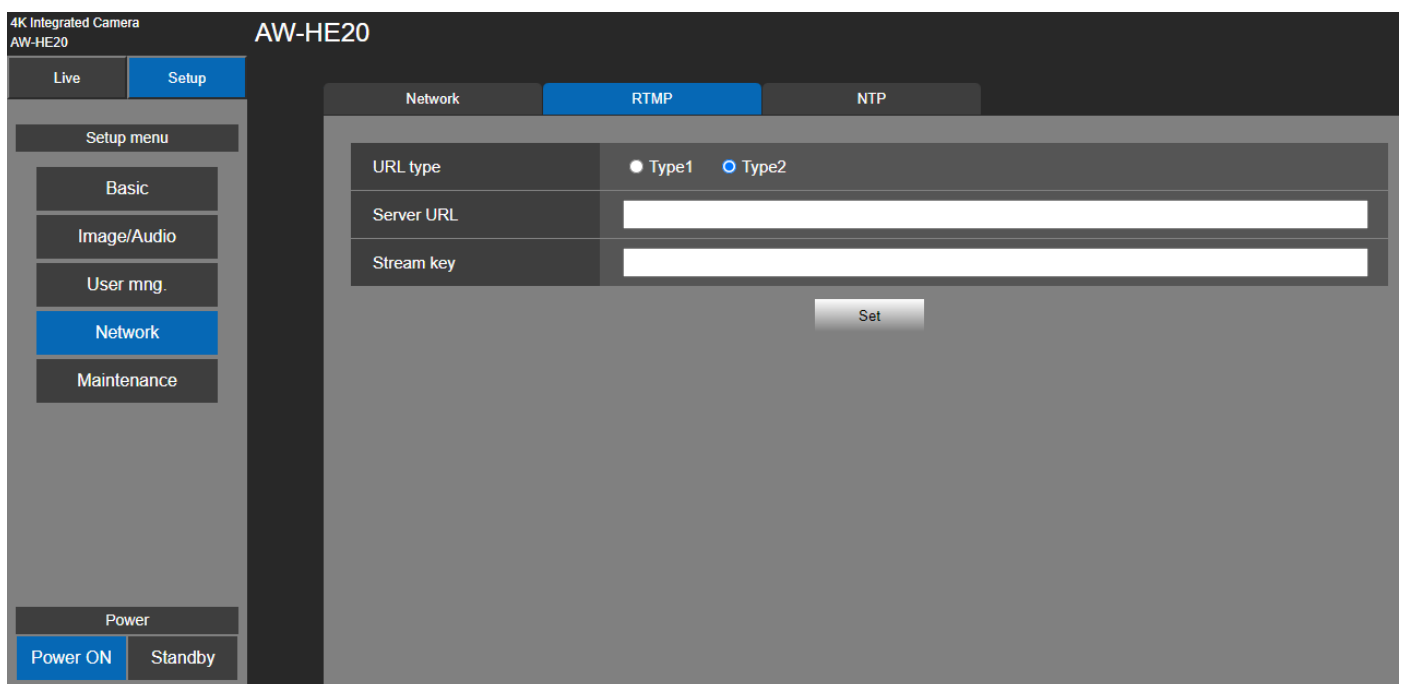

- “Max. bit rate (per client)” is set higher than 8192kbps, the bit rate during RTMPS transmission will be 8192kbps.

URL Type

[Type1, Type2]

Select the method for registering the information for the RTMP transmission server. The default is [Type2].

Type1	Specify to set the server URL and RTMP stream key as a set in [Server URL].
Type2	Specify to individually set the server URL and RTMP stream key in [Server URL] and [Stream Key].

Server URL

Set the URL for the RTMP server to be transmitted to.

Stream Key

The stream key obtained from the RTMP server is set during streaming only when the service is set to [Type2].

NTP

Settings relating to the NTP server address and port No. are performed.

This item's setting is reflected when the [Set] button is pressed.

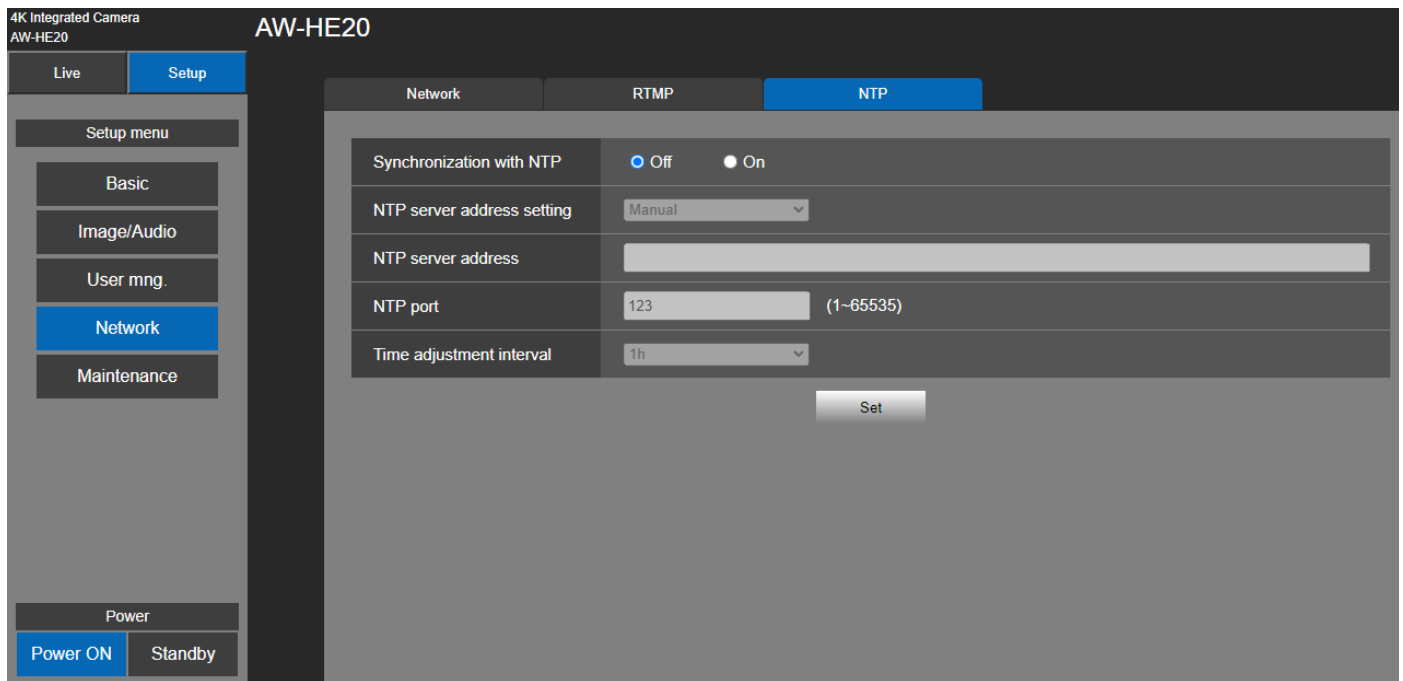

Synchronization with NTP

[Off, On]

Set whether to use an NTP server by selecting “On” or “Off”.

Setting value:

On	Uses an NTP server. (Synchronizes the date and time with the NTP server.)
Off	Does not use an NTP server.

Factory settings: Off

NTP server address setting

[Auto, Manual]

Select the method to acquire the NTP server address.

Setting value:

Auto	Acquires the NTP server address from the DHCP server.
Manual	Sets the address by inputting the NTP server address in [NTP server address].

Factory settings: Manual

[Note]

- To acquire the NTP server address from the DHCP server, you need to set “DHCP” (page 99) of “IPv4 network” on the [Network] tab of the network setup screen [Network] to “On”.

NTP server address

When [Manual] is selected in the [NTP server address setting], input the IP address or host name of the NTP server.

Maximum number of characters	0 to 128 half-size characters
Characters that can be entered	Half-size alphanumeric characters, half-size symbols :. _ -

Factory settings: blank

[Note]

- To input the [NTP server address] host name, the [DNS] setting must be selected on the [Network] tab of the network setup screen [Network] (page 100).

NTP port

Input the port No. of the NTP server.

Port Nos. that can be selected: 1 to 65535

Factory settings: 123

Time adjustment interval

Selects the interval (1 to 24 hours in 1-hour increments) for acquiring the time from the NTP server.

Setting range: 1h to 24h

Factory settings: 1h

Maintenance Settings

Among the various maintenance operations performed on this screen are language, system version upgrading and initialization of the unit.

The Maintenance screen consists of four settings: [Language], [Product info.], and [Default reset].

Click [Setup] > [Maintenance].

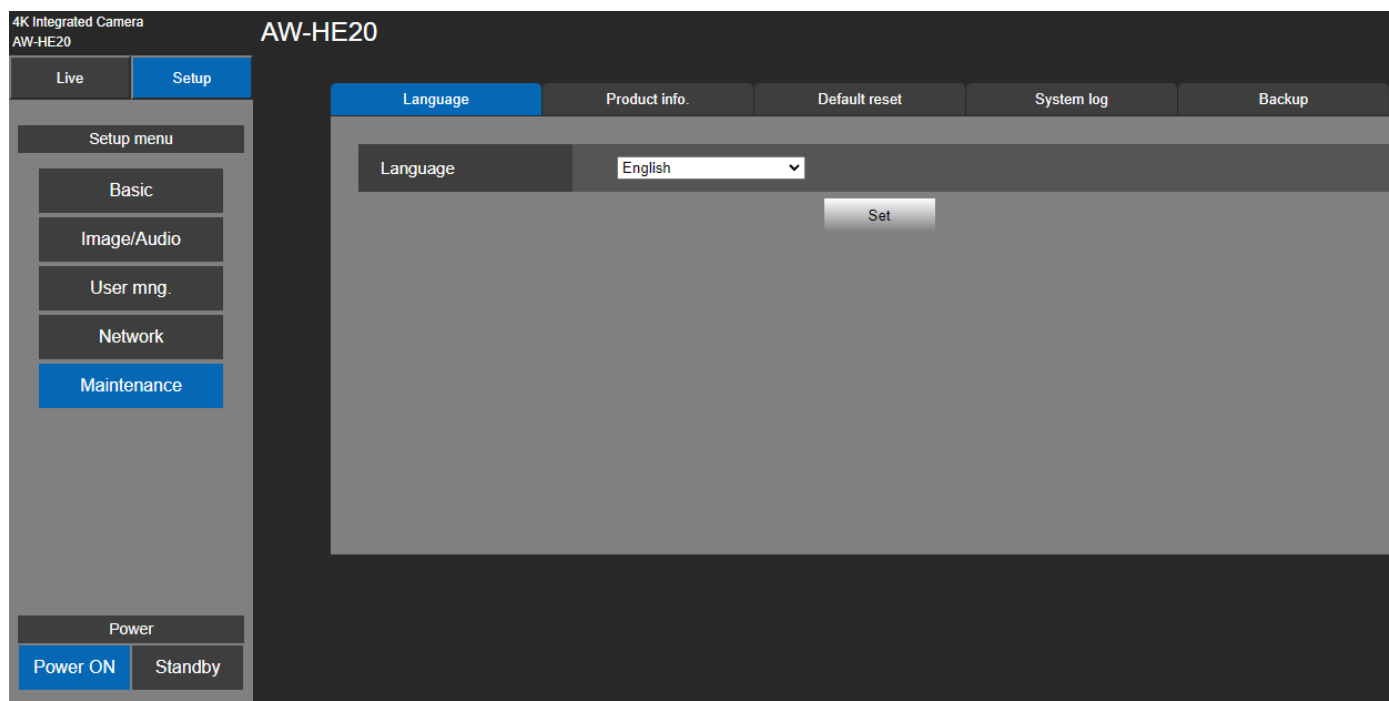

Language

[English, 日本語, 簡中]

Set the unit system's language: [English], [Simplified Chinese], and [Japanese].

Click [Setup] > [Maintenance] > [Language].

Click [Set] button to save the configuration.

Factory settings: English

Product Info.

Click [Setup] > [Maintenance] > [Product Info.].

The versions of the unit's software can be checked on this screen.

The [Model no.], [MAC address], [Serial no.], [Firmware version] and [Operation Time] of the unit is displayed.

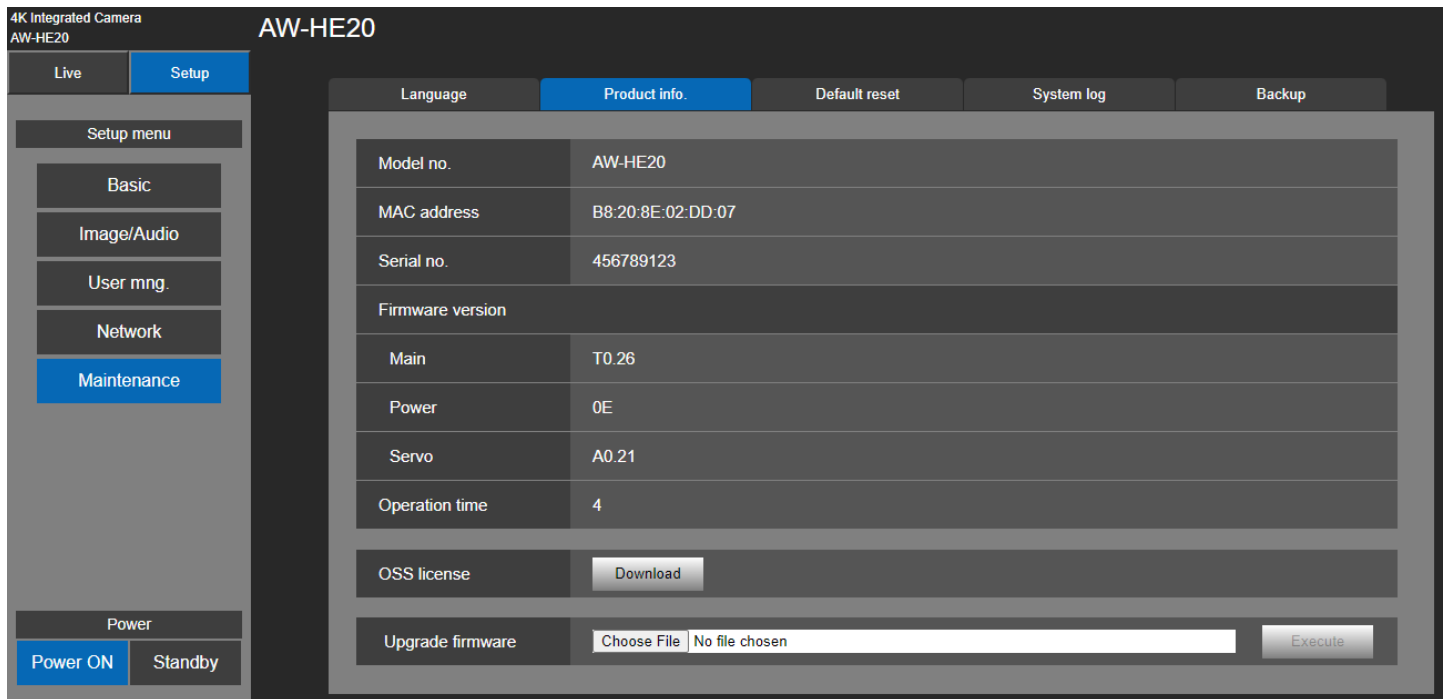

Model no.

Displays the unit's model number.

MAC address

Displays the unit's MAC address.

Serial no.

Displays the unit's serial number.

Firmware version

Main: Displays the main software version.

Power: Displays the software version of the power.

Servo: Displays the software version of the servo.

Operation time

Displays the hours the unit has been operating.

OSS license

Click "Download" button to download the OSS (Open Source Software) file. The OSS license file include all OSS license for AW-HE20. The download file name is "**License.zip**".

Upgrading the firmware (Firmware file)

Click [Setup] > [Maintenance] > [Product Info.].

1. Download the latest software to your personal computer.

[Note]

Keep the maximum combined number of characters to be used for the name of the directory in which the software will be stored and for the name of the software which has been downloaded to less than 250 characters.

2. Click the [Browse] button, and specify the downloaded software.
3. Click the [Execute] button. The [Execute] button will be enabled when the direction of software has been select.
4. The software upgrade check screen is displayed.

After upgrading the software version, be absolutely sure to delete the temporary Internet files.

[Note]

- An upgrade progress bar appears after you click the [Execute] button, and the process will take about 2 minute.
- Use the personal computer on the same subnet as the camera to upgrade the software version.
- Before using the version upgrading software, be absolutely sure to check the precautions to be observed, and follow the instructions.
- Use the files specified by Panasonic Connect Co., Ltd. as the software used for version upgrading.
- Do not turn off the unit's power while a software version is being upgraded. (Message will appear to indicate that the process is complete.)
- While a software version is being upgraded, do not attempt to execute any other operations until the version has been upgraded.
- Close the web browser once after performing a version upgrade.
- If the power is turned off during upgrading, please upgrade once more. In the case the unit may not power on, please consult your local dealer.

Default Reset

The unit's setting data is initialized and the unit is restarted in here.

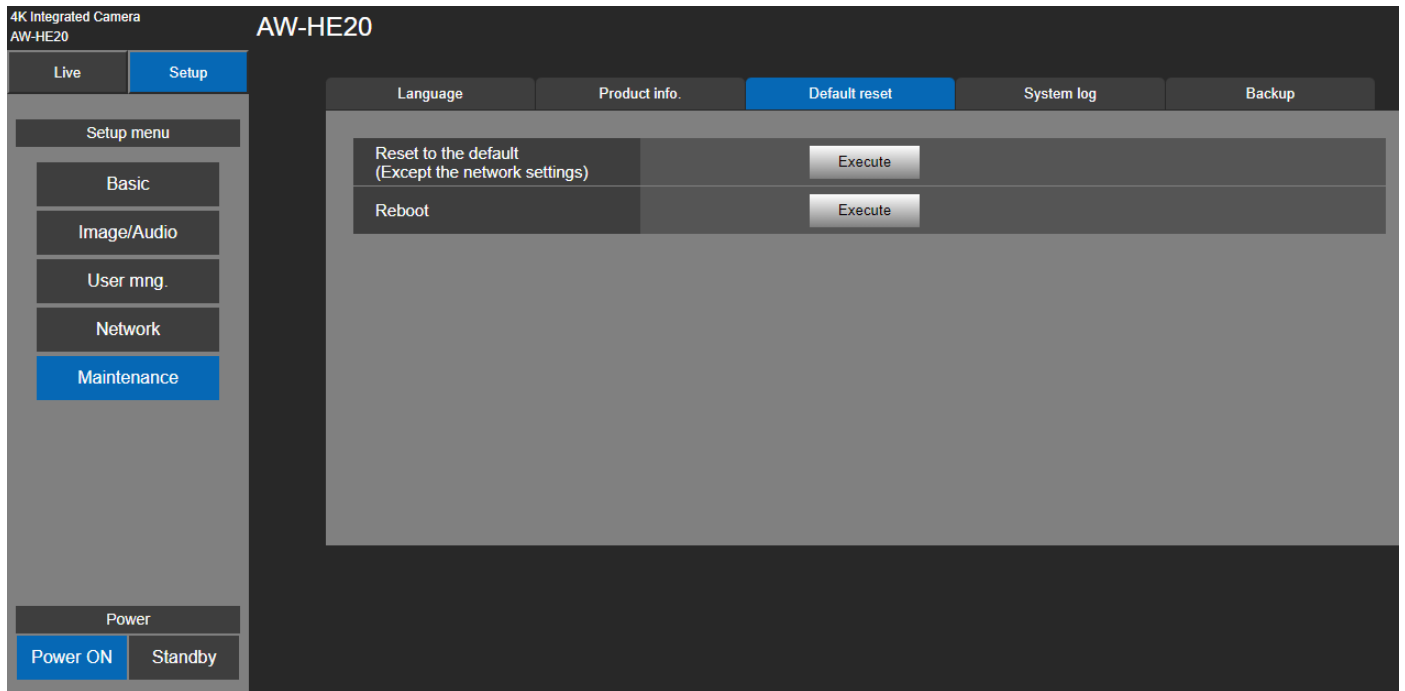

Reset to the default (Except the network settings)

When the [Execute] button is clicked, the unit's settings are returned to their defaults.

When the initialization operation is started, the unit is restarted so no operations can be undertaken for about 2 minutes.

[Note]

The following setting items will not be returned to defaults.

- [Priority Mode]
- [Frequency]
- [Format]
- All settings under [User mng.]
- All settings under [Network - Network]
- [AWB] adjustment values will not be returned to defaults.

Reboot

When the [Execute] button is clicked, the unit is rebooted.

After the unit has been rebooted, no operations can be undertaken for about 2 minutes as is the case when the unit's power is turned on.

System Log

Up to 100 event logs and error logs can be saved to the internal memory of the unit. When this maximum number has been exceeded, the old logs are overwritten successively by the new logs. The logs are maintained even if the unit's power is turned off. The event logs are always displayed when the System log screen is displayed.

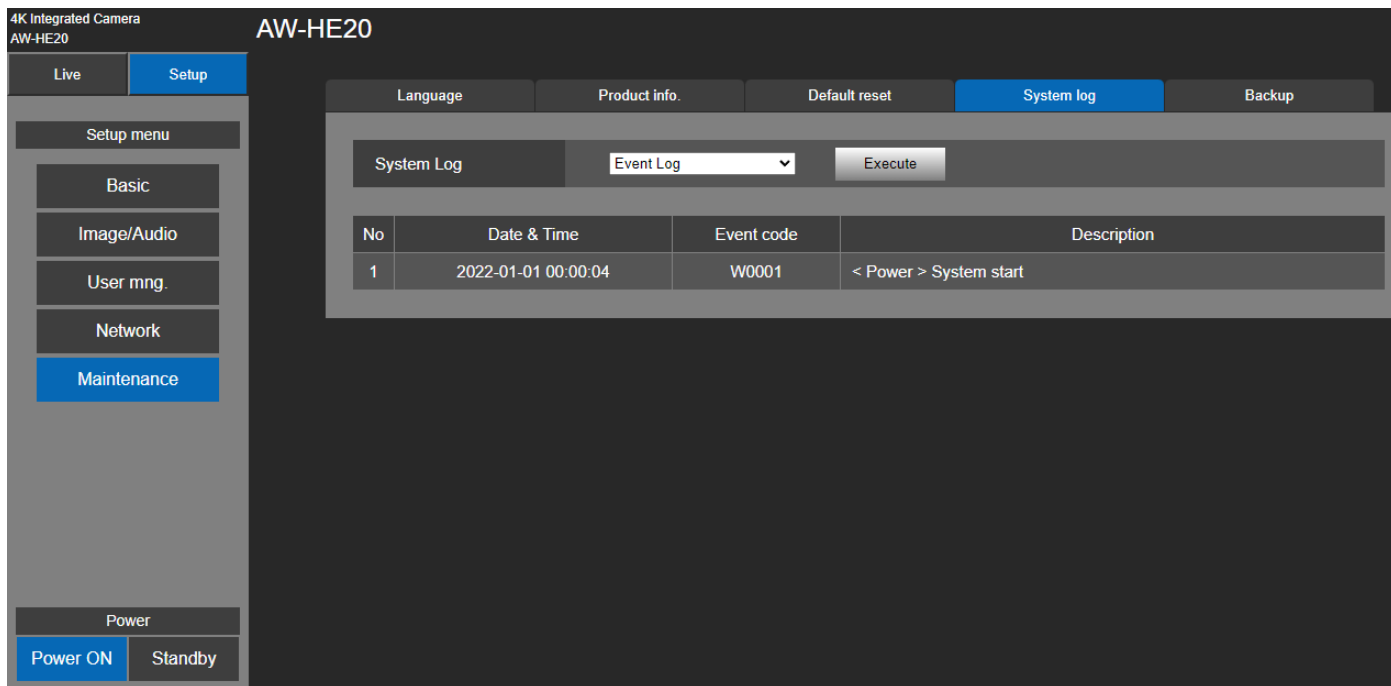

System log

[Event Log, Error Log]

Switch the display between event logs and error logs.

Setting value

Event Log	Displays the event logs.
Error Log	Displays the error logs.

Event Log

No

Displays the log sequence numbers.

Up to 100 logs can be saved.

Date & Time

Displays the dates and times when the events occurred. The dates and times when the events occurred are indicated in 24-hour format according to the clock of the unit.

Event code

Displays the event code numbers.

Description

Displays the event descriptions.

Error Log

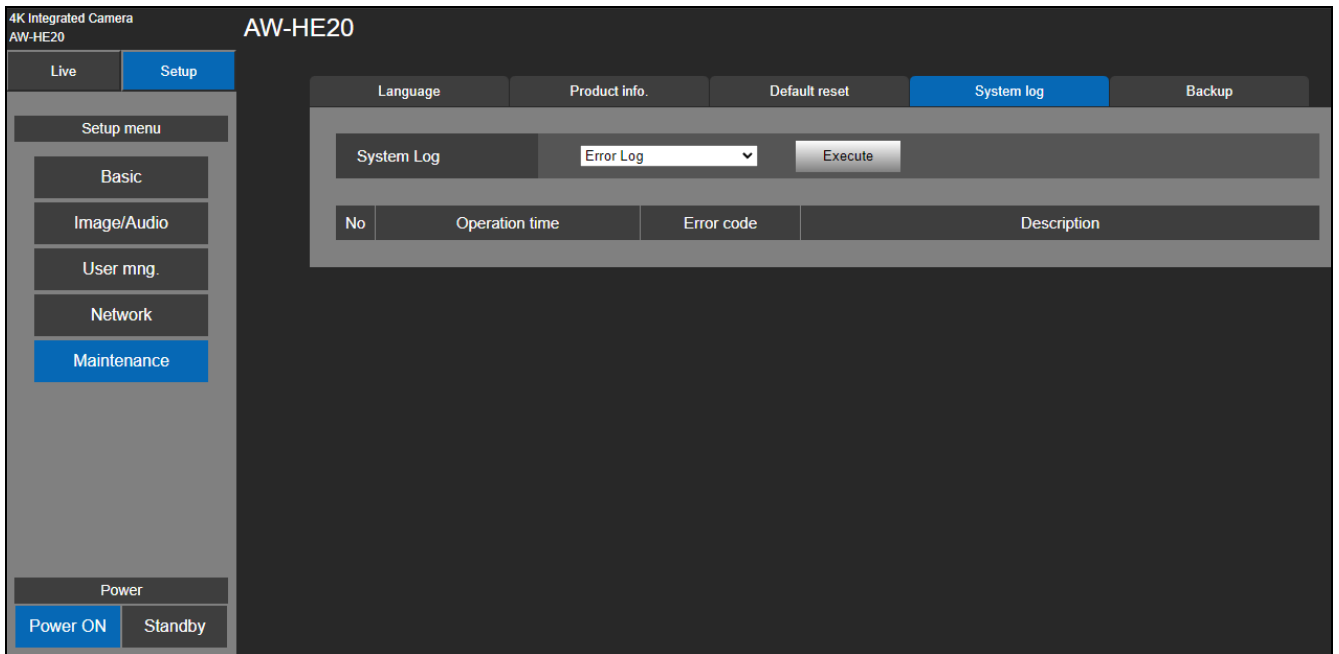

No

Displays the log sequence numbers.

Up to 100 logs can be saved.

Operation time

Displays the dates and times when the errors occurred. The dates and times when the errors occurred are indicated with the hour meter (0h to 99999h) of the unit.

Error code

Displays the event code numbers.

Description

Displays the error descriptions.

Backup

On this screen, the unit's settings can be saved to a personal computer or settings saved in a personal computer can be loaded into the unit for use.

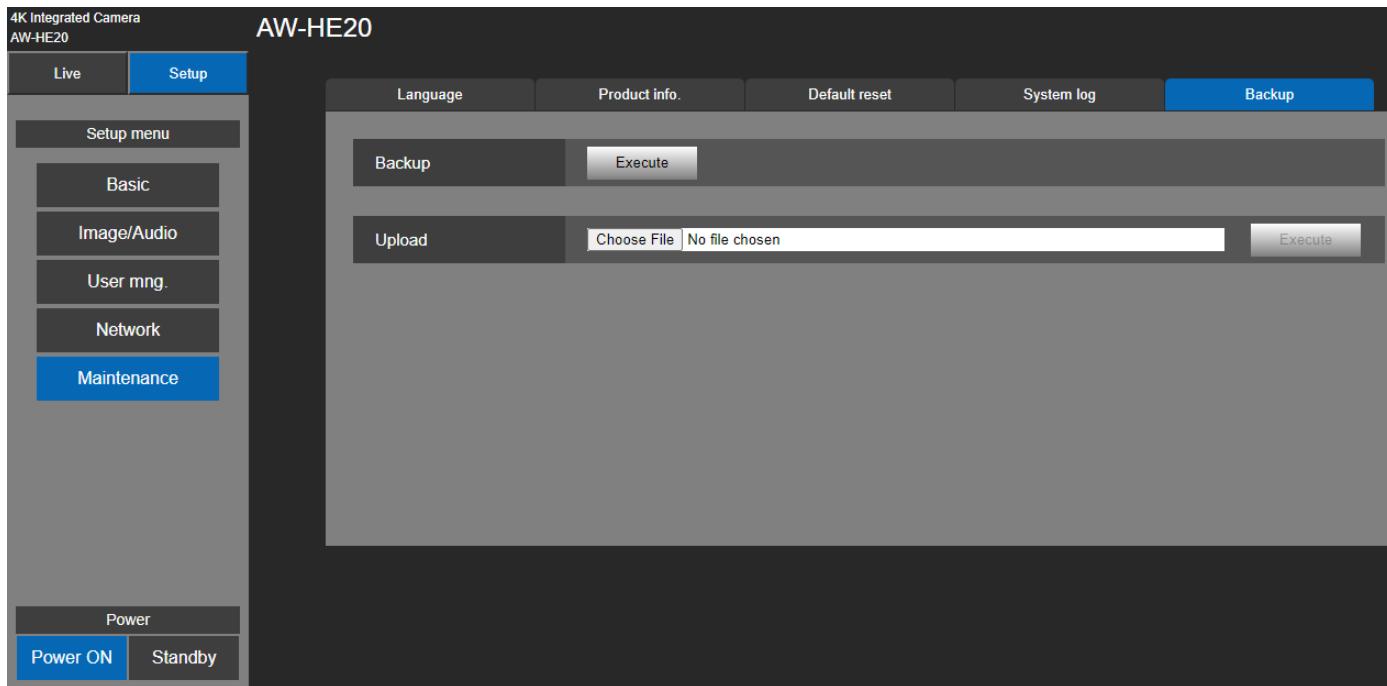

Backup

Save the unit's settings onto the personal computer. When the destination dialog box appears after clicking the [Execute] button, specify the destination folder.

Upload

The unit's setting files, which were saved in the personal computer by the download function, can be uploaded. Click the [Choose File] button to display the dialog box, and specify the setting file.

When you click the [OK] button in the message dialog box that appears after you click the [Execute] button, uploading starts.

Another message dialog box appears after uploading is complete. When you click the [OK] button, the unit will restart automatically.

Web Camera Functions

The unit can be used as a Web camera if you connect the unit and a personal computer or other device with a commercially available USB cable.

The unit is compliant with USB Video Class and USB Audio Class. The video and audio of the unit can be transmitted to a personal computer or other device by using communication software or other software.

- Set the priority mode to "HDMI/USB" or "USB (Video Conference)" before use.
- For the connection procedure, refer to "System example 3 (USB connection)".
- Audio can be output from the audio input connector [AUDIO IN] of the unit to a personal computer or other device.
- If you set the Priority Mode to USB (Video Conference), you cannot output video via HDMI/SDI, and you cannot output video via IP transmission. Also, in this mode, the audio output is forcibly turned off.

[Note]

- There is no guarantee that operation will be possible with all devices that have a USB port.
- IP control, IP video transmission, and PoE+ power supply can be used at the same time as these functions if you use a LAN cable. However, some limitations will occur to IP video transmission compared with when the priority mode is set to "IP". For details, refer to "[Priority mode](#)" section.
- Using the USB Video with Skype for Business › set the USB Video H.264 to "Disable".

Controllable functions

The following functions can be controlled when the unit is used as a Web camera.

- The names of the functions are the names used in Windows. Furthermore, values are shown as decimals.
- [] indicates the actual function names.
- Please do not change the following menu during UVC output.
Priority mode, Frequency, Format, Install Position, Mirror, Mic

Image adjust

[Brightness] > [Picture level]

This can be set in the same way same way as "Picture level" of the menus and Web settings.

Setting range: -4, -3, -2, -1, 0, 1, 2, 3, 4

Chroma level [Chroma level]

This can be set in the same way same way as "Chroma level" of the menus and Web settings.

Setting range: 0 to 10

Equivalent to -3 to +3 of "Chroma Level".

If the scene mode is set to "Full Auto", even if this setting is changed, the change will not be reflected on the unit.

White balance [White Balance mode]

This can be set in the same way same way as "White Balance mode" of the menus and Web settings.

Setting value: ATW, AWB A, AWB B, 3200K, 5600K

Backlight compensation [Backlight Comp]

This allows you to set backlight compensation in the same way as “Back Light COMP.” of the menus and Web settings.

Setting value: Off, On

If the scene mode (scene) is set to “Full Auto”, even if this setting is changed, the change will not be reflected on the unit.

Detail [Detail]

This can be set in the same way same way as “Detail” of the menus and Web settings.

Setting Range : 0, 1, 2, 3

Contrast [Contrast]

This can be set in the same way same way as “Contrast” of the menus and Web settings.

Setting Range : 0, 1, 2, 3, 4

Zoom [Zoom]

Configure the maximum zoom magnification.

Opt.Zoom	Use only the optical zoom. Up to 12× optical zoom is possible.
i.Zoom	Enabling this function allows you to perform electronic zoom while reducing drops in picture quality. Combining optical zoom and electronic zoom, up to 15.96× zoom is possible.
D.Zoom	Enable the digital zoom function. Picture quality degrades as zoom increases with digital zoom.

Troubleshooting

Operation

Symptom	Cause and solution
No power	Is the AC adaptor securely connected to the AC outlet?
	If the power plug of the AC adaptor connected properly?
	Is the network cable for the PoE+ (IEEE802.3at) compatible power supply device and the unit connected properly?
	Power may not be supplied if the total power limit is exceeded on power supply devices that allow connections to multiple PoE+ terminals.
	If the unit is connected to the controller, has it been connected properly? → For details, refer to the operating instructions for the controller.
Cannot operate (common to wireless remote control, controller)	Is the power on? → If the unit's status display lamp is off or lights up orange, it means that the unit's power is not on.
	Has the unit you want to operate been selected properly?
Cannot operate using the wireless remote control	Have the remote control's batteries run down or have the batteries been installed with their polarities reversed? → If the status display lamp does not blink even when the wireless remote control is operated near the wireless remote control signal light-sensing area, it means that the batteries have run down. Replace the batteries.
	Have the Wireless ID been set correctly?
	Is there a fluorescent light or plasma monitor near the unit and, if so, is the wireless remote control signal light-sensing area exposed to its light?
	Is the wireless control on the web screen menu not set to "Off"? → If the power status indicator flashes orange rapidly (5Hz) when operated with the wireless remote control, the wireless control in the Web screen menu is set to "Off".
The unit turns in the opposite direction to the one operated	Has the Install Position setting been selected correctly?
	The reversal setting may have been established at the controller if the unit is connected to the controller. → For details, refer to the operating instructions for the controller.
Cannot operate using the controller	Is the unit connected to the controller properly? → For details, refer to the operating instructions for the controller.
	It may be necessary to upgrade the version of the controller so that the controller will support the unit. → For details on upgrading, visit the support page on the following website. https://pro-av.panasonic.net/
Cannot access from a web browser	Has a LAN cable of category 5e or above been connected to the LAN connector for IP control <LAN LINK/ACT>?
	Is the [LINK] LED of the LAN connector for IP control lit? → If it is not lit, it means that something is wrong with the connection to the LAN or that the network at the connection destination is not working properly. Check the LAN cable for defective contacts, and check the wiring.
	Is the power on? → If the unit's status display lamp is off or lights up orange, it means that the unit's power is not on.

Symptom	Cause and solution
<p>Cannot access from a web browser</p>	<p>Has a valid IP address been set in the unit?</p>
	<p>Has the wrong IP address been accessed? → Check the connections by following the steps below. For Windows: Using the Windows command prompt, execute > ping [IP address which has been set in the camera] A reply returned from the unit signifies that there are no problems in operation. If a reply is not received, try following operation: Reboot the unit, and within 20 minutes change the IP address using the Easy IP Setup Software. For Mac: Using the OS X terminal, execute > ping -c 10 [IP address which has been set in the camera] A reply returned from the unit signifies that there are no problems in operation. If a reply is not received, try following operation: Reboot the unit, and within 20 minutes change the IP address using the Easy IP Setup Software.</p>
	<p>Is the same IP address setting being used by another unit? → Check out the IP addresses of the unit, access devices (personal computer, etc.) and any other cameras.</p>
	<p>Does the subnet mask setting match the network subnet of the connection destination? → Check out the subnet mask settings of the unit and access devices, and then consult with the network administrator.</p>
	<p>Has the “Use a proxy server” setting been selected by the web browser? (When the unit and the personal computer are connected to the same subnet) → If a proxy server has been set using the [proxy setting] of the web browser, it is recommended that a “Don’t use proxy” address be selected as the unit’s IP address setting.</p>
	<p>Has the wrong default gateway been set for the unit? (When the unit and personal computer are connected to different subnets) → Check out the default gateway that has been set for the unit, and then consult with the network administrator.</p>

Video

Symptom	Cause and solution
No pictures are displayed or the pictures are disturbed	Has the unit been connected properly to the other connected devices?
	If the system is configured in such a way that the picture is also switched when the unit to be operated is selected, has the correct unit been selected?
	Has the image signal setting been selected correctly?
	While outputting video from HDMI, if the USB device is connected / disconnected or video is started, the HDMI output video may be disrupted. Do not disconnect the USB device while using HDMI output.
The picture is flipped vertically	Has the Install Position setting been selected correctly
Multiple color bands (color bars) are displayed	Switch to the camera picture.
The menu screen is displayed	Exit the menu.
It is difficult to view the menu screens	Depending on the HDMI monitor you are using, you may experience one or more of the symptoms described below. These symptoms are especially noticeable when any of the SD formats is used: This is normal and not indicative of any trouble.
	<ul style="list-style-type: none"> ● The resolution of the characters in the camera menu displays changes as the background image changes. ● Depending on the edge enhancement setting established for the monitor, white lines appear in front of the black shadows of the menus. ● Depending on the edge enhancement setting established for the monitor, the background colors may be superimposed onto the white parts of the menus.
Something is wrong with the coloring of the pictures	Activate the ATW (Auto tracking white adjustment) function.
	In some situations, the proper colors may not be reproduced using the ATW function. → In cases like this, proceed with the white balance adjustment.
Using the USB Video with Skype for Business, Skype for Business stop.	Has the USB Video H.264 been selected to "Disable"?

IP images

Symptom	Cause and solution
Images are not displayed	<p>For Windows: If [Check for newer versions of stored pages] is not set to [Every time I visit the webpage] in the temporary Internet file settings, IP images may not appear in the live screen [Live]. → Perform the following. Select [Tools] - [Internet Options] in Internet Explorer. Click the [General] tab, and click the [Settings] button under [Browsing history]. In the [Temporary Internet Files and History Settings] dialog box, select the [Every time I visit the webpage] option under [Check for newer versions of stored pages]. Click the [OK] button.</p>
The images do not update or display properly	<p>Perform the following to delete the temporary Internet files. For Windows: Select [Tools] - [Internet Options] in Internet Explorer. Click the [General] tab, and click the [Delete] button under [Browsing history]. In the [Delete Browsing History] screen, select the [Temporary Internet Files] checkbox, and then click [Delete]. Click the [OK] button.</p> <p>For Mac: Select [Safari] - [Empty Cache] in Safari. Click [Empty] in the [Are you sure you want to empty the cache?] pop- up screen.</p> <p>The unit's ports may be filtered by the firewall or other function of the anti-virus software. → Change the HTTP port number of the unit to a port number that will not be filtered.</p> <p>If the web browser screen stops, reload the web browser screen.</p>
The RTSP image transmission stop	<p>If the RTSP image transmission stops, perform the playback operation from the playback device again.</p>

USB

Symptom	Cause and solution
Cannot be recognized as a USB device, or image are not displayed	USB drive installation takes time for the first time.
	Please make sure the priority mode is HDMI/USB or USB mode.
	<p>If the following operations are performed, this unit may not be recognized as a USB device.</p> <ol style="list-style-type: none"> 1. Change the priority mode with the USB cable connected 2. Unplug the USB cable during UVC video playback <p>If it is no longer recognized as a USB device, restart this unit.</p>
Skype for Business stops working when using it as a webcam in Skype for Business.	Please make sure that USB Video H.264 is set to Disable.

Specification

Power requirements:

DC  12V (10.8V-13.2V)

DC  42.5V to 57V

(PoE+ power supply)

Current consumption:

1.3 A (Supplied AC adapter)

0.4 A (PoE+ power supply)

The symbols on this product (including the accessories) represent the following:

 DC



Indicates safety information.

■ GENERAL

- **Ambient operating temperature:** 0 °C to 40 °C (32 °F to 104 °F)
- **Storage temperature:** -20 °C to +50 °C (-4 °F to +122 °F)
- **Allowable humidity ranges:** 20 % to 90 % (no condensation)
- **Dimensions (W x H x D):** 165.1 mm x 176.2 mm x 176.1 mm
(6.5 inches x 6.94 inches x 6.93 inches)
(Excluding protrusions, ceiling mount bracket)
- **Mass (Weight):** Approx. 1.9 kg (4.19 lb.)
(Excluding ceiling mount bracket)
- **Controller supported:** AW-RP60/AW-RP150

■ INPUT

- **DC 12 V IN**
- **Audio-IN:** ø 3.5 mm stereo mini jack
MIC/LINE INPUT

■ OUTPUT

- **HDMI:** HDMI Type-A
HDCP is not supported.
VIERA Link is not supported.
- **3G-SDI OUT:** 75Ω BNC (LEVEL-A supported)
[Note]: Embedded audio is not supported.

■ INPUT/OUTPUT

- **LAN:** LAN connector for IP control (RJ45)
- **USB:** Type-C port
- **RS-422:** CONTROL IN RS422A (RJ-45)
- **RS-232C:** Mini DIN 8pin (IN) / Mini DIN 8pin (OUT)

■ FUNCTIONS AND PERFORMANCE

[Camera unit]

- **Image sensor:** 1/2.8-type MOS
- **Lens:** Optical 12× zoom, F1.6 to F2.8
(f=3.9 ~ 46.8mm, 35mm equivalent: 26.4mm ~ 316.4mm)
- **Horizontal Field of view:** 71° (Wide) ~ 6° (Tele)
Vertical Field of view: 43° (Wide) ~ 3° (Tele)
Diagonal Field of view: 79° (Wide) ~ 7° (Tele)
- **Minimum focus distance:** Entire Zooming range: 1.5m
Wide end: 0.3m
- **Minimum illumination:** 0.4 lx
- **Horizontal resolution:** Center: 1000 TV lines (typ)
- **Gain selection :** Auto, 0 dB to 42 dB (3 dB steps)
- **Shutter Mode:**
 - Step
[50Hz]
1/1, 1/2, 1/3, 1/6, 1/12, 1/25, 1/50, 1/100, 1/250, 1/500, 1/1000, 1/2000, 1/4000, 1/8000, 1/16000
[59.94Hz/60Hz]
1/1, 1/2, 1/3, 1/7, 1/15, 1/30, 1/60, 1/120, 1/240, 1/480, 1/1000, 1/2000, 1/4000, 1/8000, 1/16000
 - Synchro
[59.94p, 29.97p]
60.0Hz~660.0Hz
[50p, 25p]
50.0Hz~570.1Hz
- **Zoom:** x2, x3, x4 Digital Zoom
- **Pan/tilt angle:** Pan: ±170 °
Tilt: -30 °/+90 °
- **White balance adjustment:** ATW, AWB A, AWB B, 3200 K, 5600 K
- **Chroma amount variability:** 11 steps (0 to 10)
- **Colorbar :** Off, On
[59.94Hz/60Hz] : SMPTE
[50Hz] : Full Bar
- **Scene:** Full Auto, Scene1, Scene2
- **HDMI/SDI output format:**

Frequency	50Hz	59.94Hz	60Hz
Format HDMI	1080/50p	1080/59.94p	1080/60p
	1080/25p	1080/29.97p	1080/30p
	720/50p	720/59.94p	720/60p
	1080/50i	1080/59.94i	1080/60i
Format SDI	1080/50p,	1080/59.94p,	1080/60p,
	1080/25p,	1080/29.97p,	1080/30p,
	720/50p	720/59.94p	720/60p
	1080/50i	1080/59.94i	1080/60i

[USB connection]

Supported devices: Equipped with USB2.0 compatible port.

- **Video output:** USB Video Class Ver1.1
- **Video output format:** H.264 ^{*1}, Motion JPEG, YUV (no compression).
- **Audio output:** USB Audio Class Ver1.0
- **Audio compression format:** Linear PCM, 48 kHz, 16-bit, 2 channels
- **Resolution/Frame rate**

Image	Resolution	Frame rate*1	
		System frequency 59.94 Hz/60 Hz	System frequency 50 Hz
H.264	1920x1080	60 fps	50 fps
	1280x720	30 fps	25 fps
	640x360	15 fps	10 fps
MJPEG	640x360	5 fps	5 fps
	1920x1080	30 fps	25 fps
	1280x720	15 fps	10 fps
YUV	640x360	5 fps	5 fps
		30 fps*2	25 fps*3
		15 fps*2	10 fps*3

*1 : The frame rate may be lower than the setting depending on the operating conditions.

*2 : On the Web User Interface, if you select **Setup > Basic > Priority Mode > HDMI/USB**, the frame rate will be set as 15 fps. Should you choose **Setup > Basic > Priority Mode > USB (Video Conference)**, the frame rate will be set as 30 fps.

*3 On the Web User Interface, if you select **Setup > Basic > Priority Mode > HDMI/USB**, the frame rate will be set as 10 fps. Should you choose **Setup > Basic > Priority Mode > USB (Video Conference)**, the frame rate will be set as 25 fps.

[IP streaming]

Video compression format: Motion JPEG, H.264, H.265.

- **Transfer mode**

Image	Resolution	Frame rate* ¹	
		System frequency 59.94 Hz/60 Hz	System frequency 50 Hz
Motion JPEG	1280x720	10 fps	10 fps
	640x360	30 fps/10 fps	25 fps/10 fps
H.264/H.265	1920x1080	60 fps	50 fps
	1280x720	30 fps	25 fps
	640x360	15 fps 5 fps	10 fps 5 fps

*1: The frame rate may be lower than the setting depending on the operating conditions.

- **Audio compression mode**

Audio compression format: AAC-LC, 48 kHz, 16 bit, 2 channels.

- **Supported protocol**

IPv4	TCP/IP, UDP/IP, HTTP, RTSP, RTP, RTP/RTCP, DHCP, DNS, ICMP, ARP, RTMP, RTMPS, NTP
IPv6	TCP/IP, UDP/IP, HTTP, RTSP, RTP, RTP/RTCP, DNS, ICMPv6, NTP

- **AC adaptor**

Input: 100 V to 240 V AC (~), 50/60 Hz, 1.2A
Output: 12 V DC (==), 3.0 A, 36 W



Indicates safety information.

Inrush current, measured according to European standard EN55103-1, on initial switch-on: 4.5 A, after a supply interruption of 5 s: 16 A

Index

3	
3200K.....	86
5	
5600K.....	45, 86
A	
Abbreviations	8
Access level	98
Accessories.....	18
Advanced Operations	43
AGC Max Gain.....	49, 66, 85
Ambient operating temperature	119
ATW	45, 86
Audio.....	79
Audio compression	121, 122
Audio output.....	121
Authentication	97
AWB	44
AWB A.....	44, 86
AWB B.....	44, 86
B	
Back Light COMP	53, 86
Back light COMP.....	66
Backlight compensation.....	114
Basic Settings	76
C	
Camera	48
Camera Menu	46, 48, 66
Camera Title.....	77
Characteristics	16
Chroma level.....	113
Chroma Level.....	66, 85
Codec.....	80
Color bar	120
Color Bar	60, 67
Contrast	53, 66, 86, 114
D	
Default Gateway	64, 68, 100, 101
Default Reset	109
Detail	66, 86, 114
DHCP	99
Digital Zoom	58
Dimensions	119
DNR	53, 66, 86
DNS.....	100
Drop-prevention wire.....	18
DRS.....	53, 66, 86
E	
Easy IP setup Software.....	29
Easy IP Setup Software	19, 31, 32
F	
Format.....	56, 91
Frame rate	80, 122
Frequency	55, 67, 92
Full Auto	49, 66
FW Version	63
G	
Gain.....	50, 66, 85, 120
H	
H.264.....	80, 122
H.265.....	80, 122
humidity ranges.....	119
I	
Image	79, 82, 113, 122
Image capture size.....	80
Image display	14
Image sensor	120
Initial Account.....	33
Initialize	65, 68
Install Position.....	57, 67, 92
IP Address.....	64, 68, 99, 101
IP image.....	118

IP Network.....	68
IPv4.....	99, 122
IPv6.....	101, 122
J	
JPEG.....	79, 122
L	
LAN connector.....	21
LAN indicator.....	21
Language.....	63, 68, 106
Len.....	120
Lens.....	21
Live Page.....	77
L-Mount kit.....	18
M	
MAC address.....	107
MAC Address.....	64, 68
Main Menu.....	48
Maintenance.....	48, 63, 106
Max bit rate.....	80
Memory.....	14
Mic.....	60, 67
Model no.....	107
N	
Network.....	99, 122
Network security.....	15
Network Setting.....	29, 99
Network settings.....	32
O	
Operating Precautions.....	19
Operating temperature.....	19
Operation time.....	107
Operations Table.....	46
Optional Accessories.....	18
OSD.....	60, 95
OSD Menu.....	72
OSD off with Tally.....	67
OSS license.....	107
Output.....	91

P	
Pan.....	120
Password.....	98
Picture Level.....	49, 66, 84
PoE.....	19, 119
PoE power supply.....	19, 119, 122
Power.....	73
Power off.....	36
Power on.....	36
Power status indicator.....	21
Preset.....	74
Preset Memories.....	43
Preset Position.....	87
Primary server address.....	101
Primary Server Address.....	100
Priority mode.....	67
Priority Mode.....	37, 54, 76
Product Info.....	107
protocol.....	122
R	
Reboot.....	109
Remote control ID.....	21
Resolution.....	122
RTMP.....	72, 103
RTMPS.....	122
S	
Scene.....	49, 66, 120
Scene Mode.....	39
Secondary server address.....	101
Secondary Server Address.....	100
Serial no.....	107
Setup Screen.....	75
Shooting Operation.....	35
Shutter priority.....	66
Shutter Priority.....	49
Shutter speed.....	120
Slow Shutter.....	50, 66, 85
Specification.....	119
Storage temperature.....	119
Stream Key.....	103

Stream transmission	80
Subnet Mask	64, 68, 99
System	48, 54, 91
T	
Tally.....	59, 60, 67, 94
tilt 120	
Transfer mode.....	122
Troubleshooting	115
U	
URL	103
Usage restrictions	15
USB.....	37, 118
USB Cable	18
USB connection	121
USB terminal.....	21
User authentication	97
User Check	98
User Management	97
User name	97

V	
Video	117
Video output.....	121
Video over IP	79
W	
Web Live Screen.....	72
Web Screen	69
Web Screen Configuration.....	75
Weight.....	119
White balance	113, 120
White Balance.....	44, 86
White Balance Mode.....	66
Wireless ID	95
Wireless Control.....	95
Wireless ID.....	60, 67
Wireless Remote Control.....	25
Z	
Zoom	73, 114, 120
Zoom In/Out.....	41
Zoom Speed.....	41

Panasonic Connect Co., Ltd.

Web Site: <https://pro-av.panasonic.net/en/>

© Panasonic Connect Co., Ltd. 2022