

ATDM-0604a

User Manual DIGITAL SMARTMIXER

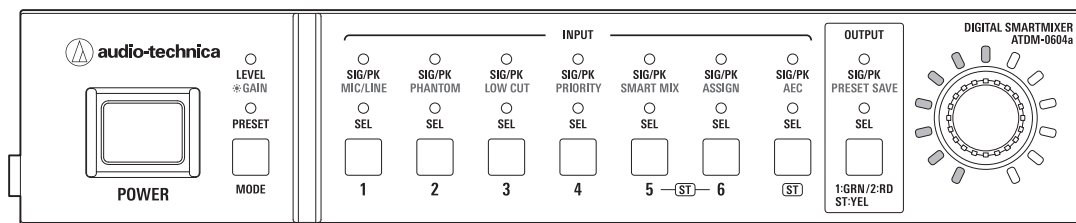

Introduction

Thank you for purchasing this Audio-Technica product.

Before using the product, read through this user manual to ensure that you will use the product correctly. Please keep this manual for future reference.

Checking the package contents

Before use, check to make sure that all of the following items are contained in the package.

If any of the items is missing from your package or damaged, contact your local Audio-Technica dealer.

- ATDM-0604a unit
- Euroblock connector ×11
- Rack-mount (large, small)
- Rack-mount screw ×6
- Power cable
- Rubber feet ×4
- Quick Start Guide

Trademarks

- SMARTMIXER™ is a trademark or registered trademark of Audio-Technica Corporation.
- Apple and the Apple logo are trademarks of Apple Inc., registered in the U.S. and other countries.
- iOS is a trademark or registered trademark of Cisco in the U.S. and other countries.
- App Store is a service mark of Apple Inc.
- Google, the Google logo, Google Play, the Google Play logo, and Android™ are trademarks or registered trademarks of Google Inc.
- All other company and product names that appear in this document are trademarks or registered trademarks of their respective owners.

Safety precautions

Important information





Warning:

To prevent fire or shock hazard, do not expose this apparatus to rain or moisture.

Caution:

- Do not expose this apparatus to drips or splashes.
- To avoid electric shock, do not open the cabinet.
- Refer servicing to qualified personnel only.
- Do not expose this apparatus to excessive heat such as sunshine, fire or the like.
- Do not subject this apparatus to strong impact.
- This apparatus should be located close enough to the AC outlet so that you can easily grasp the power cord plug at any time.
- In case of emergency, disconnect the power cord plug of this apparatus quickly.
- Do not place any objects filled with liquids, such as vases, on this apparatus.
- To prevent fire, do not place any naked flame sources (such as lighted candles) on this apparatus.
- Do not install this apparatus in a confined space such as a bookcase or similar unit.
- Install this apparatus only in the place where ventilation is good.
- This apparatus is not disconnected from the mains as long as it is connected to the AC outlet, even if the unit itself has been turned off.
- Keep the product out of the reach of small children. The product is not intended for use around children.
- Do not place the product near fire to avoid an accident or the product catching fire.

For customers in the USA/Canada

	CAUTION RISK OF ELECTRIC SHOCK DO NOT OPEN	
Caution: To prevent electric shock, do not remove the cover. There are no user-serviceable parts inside. Internal adjustments are for qualified professionals only. Refer all servicing to qualified service personnel.		
	The lightning flash with arrowhead symbol, within an equilateral triangle, is intended to alert the user to the presence of uninsulated "dangerous voltage" within the product's enclosure that may be of sufficient magnitude to constitute a risk of shock to persons.	
	The exclamation point symbol within an equilateral triangle is intended to alert the user to the presence of important operating and maintenance (servicing) instructions in the literature accompanying the product.	

Important safety instructions

- 1) Read these instructions.
- 2) Keep these instructions.
- 3) Heed all warnings.
- 4) Follow all instructions.
- 5) Do not use this apparatus near water.
- 6) Clean only with dry cloth.
- 7) Do not block any of the ventilation openings. Install in accordance with the manufacturer's instructions.
- 8) Do not install near any heat sources such as radiators, heat registers, stoves, or other apparatus (including amplifiers) that produce heat.
- 9) Do not defeat the safety purpose of the polarized or grounding plug. A polarized plug has two blades with one wider than the other. A grounding plug has two blades and a third grounding prong. The wide blade or the third prong is provided for your safety. If the provided plug does not fit into your outlet, consult an electrician for replacement of the obsolete outlet.
- 10) Protect the power cord from being walked on or pinched particularly at plugs, convenience receptacles, and the point where they exit from the apparatus.
- 11) Only use attachments/accessories specified by the manufacturer.
- 12) Use only with a cart, stand, tripod, bracket, or table specified by the manufacturer, or sold with the apparatus.
- 13) When a cart is used, use caution when moving the cart/apparatus combination to avoid injury from tip-over.
- 14) Unplug this apparatus during lightning storms or when unused for long periods of time.
- 15) Refer all servicing to qualified service personnel. Servicing is required when the apparatus has been damaged in any way, such as power-supply cord or plug is damaged, liquid has been spilled or objects have fallen into the apparatus, the apparatus has been exposed to rain or moisture, does not operate normally, or has been dropped.



Safety precautions

FCC notice

Warning:

This device complies with Part 15 of the FCC Rules. Operation is subject to the following two conditions: (1) This device may not cause harmful interference, and (2) this device must accept any interference received, including interference that may cause undesired operation.

Caution:

You are cautioned that any changes or modifications not expressly approved in this manual could void your authority to operate this equipment.

Note:

– This equipment has been tested and found to comply with the limits for a Class B digital device, pursuant to part 15 of the FCC Rules. These limits are designed to provide reasonable protection against harmful interference in a residential installation. This equipment generates, uses and can radiate radio frequency energy and, if not installed and used in accordance with the instructions, may cause harmful interference to radio communications. However, there is no guarantee that interference will not occur in a particular installation. If this equipment does cause harmful interference to radio or television reception, which can be determined by turning the equipment off and on, the user is encouraged to try to correct the interference by one or more of the following measures:

- Reorient or relocate the receiving antenna.
- Increase the separation between the equipment and receiver.
- Connect the equipment into an outlet on a circuit different from that to which the receiver is connected.
- Consult the dealer or an experienced radio/TV technician for help.

Contact:

Responsible Company: Audio-Technica U.S., Inc. Address: 1221 Commerce Drive, Stow, Ohio 44224, USA Tel: 330-686-2600

For customers in Canada

ISED statement

CAN ICES-003(B)/NMB-003(B)

Notes on use

- When using the product, also read the user manuals supplied with the devices that are to be connected.
- When not using the product, remove the power plug from the power outlet.
- Turn the product off before connecting or disconnecting cables.
- If you use the product near a TV or radio antenna, noise may be generated in the TV or radio. In this case, move the product away from the TV or radio antenna.

Maintenance

- If the product becomes dirty or dusty, disconnect the power plug first, and then wipe the product off with a dry soft cloth.
- Do not use benzene, thinner, contact restoring protective agent, or any other chemical agent. Doing so may cause deformation, damage, or malfunction.
- When storing the product for an extended period of time, wrap it with a plastic cover, and do not allow it to be exposed to humidity.

Features

Features of ATDM-0604a

- 6 mic/line inputs and 1 unbalanced stereo input, implementing high-quality mic preamplifier with discrete amplifier
- Flip function allows switching between balanced and unbalanced outputs in stereo units. 1 unbalanced output can be output at microphone level
- USB audio I/O (1 stereo input and 1 stereo output)
- Built-in SmartMixer that allows for a selection between gain sharing and gate modes
- 6 microphone inputs with AEC for simultaneous use
- Simultaneous use with noise canceller (1 unit) possible
- 4-band EQ, comp/de-esser on each input, 12-band EQ on each output
- Comp and limiter on each input and output system. Pre/Post Fader selectable for each output
- 8-band feedback suppressors can be inserted into inputs and outputs (up to 8 units)
- Audio input/output settings can be configured on the front panel, whereas the advanced settings can be configured on a computer using Web Remote.
- Allows for external control with IP Remote Protocol
- Up to one ES954 hanging array microphone (sold separately) can be connected to the microphone input
- Supports external muting of the ES954 hanging microphone from the mixer and can be set from a PC using the web remote
- Equipped with a ducking function

About Audio-Technica LINK

This product can daisy-chain up to eight ATDM-0604a units to support 48 mic/line inputs and 8 unbalanced stereo audio inputs for the entire system. The proprietary Audio-Technica LINK functionality enables the transmission of low-latency, high-speed audio bus signals between devices, making it possible to steadily control and transmit uncompressed audio signals.

Furthermore, the model offers excellent workability as it conforms to the Ethernet standards and can be connected to generic LAN cables (shielded cables of Cat5e or above with the conductor diameter size of 24 AWG or larger must be used).

System installation

Installing on a rack

The product can be installed using the supplied rack-mount.

- When installing this product in a rack, ensure that the temperature inside the rack does not exceed 40°C. This will adversely affect the internal components and cause malfunctions.
- Ensure at least a 10-centimeter space between the product and other devices or the top, side, and back faces of the rack.
- The required rack specifications are as follows.
 - EIA-standard 19-inch rack
 - 1U-size attachable rack
 - Rack with a shelf on which the product is placed or a guide rail that supports the product

- The rack mounts are affixed to the product with the following screws. Check the following when using screws other than those supplied.
 - S-tight (tapping screw), nominal diameter 4 × 6 mm

System installation

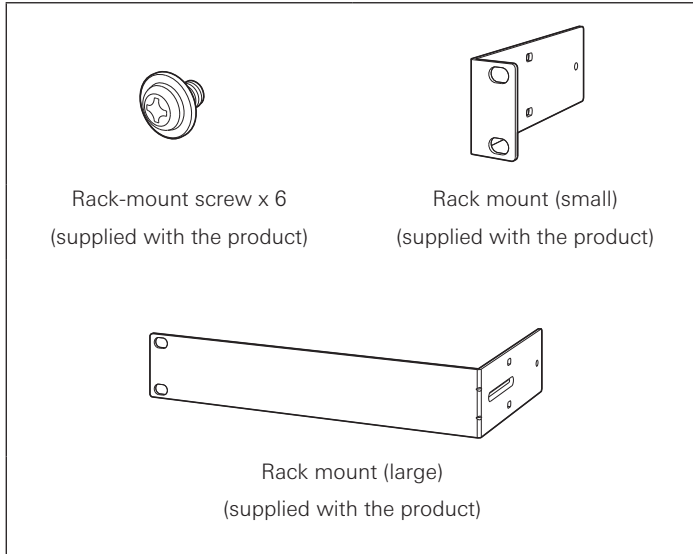

1. Attach the rack mounts to the product.

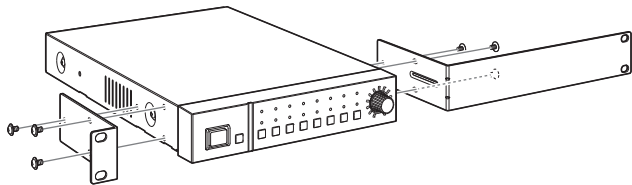

2. Install the product on the rack.

- To install the product on the rack, use the screws supplied with the rack or commercially available screws.

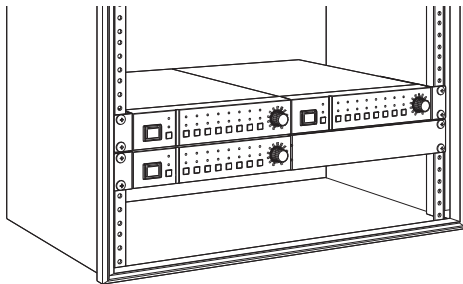

System installation

Unbalanced connection

An unbalanced connection tends to be subject to induction noise caused by the chassis potential differences. Be sure to match the chassis potentials between devices.

- Match the power supply phases between devices.
- Standardize the power supply systems.
- Connect the GND (ground) terminal or chassis of each device.

Power cable connection

- Connect the power plug to the appropriate outlet with protective grounding. Electric shock may result if the plug is not grounded securely.

How to connect a Euroblock connector

1. As shown in the figure, expose the wires inside the cable.
 - Do not solder the stranded wires.

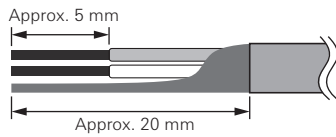

4. Tighten the screws and bundle the wires with a cable tie.

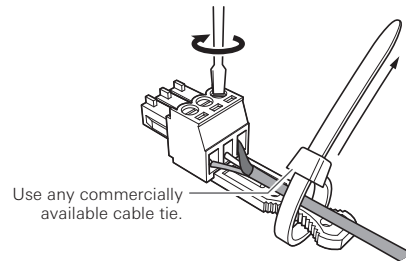

2. Loosen the screws with a flathead screwdriver.

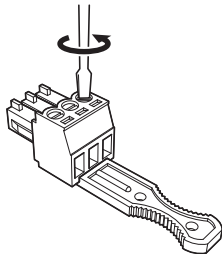

5. Connect the Euroblock connector to the product.

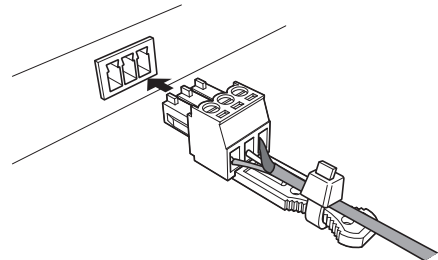

3. Verify the pin assignments, and connect each to the applicable wire.

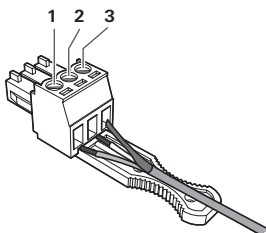

- Pin assignments

		1	2	3
INPUT	1 to 6	+: HOT	-: COLD	G: GND
	ST	R: RIGHT	L: LEFT	G: GND
OUTPUT	1/L, 2/R	+: HOT	-: COLD	G: GND
	UNBAL	R: RIGHT	L: LEFT	G: GND

System connection examples

Local discussion (Preset #2)

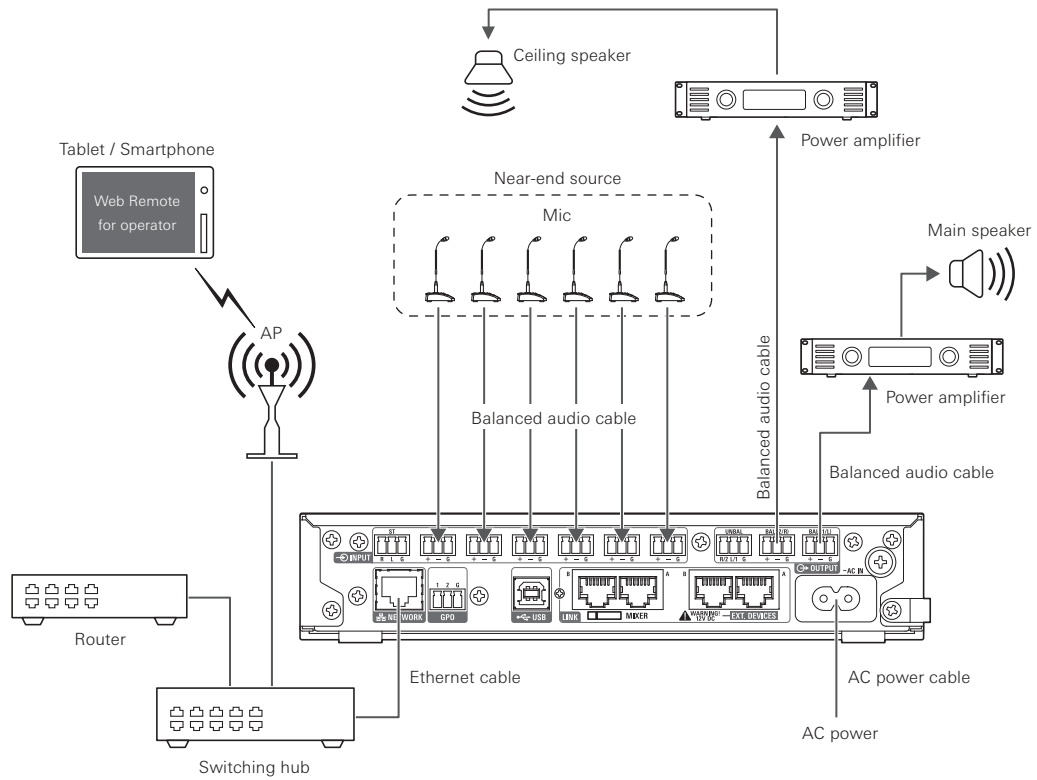

System connection examples

Remote discussion - web conference (Preset #3)

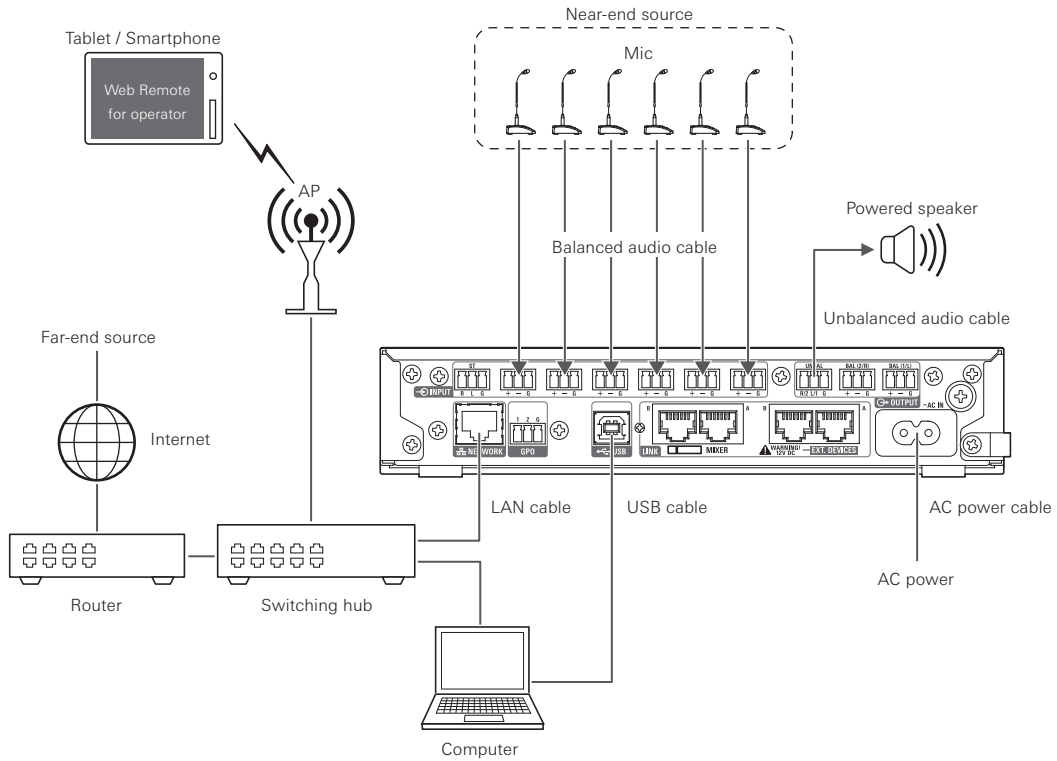

Remote discussion - video conference (Preset #4)

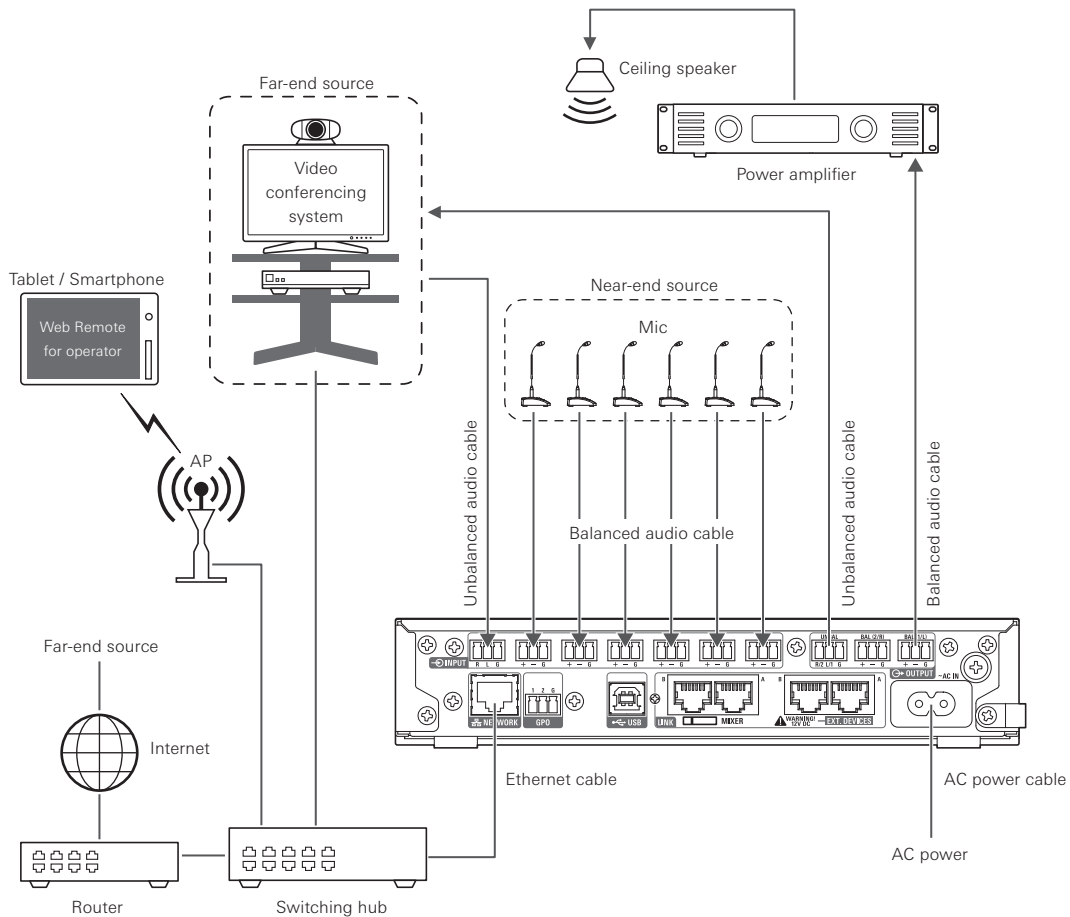

Part names and function

Front Panel

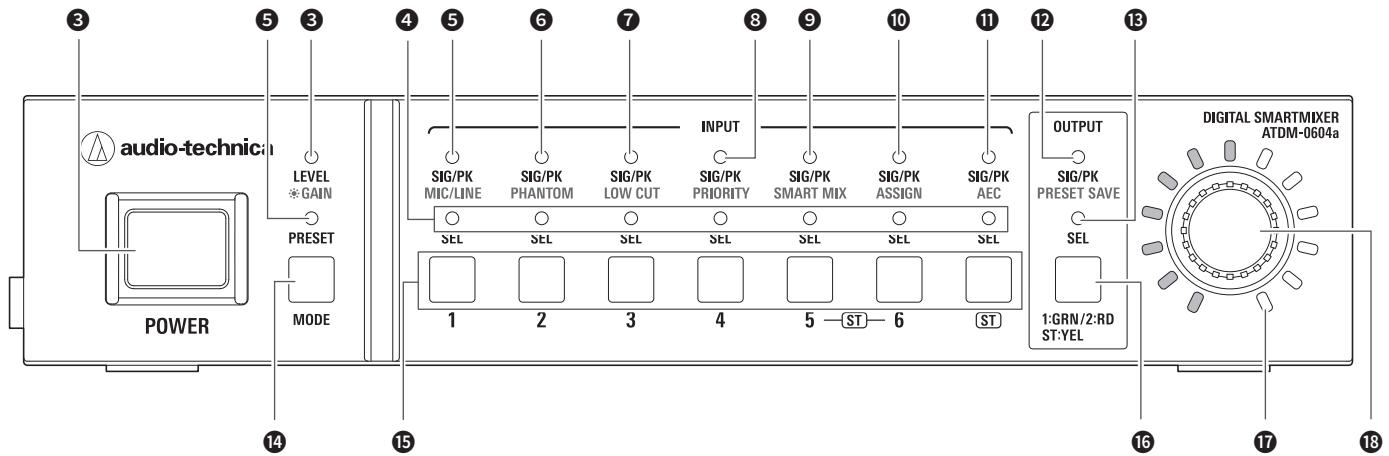

- 1 Power button**
Turns on/off the power to the product.
- 2 PRESET LED**
Lights and blinks when the power is turned on and indicates that the product is being started.
Lights when a preset is being recalled.
- 3 LEVEL-GAIN LED**
Lit: You can adjust the input level and output level.
Blinking: You can adjust the gain.
- 4 INPUT SEL LED**
Indicates the input channel, preset bank number, and the status of the function/setting of each channel.
- 5 SIG/PK-MIC/LINE LED**
Indicates the signal level of input channel 1 when the level or gain is being adjusted.
Also lights when the input type is changed (MIC/LINE).
- 6 SIG/PK-PHANTOM LED**
Indicates the signal level of input channel 2 when the level or gain is being adjusted.
Also lights when on/off of the phantom power is set.
- 7 SIG/PK-LOW CUT LED**
Indicates the signal level of input channel 3 when the level or gain is being adjusted.
Also lights when on/off of the low-cut is set.
- 8 SIG/PK-PRIORITY LED**
Indicates the signal level of input channel 4 when the level or gain is being adjusted.
Also lights when on/off of the priority is set.
- 9 SIG/PK-SMART MIX LED**
Indicates the signal level of input channel 5 when the level or gain is being adjusted.
Also lights when on/off of the SmartMixer is set.
- 10 SIG/PK-ASSIGN LED**
Indicates the signal level of input channel 6 when the level or gain is being adjusted.
Also lights when on/off of the output bus assignment is set.
- 11 SIG/PK-AEC LED**
Indicates the signal level of input channel ST when the level or gain is being adjusted.
Also lights when on/off of the AEC is set.
- 12 SIG/PK-PRESET SAVE LED**
Indicates the signal level of an output channel when the level or gain is being adjusted.
Also lights when a preset is saved.
- 13 OUTPUT SEL LED**
Indicates if an output channel is selected.
- 14 MODE button**
Selects a function.
- 15 INPUT SEL button**
Selects an input channel or preset number.
- 16 OUTPUT SEL button**
Selects the output channel. Lights green for Output 1, red for Output 2, or yellow for Output ST.
- 17 Volume LED**
Indicates the current setting of the selected channel when the level or gain is being adjusted.
- 18 Dial button**
Turn the dial button to select, and push to confirm the selection.

Part names and function

- An LED can be in one of five statuses.

- (1) Lit: Indicates that a function is selected and enabled, etc.
- (2) Off: Indicates that a function is not selected and disabled, etc.
- (3) Blinking: Indicates that a function is being selected. Repeats every 500 ms until the status changes.
- (4) Blinking fast: Indicates that the operation has been rejected. Repeats blinking five times every 200 ms.
- (5) Dimmer lit: Indicates lower brightness.

- The signal level ranges indicated by the SIG/PK LEDs are as follows.

- LED lit (red): 0 dBFS to -5 dBFS
- LED lit (yellow): -6 dBFS to -24 dBFS
- LED lit (green): -25 dBFS to -59 dBFS
- LED off: -60 dBFS or less

Rear panel

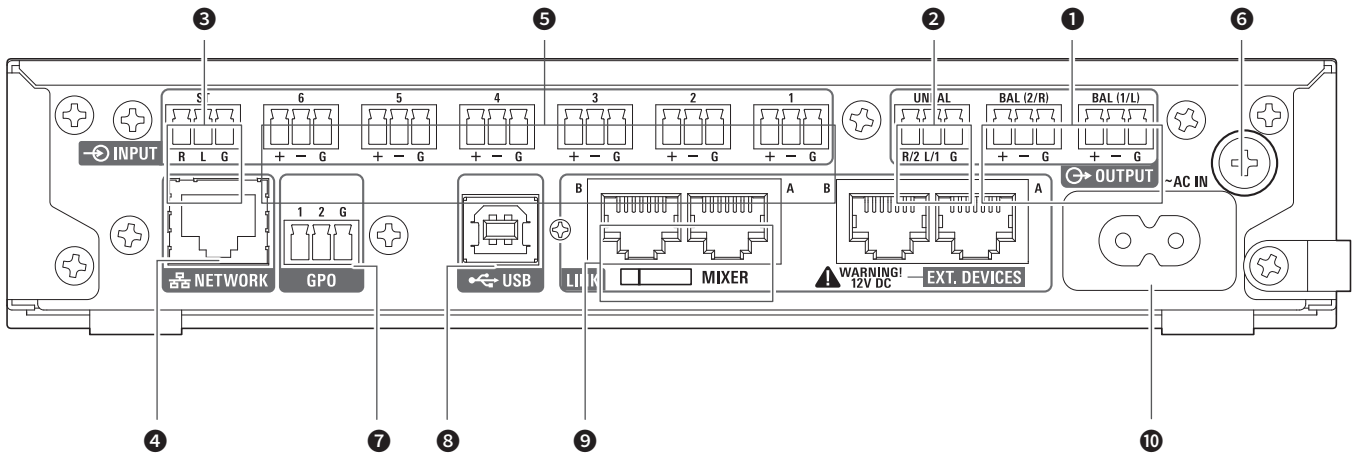

1 Unbalanced input terminal (ST)

An unbalanced input port. Connect an unbalanced cable. Pin assignments are as follows. 1: STEREO R 2: STEREO L and 3: GND.

2 Balanced input terminals (MIC/LINE)

A balanced input port. Connect a balanced cable. The input type setting (MIC/LINE) can be changed. Pin assignments are as follows. 1: HOT, 2: COLD, and 3: GND.

3 Unbalanced output terminal (UNBAL)

An unbalanced output port. Connect an unbalanced cable. Pin assignments are as follows. 1: STEREO R/2 2: STEREO L/1 and 3: GND.

4 Balanced output terminals (BAL 1/L and 2/R)

A balanced output port. Connect a balanced cable. Pin assignments are as follows. 1: HOT, 2: COLD, and 3: GND.

5 Screws for grounding

The supplied power cable is a 2-core cable, and cannot be used for grounding. Ground the product as necessary.

6 NETWORK terminal

A NETWORK port. Connect an Ethernet cable (Cat5e or above).

7 GPO terminals

General-purpose output pin. Pin assignments are 1: GPO1, 2: GPO2, G: GND.

8 USB terminal

A USB port (USB Type B). Connect a USB cable.

9 LINK A/B terminals

A LINK A/B port. Used for Audio-Technica LINK. Connect LAN cable (CAT5e or higher, conductor size 24AWG diameter or larger, shielded must be used).

10 AC Inlet

Connect the power cable.

Using the product

Starting the product

1. Press the power button.

- The PRESET LED lights, blinks, and LEVEL-GAIN LED turns on. Then, the PRESET LED turns off, and the product starts in operator mode.

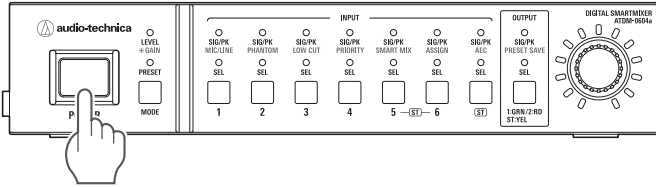

2. The volume LED lights according to the IP Config Mode setting.

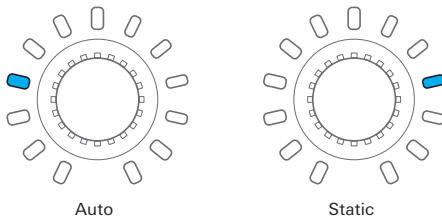

Front panel mode

The following two modes are available when operating the product with the buttons and the dial on the front panel.

Operator mode:

In this mode, daily operations are performed, such as loading the preset settings and adjusting the audio level.

Advanced mode:

In this mode, advanced settings can be configured by installing and implementing the product on-site.

- When the power is turned on, the product usually starts in operator mode. This prevents accidental device setting changes or other troubles, and ensures a safe operation of the system.

Switch front panel mode (operator mode/advanced mode)

Change between operator mode and advanced mode.

1. While pressing the MODE button, press and hold the dial button (for 1 or more seconds).

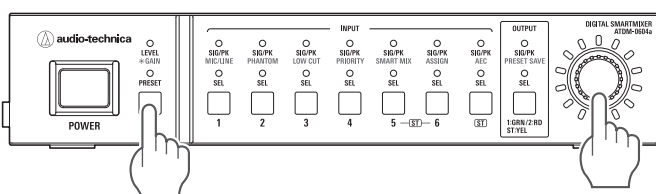

2. LEDs light/blink/turn off, and the front panel mode changes.

- When changing to operator mode
 - The LEVEL-GAIN LED and the PRESET LED light.
 - The PRESET LED turns off.
 - The front panel mode changes to operator mode.

- When changing to advanced mode

- The LEVEL-GAIN LED, the PRESET LED, and the LEDs from SIG/PK-MIC/LINE to SIG/PK-PRESET SAVE become lit.
- All LEDs turn off except the LEVEL-GAIN LED, which blinks.
- The front panel mode changes to advanced mode.

Selecting a function

Press the MODE button, or turn the dial button while pressing the MODE button, to select the function.

- Determine the function selected based on the LED that lights (LEVEL-GAIN LED and PRESET LED, or an LED from SIG/PK-MIC/LINE to SIG/PK-PRESET SAVE).

Functions available in operator mode

Start of function selection



Functions available in advanced mode

Press the MODE button to change the function in the clockwise direction as shown in the figure. While pressing the MODE button, turn the dial button to change the function to the one in the direction of the dial.

Start of function selection

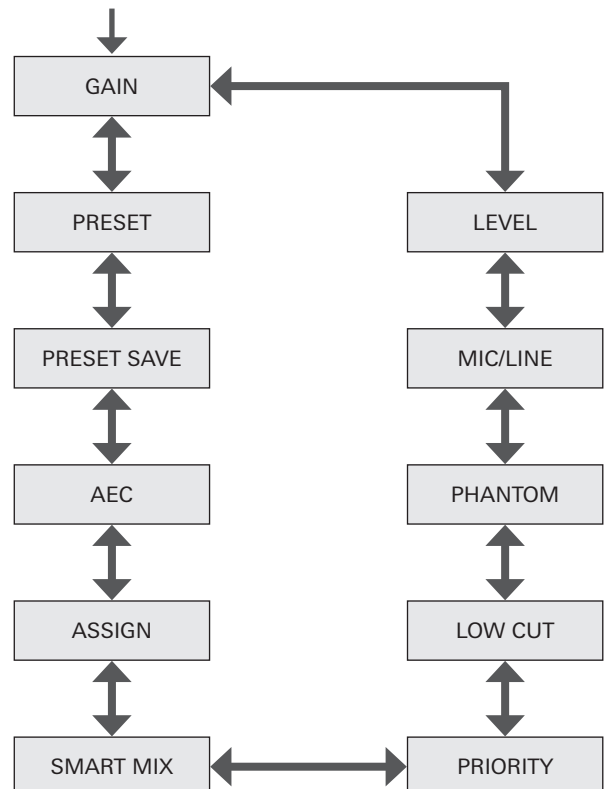

Using the product

Operations that can be performed in operator mode/advanced mode

Recalling a preset

Recall saved preset data to change the current setting.

1. **Select "PRESET".**
 - The PRESET LED lights.
2. **Push the INPUT SEL button to select the preset data to recall (from 1 to 6).**
 - The INPUT SEL LED and the volume LED light.
3. **Press the dial button.**
 - The preset data is read and the settings change.

Adjusting the input level

Set the input level to MIC or LINE. If "LINE" input type is selected, PAD (a function to attenuate the input signal by a certain level) is entered.

1. **Select "LEVEL."**
 - The LEVEL-GAIN LED lights.
 - The SIG/PK LED of each input channel becomes lit based on the input level.
2. **Press the INPUT SEL button to select the input channel you want to adjust.**
 - The INPUT SEL LED lights, and the volume LED lights according to the setting.
 - The volume LED that indicates the 0 dB (-20 dBFS) point blinks.
3. **Turn the dial button to adjust the input level.**
 - The volume LED becomes lit/turns off based on the adjusting operation.
 - When the level is at the 0 dB (-20 dBFS) point, the blinking volume LED becomes lit.

Adjusting the output level

Set the output level.

1. **Select "LEVEL."**
 - The LEVEL-GAIN LED lights.
 - The SIG/PK LED of the output channel becomes lit based on the output level.
2. **Push the OUTPUT SEL button to select the output channel you want to adjust.**
 - The color of the OUTPUT SEL LED changes, and it lights according to the selected output channel (OUTPUT 1: Green, OUTPUT 2: Red, OUTPUT ST: Yellow). The volume LED lights according to the setting.
 - The volume LED that indicates the 0 dB (-20 dBFS) point blinks.
3. **Turn the dial button to adjust the output level.**
 - The volume LED becomes lit/turns off based on the adjusting operation.
 - When the level is at the 0 dB (-20 dBFS) point, the blinking volume LED becomes lit.

Operations available only in advanced mode

Change to advanced mode to perform these operations.

Changing the input type (MIC/LINE)

Specify the input type. Only input channel 5 and input channel 6 can be set.

1. **Select "MIC/LINE."**
 - The SIG/PK-MIC/LINE LED lights.
2. **Press the INPUT SEL button to change the input type between MIC and LINE (+4dBu).**
 - The INPUT SEL LED lights when LINE is selected, and it turns off when MIC is selected.
 - Input channels 1 to 4 switch to LINE (-10 dBV), and input channels 5 and 6 switch to LINE (+4 dBV).

Adjusting the gain

Set the input gain for MIC input.

1. **Select "GAIN."**
 - The LEVEL-GAIN LED blinks.
 - The SIG/PK LED of each input channel becomes lit based on the input level.
2. **Press the INPUT SEL button to select the input channel you want to adjust.**
 - The INPUT SEL LED lights, and the volume LED lights according to the setting.
 - The volume LED that indicates the -40 dB point blinks (only when "MIC" is selected as the input type).
3. **Turn the dial button to adjust the gain.**
 - The volume LED becomes lit/turns off based on the adjusting operation.
 - When the level is at the -40 dB point, the blinking volume LED becomes lit.

• During gain adjustment, press the dial button to switch the volume LED display between gain setting value and level meter. Change the display as necessary. Also, the unity level of each audio output can be switched using the OUTPUT SEL button and dial button.

Turning the phantom power ON/OFF

Turn on/off the phantom power (+48V). This setting can be made only when the input type is set to "MIC".

1. **Select "PHANTOM."**
 - The SIG/PK-PHANTOM LED lights.
2. **Press the INPUT SEL button to switch the phantom power between ON and OFF.**
 - The INPUT SEL LED lights when the phantom power is turned on, and it turns off when the phantom power is turned off.

Saving a preset

Save the current settings as a preset.

1. **Select "PRESET SAVE".**
 - The SIG/PK-PRESET SAVE LED lights.
 - If a preset is currently recalled, the INPUT SEL LED of that preset number becomes lit.
2. **Press the INPUT SEL button to select the saving location (from PRESET 1 to PRESET 6).**
 - The INPUT SEL LED and the volume LED blink.
3. **Press the dial button.**
 - The preset is saved to the specified saving location.

Using the product

Turning the low-cut ON/OFF

Specify whether or not to remove low frequencies from the audio signal.

1. Select "LOW CUT".
 - The SIG/PK-LOW CUT LED lights.
2. Press the INPUT SEL button to switch the low-cut between ON and OFF.
 - The INPUT SEL LED lights when the low-cut setting is turned on, and it turns off when the low-cut setting is turned off.

Turning the priority ON/OFF

Set the channel priority. The priority can be set only when SmartMixer is turned on, and gate mode is selected.

1. Select "PRIORITY".
 - The SIG/PK-PRIORITY LED lights.
2. Press the INPUT SEL button to switch the priority between ON and OFF.
 - The INPUT SEL LED lights when the priority is turned on. The INPUT SEL LED turns off when the priority is turned off.

Turning SmartMixer enable/disable

Switch SmartMixer between enable/disable.

Set SmartMixer mode (gate mode or gain sharing mode) via Web Remote (p.53).

1. Select "SMART MIX".
 - The SIG/PK-SMART MIX LED lights.
2. Press the INPUT SEL button to switch the SmartMixer between enable/disable.
 - INPUT SEL LED lit:
The Smart Mixer is enabled and its channels mix audio in gated or gain-share mode.
 - INPUT SEL LED off:
Smart Mixer is invalid.

Setting the bus assignment

Assign and confirm the output bus for an input channel.

1. Select "ASSIGN".
 - The SIG/PK-AEC LED lights.
2. Press the OUTPUT SEL button to select the output bus to be assigned and confirmed.
 - If the INPUT SEL LED is lit, the channel is assigned to the selected output bus. If the light is off, it is not assigned.
 - Press the INPUT SEL button to switch the bus assignment.
INPUT SEL LED lit:
Assigned to the output bus. Even when the Smart Mixer is on, the audio signal is output through the Smart Mixer.
INPUT SEL LED blinking:
Assigned to the output bus. Audio signals processed by SmartMixer are output when SmartMixer is turned ON.
INPUT SEL LED off:
Not assigned to any output bus.

Turning the AEC ON/OFF

Turn on/off the AEC (Acoustic Echo Canceler).

1. Select "AEC".
 - The SIG/PK-AEC LED lights.
2. Press the INPUT SEL button to switch the AEC between ON and OFF.
 - The INPUT SEL LED lights when the AEC is turned on, and it turns off when the AEC is turned off.
 - Press the INPUT SEL button for the input channel ST to switch the AEC mode.
INPUT SEL LED of input channel ST lights up. AEC with NC
INPUT SEL LED of input channel ST blinks. Noise Canceling
INPUT SEL LED of input channel ST goes off. OFF

Changing the IP config mode (Auto/Static)

Specify how to obtain the IP address.

1. Press the power button.
 - The PRESET LED becomes lit.
2. When the PRESET LED starts blinking, press down the MODE button, the INPUT SEL button for INPUT channel 4 and the OUTPUT SEL button.
3. When the LEVEL LED becomes lit, release the MODE button, the INPUT SEL button for INPUT channel 4, and the OUTPUT SEL button.
4. The volume LED lights according to the IP Config Mode setting.

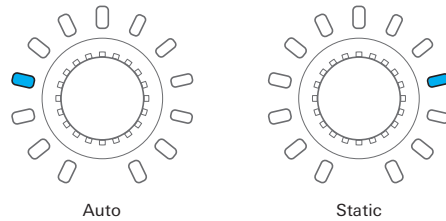

5. Turn the dial button and change the IP Config Mode.
6. Restart the product.

Web Remote

What Is Web Remote?

Web Remote is a web-based application for controlling this product. The following items can be remotely controlled from Windows PCs, Macs, iOS devices, and Android devices (hereinafter referred to as "control devices").

- Check the status of the product
- Change the various settings of the product

What is "Locate"?

"Locate" is a launcher application for Web Remote. Connect your control device, then activate "Locate". With "Locate", you can quickly access Web Remote without entering the IP address assigned to the product.

- You can also launch Web Remote without using "Locate".

Recommended environment

OS supporting Web Remote and "Locate"

- Microsoft Windows 10 or later
- macOS Big Sur or later
- Android OS 5.0 or later
- iOS 9 or later

Recommended web browsers for Web Remote

- Microsoft Edge 96 or later (Windows)
- Google Chrome ver. 57 or later (Windows and Android)
- Safari 10 or later (OS X and iOS)

- You can log into Web Remote from up to 3 control devices at the same time. If two different web browsers are running on one control device, Web Remote recognizes access from two control devices.
- To exit Web Remote, make sure to log out first, and then close the web browser screen. If the screen is closed without logging out, the session may continue, and you may remain logged into Web Remote.
- The minimum size of the web remote screen is 1024 x 768 pixels. For the control device, use a large enough display monitor to display the Web Remote screen in the web browser.

Preparing Web Remote

Connect a control device to the product

1. Before connecting a control device to the product, network settings for both devices must be performed.
 - If IP addresses are obtained automatically when connecting
 - (1) Set the product's IP Config Mode to "Auto".
 - The product ships from the factory in "Auto" mode.
 - (2) Set the control device's network settings so that it connects to the network.
 - If static IP addresses are used when connecting

- (1) Set the product's IP Config Mode to "Static".
 - The IP address is set to a static value.
The default value is "192.168.33.102".
2. Use a wired or wireless connection to connect the control device to the product.
3. Turn on the control device and the product.
 - If IP addresses are obtained automatically when connecting, it may take some time before the IP address is set.

Setting up "Locate"

1. Download the "Locate" installer/application to the control device.
 - For Windows and Mac:
Download from the Audio-Technica website (www.audio-technica.com) for your country or region.
 - For iOS and Android:
Download from the App Store or Google Play.
Upon completion of the download, proceed to Step 4.
2. Double-click "setup.exe" you have downloaded.
 - The Setup Wizard opens.
3. Follow the on-screen instructions to install "Locate".
 - When installation is complete, the "Locate" icon appears on the desktop.
4. Make sure ATDM-0604a is connected to the same network as the control device and powered on, then double-click on the "Locate" icon.
 - "Locate" launches. The ATDM-0604a connected to the network is automatically detected.
5. Select the ATDM-0604a for which you want to perform Web remote control and click "Open".
 - The Web Remote Login screen appears.

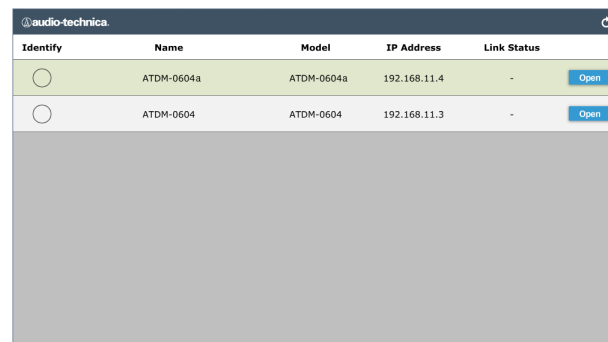

Identify	Name	Model	IP Address	Link Status
<input type="radio"/>	ATDM-0604a	ATDM-0604a	192.168.11.4	- <input type="button" value="Open"/>
<input type="radio"/>	ATDM-0604	ATDM-0604	192.168.11.3	- <input type="button" value="Open"/>

- When the "Identify" icon is clicked, the icon will flash red and the indicators on the front panel of the corresponding ATDM-0604a will flash. Use this if you have more than one ATDM-0604a on your system and want to identify the ATDM-0604a that appears in the "Locate" list.

Web Remote

Overview of Web Remote

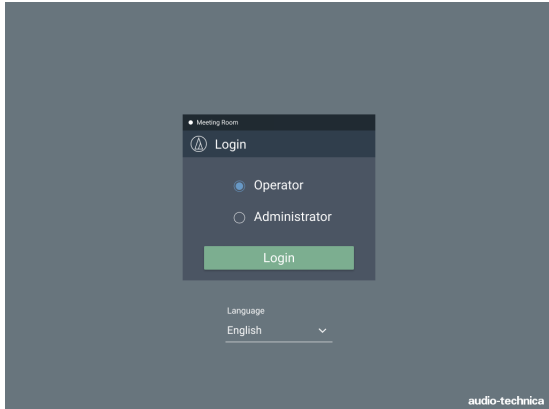

Login screen

Log in as the Operator

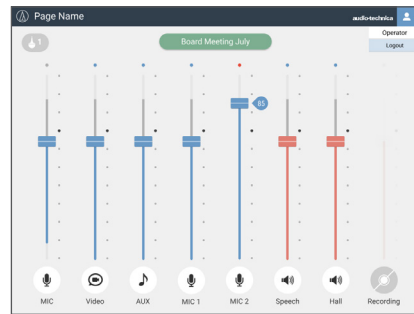

Windows/Mac display

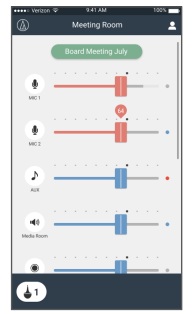

iOS/Android screen

Log in as the Administrator



Audio Settings

- Input:** Set the various options, such as Gain, Level, EQ, and SmartMixer, for audio input from a microphone or other audio devices.
- Output:** Set the various options, such as Level, FBS, EQ, and Dynamics, for audio output.

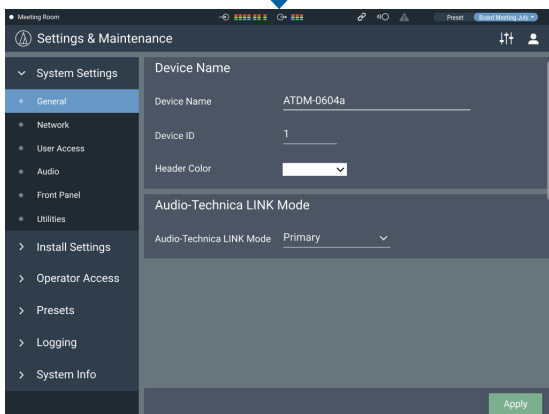

Settings & Maintenance

- System Settings:** Set the options relating to Network, Access Permissions, Audio-Technica LINK, etc., and update the firmware.d
- Operator Access:** Set the various options relating to the operation screens you can access after logging in as the Operator.
- Presets:** Recall and save presets and import/export preset data to/from external devices.
- Logging:** Set the options relating to log messages, and download log messages.
- System Info:** System information, such as the various network settings and the product's serial number and firmware version, is displayed.

• To log in as the administrator, you must use a Windows PC or a Mac computer. Operations using a tablet or a smartphone are not guaranteed.

Launch/Log into Web Remote

Launching Web Remote

Start from "Locate"

1. Launch "Locate" you have installed in the control device.
2. Select the ATDM-0604a you wish to activate the web remote from the list.
 - Web Remote launches, and the Login screen appears.

Specifying an IP address to launch the Web Remote

If you know the IP address of the product, you can launch Web Remote by specifying the IP address directly.

1. Open the control device's web browser.
2. Enter the IP address of the ATDM-0604a from which you want to activate the web remote.
 - Web Remote launches, and the Login screen appears.

Login screen

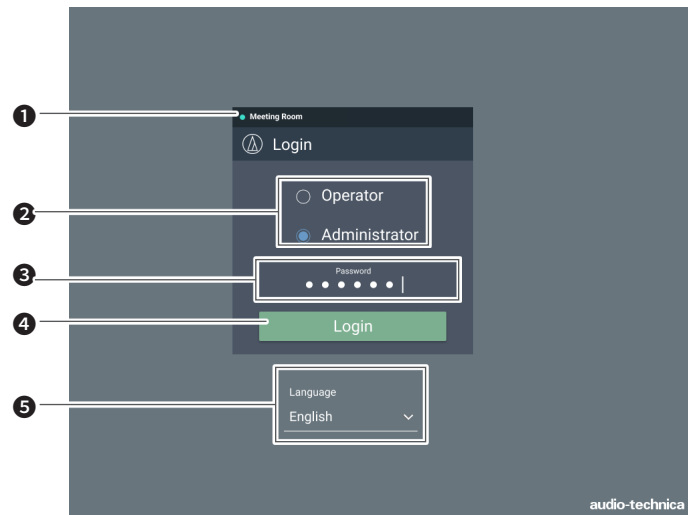

- 1 **Device name**
The name set for the product is displayed.
- 2 **Mode selection**
Select "Operator" or "Administrator" as the login user.
- 3 **Password**
Enter the password.
 - This field appears when login as the Administrator is locked. For the password settings, refer to p.43.
- 4 **Login button**
- 5 **Language**
Select the display language for Web Remote.

Logging into Web Remote

1. Select "Operator" or "Administrator", and then click "Login".
 - If "Administrator" is selected, the password entry field appears. Enter the password, and then click "Login".

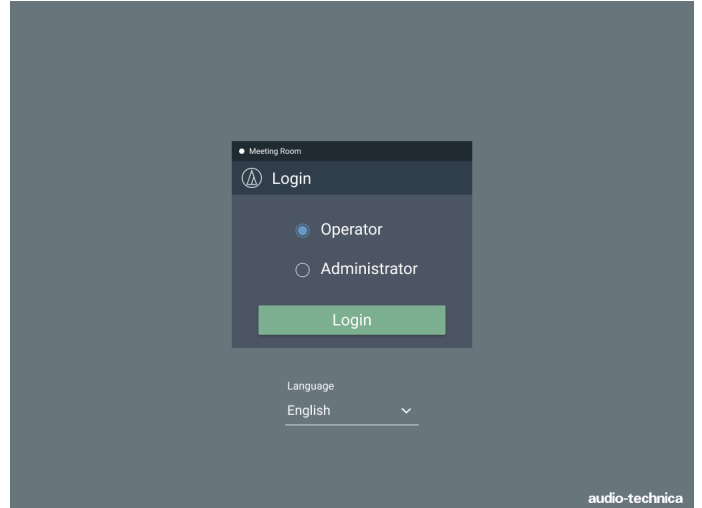

Logging out of Web Remote

1. Click the Logout icon.



2. Click "Logout".
 - Log out of Web Remote.

Operator screen

If you log in as the Operator, you can import the presets, adjust the volumes, and set other options required in day-to-day operations, through simple steps.

Windows/Mac display

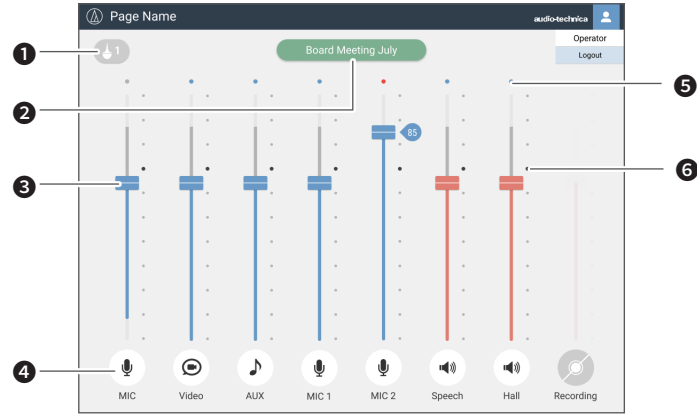

- 1 Array microphone ON/OFF
Each click toggles the array microphone on and off.
- 2 Preset display
Click to recall a desired preset.
- 3 Volume adjustment dial
Adjust the volume of each input/output channel.
Blue: Input channel
Red: Output channel
- 4 Input/Output icon
Icons and display names are displayed according to the contents of "Fader Settings" (p.46). Mute turns ON/OFF each time the icon is clicked.

iOS/Android screen

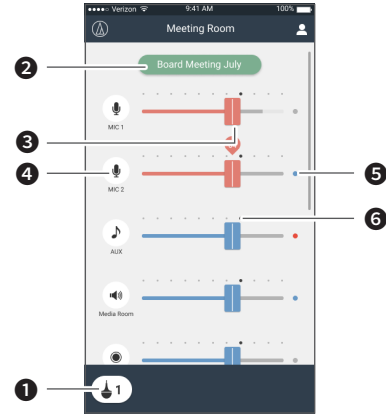

- 5 Level meter
The level of each channel is displayed.
 - Input channel:
Blue: Input received
Gray: No input
 - Output channel:
Blue: Level between -6 to -59 dBFS
Red: Level equal to or greater than -5 dBFS
Gray: No input
- 6 Reference point
The balance is set as adjusted on the Audio Input Screen at the reference point (70%).

Administrator screen

Header

If you log in as the Administrator, you can access the input/output Settings and Settings & Maintenance screens. The header at the top remains the same on both screens.

Header

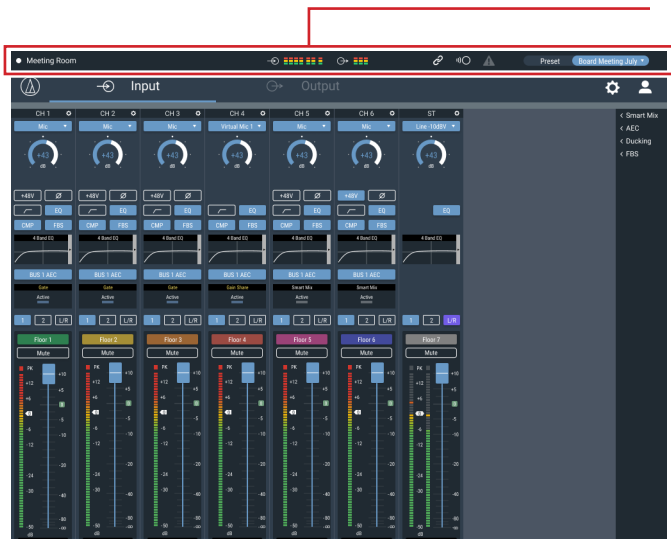

Input

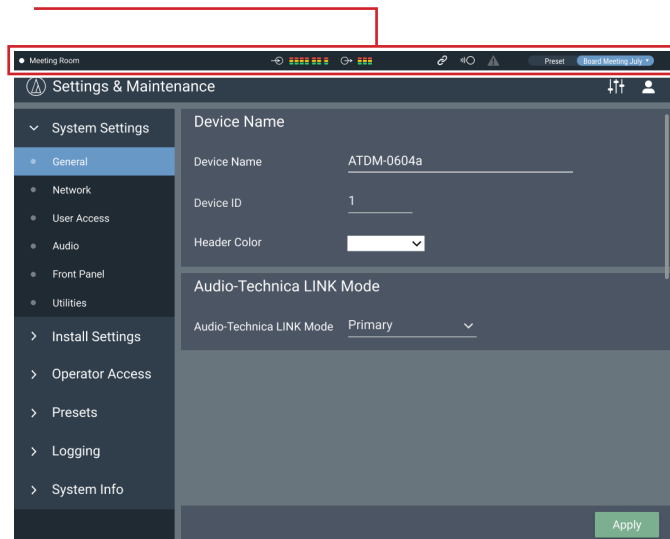



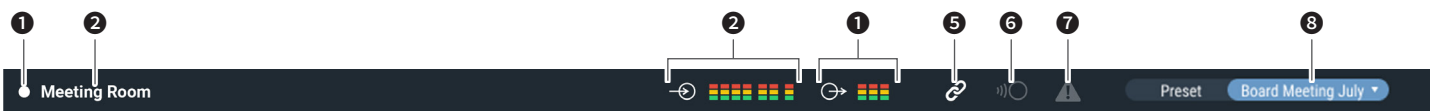







Settings & Maintenance



- 1** Device color
This color helps you identify each device when multiple products are operated.
- 2** Device name
The name set for the product is displayed.
- 3** Input indicator lamp
The input level is displayed.
- 4** Output indicator lamp
The output level is displayed.
- 5** Audio-Technica LINK status
The Audio-Technica LINK connection status is displayed.
- 6** IP remote status
The active status of IP control is displayed.
- 7** Error status
An error status is displayed.
- 8** Preset
The selected preset and the name of the loaded preset are displayed.

Administrator screen

Indicators

Status	Icon display	Description of each status
Audio-Technica LINK status		The Audio-Technica LINK device is not connected correctly.
		The Audio-Technica LINK device is connected correctly.
		There is an Audio-Technica LINK error.
		
IP remote status		Remote control is disabled.
		Remote control is enabled.
		There is a remote control error.
		
Error status		No error is present.
		An error is present.

Error display

When a triangle mark is displayed on an icon, clicking the icon displays a description of the error. After checking the description of the error, move the cursor away from the icon, and the triangle mark will disappear.



Triangle mark

Administrator screen

How to view audio input and output screens



- 1 Click to view the Web Remote version and the Audio-Technica website.
- 2 Click to toggle between the Audio Input and Audio Output Settings screens.
- 3 Click to switch to the Settings & Maintenance screen.
- 4 You can configure the audio input settings for each input channel.
- 5 Click each of these items to display a detailed setting menu.
- 6 You can configure the audio output settings for each output channel.

• You may not be able to set and/or operate functions depending on the settings or the conditions. If applicable, those functions are either grayed out or hidden.

Setting the audio input details

Changing the input type (MIC/LINE)

Specify the input type.

1. Click the area in the red box on the screen shown below.



2. Select the input type from the pull-down menu.
 - The input type changes.

Adjusting the gain

Set the input gain for Mic input.

1. Drag the meter to adjust the gain.
 - You can also click the number and enter the gain directly.



- During input gain adjustment, the level meter turns blue and displays the pre-fader level. Input gain should be adjusted while monitoring the blue level meter.

Turning the phantom power ON/OFF

Turn ON/OFF the phantom power (+48V). This setting can be made only when "Mic" is selected as the input type.

1. Click the area in the red box on the screen shown below.
 - The function is turned ON (blue)/OFF (no color) each time the dial is clicked.



Turning the phase ON/OFF

Invert the input audio phase.

1. Click the area in the red box on the screen shown below.
 - The function is turned ON (blue)/OFF (no color) each time the dial is clicked.



Turning the low-cut ON/OFF

Specify whether or not to remove low frequencies from the audio signal.

1. Click the area in the red box on the screen shown below.
 - The function is turned ON (blue)/OFF (no color) each time the dial is clicked.



Turning the 4-band EQ ON/OFF

Turn ON/OFF the 4-band EQ to be applied to audio inputs.

1. Click the area in the red box on the screen shown below.
 - The function is turned ON (blue)/OFF (no color) each time the dial is clicked.



Setting the audio input details

Turning the compressor ON/OFF

Switch the compressor between ON and OFF for each channel. This setting can be made only when the compressor module is assigned.

1. Click the area in the red box on the screen shown below.

- The function is turned ON (blue)/OFF (no color) each time the dial is clicked.

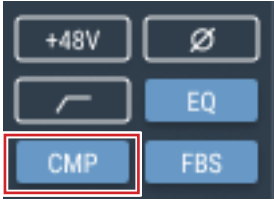

Turning the FBS ON/OFF

Switch the FBS (feedback suppressor) between ON and OFF for each channel. This setting can be made only when the FBS module is assigned.

1. Click on "FBS."



2. Select the check box next to the channel(s) to which it will be assigned.

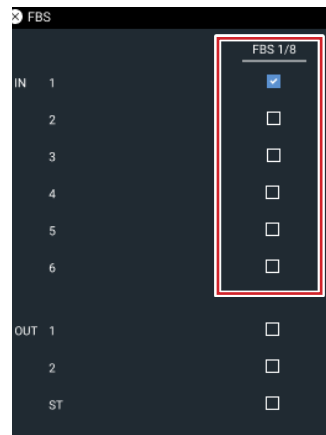

3. Click the area in the red box on the screen shown below.

- The setting is turned ON (blue)/OFF (no color) each time the switch is clicked.

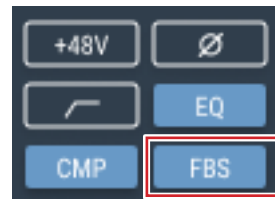

Setting the audio input details

Adjusting the 4-band EQ

Set the 4-band EQ to be applied to audio inputs.

1. Click on the red frame in the following screen.
 - The Settings screen appears.



2. Set each item.



Setting the audio input details

How to view settings screen (FBS)

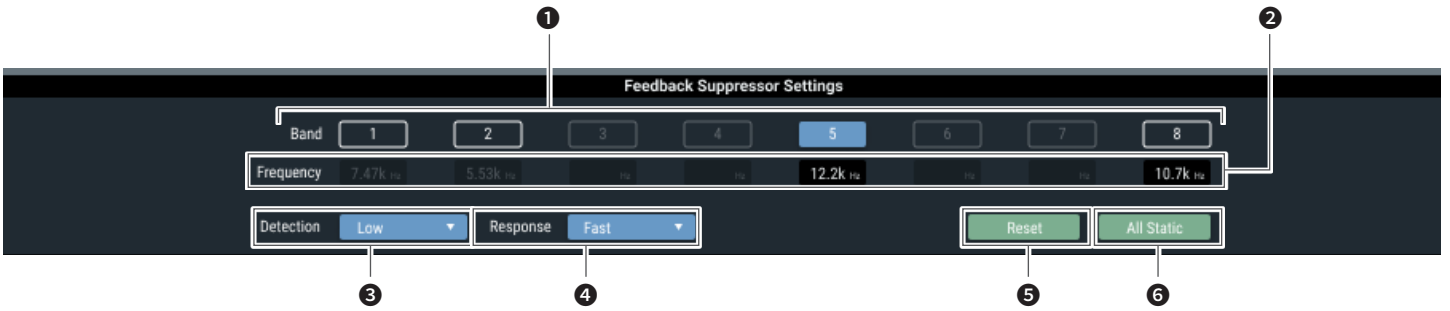

1 The statuses of the bands appear. It can also switch between dynamic and static.

2 The frequencies of the detected feedbacks appear.



3 Select the strength to suppress the feedback.

4 Select the speed of suppressing the feedback.

5 Click to reset the detected frequencies. Once reset, new frequencies are detected (but those of the bands in a static state are not reset).

6 Set all bands to a static state.

• Switch the settings of "Detection" (3) or "Response" (4) to reset the band frequencies in a dynamic state.

<p>3</p> 	<p>Dynamic state.</p> <ul style="list-style-type: none"> Indicates that the feedback frequency is detected, and the FBS is functioning. The feedback frequency remains for 15 seconds and is then automatically cleared. Until a new frequency is detected, the feedback frequency display is left blank and turns into a standby state.
	<p>Static state.</p> <ul style="list-style-type: none"> Click this icon in a dynamic state to lock the band and enter a static state. Click the icon again to cancel a static state of the band and enter a standby state.
	<p>Standby state.</p> <ul style="list-style-type: none"> Waiting for a new feedback frequency to be detected.

Setting the audio input details

How to view settings screen (EQ)

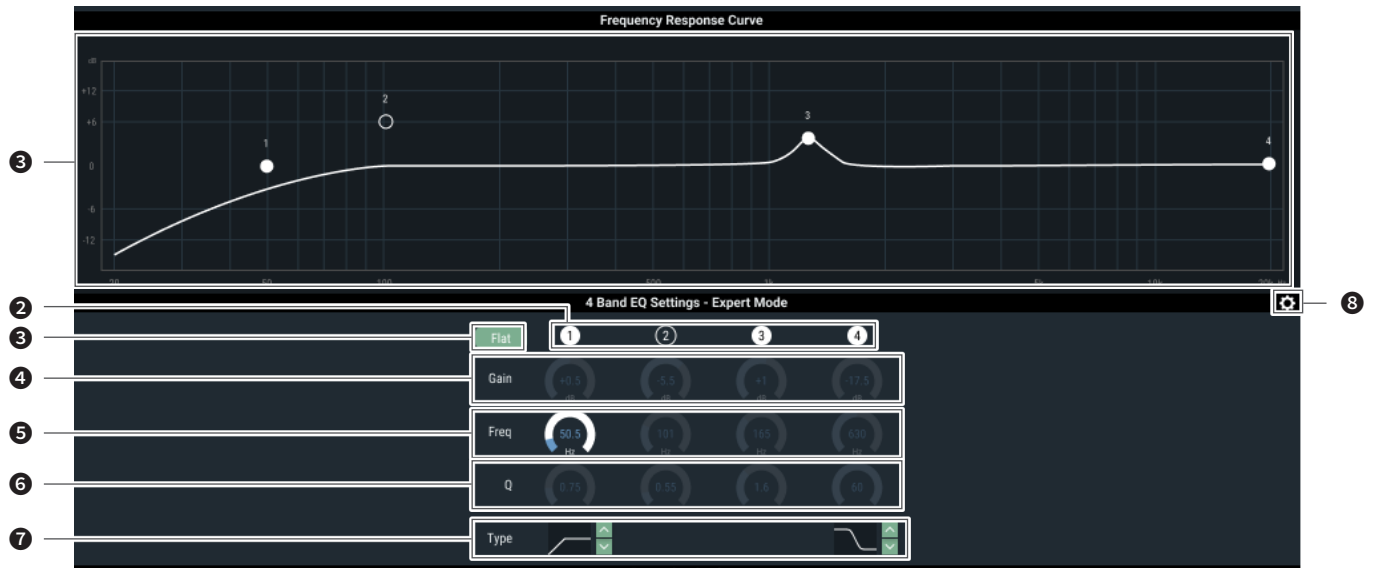

1 Display and edit the EQ frequency response waveform. The pointer for each band indicates the frequency and the gain position.

- Edit the frequency and the gain by dragging a pointer.

2 Display and toggle ON/OFF for each band. The ON and OFF statuses indicate as follows.

1	Turned ON.
2	Turned OFF.

3 In all bands, leave the frequency unchanged and set the gain to 0.

4 Adjust the gain of each band.

5 Adjust the frequency of each band.

6 Adjust the Q value for each band.

7 Change the filter type (Band 1 and Band 4 only).

8 Save EQ presets, resets EQ frequency response waveforms, and also switches between setting screens.

Setting the audio input details

Changing settings screen

The Settings screen can be in “Easy Mode” with a simplified display or in “Expert Mode” with all items displayed.

Easy mode	Select from the pre-arranged EQ patterns to easily adjust the EQ.
Expert mode	The parameters can be set for each band for finer EQ adjustment.

Click the icon (⚙️) on the top right of the screen to switch between the two.

How to view settings screen (Easy Mode)

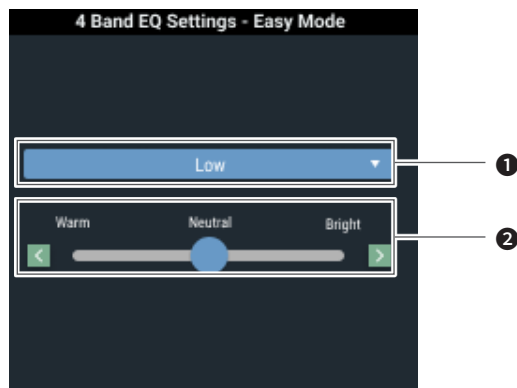

- 1 Select the audio type.
- 2 Adjust the tone.

Setting the audio input details

How to view settings screen (DYN)

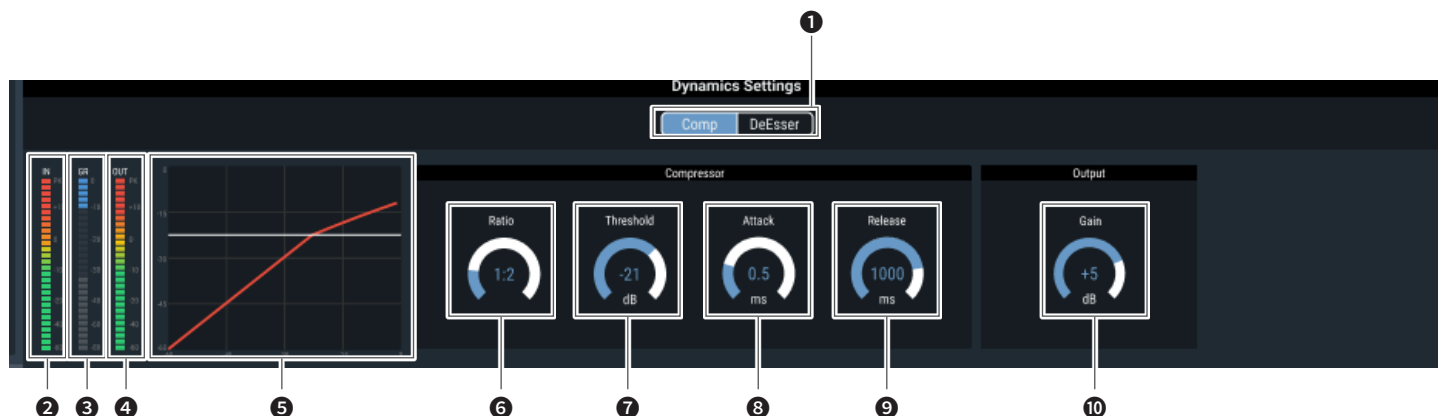

- ① Switch between the compressor and DeEsser.
- ② Indicates the level of audio input to Dynamics.
- ③ Indicates the level of audio gain suppression by the compressor.
- ④ Indicates the level of audio output from Dynamics.
- ⑤ Indicates the Dynamics characteristic.
- ⑥ Set the compressor ratio.
- ⑦ Set the compressor threshold.
- ⑧ Set the compressor attack time.
- ⑨ Set the compressor release time.
- ⑩ Set the output gain of the dynamics.

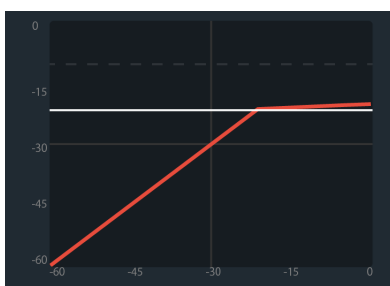
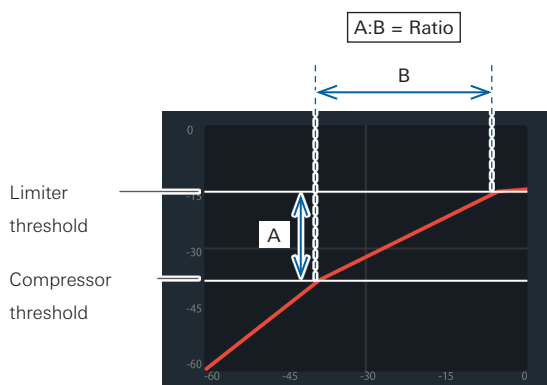

When the limiter threshold is lower than the compressor threshold, the compressor threshold is cleared, and only the limiter threshold is displayed.

Setting the audio input details

Turning the AEC ON/OFF

Turn on/off the AEC (Acoustic Echo Canceler).

- Click the area in the red box on the screen shown below.
 - The function is turned ON (blue)/OFF (no color) each time the dial is clicked.



Checking SmartMixer status

- Check the area in the red box on the screen shown below.
 - Click on the screen to display the SmartMixer Settings screen. For more details, refer to p.53.

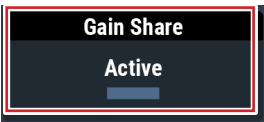

	Turned OFF.
	Turned ON.
	Turned ON, and SmartMixer active. Displayed in the set group color.

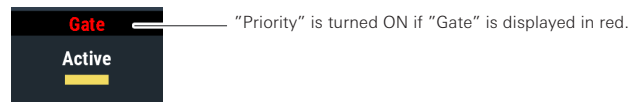

Turning the bus assignment ON/OFF

Switch the output bus between ON and OFF for each channel.

- Click the area in the red box on the screen shown below.
 - The function is turned ON (purple)/ON (blue)/OFF (no color) each time the switch is clicked.

ON (Purple)	Audio signals processed by SmartMixer are output when SmartMixer is turned ON.
ON (Blue)	Assigned to the output bus. Even when the Smart Mixer is on, the audio signal is output through the Smart Mixer.
OFF	Not assigned to any output bus.

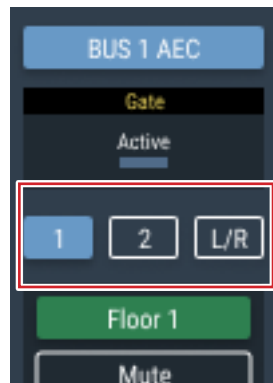

Setting the audio input details

Setting channel names and colors

Set the name and color of each channel.

1. Click the area in the red box on the screen shown below.

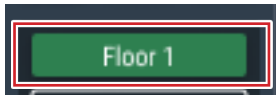

2. Select a color of your choice.
3. Click the text input field and enter the channel name of your choice.
4. Click "OK".

Turning the mute ON/OFF

Switch the mute setting between ON and OFF for each channel.

1. Click the area in the red box on the screen shown below.
 - Mute turns ON (red)/OFF (no color) each time the switch is clicked.

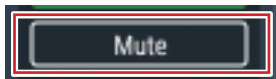

Adjusting the input level

Set the Mic/Line input level for each channel.

1. Drag the volume adjustment dial, and move it up and down to adjust the input level.

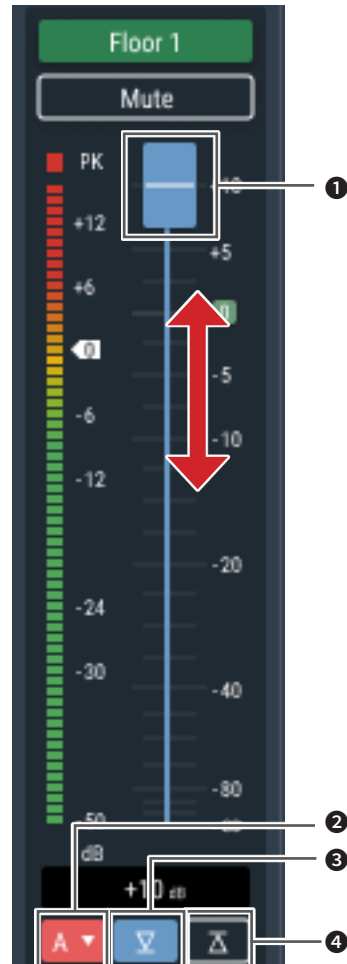

1. Volume adjustment dial
2. Fader group
3. Min Volume ON/OFF
4. Max Volume ON/OFF

Setting the audio input details

Setting the fader group

If a channel fader is set to the same group on this screen of the primary or extension unit and assigned on p.46 on the operator's screen of the primary unit, the fader assigned on that primary unit will be used to control the levels of channels belonging to the same group.

1. Click the area in the red box on the screen shown below.



2. Select the fader group.

Setting the Min/Max Volume

Determine the Min/Max Volume and turn it ON/OFF for each channel.

1. Click the area in the red box on the screen shown below.
 - The setting is turned ON (blue)/OFF (no color) each time the switch is clicked.
 - The fader minimum/maximum are set at the position when the Min/Max Volume is turned ON. The range below and above the specified position is grayed out. To change the position, turn the Max Volume OFF and then back ON.



Setting the audio output details

Setting the unity level

1. Click the area in the red box on the screen shown below.



2. Select a unity level from the pull-down menu.
 - The unity level changes.

Turning the FBS ON/OFF

Switch the FBS (feedback suppressor) between ON and OFF for each channel.

1. Click the area in the red box on the screen shown below.
 - The function is turned ON (blue)/OFF (no color) each time the dial is clicked.

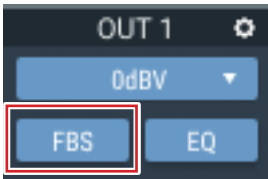

Turning the EQ ON/OFF

Switch the EQ between ON and OFF for each channel.

1. Click the area in the red box on the screen shown below.
 - The function is turned ON (blue)/OFF (no color) each time the dial is clicked.

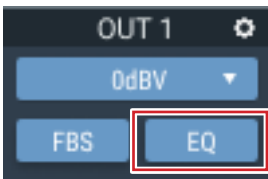

Adjusting the FBS/EQ

1. Click the area in the red box on the screen shown below.
 - The Settings screen appears.

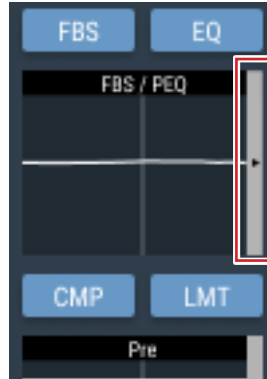

2. Set each item.



Setting the audio output details

How to view settings screen (FBS)

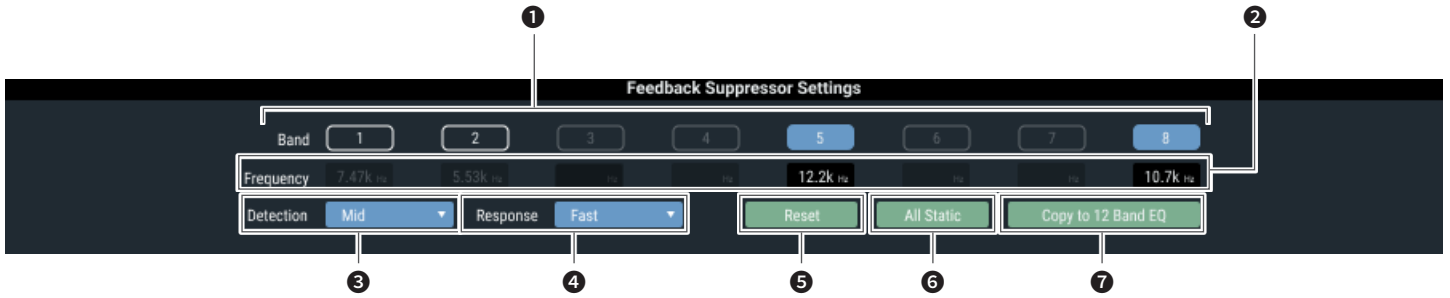

1 The statuses of the bands appear. It can also switch between dynamic and static.

1	<p>Dynamic state.</p> <ul style="list-style-type: none"> Indicates that the feedback frequency is detected, and the FBS is functioning. The feedback frequency remains for 15 seconds and is then automatically cleared. Until a new frequency is detected, the feedback frequency display is left blank and turns into a standby state.
8	<p>Static state.</p> <ul style="list-style-type: none"> Click this icon in a dynamic state to lock the band and enter a static state. Click the icon again to cancel a static state of the band and enter a standby state.
7	<p>Standby state.</p> <ul style="list-style-type: none"> Waiting for a new feedback frequency to be detected.

2 The frequencies of the detected feedbacks appear.

3 Select the strength to suppress the feedback.

4 Select the speed of suppressing the feedback.

5 Click to reset the detected frequencies. Once reset, new frequencies are detected (but those of the bands in a static state are not reset).

6 Set all bands to a static state.

7 Click to copy the static bands to the bands of 12-band EQ. The bands for which the 12-band EQ is turned off are copied.

- Switch the settings of "Detection" (3) or "Response" (4) to reset the band frequencies in a dynamic state.

Setting the audio output details

How to view settings screen (EQ)

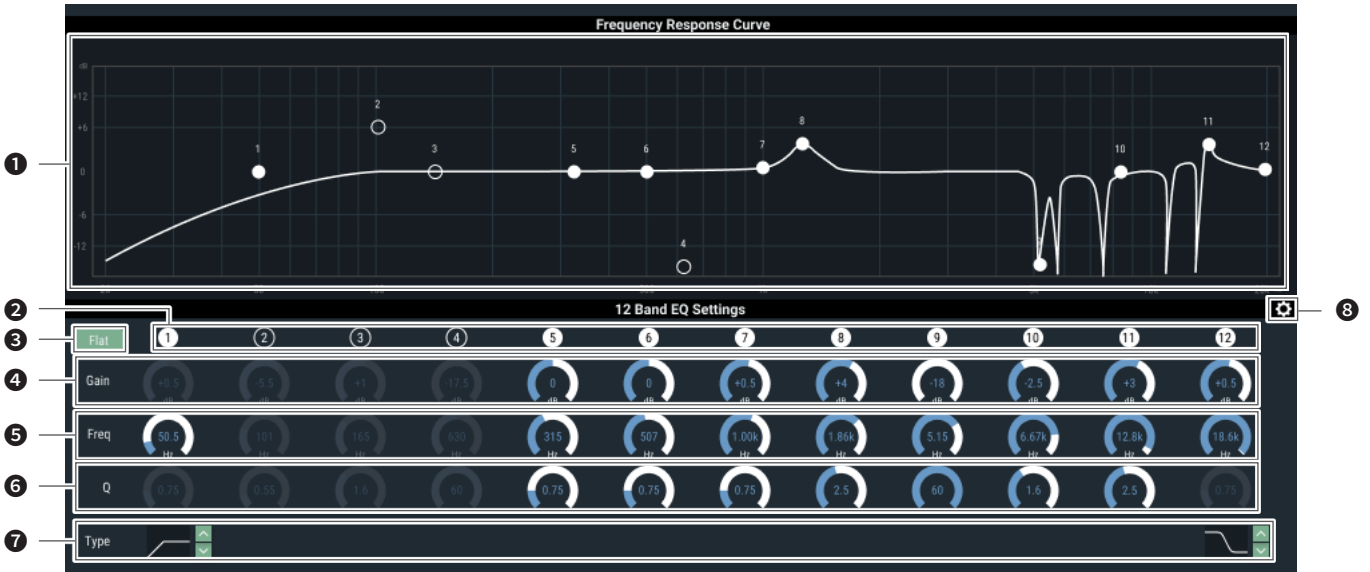

- ❶ Display and edit the EQ frequency response waveform. The pointer for each band indicates the frequency and the gain position.
 - Edit the frequency and the gain by dragging a pointer.
- ❷ Display and switch the ON/OFF setting of each band. The ON and OFF statuses indicate as follows.

❶	Turned ON.
❷	Turned OFF.

- ❸ In all bands, change the gain to 0 without changing the current frequency.
- ❹ Adjust the gain of each band.
- ❺ Adjust the frequency of each band.
- ❻ Adjust the Q value of each band.
- ❼ Change the filter type (applicable to bands 1 and 12 only).
- ❽ Reset a parameter and save/recall an EQ preset.

Setting the audio output details

How to view settings screen (DYN)

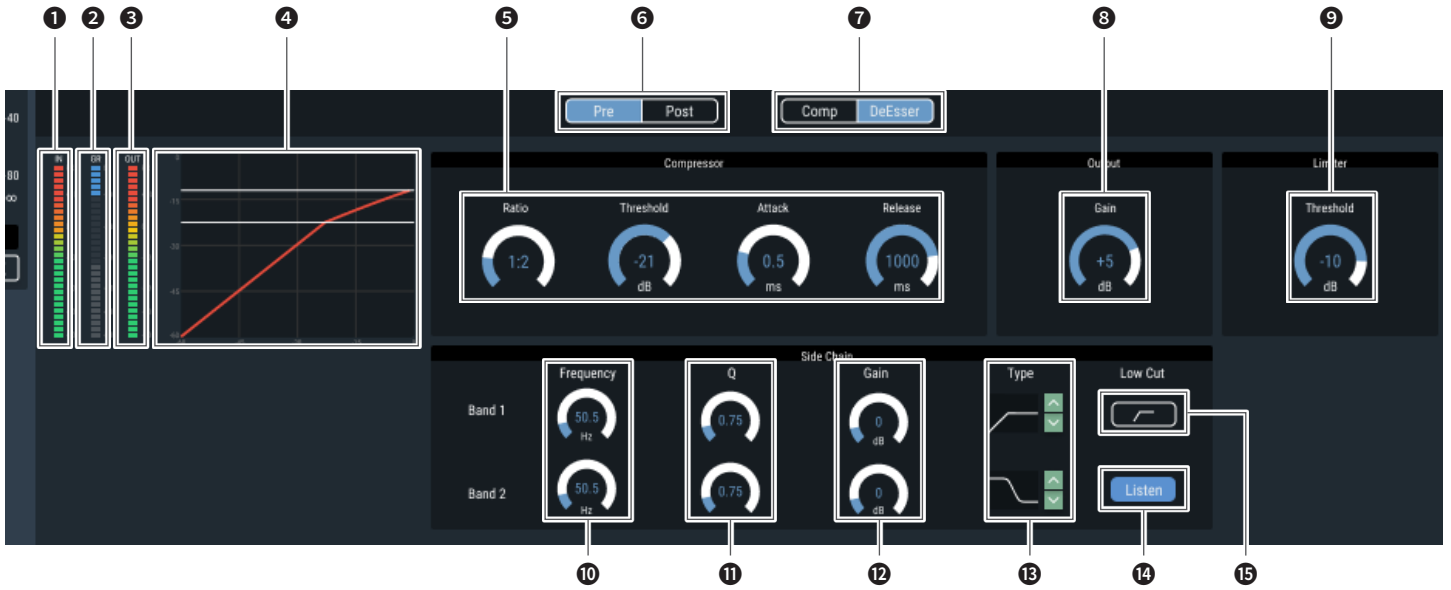

- 1 Indicates the level of audio input to Dynamics.
- 2 Indicates the level of audio gain suppression by the compressor.
- 3 Indicates the level of audio output from Dynamics.
- 4 Indicates the Dynamics characteristic.
- 5 Set each item for the compressor.
Ratio: Set the compressor ratio.
Threshold: Set the compressor threshold.
Attack: Set the compressor attack time.
Release: Set the compressor release time.
- 6 Select whether the dynamics are assigned to Pre EQ or Post EQ.
- 7 Switches between compressor/de-esser.
- 8 Set the Dynamics output gain.
- 9 Set the Limiter threshold.
- 10 Adjust the frequency of the de-esser.
- 11 Adjust the Q value of the de-esser.
- 12 Adjusts the gain of the de-esser.
- 13 Change the filter type.
- 14 Turns the Listen function on or off.
- 15 Set the low cut ON/OFF.

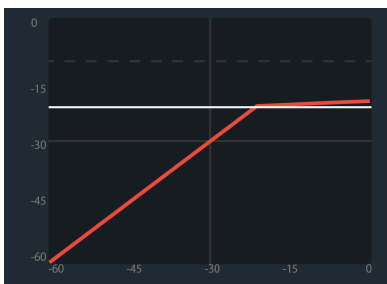
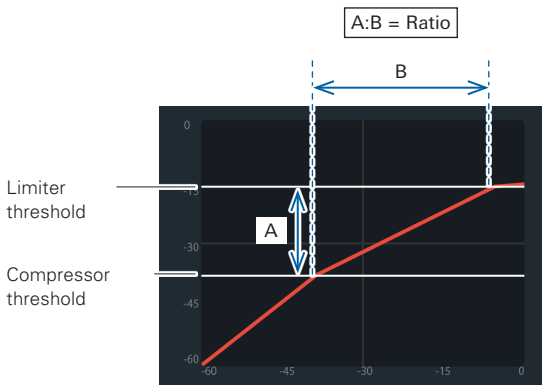

When the limiter threshold is lower than the compressor threshold, the compressor threshold is cleared, and only the limiter threshold is displayed.

Setting the audio output details

Turning the compressor ON/OFF

Switch the compressor between ON and OFF for each channel. This setting can be made only when the compressor module is assigned. This operation is the same as that for the input channels.

1. Click the area in the red box on the screen shown below.
 - The function is turned ON (blue)/OFF (no color) each time the dial is clicked.

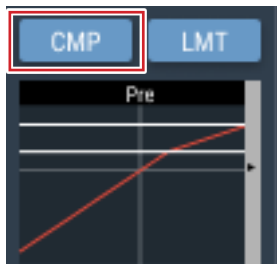

Adjusting the dynamics

1. Click the area in the red box on the screen shown below.
 - The Settings screen appears.

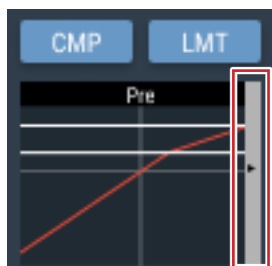

2. Set each item.



Turning the delay function ON/OFF

Specify whether or not to delay the output of each channel.

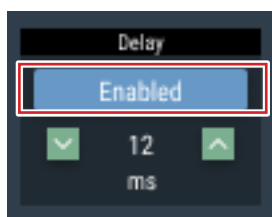
1. Click the area in the red box on the screen shown below.
 - The function is turned ON (blue)/OFF (no color) each time the dial is clicked.



Setting the delay time for delay function

1. Set the amount of time to delay.
 - Click  /  to adjust the time. You can also click the time and enter the value directly.

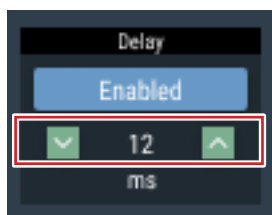

Setting the audio output details

Setting channel names and colors

Set the name and color of each channel.

1. Click the area in the red box on the screen shown below.

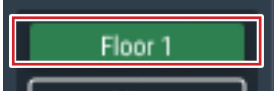

2. Select a color of your choice.
3. Click the text input field and enter the channel name of your choice.
4. Click "OK".

Turning the mute ON/OFF

Switch the mute setting between ON and OFF for each channel.

1. Click the area in the red box on the screen shown below.
 - Mute turns ON (red)/OFF (no color) each time the switch is clicked.



Adjusting the output level

Set the Mic/Line output level for each channel.

1. Click the volume adjustment dial, and move it up and down to adjust the output level.

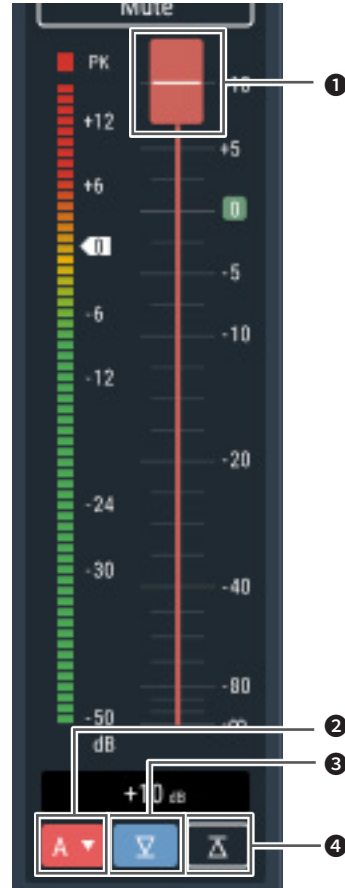

1. Volume adjustment dial
2. Fader group
3. Min Volume ON/OFF
4. Max Volume ON/OFF

Configure detailed settings for audio output

Setting the fader group

If a channel fader is set to the same group on this screen of the primary or extension unit and assigned on p.46 on the operator's screen of the primary unit, the fader assigned on that primary unit will be used to control the levels of channels belonging to the same group.

1. Click the area in the red box on the screen shown below.



2. Select the fader group.

Setting the Min/Max Volume

Determine the Min/Max Volume and turn it ON/OFF for each channel.

1. Click the area in the red box on the screen shown below.

- The setting is turned ON (blue)/OFF (no color) each time the switch is clicked.
- The fader minimum/maximum are set at the position when the Min/Max Volume is turned ON. The range below and above the specified position is grayed out. To change the position, turn the Max Volume OFF and then back ON.



Setting the USB output

Select the USB output bus and set the transmission level.

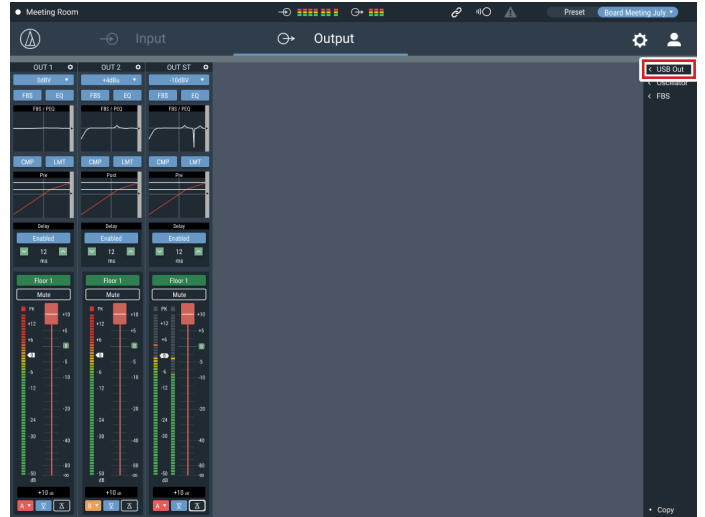

1. Click "USB OUT".

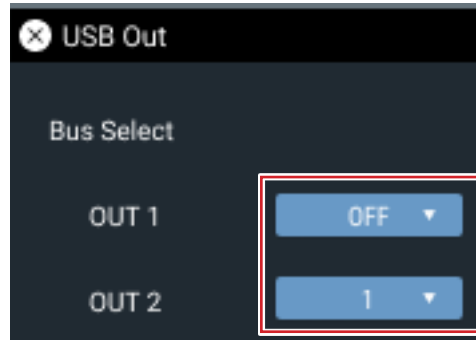

2. Selects the bus for output to USB OUT 1 and 2 respectively.



3. Select the level for USB output.

- Click  /  to adjust the level. You can also click the number and enter another value directly.

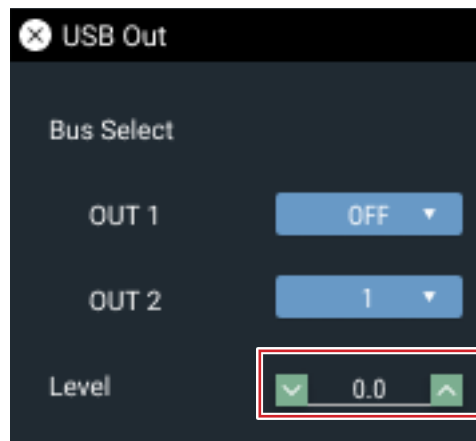

Setting the audio output details

Setting the oscillator

The product has an oscillator function on the output channels. This function is convenient for checking the audio during setup or maintenance.

1. Click on "Oscillator".

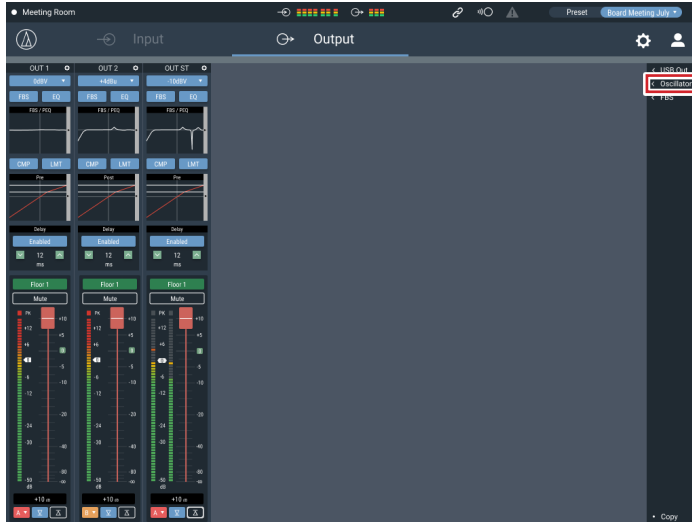

2. Click "Enabled".
 3. Select "Sine Wave" or "Pink Noise" under "Source".
 4. Select a frequency under "Frequency".
 5. Adjust the level under "Level".
 6. Select an output channel under "Assign".
- When "Enabled" is ON for the selected channels, the oscillator will be activated.

Setting the system details (Settings & Maintenance)

Advanced options for the entire system and access utilities to help maintain and troubleshoot the system are available.

Settings & Maintenance screen

Basic operations

1. Click on the icon () in the upper right corner of the screen.



2. From the list of setting items, select the item you want to set.

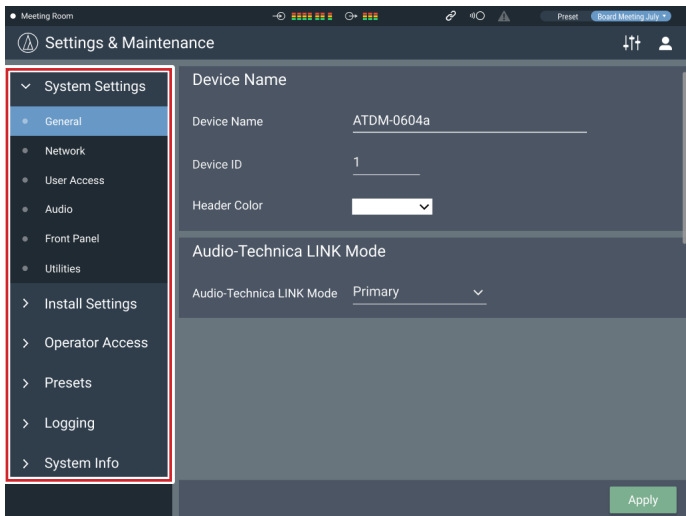

3. Set the item as necessary, and click "Apply".

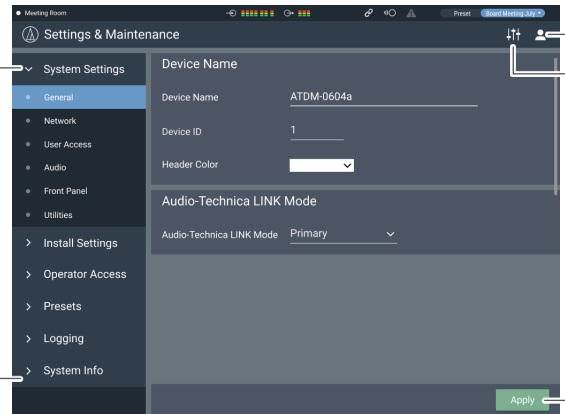
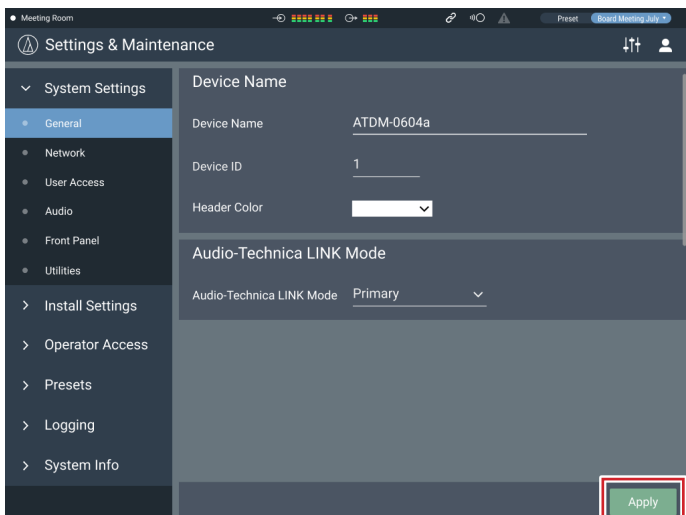

- 1 Setting item menu

- 2 Logout icon

- 3 Screen switching icon

The Audio Settings screen appears.

- 4 Apply button

The change made to each setting is reflected.

General in System Settings

Device Name

Device Name	Set the name of the product being controlled from Web Remote.
Device ID	Set the device ID of the product.
Header Color	Set the color of the top part (header) of the Web Remote screen.

After setting each item, click "Apply" to complete the setting.

Audio-Technica LINK mode

Set the operation mode under Audio-Technica LINK.

1. Select "Primary" or "Extension".

2. Click "Apply".

- Setting is complete.

Setting the system details (Settings & Maintenance)

Network (System Settings)

IP Control & Web Remote Port Settings

Set how to obtain IP addresses, and specify each value.

1. From "IP Config Mode", select "Auto" or "Static".

Auto	IP addresses are automatically assigned from the DHCP server, etc.
Static	Specify static IP addresses. Selecting "Static" enables the "IP Address", "Subnet Mask", and "Gateway Address" fields. Enter the addresses you want to specify. The default value is "192.168.33.102".

2. Click "Apply".

- Setting is complete.

Allow Discovery

Set the product to be discovered automatically by "Locate".

1. Click the switch.

- The function is turned ON (blue)/OFF (no color) each time the dial is clicked.
- When the function is turned on, the product can be identified by "Locate".

2. Click "Apply".

- Setting is complete.

IP Control Settings

Set the options relating to IP control.

1. Set each item.

Port Number	The port number of the IP control is displayed.
Notification	Receive notifications from IP-controlled devices.
Audio Level Notification*	Receive audio level notifications from IP-controlled devices.
Multicast Address*	Set the address for multicast.
Multicast Port Number*	Set the port number for multicast.

* This item can be set only when "Notification" is turned ON (blue).

2. Click "Apply".

- Setting is complete.

NTP Settings

Set the NTP (Network Time Protocol).

1. Set each item.

Enabled	Set whether to enable or disable the NTP (Network Time Protocol).
Server Address	Set the NTP server address.
Port Number	Set the NTP port number.
Time Zone	Set the time difference from the UTC (Coordinated Universal Time).
Daylight Saving Time	Turn on/off the daylight saving time.
Start Date & Time*	Set the starting date/time of daylight saving time.
End Date & Time*	Set the ending date/time of daylight saving time.

* This can be set only when "Daylight Saving Time" is ON (blue).

2. Click "Apply".

- Setting is complete.

User Access (System Settings)

Default Front Panel Mode

Set the front panel mode when the power is on.

1. Select "Administrator"/"Operator".
2. Click "Apply".

- Setting is complete.

Login Password

Set whether or not to require a password for Administrator login.

1. Click the switch to turn on/off the setting.

- The function is turned ON (blue)/OFF (no color) each time the dial is clicked.

2. Enter a desired password.

- Create a password using 4 to 8 alphanumeric characters.

3. Click "Apply".

- Setting is complete.

Operator Page Permissions

Set whether or not to limit the devices that can be accessed by the Operator.

1. Click the switch to turn on/off this function.

- The function is turned ON (blue)/OFF (no color) each time the dial is clicked.

2. Enter the IP addresses of the devices that can be accessed by the Operator.

- Up to 5 devices can be registered.

3. Click "Apply".

- Setting is complete.
- No other device can be accessed by the Operator.

Setting the system details (Settings & Maintenance)

Audio (System Settings)

Audio System

Check/change the audio-related system settings.

1. Set each item.

Gain Unit Type	Set the unit in which the gain is displayed for adjustment.
Delay Unit Type	Set the unit in which the delay time is displayed for setting.
Output Flip	Switch the output ports.
Input EQ/DYN Display	Set the graph display for the Audio Input Settings screen.
Virtual Mic Mode	Select to include the virtual mic as an option in the input type pull-down menu.

2. Click "Apply".

- Setting is complete.

Output Flip (output mode switching)

Output of each channel assigned to an output bus is as described below.

- When "Output Flip" is OFF

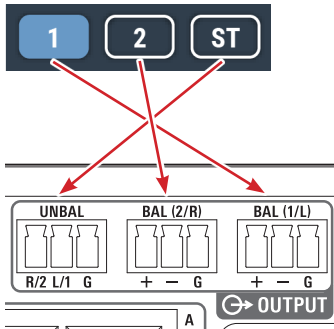

- When "Output Flip" is ON

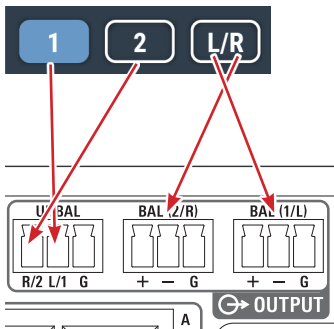

- When "Output Flip" is turned on, the OUTPUT ST notation on the audio output screen changes to OUTPUT L/R.

Array Mic Mute

Turning Virtual Mic mode ON (blue) enables GPO1/GPO2 settings.

1. Click the switch to turn on/off the setting.
 - The function is turned ON (blue)/OFF (no color) each time the dial is clicked.
2. Set "Mute"/"Unmute".
 - The signal output from the GPO1 and GPO2 terminals during "Mute" and "Unmute" can be selected from "Open" and "Close".
3. Click "Apply".
 - Setting is complete.
 - Works with the array microphone icon on the operator page.

Setting the system details (Settings & Maintenance)

Front Panel (System Settings)

Levels

Set whether or not to enable input/output level adjustment for each channel on the front panel of the product.

1. Place/remove a check mark on each channel.
 - You can adjust the level of each selected channel.
2. Click "Apply".
 - Setting is complete.

LED Dimmer

Set whether or not to enable dimming of the LEDs (dimmed illumination) on the front panel of the product.

1. Click the switch to turn on/off the setting.
 - The setting is turned ON (blue)/OFF (no color) each time the switch is clicked.
2. Click "Apply".
 - Setting is complete.

Front Panel Restrictions

Set whether or not to enable preset recall on the front panel of the product.

1. Click the switch to turn on/off the setting.
 - The setting is turned ON (blue)/OFF (no color) each time the switch is clicked.
2. Click "Apply".
 - Setting is complete.

Utilities (System Settings)

Firmware Update

Update the firmware of the product.

1. Check "Serial Number", "Device Name", and "Firmware Version" on the screen to see if this product is due for update.
2. Click "Browse".
 - The file selection screen appears.
3. Select and open the file of the latest version on the file selection screen.
4. Click "Update".
 - Update is started. When the update is complete, the completion screen appears.
5. Turn off the product, and then restart the product.
 - After the restart, reload the page in a web browser.

Language Pack Install

Install the language pack to allow Web Remote to be displayed in multiple languages.

1. Click "Browse".
 - The file selection screen appears.
2. Select and open the files of the desired languages on the file selection screen.
3. Click "Install".
 - Installation is started. When the installation is complete, the completion screen appears and you are automatically logged out.

Reset All Settings to Default

Reset the product to the factory defaults. (The firmware will remain the current version.)

1. Click "Reset".
 - The confirmation screen appears.
2. Check the information on the confirmation screen, and click "YES".
 - When the initialization is complete, the completion screen appears. Turn off the product.

Control Panel (Install Settings)

This item is used when connecting our separately sold control panel. Refer to the control panel manual for details.

Setting the system details (Settings & Maintenance)

Operator Page (Operator Access)

Array Mic Switch LINK

Set whether or not to share muting by the Mic Array switch between Audio-Technica LINK devices.

- Click the switch to turn on/off the setting.
 - The setting is turned ON (blue)/OFF (no color) each time the switch is clicked.
- Click "Apply".
 - Setting is complete.

How to view the Fader Settings screen

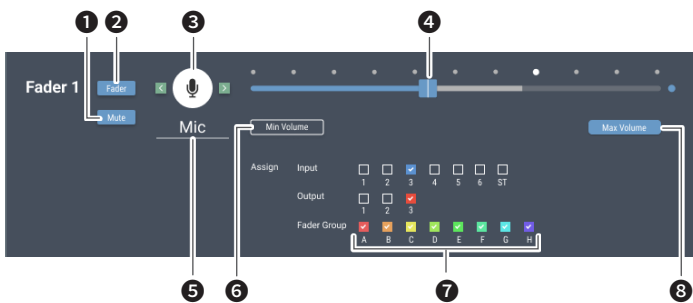

- Set whether or not to mute when the icon (3) is clicked on the Operator Page.
- Set whether or not to display the fader on the Operator Page.
- Select the icon to be displayed on the Operator Page.
- Adjust the volume.
- Set a desired name.
- Set the minimum fader level.
- Assign an input or output channel to the fader or set a fader group.
- Set the maximum fader level.

Fader Settings

Check/change the operations that can be performed on the Operator page.

- Enter the page name to be displayed in "Page Name".
- Set each item.
 - Set each item by referring to "How to view the Fader Settings screen".
- Click "Apply".
 - Setting is complete.

Operator Page Restrictions

Set restrictions on the operations that can be performed on the Operator page.

- Set each item.

Preset Recall	Set whether or not to recall presets.
Number of Presets*	Set the number of presets that can be recalled.
Resume Fader Position	Set whether or not to enable position resume for up to eight fader channels.
Logout Button	Set whether or not to display the Log Out button on the screen.
Array Mic Switch	Set whether to place a button on the Operator Page for turning the array mic and LED ring on or off.

* This can be set when "Preset Recall" is turned ON.

- Click "Apply".
 - Setting is complete.

Presets (Presets)

Presets

Check/change the preset settings currently registered in the product, and import/export preset files.

How to view the Presets screen

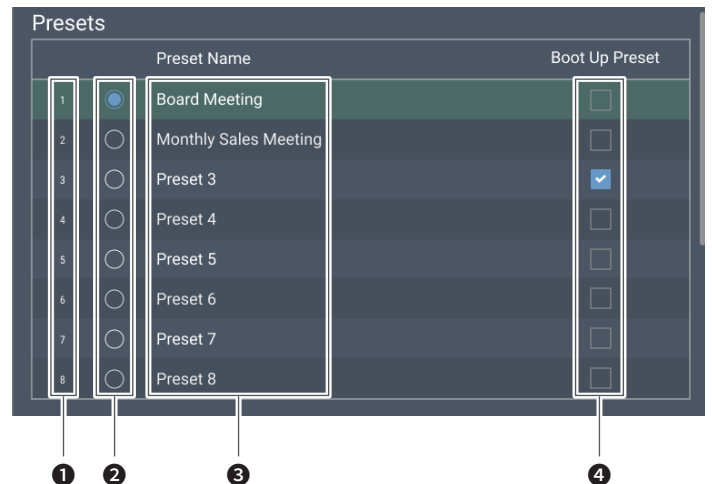

- Preset No.
- Radio button
Select a preset.
- Preset name
Set a desired name.
- Boot Up Preset
Each time this product is started, the selected preset is recalled.

Setting the system details (Settings & Maintenance)

Exporting a preset

1. Click the radio button corresponding to the preset number from which you want to export.
 - Clicking the button selects the preset (the color turns to blue).
2. Click "Export".
3. Set the save location/file name, and export the file.

Importing a preset

A preset created elsewhere can be imported.

1. Click the radio button corresponding to the preset number to which you want to import.
 - Clicking the button selects the preset (the color turns to blue).
2. Click "Browse", and select the external file.
3. Click "Import".
 - The preset is imported.

Preset Recall LINK

Set whether or not to link Preset Recall between Audio-Technica LINK devices.

1. Click the switch to turn on/off the setting.
 - The function is turned ON (blue)/OFF (no color) each time the dial is clicked.

Partial Preset (Presets)

Unlike presets used to save settings for an entire device, these presets only save parameters selected by choice. Settings can be recalled without affecting parameters other than the saved parameters.

Changing a partial preset name

1. Click on the name of the partial preset you wish to change.
2. Enter a partial preset name.

Setting partial preset parameters

1. Click the radio button for the partial preset number you wish to set.
 - Clicking the button selects the preset (the color turns to blue).
2. Set each parameter from "Partial preset Parameters".
3. Click "Save."
 - The partial preset is saved.

Recalling a partial preset

1. Click the radio button for the partial preset number you wish to recall.
 - Clicking the button selects the preset (the color turns to blue).
2. Click "Recall".

Exporting a partial preset

1. Click the radio button for the partial preset number you wish to change.
 - Clicking the button selects the preset (the color turns to blue).
2. Click "Export".

Importing a partial preset

1. Click the radio button for the partial preset number you wish to load.
 - Clicking the button selects the preset (the color turns to blue).
2. Click "Browse", and select the external file.
3. Click "Import".
 - The partial preset is imported.

Setting the system details (Settings & Maintenance)

4 Band EQ Library (Presets)

4 Band EQ Library

You can import/export 4-band EQ patterns to be applied to audio inputs as a preset.

EQ Preset	A setting in which the EQ patterns for all bands are saved.
Library	A group that includes all presets.

Changing a preset name

1. Click the preset name you want to change.
2. Enter the new preset name.

Exporting a preset/library

1. Click the radio button corresponding to the preset number from which you want to export.
 - Clicking the button selects the preset (the color turns to blue).
 - When exporting a library, you need not select all applicable presets.
2. Click "Export" from "EQ Preset"/"Library".

Importing a preset/library

1. Click the radio button corresponding to the preset number to which you want to import.
 - Clicking the button selects the preset (the color turns to blue).
 - When importing a library, you need not select all applicable presets.
2. Click "Browse" from "EQ Preset"/"Library" and select the external file.
3. Click "Import" from "EQ Preset"/"Library".
 - The preset/library is imported.

12 Band EQ Library (Presets)

12 Band EQ Library

You can import/export 12-band EQ patterns to be applied to audio outputs as a preset.

EQ Preset	A setting in which the EQ patterns for all bands are saved.
Library	A group that includes all presets.

Changing a preset name

1. Click the preset name you want to change.
2. Enter the new preset name.

Exporting a preset/library

1. Click the radio button corresponding to the preset number from which you want to export.
 - Clicking the button selects the preset (the color turns to blue).
 - When exporting a library, you need not select all applicable presets.
2. Click "Export" from "EQ Preset"/"Library".

Importing a preset/library

1. Click the radio button corresponding to the preset number to which you want to import.
 - Clicking the button selects the preset (the color turns to blue).
 - When importing a library, you need not select all applicable presets.
2. Click "Browse" from "EQ Preset"/"Library" and select the external file.
3. Click "Import" from "EQ Preset"/"Library".
 - The preset/library is imported.

Logging (Logging)

Logging

Set the options relating to log messages, and download log files.

Enabled	Set whether or not to save log messages.
Destination	Set whether to write log messages to the internal memory or transfer them to the Syslog server.
Log File	You can download the log file recorded to the internal memory by clicking "Download".

After setting each item, click "Apply" to complete the setting.

- Syslog is a standard for transferring log messages across IP networks. It is used for administration of computer systems and security monitoring.

Setting the system details (Settings & Maintenance)

System Info (System Info)

System Info

System information, such as the various network settings and the product's serial number and firmware version, is displayed. Clicking "Export" will export system information to a text file.

Key functions

AEC (Acoustic Echo Canceler)

In meetings held between remote locations, such as teleconferencing, acoustic echoes can occur when the audio output from the speaker is picked up by a microphone. The audio from the other party is amplified by the speaker and can bounce off of the ceiling, walls or floors of the room, and, upon being picked up by the microphone, is returned to the other party along with your party's audio. The other party hears the delayed own audio, making it difficult to speak back.

Using the other party's signals as reference signals, the acoustic echo canceler removes only the echoes in the other party's audio from the audio signals sent from your party. This makes it possible to deliver clear audio, with no echoes, to the other party.

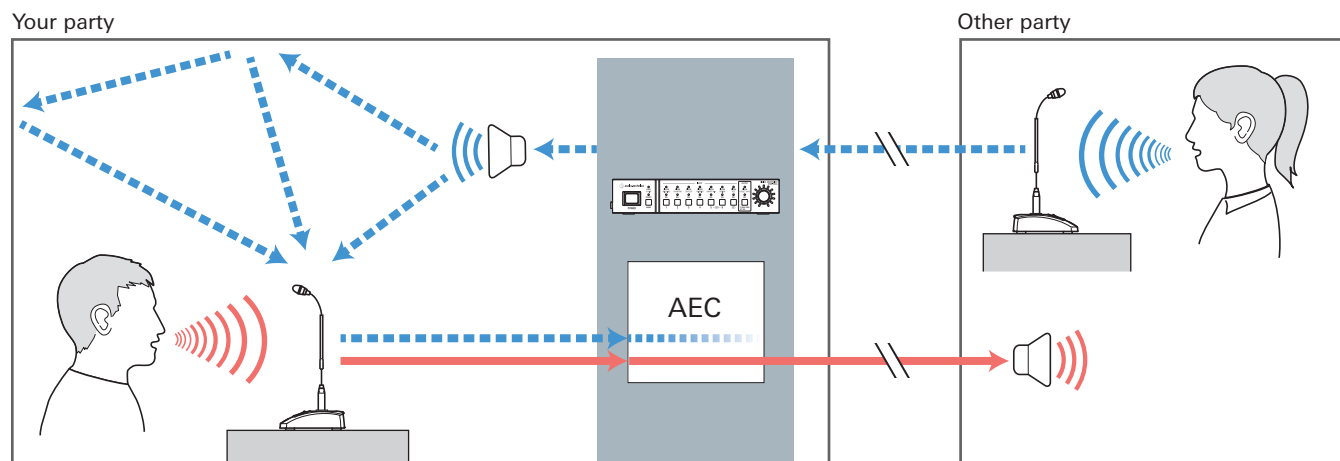

Key functions

Setting AEC

1. Click "AEC".



4. Turn AEC ON for the microphone to be used (for each channel).



2. From "Mode", select "AEC".



5. Select the BUS to be processed from "Input bus".



3. From "AEC Reference", select the reference signal (the signal for removing echoes).

- In general, a signal from the other party is set as the reference Level signal.



Key functions

- Select the output destination for the processed signal from "Output".
 - Multiple "Outputs" can be selected. The selected "Output" will output an AEC/NC'd signal to the bus selected in "Input BUS". AEC/NC outputs have priority (override) over channel strip assignments.
 - For example, if CH1 is assigned to bus 1 and CH2 to bus 2, and "Input BUS" for AEC is set to 1 and "Output" is set to 2, OUT2 will output an AEC-applied signal to CH1.



- If necessary, turn ON "NLP".
 - These features may increase the echo canceling effect.



• If the echo no longer disappears, turn AEC on/off and restart the product.

- Confirm that the ERL meter fluctuates.
 - Perform the following procedures as necessary.



- Adjust the distance to the microphone, speaker position, input level, etc. so that the ERL meter is below 0.
 - If the ERL meter is greater than 0, try the following
 - Move microphone and speaker placement away
 - Increase input for AEC Reference

Key functions

SmartMixer

The SmartMixer function is designed to automatically adjust the audio input and output of the microphone channel without picking up any unnecessary noise or allowing howling to occur in meetings where an unspecified large number of participants speak at the same time. It is particularly effective in meetings, such as a panel discussion, where the participants can speak at any given time. The automation of the otherwise cumbersome fader operation by an operator makes it possible to have stable and efficient operation. SmartMixer can be either "gate mode" or "gain sharing mode".

Gate mode SmartMixer

When there is an audio input to a microphone, the corresponding channel automatically opens. If more than one microphone receives audio input, the audio inputs to all open channels are added. Simply adding the audio inputs tends to lower the howling margin, thereby reducing the audio quality. To address this issue, the gate mode SmartMixer attenuates the added audio inputs based on the number of open mic channels.

Gain sharing mode SmartMixer

This type of SmartMixer compares the audio input level of each mic channel against the total sum of the audio input levels from all open mic channels, and, based on the ratio, divides the gain among all the channels. With this, the total gain always (remains constant), whether the audio input is from one microphone or multiple microphones.

Setting Gate mode SmartMixer

Configure all settings using Web Remote.

1. Click "Smart Mix".



2. From "Mode", select "Gate".



3. Click "Enabled" for each channel that should operate with the SmartMixer function.

- Click to turn ON (blue).



Key functions

4. Set "Priority", "Can Cut", and "Off Attenuation" for each channel, as necessary.

Priority	When this is set to ON, the gate of this microphone input channel opens first over the other channels whose "Priority" is OFF. <ul style="list-style-type: none"> Depending on the setting of the priority mode, the gate may not open.
Can Cut	When this is set to ON for a channel whose "Priority" is ON, the gates of the other channels whose "Priority" is OFF close upon opening of the gate of this microphone input channel.
Off Attenuation	Set the attenuation level when the gate of the microphone input channel is closed.

5. Assign signals to the output buses.

ON (Purple)	Audio signals processed by SmartMixer are output when SmartMixer is turned ON.
ON (Blue)	Assigned to the output bus. Even when the Smart Mixer is on, the audio signal is output through the Smart Mixer.
OFF	Not assigned to any output bus.

6. Set "Last Mic On", "Gate Hold Time", "NOMA", "Num of Open Mics", "Fixed Threshold", and "Threshold Level".

Last Mic On	When this is set to ON, the last opened microphone input channel gate remains open.
Hold Time	Set the time after the audio input is ceased until the microphone input channel gate is closed.
NOMA	This function is used to attenuate the output according to the number of open microphone input channel gates. It is recommended that "NOMA" be set to ON to prevent howling.
Num of Open Mics	Limit the number of microphone input channel gates that open simultaneously. Change this value according to the operating method.
Priority Mode	Either mode of the following applies when the number of microphone input channel gates that currently open reaches the "Num of Open Mics". Mode 1: Channels cannot be opened even if their "Priority" is ON. Mode 2: Channels can be opened if their "Priority" is ON.
Fixed Threshold	This function locks the level at which the microphone input channel gate opens.
Threshold Level	Set the level at which the microphone input channel gate opens.

Setting gain sharing mode SmartMixer

Configure all settings using Web Remote.

1. Click "Smart Mix".



2. From "Mode", select "Gain Share".



Key functions

- 3. Click "Enabled" for each channel that should operate with the SmartMixer function.
 - Click to turn ON (blue).



- 4. Set "Weight" for each channel, as necessary.
 - The gain to be distributed can be adjusted. This can be used also to balance the background noise for each channel.

- 5. Assign signals to the output buses.

ON (Purple)	Audio signals processed by SmartMixer are output when SmartMixer is turned ON.
ON (Blue)	Assigned to the output bus. Even when the Smart Mixer is on, the audio signal is output through the Smart Mixer.
OFF	Not assigned to any output bus.

- 6. Monitor the gain meter of each channel to confirm that the total gain is distributed based on the input signals.

Key functions

Audio-Technica LINK

This product can daisy-chain up to eight ATDM-0604a units to support 48 mic/line inputs and 8 unbalanced stereo audio inputs for the entire system. The proprietary Audio-Technica LINK functionality enables the transmission of low-latency, high-speed audio bus signals between devices, making it possible to steadily control and transmit uncompressed audio signals.

Furthermore, the model offers excellent workability as it conforms to the Ethernet standards and can be connected to generic LAN cables (shielded cables of Cat5e or above with the conductor diameter size of 24 AWG or larger must be used).

Connection and setting procedures

1. Daisy-chain up to 8 ATDM-0604a units.

- Do not connect units in a ring pattern. Be sure to leave one of the LINK terminals of the ATDM-0604a at both ends of the connection unconnected.
- For connections, use a LAN cable of Cat5e or above with conductor diameter size of 24 AWG or larger (shielded cables are recommended).

Connection example

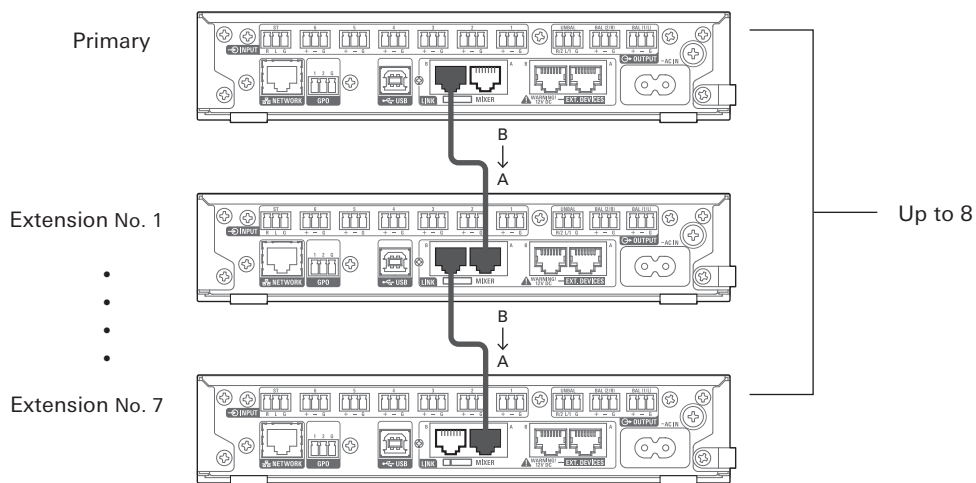

2. Start the web remote and configure the settings related to Audio-Technica LINK for each ATDM-0604a.

3. In "Audio-Technica LINK mode", set the ATDM-0604a connected at either end to be the "Primary".

- Do not set the ATDM-0604a connected in the middle as the "parent unit". The connection will not be recognized properly.

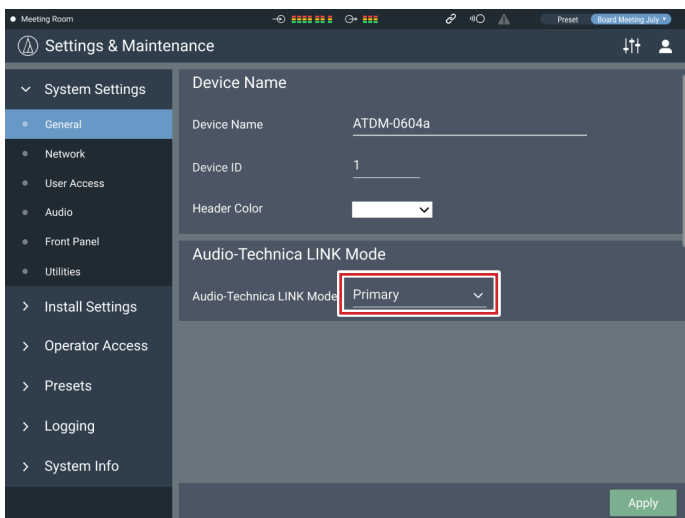

4. Other ATDM-0604a should be set to "Extension".

- Do not configure "Primary" settings on more than one ATDM-0604a.

Key functions

Sharing audio buses

During Audio-Technica LINK, the audio output buses (Output 1/L, Output 2/R, and Output ST) and the AEC reference signal bus are shared between each ATDM-0604a.

This allows any ATDM-0604a to output 48 mic/line inputs and 8 unbalanced stereo audio inputs. The AEC reference signals can also be shared among the devices.

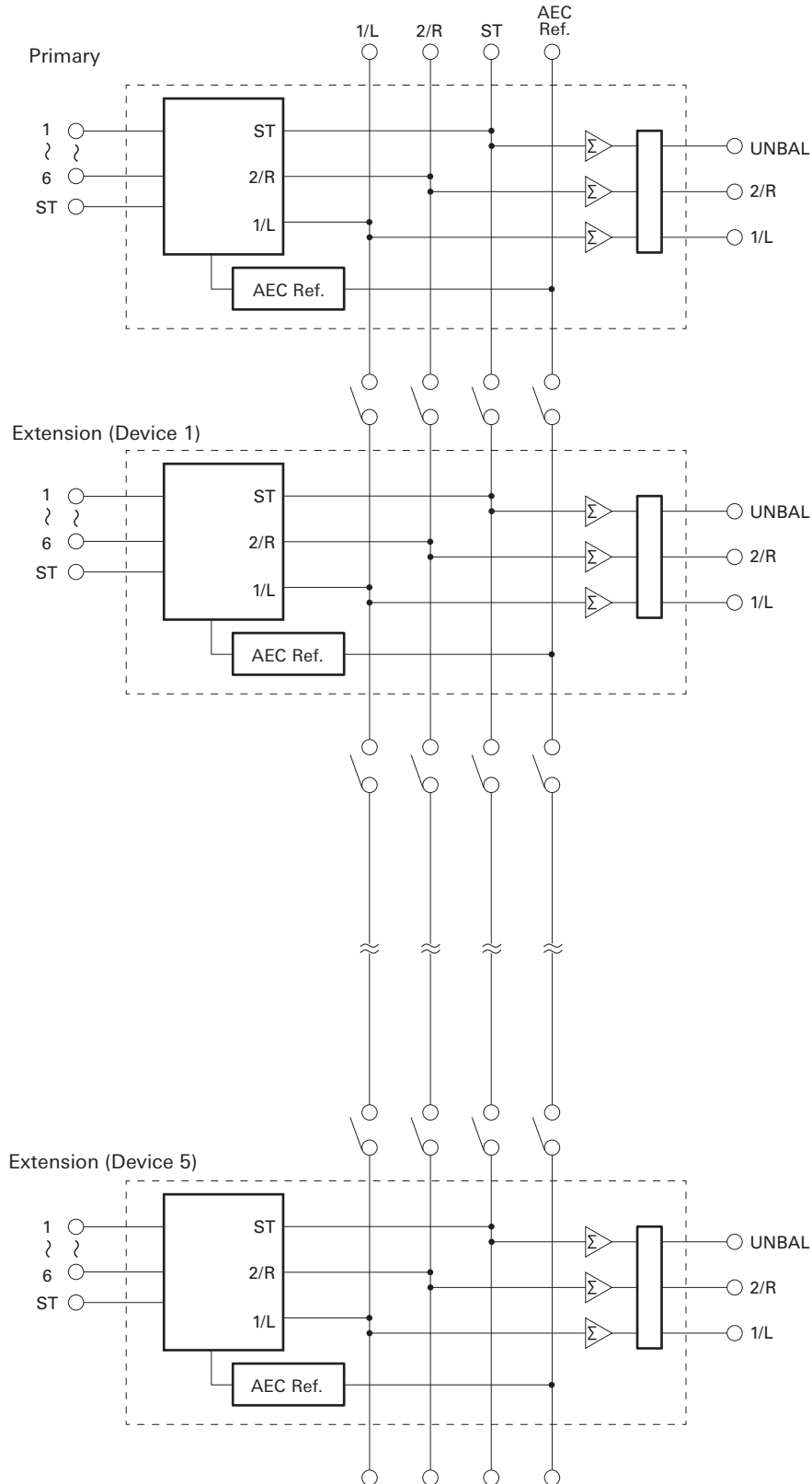

Key functions

Front panel operation restriction

The following two modes are available when operating the product with the buttons and the dial on the front panel.

Operator mode:

In this mode, daily operations are performed, such as loading the preset settings and adjusting the audio level.

Advanced mode:

In this mode, advanced settings can be configured by installing and implementing the product on-site.

When the power is turned on, the product usually starts in operator mode. This prevents accidental device setting changes or other troubles, and ensures a safe operation of the system.

This section explains how to restrict the front panel operation using Web Remote.

- The restriction cannot be activated in Advanced mode.
1. Select "Administrator", enter the password and click "Login".
 - If you are logged in as an operator, log out, and then log back in.

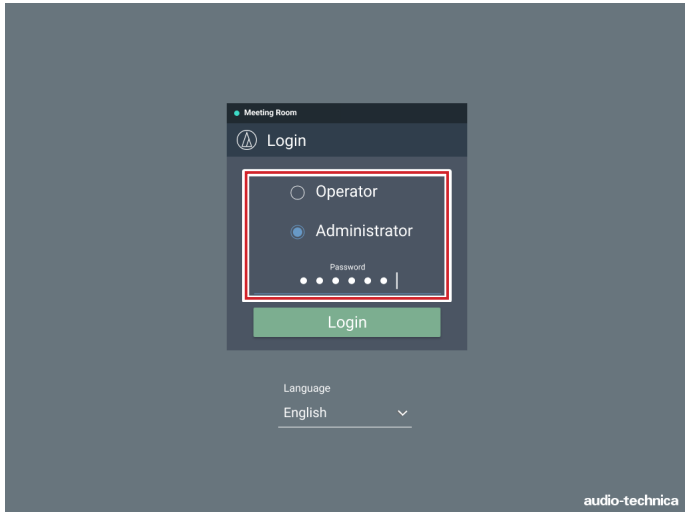

2. Click the icon (⚙️) on the top right of the screen.



3. Click "Front Panel".
4. In the "Levels" setting, set the operation restriction for the audio level adjustment.
 - If INPUT and OUTPUT for each channel are selected, the audio level for that channel can be adjusted.
 - Clear the check boxes not to allow these controls.
5. Using "Front Panel Restrictions", set whether or not to enable preset recall on the front panel of the product.
 - The setting is turned ON (blue)/OFF (no color) each time the switch is clicked.
6. Click "Apply".
 - Setting is complete.

Key functions

Recalling Preset

Operator screen

1. Click the green area at the top of the screen.

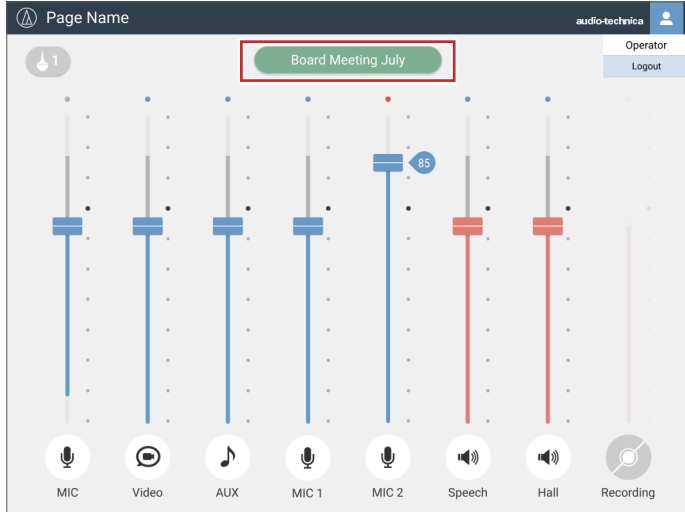

2. Select the preset of your choice from the pull-down menu.
 - The preset name appears, and the settings change based on the selected preset.

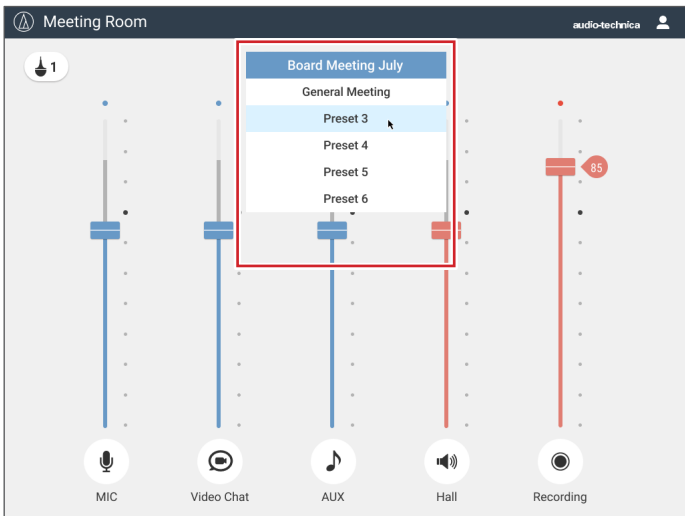

Administrator screen

1. Click "Preset" at the top right of the screen.



2. Select "Recall Preset" from the pull-down menu.
3. Select the preset of your choice.
 - The preset name appears, and the settings change based on the selected preset.

Key functions

About preset

The product includes preset patterns using a web or video conference.

Preset #1 (Initialization of audio settings)

- Reset the audio settings on the product to the factory defaults.
- All settings are deleted when initialized. Accordingly, it is recommended that the settings be saved to another preset or a hard disk space.
- The administrator password and IP address are not initialized. If you forget the administrator password or do not have the correct IP address to access the product, initialize the product system.

Preset #2 (Self-amplification)

This preset is suitable for self-amplification in a small- to mid-size conference room. It can also be used when amplification of the instructor with a speaker is necessary in a remote lecture or seminar. The product is equipped with a feedback suppressor for each output system to control howling. It is also equipped with a noise canceler that can reduce the fan noise generated by an air conditioning system or a projector and collect and amplify comfortable audio.

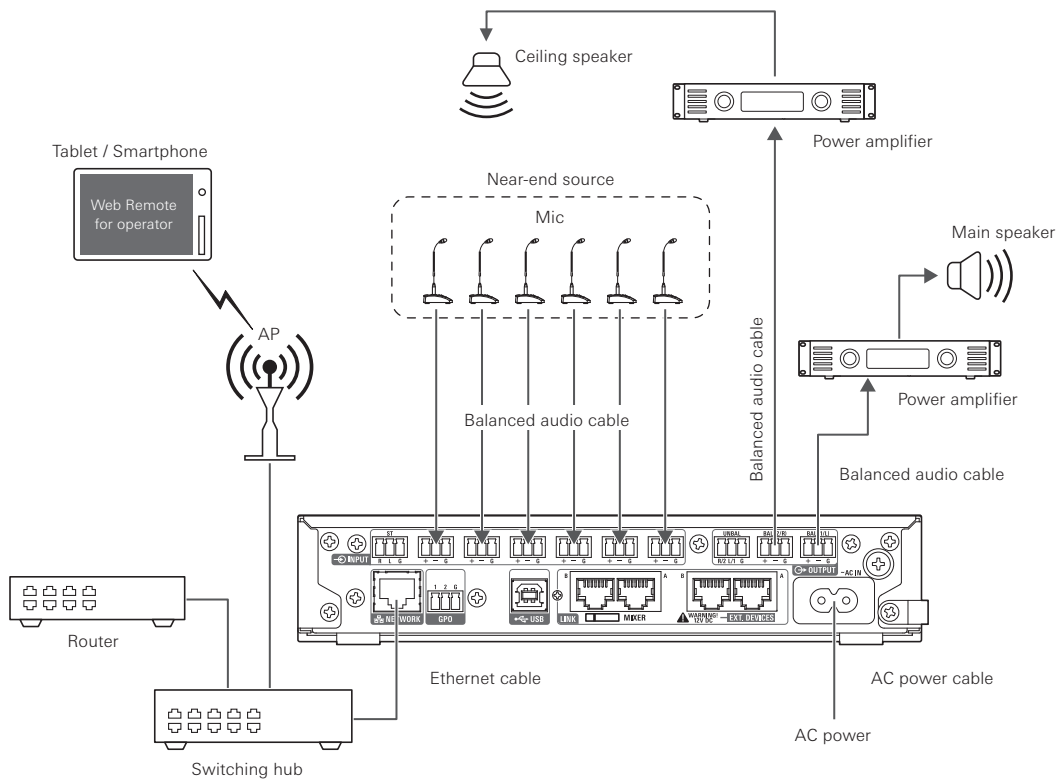

Key functions

Copying settings

The settings for a channel can be copied to another channel.

1. Click the icon (⚙️) of the source channel.



2. Click "Copy".



3. Select the a different source channel.

- To select a different channel, click the channel selected. The selection of the channel is canceled. Reselect the channel to copy.

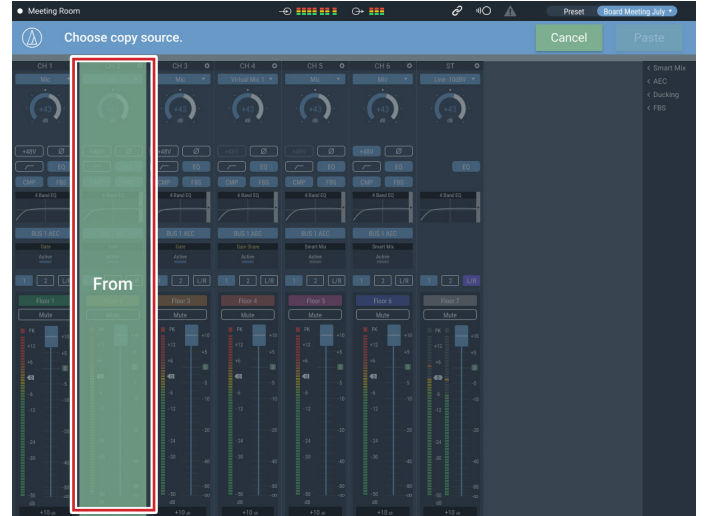

4. Select the target channel.

- To select a different channel, click the channel selected. The selection of the channel is canceled. Reselect the target channel.

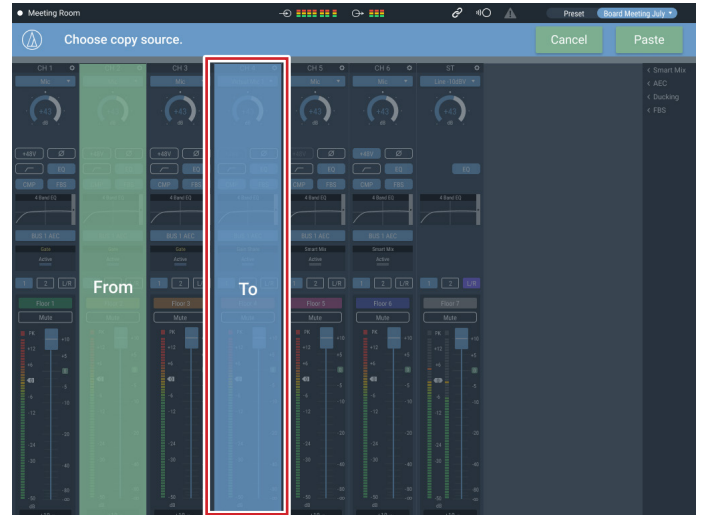

5. Click "Paste".

- To cancel the copying, click "Cancel". The screen returns to the previous screen.

Key functions

Resetting settings

The settings for a channel can be reset to the default settings.

1. Click the icon (⚙️) of the channel to reset.



2. Click "Reset".



Key functions

Linking channels

Link channels to share the settings. You can link only input channels 5 and 6.

1. Click the icon (⚙️) of the channels to be linked.



2. Click on "Link 5&6".



3. Confirm that the input channels have been linked.
 - The settings of the channel 6 are same as the settings of the channel 5.
 - The linked channel 6 are grayed out and cannot be used.

Key functions

Using the ES954 (Hanging Microphone Array)

Connecting and setting the ES954

1. Connect the ES954 to the ATDM-0604a.
 - Connect MIC1-4 of the ES954 to input channels 1-4 of the ATDM-0604a.

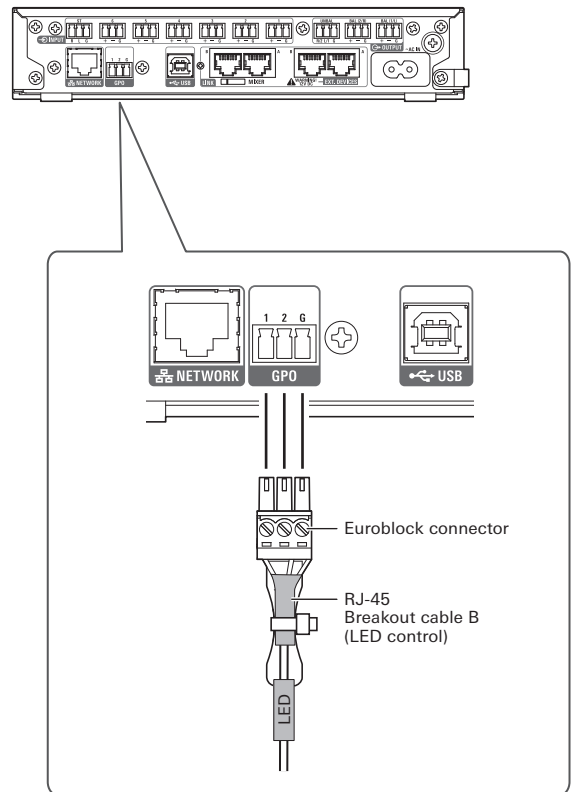
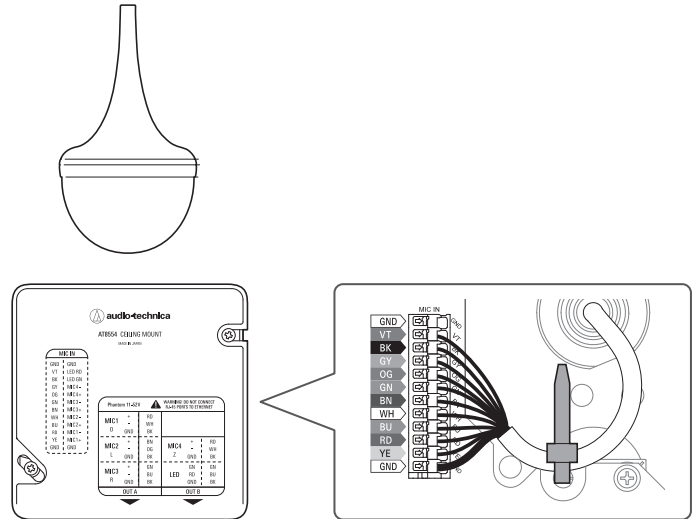
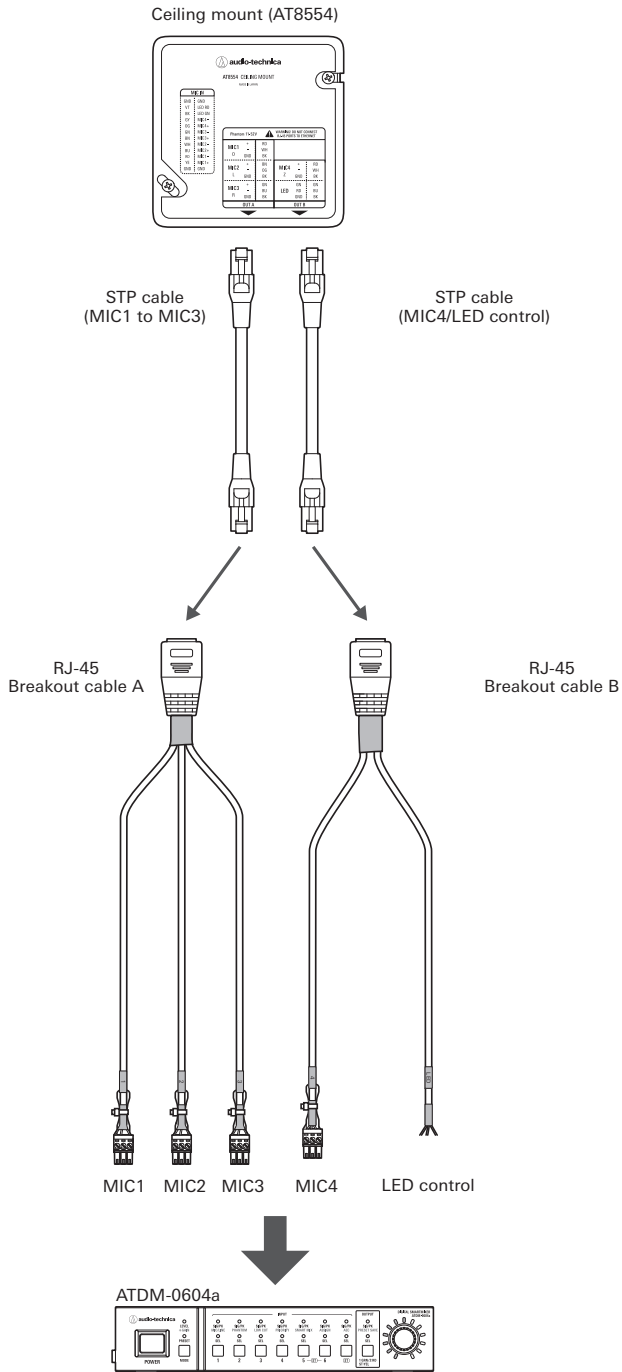

Key functions

Setting the Administrator Page

1. Start Web Remote and log in as "Administrator".

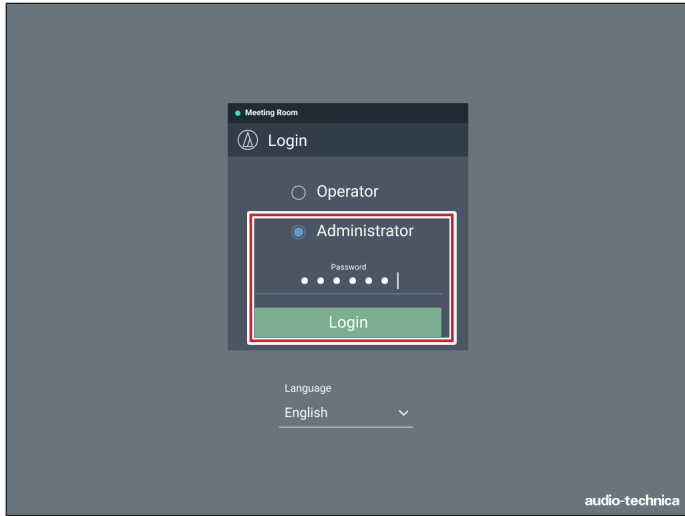

2. Click the icon (⚙️) at the upper right of the screen.



3. Click "Audio".

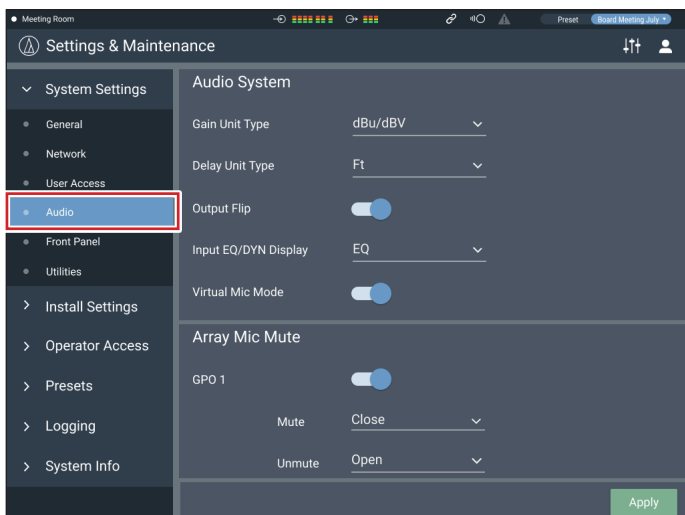

4. Turn on "Virtual Mic Mode".

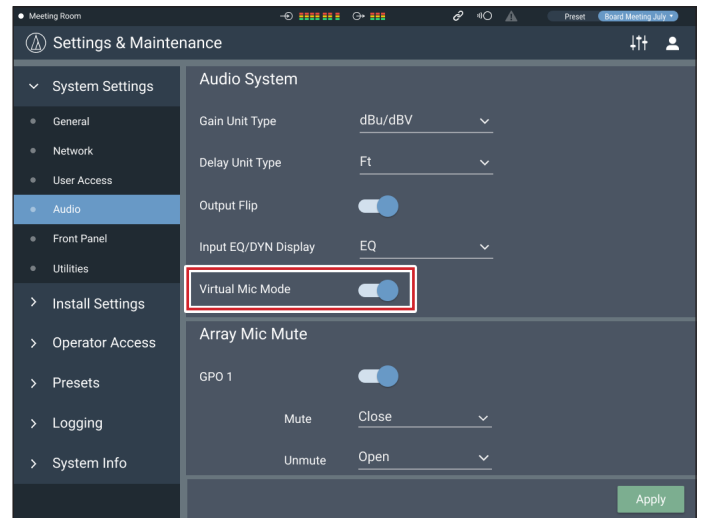

5. Sets the mute function by GPO.

- When "Mute" is set to "Close" and "Unmute" is set to "Open" for "GPO1" and "GPO2", the ES954 ring color when muted can be set as follows.
 - Only "GPO1" is ON: LED Green
 - Only "GPO2" is ON: LED Red
 - "GPO1" and "GPO2" ON: LED Orange

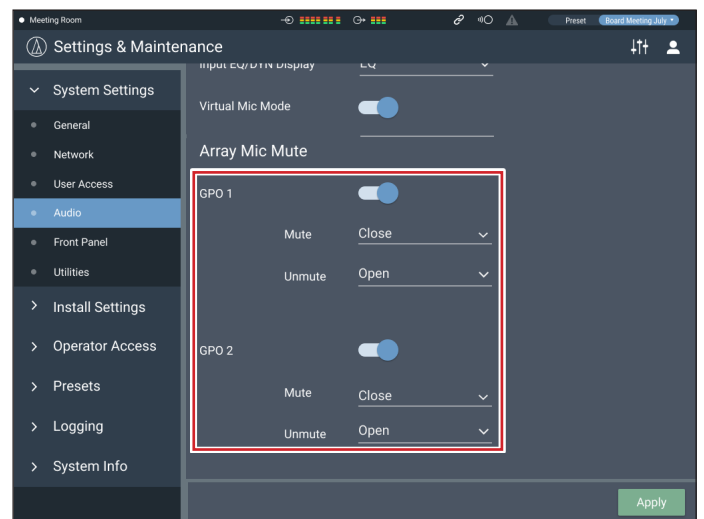

6. Click "Apply".

- The input types for input channels 1 to 4 automatically set to "Virtual Mic".
- The phantom power for input channels 1 to 4 turn "ON" automatically.

7. Click the screen switch icon (⏏️).

Key functions

- Set "Input gain", "Low-cut", "EQ", "Smart Mix", "Assign", and "Volume" as necessary.
 - Input gain values on channels set as "Virtual Mic" are linked.
 - "Low-cut", "EQ", "Smart Mix", "Assign", and "Volume" can be set for each channel.



- Click the right side of the virtual mic box for additional settings.



- Set the "Orientation," "Pattern," and "Tilt" of the virtual microphone for each channel.

Orientation	Click the buttons around the virtual polar pattern to set the orientation of each virtual mic input channel. "Front" indicates the side that has the audio-technica logo on the ES954.
Pattern	Select "Wide", "Normal", or "OMNI" for the virtual mic polar pattern.
Tilt	Adjust the directivity of the vertical plane.

Key functions

Setting the Operator Page

1. Start Web Remote and log in as “Administrator”.

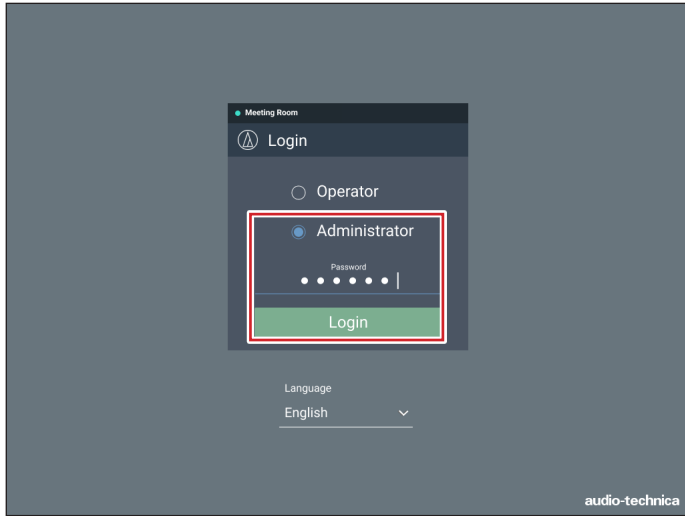

2. Click the icon (⚙️) at the upper right of the screen.



3. Click “Operator Page”.

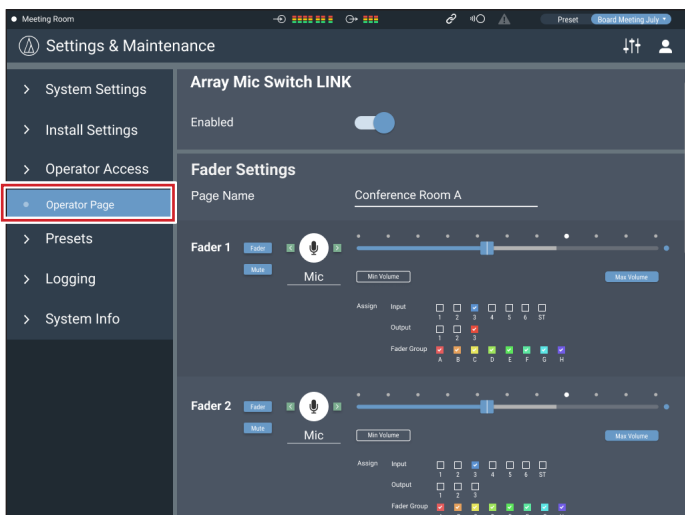

4. Turn on “Array Mic Switch”.

5. Log out and then log in again as an “Operator”.

6. You can turn the array mic and LED ring on or off by clicking the Array Mic icon.
- The array mic on/off status is not saved. (After restarting the product, it is on.)
 - The array mic on/off status cannot be configured as part of a preset.

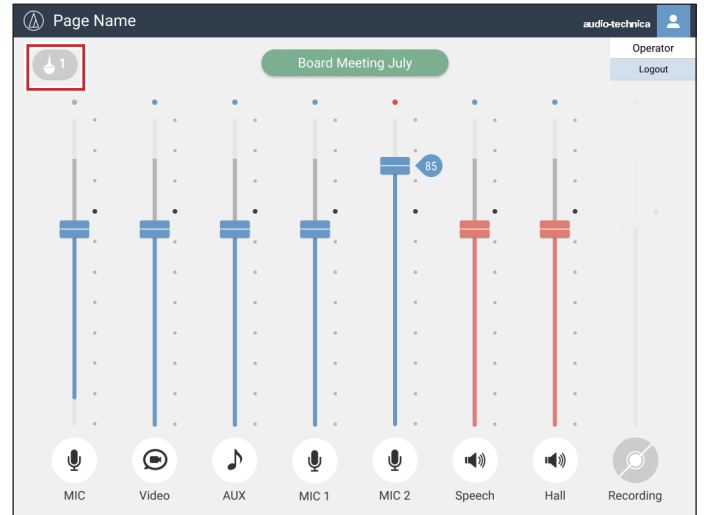

Key functions

Ducking function

The mixer has a ducking function on input channel ST.

The function automatically reduces the background music volume or returns it to the original volume. It is useful for situations in which background music is playing and there are announcements to be made.

Enabling Ducking

1. Start Web Remote and log in as "Administrator".

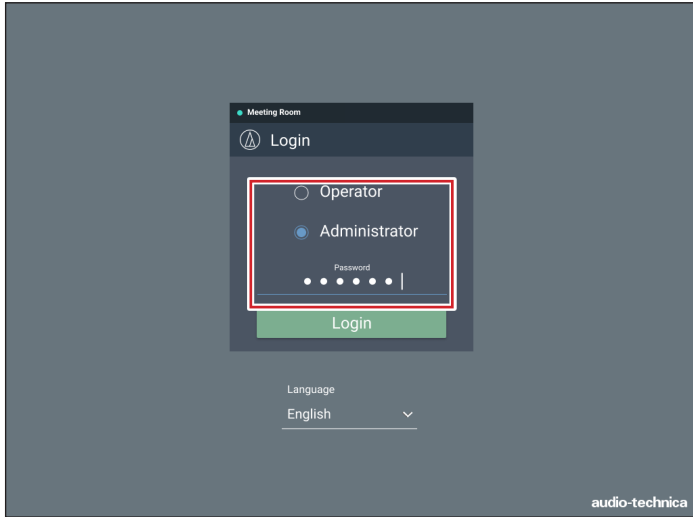

2. Click "Ducking".



3. Click on "Enabled"

- The signal assigned to BUS1 becomes the trigger, and ducking is applied to input channel ST.

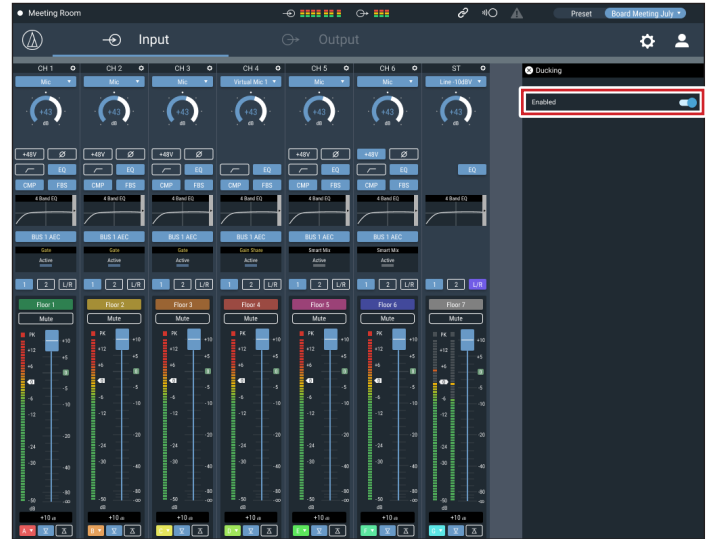

Menu Item

Audio Settings

Input

Item name				Setting values	Default Setting	Presets Included	Resumed			
Input channel 1 to 6	CH #			CH 1 to 6	-	-	-			
	Mode Select* ¹			CH1-4: MIC, LINE -10dBV, Virtual Mic CH5, 6: MIC, LINE +4dBu, LINE 0dBV, LINE -10dBV, LINE -20dBV, Virtual Mic	Mic	✓	✓			
	Input gain			+20dB to +60dB -20dBu to -60dBu	+20	✓	✓			
	Phantom power			On, Off	Off	✓	✓			
	Phase			On, Off	Off	✓	✓			
	Lowcut (120Hz, -12dB/oct)			On, Off	Off	✓	✓			
	4 Band EQ			On, Off	Off	✓	✓			
	CMP			On, Off	Off	✓	✓			
	FBS			On, Off	Off	✓	✓			
	BUS 1 AEC			On, Off	Off	✓	✓			
	BUS 2 AEC					✓	✓			
	BUS ST AEC					✓	✓			
	Smart Mix			Disable, Enable, Priority, Mixing	Disable	-	-			
	Output 1 Bus			On, Off	Off	✓	✓			
	Output 2 Bus			On, Off	Off	✓	✓			
	Output ST ^{BUS*2}			On, Off	Off	✓	✓			
	Levels			-∞, -120dB to +10dB	-∞	✓	✓			
	CH Name			(Maximum 10 byte)	CH 1 to 6	✓	✓			
	CH Color			Green, Yellow, Brown, Red, Pink, Blue, Gray, Dark Gray	Green	✓	✓			
	CH mute			On, Off	Off	✓	✓			
	Link 5 &6 (CH 5, 6 only)			Unlink 5&6, link 5&6	Unlinked 5&6	✓	✓			
	Max Volume			On, Off	Off	✓	✓			
	Min Volume			On, Off	Off	✓	✓			
	Copy			-	-	-	-			
	Reset			-	-	-	-			
Input channel ST	CH #			ST	-	-	-			
	Mode Select			LINE -10dBV, LINE -20dBV, USB	LINE -10dBV	✓	✓			
	Input gain			-20dB to +20dB	0	✓	✓			
	4 Band EQ			On, Off	Off	✓	✓			
	Output 1 Bus			On, Off	Off	✓	✓			
	Output 2 Bus			On, Off	Off	✓	✓			
	Output ST BUS* ²			On, Off	Off	✓	✓			
	Levels			-∞, -120dB to +10dB	-∞	✓	✓			
	CH Name			(Maximum 10 byte)	AUX	✓	✓			
	CH Color			Green, Yellow, Brown, Red, Pink, Blue, Gray, Dark Gray	Green	✓	✓			
	CH mute			On, Off	Off	-	✓			
	Max Volume			On, Off	Off	✓	✓			
	Min Volume			On, Off	Off	✓	✓			
	Copy			-	-	-	-			
Reset			-	-	-	-				
Virtual Mic	Orientation			0 to 330deg	0deg	✓	✓			
	Pattern			Wide, Normal, OMNI	Normal	✓	✓			
	Tilt			0deg, 45deg	0deg	✓	✓			
Feedback Suppressor Setting	CH 1-6, ST	Band 1-8	Frequency	-	-	-	-			
			Band	On, Off	Off	✓	✓			
	Detection			Low, Mid, High	High	✓	✓			
	Response			Slow, Fast	Fast	✓	✓			
	Reset			On, Off	Off	-	-			
4 Band EQ Settings	Recall Library	Easy mode	Type Select							
			Tone			High, Mid, Low	Mid	✓	✓	
								Warm, Warm-1, Warm-2, Warm-3, Warm-4, Warm-5, Warm-6, Natural, Bright-6, Bright-5, Bright-4, Bright-3, Bright-2, Bright-1, Bright	Natural	✓

Menu Item

Item name		Setting values	Default Setting	Presets Included	Resumed	
4 Band EQ	Expert mode	Band #1 Gain	-18dB to +18dB	0	✓	✓
		Band #1 Frequency	20Hz to 20kHz	25	✓	✓
		Band #1 Q value	0.3 to 60	0.75	✓	✓
		Band #1 Filter type	HPF , LSH , PEQ	PEQ	✓	✓
		Band #2 Gain	-18dB to +18dB	0	✓	✓
		Band #2 Frequency	20Hz to 20kHz	63	✓	✓
		Band #2 Q value	0.3 to 60	0.75	✓	✓
		Band #3 Gain	-18dB to +18dB	0	✓	✓
		Band #3 Frequency	20Hz to 20kHz	6.3k	✓	✓
		Band #3 Q value	0.3 to 60	0.75	✓	✓
		Band #4 Gain	-18dB to +18dB	0	✓	✓
		Band #4 Frequency	20Hz to 20kHz	16k	✓	✓
		Band #4 Q value	0.3 to 60	0.75	✓	✓
		Band #4 Filter type	LPF, HSH, PEQ	PEQ	✓	✓
		Reset all band	-	-	-	-
		Dynamics Setting	Comp/DeEsser	Comp, DeEsser	Comp	✓
	Compressor		Ratio	1:1.4, 1:2, 1:4, 1:6, 1:10, 1:∞	1:2	✓
Threshold			-60 to 0dB	-10	✓	✓
Attack			0ms, 0.25ms, 0.5ms, 1ms, 2ms, 4ms, 8ms, 16ms, 32ms, 100ms	1	✓	✓
Release			50ms, 100ms, 200ms, 400ms, 800ms, 1000ms, 2000ms	400	✓	✓
Output	Gain		+10dB to -10dB	0	✓	✓
DeEsser	Band 1 Frequency		20Hz to 20kHz	1.6k	✓	✓
	Band 1 Q value		0.3 to 60	0.75	✓	✓
	Band 1 Gain		0dB to +18dB	0	✓	✓
	Band 1 Filter type		HPF, LSH, PEQ	PEQ	✓	✓
	Band 2 Frequency		20Hz to 20kHz	1.6k	✓	✓
	Band 2 Q value		0.3 to 60	0.75	✓	✓
	Band 2 Gain		0dB to +18dB	0	✓	✓
	Band 2 Filter type		HPF, LSH, PEQ	PEQ	✓	✓
Low Cut	On, Off	On	✓	✓		
Listen	On, Off	Off	-	-		

*1 "MIC" cannot be selected when " link 5#6 " is selected.

When "Array Mic Switch" is enabled, Ch1 to 4 change to "Virtual Mic".

*2 When "Output Flip" is turned on, the OUTPUT ST notation changes to OUTPUT L/R.

Menu Item

Smart Mix

Item name			Setting values	Default Setting	Presets Included	Resumed
Smart Mix	Mode		Off, Gate, Gain Share	Gain Share	✓	✓
	Last Mic On		On, Off	Off	✓	✓
	Hold Time		0.1 to 10.0 seconds	2.5	✓	✓
	NOMA		On, Off	Off	✓	✓
	Num of Open Mics		1-10	6	✓	✓
	Priority Mode		Mode1, Mode2	Mode1	✓	✓
	Fixed Threshold		On, Off	Off	✓	✓
Threshold Level		-80 to 0	-50	✓	✓	

AEC

Item name			Setting values	Default Setting	Presets Included	Resumed	
AEC	Mode		Off, AEC, NC	AEC	✓	✓	
	Input Bus		1, 2, ST	1	✓	✓	
	Output		1, 2, ST	Off	✓	✓	
	AEC Reference		OUT1, OUT2, OUT ST	OUT1	✓	✓	
	NC Settings	NC Attenuation Level		0dB to 20dB	6	✓	✓
		NLP		On, Off	On	✓	✓
	NLP Sensitivity		Low, Mid, High	Mid	✓	✓	

Ducking

Item name			Setting values	Default Setting	Presets Included	Resumed
Ducking	Enabled		On, Off	Off	✓	✓

FBS

Item name			Setting values	Default Setting	Presets Included	Resumed
CMP/FBS	IN 1-6		Off, FBS	Off	✓	✓
	OUT 1, 2, ST		Off, FBS	Off	✓	✓

Menu Item

Output

Item name				Setting values	Default Setting	Presets Included	Resumed
Channels 1 and 2	CH #			OUT 1, 2	-	-	-
	Unity			+4dBu, 0dBV, -10dBV	+4dBu	✓	✓
	FBS			On, Off	Off	✓	✓
	EQ			On, Off	Off	✓	✓
	CMP			On, Off	Off	✓	✓
	LMT			On, Off	Off	✓	✓
	Delay	Enabled		On, Off	Off	✓	✓
	CH Name			(up to 30 characters (ASCII code only))	OUT1~2	✓	✓
	CH Color			Green, Yellow, Brown, Red, Pink, Blue, Gray, Dark Gray	Green	✓	✓
	Channel Mute (Mute)			On, Off	Off	✓	✓
	Levels			- ∞, -120dB to +10dB	-40dB	✓	✓
	Max Volume			On, Off	Off	✓	✓
	Min Volume			On, Off	Off	✓	✓
	Copy			-	-	-	-
	Reset			-	-	-	-
Channel ST	CH #			ST	-	-	-
	Unity			-10dBV, -33dBV	-10dBV	✓	✓
	FBS			On, Off	Off	✓	✓
	EQ			On, Off	Off	✓	✓
	CMP			On, Off	Off	✓	✓
	LMT			On, Off	Off	✓	✓
	Delay	Enabled		On, Off	Off	✓	✓
	CH Name			(up to 30 characters (ASCII code only))	ST	✓	✓
	CH Color			Green, Yellow, Brown, Red, Pink, Blue, Gray, Dark Gray	Green	✓	✓
	Channel Mute (Mute)			On, Off	Off	✓	✓
	Levels			- ∞, -120dB to +10dB	-40dB	✓	✓
	Max Volume			On, Off	Off	✓	✓
	Min Volume			On, Off	Off	✓	✓
	Copy			-	-	-	-
	Reset			-	-	-	-
Feedback Suppressor Setting	OUT 1-2, ST	Band 1-8	Frequency	-	-	-	-
			Band	On, Off	Off	✓	✓
			Detection	Low, Mid, High	High	✓	✓
			Response	Slow, Fast	Fast	✓	✓
			Reset	On, Off	Off	-	-
			All Static	On, Off	Off	-	-
12 Band EQ Setting	OUT 1-2, ST	Band 1		On , Off	On	✓	✓
		Effective					
		Band 1 Gain		-18dB to +18dB	0	✓	✓
		Band 1		20Hz to 20kHz	20	✓	✓
		Frequency					
		Band 1 Q value		0.3 to 60	0.75	✓	✓
		Band 1 Filter type		HPF , LSH, PEQ	PEQ	✓	✓
		Band 2 Enabled		On , Off	On	✓	✓
		Band 2 Gain		-18dB to +18dB	0	✓	✓
		Band 2		20Hz to 20kHz	30	✓	✓
		Frequency					
		Band 2 Q value		0.3 to 60	0.75	✓	✓
		Band 3 Enabled		On , Off	On	✓	✓
		Band 3 Gain		-18dB to +18dB	0	✓	✓
		Band 3		20Hz to 20kHz	60	✓	✓
		Frequency					
		Band 3 Q value		0.3 to 60	0.75	✓	✓
		Band 4		On , Off	On	✓	✓
		Effective					
		Band 4 Gain		-18dB to +18dB	0	✓	✓
Band 4		20Hz to 20kHz	120	✓	✓		
Frequency							
Band 4 Q value		0.3 to 60	0.75	✓	✓		

Menu Item

Item name		Setting values		Default Setting	Presets Included	Resumed
12 Band EQ Setting	OUT 1-2, ST	Band 5 Effective	On, Off	On	✓	✓
		Band 5 Gain	-18dB to +18dB	0	✓	✓
		Band 5 Frequency	20Hz to 20kHz	240	✓	✓
		Band 5 Q value	0.3 to 60	0.75	✓	✓
		Band 6 Effective	On, Off	On	✓	✓
		Band 6 Gain	-18dB to +18dB	0	✓	✓
		Band 6 Frequency	20Hz to 20kHz	500	✓	✓
		Band 6 Q value	0.3 to 60	0.75	✓	✓
		Band 7 Effective	On, Off	On	✓	✓
		Band 7 Gain	-18dB to +18dB	0	✓	✓
		Band 7 Frequency	20Hz to 20kHz	1k	✓	✓
		Band 7 Q value	0.3 to 60	0.75	✓	✓
		Band 8 Effective	On, Off	On	✓	✓
		Band 8 Gain	-18dB to +18dB	0	✓	✓
		Band 8 Frequency	20Hz to 20kHz	2k	✓	✓
		Band 8 Q value	0.3 to 60	0.75	✓	✓
		Band 9 Effective	On, Off	On	✓	✓
		Band 9 Gain	-18dB to +18dB	0	✓	✓
		Band 9 Frequency	20Hz to 20kHz	4k	✓	✓
		Band 9 Q value	0.3 to 60	0.75	✓	✓
		Band 10 Effective	On, Off	On	✓	✓
		Band 10 Gain	-18dB to +18dB	0	✓	✓
		Band 10 Frequency	20Hz to 20kHz	8k	✓	✓
		Band 10 Q value	0.3 to 60	0.75	✓	✓
		Band 11 Effective	On, Off	On	✓	✓
		Band 11 Gain	-18dB to +18dB	0	✓	✓
		Band 11 Frequency	20Hz to 20kHz	16k	✓	✓
		Band 11 Q value	0.3 to 60	0.75	✓	✓
		Band 12 Effective	On, Off	On	✓	✓
		Band 12 Gain	-18dB to +18dB	0	✓	✓
		Band 12 Frequency	20Hz to 20kHz	20k	✓	✓
		Band 12 Q value	0.3 to 60	0.75	✓	✓
		Band 12 Filter type	HPF, LSH, PEQ	PEQ	✓	✓
	Flat	-	-	-		
	EQ preset recall	-	-	-		
	EQ Preset Saving	-	-	-		
	Reset	-	-	-		

Menu Item

Item name			Setting values	Default Setting	Presets Included	Resumed	
Dynamics Setting	Pre/Post		Pre, Post	Post	✓	✓	
	Comp/DeEsser		Comp, DeEsser	Comp	✓	✓	
	Compressor	Ratio		1:1.4, 1:2, 1:4 1:6 1:10, 1:∞	1:2	✓	✓
		Threshold		-60 to 0dB	-10	✓	✓
		Attack		0ms, 0.25ms, 0.5ms, 1ms, 2ms, 4ms, 8ms, 16ms, 32ms, 100ms	1	✓	✓
		Release		50ms, 100ms, 200ms, 400ms, 800ms, 1000ms, 2000ms	400	✓	✓
	Output	Gain		+10dB to -10dB	0	✓	✓
	Limiter	Threshold		-60dB to 0dB	0	✓	✓
	DeEsser	Band 1	Frequency	20Hz to 20kHz	1.6k	✓	✓
			Band 1 Q value	0.3 to 60	0.75	✓	✓
			Band 1 Gain	0dB to +18dB	0	✓	✓
			Band 1 Filter type	HPF, LSH, PEQ	PEQ	✓	✓
		Band 2	Frequency	20Hz to 20kHz	1.6k	✓	✓
			Band 2 Q value	0.3 to 60	0.75	✓	✓
			Band 2 Gain	0dB to +18dB	0	✓	✓
			Band 2 Filter type	HPF, LSH, PEQ	PEQ	✓	✓
		Low Cut		On, Off	On	✓	✓
		Listen		On, Off	Off	-	-

USB OUT

Item name			Setting values	Default Setting	Presets Included	Resumed
USB OUT	Bus Select	OUT 1	OFF, 1, 2, ST(L), NC	OFF	✓	✓
		OUT 2	OFF, 1, 2, ST(R), NC	OFF	✓	✓
	Level		-∞, -120dB to 0dB	0	✓	✓

Oscillator

Item name			Setting values	Default Setting	Presets Included	Resumed
Oscillator	Enabled		On, Off	Off	-	-
	Source		Sine Wave, Pink Noise	Sine Wave	-	-
	Frequency		100Hz, 1kHz, 10kHz	1kHz	-	-
	Level		-∞, -120dB to 0dB	-∞	-	-
	Assign	OUT 1 to 1, ST		Enable, Disable	Disable	-

FBS

Item name			Setting values	Default Setting	Presets Included	Resumed
FBS	IN 1-6		Off, FBS	Off	✓	✓
	OUT 1 to 2		Off, FBS	Off	✓	✓
	ST		Off, FBS	Off	✓	✓

Menu Item

Settings & Maintenance

System Settings

General

Item name		Setting values	Default Setting	Presets Included	Resumed
Device Name	Device Name	(Maximum 30 characters (ASCII code only))	ATDM-0604a	-	✓
	Equipment ID	0 to 255	0	-	✓
	Header Color	White, Green, Yellow, Orange, Purple, Cyan	White	-	✓
Audio-Technica LINK Mode	Audio-Technica LINK Mode	Primary, Extension	Primary	-	✓

Network

Item name		Setting values	Default Setting	Presets Included	Resumed
IP Control / Web Remote Port Settings	IP Config Mode	Auto, Static	Auto	-	✓
	IP Address	0.0.0.0 to 255.255.255.255	-	-	✓
	Subnet Mask	0.0.0.0 to 255.255.255.255	-	-	✓
	Gateway Address	0.0.0.0 to 255.255.255.255	-	-	✓
Allow Discovery	Enabled	On, Off	On	-	✓
IP Control Settings	Port Number	00001 to 65535	17300	-	✓
	Notification	On, Off	Off	-	✓
	Audio Level Notification	On, Off	Off	-	✓
	Multicast Address	0.0.0.0 to 255.255.255.255	239.0.0.100	-	✓
	Multicast Port Number	00001 to 65535	17000	-	✓
NTP Settings	Enabled	On, Off	Off	-	✓
	Server Address	0.0.0.0 to 255.255.255.255	-	-	✓
	Port Number	00001 to 65535	123	-	✓
	Time Zone	UTC -12:00 to +14:00	00:00	-	✓
	Daylight Saving Time	On, Off	Off	-	✓
	Start Date & Time	1/1-12/31, 0:00-23:00	3/27, 2:00	-	✓
	End Date & Time	1/1-12/31, 0:00-23:00	10/30, 2:00	-	✓

Restrict Access

Item name		Setting values	Default Setting	Presets Included	Resumed
Default Front Panel Mode	Default Front Panel Mode	Operator, Administrator	Operator	-	✓
Login Password	Administrator Password	On, Off (Minimum 4, Maximum 8 characters (alphabet and number only))	Off	-	✓
Operator Page Permissions	Restrict Access	On, Off	Off	-	✓
	Permission IP1 to IP5	0.0.0.0 to 255.255.255.255	-	-	✓

Audio

Item name		Setting values	Default Setting	Presets Included	Resumed
Audio System	Gain Unit Type	dBu/dBV, dB	dB	-	✓
	Delay Unit Type	ms, m, Ft	ms	-	✓
	Output Flip	On, Off	Off	-	✓
	Input EQ/DYN Display	EQ, DYN	EQ	-	✓
	Virtual Mic Mode	On, Off	Off	-	✓
Array Mic Mute	GPO1	On, Off	Off	-	✓
	GPO2	On, Off	Off	-	✓

Menu Item

Front Panel

Item name				Setting values	Default Setting	Presets Included	Resumed
Levels	INPUT: 1 to 6CH, ST OUTPUT: 1, 2, ST			Enable, Disable	Enable	-	✓
LED Dimmer	Enabled			On, Off	Off	-	✓
Front Panel Restrictions	Enable Preset Recall			Enable, Disable	Enable	-	✓

Utilities

Item name				Setting values	Default Setting	Presets Included	Resumed
Firmware Update				-	-	-	-
Language Pack Install				-	-	-	-
Reset All Settings to Default				-	-	-	-

Operator Access

Operator Page

Item name				Setting values	Default Setting	Presets Included	Resumed
Array Mic Switch LINK	Enabled			On, Off	Off	-	✓
Fader Settings	Page Name			(Maximum 30 characters)	Page 1	✓	✓
	Fader 1 to 8	Fader		On, Off	Off (Fader 1: On)	✓	✓
		Mute		On, Off	Off (Fader 1: On)	✓	✓
		Name		(Maximum 10 characters (ASCII code only))	Mic	✓	✓
		Icon		Mic, Aux, PC, Chat, Spk, Rec	Mic	✓	✓
		Level		0 to 100	70	✓	✓
		Min Volume		On, Off	Off	✓	✓
		Max Volume		On, Off	Off	✓	✓
		Assign		INPUT: 1-6, ST OUTPUT: 1, 2, ST Fader Group: A to H	Off (INPUT1 1: On)	✓	✓
Operator Page Restrictions	Preset Recall			On, Off	On	✓	✓
	Number Of Presets			1 to 6	6	✓	✓
	Resume Fader Position			On, Off	Off	✓	✓
	Logout Button			On, Off	On	✓	✓
	Array Mic Switch			On, Off	Off	✓	✓

Menu Item

Presets

Presets

Item name				Setting values	Default Setting	Presets Included	Resumed
Presets	Preset Name			(Maximum 30 Byte)	Preset 1 to 6	✓	✓
	Boot Up Preset			1 to 6, Non	Non	-	✓
Presets Recall Linking	Presets Recall Linking			On, Off	On	-	✓

Partial Preset

Item name				Setting values	Default Setting	Presets Included	Resumed
Partial Preset	Preset Name			(max. 30 characters)	Partial Preset 1-40	✓	✓
Partial Preset Parameters	All Parameters			On, Off	Off	-	✓
	Input	AEC Reference	Level/Mute	On, Off	Off	-	✓
			Input CH	Level/Mute	On, Off	Off	-
		Input CH	Smart Mix/AEC	On, Off	Off	-	✓
			Group	On, Off	Off	-	✓
			Bus Assign (Bus 1)	On, Off	Off	-	✓
			Bus Assign (Bus 2)	On, Off	Off	-	✓
	Output	Output CH	Bus Assign (Bus ST)	On, Off	Off	-	✓
			Level/Mute	On, Off	Off	-	✓
	Operator Page	Fader	Group	On, Off	Off	-	✓
Level/Mute			On, Off	Off	-	✓	

4 Band EQ Library

Item name				Setting values	Default Setting	Presets Included	Resumed
4 Band EQ Library	EQ Preset Name			(Maximum 30 Byte)	EQ Preset 01 to 20	-	✓

12 Band EQ Library

Item name				Setting values	Default Setting	Presets Included	Resumed
12 Band EQ Library	EQ Preset Name			(Maximum 30 Byte)	EQ Preset 01 to 20	-	✓

Logging

Logging

Item name				Setting values	Default Setting	Presets Included	Resumed
Logging	Enabled			On, Off	On	-	✓
	Destination			Internal, Syslog	Internal	-	✓
	Log File			-	-	-	-

System Info

System Info

Item name				Setting values	Default Setting	Presets Included	Resumed
System Info				-	-	-	-

Troubleshooting

If you encounter a problem, please check the following.

- Check whether all connections are correct.
- Check whether the system is being operated according to the instructions provided in the manual.
- Check whether the external devices are functioning properly. Check the devices without connecting them to the product.
- Restart the network devices.

If any of the devices in the system are not functioning properly, check the troubleshooting tips below.

If none of the tips apply, please contact your local Audio-Technica dealer.

You may be asked to provide the version of your firmware. Please check in advance and have the firmware version handy.

To find the firmware version on the product: Refer to p.16.

To find the firmware version via Web Remote: Refer to p.46.

ATDM-0604a main unit

Error Message	Cause
No power supply .	Check whether the power cable is connected correctly.
The connected microphone does not function.	Check whether the microphone is connected correctly.
	Make sure MIC is selected for the input type (MIC/LINE).
	Check whether the phantom power is turned on when using a condenser microphone.
	Check the gain.
	Check the input level.
No sound comes out of the connected speaker. The sound is distorted.	Check the connections of all devices.
	Check whether the phantom power is turned on when using a condenser microphone.
	Check whether a device that does not require phantom power is connected with the phantom power turned ON. If phantom power is supplied to a device that does not require it, the device may malfunction.
	Check and adjust the settings on the connected amplifier.
	Check whether the balanced cable is damaged.
	Make sure that the balanced cable is securely inserted all the way.
	Check whether the input and output terminals are connected correctly.
	Check whether the pin assignments are correct for the input and output terminals.
	Check that the input level and/or the output level is not set too low.
	Check whether mute is turned ON.
The sound is strange.	Adjust the input gain.
	If the sound is muffled or the volume is not sufficient, check the setting of each equalizer.
The howling cannot be suppressed.	Check the setting of the FBS (feedback suppressor). If howling that exceeds the number of filters is occurring, the howling cannot be controlled completely.
Front panel buttons are not responding .	Check that the front panel is not locked.

Troubleshooting

Web Remote

Error Message	Cause/Action
You cannot "locate" the product.	Check the connections of the product and the control device, such as a computer.
	Check whether the product and the control device, such as a computer, are connected to the same network.
	Check the firewall settings.
Web Remote cannot be opened from a control device, such as an iPad or another tablet.	Check whether the control device is connected to the correct access point.
	Check whether the product and the control device, such as an iPad or another tablet, are connected to the same network.
You forgot the password.	<p>Reset the password based on the following procedure.</p> <ol style="list-style-type: none">1. Press the power button to start the product.2. Press the MODE button, or turn the dial button while pressing the MODE button, to select "PRESET".3. While pressing the OUTPUT SEL button, turn the dial button three clicks to the right.4. While pressing the OUTPUT SEL button, turn the dial button three clicks to the left.5. While pressing the OUTPUT SEL button, press the dial button. <p>The Web Remote password is reset. Login again to Web Remote and set the password again as needed.</p>

Error messages

Symptom	Cause	Action
Resume Data Error	Importing the resume data failed. The product started with the previous or default settings.	Restart the product, and check whether the same error occurs.
Preset Data Error	Importing the preset data failed. The preset data is the one that was successfully imported last time or the default.	Restart the product, and check whether the same error occurs.
Library Data Error	Importing the EQ library data failed. The product started with the previous or default settings.	Restart the product, and check whether the same error occurs.
Audio-Technica LINK Connection Error	An error occurred in communication with the ATDM-0604a connected via Audio-Technica LINK. The operation of Audio-Technica LINK was stopped.	Check for any network connection problem.
Audio-Technica LINK OFF	The Audio-Technica LINK was canceled, and its operation was stopped.	Check for any network connection problem.
Detect Exceeded Link Units	The number of ATDM-0604a units available for connection has been exceeded. The operation of Audio-Technica LINK was stopped.	Check the number of units connected.
Detect Multi Primary Units	Multiple ATDM-0604a parent units detected. The operation of Audio-Technica LINK was stopped.	Set only one ATDM-0504a unit as the primary.
Detect Ring Connection	A ring connection was detected. The operation of Audio-Technica LINK was stopped.	Do not connect units in a ring pattern. Be sure to leave one of the LINK terminals of the ATDM-0604a at both ends of the connection unconnected.
Network Communication Error	A network communication error occurred.	Check for any network connection problem.
	An IP command communication error occurred.	
Access from Non Permitted Device	A device not permitted to access was connected.	Check for any network connection problem.
File Import Failed	Importing the preset file failed.	<ul style="list-style-type: none"> • Check whether the file format is correct. • The network connection may have been disconnected.
File Export Failed	Exporting the preset file failed.	The network connection may have been disconnected.
Failed	An unknown system failure occurred.	Perform the operation again, and check whether the same error occurs.
Please turn power OFF.	An error occurred during the firmware update.	Restart the product, and check whether the same error occurs.
Data acquisition error.	Acquisition of data via web remote failed.	Perform the operation again, and check whether the same error occurs.
USB Disconnected	The USB connection with the PC is not established.	<ul style="list-style-type: none"> • Check whether the USB connection with the PC is proper. • Connect the USB to another PC, and check whether the same error occurs.
Synchronous Disconnect	Synchronization with the PC failed.	<ul style="list-style-type: none"> • Check whether the USB connection with the PC is proper. • Connect the USB to another PC, and check whether the same error occurs.
Cannot COPY	The data cannot be copied because the EQ preset is full.	Check whether there is space in the EQ preset.
	Copying of the bands in static state to the 12-band EQ failed.	The bands for which EQ is set to OFF on the 12-band EQ side are to be copied. Check the settings.

Dimensions

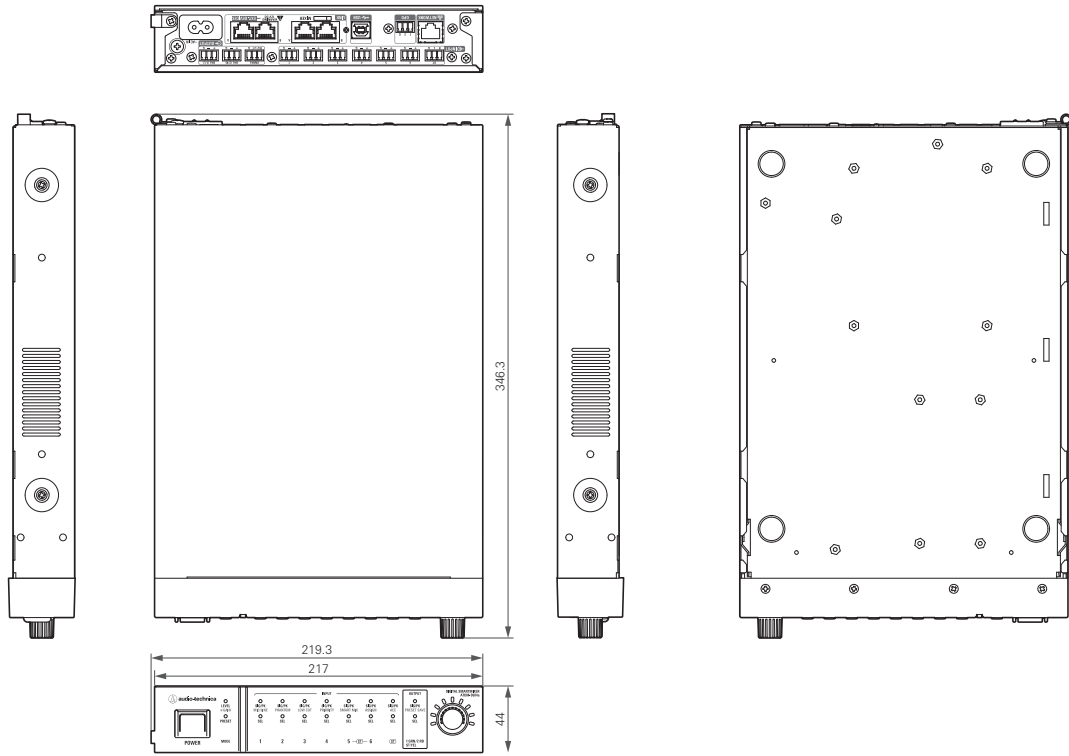

(Unit: mm)

Specifications

General specifications

Power supply	AC 100V to 240V 50/60Hz	
Power consumption	17W	
Operating temperature range	0 to 40°C (32 to 104°F)	
Operating humidity range	25 to 85% (with no condensation)	
Dimensions (including protrusions)	219.3 mm (8.6") × 346.3 mm (14") × 44 mm (1.7") (W×D×H)	
Weight	1.89 kg (4.2 lbs)	
Finish	Front Panel	Black with silver lines
	Top/rear/sides	Black

Audio

Frequency characteristics	20 Hz to 20 kHz (MIC -16 dBu)	+1.0/-1.0 dB
	20 Hz to 20 kHz (MIC -60 dBu)	+1.0/-2.0 dB
	20 Hz to 20 kHz (LINE 24 dBu)	+1.0/-1.0 dB
	20 Hz to 20 kHz (LINE -40 dBu)	+1.0/-2.0 dB
Dynamic range		110 dB or higher, A-weighted/ST
S/N ratio		90 dB or higher, A-weighted/ST
Headroom		20 dB or higher
Input referred noise		-126 dBu or less, Rs = 150 ohm, DIN
Common-mode rejection ratio		80 dB or higher, 1 kHz
Residual noise		-86 dBu or less, A-weighted
Maximum gain		64 dB
Channel separation		-80 dB or less, 1 kHz unity
Total harmonic distortion		0.03% or less, 1 kHz unity
Analog input	MIC1-6 max.	0 dBu
	MIC1-6 unity	-40 dBu
	LINE1-4 max.	+10 dBV
	LINE 1-4 unity	-10 dBV
	LINE 5-6 max.	+24 dBu
	LINE 5-6 unity	+4 dBu/0 dBV/-10 dBV/-20 dBV
	ST max.	+10 dBV
	ST unity	-10 dBV/-20 dBV
Analog output	UNBAL max.	+10 dBV/-13 dBV
	UNBAL unity	-10 dBV/-33 dBV
	BAL 1/L, 2/R max.	+24 dBu / +20 dBV / +10 dBV
	BAL 1/L, 2/R unity	+4 dBu/0 dBV/-10 dBV

Specifications

Other

Phantom power		+48 VDC
PAD (Attenuation level)		-24 dB
I/O connector	INPUT ST	Euroblock connectors (3-pin)
	INPUT MIC/LINE 1 to 6	Euroblock connectors (3-pin)
	OUTPUT UNBAL	Euroblock connectors (3-pin)
	OUTPUT BAL 1/L, 2/R	Euroblock connectors (3-pin)
	GPO	Euroblock connectors (3-pin)
Level indicator	SIGNAL/PEAK	1 point (Red/Yellow/Green)
	Peak indicate (red)	-5 to 0 dB
	Peak hold time	2 sec
Remote control	IP protocol	RJ-45x1 pc
	IP address	192.168.33.102 (factory default)
	Communication speed	100 Mbps
Network	IP protocol	RJ-45x1 pc
Link I/O	Audio-Technica LINK	RJ-45 x 4 pcs
	Communication speed	100 Mbps
USB Type B	Channel	Stereo input x 1 ch, stereo output x 1 ch (24-bit)
	Communication speed	High-speed (480 Mbps)
A/D converter	Resolution	24-bit
	Dynamic range	115 dB
D/A converter	Resolution	24-bit
	Dynamic range	115 dB
Accessories		Euro block connectors x 11, Rack mount (large, small), Rack mount screw x 6, Power cable, Rubber foot x 4

Input/Output specifications

Analog input specifications

Input terminal		Gain	Load impedance	Input level			Connector	Balanced/Unbalanced
				Minimum value	Nominal value	Maximum value		
MIC/LINE1-4	MIC	20 to 60 dB	1.6 kΩ	-60 dBu	-40 dBu	-20 dBu	Euroblock connector	Balanced
	LINE	20 to 60 dB	1.6 kΩ	-50 dBV	-10 dBV	+10 dBV	Euroblock connector	Balanced
MIC/LINE 5, 6	MIC	20 to 60 dB	1.6 kΩ	-60 dBu	-40 dBu	-20 dBu	Euroblock connector	Balanced
	LINE	20 to 60 dB	10 kΩ	-40 dBu	+4 dBu / 0 dBV / -10 dBV / -20 dBV	+24 dBu	Euroblock connector	Balanced
ST (L/R)		-	10 kΩ	-	-10 dBV / -20 dBV	+20 dBV	Euroblock connector	Unbalanced

Analog output specifications

Output terminal	Load impedance	Output level			Connector	Balanced/Unbalanced
		Minimum value	Nominal value	Maximum value		
UNBAL (L/R)	150 Ω	-	-33 dBV / -10 dBV	-13 dBV / +10 dBV	Euroblock connector	Unbalanced
BAL 1/L, 2/R	150 Ω	-	-10 dBV / 0 dBV / +4 dBu	+10 dBV / +20 dBV / +24 dBu	Euroblock connector	Balanced

For product improvement, the product is subject to modification without notice.

System diagram

