

## USER MANUAL

### MODELS:

KDS-EN7 4K AVoIP Encoder

KDS-DEC7 4K AVoIP Decoder



# Contents

<b>Introduction</b>	<b>1</b>
Getting Started	1
Overview	2
Typical Applications	3
<b>Defining KDS-EN7 and KDS-DEC7</b>	<b>4</b>
Defining KDS-EN7	4
Defining KDS-DEC7	5
<b>Mounting KDS-EN7/KDS-DEC7</b>	<b>6</b>
<b>Connecting KDS-EN7 and KDS-DEC7</b>	<b>7</b>
Connecting the Audio/Input Output	8
Understanding LED Functionality	9
Connecting to KDS-EN7 via RS-232	9
<b>Operating and Controlling KDS-EN7</b>	<b>10</b>
Configuring the Network Switch	10
Using Menu Navigation Buttons	10
Operating via Ethernet	14
<b>Using KDS-EN7 Embedded Web Pages</b>	<b>19</b>
Defining AV Routing Parameters	21
Defining HDMI Input Settings	22
Defining Audio Settings	23
Managing EDID	25
General Device Settings	27
KDS-EN7 Network Settings	30
Defining KDS-EN7 Time and Date	32
Setting KDS-EN7 Security	33
Defining KDS-EN7 User Access	36
Defining KDS-EN7 Gateway Settings	38
Viewing KDS-EN7 Status	42
Viewing KDS-EN7 Connections Status	43
Viewing KDS-EN7 Advanced Status	44
Viewing the About Page	45
<b>Using KDS-DEC7 Embedded Web Pages</b>	<b>46</b>
Defining AV Routing Parameters	48
Configuring OSD settings	50
Configuring KVM Settings	51
Setting the Video Wall	54
Configuring the Overlay	55
Defining Video Settings	58
General KDS-DEC7 Settings	59
KDS-DEC7 Network Settings	61
Defining KDS-DEC7 Time and Date	62
Setting KDS-DEC7 Security	63
Defining KDS-DEC7 User Access	64
Defining Gateway Settings	64
Viewing KDS-DEC7 Status	65
Viewing KDS-DEC7 Connections Status	66
Viewing KDS-DEC7 Advanced Status	67
Viewing the KDS-DEC7 About Page	68
<b>KVM Roaming, OSD menu and Fast Switching</b>	<b>69</b>
Configuring KVM Roaming	70
KVM and OSD Menu Switching	73
Fast switching configuration	74
<b>Upgrading Firmware</b>	<b>75</b>

<b>Technical Specifications</b>	<b>77</b>
KDS-EN7 Specifications	77
KDS-DEC7 Specifications	78
Default Communication Parameters	79
Default EDID	79
Default Parameters	81
KDS-DEC7 Default Parameters	82
<b>Protocol 3000</b>	<b>84</b>
Understanding Protocol 3000	84
Protocol 3000 Commands	85
Result and Error Codes	104
<b>KDS JSON Configuration API</b>	<b>105</b>

# Introduction

Welcome to Kramer Electronics! Since 1981, Kramer Electronics has been providing a world of unique, creative, and affordable solutions to the vast range of problems that confront the video, audio, presentation, and broadcasting professional on a daily basis. In recent years, we have redesigned and upgraded most of our line, making the best even better!

---

## Getting Started

We recommend that you:

- Unpack the equipment carefully and save the original box and packaging materials for possible future shipment.
- Review the contents of this user manual.



Go to [www.kramerav.com/downloads/KDS-EN7](http://www.kramerav.com/downloads/KDS-EN7) or [www.kramerav.com/downloads/KDS-DEC7](http://www.kramerav.com/downloads/KDS-DEC7) to check for up-to-date user manuals, application programs, and to check if firmware upgrades are available (where appropriate).

## Achieving Best Performance

- Use only good quality connection cables (we recommend Kramer high-performance, high-resolution cables) to avoid interference, deterioration in signal quality due to poor matching, and elevated noise levels (often associated with low quality cables).
- Do not secure the cables in tight bundles or roll the slack into tight coils.
- Avoid interference from neighboring electrical appliances that may adversely influence signal quality.
- Position your Kramer **KDS-EN7 / KDS-DEC7** away from moisture, excessive sunlight and dust.

## Safety Instructions



### Caution:

- This equipment is to be used only inside a building. It may only be connected to other equipment that is installed inside a building.
- For products with relay terminals and GPIO ports, please refer to the permitted rating for an external connection, located next to the terminal or in the User Manual.
- There are no operator serviceable parts inside the unit.



### Warning:

- Use only the power cord that is supplied with the unit.
- To ensure continuous risk protection, replace fuses only according to the rating specified on the product label which is located on the bottom of the unit.

## Recycling Kramer Products

The Waste Electrical and Electronic Equipment (WEEE) Directive 2002/96/EC aims to reduce the amount of WEEE sent for disposal to landfill or incineration by requiring it to be collected and recycled. To comply with the WEEE Directive, Kramer Electronics has made arrangements with the European Advanced Recycling Network (EARN) and will cover any costs of treatment, recycling and recovery of waste Kramer Electronics branded equipment on arrival at the EARN facility. For details of Kramer's recycling arrangements in your particular country go to our recycling pages at [www.kramerav.com/il/quality/environment](http://www.kramerav.com/il/quality/environment).

---

## Overview

Congratulations on purchasing your Kramer **KDS-EN7 4K AVoIP Encoder / KDS-DEC7 4K AVoIP Decoder**. **KDS-EN7 / KDS-DEC7** is an advanced encoder/decoder for streaming 4K@60Hz (4:2:0) video signals, USB, IR, RS-232, or CEC signals via Ethernet over copper cable in unicast (one-to-one) or multicast (one-to-many) configurations.

**KDS-EN7** encodes and streams the video signal, and transmits USB, IR, RS-232, or CEC signals over an IP network. **KDS-DEC7** decodes the video signal and receives USB, IR, RS-232, or CEC signals.

**KDS-EN7** and **KDS-DEC7** provide exceptional quality, advanced and user-friendly operation, and flexible control.

## Exceptional Quality

- Video Streaming Transmitter/receiver - Streams up to 4K@60Hz (4:2:0) resolution signals over a 1G network interface.
- HDR Support – HDR10 up to 4K@30Hz 4:2:2 12bits.
- Streaming Support – Provides unicast and multicast streaming.
- Flexible Analog Audio Embedding and De-embedding - Select the balanced analog audio as input to embed into the streaming and HDMI output signal, or as output to extract the HDMI audio signal and output it as balanced analog audio.
- Analog Audio De-embedding – **KDS-DEC7** extracts the HDMI audio signal or LAN streaming audio and outputs it as balanced analog audio.
- Video Wall Support – **KDS-DEC7** can create a video wall of up to 16x16 displays.
- KVM and OSD Menu Switching - **KDS-DEC7** On Screen Display Menu triggered by USB hotkey for quick switching between different encoders.

## Advanced and User-friendly Operation

- Convenient and Comprehensive Control – Control the unit using intuitive embedded web pages, Protocol 3000 API commands via Ethernet, or front panel LCD and navigation buttons.
- PoE Support – Powered with PoE connection from PoE switch.
- Keyboard and Mouse Roaming.
- Control Gateway - Through P3K or special TCP connection, users can control/communicate with IR, RS-232, or CEC to the connected devices.
- Separate Service LAN Port – can be used for physical separation between AV and command streams to separate LAN for security and reliability purposes.

## Flexible Connectivity

- Analog/embedded audio inputs and outputs.

---

## Typical Applications

**KDS-EN7** is ideal for the following typical applications:

- Real-time essential installations such as command and control rooms.
- Large scale AV content sharing installations using existing wires and infrastructure in corporate offices and government applications.
- AV distribution systems with one or more sources and multiple displays in schools, universities, and public venues.
- AV installations where low latency KM/KVM capabilities are required.

## Controlling your KDS-EN7

Control your **KDS-EN7** directly via Navigation buttons, or via:

- The Ethernet using built-in user-friendly web pages.
- Protocol commands.

# Defining KDS-EN7 and KDS-DEC7

This section defines KDS-EN7 and KDS-DEC7.

## Defining KDS-EN7

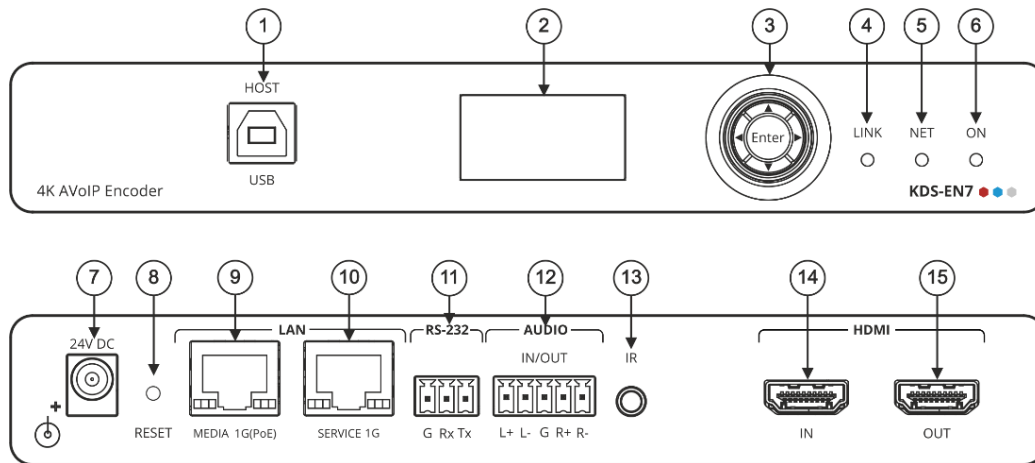

Figure 1: KDS-EN7 4K AVoIP Encoder

#	Feature	Function	
①	HOST USB Type B Port	Connect to a USB host, for example, a PC for KVM/USB support.	
②	LCD Display	Use for device configuration such as unique channel/AV stream setting on encoder and channel tuning on decoder.	
③	Menu Navigation Button	◀	Press to return to the previous menu.
		▲	Press to move up to the next configuration parameter.
		▶	Press to go to the next menu.
		▼	Press to move down to the next configuration parameter.
		Enter	Press to accept changes.
④	LINK LED	See <a href="#">Understanding LED</a> Functionality on page 9.	
⑤	NET LED		
⑥	ON LED		
⑦	24V/1A DC Connector	Connect to the power adapter (purchased separately).	
⑧	RESET Recessed Button	Press and hold for 10 seconds to reset the device to its factory default values. All LEDs flash.	
⑨	LAN MEDIA 1G(PoE) RJ-45 Port	Unicast: connect for streaming either directly to a decoder or via LAN. Multicast: connect to multiple decoders or connect to one decoder to which multiple decoders are daisy-chained via SERVICE (1G) port.	
⑩	LAN SERVICE 1G RJ-45 Port	Used optionally for physical separation between AV and command streams to separate LAN for security and reliability purposes.	
⑪	RS-232 3-pin Terminal Block Connector	Connect to an RS-232 device to use as a Gateway and bi-directional signal extension (even when no AV signal is extended).	
⑫	AUDIO IN/OUT 5-pin Terminal Block Connector	Connect to a balanced analog stereo audio source/acceptor.	
⑬	IR 3.5 Mini Jack	Connect to an IR sensor or emitter for bi-directional signal extension (even when no AV signal is extended). Expected voltage for IR receiver - (3.3V).	
⑭	HDMI IN Connector	Connect to an HDMI source.	
⑮	HDMI OUT Connector	Connect to an additional <b>KDS-EN7</b> device to loop the signal, or to a local acceptor.	

## Defining KDS-DEC7

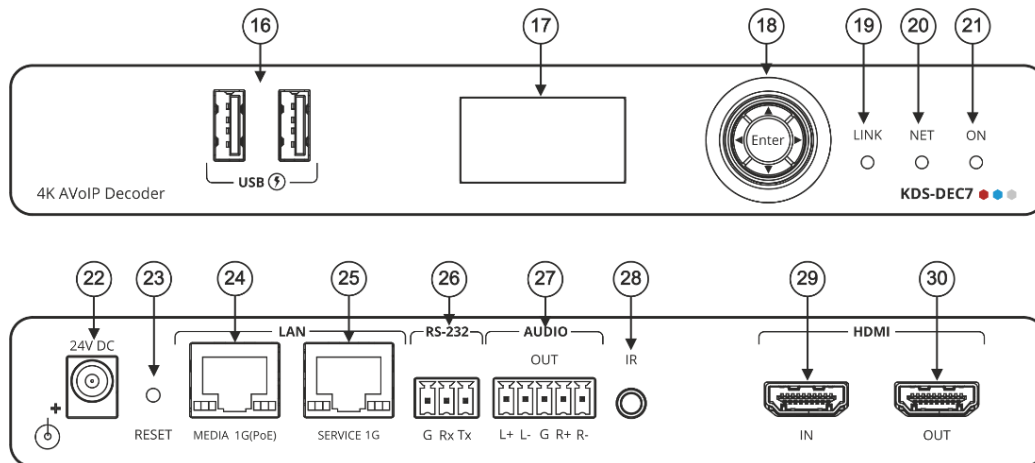

Figure 2: KDS-DEC7 4K AVoIP Decoder

#	Feature	Function	
①⑥	USB Type A Port	Connect to a keyboard and mouse.	
①⑦	LCD Display	Upon power up, displays the last video source. Use for device information and configuration.	
①⑧	Menu Navigation Button	◀	Press to return to the previous menu.
		▲	Press to move up to the next configuration parameter.
		▶	Press to go to the next menu.
		▼	Press to move down to the next configuration parameter.
		Enter	Press to accept changes.
①⑨	LINK LED	See <a href="#">Understanding LED Functionality</a> on page 9.	
②⑩	NET LED		
②①	ON LED		
②②	24V/1A DC Connector	Connect to the power adapter (purchased separately).	
②③	RESET Recessed Button	Press and hold for 10 seconds to reset the device to its factory default values. All LEDs flash.	
②④	LAN MEDIA 1G(PoE) RJ-45 Port	Connect for streaming.	
②⑤	LAN SERVICE 1G RJ-45 Port	Use, optionally, to create a physical separation between AV streams (MEDIA) and command streams (SERVICE), for enhancing security and reliability.	
②⑥	RS-232 3-pin Terminal Block Connector	Connect to an RS-232 device to use as a Gateway and bi-directional signal extension (even when no AV signal is extended).	
②⑦	AUDIO OUT 5-pin Terminal Block Connector	Connect to a balanced analog stereo audio acceptor.	
②⑧	IR 3.5 Mini Jack	Connect to an IR sensor or emitter for bi-directional signal extension (even when no AV signal is extended). Expected voltage for IR receiver – (3.3V).	
②⑨	HDMI IN Connector	Connect to an HDMI source.	
③⑩	HDMI OUT Connector	Connect to an HDMI acceptor.	



# Mounting KDS-EN7/KDS-DEC7

This section provides instructions for mounting **KDS-EN7**. Before installing, verify that the environment is within the recommended range:



- Operation temperature – 0° to 40°C (32 to 104°F).
- Storage temperature – -40° to +70°C (-40 to +158°F).
- Humidity – 10% to 90%, RHL non-condensing.



## Caution:

- Mount **KDS-EN7** before connecting any cables or power.



## Warning:

- Ensure that the environment (e.g., maximum ambient temperature & air flow) is compatible for the device.
- Avoid uneven mechanical loading.
- Appropriate consideration of equipment nameplate ratings should be used for avoiding overloading of the circuits.
- Reliable earthing of rack-mounted equipment should be maintained.
- Maximum mounting height for the device is 2 meters.

### Mount KDS-EN7 in a rack:

- Use the recommended rack adapter  
(see [www.kramerav.com/product/KDS-EN7](http://www.kramerav.com/product/KDS-EN7)).

### Mount KDS-EN7 on a surface using one of the following methods:

- Attach the rubber feet and place the unit on a flat surface.
- Fasten 2 brackets (included) on each side of the unit and attach it to a flat surface. For more information go to [www.kramerav.com/downloads/KDS-EN7](http://www.kramerav.com/downloads/KDS-EN7).

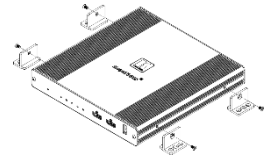

# Connecting KDS-EN7 and KDS-DEC7

 By-default, the device uses PoE for powering the device. Optionally, you can separately purchase a power adapter to connect to the product and plug into the mains electricity.

Always switch off the power to each device before connecting it to your **KDS-EN7** and **KDS-DEC7**. After connecting your devices, connect their power and then switch on the power to each device.

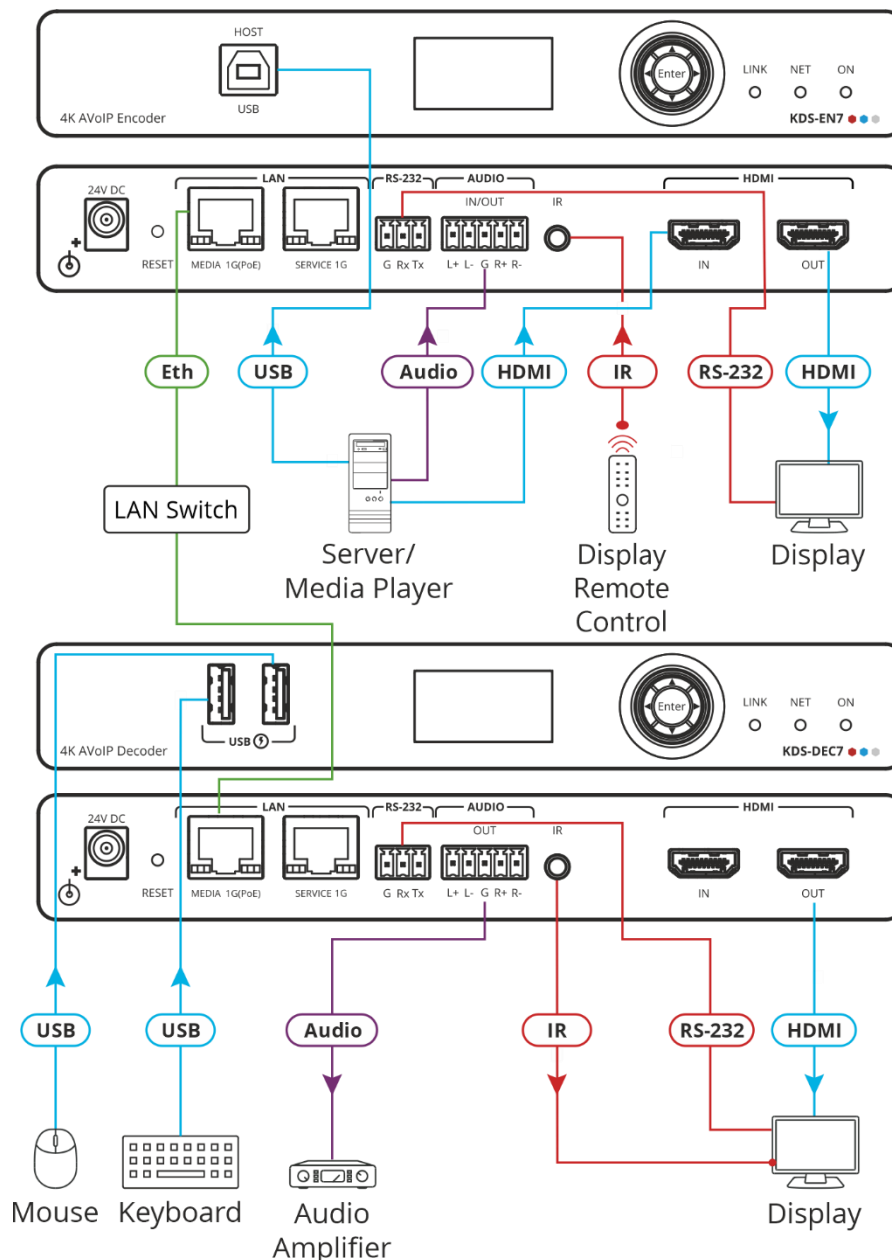



Figure 3: Connecting the KDS-EN7 and KDS-DEC7

To connect KDS-EN7 as illustrated in the example in [Figure 3](#):

1. Connect an HDMI source (for example, a server or a media player) to the HDMI IN connector  on the **KDS-EN7**.

2. Connect a balanced stereo audio source (for example, the server audio connector) to the AUDIO IN/OUT 5-pin terminal block connector (12) on the **KDS-EN7**.
3. Connect the LAN MEDIA 1G(PoE) RJ-45 port (9) on the **KDS-EN7** to the LAN MEDIA 1G(PoE) RJ-45 port (24) on the **KDS-DEC7** via a LAN switch.
4. Connect the HDMI OUT connector (30) on the **KDS-DEC7** to an HDMI acceptor (for example, a display).
5. Connect the AUDIO OUT 5-pin terminal block connector (27) on the **KDS-DEC7** to a balanced stereo audio acceptor (for example, an audio amplifier).
6. Connect the USB ports:
  - On **KDS-EN7**, connect the HDMI input (for example, the server) to the USB HOST port (1).
  - On **KDS-DEC7**, connect a mouse and a keyboard to the two USB type A ports (16).
7. Control the display connected to **KDS-DEC7** from the encoder side via IR:
  - On **KDS-EN7**, connect an IR sensor cable to the IR 3.5mm mini jack (13).
  - On **KDS-DEC7**, connect the IR 3.5mm mini jack (28) to an emitter cable and attach the emitter side to the IR sensor of the display.
8. Connect RS-232 3-pin terminal block connectors:
  - On the **KDS-EN7**, connect the RS-232 port (11) to a laptop/controller.
  - On the **KDS-DEC7**, connect RS-232 (26) to the display.

 RS-232 bidirectional signals can be sent between the display and the laptop connected to the HDMI OUT connector on the **KDS-DEC7**.

## Connecting the Audio/Input Output

The following are the pinouts for connecting the input/output to a balanced or unbalanced stereo audio acceptor:

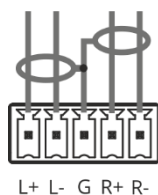

Figure 4: Connecting to a Balanced Stereo Audio Source/Acceptor

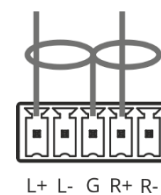

Figure 5: Connecting to an Unbalanced Stereo Audio Acceptor



Figure 6: Connecting an Unbalanced Stereo Audio Source to the Balanced Input

## Understanding LED Functionality

KDS-EN7 and KDS-DEC7 LEDs function as follows:

LED	Color	Definition
LINK LED	Lights Green	A link is established between <b>KDS-EN7</b> and <b>KDS-DEC7</b> and is transmitting A/V signals.
	Flashes Green	A signal is established, and a problem is detected.
NET LED	Off	No IP address is acquired.
	Lights green	A valid IP address has been acquired.
	Flashes Green very fast (for 60sec)	A device identification command is sent (Flag me).
	Lights Yellow	Device falls back to default IP address.
	Lights Red	Security is blocking IP access.
ON LED	Flashes Red	On fallback address acquiring, device 'ON' LED flashes continuously in slow 0.5/10sec cadence.
	Lights Green	When power is on.
	Flashes Green Slowly	Device is in standby mode.
	Flashes green fast	FW is downloaded in the background.
	Flashes Green very fast (for 60sec)	A device identification command is sent (Flag me).
	Lights Yellow	Device falls back to default IP address.
	Lights Red	Security is blocking IP access.

Post reboot, all LEDs light for 3 seconds then return to their normal LED display mode.

## Connecting to KDS-EN7 via RS-232

You can connect to **KDS-EN7** via an RS-232 connection <sup>(13)</sup> using, for example, a PC.



This section applies to **KDS-DEC7** too.

**KDS-EN7** features an RS-232 3-pin terminal block connector allowing the RS-232 to control **KDS-EN7**.

Connect the RS-232 terminal block on the rear panel of **KDS-EN7** to a PC/controller, as follows:

From the RS-232 9-pin D-sub serial port connect:

- Pin 2 to the TX pin on the **KDS-EN7** RS-232 terminal block
- Pin 3 to the RX pin on the **KDS-EN7** RS-232 terminal block
- Pin 5 to the G pin on the **KDS-EN7** RS-232 terminal block

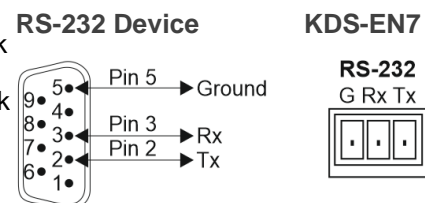

# Operating and Controlling KDS-EN7

This section describes the following actions:

- [Configuring the Network Switch](#) on page [10](#).
- [Using Menu Navigation Buttons](#) on page [10](#).
- [Operating via Ethernet](#) on page [14](#).

---

## Configuring the Network Switch

Before setting the system, make sure that your AV over IP network switch meets the following minimum requirements:

- Jumbo Frames – On. (at least 8000 bytes).
- IGMP Snooping – On.
- IGMP Querier – On.
- IGMP Immediate/Fast Leave – On.
- Unregistered Multicast Filtering – On.

---

## Using Menu Navigation Buttons

Connect the device to the 24V DC power adapter and connect the adapter to the mains electricity. The ON LED lights green, and the LINK LED flashes (indicating that no streaming activity is detected).

Use the navigation button to easily view and set basic device parameters via the Device menu, appearing on the device LCD display [②](#), see:

- [Using KDS-EN7 Navigation Buttons](#) on page [11](#).
- [Using KDS-DEC7 Navigation Buttons](#) on page [12](#).



KDS-EN7 and KDS-DEC7 have slightly different menus.

Use the Navigation buttons [③](#) / Use the:

- Up arrow – to move to the next configuration parameter.
- Left arrow – to return to the previous menu.
- Right arrow – to go to the next menu.
- Enter button – accept and save the change.
- Defining device settings.

## Using KDS-EN7 Navigation Buttons

- [Defining Device Status](#) on page [11](#).
- [Viewing Device Information](#) on page [11](#).
- [Selecting the EDID](#) on page [11](#).
- [Defining HDCP Settings](#) on page [12](#).
- [Defining Encoder Device Channel Number](#) on page [12](#).

### Defining Device Status

View the device parameters.

#### To view device parameters:

1. Press the left or right arrows to access the device status (DEV STATUS) menu.
2. Press the up or down arrows to view the following information:
  - LAN1 STATUS, including IP address, Subnet mask and Gateway address
  - LAN2 STATUS, including IP address, Subnet mask and Gateway address.
  - HDMI STATUS, including video input resolution and HDCP settings status.
  - View Device channel ID (CH DEFINE).
  - Device internal TEMPERATURE (°C).

Device status is viewed.

### Viewing Device Information

#### To view device parameters:

1. Press the left or right arrows to access the device status menu.
2. Press the up or down arrows to view the device firmware and hardware information:
  - Firmware version (FW).
  - Bootloader information (BL).
  - Hardware version (HW).

Device information is viewed.

### Selecting the EDID

#### To select the EDID:

1. Press the left or right arrows to access the device setting menu.
2. Press the up or down arrows to select the EDID settings menu.

3. Select the EDID from the following options:

Select	EDID Setting
0	Default
1	4K30_2.0CH
2	4K30_Dolby
3	1080P50_Dolby
4	720P50_2.0
5	720P50_Dolby

4. Press **Enter** to accept change.

EDID on the input is set.

## Defining HDCP Settings

Enable or disable HDCP on the input via the navigation buttons.

### To define HDCP settings:

1. Press the left or right arrows to access the HDCP Settings menu.
2. Press the up or down arrows to select HDCP support mode:
  - Select ON to enable HDCP support.
  - Select OFF to disable HDCP support.
3. Press **Enter** to accept HDCP mode.

## Defining Encoder Device Channel Number

Set a device channel number from 1 to 999.

### To define the encoder channel number:

1. Press the left or right arrows to access the CH DEFINE menu.
2. Press the up or down arrows to set a first digit (0 to 9).
3. Press left and right arrows to add another digit (0 to 9).
4. Press **Enter** to accept channel number.

Channel number for this device is defined.

## Using KDS-DEC7 Navigation Buttons

### Defining Device Status

You can view the device parameters.

### To view device parameters:

1. Press the left or right arrows to access the device status menu.
2. Press the up or down arrows to view the following information:
  - LAN 1 status, including IP address, Subnet mask and Gateway address
  - LAN2 status, including IP address, Subnet mask and Gateway address.

- HDMI status, including video input resolution and HDCP settings status.
- View the encoder channel that was selected.
- Device internal temperature (°C).

Device status is viewed.

## Viewing Device Information

### To view device parameters:

1. Press the left or right arrows to access the device status menu.
2. Press the up or down arrows to view the device firmware and hardware information:
  - Firmware version.
  - Bootloader information.
  - Hardware version.

Device information is viewed.

## Selecting the video input signal

You can either select the streaming input or the local HDMI input signal to route to the HDMI output.

### To select the streaming input:

1. Press the left or right arrows to access the device setting menu.
2. Press the up or down arrows to select Input Setting.
3. Select one of the HDMI inputs:
  - STREAM IN
  - HDMI IN
4. Press **Enter** to accept change.

The input is selected.

## Defining Output Resolution

Select the display resolution.

### To select the output resolution:

1. Press the left or right arrows to access the Device Settings menu.
2. Press the up or down arrows to select RESOLUTION Setting:
  - Pass-through
  - 720P60
  - 1080P60
  - 1080P50
  - 2160P25
  - 2160P30



3. Press **Enter** to accept output resolution.

Resolution is selected.

### Selecting an Encoder Device Channel Number on the decoder

Select the channel number of a specific encoder.

**To select an encoder channel number:**

1. Press the left or right arrows to access the encoder CH Select menu.
2. Press the up or down arrows to select the first digit (0 to 9).
3. Press left and right arrows to add another digit (0 to 9).

Channel number for the specific encoder is selected.

---

## Operating via Ethernet

This section describes the following actions:

- [Allocating the IP Address via LCD screen menu](#) on page [14](#).
- [Accessing the Web UI](#) on page [15](#).
- [Connecting Ethernet Port Directly to a PC](#) on page [16](#).
- [Connecting Ethernet Port via a Network Hub or Switch](#) on page [18](#).
- [Configuring Ethernet Port](#) on page [18](#).

### Allocating the IP Address via LCD screen menu

**KDS-EN7 / KDS-DEC7** IP default static addresses are: 192.168.1.39 for the Encoder and 192.168.1.40 for the Decoder. By default, DHCP is enabled, and assigns an IP address to the device. If DHCP Server is not available, for example, in case a device is connected directly to the laptop, that device gets the default IP address. If these IP addresses are already in use, the system searches for a random unique IP in the range of 192.168.X.Y. the allocated IP address can be identified using the LCD screen menu.

#### Setting Channel Number

Each encoder requires a unique channel number, and the connected decoders should be tuned to that encoder channel. You can set the channel number via the LCD screen menu or the embedded web pages.

**To set the channel number for KDS-EN7/KDS-DEC7, via LCD screen menu:**

1. Connect the device to the 24V DC power adapter and connect the adapter to the mains electricity. The ON LED lights green, and the LINK LED flashes (indicating that no streaming activity is detected).
2. In the LCD screen menu, go to DEV SETTINGS > CH DEFINE.

3. Change channel number using arrow buttons:
  - For the **KDS-EN7** set a unique channel number.
  - For each of the **KDS-DEC7** devices, set to the defined **KDS-EN7** channel number.
4. Press **Enter** to save your selection.

#### To set the channel number via web pages:

1. Connect the **KDS-EN7** / **KDS-DEC7** Ethernet port to the network and power the device.
2. Access the embedded web pages.
3. In the **Main** page:
  - For **KDS-EN7**:
    - Go to **AV Routing** page.
    - Select **Channel ID** and define the channel ID number.
  - For **KDS-DEC7**:
    - Go to **AV Routing** page.
    - Select **Channel ID** (corresponding to the desired encoder channel ID).

By default, **KDS-EN7** and **KDS-DEC7** are DHCP-enabled. This section describes how to operate via the Ethernet and access the IP address when DHCP is enabled and when a static IP address is used.

You can connect to **KDS-EN7** via Ethernet using either of the following methods:

- When DHCP is enabled (see, for example, [KDS-EN7 Network Settings](#) on page [30](#)).

When using a static IP Address (DHCP is disabled):

- Directly to the PC using a crossover cable (see [Connecting Ethernet Port Directly to a PC](#) on page [16](#)).
- Via a network hub, switch, or router, (using a static IP address) using a straight-through cable (see [Connecting Ethernet Port via a Network Hub](#) on page [18](#)).

**Note:** If you want to connect via a router and your IT system is based on IPv6, speak to your IT department for specific installation instructions.

## Accessing the Web UI

By default, IP setting for KDS-7 Decoders is DHCP.

#### To access the Web UI, perform the following:

1. Connect the LAN port of the device to a local area network.  
Make sure that there is a DHCP server in the Network so that the device can obtain a valid IP address.
2. Connect your PC to the same network as the device.

- Input the device's IP address in the browser and press Enter, the following window pops up.  
Allocated IP address can be checked using LCD screen menu.

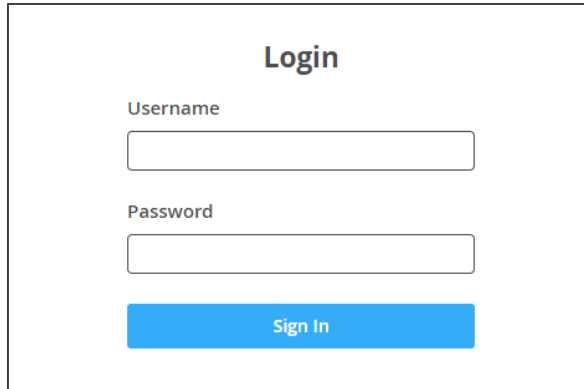

The screenshot shows a web browser window titled "Login". It contains two text input fields: "Username" and "Password". Below the "Password" field is a blue button labeled "Sign In".

Figure 7: Login Window

- Input username and password (default username / password: admin / admin) and click **Sign In** to enter the main page of web UI.

## Connecting Ethernet Port Directly to a PC

You can connect the Ethernet port of **KDS-EN7** directly to the Ethernet port on your PC using a crossover cable with RJ-45 connectors.



This type of connection is recommended for identifying **KDS-EN7** with the factory configured default IP address.

After connecting **KDS-EN7** to the Ethernet port, configure your PC as follows:

- Click **Start > Control Panel > Network and Sharing Center**.
- Click **Change Adapter Settings**.
- Highlight the network adapter you want to use to connect to the device and click **Change settings of this connection**.

The Local Area Connection Properties window for the selected network adapter appears as shown in [Figure 8](#).

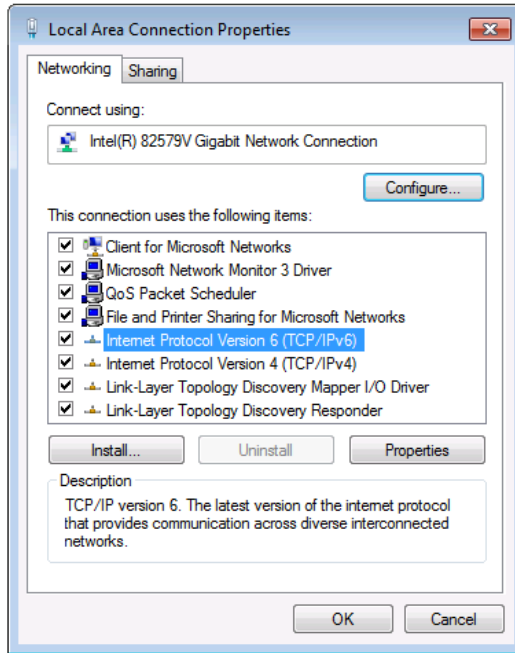

Figure 8: Local Area Connection Properties Window

4. Highlight either **Internet Protocol Version 6 (TCP/IPv6)** or **Internet Protocol Version 4 (TCP/IPv4)** depending on the requirements of your IT system.
5. Click **Properties**.

The Internet Protocol Properties window relevant to your IT system appears as shown in [Figure 9](#) or [Figure 10](#).

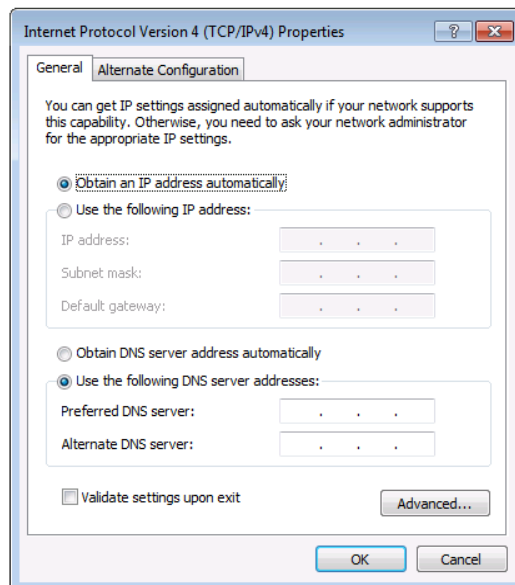

Figure 9: Internet Protocol Version 4 Properties Window

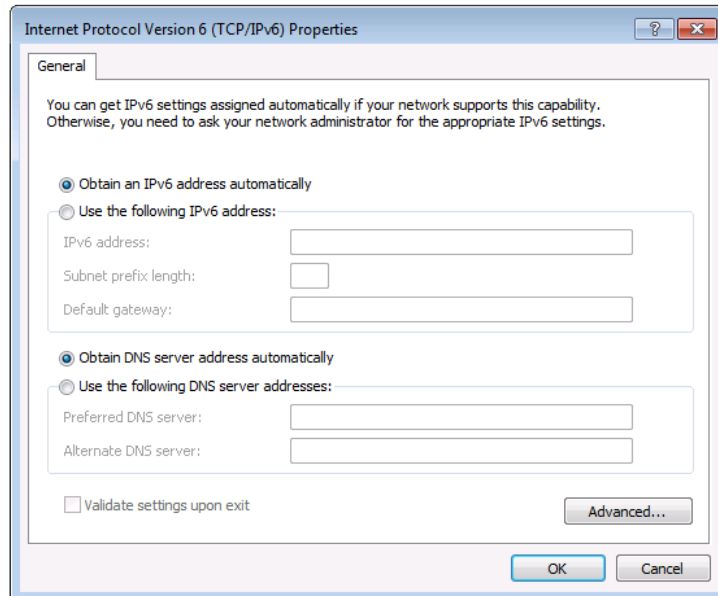

Figure 10: Internet Protocol Version 6 Properties Window

6. Select **Use the following IP Address** for static IP addressing and fill in the details as shown in [Figure 11](#).

For TCP/IPv4 you can use any IP address in the range 192.168.1.1 to 192.168.1.255 (excluding 192.168.1.39) that is provided by your IT department.

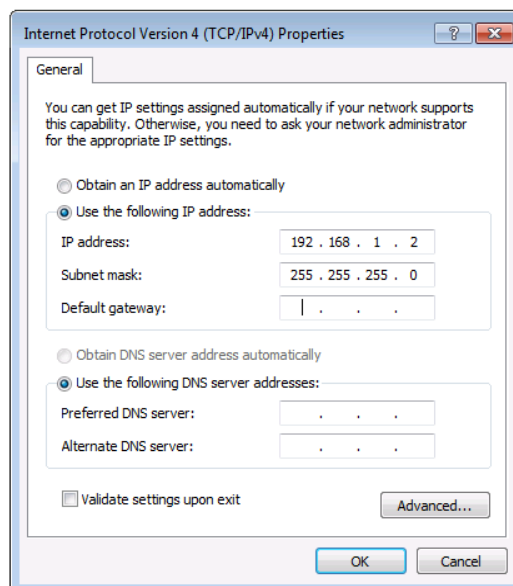

Figure 11: Internet Protocol Properties Window

7. Click **OK**.
8. Click **Close**.

## Connecting Ethernet Port via a Network Hub or Switch

You can connect the Ethernet port of **KDS-EN7** to the Ethernet port on a network hub or using a straight-through cable with RJ-45 connectors.

## Configuring Ethernet Port

You can set the Ethernet parameters via the embedded web pages.

# Using KDS-EN7 Embedded Web Pages

KDS-EN7 can be operated remotely using the embedded web pages. The web pages are accessed using a Web browser and an Ethernet connection.

Before attempting to connect:

- Perform the procedures in [Operating via Ethernet](#) on page [14](#).
- Ensure that your browser is supported.

The following operating systems and Web browsers are supported:

Operating Systems	Applicable Browser Versions and Higher
Windows 7	Chrome: 25 Internet Explorer: 9 Firefox 19 Opera: 11
Mac (PC)	Chrome: 25 Firefox: 19 Opera: 11
iOS	Chrome: 25 Safari (depends on the IOS version) Opera: 11
Android OS	Chrome: 25 Opera: 11



Some features might not be supported by some mobile device operating systems.

KDS-EN7 enables performing the following:

- [Defining AV Routing Parameters](#) on page [21](#).
- [Defining HDMI Input Settings](#) on page [22](#).
- [Defining Audio Settings](#) on page [23](#).
- [Managing EDID](#) on page [25](#).
- [General Device Settings](#) on page [27](#).
- [KDS-EN7 Network Settings](#) on page [30](#).
- [Defining KDS-EN7 Time and Date](#) on page [32](#).
- [Setting KDS-EN7 Security](#) on page [33](#).
- [Defining KDS-EN7 User Access](#) on page [36](#).
- [Defining KDS-EN7 Gateway Settings](#) on page [38](#).
- [Viewing KDS-EN7 Status](#) on page [42](#).
- [Viewing KDS-EN7 Connections Status](#) on page [43](#).

- [Viewing KDS-EN7 Advanced Status](#) on page [44](#).
- [Viewing the About Page](#) on page [45](#).

**To Browse the KDS-EN7 Web Pages:**

1. Open your Internet browser.
2. Type the IP number of the device in the Address bar of your browser. For example, the default IP number:

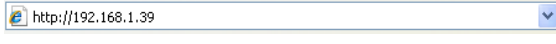
. The Login window appears.

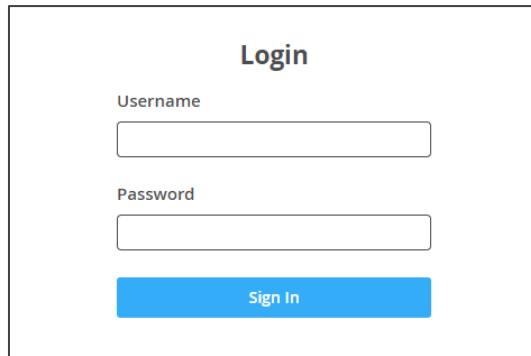

Figure 12: Login Window

3. Enter the Username and Password (Admin/Admin, by default). The KDS-EN7 page appears.

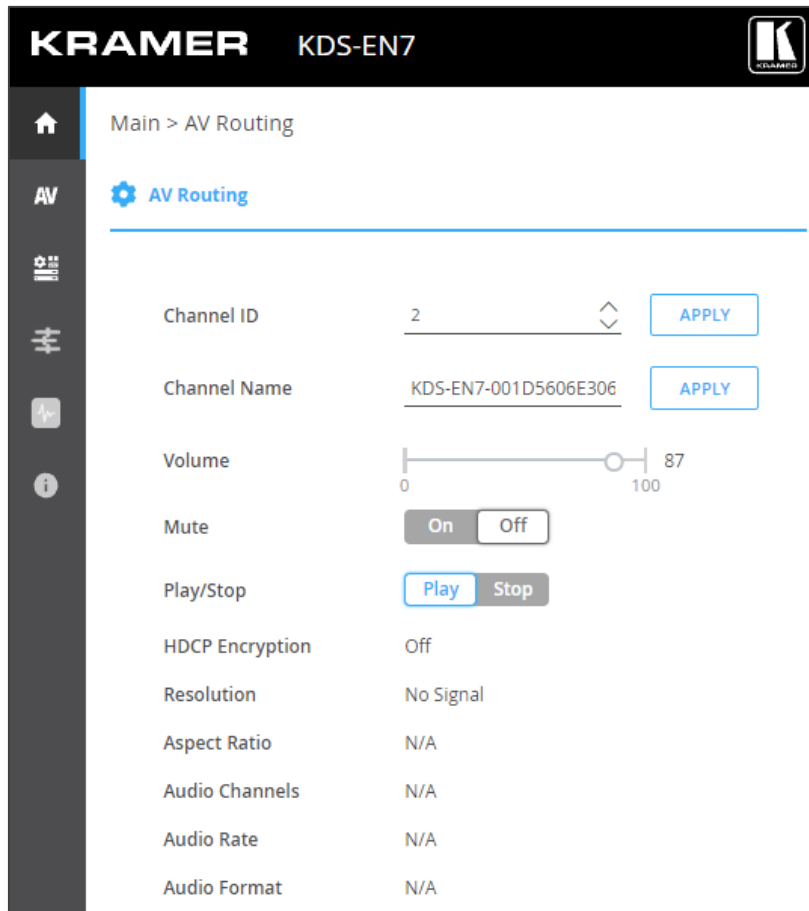

Figure 13: Controller Application Page with Navigation List on Left

4. Click the tabs on the left side of the screen to access the relevant web page.

---

## Defining AV Routing Parameters

Set the **KDS-EN7** AV routing parameters.

To set AV routing parameters:

1. In the Navigation pane, Select **Main>AV Routing**. The AV Routing page appears (see [Figure 13](#)).
2. Define the following settings:
  - **Channel ID:** Set Channel ID and click **APPLY**.  
Channel ID defines the device input ID (1 to 999).
  - **Channel Name:** Enter the Stream Name and click **APPLY**.  
Stream name is identical to Host name (see [General Device Settings](#) on page [27](#)) can include up to 24 characters; “-“ and “\_” are allowed within the name.  
by default, the name is the model name and MAC address connected by “-“.
  - **Volume:** Use the slider to adjust the analog audio output volume (0 to 100%).  
Default is 80 (0dB), 100% (12dB) and 0 is mute.
  - **Mute:** Mute/unmute all audio outputs (HDMI OUT, AUDIO OUT, and MEDIA ports).
  - **Play/Stop:** Start or stop streaming of video, audio, IR, RS-232 and USB signals.
3. View the following streaming parameters: HDCP Encryption, Resolution, Aspect Ratio, Audio Channels, Audio Rate and Audio Format.

Routing parameters are defined.



## Defining HDMI Input Settings

Define KDS-EN7 video settings.

To define HDMI input settings:

1. In the Navigation pane, Select **AV**. The Video tab in the AV Routing page appears.

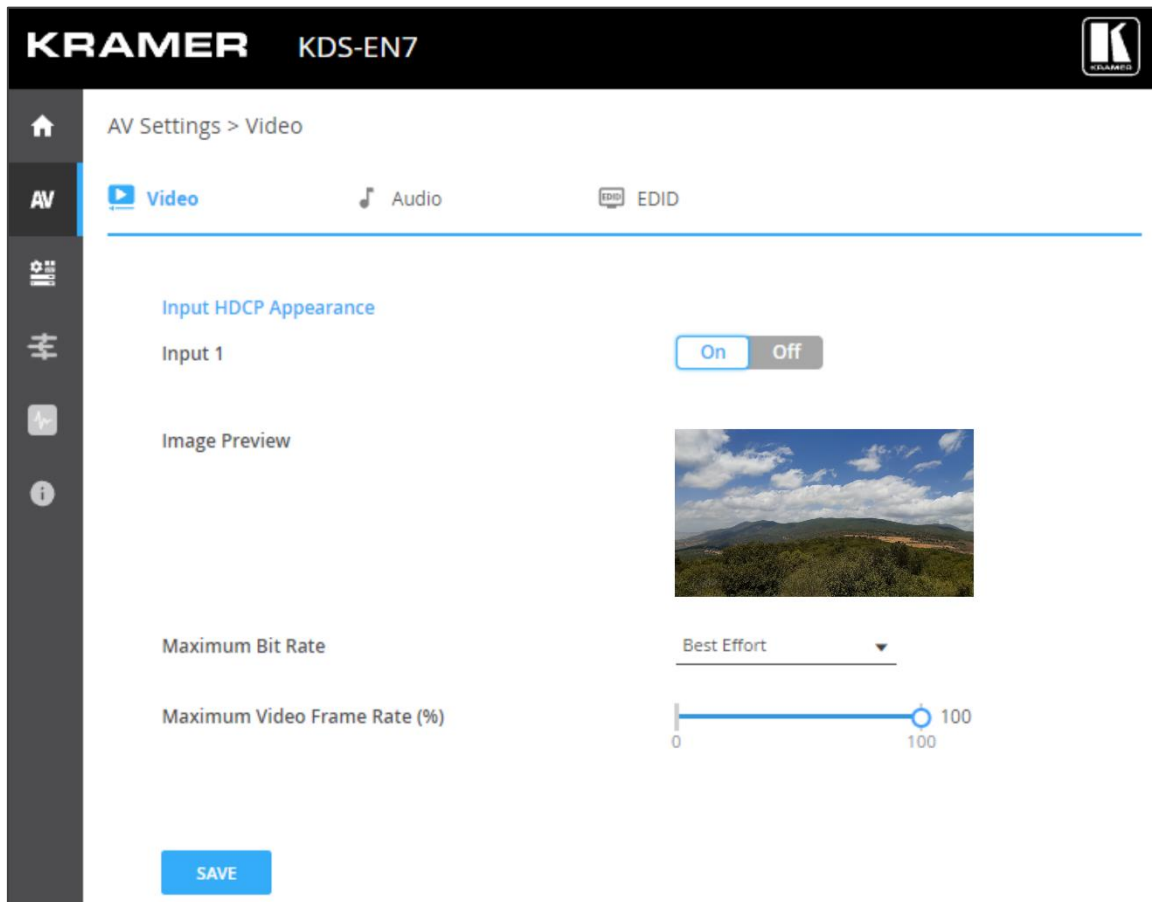

Figure 14: AV Settings – Video Settings Tab

2. Define the following settings:

- **Input 1:** enable/disable HDCP support for the HDMI input.
- **Image Preview:** view the output video streaming preview.
- **Maximum Bit Rate:** select the maximum transmission bandwidth. Select bandwidth (10Mbps, 50Mbps, 100Mbps, 150Mbps and 200Mbps) or Best Effort to set bandwidth for best video quality output.



After setting the maximum bit rate you need to restart the device.

- **Maximum Video Frame Rate (%):** use the slider to configure the maximum frame rate in proportion. 100% (default) means zero compression on the frame rate.

3. Click **SAVE**.

HDMI input settings are defined.

## Defining Audio Settings

Define KDS-EN7 audio settings.

To define Audio settings:

1. In the Navigation pane, Select **AV**. The Video tab in the AV Settings page appears (see [Figure 14](#)).
2. Select the **Audio** tab. The Audio tab appears.

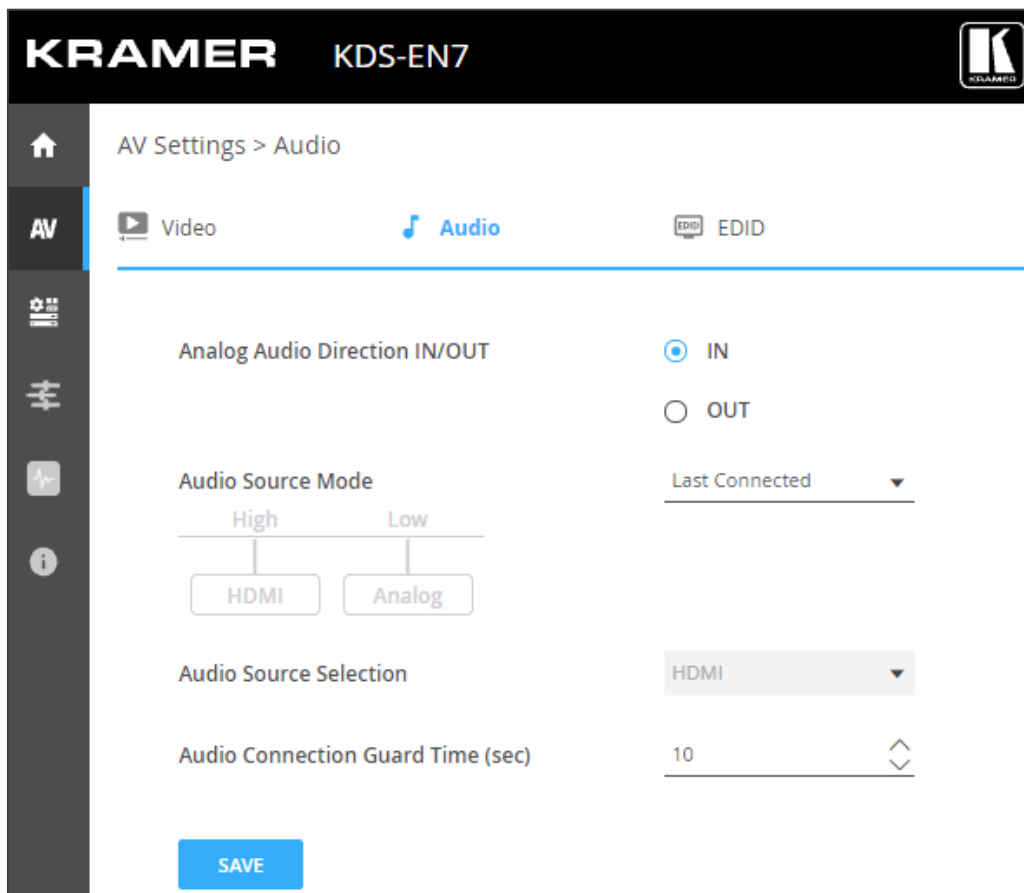

Figure 15: AV Settings – Audio Tab

3. Select IN or OUT to select the audio direction.



If IN is selected, the analog audio port is set as an input and **KDS-EN7** includes 2 optional audio sources.

If OUT is selected, the analog audio port is set as an output and **KDS-EN7** includes only the HDMI audio source.

- 4. Define the audio source (HDMI or analog audio when the analog port is set as IN) selection mode:

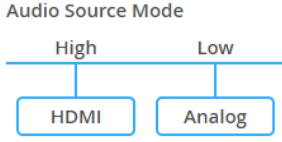
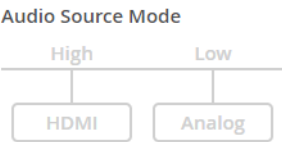
<p><b>Last Connected:</b> the device switches the last connected audio source to the output.</p>		Last Connected ▼
<p><b>Priority:</b> Set the connection priority by clicking and dragging an input to set its priority order. The device switches the highest priority audio input to the output.</p>		Priority ▼
<p><b>Manual:</b> manually select the audio source. The device switches an audio source only when selected manually.</p>	 <p>Audio Source Selection</p>	Manual ▼  HDMI ▲ HDMI Analog None
	Audio Connection Guard Time (sec)	

- 5. Set the Audio Connection Guard Time (10 seconds, by default), which is the audio signal loss time interval.  
For example, when in the Last Connected or Priority modes, the currently selected analog audio signal is lost (either becomes silent or is unplugged), the HDMI audio source is automatically selected.

- 6. Click **SAVE**.

Audio settings are defined.

## Managing EDID

You can select the EDID and lock it if required.

To manage EDID:

1. In the Navigation pane, Select **AV**. The Video tab in the AV Routing page appears (see [Figure 14](#)).
2. Select the **EDID** tab. The EDID Management tab appears.

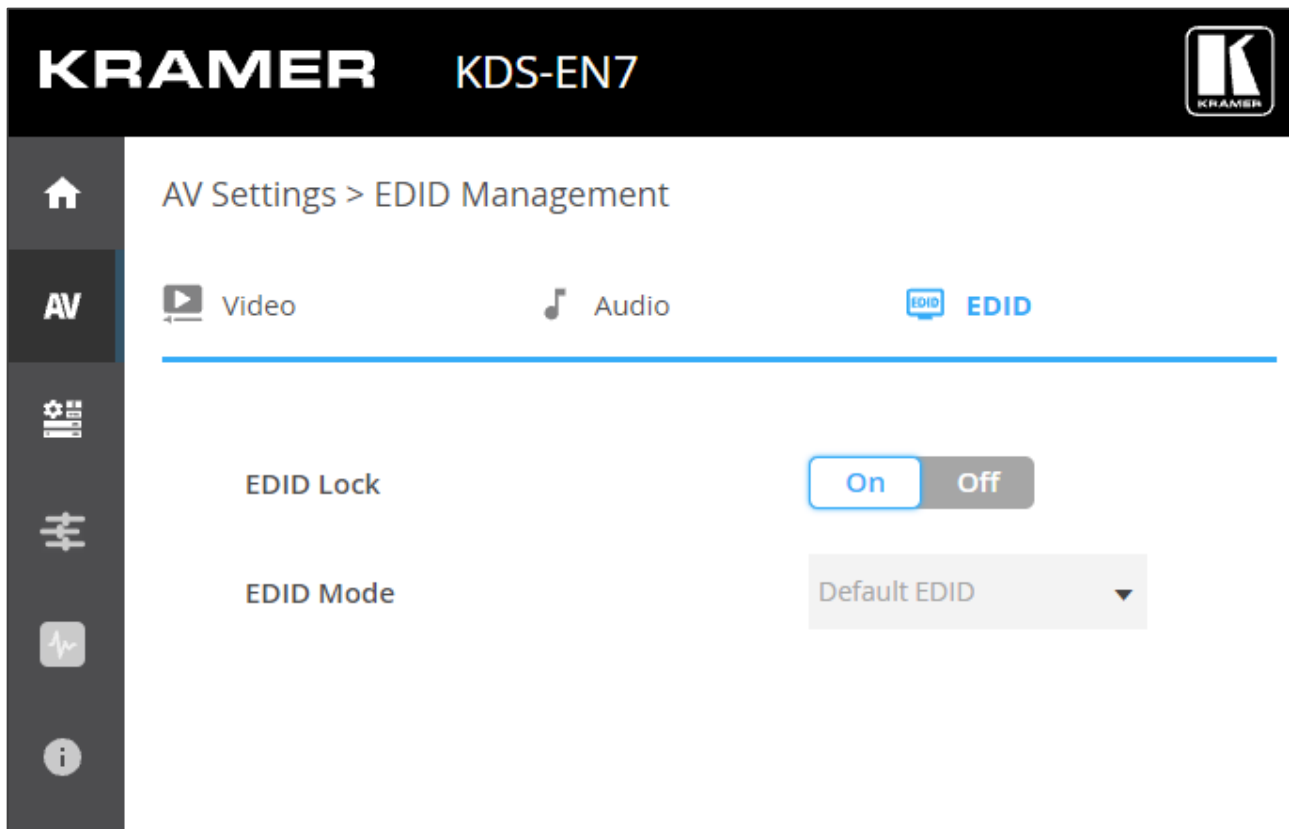

Figure 16: AV Settings – EDID Management Tab

3. Set EDID Lock:
  - Click **ON**, to lock to the last acquired EDID.
  - Click **OFF**, to unlock and acquire a new EDID.

4. Select EDID mode from the drop-down box:



Before selecting the EDID mode, set EDID Lock to **OFF**.

**Default Mode:** set to the default, built-in, EDID.

EDID Lock	<input type="checkbox"/> On <input checked="" type="checkbox"/> Off
EDID Mode	Default EDID ▾

**Passthrough:** acquire EDID from a specific decoder:

- Enter the decoder IP address.
- Click **READ**.

The EDID is copied from the decoder to the encoder.

EDID Lock	<input type="checkbox"/> On <input checked="" type="checkbox"/> Off
EDID Mode	Passthrough ▾
Read EDID from Specific Decoder	0.0.0.0 <input type="button" value="READ"/>

EDID Lock	<input type="checkbox"/> On <input checked="" type="checkbox"/> Off
EDID Mode	Passthrough ▾
Read EDID from Specific Decoder	192.168.1.40 <input type="button" value="READ"/>

**Custom:** download the EDID file from an external source.

To remove an EDID from the list:

- Select an EDID file from the list.
- Click **REMOVE**.

To upload an EDID file:

- Click **UPLOAD**.
- Select an EDID file from the Open window.
- Click **UPLOAD**. the EDID file is added to the list.
- Select the file and click **UPLOAD**.

EDID Mode	Custom ▾													
User EDID	<table border="1"> <tr><td>default.bin</td><td><input type="button" value="UPLOAD"/></td></tr> <tr><td>4K30_2.0CH_SDR.bin</td><td><input type="button" value="REMOVE"/></td></tr> <tr><td>4K30_Dolby_DTS7.1_SDR.bin</td><td><input type="button" value="APPLY"/></td></tr> <tr><td>1080P50_Dolby_DTS7.1_SDR.bin</td><td></td></tr> <tr><td>720P50_2.0CH_SDR.bin</td><td></td></tr> <tr><td>720P50_Dolby_DTS7.1_SDR.bin</td><td></td></tr> </table>	default.bin	<input type="button" value="UPLOAD"/>	4K30_2.0CH_SDR.bin	<input type="button" value="REMOVE"/>	4K30_Dolby_DTS7.1_SDR.bin	<input type="button" value="APPLY"/>	1080P50_Dolby_DTS7.1_SDR.bin		720P50_2.0CH_SDR.bin		720P50_Dolby_DTS7.1_SDR.bin		
default.bin	<input type="button" value="UPLOAD"/>													
4K30_2.0CH_SDR.bin	<input type="button" value="REMOVE"/>													
4K30_Dolby_DTS7.1_SDR.bin	<input type="button" value="APPLY"/>													
1080P50_Dolby_DTS7.1_SDR.bin														
720P50_2.0CH_SDR.bin														
720P50_Dolby_DTS7.1_SDR.bin														



You can load up to 8 EDID files. If 8 files are loaded, you need to remove a file from the list. default.bin cannot be deleted.

The list returns to its default list upon factory reset.

EDID is managed.

---

## General Device Settings

Change the Host Name, which is identical to the Channel ID name (see [Defining AV Routing Parameters](#) on page [21](#)), view the device model, H/W release version, serial number and MAC address.



Though the device has only one MAC address, you can configure up to two separate IP addresses for the two Ethernet ports in two subnets using one MAC address (see [KDS-EN7 Network Settings](#) on page [30](#)).

KDS-EN7 enables performing the following actions via the General Settings tab:

- [Locking/Unlocking the Front Panel](#) on page [28](#).
- [Importing/Exporting Device Settings](#) on page [29](#).
- [Locating the Device](#) on page [29](#).
- [Managing the Firmware Version](#) on page [29](#).
- [Restarting or Resetting the Device](#) on page [29](#).

## Locking/Unlocking the Front Panel

To lock/unlock the front panel:

1. In the Navigation pane, Select **Device Settings**. The General tab in the Device Settings page appears.

The screenshot displays the 'Device Settings > General' page for a Kramer KDS-EN7 device. The page is organized into several sections:

- General Preferences:**
  - Host Name: KDS-EN7-001D5606E306 (with an APPLY button)
  - Device Model: KDS-EN7
  - Device H/W Release: v0.2
  - MAC Address: 00-1D-56-06-E3-06
  - Serial Number: 11210005600008
  - Front Panel Lock: A toggle switch currently set to 'On' (with an 'Off' button).
  - Import/Export Device Settings: A dropdown menu set to 'All including IP' (with IMPORT and EXPORT buttons).
  - Locate Device: (with an APPLY button)
- Version:**
  - Firmware Version: v0.6.3 (with an UPGRADE button)
  - Last Upgrade Date/Time: 01-01-1970,00:09:04
  - Firmware Standby Version: v0.6.2 (with a ROLLBACK button)
- Device Reset:** (with RESTART and RESET buttons)

Figure 17: Device Settings – General Tab

2. Lock/Unlock the device front panel:

- Click Off, to enable device control from the front panel via the LCD screen and the navigation buttons(see [Using Menu Navigation Buttons](#) on page 10).
- Click On, to disable device control via the navigation buttons.

## Importing/Exporting Device Settings

You can select the type of device settings to export/import from/to the device.

**To import or export the device settings:**

1. In the Navigation pane, Select **Device Settings**. The General tab in the Device Settings page appears (see [Figure 17](#)).
2. In the General Device Settings page, select the setting types to import or export.
  - **All without IP** – Select all the settings, excluding the IP address.
  - **Streams** – Select video, audio, IR, CEC and RS-232 settings.
  - **AV Settings Only** – Select only video and audio settings.
  - **All including IP** – Select all the settings including the IP address.
3. When importing, do the following (when exporting, go to the next step):
  - Click **IMPORT**. An Open file appears.
  - Select the file to import (settings.tar.gz).
  - Click **Open** to import the file.
4. To export settings, click **EXPORT**.  
The settings file is created (settings.tar.gz).

The settings file is imported/exported.

## Locating the Device

Locate the specific device in the system.

**To locate the device:**

1. In the Navigation pane, Select **Device Settings**. The General tab in the Device Settings page appears (see [Figure 17](#)).
2. In the General Device Settings page, click **APPLY** next to Locate Device.  
the located device NET and ON LEDs on the front panel flashes for 60 seconds.

The device is located in the system.

## Managing the Firmware Version

To upgrade the firmware, view the date of the last upgrade, or rollback to the previous firmware revision in case of a problem, see [Upgrading Firmware](#) on page [75](#).



Click **ROLLBACK** to update to the previous FW version.

## Restarting or Resetting the Device

Click **RESTART** to reboot the device and click **RESET** to restore device factory default settings.



## KDS-EN7 Network Settings

The device enables performing the following actions:

- [Defining Interface Settings](#) on page [30](#).
- [Defining IP Casting Mode Setting](#) and TTL on page [31](#).
- [Managing TCP/UDP Ports](#) on page [31](#).

### Defining Interface Settings

Define interface settings for each of the Ethernet ports.

To define interface settings:

1. In the Navigation pane, Select **Device Settings**. The General tab in the Device Settings page appears (see [Figure 17](#)).
2. Select the **Network** tab. The Network tab appears.

The screenshot displays the 'Device Settings > Network' page for a Kramer KDS-EN7 device. The 'Network' tab is active, showing various configuration options. A table lists interface settings for '802.1Q' and 'P3K & Gateway' services. Below the table, there are radio buttons for 'IP Casting Mode' (Unicast and Multicast), a 'TTL' field, and 'TCP/UDP Management' fields for 'TCP Port' and 'UDP Port'. A 'SAVE' button is located at the bottom left.

Service Name	Port	802.1Q	VLAN Tag	DHCP	IP Address	Mask Address	Gateway Address
Stream	Media	N/A	N/A	<input type="checkbox"/> On <input type="checkbox"/> Off	192.168.1.39	255.255.0.0	0.0.0.0
P3K & Gateway	Media	<input type="checkbox"/> On <input type="checkbox"/> Off	2	<input type="checkbox"/> On <input type="checkbox"/> Off	192.168.1.39	255.255.0.0	0.0.0.0

IP Casting Mode:  Unicast  Multicast

TTL: 64

TCP Port: 5000

UDP Port: 50000

SAVE

Figure 18: Device Settings – Network Tab

3. Set the Media port Stream service parameters:
  - **DHCP mode** – Set DHCP to **On** (default) or **Off**.
  - **IP Address** – When DHCP mode is set to Off, the device uses a static IP address. This requires entering mask and gateway addresses.
  - **Mask Address** – Enter subnet mask.

- **Gateway address** – Enter the gateway address.



Note that Stream Service is assigned only to the Media port.

#### 4. Set the P3K & Gateway service parameters:

- **Port** – Set the P3K & Gateway port to **Media** (default) or **Service**.



P3K & Gateway can be assigned to either Media or Service port, but if it is assigned to Media port with DHCP enabled and 802.1Q disabled, it will share the same IP address with the Stream Service.

Otherwise, it should be assigned with another IP address, which must have a subnet that is different than the Stream Service.

- **802.1Q** – Click **On** to enable 802.1Q standard for P3K & Gateway service, or click **Off** (default) to disable.

If Media port is selected and 802.1Q is disabled for P3K & Gateway, both VLAN Tag and IP setting for P3K & Gateway are not available.

- **VLAN Tag** – Enter an integer number to specify a VLAN ID (1 - 4093) to P3K & Gateway services. This way, the P3K&Gateway service will have the VLAN packets tagged to Network.
- **DHCP mode** – Set DHCP to **On** (default) or **Off**.
- **IP Address** – When DHCP mode is set to Off, the device uses a static IP address. This requires entering mask and gateway addresses.
- **Mask Address** – Enter subnet mask.
- **Gateway address** – Enter the gateway address.

IP interface parameters are defined.

## Defining IP Casting Mode Setting and TTL

Define the following:

- Check **Unicast** or **Multicast** (default) mode.
- Set TTL, to define the lifetime of data in the computer/Network to prevent an IP packet from propagating endlessly through the Network (default, 64).

IP Casting and TTL are defined.

## Managing TCP/UDP Ports

To manage TCP/UDP ports:

1. In the Navigation pane, Select **Device Settings**. The General tab in the Device Settings page appears (see [Figure 17](#)).
2. Select the **Network** tab. The Network tab opens (see [Figure 18](#)).
3. Define TCP (default, 5000) and UDP (default, 50000) ports.

TCP/UDP ports are defined.

## Defining KDS-EN7 Time and Date

You can sync the device time and date to any server around the world.

To sync device time and date to a server:

1. In the Navigation pane, click **Device Settings**. The General tab in the Device Settings page appears (see [Figure 17](#)).
2. Select the **Time and Date** tab. The Time and Date tab appears.

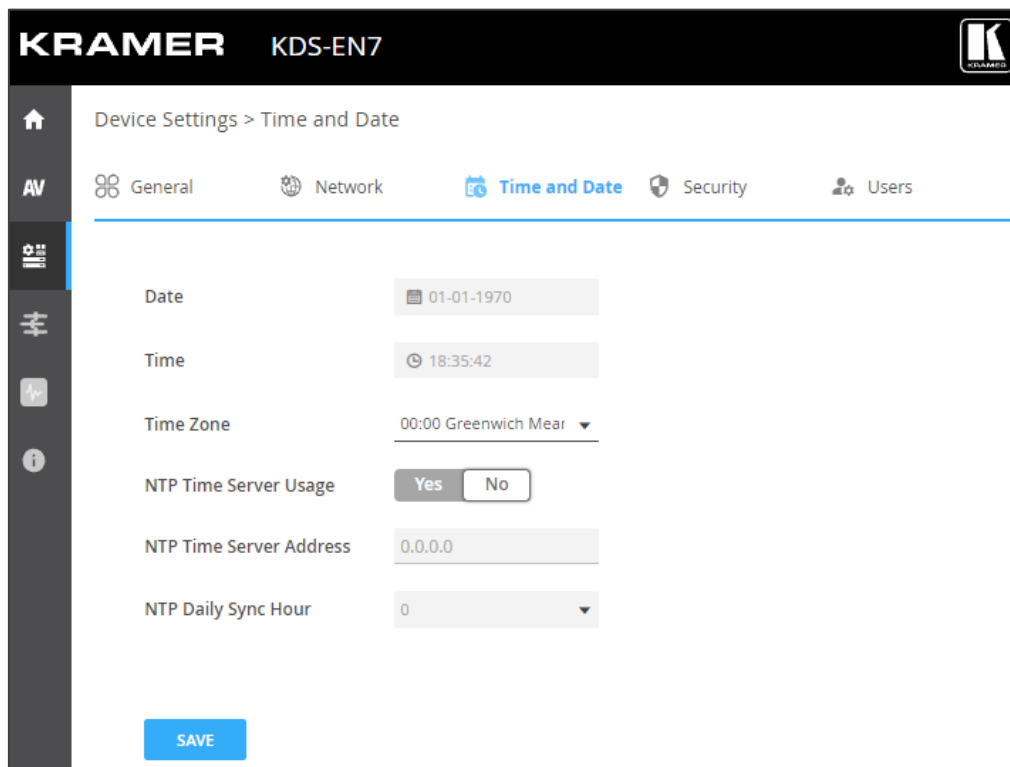

Figure 19: Device Settings – Time and Date Tab

3. Next to Use Time Server (NTP), click **YES** to use time server (NTP).

Network fields are enabled.

4. Type in server information:
  - Enter the server address.
  - Set daily sync hour.

5. Click **SAVE**.

The device's date and time are synchronized to the server address entered.

## Setting KDS-EN7 Security

The Security tab configures device 802.1x authentication to limit unauthorized access, and HTTPS/TLS for establishing an encrypted connection to an authenticated peer over the network.

This section describes the following actions:

- [Configuring HTTPS](#) on page [33](#).
- [Defining 802.1x Authentication](#) on page [34](#).



Contact your IT administrator for the network access authentication.

## Configuring HTTPS

To configure HTTPS:

1. In the Navigation pane, click **Device Settings**. The General tab in the Device Settings page appears (see [Figure 17](#)).
2. Select **Security** tab. The Security tab appears.

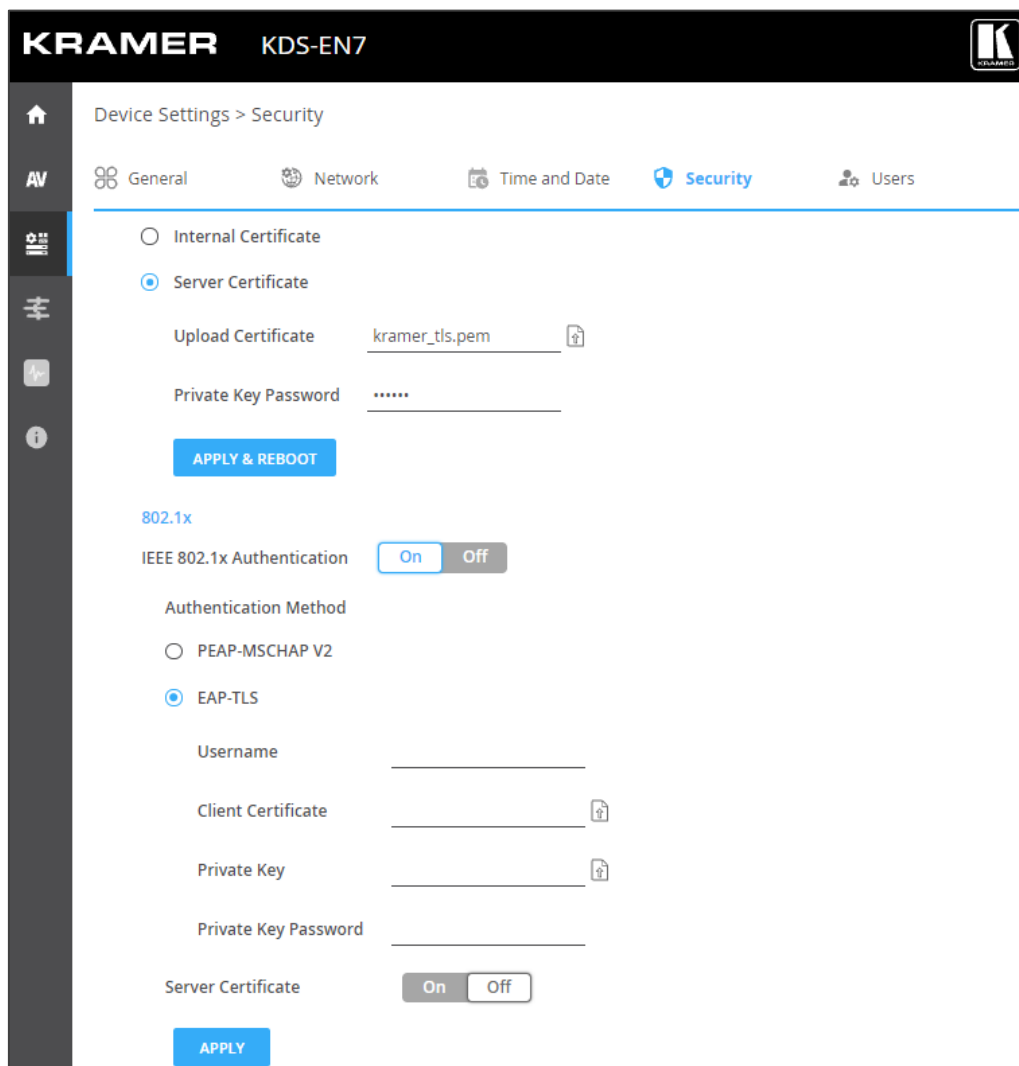



Figure 20: Device Settings – Security Tab

3. For HTTPS server, click **ON** to enable HTTPS authentication service (default) or **Off** to disable HTTPS authentication.
4. When set to ON check one of the following settings:
  - **Internal Certificate** – To use the factory default certificate for authentication.
  - **Server Certificate** – To submit certificate from the server for authentication. To do so, click  to upload the certificate. enter the private key password (assigned by the IT administrator) and click **APPLY & REBOOT**.

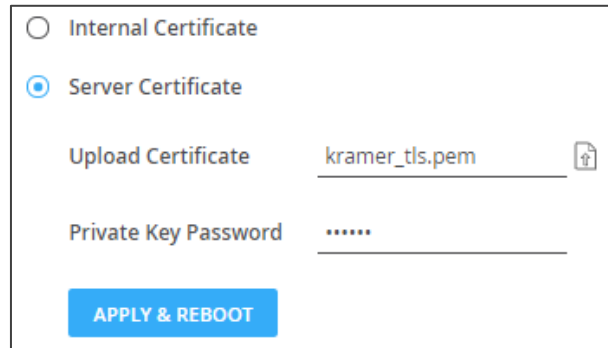

Figure 21: Security Tab – Server Certificate

5. Click **APPLY**.

HTTPS is configured.

## Defining 802.1x Authentication

To configure security:

1. In the Navigation pane, click **Device Settings**. The General tab in the Device Settings page appears (see [Figure 17](#)).
2. Select **Security** tab. The Security tab appears (see [Figure 20](#)).
3. For 802.1x authentication, click **ON** to enable 802.1x authentication service. 802.1x supports authentication based on port and MAC address.
4. When set to ON check one of the following settings:
  - **PEAP-MSCHAP V2** – To use this authentication method, enter a Username (up to 24 alphanumeric characters, including “\_” and “-” characters within the username) and Password (up to 24 ASCII characters):

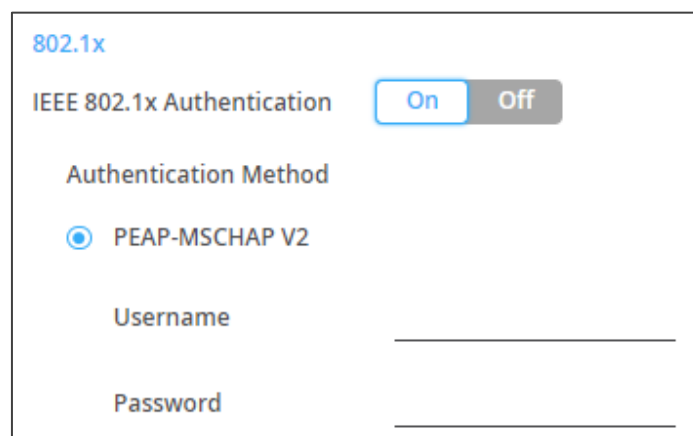

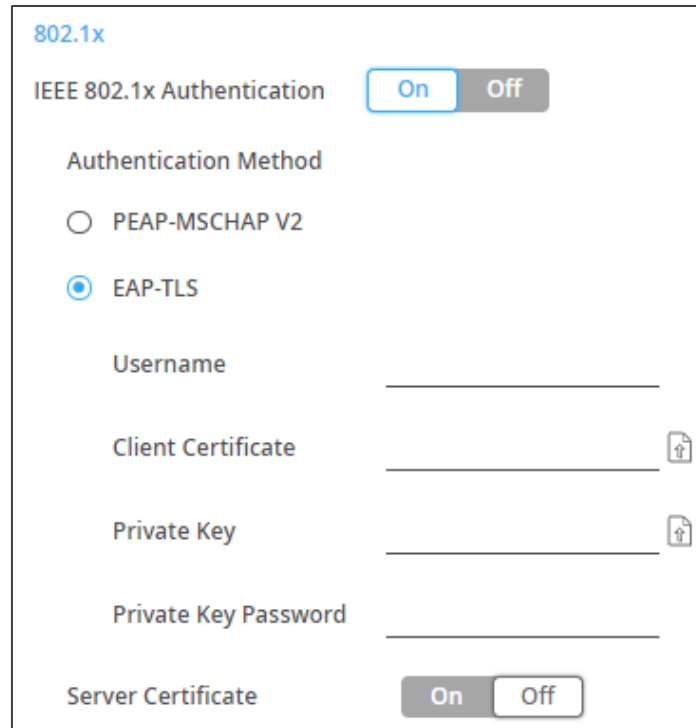

Figure 22: Security Tab – EAP-MSCHAP V2 Authentication

- **EAP-TLS** – To submit certificate from the server for authentication. To do so, enter the Username, click  to upload the certificates and keys, and enter the private key password (assigned by IT administrator). Set Server Certificate **On**.



802.1x

IEEE 802.1x Authentication

Authentication Method

PEAP-MSCHAP V2

EAP-TLS

Username \_\_\_\_\_

Client Certificate \_\_\_\_\_ 

Private Key \_\_\_\_\_ 

Private Key Password \_\_\_\_\_

Server Certificate

Figure 23: EAP-TLS – Certificates and Password

5. Click **APPLY**.

Security is configured.

## Defining KDS-EN7 User Access

The Users tab enables activating device security and defining logon authentication details. When device security is on, web page access requires authentication upon initial landing on operation page. The default password is **admin**. By default, security is disabled.

### Enabling User Access

To enable security:

1. In the Navigation pane, click **Device Settings**. The General tab in the Device Settings page appears (see [Figure 17](#)).
2. Select Users tab.

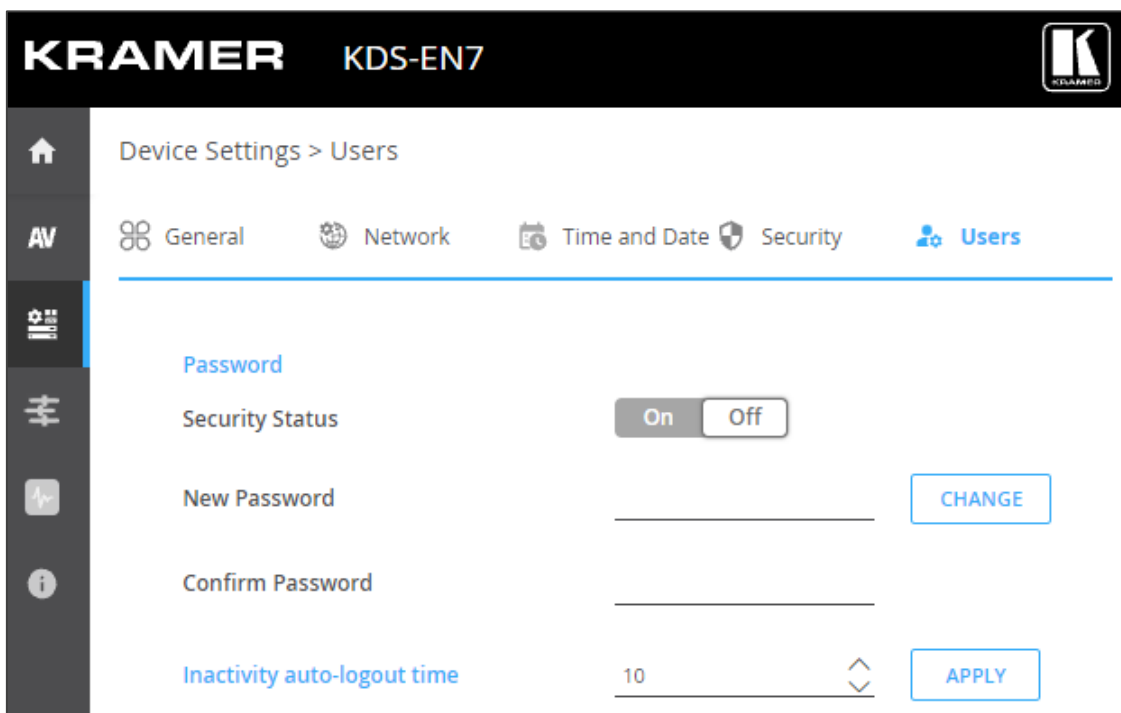

Figure 24: Device Settings – Users Tab

3. Click **On** next to Security Status to enable web page authentication (Off by default). The following message appears.

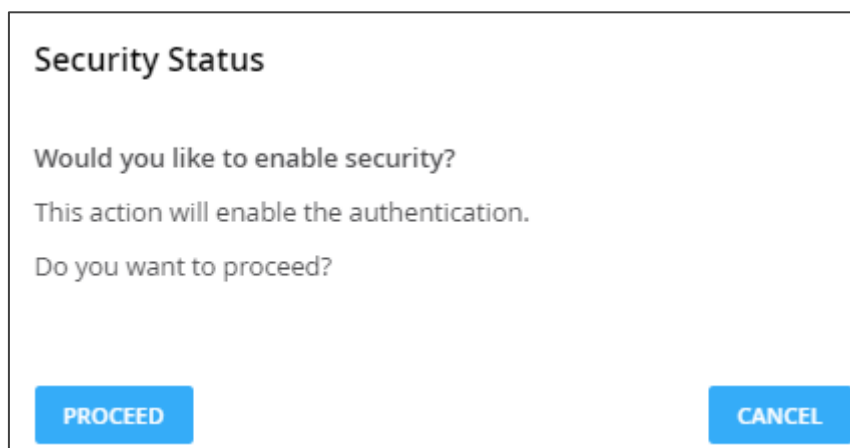

Figure 25: Security Tab – Security Status

- Click **PROCEED**. The web page refreshes, and the password fields are visible.  
Security is enabled and access requires authentication.

## Disabling User Access

To enable security:

- In the Navigation pane, click **Device Settings**. The General tab in the Device Settings page appears (see [Figure 17](#)).
- Select Users tab (see [Figure 24](#)).

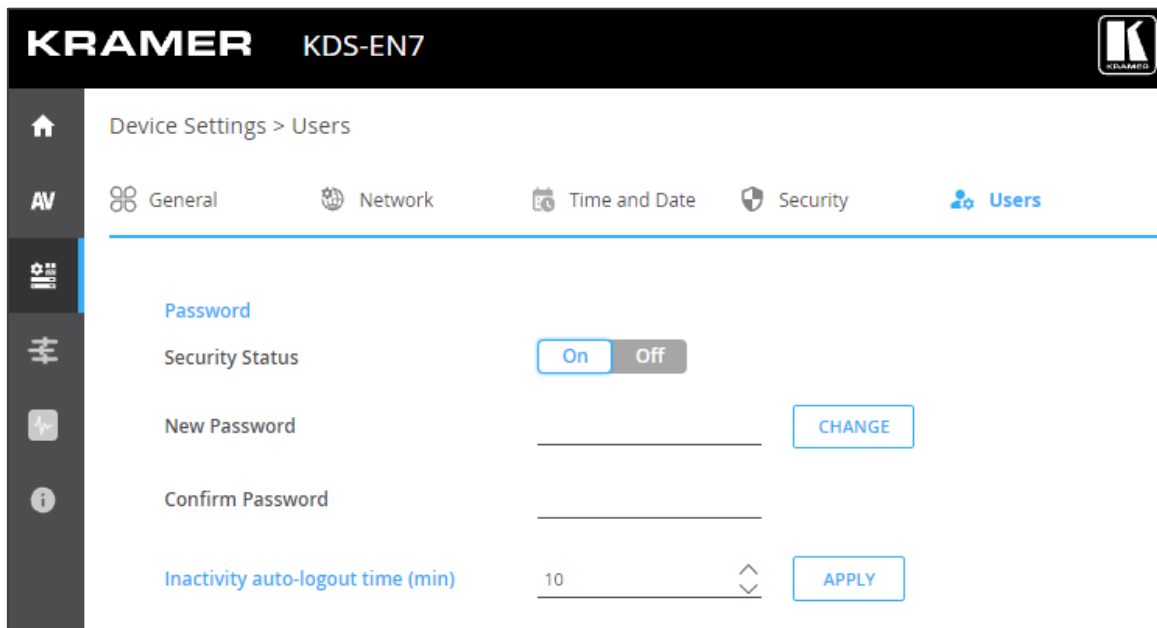

Figure 26: Device Settings – Users Tab

- Click **Off** next to Security Status to enable web page authentication. The following message appears.

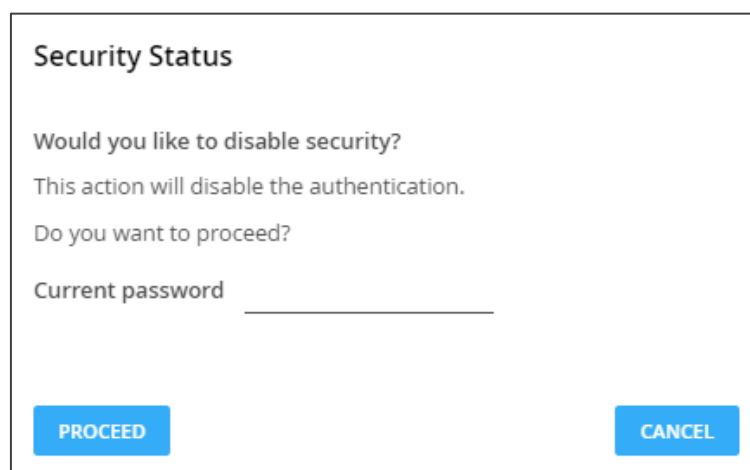

Figure 27: Security Tab – Security Status

- Enter the current password.
- Click **PROCEED**.  
Security is disabled.



## Logging Out

You can define the time of inactivity before the page logs out automatically by setting the Inactivity auto-logout time (in minutes).

## Changing the Password

To change the password:

1. In the Navigation pane, click **Device Settings**. The General tab in the Device Settings page appears (see [Figure 17](#)).
2. Select Users tab (see [Figure 24](#)).

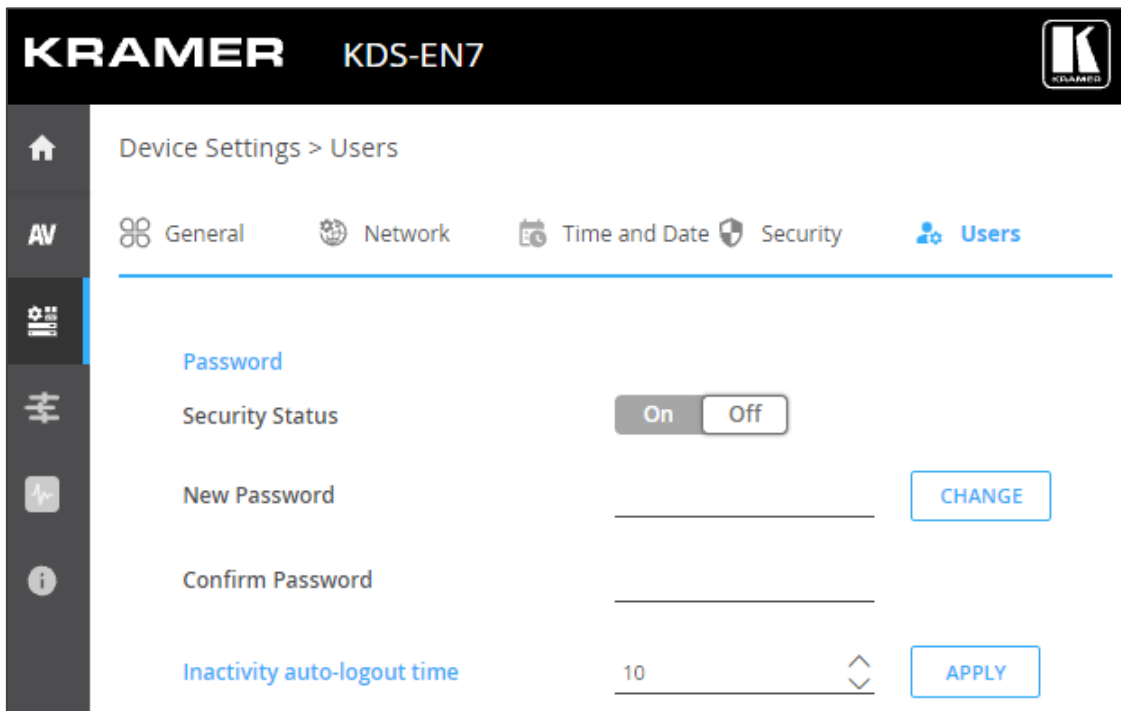

Figure 28: Device Settings – Users Tab

3. Next to New Password, enter the new password.
4. Next to Confirm Password, enter the new password again.
5. Click **CHANGE**.

Password has changed.

---

## Defining KDS-EN7 Gateway Settings

KDS-EN7 enables configuring CEC, RS-232 and/or IR gateway Control. You can perform the following actions:

- [Configuring CEC Settings](#) on page [39](#).
- [Configuring RS-232 Settings](#) on page [40](#).
- [Configuring IR Settings](#) on page [41](#).

## Configuring CEC Settings

KDS-EN7 sends CEC commands from a control system, connected by LAN, via the KDS-EN7 built-in control gateway, to control CEC enabled devices that are connected to the KDS-EN7 HDMI output and input.

To set CEC Gateway:

1. In the Navigation pane, click **Control**. The Control>Settings page appears.

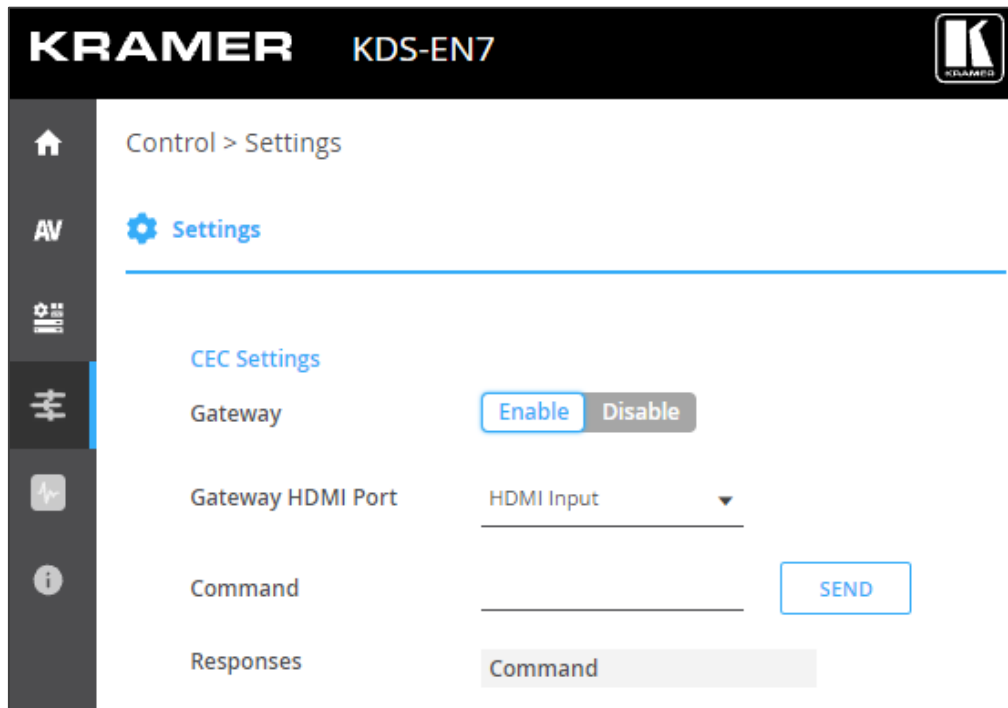

Figure 29: Control > Settings Page – CEC Settings

2. Click **Enable** to enable CEC gateway or click **Disable**.
  3. Select the HDMI port from the drop-down list to which CEC commands are sent:
    - HDMI Input (HDMI IN).
    - HDMI Loop Through (HDMI OUT).
  4. Enter the CEC command.  
Use hex format for the CEC command, up to 32 hex digits.
  5. Click **SEND**.
  6. View the CEC-enabled device response.
- CEC Gateway is configured.

## Configuring RS-232 Settings

KDS-EN7 sends RS-232 commands from a control system, connected by LAN, via the KDS-EN7 built-in control gateway, to devices that are connected to the KDS-EN7 RS-232 port.

To set RS-232 Gateway:

1. In the Navigation pane, click **Control**. The Control>Settings page appears (see [Figure 29](#)).

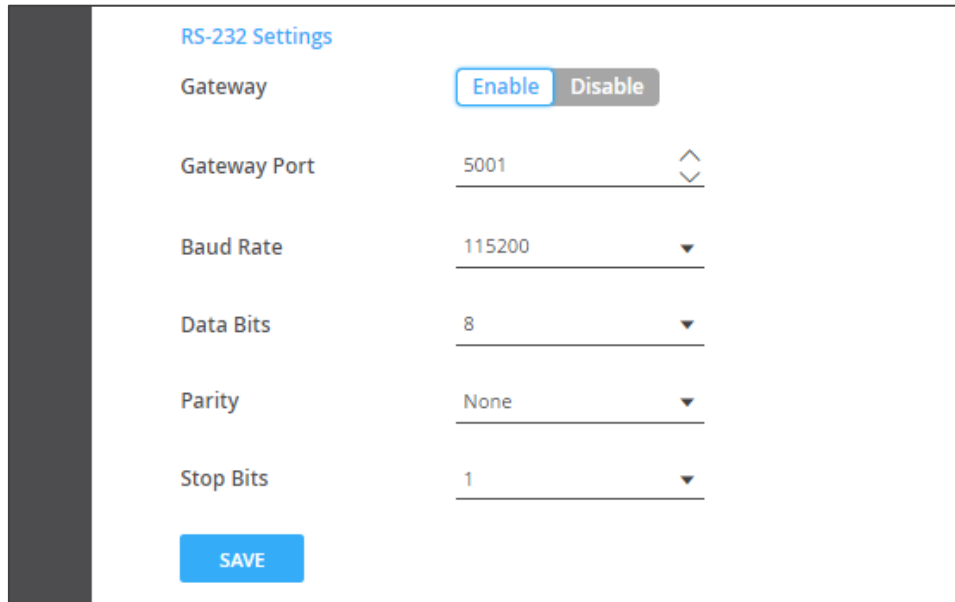

RS-232 Settings	
Gateway	<input checked="" type="checkbox"/> Enable <input type="checkbox"/> Disable
Gateway Port	5001 <input type="text"/>
Baud Rate	115200 <input type="text"/>
Data Bits	8 <input type="text"/>
Parity	None <input type="text"/>
Stop Bits	1 <input type="text"/>
<input type="button" value="SAVE"/>	

Figure 30: Control > Settings Page – RS-232 Settings

2. Click **Enable** to enable RS-232 gateway or click **Disable**.
3. Define the RS-232 gateway port (5001, by default).
4. Enter the Baud Rate: 9600, 19200, 38400, 57600 or 115200 (default).
5. Enter the Data Bits: 5, 6, 7 or 8 (default).
6. Enter Parity: None (default), Odd or Even.
7. Enter Stop Bits: 1 (default) or 2.
8. Click **SAVE**.

RS-232 Gateway is configured.

## Configuring IR Settings

KDS-EN7 sends IR commands from a control system, connected by LAN, via the KDS-EN7 built-in control gateway, to IR connected devices.

To set RS-232 Gateway:

1. In the Navigation pane, click **Control**. The Control>Settings page appears.

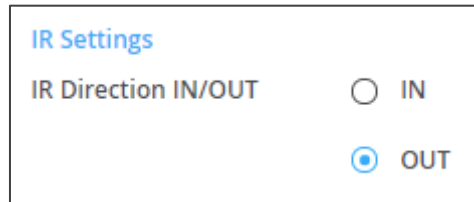

Figure 31: Control > Settings Page – IR Settings

2. Set IR direction:
  - **IN** – Configure the IR port as an input port that is connected to an IR receiver cable.
  - **OUT** – Configure the IR port as an output port that is connected to an IR emitter cable.

IR Gateway is configured.

## Viewing KDS-EN7 Status

View the device status.

To view device status:

1. In the Navigation pane, click **Diagnostics**. The Status tab appears.

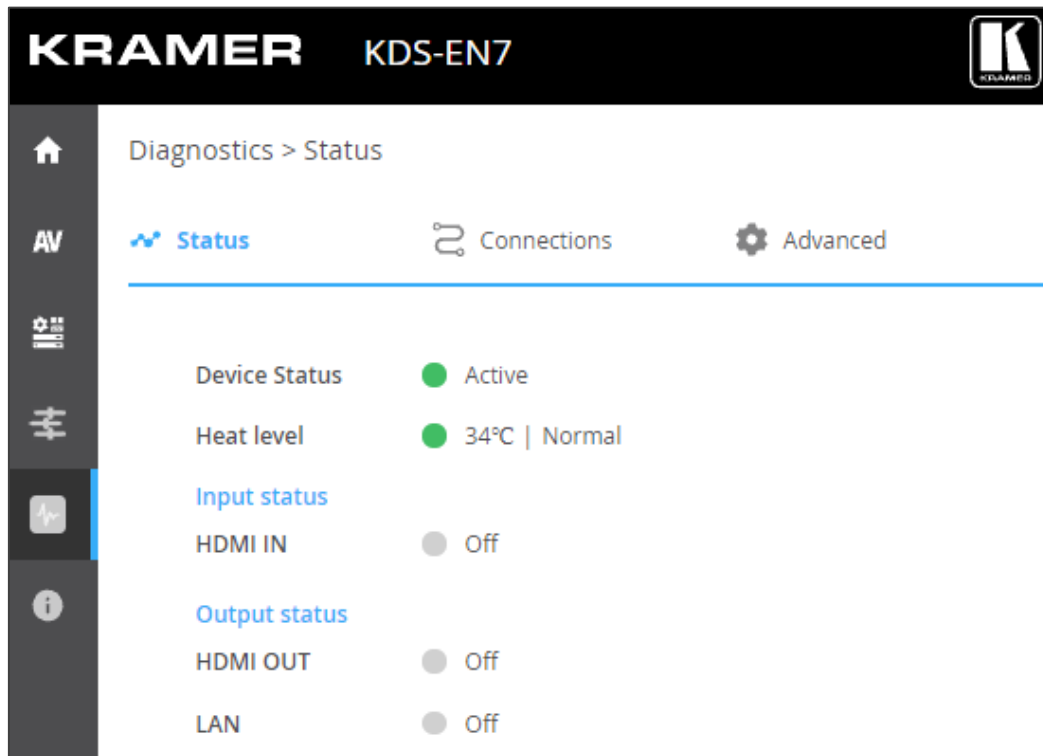

Figure 32: Diagnostics – Status Tab

2. View the Device Status:
  - **Active**, for normal operation (green indication).
  - **Standby**, when device is powered Off, booting or in standby mode (yellow indication).
3. View device internal heat status:
  - **Normal**, for temperatures under 45°C (green indication).
  - **High**, for temperatures between 45°C and 60°C (orange indication).
  - **Overheat**, for temperatures higher than 60°C (red indication).
4. View the input status:
  - **On**, when the input has a valid signal and is transmitting a signal (green indication).
  - **Off**, when an input is not connected or there is no valid signal (gray indication).
5. View HDMI OUT and LAN output status:
  - **On**, when an output is transmitting a signal (green indication).
  - **Off**, when an output has no signal output (gray indication).

Device status is viewed.

## Viewing KDS-EN7 Connections Status

View the connection information status.

To view Connections status:

1. In the Navigation pane, click **Diagnostics**. The Status tab appears (see [Figure 32](#)).
2. Select the Connections tab.

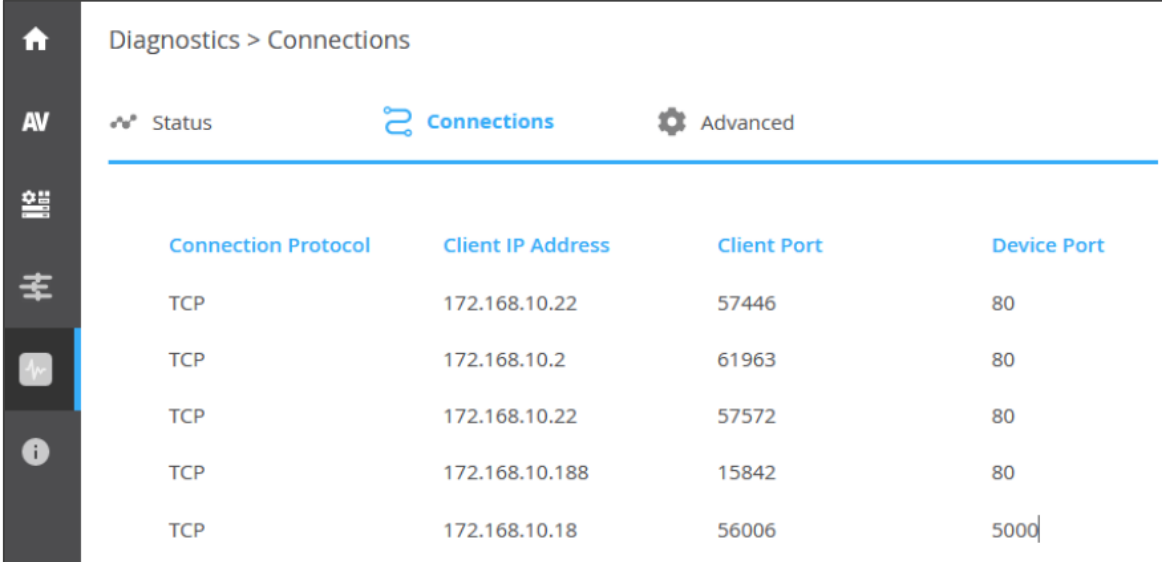

Connection Protocol	Client IP Address	Client Port	Device Port
TCP	172.168.10.22	57446	80
TCP	172.168.10.2	61963	80
TCP	172.168.10.22	57572	80
TCP	172.168.10.188	15842	80
TCP	172.168.10.18	56006	5000

Figure 33: Diagnostics – Status Tab

3. View the Connections status, including protocol type, client IP address and port, and the device port.

Connections' status is viewed.

## Viewing KDS-EN7 Advanced Status

View the system log and gateway messages counter.

To view log and message counter:

1. In the Navigation pane, click **Diagnostics**. The Status tab appears (see [Figure 32](#)).
2. Select the Advanced tab.

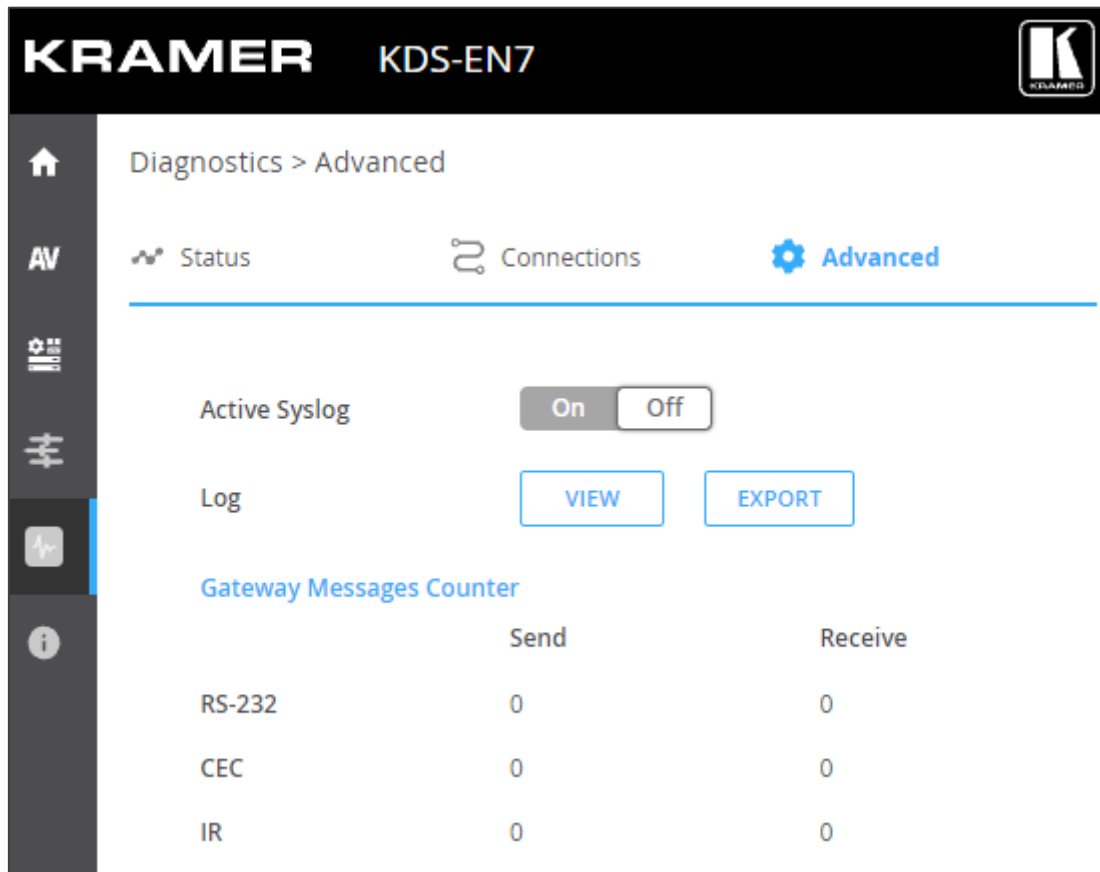

Figure 34: Diagnostics – Advanced Tab

3. Define Syslog activity:
  - **On**, to enable device system log locally.
  - **Off** (default), to disable device system log locally.
4. Click **VIEW** to view the system log, if required.
5. Click **EXPORT** to export the system log (.txt) to the local PC.
6. View the sent and received gateway messages.

System log and counters are viewed.

# Viewing the About Page

View the web page hardware release, firmware version and Kramer Electronics Ltd details in the About page.

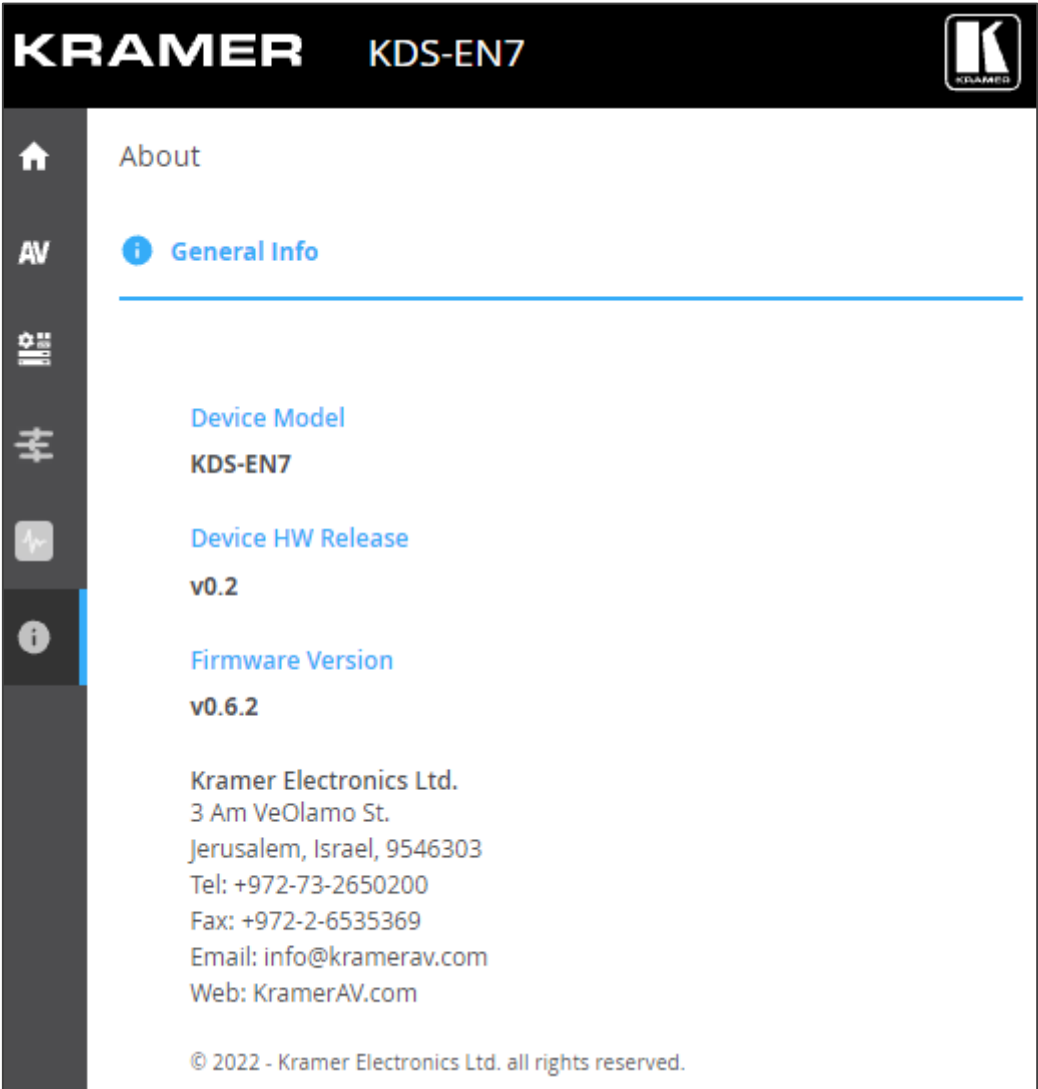

Figure 35: About Page



# Using KDS-DEC7 Embedded Web Pages

KDS-DEC7 can be operated remotely using the embedded web pages. The web pages are accessed using a Web browser and an Ethernet connection.

Before attempting to connect:

- Perform the procedures in [Operating via Ethernet](#) on page [14](#).
- Ensure that your browser is supported.

The following operating systems and Web browsers are supported:

Operating Systems	Applicable Browser Versions and Higher
Windows 7	Chrome: 25 Internet Explorer: 9 Firefox 19 Opera: 11
Mac (PC)	Chrome: 25 Firefox: 19 Opera: 11
iOS	Chrome: 25 Safari (depends on the IOS version) Opera: 11
Android OS	Chrome: 25 Opera: 11



Some features might not be supported by some mobile device operating systems.

KDS-DEC7 enables performing the following:

- [Defining AV Routing Parameters](#) on page [48](#).
- [Configuring OSD settings](#) on page [50](#).
- [Configuring KVM Settings](#) on page [51](#).
- [Setting the Video Wall](#) on page [54](#).
- [Configuring the Overlay](#) on page [55](#).
- [Defining Video Settings](#) on page [58](#).
- [General KDS-DEC7 Settings](#) on page [59](#).
- [KDS-DEC7 Network Settings](#) on page [61](#).
- [Defining KDS-DEC7 Time and Date](#) on page [62](#).
- [Setting KDS-DEC7 Security](#) on page [63](#).
- [Defining KDS-DEC7 User Access](#) on page [64](#).
- [Defining Gateway Settings](#) on page [64](#).

- [Viewing KDS-DEC7 Status](#) on page [65](#).
- [Viewing KDS-DEC7 Connections Status](#) on page [66](#).
- [Viewing KDS-DEC7 Advanced Status](#) on page [67](#).
- [Viewing the KDS-DEC7 About Page](#) on page [68](#).

#### To Browse the KDS-DEC7 Web Pages:

1. Connect the LAN port of the device

Open your Internet browser.

2. Type the IP number of the device in the Address bar of your browser. For example, the default IP number:

. The Login window appears.

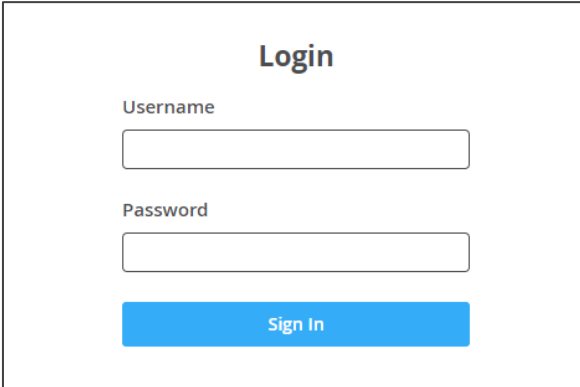

The screenshot shows a web page titled "Login". It contains two input fields: "Username" and "Password". Below these fields is a blue button labeled "Sign In".

Figure 36: Login Window

- Enter the Username and Password (admin/admin, by default).  
The KDS-DEC7 page appears.

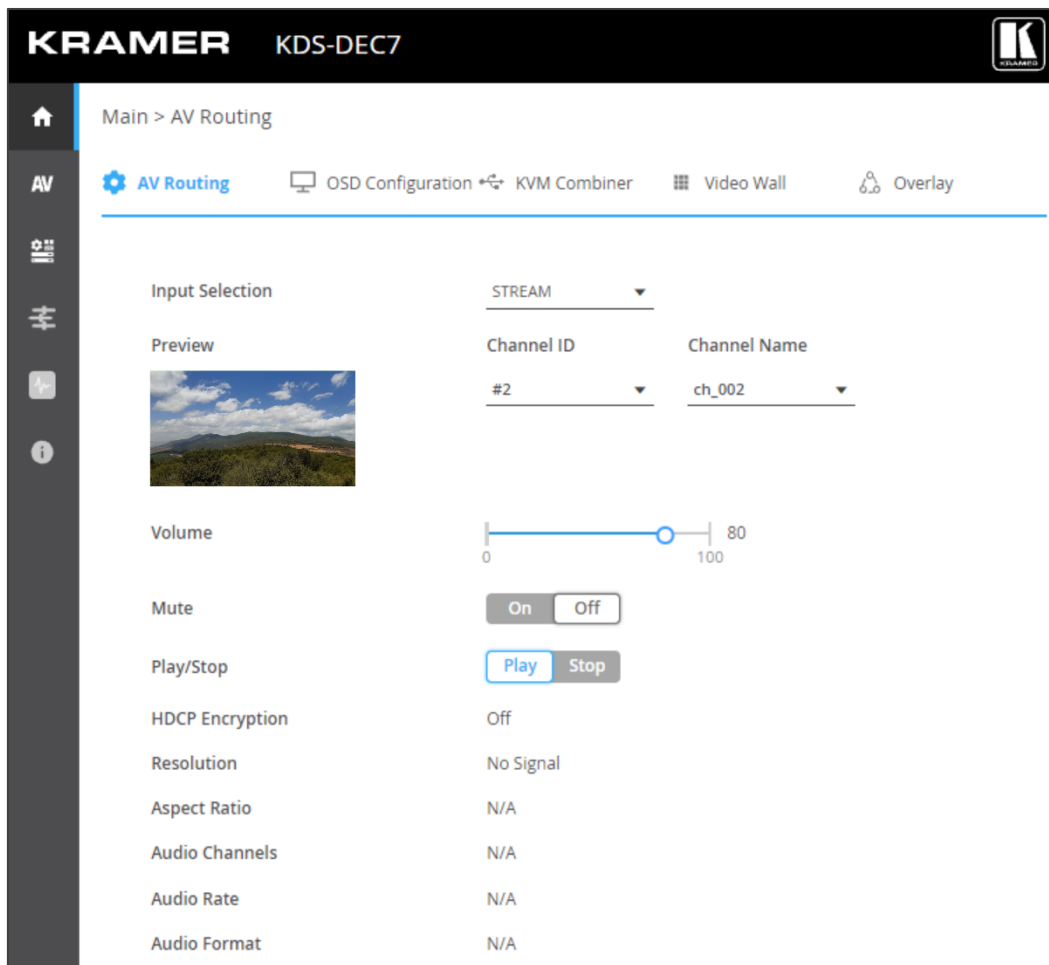

Figure 37: KDS-DEC7 Main Page with Navigation List on Left

- Click the tabs on the left side of the screen to access the relevant web page.

## Defining AV Routing Parameters

Set the KDS-DEC7 AV routing parameters.

To set AV routing parameters:

- In the Navigation pane, Select **Main>AV Routing**. The AV Routing page appears (see [Figure 37](#)).
- From the drop-down list next to Input Selection, set the input source to STREAM or HDMI.
- If STREAM is selected next to Input Selection, set the Channel ID and Channel Name as defined in Main > OSD Configuration > Channel List (see [Configuring OSD settings](#) on page 50).  
A depiction of the streaming appears under Preview.



If HDMI is selected next to Input Selection, the preview window and Channel ID and name are hidden.

4. Use the slider next to Volume to adjust the analog audio output volume (0 to 100%). Default is 80 (0dB), 100% (12dB) and 0 is mute.
5. Mute/unmute all audio outputs (HDMI OUT, AUDIO OUT, and LAN output).
  - Play (default) or stop streaming of video, audio, IR, RS-232 and USB signals.
6. View the following streaming parameters: HDCP Encryption, Resolution, Aspect Ratio, Audio Channels, Audio Rate and Audio Format.

Routing Parameters are defined.

## Configuring OSD settings

Configure the KDS-DEC7 OSD settings.

To configure the OSD:

1. In the Navigation pane, Select **Main>AV Routing**. The AV Routing page appears (see [Figure 37](#)).
2. Select the OSD Configuration tab.

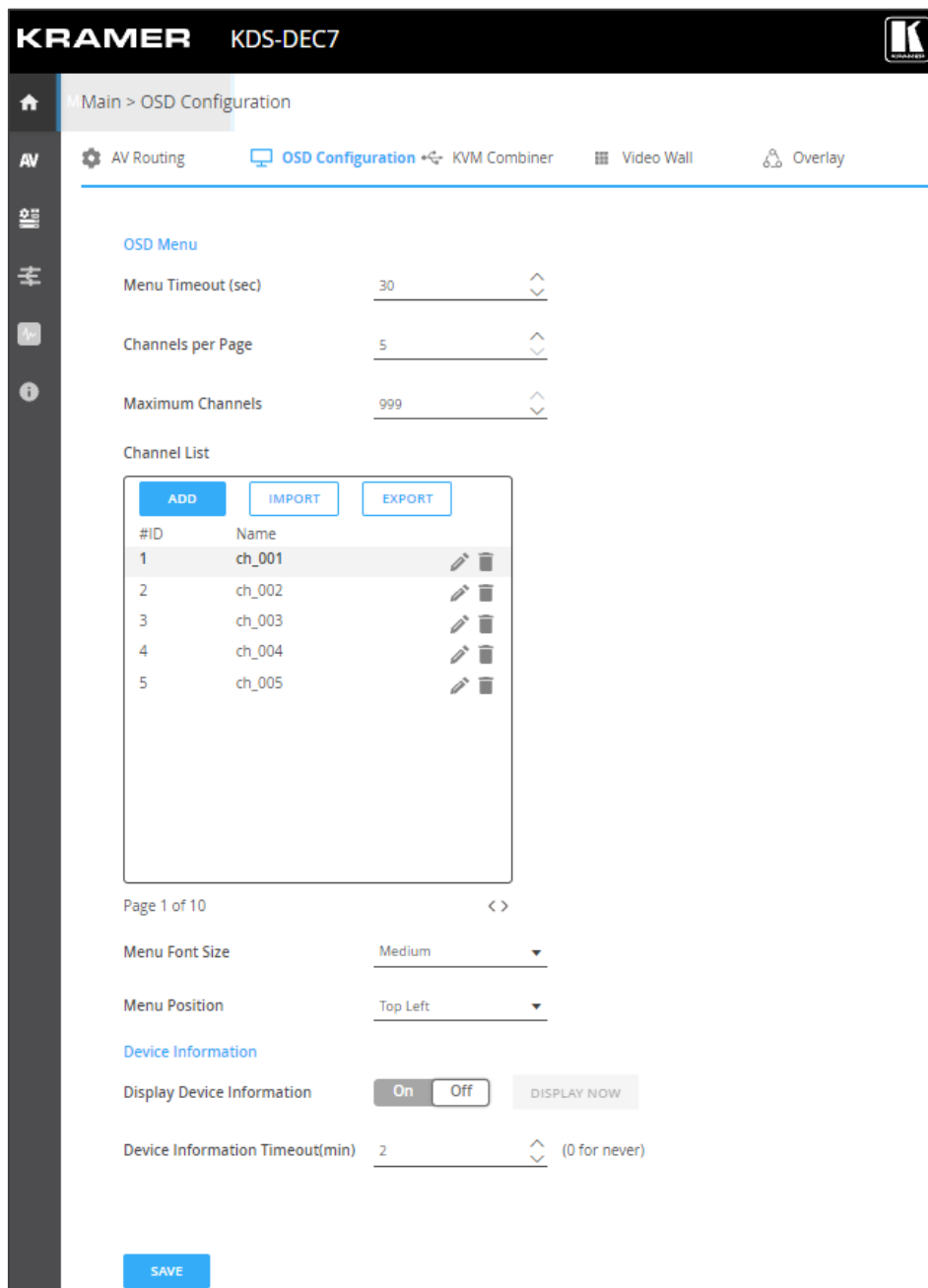

Figure 38: Main Page – OSD Configuration Tab

3. Set the menu timeout in seconds.
4. Define the number of channels that are displayed per page in the channel list. you can select 5 (default) to 10 per page (for 3840x2160 resolution, you can select up to 7 items per page).

5. Define the maximum number of channels that can be displayed (up to 999).
6. View the channel list and perform the following actions:
  - Click **ADD** to add the channel ID and name one by one to the Channel List.
  - Click **IMPORT** to import a preset channel list (.json) to this channel list.
  - Click **EXPORT** to export the channel list to your PC.
7. Set the menu font size and position.
8. Next to Display Device Information, click **On** to display Device Information on the screen (including device version, IP address and MAC address, etc.) or click **Off**.
9. Click **DISPLAY NOW** (when device information is set to On).
10. Set the device information timeout.



If video is lost, and the sleep image is displayed, Device Information appears, and at this state cannot be turned off.

OSD is configured.

## Configuring KVM Settings

Configure the KDS-DEC7 KVM settings.

To configure KVM settings:

1. In the Navigation pane, Select **Main>AV Routing**. The AV Routing page appears (see [Figure 37](#)).
2. Select the KVM Combiner tab.

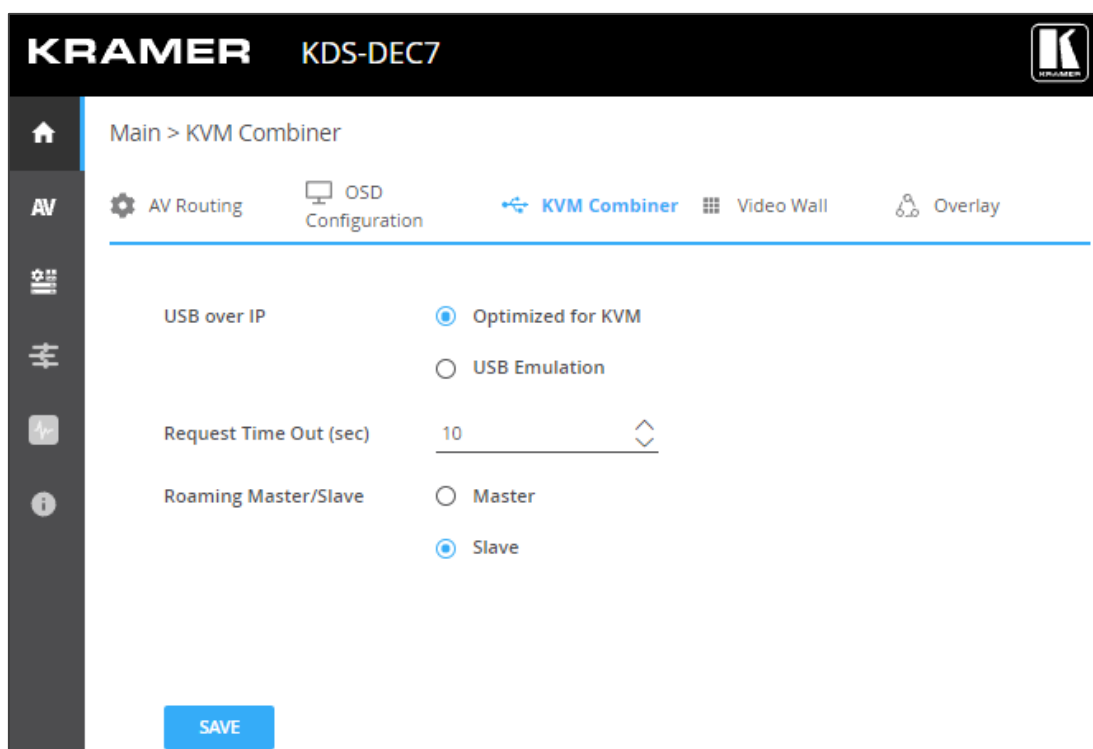

Figure 39: Main Page – KVM Combiner Tab

3. Set USB over IP status. Check:
  - **Optimized for KVM** (default), to enable KVM settings.
  - **USB Emulation**, to enable USB pairing function.
4. Next to Request Time Out (sec), set the time for which the decoder that gets the USB token from the encoder remains inactive, so then another routed decoder can get the USB token from the encoder.  
 For example, If the request timeout is set to 10 seconds (default), when a decoder that has the USB token remains inactive for 10 seconds, another decoder can get the USB token from the encoder.



Enabled when **Optimized for KVM** is selected.

5. Set Roaming Master/Slave status. Check:
  - **Master**, to configure the device as the Master (see [Configuring Slave Devices When Master is Selected](#) on page 52).
  - **Slave** (default), to configure the device as a Slave.



Enabled when **Optimized for KVM** is selected.

6. Click **SAVE**.

KVM settings are configured.

## Configuring Slave Devices When Master is Selected

When this **KDS-DEC7** device is set as the Master, the following window appears showing this device and its MAC address.

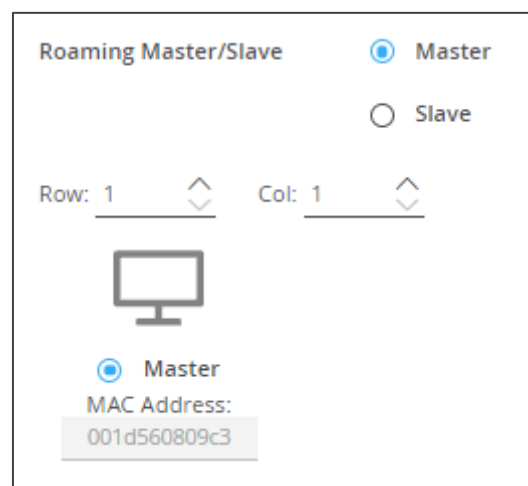

Figure 40: Roaming Master Window

**To configure slave device status:**

1. Define the number of rows and columns for roaming slaves (for example, 2 rows and 2 columns).

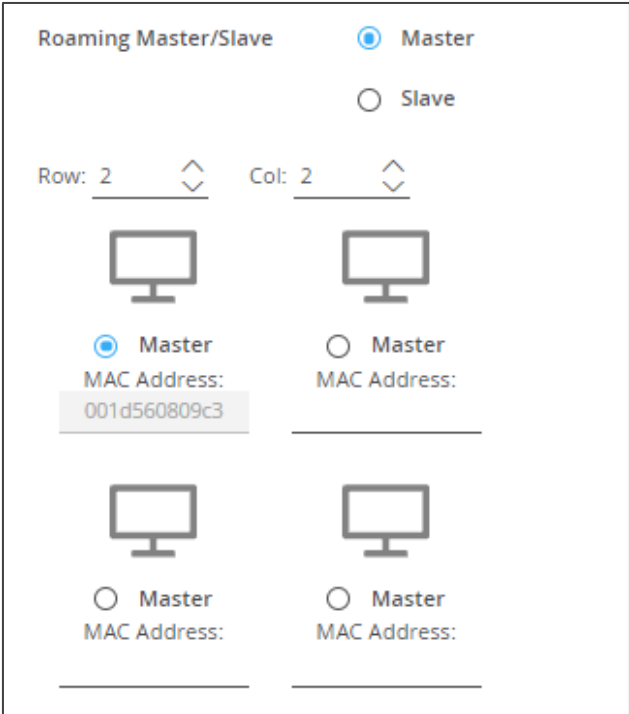

Figure 41: Roaming Slave Status Window

2. Check a Master device to which the keyboard and mouse are connected.
3. Enter the MAC address of the roaming slave device(s).
4. Click **SAVE**.

Roaming Master/Slave configuration is defined.



## Setting the Video Wall

Configure the KDS-DEC7 video wall.

To configure the KDS-DEC7 video wall:

1. In the Navigation pane, Select **Main>AV Routing**. The AV Routing page appears (see [Figure 37](#)).
2. Select the Video Wall tab.

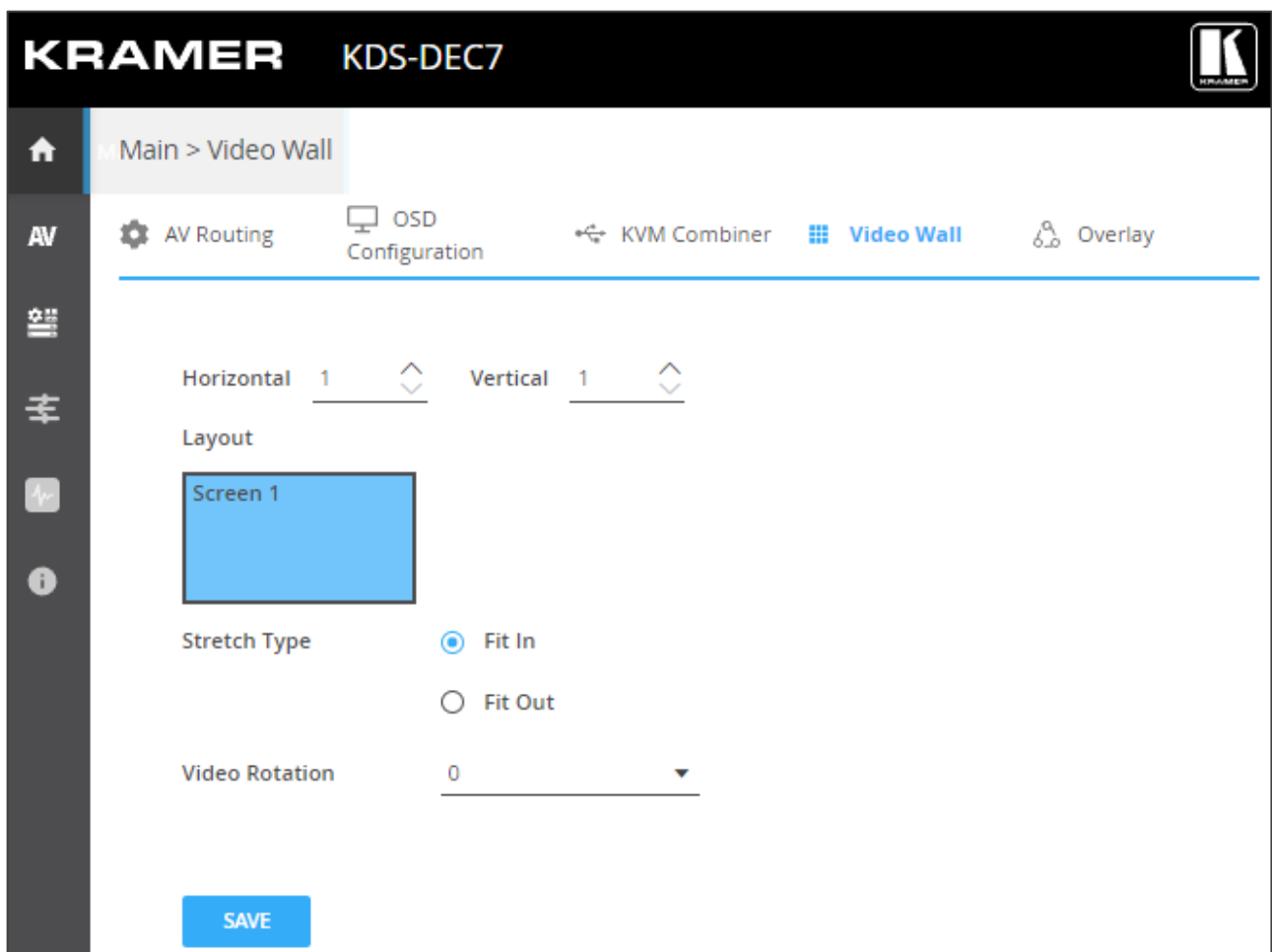

Figure 42: Main Page – Video Wall Tab

- Set the video wall horizontal and vertical size (up to 16x16). For example, select a 2x3 video wall and view the layout.

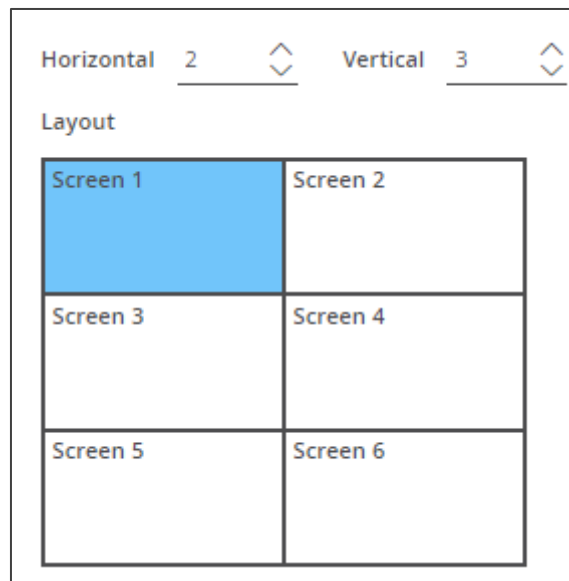

Figure 43: 2x3 Video Wall Configuration

- Define the Image stretch type over the video wall. Check:
  - Fit In**, to stretch the video to fit the screen.
  - Fit Out**, to maintain the source video aspect ratio and fill the video to the screen. Note that part of the video may be cut out.
- If required, rotate the video image by 90, 180 or 270 degrees (default is 0).
- Click **SAVE**.

Video wall is configured.

---

## Configuring the Overlay

Use the Overlay tab to perform the following actions:

- [Configuring the Image Overlay](#) on page [56](#).
- [Configuring the Text Overlay](#) on page [57](#).

## Configuring the Image Overlay

To configure the image overlay:

1. In the Navigation pane, Select **Main>AV Routing**. The AV Routing page appears (see [Figure 37](#)).
2. Select the Overlay tab.

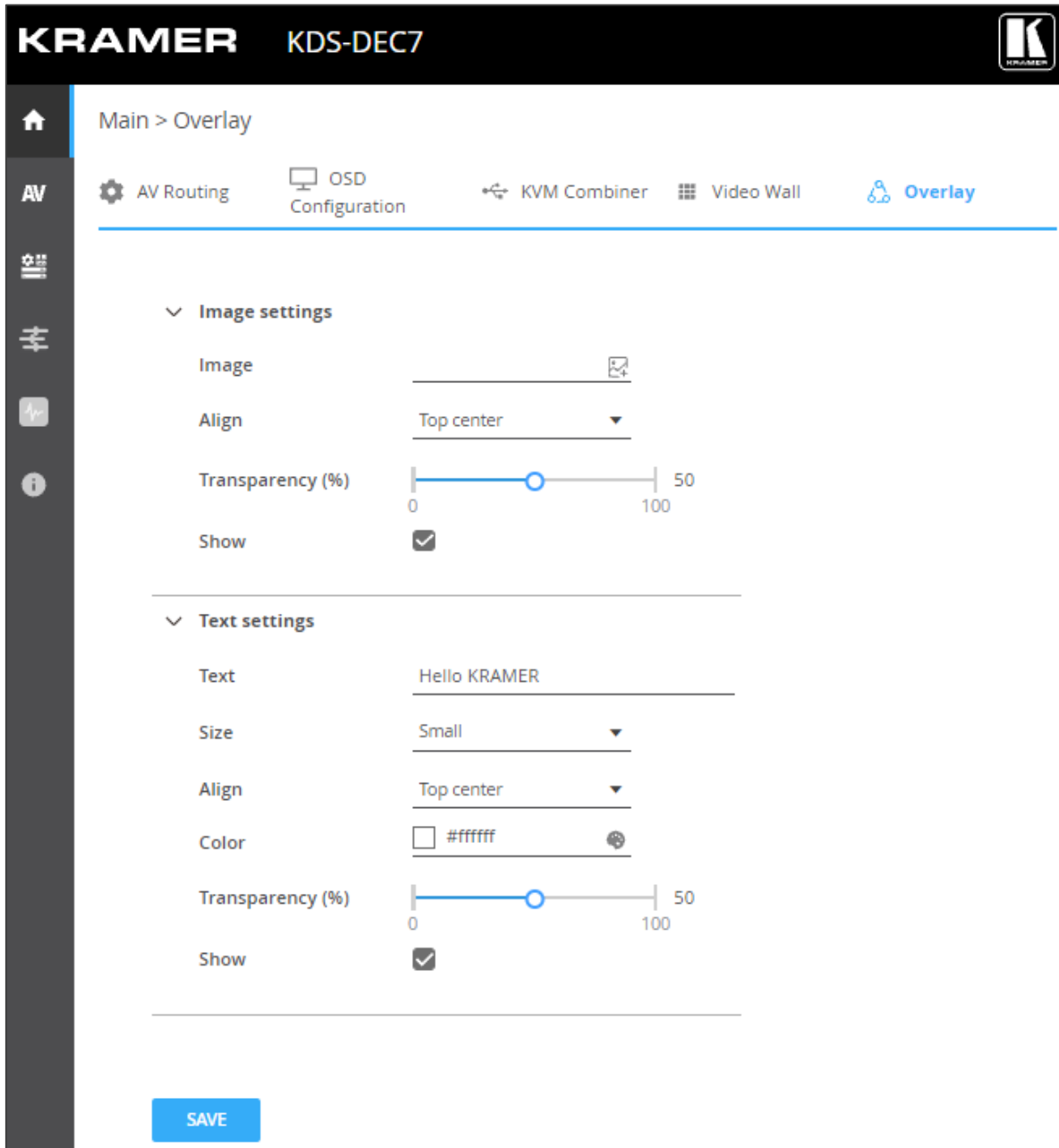

Figure 44: Main – Overlay Tab

3. Click image icon to upload an image.



The image format must be PNG, the resolution up to 640x360, and file size up to 256KB.

4. Set the image location from the drop-down box (default is Top center).
5. Use the slider to define the image transparency from 0 to 100% (invisible).

6. Check **Show** to display the image.
7. Click **SAVE**.

Image overlay is configured.

## Configuring the Text Overlay

To configure the image overlay:

1. In the Navigation pane, Select **Main>AV Routing**. The AV Routing page appears (see [Figure 37](#)).
2. Select the Overlay tab (see [Figure 44](#)).

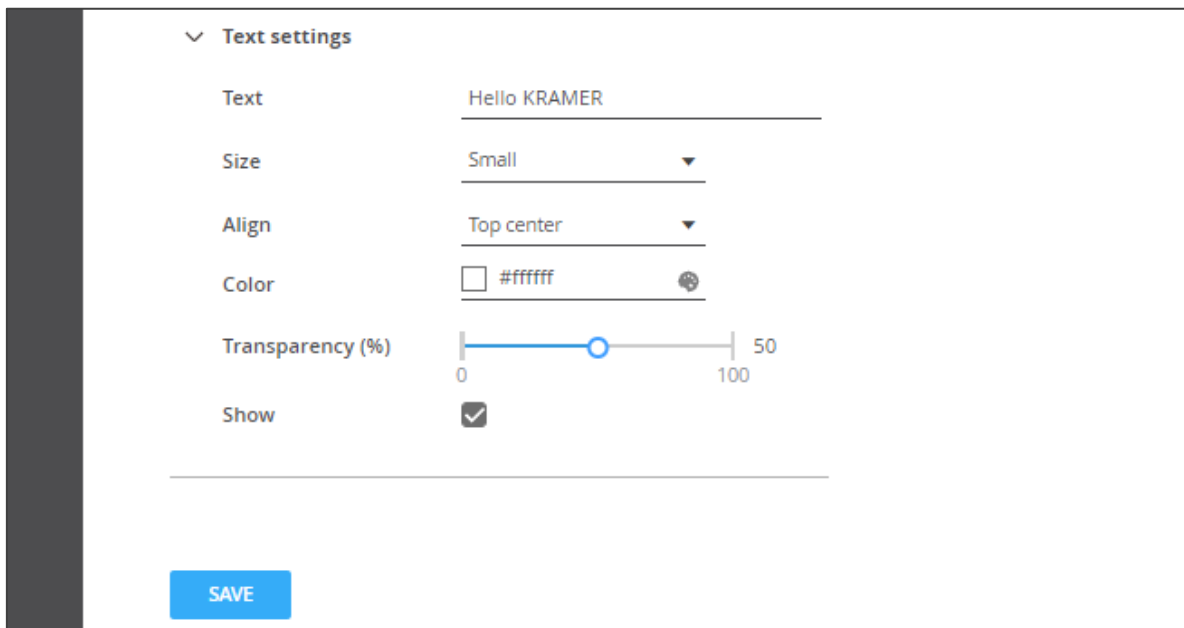

Figure 45: Main Page – Text Overlay Tab

3. Enter the overlay text.
4. Set the text size.
5. Set the text location from the drop-down box (default is Top center).
6. Set the text color.
7. Use the slider to define the text transparency from 0 to 100% (invisible).
8. Check **Show** to display the text.
9. Click **SAVE**.

Text overlay is configured.

## Defining Video Settings

Define KDS-DEC7 video settings.

To define Video settings:

1. In the Navigation pane, Select **AV**. The Video page appears.

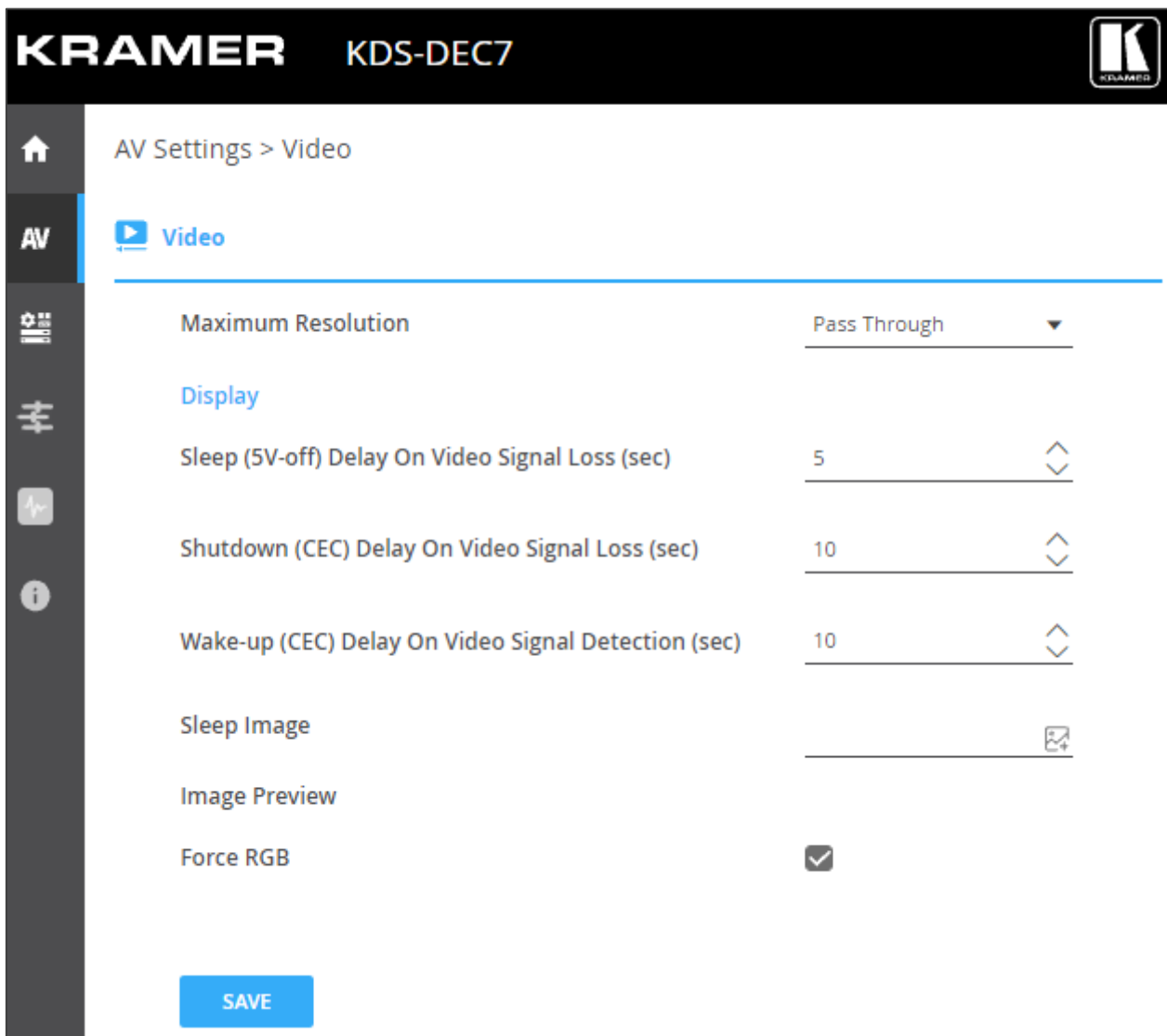

Figure 46: Video Settings

2. From the drop-down list, set the maximum output resolution: Pass Through (default, the output video resolution follows the input stream resolution), Full HD (720p60), Full HD (1080p60), Full HD (1080p50), Ultra HD 2160p25 or Ultra HD (2160p30).



You cannot upscale a source with horizontal pixels > 1920.  
For example, 2048x1080, 3840x2160 are not supported.

The output resolution can be downscaled by downscaling the horizontal + vertical resolutions by half.

For example: 4096x2160 can be downscaled to 1920x1080.

Meaning 128 horizontal pixels are missing ( $4096/2 - 1920 = 128$ ).

For example, 3840x2160 can be downscaled to 1280x720.

Meaning 640 horizontal pixels are missing ( $3840/2 - 1280 = 640$ ) 360 vertical pixels will be missing ( $2160/2 - 720 = 360$ ).

### 3. Define display behavior:

- **Sleep (5V-off) Delay On Video Signal Loss (sec):** when video signal is lost, define the delay time before setting 5V power off.
- **Shutdown (CEC) Delay On Video Signal Loss (sec):** when video signal is lost, define the delay time before a CEC shutdown command is sent to the unit.
- **Wake-up (CEC) Delay on Video Signal Detection (sec):** when the device detects a video signal, define the delay time before a CEC wake up command is sent to the unit.

### 4. Click next to Sleep Image to upload the image to be displayed when there is no signal on the input.

### 5. View live stream preview.

### 6. Set Force RGB mode:

- Check (default) to force RGB as the output video format.
- Uncheck.

### 7. Click **SAVE**.

HDMI input settings are defined.

---

## General KDS-DEC7 Settings

Change the Host Name and click **APPLY**, view the device model, H/W release version, serial number, and MAC address.



Though the device has only one MAC address, you can configure up to two separate IP addresses for the two Ethernet ports in two subnets using one MAC address (see [KDS-DEC7 Network Settings](#) on page [61](#)).

## To define KDS-DEC7 general settings:

1. In the Navigation pane, Select **Device Settings**. The General tab in the Device Settings page appears.

The screenshot displays the 'General' tab of the 'Device Settings' page for a KDS-DEC7 device. The page is organized into several sections:

- General Preferences:**
  - Host Name: KDS-DEC7-001D560809C (with an APPLY button)
  - Device Model: KDS-DEC7
  - Device H/W Release: v0.2
  - MAC Address: 00-1d-56-08-09-c3
  - Serial Number: 11210005700006
  - Front Panel Lock: On/Off toggle (currently On)
  - Import/Export Device Settings: All including IP (with IMPORT and EXPORT buttons)
  - Locate Device: (with an APPLY button)
  - Power Save: On/Off toggle (currently On)
  - Inactivity Auto-standby Delay Duration: 30 (with an APPLY button)
- Version:**
  - Firmware Version: v0.5.6 (with an UPGRADE button)
  - Last Upgrade Date/Time: 01-01-1970,00:01:50
  - Firmware Standby Version: v0.5.1 (with a ROLLBACK button)
- Device Reset:** (with RESTART and RESET buttons)

Figure 47: KDS-DEC7 Device Settings – General Page

2. Perform the following actions for **KDS-DEC7** (as described for **KDS-EN7**):
  - [Locking/Unlocking the Front Panel](#) on page [28](#).
  - [Importing/Exporting Device Settings](#) on page [29](#).
  - [Locating the Device](#) on page [29](#).
  - [Upgrading Firmware](#) on page [75](#).
  - [Restarting or Resetting the Device](#) on page [29](#).

General settings are defined.

## KDS-DEC7 Network Settings

To define KDS-DEC7 Network settings:

1. In the Navigation pane, Select **Device Settings**. The General tab in the Device Settings page appears (see [Figure 47](#)).
2. Select the Network tab.

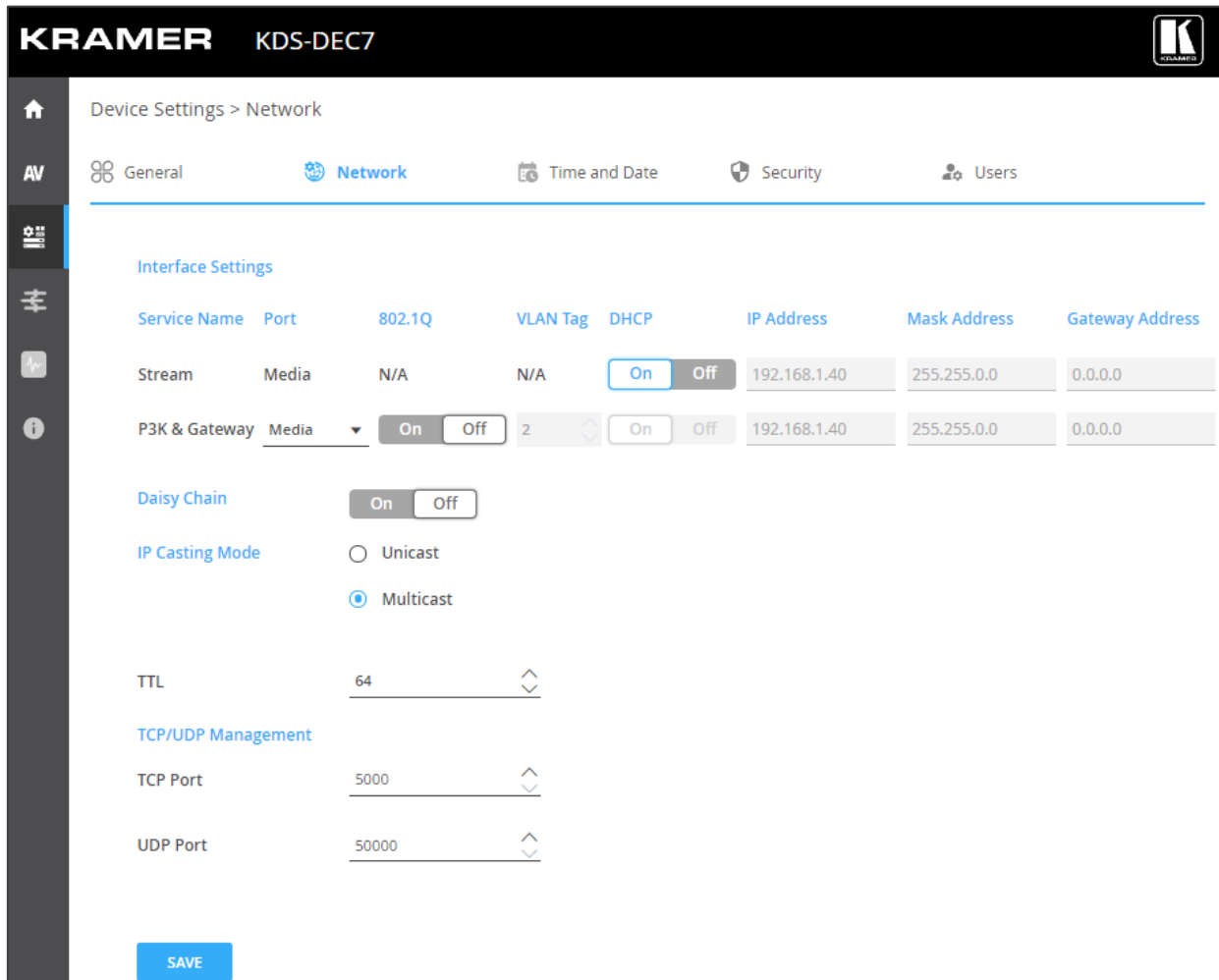

Figure 48: Device Settings – General Page

3. Perform the following actions for **KDS-DEC7** (as described for **KDS-EN7**):
  - [Defining Interface Settings](#) on page [30](#).
  - [Defining IP Casting Mode Setting](#) and TTL on page [31](#).
  - [Managing TCP/UDP Ports](#) on page [31](#).

Network Settings are defined.



## Defining KDS-DEC7 Time and Date

You can set the device time and date manually or Sync the device time and date to any server around the world.

To define KDS-DEC7 Time and Date:

1. In the Navigation pane, Select **Device Settings**. The General tab in the Device Settings page appears (see [Figure 47](#)).
2. Select the Time and Date tab.

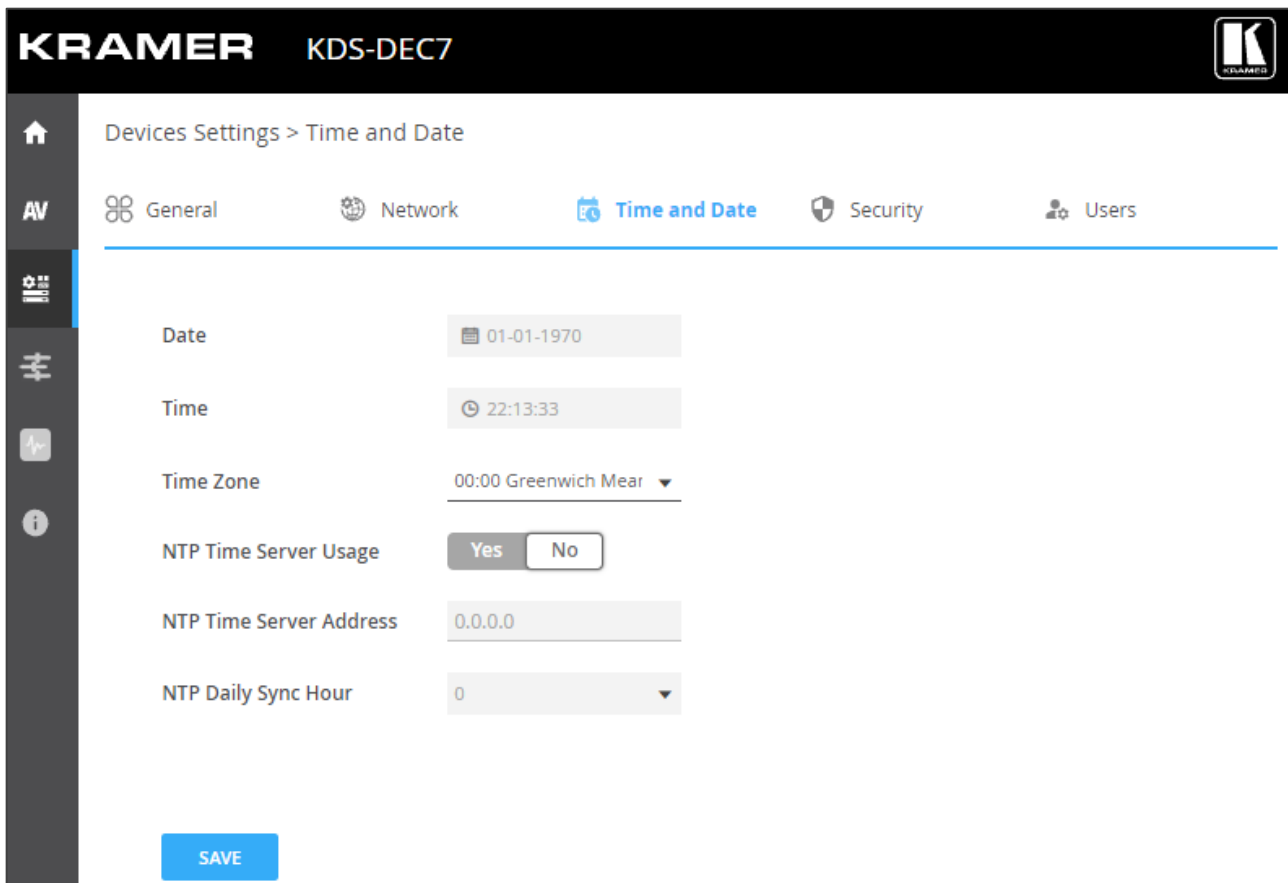

Figure 49: Device Settings Page – Time and Date Tab

3. Perform the following actions for **KDS-DEC7** (as described for **KDS-EN7**):
  - See [Defining KDS-EN7 Time and Date](#) on page [32](#).

Time and date settings are defined.

## Setting KDS-DEC7 Security

The Security tab configures device authentication to limit unauthorized access to LAN/WLAN Network.



Contact your IT administrator for the network access authentication.

### To Configure security:

1. In the Navigation pane, Select **Device Settings**. The General tab in the Device Settings page appears (see [Figure 47](#)).
2. Select the Security tab.

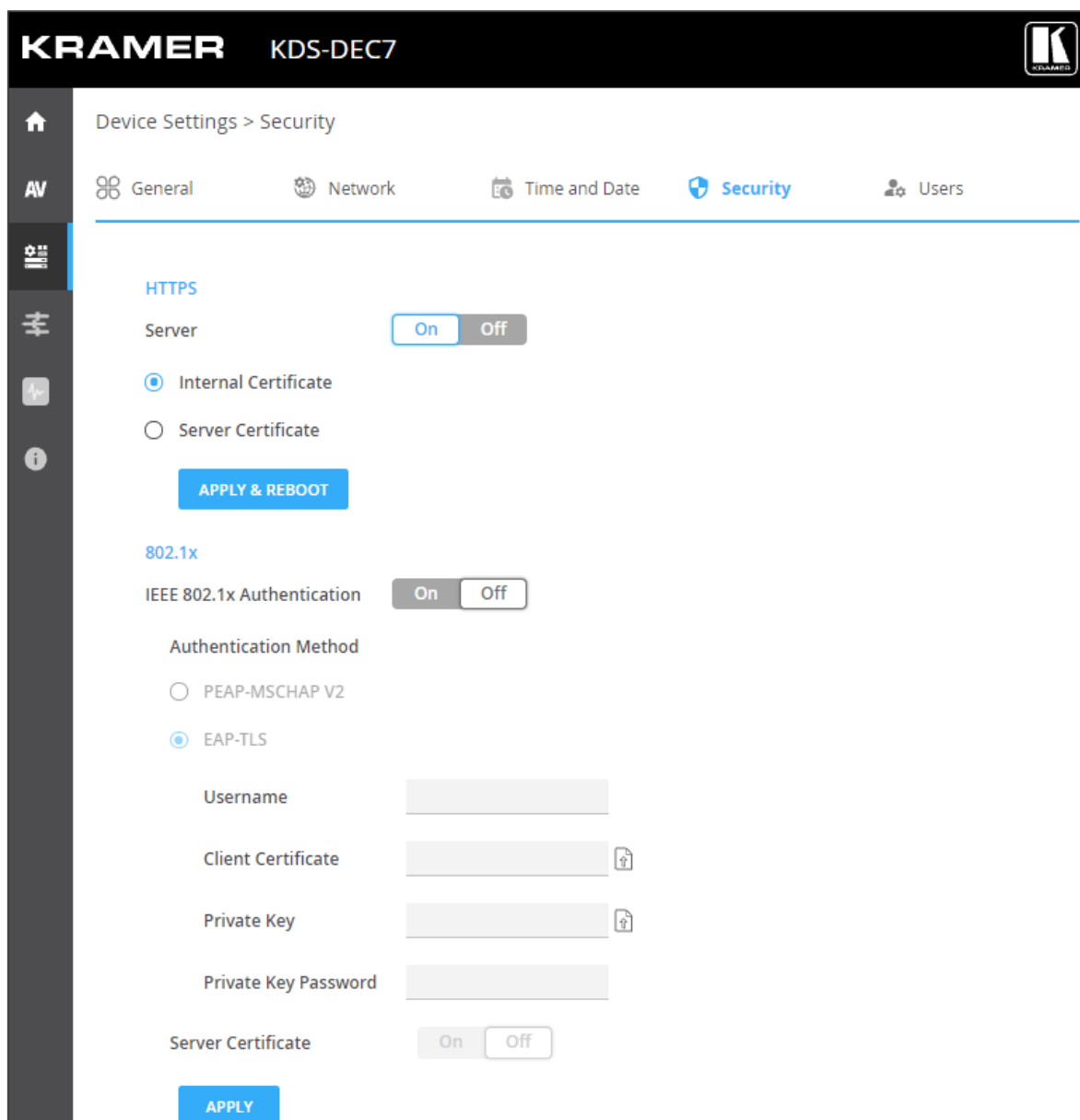

Figure 50: Device Settings – Security Enabled

3. Define security for **KDS-DEC7** (as described for **KDS-EN7**), see [Setting KDS-EN7 Security](#) on page [33](#):

Security is configured.

## Defining KDS-DEC7 User Access

The Users tab enables activating device security and defining logon authentication details. When device security is on, web page access requires authentication upon initial landing on operation page. User and password default is admin. User access to web pages is identical to KDS-EN7, see [Defining KDS-EN7 User Access](#) on page 36.

## Defining Gateway Settings

KDS-DEC7 enables configuring CEC, RS-232 and/or IR gateway Control.

### Configuring CEC Settings

KDS-DEC7 sends CEC commands from a control system, connected by LAN, via the KDS-DEC7 built-in control gateway, to control CEC enabled devices that are connected to the KDS-DEC7 HDMI output and input.

To set CEC Gateway:

1. In the Navigation pane, click **Control**. The Control>Settings page appears.

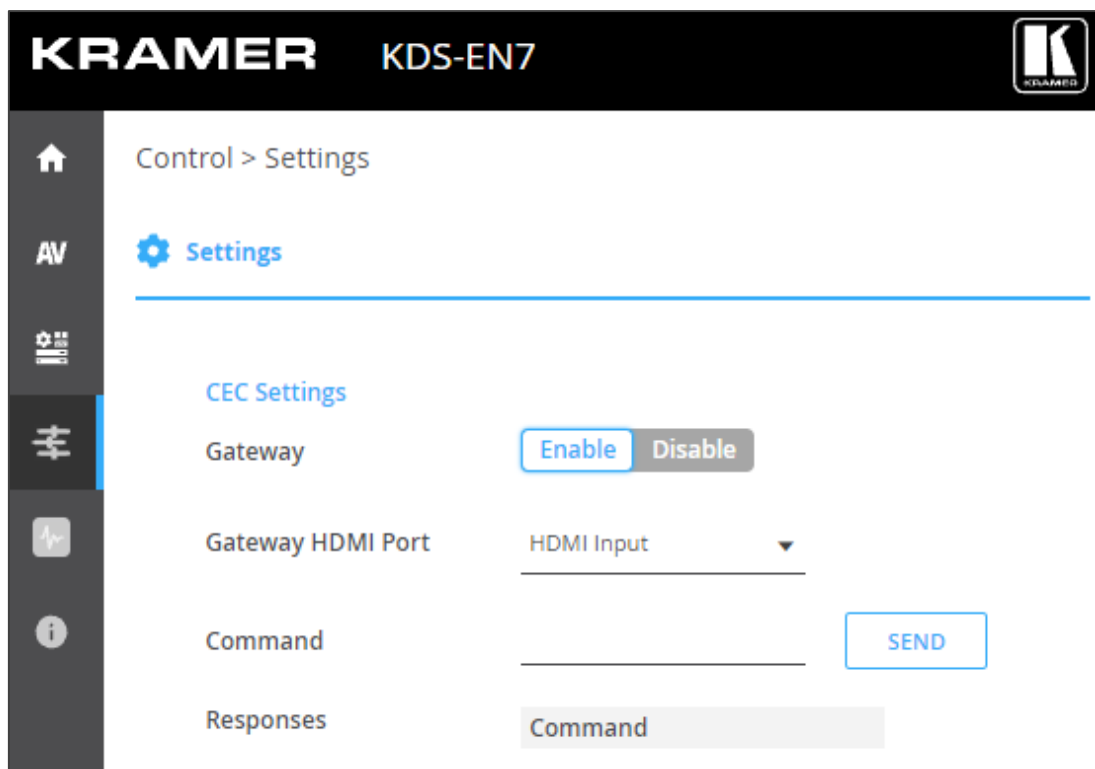

Figure 51: Control > Settings Page – CEC Settings

2. Perform the following actions for **KDS-DEC7** (as described for **KDS-EN7**):
  - [Configuring CEC Settings](#) on page 39.
  - [Configuring RS-232 Settings](#) on page 40.
  - [Configuring IR Settings](#) on page 41.

Gateway settings are configured.

## Viewing KDS-DEC7 Status

View the device status.

To view device status:

1. In the Navigation pane, click **Diagnostics**. The Status tab appears.

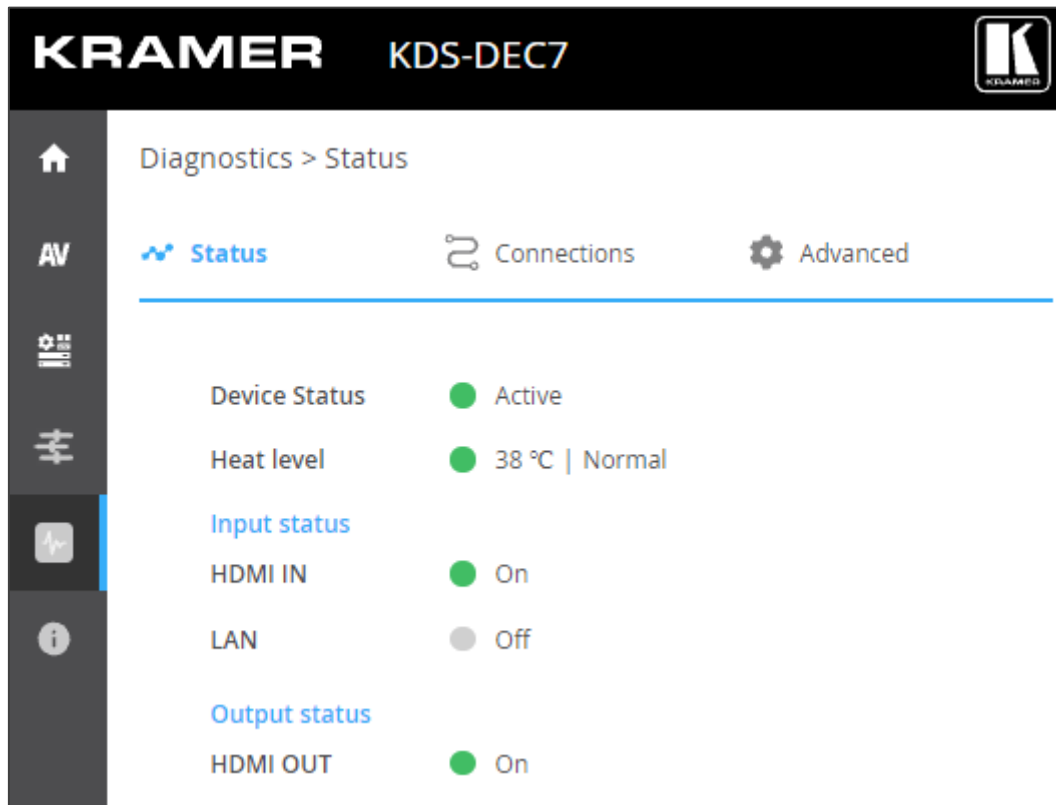

Figure 52: Diagnostics Page – Status Tab

## Viewing KDS-DEC7 Connections Status

View the connection information status.

To view Connections status:

1. In the Navigation pane, click **Diagnostics**. The Status tab appears (see [Figure 52](#)).
2. Select the Connections tab.

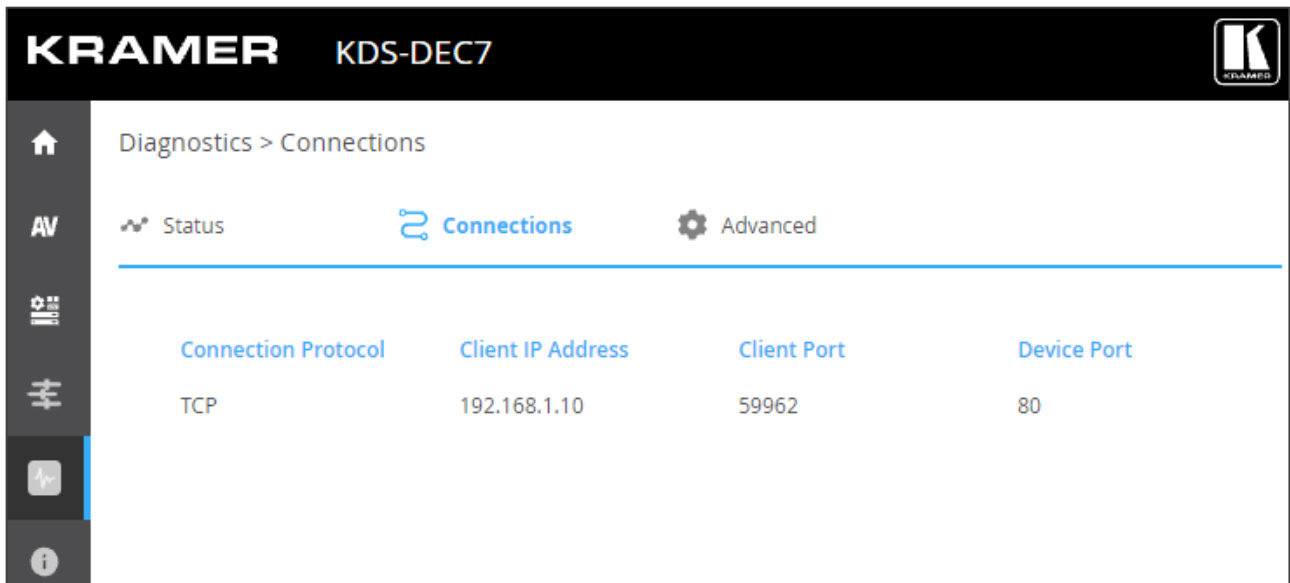

Figure 53: Diagnostics Page – Connections Tab

3. View the Connections status, including protocol type, client IP address and port, and the device port.

Connections' status is viewed.

## Viewing KDS-DEC7 Advanced Status

View the system log and gateway messages counter.

To view log and message counter:

1. In the Navigation pane, click **Diagnostics**. The Status tab appears (see [Figure 52](#)).
2. Select the Advanced tab.

The screenshot shows the Kramer KDS-EN7 web interface. The top header displays 'KRAMER KDS-EN7' and the Kramer logo. The navigation sidebar on the left includes icons for Home, AV, Settings, Diagnostics, and Information. The main content area is titled 'Diagnostics > Advanced' and features three tabs: 'Status', 'Connections', and 'Advanced' (which is selected). Below the tabs, there is a section for 'Active Syslog' with a toggle switch set to 'On'. Underneath, there is a 'Log' section with 'VIEW' and 'EXPORT' buttons. The 'Gateway Messages Counter' section contains a table with the following data:

	Send	Receive
RS-232	0	0
CEC	0	0
IR	0	0

Figure 54: Diagnostics Page – Advanced Tab

3. Define Syslog activity:
  - **On**, to enable device system log locally.
  - **Off** (default), to disable device system log locally.
4. Click **VIEW** to view the system log, if required.
5. Click **EXPORT** to export the system log (.txt) to the local PC.
6. View the sent and received gateway messages.

System log and counters are viewed.

# Viewing the KDS-DEC7 About Page

View the web page hardware release, firmware version and Kramer Electronics Ltd details in the About page.

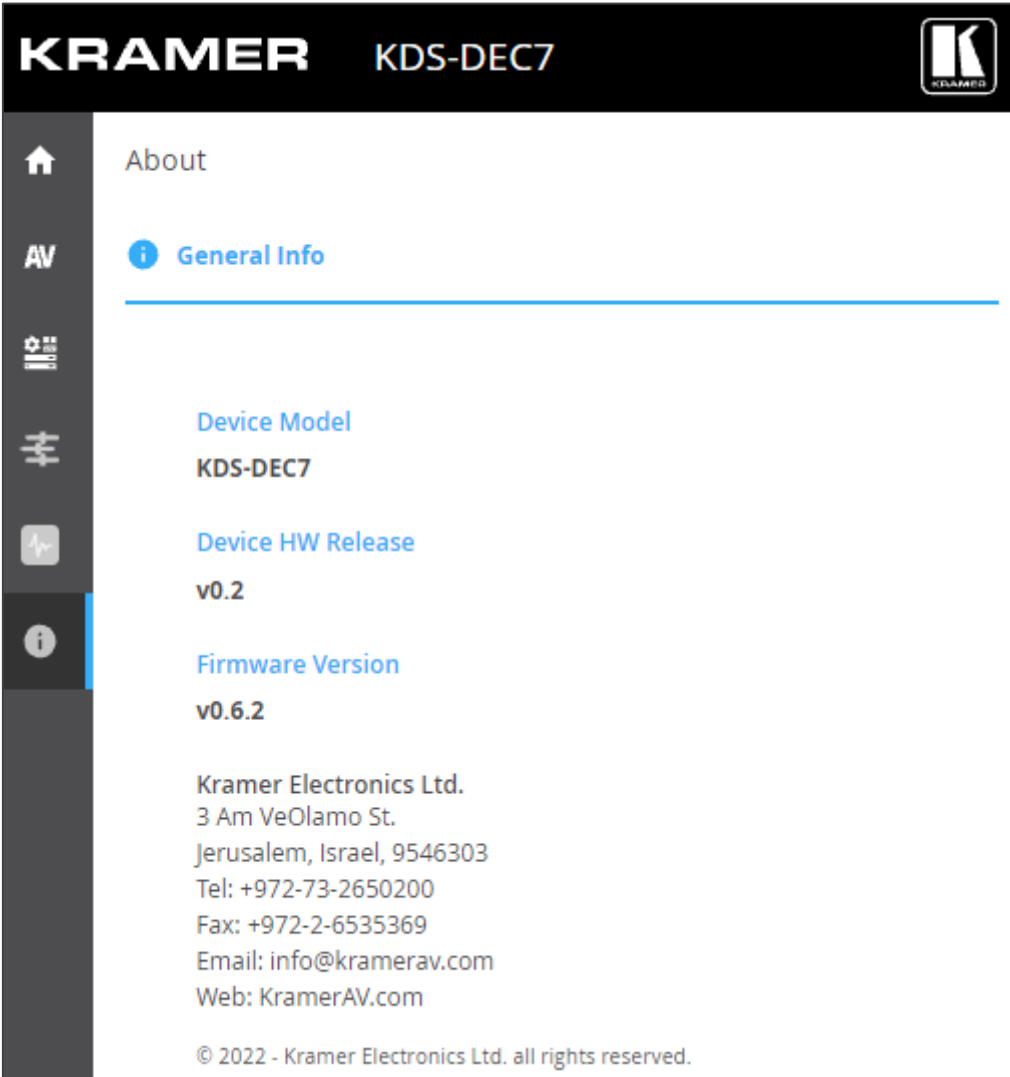

Figure 55: About Page

# KVM Roaming, OSD menu and Fast Switching

This section describes KVM roaming, using the OSD Menu and Fast switching configurations.

To set the devices properly:

1. Make sure the system devices (**KDS-EN7** and **KDS-DEC7**) and PC are all connected to the same Network.
2. Power all the devices in the system.
3. Configure the Network switch as follows:
  - Jumbo Frames – On. (at least 8000 bytes).
  - IGMP Snooping – On.
  - IGMP Querier – On.
  - IGMP Immediate/Fast Leave – On.
  - Unregistered Multicast Filtering – On.
4. Make sure that the PC sub Network is the same as the system devices.

Devices are set.

Perform the following actions:

- [Configuring KVM Roaming](#) on page [70](#).
- [KVM and OSD Menu Switching](#) on page [73](#).
- [Fast switching configuration](#) on page [74](#).



# Configuring KVM Roaming

The KVM Roaming mode enables interacting with multiple hosts via USB from one master KDS-DEC7 decoder connected to a keyboard and mouse, see, for example, the following layout.

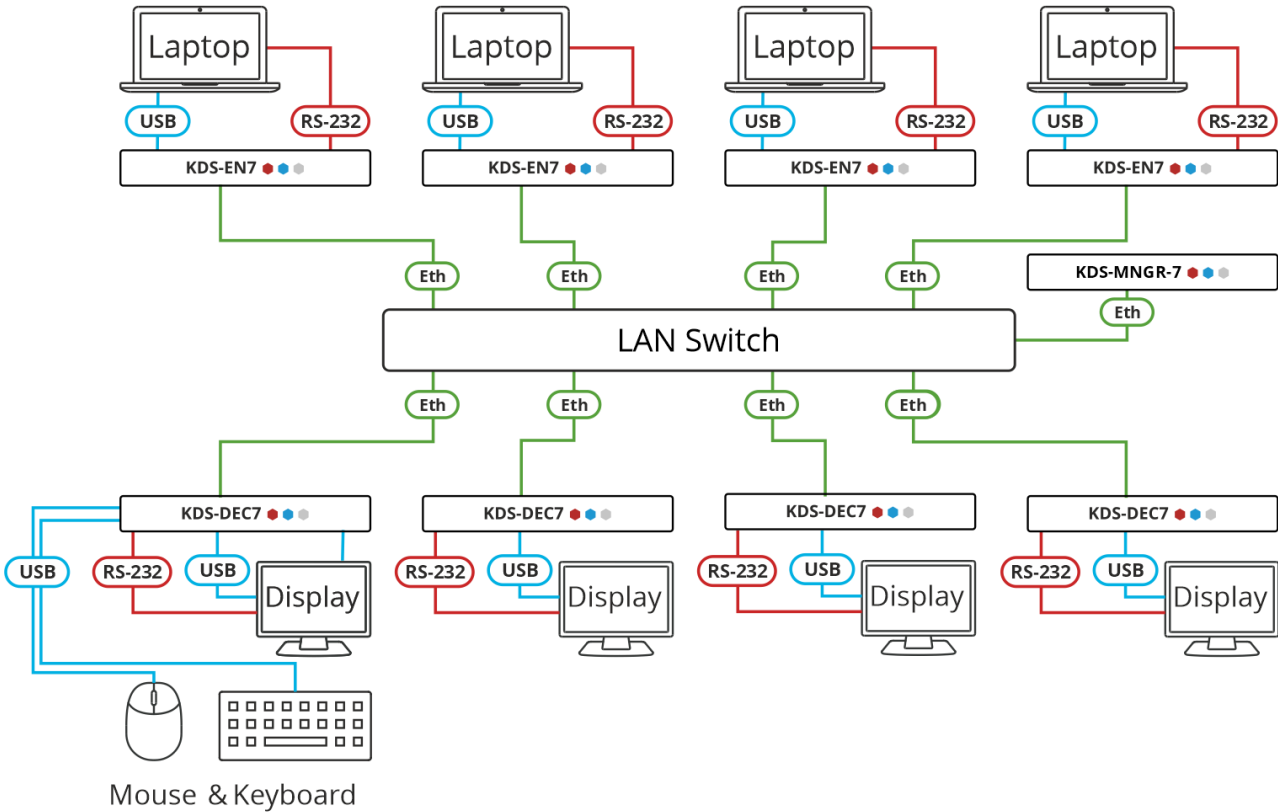

Figure 56: KVM Roaming Layout

### To configure KVM roaming:

- 1. Access the encoder and decoder web pages.
- 2. For each encoder, in the AV Routing page, set a unique Channel ID and name.

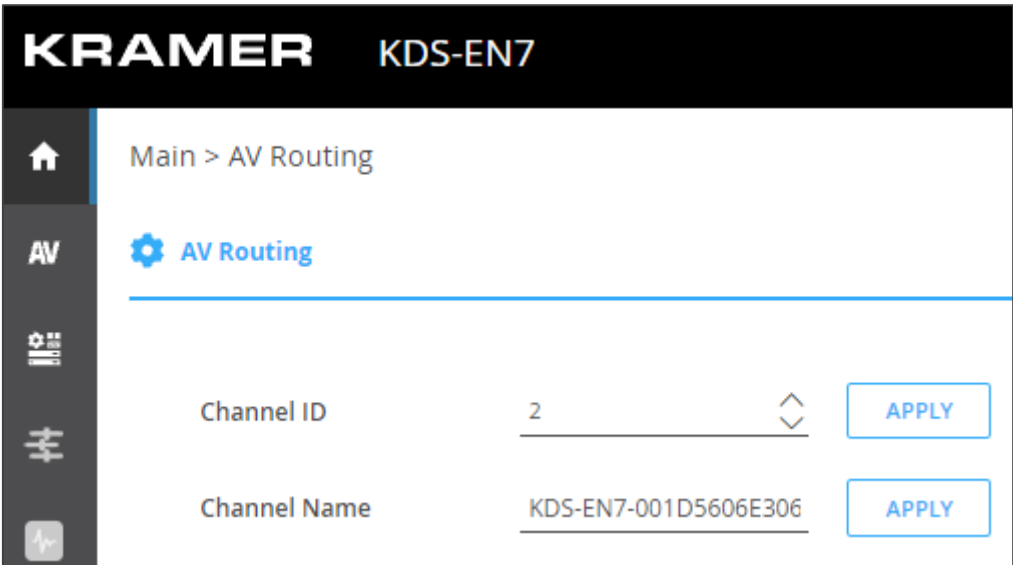

Figure 57: KDS-EN7 Setting Channel ID and Name

- For each decoder, in the AV Routing page, pair an encoder to a decoder. For example, pair ENC 1 to DEC 1, ENC 2 to DEC 2, ENC 3 to DEC 3 and ENC 4 to DEC 4.

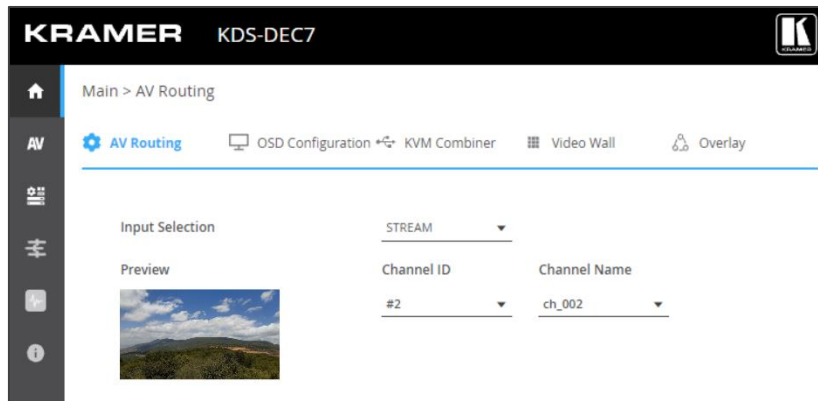

Figure 58: KDS-DEC7 Setting Channel ID and Name

- For the Decoder that has the keyboard and mouse connected, open the Main>KVM Combiner page.

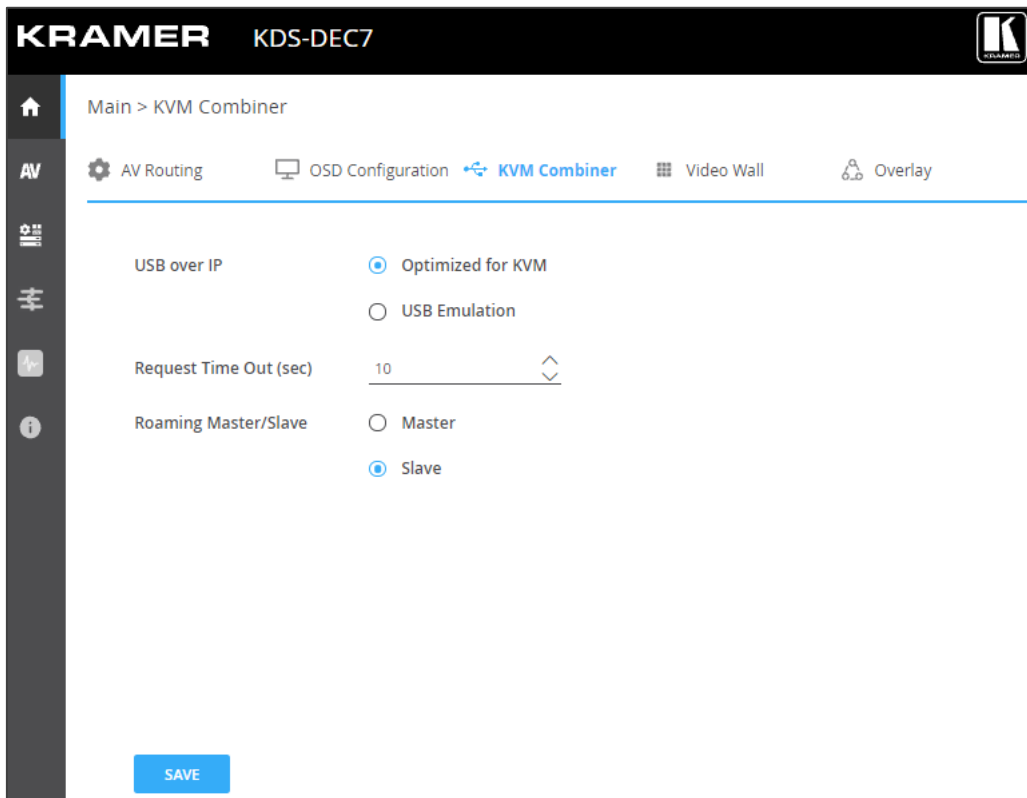

Figure 59: Defining the Master Decoder for KVM Roaming

- Set the Decoder as master. The decoder configuration setup appears.

- 6. Set the row and column numbers as they are set physically.  
For example, if the decoder setup is a 2x2 video wall, set Row to 2 and Column to 2.

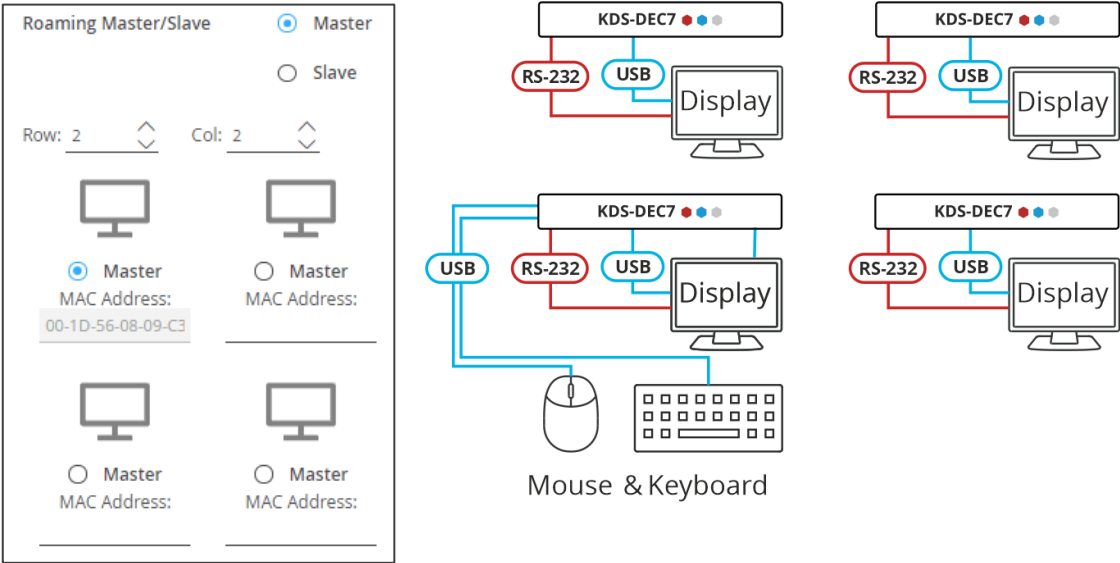

Figure 60: Setting the decoder configuration

- 7. Check the physical location of the Master decoder (lower left size in this example).  
The MAC address is automatically entered.

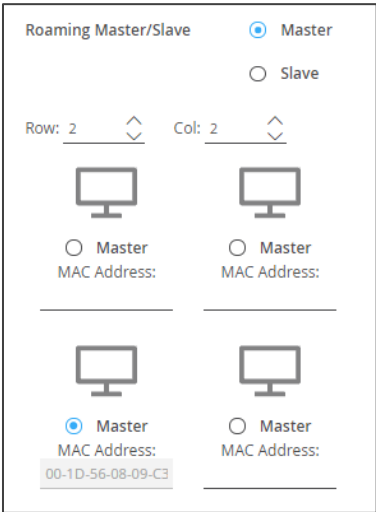

Figure 61: Setting Master MAC Address

- 8. Manually enter the other (slave) decoder MAC addresses according to the physical setup.
  - 9. Click Slave.
- KVM Roaming is configured.

## KVM and OSD Menu Switching

Use the keyboard keys to access an OSD menu on a defined the display.

### To access and use the OSD menu:

1. Access the target decoder (connected to the display on which the OSD should be displayed) web pages.
2. In the Main>OSD Configuration page, add the encoder channel name to the channel list.

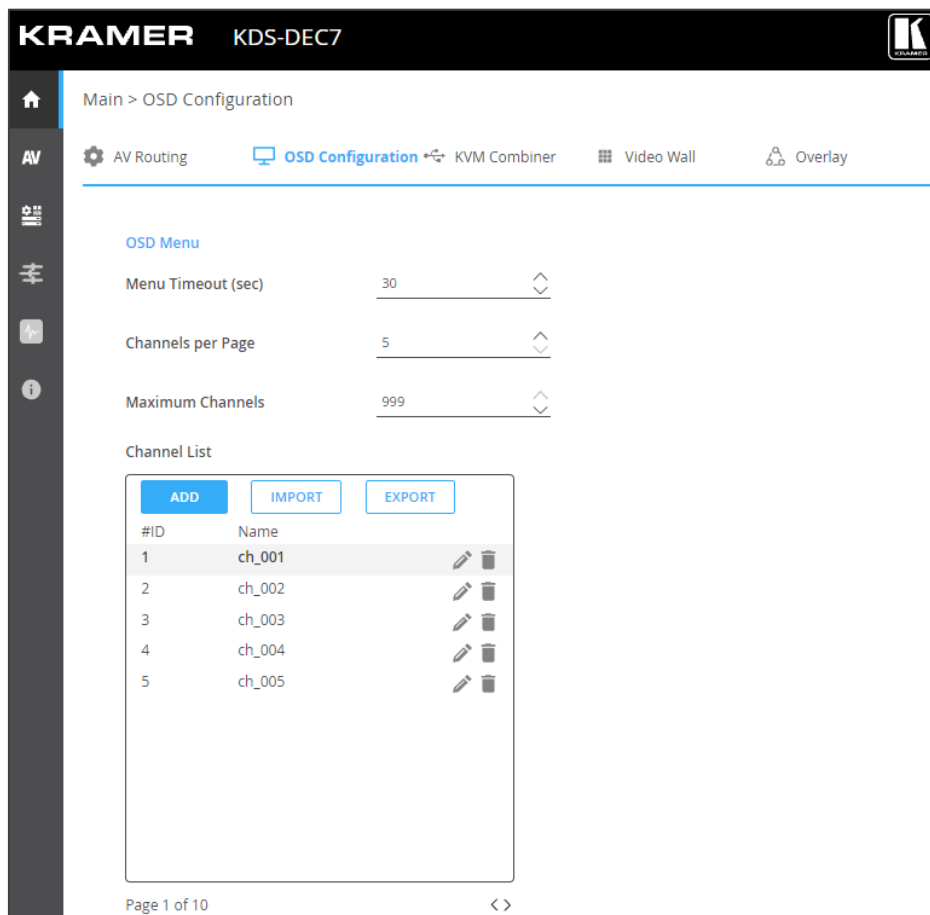

Figure 62: KDS-DEC7 Adding the encoder Channel ID and Name

3. Connect a USB keyboard to the USB-A Target decoder.
4. On the connected keyboard, double click the **Caps Lock**.  
The OSD Channel Select page OSD appears, listing 10 channel IDs per page.
5. To operate the OSD, use the Keyboard as follows:
  - Press **Caps Lock** twice to open the OSD.
  - Press **Up/Down** (or **PgUp/PgDn**) to move up/down to the next item.
  - Type a menu feature next to Filter (in the OSD) to access a function quickly.
  - Press **Enter** to accept a selection and exit the OSD menu.
  - Press **Esc** to exit the menu.

OSD menu is accessed.

## Fast switching configuration

This section describes how to configure fast switching.

### To fast switching:

1. Access the encoder and decoder web pages.
2. For each encoder, in the AV Routing page, set a unique Channel ID and name.

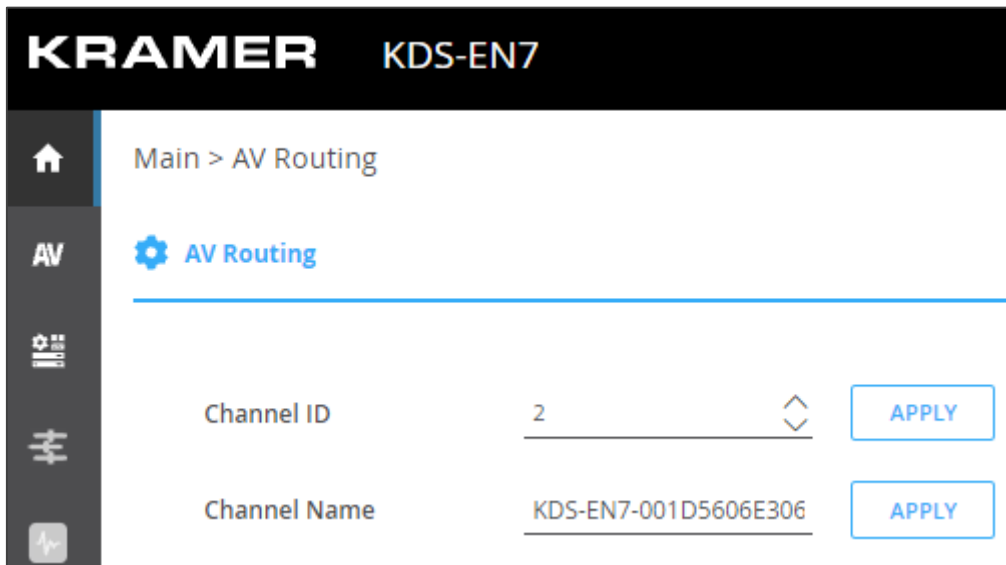



Figure 63: Setting Channel ID and Name on the KDS-EN7 Devices

3. Make sure that all the encoders in the system share the same settings. For example, to configure fast switching between encoder 1 and encoder 2 the following settings need to be identical on the input source:
  - HDCP setting.
  - Resolution and Refresh rate.
4. On the decoders, set the Maximum Resolution in the AV Settings>Video page to be identical.

Fast switching is configured.

# Upgrading Firmware

Upgrade the firmware, view the date of the last upgrade, or rollback to the previous firmware revision in case of a problem.

 Click **ROLLBACK** to update to the previous FW version.

 If the device firmware version is lower than 0.6.3, contact Kramer tech support team at [support@kramerav.com](mailto:support@kramerav.com) or go to our Web site at [k.kramerav.com/support/downloads.asp](http://k.kramerav.com/support/downloads.asp).

**To upgrade the firmware:**

- 1. In the Navigation pane, Select **Device Settings**. The General tab in the Device Settings page appears.

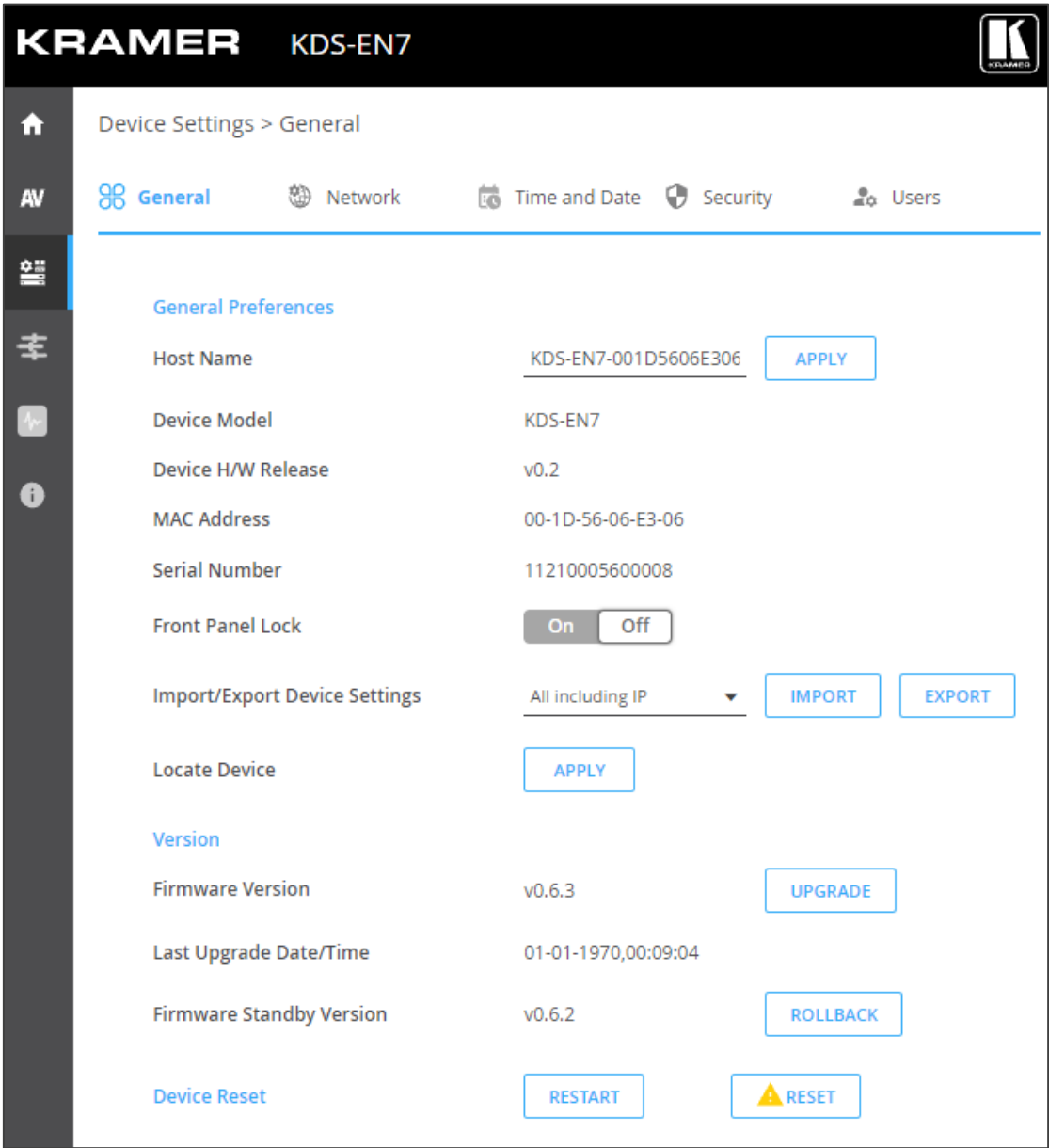

Figure 64: General Tab – Upgrading the Firmware

2. Next to Firmware Version, click **UPGRADE**. The Open window appears.
3. Select the FW file and click **Open**. The FW upgrade pop-up window appears. Wait for upgrade completion.
4. Once completed, refresh the web page and log-in.

Firmware upgrade is complete.

# Technical Specifications

## KDS-EN7 Specifications

Inputs	1 HDMI	On a female HDMI connector
Outputs	1 HDMI	On a female HDMI connector
Ports	2 Ethernet	On RJ-45 female connectors
	1 Balanced Audio	On a 5-pin terminal block connector
	1 RS-232	On a 3-pin terminal block connector
	1 IR	On a 3.5mm TRS connector
	1 USB Host	On a USB-B connector
Video	Compression Standard	JPEG based, private stream
	Max Resolution	4K@60Hz (4:2:0)
User Interface	Indicators	LINK, NET and ON LEDs, front panel LCD Display
	Rear Panel	Restart and factory reset button
	Controls	Embedded web pages, P3K API commands via Ethernet, front panel navigation buttons
Power	Consumption	12V DC, 280mA
	Source	24V DC, 5A (optional, purchased separately)
Environmental Conditions	Operating Temperature	0° to +45°C (32° to 113°F)
	Storage Temperature	-20° to +70°C (-4° to 158°F)
	Humidity	10% to 90%, RHL non-condensing
Regulatory Compliance	Safety	CE, FCC
	Environmental	RoHs, WEEE
Enclosure	Size	Mega Tool Deep
	Type	Aluminum
	Cooling	Convection Ventilation
General	Net Dimensions (W, D, H)	19cm x 14.5cm x 2.8cm (7.5" x 5.7" x 1.1")
	Shipping Dimensions (W, D, H)	31cm x 18cm x 7.6cm (12.2" x 7.09" x 2.99")
	Net Weight	0.7kg (1.54lbs) approx.
	Shipping Weight	0.9kg (2lbs) approx.
Specifications are subject to change without notice at <a href="http://www.kramerav.com">www.kramerav.com</a>		



## KDS-DEC7 Specifications

Inputs	1 HDMI	On a female HDMI connector
Outputs	1 HDMI	On a female HDMI connector
Ports	2 Ethernet	On RJ-45 female connectors
	1 Balanced Audio	On a 5-pin terminal block connector
	1 RS-232	On a 3-pin terminal block connector
	1 IR	On a 3.5mm TRS connector
	2 USB	On USB-A connectors
Video	Compression Standard	JPEG based, private stream
	Max Resolution	4K@60Hz (4:2:0)
User Interface	Indicators	LINK, NET and ON LEDs, front panel LCD Display
	Rear Panel	Restart and factory reset button
	Controls	Embedded web pages, P3K API commands via Ethernet, front panel navigation buttons
Power	Consumption	PoE on LAN(PoE) port 24V DC, 530mA when using optional power source
	Source	24V DC, 5A (optional, purchased separately)
Environmental Conditions	Operating Temperature	0° to +45°C (32° to 113°F)
	Storage Temperature	-20° to +70°C (-4° to 158°F)
	Humidity	10% to 90%, RHL non-condensing
Regulatory Compliance	Safety	CE, FCC
	Environmental	RoHs, WEEE
Enclosure	Size	Mega Tool Deep
	Type	Aluminum
	Cooling	Convection Ventilation
General	Net Dimensions (W, D, H)	19cm x 14.5cm x 2.8cm (7.5" x 5.7" x 1.1")
	Shipping Dimensions (W, D, H)	31cm x 18cm x 7.6cm (12.2" x 7.09" x 2.99")
	Net Weight	0.7kg (1.54lbs) approx.
	Shipping Weight	0.9kg (2lbs) approx.
Specifications are subject to change without notice at <a href="http://www.kramerav.com">www.kramerav.com</a>		

## Default Communication Parameters

P3K		
Example (stop encoder decoder activity)		#KDS-ACTION 0<CR>
Ethernet		
To reset the IP settings to the factory reset values go to: Menu->Setup -> Factory Reset-> press Enter to confirm		
	KDS-EN7	KDS-DEC7
DHCP	Default	Default
IP Address:	192.168.1.39	192.168.1.40
Subnet mask:	255.255.255.0	255.255.255.0
Default gateway:	192.168.1.254	192.168.1.254
TCP Port #:	5000	5000
UDP Port #:	50000	50000
Default username:	admin	admin
Default password:	admin	admin
Full Factory Reset		
Embedded web pages	Device Settings > General > RESET	
Front panel buttons	Press the RESET button on the rear panel for 10 seconds	

## Default EDID

### Monitor

Model name..... KDS7 Encoder  
 Manufacturer..... KMR  
 Plug and Play ID..... KMR0000  
 Serial number..... 1  
 Manufacture date..... 2021, ISO week 37  
 Filter driver..... None

EDID revision..... 1.3  
 Input signal type..... Digital  
 Color bit depth..... Undefined  
 Display type..... RGB color  
 Screen size..... 890 x 500 mm (40.2 in)  
 Power management..... Not supported  
 Extension blocs..... 1 (CEA/CTA-EXT)  
 DDC/CI..... n/a

### Color characteristics

Default color space..... Non-sRGB  
 Display gamma..... 2.20  
 Red chromaticity..... Rx 0.640 - Ry 0.330  
 Green chromaticity..... Gx 0.300 - Gy 0.600  
 Blue chromaticity..... Bx 0.150 - By 0.060  
 White point (default).... Wx 0.313 - Wy 0.329  
 Additional descriptors... None

### Timing characteristics

Range limits..... Not available  
 GTF standard..... Not supported  
 Additional descriptors... Established timings  
 Preferred timing..... Yes  
 Native/preferred timing.. 1920x1080p at 50Hz (16:9)  
 Modeline..... "1920x1080" 148.500 1920 2448 2492 2640 1084 1089 1125 +hsync +vsync  
 Detailed timing #1..... 1920x1200p at 50Hz (16:9)  
 Modeline..... "1920x1200" 127.750 1920 1968 2000 2080 1200 1203 1209 1229 +hsync -vsync

### Standard timings supported

640 x 480p at 60Hz - IBM VGA  
 800 x 600p at 60Hz - VESA  
 1024 x 768p at 60Hz - VESA  
 1280 x 800p at 60Hz - VESA STD  
 1600 x 900p at 60Hz - VESA STD  
 1280 x 768p at 60Hz - VESA  
 1280 x 960p at 60Hz - VESA  
 1280 x 1024p at 60Hz - VESA

1360 x 768p at 60Hz - VESA  
 1440 x 900p at 60Hz - VESA  
 1400 x 1050p at 60Hz - VESA  
 1650 x 1050p at 60Hz - VESA  
 1600 x 1200p at 60Hz - VESA  
 1920 x 1200p at 60Hz - VESA (RB)

## EIA/CEA/CTA-861 Information

Revision number..... 3  
 IT underscan..... Supported  
 Basic audio..... Supported  
 YCbCr 4:4:4..... Supported  
 YCbCr 4:2:2..... Supported  
 Native formats..... 3  
 Detailed timing #1..... 1366x1536i at 60Hz (16:9)  
 Modeline..... "1366x1536" 85.500 1366 1436 1579 1792 1536 1542 1548 1596 interlace +hsync +vsync

## CE video identifiers (VICs) - timing/formats supported

1920 x 1080p at 50Hz - HDTV (16:9, 1:1) [Native]  
 1920 x 1080p at 60Hz - HDTV (16:9, 1:1)  
 1920 x 1080p at 25Hz - HDTV (16:9, 1:1)  
 1920 x 1080p at 24Hz - HDTV (16:9, 1:1)  
 1920 x 1080i at 50Hz - HDTV (16:9, 1:1)  
 1920 x 1080i at 60Hz - HDTV (16:9, 1:1)  
 1920 x 1080i at 60Hz - HDTV (16:9, 1:1)  
 1920 x 1080i at 60Hz - HDTV (16:9, 1:1)  
 1920 x 1080i at 60Hz - HDTV (16:9, 1:1)  
 1920 x 1080i at 60Hz - HDTV (16:9, 1:1)  
 1920 x 1080i at 60Hz - HDTV (16:9, 1:1)  
 1920 x 1080i at 60Hz - HDTV (16:9, 1:1)  
 1920 x 1080i at 60Hz - HDTV (16:9, 1:1)  
 1280 x 720p at 60Hz - HDTV (16:9, 1:1)  
 720 x 480p at 60Hz - EDTV (4:3, 8:9)  
 720 x 576p at 50Hz - EDTV (4:3, 16:15)  
 NB: NTSC refresh rate = (Hz\*1000)/1001

## CE audio data (formats supported)

LPCM 2-channel, 16-bit at 32/44/48 kHz

## CE speaker allocation data

Channel configuration.... 2.0  
 Front left/right..... Yes  
 Front LFE..... No  
 Front center..... No  
 Rear left/right..... No  
 Rear center..... No  
 Front left/right center.. No  
 Rear left/right center... No  
 Rear LFE..... No

## CE vendor specific data (VSDB)

IEEE registration number. 0x000C03  
 CEC physical address..... 1.0.0.0  
 Supports AI (ACP, ISRC).. No  
 Supports 48bpp..... No  
 Supports 36bpp..... Yes  
 Supports 30bpp..... Yes  
 Supports YCbCr 4:4:4..... Yes  
 Supports dual-link DVI... No  
 Maximum TMDS clock..... 300MHz  
 Audio/video latency (p).. n/a  
 Audio/video latency (i).. n/a  
 HDMI video capabilities.. Yes  
 EDID screen size..... No additional info  
 3D formats supported..... Not supported  
 Data payload..... 030C001000383C20008001020304

## CE vendor specific data (VSDB)

IEEE registration number. 0xC45DD8  
 CEC physical address..... 0.1.3.12  
 Supports AI (ACP, ISRC).. Yes  
 Supports 48bpp..... No  
 Supports 36bpp..... No  
 Supports 30bpp..... No  
 Supports YCbCr 4:4:4..... No  
 Supports dual-link DVI... No  
 Maximum TMDS clock..... 0MHz

## YCbCr 4:2:0 video data

Data payload..... 0E60616566

## CE video capability data

CE scan behavior..... Always overscanned



Page Name	Tab Name	Fields	Editable Field	Exportable Field	Default Values	
		TCP Port	Yes	Yes	5,000	
		UDP Port	Yes	Yes	50,000	
	Time and Date	Date	Yes	Yes	01-01-1970	
		Time	Yes	Yes	N/A	
		Time Zone	Yes	Yes	00:00 Greenwich	
		NTP Time Server Usage	Yes	Yes	No	
		NTP Time Server Address	Yes	Yes	N/A	
		NTP Daily Sync Hour	Yes	Yes	N/A	
		Security	HTTPS Server	Yes	Yes	On; Internal Certificate
	IEE 802.1x Authentication		Yes	Yes	Off	
	Users	Security Status	Yes	Yes	Off	
		Inactivity auto-logout time	Yes	Yes	10	
	Control	Settings	CEC Gateway	Yes	Yes	Enable
			CEC Gateway HDMI Port	Yes	Yes	HDMI Input
RS232 Gateway			Yes	Yes	Enable	
RS232 Port			Yes	Yes	5001	
RS232 Baud rate			Yes	Yes	115200	
RS232 Data Bits			Yes	Yes	8	
Parity			Yes	Yes	None	
Stop Bits			Yes	Yes	1	
IR Gateway			Yes	Yes	Enable	
IR Direction IN/OUT			Yes	Yes	Out	
Diagnosics			Advanced	Active Syslog	Yes	Yes

## KDS-DEC7 Default Parameters

Page Name	Tab Name	Fields	Editable Field	Exportable Field	Default Values
Main AV Settings	AV Routing	Input Selection	Yes	Yes	STREAM
		Preview	Yes	Yes	Channel ID: #1 Channel Name: ch_001
		Volume	Yes	Yes	80
		Mute	Yes	Yes	Off
		Play/Stop	Yes	Yes	Play
	OSD Configuration	Menu Timeout (sec)	Yes	Yes	30
		Channels per Page	Yes	Yes	5
		Maximum Channels	Yes	Yes	999
		Channel List	Yes	Yes	50 items display in the Channel list.
		Menu Font Size	Yes	Yes	Medium
		Menu Position	Yes	Yes	Top Left
		Display Device Information	Yes	Yes	Off
		Device Information Timeout (min)	Yes	Yes	2
		KVM Combiner	USB Over IP	Yes	Yes
	Request Time Out (sec)		Yes	Yes	10
	Roaming Master/Slave		Yes	Yes	Slave
	Video Wall	Horizontal	Yes	Yes	1
		Vertical	Yes	Yes	1
		Stretch Type	Yes	Yes	Fit In
		Video Rotation	Yes	Yes	0
	Overlay	Image settings Align	Yes	Yes	Top Center
		Image settings Transparency (%)	Yes	Yes	50
		Show	Yes	Yes	unchecked
		Text Settings Text	Yes	Yes	Hello KRAMER
		Text Settings Size	Yes	Yes	Small
		Text Settings Align	Yes	Yes	Top Center
		Text Settings Color	Yes	Yes	#ffff

Page Name	Tab Name	Fields	Editable Field	Exportable Field	Default Values
		Text Settings Transparency (%)	Yes	Yes	50
		Show	Yes	Yes	Unchecked
AV Settings	Video	Maximum Resolution	Yes	Yes	Pass Through
		Sleep (5V-off) Delay On Video Signal Loss (sec)	Yes	Yes	0
		Shutdown (CEC) Delay On Video Signal Loss (sec)	Yes	Yes	0
		Wake-up (CEC) Delay on Video Signal Detection (sec)	Yes	Yes	0
		Force RGB	Yes	Yes	Checked
Device Settings	General	Host Name	Yes	Yes	KDS-DEC7-xxxxxxxxxx ("xxxxxxxxxx" is the device's MAC address)
		Import/Export Device Settings	Yes	Yes	All including IP
		Front Panel Lock	Yes	Yes	Off
	Network	Stream Port	No	Yes	Media
		Stream 802.1Q	No	Yes	N/A
		Stream VLAN Tag	No	Yes	N/A
		Stream DHCP	Yes	Yes	On
		P3K & Gateway Port	Yes	Yes	Media
		P3K & Gateway 802.1Q	Yes	Yes	Off
		P3K & Gateway VLAN Tag	Yes	Yes	N/A
		P3K & Gateway DHCP	Yes	Yes	N/A
		Daisy Chain	Yes	Yes	Off
		IP Casting Mode	Yes	Yes	Multicast
		TTL	Yes	Yes	64
		TCP Port	Yes	Yes	5,000
		UDP Port	Yes	Yes	50,000
	Time and Date	Date	Yes	Yes	01-01-1970
		Time	Yes	Yes	N/A
		Time Zone	Yes	Yes	00:00 Greenwich
		NTP Time Server Usage	Yes	Yes	No
		NTP Time Server Address	Yes	Yes	N/A
		NTP Daily Sync Hour	Yes	Yes	N/A
	Security	HTTPS Server	Yes	Yes	On; Internal Certificate
		IEE 802.1x Authentication	Yes	Yes	Off
	Users	Security Status	Yes	Yes	Off
		Inactivity auto-logout time	Yes	Yes	10
Control	Settings	CEC Gateway	Yes	Yes	Enable
		CEC Gateway HDMI Port	Yes	Yes	HDMI Input
		RS232 Gateway	Yes	Yes	Enable
		RS232 Port	Yes	Yes	5001
		RS232 Baud rate	Yes	Yes	115200
		RS232 Data Bits	Yes	Yes	8
		Parity	Yes	Yes	None
		Stop Bits	Yes	Yes	1
		IR Gateway	Yes	Yes	Enable
		IR Direction IN/OUT	Yes	Yes	Out
Diagnostics	Advanced	Active Syslog	Yes	Yes	Off

# Protocol 3000

Kramer devices can be operated using Kramer Protocol 3000 commands sent via Ethernet ports.

## Understanding Protocol 3000

Protocol 3000 commands are a sequence of ASCII letters, structured according to the following.

- **Command format:**

Prefix	Command Name	Constant (Space)	Parameter(s)	Suffix
#	Command	␣	Parameter	<CR>

- **Feedback format:**

Prefix	Device ID	Constant	Command Name	Parameter(s)	Suffix
~	nn	@	Command	Parameter	<CR><LF>

- **Command parameters** – Multiple parameters must be separated by a comma (,). In addition, multiple parameters can be grouped as a single parameter using brackets ([ and ]).
- **Command chain separator character** – Multiple commands can be chained in the same string. Each command is delimited by a pipe character (|).
- **Parameters attributes** – Parameters may contain multiple attributes. Attributes are indicated with pointy brackets (<...>) and must be separated by a period (.).

The command framing varies according to how you interface with the **KDS-EN7**. The following figure displays how the # command is framed using terminal communication software (such as Hercules):

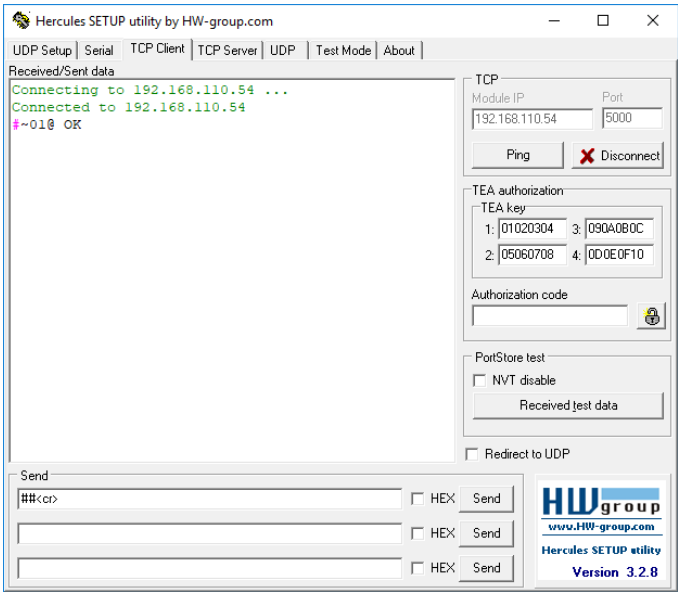

# Protocol 3000 Commands

Function	Description	Syntax	Response	Parameters/Attributes	Example
#	Protocol handshaking. <b>NOTE:</b> Validates the Protocol 3000 connection and gets the machine number. Step-in master products use this command to identify the availability of a device.	#<CR>	~nn@_ok<CR><LF>		#<CR>
BEACON-EN	Set beacon rate.	#BEACON-EN port_id,status,rate<CR>	~nn@BEACON-EN port_id,status,rate<CR><LF>	port_id – ID of the Ethernet port status – Enable/Disable beacon 0 – Disable (default) 1 – Enable rate – Repetition rate in seconds 1 – 1 second (minimum) 10 – 10 seconds (default) 1800 – 30 minutes (maximum)	Set beacon information: #BEACON-EN 5000,0,1<CR>
BEACON-INFO?	Get beacon information, including IP address, UDP control port, TCP control port, MAC address, model, name. <b>NOTE:</b> There is no Set command. Get command initiates a notification.	#BEACON-INFO?_port_id<CR>	~nn@BEACON-INFO port_id,ip_string,udp_port,tcp_port,mac_address,model,name<CR><LF>	port_id – ID of the Ethernet port ip_string – Dot-separated representation of the IP address udp_port – UDP control port tcp_port – TCP control port mac_address – Dash-separated mac address model – Device model name – Device name	Get beacon information: #BEACON-INFO?<CR>
BUILD-DATE?	Get device build date.	#BUILD-DATE?<CR>	~nn@BUILD-DATE date,time<CR><LF>	date – Format: YYYY/MM/DD where YYYY = Year MM = Month DD = Day time – Format: hh:mm:ss where hh = hours mm = minutes ss = seconds	Get the device build date: #BUILD-DATE?<CR>
CEC-GW-PORT-ACTIVE	Set CEC Gateway mode - Whether CEC commands coming from HDMI stream (passthrough) or from LAN.	#CEC-GW-PORT-ACTIVE gateway<CR>	~nn@CEC-GW-PORT-ACTIVE gateway<CR><LF>	CEC mode 0 – CEC Passthrough mode 1 – CEC Gateway mode – command to be sent to HDMI Input. 2 – CEC Gateway mode – command to be sent to HDMI Output. 3 – CEC Gateway mode – command to be sent to HDMI Loop Through	Set CEC Gateway mode: #CEC-GW-PORT-ACTIVE 1<CR>
CEC-NTFY	Notify about CEC command retrieved from bus. <b>NOTE:</b> Notification is sent to all com ports upon CEC message retrieval from CEC bus.	#CEC-NTFY<CR>	~nn@CEC-NTFY port_index,len,<cec_command ...><CR><LF>	port_index – CEC port notifying the command len – 1–16 cec_command – CEC format command (in HEX format, no leading zeros, no '0x' prefix)	Notify about CEC command retrieved from bus.: #CEC-NTFY<CR>
CEC-SND	Send CEC command to port.	#CEC-SND port_index,sn_id,cmd_name,cec_len,cec_command<CR>	~nn@CEC-SND port_index,sn_id,cmd_name,cec_mode<CR><LF>	port_index – CEC port transmitting the command (1 – number of ports) sn_id – serial number of command for flow control and response commands from device cmd_name – command name cec_len – 1–16 cec_command – CEC format command (in HEX format, no leading zeros, no '0x' prefix) cec_mode – CEC mode 0 – Sent 1 – Gateway disabled 2 – Inactive CEC-Master 3 – Busy 4 – Illegal Message Parameter 5 – Illegal CEC Address Parameter 6 – Illegal CEC Command 7 – Timeout 8 – Error	Send CEC command to port: #CEC-SND 1,1,1,2,E004<CR>
COM-ROUTE-ADD	Add a communication route tunnel connection.	#COM-ROUTE-ADD com_id,port_type,port_id,eth_rep_en,timeout<CR>	~nn@COM-ROUTE-ADD com_id,port_type,port_id,eth_rep_en,timeout<CR><LF>	com_id – Machine dependent port_type – TCP/UDP 0 – TCP 1 – UDP port_id – TCP/UDP port number (5000 – 5999) eth_rep_en – Ethernet Reply 0 – COM port does not send replies to new clients 1 – COM port sends replies to new clients. timeout – Keep alive timeout in seconds (1 to 3600)	Add a communication route tunnel connection: #COM-ROUTE-ADD 1,1,1,1,1<CR>
COM-ROUTE-REMOVE	Remove a communication route tunnel connection.	#COM-ROUTE-REMOVE com_id<CR>	~nn@COM-ROUTE-REMOVE com_id<CR><LF>	com_id – Machine dependent	Remove a communication route tunnel connection: #COM-ROUTE-REMOVE 1<CR>



Function	Description	Syntax	Response	Parameters/Attributes	Example
COM-ROUTE?	Get communication route tunnel connection state.	#COM-ROUTE?_com_id<CR>	~nn@COM-ROUTE com_id,port_type,port_id,eth_r ep_en,timeout<CR><LF>	com_id – Machine dependent port_type – TCP/UDP 0 – TCP 1 – UDP port_id – TCP/UDP port number eth_rep_en – Ethernet Reply 0 – COM port does not send replies to new clients 1 – COM port sends replies to new clients. timeout – Keep alive timeout in seconds (1 to 3600)	Get tunneling port routing for all route tunnels: #COM-ROUTE?_.*<CR>
CS-CONVERT	Set the "force RGB color space" convert mode.	#CS-CONVERT out_index,cs_mode<CR>	~nn@CS-CONVERT out_index,cs_mode<CR><LF>	out_index – Number that indicates the specific output: 1-N (N= the total number of outputs) cs_mode – Index in resolution table 0 – Color space pass (default) 1 – Enable "force RGB color space" convert mode	Enable "force RGB color space" convert mode for channel 1: #CS-CONVERT_1,1<CR>
CS-CONVERT?	Get the "force RGB color space" convert mode.	#CS-CONVERT?_out_index<CR>	~nn@CS-CONVERT out_index,cs_mode<CR><LF>	out_index – Number that indicates the specific output: 1-N (N= the total number of outputs) cs_mode – Index in resolution table 0 – Color space pass (default) 1 – Enable "force RGB color space" convert mode	Get the "force RGB color space" convert mode status for channel 1: #CS-CONVERT?_1<CR>
DEV-STATUS?	Get device status.	#DEV-STATUS?<CR>	~nn@DEV-STATUS status<CR><LF>	status - device status for encoder/decoder 0 – power on 1 – standby 2 – FW Background Download 3 – IP fallback address	Get device status #DEV-STATUS?<CR>
EDID-ACTIVE	Activate specific EDID Note: only valid in custom mode. in other modes will return error.	#EDID-ACTIVE Input_id, Index<CR>	~nn@EDID-ACTIVE Input_id, Index<CR><LF> or ~nn@EDID- ACTIVE err<CR><LF>	Input_id – 1 Index - Index in EDID List	Set custom EDID #1 active on input 1; If not in CUSTOM mode, return ERROR #EDID-ACTIVE 1,1<CR>
EDID-ACTIVE?	Get current active EDID. Note: only valid in custom mode. in other modes will return error.	#EDID-ACTIVE? Input_id<CR>	~nn@EDID-ACTIVE Input_id, Index<CR><LF>	Input_id – 1 Index - Index in EDID List	Get active custom EDID index on Input 1; If not in CUSTOM mode, return ERROR #EDID-ACTIVE? 1<CR>
EDID-LIST?	Get a list of currently existing EDID's (Get only)	#EDID-LIST?<CR>	~nn@#EDID-LIST [0,"DEFAULT"],...<CR><LF>	[idx,"xxx"]...	Get EDID list #EDID-LIST?<CR>  Return: ~nn@EDID-LIST [0,"DEFAULT"],[2,"SONY"],[5,"PANASONIC"]<CR><LF>
EDID-MODE	Set EDID work mode.	#EDID-MODE Input_id, Mode, Index<CR>	~nn@#EDID-MODE Input_id, Mode, Index<CR><LF>	Input_id – 1 Mode: (PASSTHRU (get from decoder); CUSTOM; DEFAULT ) Index: [option], CUSTOM should have an 'Index'	Set EDID to custom mode, idx is 1 #EDID-MODE 1,CUSTOM,1<CR>
EDID-MODE?	Get EDID work mode.	#EDID-MODE? Input_id<CR>	~nn@#EDID-MODE Input_id, Mode, Index<CR><LF>	Input_id – 1 Mode: (PASSTHRU (get from decoder); CUSTOM; DEFAULT ) Index: [option],CUSTOM should have an 'Index'	Get EDID Mode #EDID-MODE? 1<CR>
EDID-NET-SRC?	Get MAC on net device of EDID source	#EDID-NET-SRC? input_id<CR>	~nn@EDID-NET-SRC input_id, src_ip<CR><LF>	input_id – 1 src_ip – DEC IP address	Get MAC on Net device for Input 1 #EDID-NET-SRC? 1<CR>
EDID-NET-SRC	Set MAC on net device to be EDID source	#EDID-NET-SRC input_id, src_ip<CR>	~nn@EDID-NET-SRC input_id, src_ip<CR><LF>	input_id – 1 src_mac – DEC IP address	Set MAC on net device for Input 1 #EDID-NET-SRC 1,192.168.1.40<CR>
EDID-RM	Remove custom EDID from EDID list Note: should return ERR if this EDID is in USE.	#EDID-RM Index<CR>	~nn@#EDID-RM Index<CR><LF> or ~nn@EDID-RM_err<CR><LF>	Index: 1...N - EDID index to remove. Index 0 (Default) is not removable	remove EDID from slot 3 and delete the file #EDID-RM 3<CR>
ETH-PORT	Set Ethernet port protocol. <b>NOTE:</b> If the port number you enter is already in use, an error is returned. The port number must be within the following range: 0-(2 <sup>16</sup> -1).	#ETH-PORT_port_type,port_id<CR>	~nn@ETH-PORT port_type,port_id<CR><LF>	port_type – TCP/UDP port_id – when port_type = TCP: 5000-5099 when port_type = UDP: 50000-50999	Set the Ethernet port protocol for TCP to port 12457: #ETH-PORT_TCP,5000<CR>
ETH-PORT?	Get Ethernet port protocol.	#ETH-PORT?_port_type<CR>	~nn@ETH-PORT port_type,port_id<CR><LF>	port_type – TCP/UDP port_id – when port_type = TCP: 5000-5099 when port_type = UDP: 50000-50999	
FACTORY	Reset device to factory default configuration <b>NOTE:</b> This command deletes all user data from the device. The deletion can take some time. Your device may require powering off and powering on for the changes to take effect.	#FACTORY<CR>	~nn@FACTORY_ok<CR><LF>		Reset the device to factory default configuration: #FACTORY<CR>

Function	Description	Syntax	Response	Parameters/Attributes	Example
GTW-MSG- NUM?	Get Control Gateway Messages Counter from certain period. Add Recv_Count and Send_Count	#GTW-MSG-NUM? message_type,data<CR>	-nn@GTW-MSG-NUM message_type,date, recv_counter,send_count<CR> <LF>	message_type – where: 1 =CEC 2 = IR 3 = RS232 date – Format: DD-MM-YYYY. Recv_counter – counter of receive messages Send_counter – counter of send messages	Get Control Gateway Messages Counter from certain period #GTW-MSG-NUM? 1,05-12-2018<CR>
HDCP-MOD	Set HDCP mode. <b>NOTE:</b> Set HDCP working mode on the device input: HDCP supported - HDCP_ON [default]. HDCP not supported - HDCP OFF. HDCP support changes following detected sink - MIRROR OUTPUT. When you define 3 as the mode, the HDCP status is defined according to the connected output in the following priority: OUT 1, OUT 2. If the connected display on OUT 2 supports HDCP, but OUT 1 does not, then HDCP is defined as not supported. If OUT 1 is not connected, then HDCP is defined by OUT 2.	#HDCP-MOD?_in_index,mode<CR>	-nn@HDCP-MOD in_index,mode<CR><LF>	in_index – Number that indicates the specific input: 1-N (N= the total number of inputs) mode – HDCP mode: 0 – HDCP Off 1 – HDCP On 3 – HDCP Mirror Mode - used by KDS-7 decoder to allow an HDCP 2.2 source connected to the encoder to play on an HDCP 1.4 TV/display connected to the decoder.	Set the input HDCP-MODE of IN 1 to Off: #HDCP-MOD?_1,0<CR>
HDCP-MOD?	Get HDCP mode. <b>NOTE:</b> Set HDCP working mode on the device input: HDCP supported - HDCP_ON [default]. HDCP not supported - HDCP OFF. HDCP support changes following detected sink - MIRROR OUTPUT.	#HDCP-MOD?_in_index<CR>	-nn@HDCP-MOD in_index,mode<CR><LF>	in_index – Number that indicates the specific input: 1-N (N= the total number of inputs) mode – HDCP mode: 0 – HDCP Off 1 – HDCP On 3 – HDCP Mirror Mode - used by KDS-7 decoder to allow an HDCP 2.2 source connected to the encoder to play on an HDCP 1.4 TV/display connected to the decoder.	Get the input HDCP-MODE of IN 1 HDMI: #HDCP-MOD?_1<CR>
HDCP-STAT?	Get HDCP signal status. <b>NOTE:</b> io_mode = 1 – get the HDCP signal status of the sink device connected to the specified output. io_mode = 0 – get the HDCP signal status of the source device connected to the specified input.	#HDCP-STAT? io_mode,in_index<CR>	-nn@HDCP-STAT io_mode,in_index,status<CR> <LF>	io_mode – Input/Output 0 – Input 1 – Output io_index – Number that indicates the specific number of inputs or outputs (based on io_mode): 1-N (N=total number of inputs or outputs) status – Signal encryption status - valid values On/Off 0 – HDCP Off 1 – HDCP On	Get the output HDCP-STATUS of IN 1: #HDCP-STAT?_0,1<CR>
HELP	Get command list or help for specific command.	#HELP<CR> #HELP_cmd_name<CR>	1. Multi-line: -nn@Device_cmd_name, cmd_name<CR><LF> To get help for command use: HELP (COMMAND_NAME)<CR><LF> > -nn@HELP cmd_name:<CR><LF> description<CR><LF> USAGE:usage<CR><LF>	cmd_name – Name of a specific command	Get the command list: #HELP<CR>  To get help for AV-SW-TIMEOUT: HELP_av-sw-timeout<CR>
HW-TEMP?	Get device heat	#HW-TEMP? region_id,mode<CR>	-nn@HW-TEMP region_id, temperature<CR><LF>	region_id – ID of the region for which to get the temperature 0 – First CPU <b>Mode</b> – Celsius or Fahrenheit 0 – Celsius 1 – Fahrenheit temperature – Temperature of the HW region, rounded down to the closest integer	Get temperature in Celsius of first cpu #HW-TEMP? 0,0<CR>
HW- VERSION?	Get hardware version	#HW-VERSION?<CR>	-nn@HW-VERSION hardware_version<CR><LF>	hardware_version – XX.XX.XXXX where the digit groups are: major.minor.version	Get hardware version #HW-VERSION?<CR>
IDV	Set visual indication from device. <b>NOTE:</b> Using this command, some devices can light a sequence of buttons or LEDs to allow identification of a specific device from similar devices.	#IDV<CR>	-nn@IDV_ok<CR><LF>		#IDV<CR>



Function	Description	Syntax	Response	Parameters/Attributes	Example
KDS-GW-ETH	Set gateway network port	#KDS-GW-ETH gw_type,netw_id<CR>	~nn@KDS-GW-ETH gw_type,netw_id<CR><LF>	gw_type { 0 – Control 1 – Dante } netw_id – Network ID—the device network interface (if there are more than one). Counting is 0 based, meaning the control port is '0', additional ports are 1,2,3....	Set Dante port to eth1 #KDS-GW-ETH 1,1<CR>
KDS-GW-ETH?	Get gateway network port.	#KDS-GW-ETH? gw_type<CR>	~nn@KDS-GW-ETH gw_type,netw_id<CR><LF>	gw_type { 0 – Control 1 – Dante } netw_id – Network ID—the device network interface (if there are more than one). Counting is 0 based, meaning the control port is '0', additional ports are 1,2,3....	Get Dante port #KDS-GW-ETH? 1<CR>
KDS-IR-GW	Set IR gateway mode.	#KDS-IR-GW mode<CR>	~nn@KDS-IR-GW mode<CR><LF>	lr gw mode { 0 – off 1 – on }	Set IR Gateway to ON #KDS-IR-GW 1<CR>
KDS-IR-GW?	Get IR gateway mode.	#KDS-IR-GW?<CR>	~nn@KDS-IR-GW mode<CR><LF>	lr gw mode { 0 – off 1 – on }	Get IR Gateway #KDS-IR-GW?<CR>
KDS-METHOD	Set unicast / multicast .Add Set Command; add Multicast	#KDS-METHOD 1<CR>	~nn@KDS-METHOD method<CR><LF>	method – Streaming method – 1 Unicast 2 Multicast	Set current streaming method of encoder/decoder: #KDS-METHOD 1<CR>
KDS-METHOD?	Get unicast / multicast. Add Multicast.	#KDS-METHOD?<CR>	~nn@KDS-METHOD method<CR><LF>	method – Streaming method 1 – Unicast 2 – Multicast	Get current streaming method of encoder/decoder: #KDS-METHOD<CR>
KDS-MULTICAST	Set multicast group address and TTL value.	#KDS-MULTICAST group_ip,tll<CR>	~nn@KDS-MULTICAST group_ip,tll<CR><LF>	group-ip - Multicast group IP used for streaming packets in Multicast Streaming Method. tll - Time to Live of the streamed packets.	Set multicast group address and TTL value #KDS-MULTICAST <u>225.225.0.10.1</u> <CR>
KDS-OSD-DISPLAY	Set decoder OSD display.	#KDS-OSD-DISPLAY mode<CR>	~nn@KDS-OSD_DISPLAY mode<CR><LF>	osd mode { 0 – off 1 – on 2 – display now + on; //set osd mode to on, and osd will display now }	Set OSD Display mode on #KDS-OSD-DISPLAY 1<CR>
KDS-OSD-DISPLAY?	Get decoder OSD display status.	#KDS-OSD-DISPLAY?<CR>	~nn@KDS-OSD_DISPLAY mode<CR><LF>	osd mode { 0 – off 1 – on }	Get OSD display mode #KDS-OSD-DISPLAY?<CR>
KDS-RATIO?	Get aspect ratio.	#KDS-RATIO?<CR>	~nn@KDS-RATIO value<CR><LF>	value – Streamer Decoder Aspect Ratio width:height, for example "16:9"	Get Aspect Ratio #KDS-RATIO?<CR>

Function	Description	Syntax	Response	Parameters/Attributes	Example
KDS-RESOL?	Get actual AV stream resolution.	#KDS-RESOL? io_mode,io_index,is_native<CR>	~nn@KDS-RESOL? io_mode,io_index,is_native,res olution<CR><LF>	io_mode – Input/Output 0 – Input 1 – Output io_index – Number that indicates the specific input or output port: 1-N (N= the total number of input or output ports) is_native – Native resolution flag 0 – Off 1 – On resolution – Resolution index 0=No Signal (for input) / Native – EDID (for output) 1=640x480p@59.94Hz/60Hz 2=720x480p@59.94Hz/60Hz 3=720x480p@59.94Hz/60Hz 4=1280x720p@59.94Hz/60Hz 5=1920x1080i@59.94Hz/60Hz 6=720(1440)x480i@59.94Hz/60Hz 7=720(1440)x480i@59.94Hz/60Hz 8=720(1440)x240p@59.94Hz/60Hz 9=720(1440)x240p@59.94Hz/60Hz 10=2880x480i@59.94Hz/60Hz 11=2880x480i@59.94Hz/60Hz 12=2880x240p@59.94Hz/60Hz 13=2880x240p@59.94Hz/60Hz 14=1440x480p@59.94Hz/60Hz 15=1440x480p@59.94Hz/60Hz 16=1920x1080p@59.94Hz/60Hz 17=720x576p@50Hz 18=720x576p@50Hz 19=1280x720p@50Hz 20=1920x1080i@50Hz 21=720(1440)x576i@50Hz 22=720(1440)x576i@50Hz 23=720(1440)x288p@50Hz 24=720(1440)x288p@50Hz 25=2880x576i@50Hz 26=2880x576i@50Hz 27=2880x288p@50Hz 28=2880x288p@50Hz 29=1440x576p@50Hz 30=1440x576p@50Hz 31=1920x1080p@50Hz 32=1920x1080p@23.97Hz/24Hz 33=1920x1080p@25Hz 34=1920x1080p@29.97Hz/30Hz 35=2880x480p@59.94Hz/60Hz 36=2880x480p@59.94Hz/60Hz 37=2880x576p@50Hz 38=2880x576p@50Hz 39=1920x1080i@50Hz 40=1920x1080i@100Hz 41=1280x720p@100Hz 42=720x576p@100Hz 43=720x576p@100Hz 44=720(1440)x576i@100Hz 45=720(1440)x576i@100Hz 46=1920x1080i@119.88/120Hz 47=1280x720p@119.88/120Hz 48=720x480p@119.88/120Hz 49=720x480p@119.88/120Hz 50=720(1440)x480i@119.88/120Hz 51=720(1440)x480i@119.88/120Hz 52=720x576p@200Hz 53=720x576p@200Hz 54=720(1440)x576i@200Hz 55=720(1440)x576i@200Hz 56=720x480p@239.76/240Hz 57=720x480p@239.76/240Hz 58=720(1440)x480i@239.76/240Hz 59=720(1440)x480i@239.76/240Hz 60=1280x720p@23.97Hz/24Hz 61=1280x720p@25Hz 62=1280x720p@29.97Hz/30Hz 63=1920x1080p@119.88/120Hz 64=1920x1080p@100Hz 65=800x600p@60Hz 66=1024x768@60Hz 67=1280x768p@60Hz 68=1280x1024p@60Hz 69=1600x1200p@60Hz 70=1680x1050p@60Hz 71=1920x1200@60Hz 72=3840x2160p@24Hz 73=3840x2160p@25Hz 74=3840x2160p@30Hz 75=3840x2160p@50Hz 76=3840x2160p@60Hz 77-100=(Reserved) 100=Custom resolution 1 101=Custom resolution 2 102=Custom resolution 3 103=Custom resolution 4 104=Custom resolution 5 104-254=(Reserved)	

Function	Description	Syntax	Response	Parameters/Attributes	Example
KDS-RESOL?	Get actual AV stream resolution.	#KDS-RESOL? io_mode,io_index,is_native<CR>	~nn@KDS-RESOL? io_mode,io_index,is_native,res olution<CR><LF>	io_mode – Input/Output 0 – Input 1 – Output io_index – Number that indicates the specific input or output port: 1-N (N= the total number of input or output ports) is_native – Native resolution flag 0 – Off 1 – On resolution – Resolution index 0=No Signal (for input) / Native – EDID (for output) 1=640x480p@59.94Hz/60Hz 2=720x480p@59.94Hz/60Hz 3=720x480p@59.94Hz/60Hz 4=1280x720p@59.94Hz/60Hz 5=1920x1080i@59.94Hz/60Hz 6=720(1440)x480i@59.94Hz/60Hz 7=720(1440)x480i@59.94Hz/60Hz 8=720(1440)x240p@59.94Hz/60Hz 9=720(1440)x240p@59.94Hz/60Hz 10=2880x480i@59.94Hz/60Hz 11=2880x480i@59.94Hz/60Hz 12=2880x240p@59.94Hz/60Hz 13=2880x240p@59.94Hz/60Hz 14=1440x480p@59.94Hz/60Hz 15=1440x480p@59.94Hz/60Hz 16=1920x1080p@59.94Hz/60Hz 17=720x576p@50Hz 18=720x576p@50Hz 19=1280x720p@50Hz 20=1920x1080i@50Hz 21=720(1440)x576i@50Hz 22=720(1440)x576i@50Hz 23=720(1440)x288p@50Hz 24=720(1440)x288p@50Hz 25=2880x576i@50Hz 26=2880x576i@50Hz 27=2880x288p@50Hz 28=2880x288p@50Hz 29=1440x576p@50Hz 30=1440x576p@50Hz 31=1920x1080p@50Hz 32=1920x1080p@23.97Hz/24Hz 33=1920x1080p@25Hz 34=1920x1080p@29.97Hz/30Hz 35=2880x480p@59.94Hz/60Hz 36=2880x480p@59.94Hz/60Hz 37=2880x576p@50Hz 38=2880x576p@50Hz 39=1920x1080i@50Hz 40=1920x1080i@100Hz 41=1280x720p@100Hz 42=720x576p@100Hz 43=720x576p@100Hz 44=720(1440)x576i@100Hz 45=720(1440)x576i@100Hz 46=1920x1080i@119.88/120Hz 47=1280x720p@119.88/120Hz 48=720x480p@119.88/120Hz 49=720x480p@119.88/120Hz 50=720(1440)x480i@119.88/120Hz 51=720(1440)x480i@119.88/120Hz 52=720x576p@200Hz 53=720x576p@200Hz 54=720(1440)x576i@200Hz 55=720(1440)x576i@200Hz 56=720x480p@239.76/240Hz 57=720x480p@239.76/240Hz 58=720(1440)x480i@239.76/240Hz 59=720(1440)x480i@239.76/240Hz 60=1280x720p@23.97Hz/24Hz 61=1280x720p@25Hz 62=1280x720p@29.97Hz/30Hz 63=1920x1080p@119.88/120Hz 64=1920x1080p@100Hz 65=800x600p@60Hz 66=1024x768@60Hz 67=1280x768p@60Hz 68=1280x1024p@60Hz 69=1600x1200p@60Hz 70=1680x1050p@60Hz 71=1920x1200@60Hz 72=3840x2160p@24Hz 73=3840x2160p@25Hz 74=3840x2160p@30Hz 75=3840x2160p@50Hz 76=3840x2160p@60Hz 77-100=(Reserved) 100=Custom resolution 1 101=Custom resolution 2 102=Custom resolution 3 103=Custom resolution 4 104=Custom resolution 5 104-254=(Reserved)	
KDS-SCALE	Set scaling mode Add res_type.	#KDS-SCALE value,res_type<CR>	~nn@KDS-SCALE value,res_type<CR><LF>	value – Streamer Decoder Scaling Mode 0 – Pass Thru 1 – Scaling res_type[option] – res_type refer to #KDS-RESOL? Scaling should have an 'res_type'	Set scale to scaling, resolution is 1080P60 #KDS-SCALE 1,16<CR>

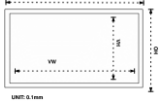
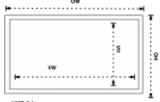
Function	Description	Syntax	Response	Parameters/Attributes	Example										
KDS-SCALE?	Get scaling mode Add res_type.	#KDS-SCALE?<CR>	~nn@KDS-SCALE value,res_type<CR><LF>	value – Streamer Decoder Scaling Mode 0 – Pass Thru 1 – Scaling res_type[option] – res_type refer to #KDS-RESOL? Scaling should have an 'res_type'	Get scaling mode #KDS-SCALE?<CR>										
KDS-START-OVERLAY	Start the Overlay process.	#KDS-START-OVERLAY profile_name,time_limit<CR>	~nn@KDS-START-OVERLAY profile_name,time_limit<CR><LF>	profile – name on the JSON cponfiguration file that defines overlay settings time_limit – The maximum time to display the overlay (override the parameter) this parameter can be omit or set to '0' to indicate we want to use the timeout predefined into the JSON configuration file. To set infinite time, set '0'.	Set text overlay parameters: #KDS-START-OVERLAY overlay,0<CR>										
KDS-STOP-OVERLAY	Stop the video overlay process.	#KDS-STOP-OVERLAY<CR>	~nn@KDS-STOP-OVERLAY <CR><LF>		Set text overlay parameters: #KDS-STOP-OVERLAY<CR>										
KDS-VLAN-TAG	Set vlan tag of gateway port.	#KDS-VLAN-TAG gw_type,tag_id<CR>	~nn@KDS-VLAN-TAG gw_type,tag_id<CR><LF>	gw_type { 0 – Control 1 – Dante } tag_id – vlan tag (1 to 4093) 1 = No VLAN tag	Set Dante vlan tag to 33: #KDS-VLAN-TAG 1,33<CR>										
KDS-VLAN-TAG?	Get vlan tag of gateway port.	#KDS-VLAN-TAG? gw_type<CR>	~nn@KDS-VLAN-TAG gw_type,tag_id<CR><LF>	gw_type { 0 – Control 1 – Dante } tag_id – vlan tag (1 to 4093) 1 = No VLAN tag	Get Dante vlan tag: #KDS-VLAN-TAG? 1<CR>										
KDS-VW-BEZEL	Set KDS-7 Video Wall bezel compensation.	#KDS-VW-BEZEL vw,ow,vh,oh<CR>	~nn@KDS-VW-BEZEL vw,ow,vh,oh<CR><LF>	 vw: 0~100000 ow: 0~100000 vh: 0~100000 oh: 0~100000	Set bezel compensation #KDS-VW-BEZEL 12210,12310,6860,6960<CR>										
KDS-VW-BEZEL?	Get KDS-7 Video Wall bezel compensation	#KDS-VW-BEZEL?<CR>	~nn@KDS-VW-BEZEL vw,ow,vh,oh<CR><LF>	 vw: 0~100000 ow: 0~100000 vh: 0~100000 oh: 0~100000	Get bezel compensation #KDS-VW-BEZEL?<CR>										
KDS-VW-PATTERN	Set test pattern mode of video wall.	#KDS-VW-PATTERN mode<CR>	~nn@KDS-VW-PATTERN mode<CR><LF>	mode 0 – OFF (Disable test pattern) 1 – On (Enable test pattern)	Set video wall test pattern on #KDS-VW-PATTERN 1<CR>										
KDS-VW-PATTERN?	Get test pattern mode of video wall.	#KDS-VW-PATTERN?<CR>	~nn@KDS-VW-PATTERN mode<CR><LF>	mode 0 – OFF (Disable test pattern) 1 – On (Enable test pattern)	Get video wall test pattern on #KDS-VW-PATTERN?<CR>										
LDFW	Load new firmware file. <b>NOTE:</b> In most devices firmware data is saved to flash memory, but the memory does not update until receiving the "UPGRADE" command and is restarted.	Step 1: #LDFW_size<CR> Step 2: If ready was received, send FIRMWARE_DATA	Response 1: ~nn@LDFW_size ready<CR><LF> or ~nn@LDFW_ernn<CR><LF> Response 2: ~nn@LDFW_size_ok<CR><LF>	size – Size of firmware data that is sent firmware_data – HEX or KFW file in protocol packets Using the Packet Protocol Send a command: LDRV, LOAD, IROUT, LDEDID Receive Ready or ERR### If Ready: a. Send a packet, b. Receive OK on the last packet, c. Receive OK for the command Packet structure: Packet ID (1, 2, 3...) (2 bytes in length) Length (data length + 2 for CRC) – (2 bytes in length) Data (data length -2 bytes) CRC – 2 bytes <table border="1" data-bbox="949 1635 1212 1724"> <tr> <td>01</td> <td>02</td> <td>03</td> <td>04</td> <td>05</td> </tr> <tr> <td>Packet ID</td> <td>Length</td> <td>Data</td> <td colspan="2">CRC</td> </tr> </table> Response: ~nnn_ok<CR><LF> (Where NNNN is the received packet ID in ASCII hex digits.)	01	02	03	04	05	Packet ID	Length	Data	CRC		
01	02	03	04	05											
Packet ID	Length	Data	CRC												
LOCK-EDID	Lock last read EDID.	#LOCK-EDID in_index,lock_mode<CR>	~nn@LOCK-EDID in_index,lock_mode<CR><LF>	in_index – 1 lock_mode – On/Off 0 – Off unlocks EDID 1 – On locks EDID	Lock the last read EDID from the HDMI In 1 input #LOCK-EDID 1,1<CR>										
LOCK-EDID?	Get EDID lock state.	#LOCK-EDID? in_index<CR>	~nn@LOCK-EDID in_index,lock_mode<CR><LF>	in_index – 1 lock_mode – On/Off 0 – Off unlocks EDID 1 – On locks EDID	Get EDID lock state for Input 1 #LOCK-EDID? 1<CR>										
LOCK-FP	Lock the front panel.	#LOCK-FP_lock/unlock<CR>	~nn@LOCK-FP lock/unlock<CR><LF>	Lock/Unlock – On/Off 0 – (Off) Unlocks EDID 1 – (On) Locks EDID	Unlock front panel: #LOCK-FP_0<CR>										
LOCK-FP?	Get the front panel lock state.	#LOCK-FP?<CR>	~nn@LOCK-FP lock/unlock<CR><LF>	Lock/Unlock – On/Off Off – Unlocks EDID On – Locks EDID	Get the front panel lock state: #LOCK-FP?<CR>										

Function	Description	Syntax	Response	Parameters/Attributes	Example
LOG-ACTION	Reset events log.	#LOG-ACTION <sub>action,period</sub> <CR>	-nn@LOG-ACTION action,period<CR><LF>	action – one of 1 – start 2 – pause 3 – resume 4 – reset period - relevant for "start" 1 – keep current 2 – daily 3 – weekly (default)	Reset events log : #LOG-ACTION <sub>4,2</sub> <CR>
LOG-TAIL?	Get the last "n" lines of message logs. <b>NOTE:</b> Used for advanced troubleshooting. Helps find error root causes and gets details not displayed in the error code number.	#LOG-TAIL? <sub>line_num</sub> <CR>	Get: -nn@LOG-TAILn<CR><LF> Line content #1<CR><LF> Line content #2<CR><LF> Etc...	line_num – Optional, default line_num is 10	Get the last "2" lines of message logs: #LOG-TAIL? <sub>2</sub> <CR>
LOGIN	Set protocol permission. <b>NOTE:</b> The permission system works only if security is enabled with the "SECUR" command. LOGIN allows the user to run commands with an End User or Administrator permission level. When the permission system is enabled, LOGIN enables running commands with the User or Administrator permission level. When set, login must be performed upon each connection. It is not mandatory to enable the permission system in order to use the device. In each device, some connections allow logging in to different levels. Some do not work with security at all. Connection may logout after timeout.	#LOGIN <sub>login_level,password</sub> <CR>	-nn@LOGIN login_level,password ok<CR><LF> or -nn@LOGIN_err 004<CR><LF> (if bad password entered)	login_level – Level of permissions required (User or Admin) password – Predefined password (by PASS command). Default password is an empty string	Set the protocol permission level to Admin (when the password defined in the PASS command is 33333): #LOGIN <sub>admin,33333</sub> <CR>
LOGIN?	Get current protocol permission level. <b>NOTE:</b> The permission system works only if security is enabled with the "SECUR" command. For devices that support security, LOGIN allows the user to run commands with an End User or Administrator permission level. In each device, some connections allow logging in to different levels. Some do not work with security at all. Connection may logout after timeout.	#LOGIN?<CR>	-nn@LOGIN login_level<CR><LF>	login_level – Level of permissions required (User or Admin)	Get current protocol permission level: #LOGIN?<CR>
LOGOUT	Cancel current permission level. <b>NOTE:</b> Logs out from End User or Administrator permission levels to Not Secure.	#LOGOUT<CR>	-nn@LOGOUT <sub>ok</sub> <CR><LF>		#LOGOUT<CR>
LOGOUT-TIMEOUT	Set inactivity auto-logout time.	# LOGOUT-TIMEOUT <sub>time</sub> <CR>	-nn@ LOGOUT-TIMEOUT time<CR><LF>	time – minutes of logout time	Set Inactivity auto-logout time to 10 #LOGOUT-TIMEOUT 10<CR>
LOGOUT-TIMEOUT?	Get inactivity auto-logout time.	#LOGOUT-TIMEOUT?<CR>	-nn@LOGOUT-TIMEOUT time<CR><LF>	time – minutes of logout time	Get Inactivity auto-logout time #LOGOUT-TIMEOUT?<CR>



Function	Description	Syntax	Response	Parameters/Attributes	Example
MODEL?	Get device model. <b>NOTE:</b> This command identifies equipment connected to KDS-EN7 and notifies of identity changes to the connected equipment. The Matrix saves this data in memory to answer REMOTE-INFO requests.	#MODEL?<CR>	-nn@MODEL model_name<CR><LF>	model_name – String of up to 19 printable ASCII chars	Get the device model: #MODEL?<CR>
NAME	Set machine or DANTE (DNS) name. <b>NOTE:</b> The machine name is not the same as the model name. The machine name is used to identify a specific machine or a network in use (with DNS feature on).	#NAME interface_id, host_name<CR>	-nn@NAME interface_id, host_name<CR><LF>	interface_id 0 – machine name 1 – dante name host_name – String of up to 15 alpha-numeric chars (can include hyphen, not at the beginning or end)	Set the machine DNS name of the device to room-442: #NAME 0 room-442<CR>
NAME?	Get machine or DANTE (DNS) name. <b>NOTE:</b> The machine name is not the same as the model name. The machine name is used to identify a specific machine or a network in use (with DNS feature on).	#NAME? interface_id<CR>	-nn@NAME interface_id, host_name<CR><LF>	interface_id 0 – machine name 1 – dante name host_name – String of up to 15 alpha-numeric chars (can include hyphen, not at the beginning or end)	Get the DNS name of the device: #NAME? 0<CR>
NAME-RST	Reset machine (DNS) name to factory default. <b>NOTE:</b> Factory default of machine (DNS) name is "KRAMER_" + 4 last digits of device serial number.	#NAME-RST<CR>	-nn@NAME-RST ok<CR><LF>		Reset the machine name (S/N last digits are 0102): #NAME-RST kramer_0102<CR>
NET-CONFIG	Set a network configuration. <b>NOTE:</b> Parameters [DNS1] and [DNS2] are optional. <b>NOTE:</b> For Backward compatibility, the id parameter can be omitted. In this case, the Network ID, by default, is 0, which is the Ethernet control port. <b>NOTE:</b> If the gateway address is not compliant to the subnet mask used for the host IP, the command will return an error. Subnet and gateway compliancy specified by RFC950.	#NET-CONFIG netw_id,net_ip,net_mask,gateway,[dns1],[dns2]<CR>	-nn@NET-CONFIG netw_id,net_ip,net_mask,gateway<CR><LF>	netw_id – Network ID—the device network interface (if there are more than one). Counting is 0 based, meaning the control port is '0', additional ports are 1,2,3.... net_ip – Network IP net_mask – Network mask gateway – Network gateway	Set the device network parameters to IP address 192.168.113.10, net mask 255.255.0.0, and gateway 192.168.0.1: #NET-CONFIG 0,192.168.113.10,255.255.0.0,192.168.0.1<CR>
NET-CONFIG?	Get a network configuration.	#NET-CONFIG? netw_id<CR>	-nn@NET-CONFIG netw_id,net_ip,net_mask,gateway<CR><LF>	netw_id – Network ID—the device network interface (if there are more than one). Counting is 0 based, meaning the control port is '0', additional ports are 1,2,3.... net_ip – Network IP net_mask – Network mask gateway – Network gateway	Get network configuration: #NET-CONFIG? id<CR>

Function	Description	Syntax	Response	Parameters/Attributes	Example
NET-DHCP	Set DHCP mode. <b>NOTE:</b> Only 1 is relevant for the mode value. To disable DHCP, the user must configure a static IP address for the device. Connecting Ethernet to devices with DHCP may take more time in some networks. To connect with a randomly assigned IP by DHCP, specify the device DNS name (if available) using the NAME command. You can also get an assigned IP by direct connection to USB or RS-232 protocol port, if available. For proper settings consult your network administrator. <b>NOTE:</b> For Backward compatibility, the id parameter can be omitted. In this case, the Network ID, by default, is 0, which is the Ethernet control port.	#NET-DHCP netw_id,dhcp_state<CR>	~nn@NET-DHCP netw_id,dhcp_state<CR><LF>	netw_id – Network ID—the device network interface (if there are more than one). Counting is 0 based, meaning the control port is '0', additional ports are 1,2,3.... dhcp_state – 1 – Try to use DHCP. (If unavailable, use the IP address set by the factory or the net-ip command).	Enable DHCP mode for port 1, if available: #NET-DHCP_1,1<CR>
NET-DHCP?	Get DHCP mode. <b>NOTE:</b> For Backward compatibility, the id parameter can be omitted. In this case, the Network ID, by default, is 0, which is the Ethernet control port.	#NET-DHCP?_id<CR>	~nn@NET-DHCP netw_id,dhcp_state<CR><LF>	netw_id – Network ID—the device network interface (if there are more than one). Counting is 0 based, meaning the control port is '0', additional ports are 1,2,3.... dhcp_state – 1 – Try to use DHCP. (If unavailable, use the IP address set by the factory or the net-ip command).	Get DHCP mode for port 1, if available: #NET-DHCP?_1<CR>
NET-MAC?	Get MAC address. <b>NOTE:</b> For backward compatibility, the id parameter can be omitted. In this case, the Network ID, by default, is 0, which is the Ethernet control port.	#NET-MAC?_id<CR>	~nn@NET-MAC id,mac_address<CR><LF>	id – Network ID—the device network interface (if there are more than one). Counting is 0 based, meaning the control port is '0', additional ports are 1,2,3.... mac_address – Unique MAC address. Format: XX-XX-XX-XX-XX-XX where X is hex digit	#NET-MAC?_id<CR>
NET-STAT?	Get net connection list of this machine. <b>NOTE:</b> The response is returned in one line and terminated with<CR><LF>. The response format lists signal IDs separated by commas. This is an Extended Protocol 3000 command.	#NET-STAT?<CR>	~nn@NET-STAT [(<port_type> <port_index>,<client_ip>:<client_port>),state ]...<CR><LF>	port_type – TCP/UDP 0 – TCP 1 – UDP port_index - Device port client_ip – Dot-separated representation of the IP address client_port - Client port state – listen or established	Get net connection list of this machine: #NET-STAT?<CR> ~01@NETSTAT [(TCP:80.0.0.0:0),LISTEN],[ (TCP:5000.0.0.0:0), LISTEN], [(TCP:80.192.168.114.3:5240 0),ESTABLISHED],[(TCP:500 0,192.168.1.100:51647) ,ESTABLISHED]<CR><LF>
NET-IP?	Get a network IP address. This is an UDP protocol only.	#NET-IP?<CR>	~nn@NET-IP_net_ip<CR><LF>	net_ip – Network IP	Get network IP address: #NET-IP?<CR>
PASS	Set password for login level. Default password = admin.	#PASS login_level password<CR>	~nn@PASS login_level,password<CR><LF> >	login_level – Level of login to set (supports admin only).  password – Password for the login_level. Up to 15 printable ASCII chars	Set the password for the admin protocol permission level to 33333: #PASS admin,33333<CR>
PASS?	Get password for login level. Default password = admin.	#PASS? login_level<CR>	~nn@PASS login_level,password<CR><LF> >	login_level – Level of login to set (supports admin only).  password – Password for the login_level. Up to 15 printable ASCII chars	Get the password for the admin protocol permission level: #PASS? admin<CR>

Function	Description	Syntax	Response	Parameters/Attributes	Example
PORT-DIRECTION	Set port direction as input or output.	#PORT-DIRECTION <direction_type>.<port_format>.<port_index>.<signal_type>, direction<CR>	-nn@PORT-DIRECTION <direction_type>.<port_format>.<port_index>.<signal_type>, direction<CR><LF>	The following attributes comprise the signal ID: <direction_type> – Direction of the port: { IN – Input ; OUT – Output; BOTH – Bi-directional } <port_format> – Type of signal on the port: { HDMI; ANALOG-AUDIO; IR } <port_index> – The port number as printed on the front or rear panel <signal_type> – Signal ID attribute: { AUDIO; IR } <direction> – Direction of the port: { IN – Input ; OUT – Output;}	Set audio analog port direction as input #PORT-DIRECTION both.analog.1.audio, IN<CR>
PORT-DIRECTION	Get port direction.	#PORT-DIRECTION? <direction_type>.<port_format>.<port_index>.<signal_type><CR>	-nn@PORT-DIRECTION <direction_type>.<port_format>.<port_index>.<signal_type>, direction<CR><LF>	The following attributes comprise the signal ID: <direction_type> – Direction of the port: { IN – Input ; OUT – Output; BOTH – Bi-directional } <port_format> – Type of signal on the port: { HDMI; ANALOG-AUDIO; IR } <port_index> – The port number as printed on the front or rear panel <signal_type> – Signal ID attribute: { AUDIO; IR } <direction> – Direction of the port: { IN – Input ; OUT – Output;}	Get audio analog port direction #PORT-DIRECTION? both.analog.1.audio<CR>
PORTS-LIST?	Get the port list of this machine. <b>NOTE:</b> The response is returned in one line and terminated with<CR><LF>. The response format lists port IDs separated by commas. This is an Extended Protocol 3000 command.	#PORTS-LIST?<CR>	-nn@PORTS-LIST [<direction_type>.<port_format>.<port_index>,...]<CR><LF>	The following attributes comprise the port ID: <direction_type> – Direction of the port: IN OUT BOTH <port_format> – Type of signal on the port: HDMI HDBT ANALOG_AUDIO AMPLIFIED_AUDIO TOS SPDIF MIC RS-232 IR USB_A USB_B <port_index> – The port number as printed on the front or rear panel	Get the ports list: #PORTS-LIST?<CR>
RESET	Reset device <b>NOTE:</b> To avoid locking the port due to a USB bug in Windows, disconnect USB connections immediately after running this command. If the port was locked, disconnect and reconnect the cable to reopen the port.	#RESET<CR>	-nn@RESET,ok<CR><LF>		Reset the device: #RESET<CR>
ROLLBACK	Rollback firmware to standby version.	#ROLLBACK<CR>	-nn@ROLLBACK ok<CR><LF>		Perform firmware rollback: # ROLLBACK<CR>
SECUR	Start/stop security. <b>NOTE:</b> The permission system works only if security is enabled with the "SECUR" command.	#SECUR_security_state<CR>	-nn@SECUR security_state<CR><LF>	security_state – Security state 0 – OFF (disables security) 1 – ON (enables security)	Enable the permission system: #SECUR_0<CR>

Function	Description	Syntax	Response	Parameters/Attributes	Example
SIGNALS-LIST?	Get signal ID list of this machine. <b>NOTE:</b> The response is returned in one line and terminated with<CR><LF>. The response format lists signal IDs separated by commas. This is an Extended Protocol 3000 command.	#SIGNALS-LIST?<CR><LF>	~nn@SIGNALS-LIST [<direction_type>.<port_format>.<port_label>.<signal_type>.<index>]<CR><LF>	The following attributes comprise the signal ID: <direction_type> – Direction of the port: IN – Input OUT – Output BOTH – Bi-directional (e.g. for RS-232) <port_format> – Type of signal on the port: HDMI HDBT ANALOG_AUDIO AMPLIFIED_AUDIO TOS SPDIF MIC RS-232 IR USB_A USB_B <port_index> – The port number as printed on the front or rear panel <signal_type> – Signal ID attribute: VIDEO AUDIO ARC RS232 IR USB <index> – Indicates a specific channel number when there are multiple channels of the same type	Get signal ID list: #SIGNALS-LIST?<CR>
SN?	Get device serial number.	#SN?<CR>	~nn@SN serial_num<CR><LF>	serial_num – 14 decimal digits, factory assigned	Get the device serial number: #SN?<CR>
STANDBY	Set standby mode.	#STANDBY_value<CR>	~nn@STANDBY value<CR><LF>	value – On/Off 0 – Off 1 – On	Set standby mode: #STANDBY_1<CR>
STANDBY-TIMEOUT	Set inactivity auto-standby time.	#STANDBY-TIMEOUT time<CR>	~nn@STANDBY-TIMEOUT time<CR><LF>	time – minutes of standby time	Set inactivity auto-standby time is 10 min #STANDBY-TIMEOUT 10<CR>
STANDBY-TIMEOUT?	Get inactivity auto-standby time.	#STANDBY-TIMEOUT?<CR>	~nn@STANDBY-TIMEOUT time<CR><LF>	time – minutes of standby time	Get inactivity auto-standby time #STANDBY-TIMEOUT?<CR>
STANDBY-VERSION?	Get standby firmware version.	#STANDBY-VERSION?<CR>	~nn@STANDBY-VERSION? standby_version<CR><LF>	standby_version – XX.XX.XXXX where the digit groups are: major.minor.build version	Get standby version #STANDBY-VERSION?<CR>
TIME	Set device time and date.. <b>NOTE:</b> The year must be 4 digits. The device does not validate the day of week from the date. Time format - 24 hours. Date format - Day, Month, Year.	#TIME_day_of_week,date,data<CR>	~nn@TIME day_of_week,date,data<CR><LF>	day_of_week – One of {SUN,MON,TUE,WED,THU,FRI,SA T} date – Format: DD-MM-YYYY. data – Format: hh:mm:ss where hh = hours mm = minutes ss = seconds	Set device time and date to December 5, 2018 at 2:30pm: #TIME_mon_05-12-2018,14:30:00<CR>
TIME?	Get device time and date.. <b>NOTE:</b> The year must be 4 digits. The device does not validate the day of week from the date. Time format - 24 hours. Date format - Day, Month, Year.	#TIME?<CR>	~nn@TIME day_of_week,date,data<CR><LF>	day_of_week – One of {SUN,MON,TUE,WED,THU,FRI,SA T} date – Format: YYYY/MM/DD where YYYY = Year MM = Month DD = Day data – Format: hh:mm:ss where hh = hours mm = minutes ss = seconds	Get device time and date: #TIME?<CR>
TIME-LOC	Set local time offset from UTC/GMT. <b>NOTE:</b> If the time server is configured, device time calculates by adding UTC_off to UTC time (that it got from the time server) + 1 hour if daylight savings time is in effect. TIME command sets the device time without considering these settings.	#TIME-LOC_utc_off,dst_state<CR>	~nn@TIME-LOC utc_off,dst_state<CR><LF>	utc_off – Offset of device time from UTC/GMT (without daylight time correction) dst_state – Daylight saving time state 0 – no daylight saving time 1 – daylight saving time	Set local time offset to 3 with no daylight-saving time: #TIME-LOC_3,0<CR>
TIME-LOC?	Get local time offset from UTC/GMT. <b>NOTE:</b> If the time server is configured, device time calculates by adding UTC_off to UTC time (that it got from the time server) + 1 hour if daylight savings time is in effect. TIME command sets the device time without considering these settings.	#TIME-LOC?<CR>	~nn@TIME-LOC utc_off,dst_state<CR><LF>	utc_off – Offset of device time from UTC/GMT (without daylight time correction) dst_state – Daylight saving time state 0 – no daylight saving time 1 – daylight saving time	Get local time offset from UTC/GMT: #TIME-LOC?<CR>

Function	Description	Syntax	Response	Parameters/Attributes	Example
TIME-SRV	Set time server. <b>NOTE:</b> This command is needed for setting UDP timeout for the current client list.	#TIME-SRV mode,time_server_ip,sync_hour<CR>	-nn@TIME-SRV mode,time_server_ip,sync_hour,server_status<CR><LF>	mode – On/Off 0 – Off 1 – On time_server_ip – Time server IP address sync_hour – Hour in day for time server sync server_status – On/Off	Set time server with IP address of 128.138.140.44 to ON: #TIME-SRV 1,128.138.140.44,0,1<CR>
TIME-SRV?	Get time server. <b>NOTE:</b> This command is needed for setting UDP timeout for the current client list.	#TIME-SRV?<CR>	-nn@TIME-SRV mode,time_server_ip,sync_hour,server_status<CR><LF>	mode – On/Off 0 – Off 1 – On time_server_ip – Time server IP address sync_hour – Hour in day for time server sync server_status – On/Off	Get time server: #TIME-SRV?<CR>
UART	Set com port configuration. If Serial is configured when RS-485 is selected, the RS-485 UART port automatically changes. The command is backward compatible, meaning that if the extra parameters do not exist, FW goes to RS-232. Stop_bits 1.5 is only relevant for 5 data_bits.	#UART com_id,baud_rate,data_bits,parity,stop_bits_mode,serial_type,485_term<CR>	-nn@UART com_id,baud_rate,data_bits,parity,stop_bits_mode,serial_type,485_term<CR><LF>	com_id – 1 to n (machine dependent) baud_rate – 9600 - 115200 data_bits – 5-8 parity – Parity Type 0 – No 1 – Odd 2 – Even stop_bits_mode – 1/1.5/2 serial_type – 232/485 0 – 232 1 – 485 485_term – 485 termination state 0 – disable 1 – enable (optional - this exists only when serial_type is 485)	Set baud rate to 9600, 8 data bits, parity to none and stop bit to 1: #UART_9600,8,node,1<CR>
UART?	Get com port configuration. The command is backward compatible, meaning that if the extra parameters do not exist, FW goes to RS-232. Stop_bits 1.5 is only relevant for 5 data_bits.	#UART?_com_id<CR>	-nn@UART com_id,baud_rate,data_bits,parity,stop_bits_mode,serial_type,485_term<CR><LF>	com_id – 1 to n (machine dependent) baud_rate – 9600 - 115200 data_bits – 5-8 parity – Parity Type 0 – No 1 – Odd 2 – Even stop_bits_mode – 1/1.5/2 serial_type – 232/485 0 – 232 1 – 485 485_term – 485 termination state 0 – disable 1 – enable (optional - this exists only when serial_type is 485)	Set baud rate to 9600, 8 data bits, parity to none and stop bit to 1: #UART 1,9600,8,node,1<CR>
UPG-TIME?	Get firmware version last upgrade date/time Add New Command for KDS-7	#UPG-TIME?<CR>	-nn@UPG-TIME date,data<CR><LF>	date – Format: DD-MM-YYYY. data – Format: hh:mm:ss where	Get last upgrade date/time #UPG-TIME?<CR>
UPGRADE	Perform firmware upgrade. <b>NOTE:</b> Not necessary for some devices. Firmware usually uploads to a device via a command like LDFW. Reset the device to complete the process.	#UPGRADE<CR>	-nn@UPGRADE_ok<CR><LF>		Perform firmware upgrade: #UPGRADE<CR>
VERSION?	Get firmware version number.	#VERSION?<CR>	-nn@VERSION firmware_version<CR><LF>	firmware_version – XX.XX.XXXX where the digit groups are: major.minor.build version	Get the device firmware version number: #VERSION?<CR>
VIDEO-WALL-SETUP	Define device video wall relative position and video alignment.	#VIDEO-WALL-SETUP out_id,rotation<CR>	-nn@VIDEO-WALL-SETUP out_id,rotation<CR><LF>	out_id – Number of output (1-256) rotation – Repetition rate in seconds 0 – 0 degrees 1 – 90 degrees 2 – 180 degrees 3 – 270 degrees	Set video alignment: #VIDEO-WALL-SETUP 10,1<CR>
VIDEO-WALL-SETUP?	Get device video wall relative position and video alignment.	#VIDEO-WALL-SETUP? out_id<CR>	-nn@VIDEO-WALL-SETUP out_id,rotation<CR><LF>	out_id – Number of output (1-256) rotation – Repetition rate in seconds 0 – 0 degrees 1 – 90 degrees 2 – 180 degrees 3 – 270 degrees	Get video alignment: #VIDEO-WALL-SETUP?<CR>
VIEW-MOD	Set view mode. In case of KDS-7 only Video wall mode is supported. Second and third parameters are "mode" specific. In case of video wall, they define video wall layout	#VIEW-MOD_mode<CR>	-nn@VIEW-MOD mode<CR><LF>	mode – View Modes 0 – PIP off (matrix) 1 – PIP on (dual PIP) 2 – Preview (not applicable) 3 – Quad 5 – POP 15 – Video wall Horizontal – video wall layout Vertical – video wall layout	Set view mode: #VIEW-MOD_15_2_2<CR>
VIEW-MOD?	Get view mode. In case of KDS-7 only Video wall mode is supported.	#VIEW-MOD?<CR>	-nn@VIEW-MOD_mode, horizontal,vertical<CR><LF>	mode – View Modes 0 – PIP off (matrix) 1 – PIP on (dual PIP) 2 – Preview (not applicable) 3 – Quad 5 – POP 15 – Video wall horizontal – video wall layout vertical – video wall layout	Get view mode: #VIEW-MOD?15,2,2<CR>

Function	Description	Syntax	Response	Parameters/Attributes	Example
WND-BEZEL	Get Encoder AV channel info returns channel id and channel name. In case of KDS-7 only Video wall mode is supported.	#WND-BEZEL mode,out_index,hv_value,switch,h_value,v_value,h_value,v_value<CR>	-nn@WND-BEZEL mode,out_index,hv_value,switch,h_value,v_value,h_value,v_value<CR><LF>	mode - View mode: 0 = matrix 1 = PIP on (dual PIP or PIP1) 2 = Preview (not applicable) 3 = Quad 4 = Video wall 2x2 5 = Pop3(side) 6 = Video wall 1x4 7 = Split screen 8 = SbS 9 = Pip2 10 = Pip3 11 = Stacked 12 = Pop3(bottom) 13 = Matrix fast switch out_index - Number that indicates the specific output 1-256: 1-N (N= the total number of outputs) h_value – Horizontal correction values v_value – Vertical correction values h_offset – Horizontal correction values. v_offset – Vertical correction values	Define bezel correction: #WND-BEZEL 0,1,2,2,0,0<CR>
WND-BEZEL?	Set Bezel H/V correction in pixels. The bezel is assumed to be centered on the screen. For cases where it is not, this offset is designed to shift it. In case of KDS-7 only Video wall mode is supported.	#WND-BEZEL?<CR>	-nn@BEZEL mode,out_index,hv_value,switch,h_value,v_value,h_value,v_value<CR><LF>	mode - View mode: 0 = matrix 1 = PIP on (dual PIP or PIP1) 2 = Preview (not applicable) 3 = Quad 4 = Video wall 2x2 5 = Pop3(side) 6 = Video wall 1x4 7 = Split screen 8 = SbS 9 = Pip2 10 = Pip3 11 = Stacked 12 = Pop3(bottom) 13 = Matrix fast switch out_index - Number that indicates the specific output 1-256: 1-N (N= the total number of outputs) h_value – Horizontal correction values v_value – Vertical correction values h_offset – Horizontal correction values. v_offset – Vertical correction values	Get bezel correction: #WND-BEZEL?<CR>
WND-STRETCH	Set video wall stretch type Add New Command for KDS-7	#WND-STRETCH out_index,mode<CR>	-nn@WND-STRETCH out_index,mode<CR><LF>	out_index - Number that indicates the specific output 1-256: 1-N (N= the total number of outputs) mode - Stretch mode: 0 - fit in 1 - fit out	Set Video Wall Stretch Type is Fit In #WND-STRETCH 1, 0<CR>
WND-STRETCH?	Get video wall stretch type Add New Command for KDS-7	#WND-STRETCH? out_index<CR>	-nn@WND-STRETCH out_index,mode<CR><LF>	out_index - Number that indicates the specific output 1-256: 1-N (N= the total number of outputs) mode - Stretch mode: 0 - fit in 1 - fit out	Get Video Wall Stretch Type #WND-STRETCH? 1<CR>
X-AUD-DESC?	Get audio signal info <b>NOTE:</b> This is an Extended Protocol 3000 command.	#X-AUD-DESC? <direction_type>.<port_format>.<port_index><CR>	-nn@X-AUD-DESC? <direction_type>.<port_format>.<port_label>.<signal_type>.<index>.<ch_tot>.<samp_rate>.<aud_format><CR><LF>	The following attributes comprise the signal ID: <direction_type> – Direction of the port: IN – Input OUT – Output BOTH – Bi-directional (e.g. for RS-232) <port_format> – Type of signal on the port: HDMI HDBT ANALOG_AUDIO AMPLIFIED_AUDIO TOS SPDIF MIC RS-232 IR USB_A USB_B <port_index> – The port number as printed on the front or rear panel ch_tot – Total number of channels samp_rate – Sample rate aud_format –	Get the audio signal info: #X-AUD-DESC? out.hdmi.1<CR>

Function	Description	Syntax	Response	Parameters/Attributes	Example
X-AUD-LVL	Set audio level of a specific signal. <b>NOTE:</b> This is an Extended Protocol 3000 command.	#X-AUD-LVL <direction_type>.<port_format>.<port_index>.<signal_type>.<index>.audio_level<CR>	~nn@X-AUD-LVL <direction_type>.<port_format>.<port_index>.<signal_type>.<index>.audio_level<CR><LF>	The following attributes comprise the signal ID: <direction_type> – Direction of the port: IN – Input OUT – Output BOTH – Bi-directional (e.g. for RS-232) <port_format> – Type of signal on the port: HDMI HDBT ANALOG_AUDIO AMPLIFIED_AUDIO TOS SPDIF MIC RS-232 IR USB_A USB_B <port_index> – The port number as printed on the front or rear panel <signal_type> – Signal ID attribute: VIDEO AUDIO ARC RS232 IR USB <index> – Indicates a specific channel number when there are multiple channels of the same type audio_level – Audio level in dB (range between -60 to +30) depending of the ability of the product	Set the audio level of a specific signal to 10: #X-AUD-LVL in.analog_audio.5.audio.1,10 <CR>
X-AUD-LVL?	Get audio level of a specific signal. <b>NOTE:</b> This is an Extended Protocol 3000 command.	#X-AUD-LVL? <direction_type>.<port_format>.<port_index>.<signal_type>.<index><CR>	~nn@X-AUD-LVL <direction_type>.<port_format>.<port_index>.<signal_type>.<index>.audio_level<CR><LF>	The following attributes comprise the signal ID: <direction_type> – Direction of the port: IN – Input OUT – Output BOTH – Bi-directional (e.g. for RS-232) <port_format> – Type of signal on the port: HDMI HDBT ANALOG_AUDIO AMPLIFIED_AUDIO TOS SPDIF MIC RS-232 IR USB_A USB_B <port_index> – The port number as printed on the front or rear panel <signal_type> – Signal ID attribute: VIDEO AUDIO ARC RS232 IR USB <index> – Indicates a specific channel number when there are multiple channels of the same type audio_level – Audio level in dB (range between -60 to +30) depending of the ability of the product	Get the audio level of a specific signal: #X-AUD-LVL? out.analog_audio.1.audio.1<CR>

Function	Description	Syntax	Response	Parameters/Attributes	Example
X-AV-SW-MODE	Set auto-switch mode per output. <b>NOTE:</b> This is an Extended Protocol 3000 command.	#X-AV-SW-MODE <direction_type>.<port_format>.<port_index>.<signal_type>.<index>.<connection_mode><CR>	~nn@X-AV-SW-MODE <direction_type>.<port_format>.<port_index>.<signal_type>.<index>.<connection_mode><CR><LF>	The following attributes comprise the signal ID: <direction_type> – Direction of the port: IN – Input OUT – Output BOTH – Bi-directional (e.g. for RS-232) <port_format> – Type of signal on the port: HDMI HDBT ANALOG_AUDIO AMPLIFIED_AUDIO TOS SPDIF MIC RS-232 IR USB_A USB_B <port_index> – The port number as printed on the front or rear panel <signal_type> – Signal ID attribute: VIDEO AUDIO ARC RS232 IR USB <index> – Indicates a specific channel number when there are multiple channels of the same type connection_mode – Connection mode 0 – manual 1 – priority 2 – last connected	Set auto switch mode for HDMI OUT 1 (last connected): #X-AV-SW-MODE out.hdmi.1.video.1,2<CR>
X-AV-SW-MODE?	Get auto-switch mode. <b>NOTE:</b> This is an Extended Protocol 3000 command.	#X-AV-SW-MODE?<direction_type>.<port_format>.<port_index>.<signal_type>.<index><CR>	~nn@X-AV-SW-MODE <direction_type>.<port_format>.<port_index>.<signal_type>.<index>.<connection_mode><CR><LF>	The following attributes comprise the signal ID: <direction_type> – Direction of the port: IN – Input OUT – Output BOTH – Bi-directional (e.g. for RS-232) <port_format> – Type of signal on the port: HDMI HDBT ANALOG_AUDIO AMPLIFIED_AUDIO TOS SPDIF MIC RS-232 IR USB_A USB_B <port_index> – The port number as printed on the front or rear panel <signal_type> – Signal ID attribute: VIDEO AUDIO ARC RS232 IR USB TEST PATTERN KDS-OVER <index> – Indicates a specific channel number when there are multiple channels of the same type connection_mode – Connection mode 0 – manual 1 – priority 2 – last connected	Get auto switch mode for HDMI OUT 1: #X-AV-SW-MODE? out.hdmi.1.video.1<CR>
X-MUTE	Set mute ON/OFF on a specific signal.	#X-MUTE <direction_type>.<port_format>.<port_index>.<signal_type>.<index>.<state><CR>	~nn@ X-MUTE <direction_type>.<port_format>.<port_index>.<signal_type>.<index>.<state><CR><LF>	<direction_type> – Direction of the port: { IN – Input ; OUT – Output ; BOTH – Bi-directional } <port_format> – Type of signal on the port: { HDMI,USB_C,ANALOG_AUDIO } <port_index> – The port number as printed on the front or rear panel <signal_type> – Signal ID attribute: { VIDEO, AUDIO } <index> – Indicates a specific channel number when there are multiple channels of the same type state – OFF/ON (not case sensitive)	Mute the video on HDMI OUT 1: #X-MUTE_out.hdmi.1.video.1,on<CR>



Function	Description	Syntax	Response	Parameters/Attributes	Example
X-MUTE?	Get mute ON/OFF on a specific signal.	#X-MUTE? <direction_type>.<port_format>.<port_index>.<signal_type>.<index><CR>	-nn@ X-MUTE <direction_type>.<port_format>.<port_index>.<signal_type>.<index>,state<CR><LF>	<direction_type> – Direction of the port: { IN – Input ; OUT – Output ; BOTH – Bi-directional } <port_format> – Type of signal on the port: { HDMI,USB_C,ANALOG_AUDIO } <port_index> – The port number as printed on the front or rear panel <signal_type> – Signal ID attribute: { VIDEO, AUDIO } <index> – Indicates a specific channel number when there are multiple channels of the same type state – OFF/ON (not case sensitive)	Get the mute the video on HDMI OUT 1: #X-MUTE?_out.hdmi.1.video.1<CR>
X-PRIORITY	Set priority order.	#X-PRIORITY <direction_type>.<port_format>.<port_index>.<signal_type>,[<direction_type>.<port_format>.<port_index>.<signal_type> ,...]<CR>	-nn@X-PRIORITY <direction_type>.<port_format>.<port_index>.<signal_type>,[<direction_type>.<port_format>.<port_index>.<signal_type> ,...]<CR><LF>	<direction_type> – Direction of the port: { IN – Input ; OUT – Output ; BOTH – Bi-directional } <port_format> – Type of signal on the port: { HDMI,USB_C,ANALOG_AUDIO } <port_index> – The port number as printed on the front or rear panel <signal_type> – Signal ID attribute: { VIDEO, AUDIO }	Set video priority is 3,2,1 #X-PRIORITY out.hdmi.1.video,[in.usb_c.3.video,in.hdmi.2.video,in.hdmi.1.video]<CR>
X-PRIORITY?	Get priority order.	#X-PRIORITY? <direction_type>.<port_format>.<port_index>.<signal_type><CR>	-nn@X-PRIORITY <direction_type>.<port_format>.<port_index>.<signal_type>,[<direction_type>.<port_format>.<port_index>.<signal_type> ,...]<CR><LF>	<direction_type> – Direction of the port: { IN – Input ; OUT – Output ; BOTH – Bi-directional } <port_format> – Type of signal on the port: { HDMI,USB_C,ANALOG_AUDIO } <port_index> – The port number as printed on the front or rear panel <signal_type> – Signal ID attribute: { VIDEO, AUDIO }	Get video priority #X-PRIORITY? out.hdmi.1.video<CR>
X-ROUTE	Send routing command. <b>NOTE:</b> It is recommended to use the command #SIGNALS-LIST to get the list of all signal IDs available in the system and which can be used in this command. Video 1 is the default port in this command and is implied even if not written: #X-ROUTE out.sdi.5,in.sdi.1<CR> > is interpreted as: #X-ROUTE out.sdi.5.video.1,in.sdi.1.video.1<CR> This is an Extended Protocol 3000 command. Brackets '[' and ']' are reserved Protocol 3000 characters that define a list of parameters as in [a,b,c,d].	#X-ROUTE [<direction_type1>.<port_type1>.<port_index1>.<signal_type1>.<index1> ,...],<direction_type2>.<port_type2>.<port_index2>.<signal_type2>.<index2><CR>	-nn@X-ROUTE [<direction_type1>.<port_type1>.<port_index1>.<signal_type1>.<index1> ,...],<direction_type2>.<port_type2>.<port_index2>.<signal_type2>.<index2><CR><LF>	The following attributes comprise the signal ID: <direction_type> – Direction of the port: IN – Input OUT – Output BOTH – Bi-directional (e.g. for RS-232) <port_format> – Type of signal on the port: HDMI HDBT ANALOG_AUDIO AMPLIFIED_AUDIO TOS SPDIF MIC RS-232 IR USB_A USB_B STREAM DANTE <port_index> – The port number as printed on the front or rear panel <signal_type> – Signal ID attribute: VIDEO AUDIO ARC RS232 IR USB <index> – Indicates a specific channel number when there are multiple channels of the same type	Route HDMI IN 2 to HDMI OUT 3: #X-ROUTE out.hdmi.3.video.1,in.hdmi.2.video.1<CR> Route an ARC audio signal to HDBT input #1 from HDMI output #1: #X-ROUTE in.hdbt.1.arc.1,out.hdmi.1.arc.1<CR> Route audio of hdmi.1.audio.1 signal to hdmi output, analog, and dante: #X-ROUTE [out.hdmi.1.audio.1,out.analog_audio.1.audio.1,out.dante.1.audio.1],in.hdmi.1.audio.1<CR>

Function	Description	Syntax	Response	Parameters/Attributes	Example
X-ROUTE?	<p>Get routing status.  <b>NOTE:</b> It is recommended to use the command #SIGNALS-LIST to get the list of all signal IDs available in the system and which can be used in this command. VIDEO.1 are the default &lt;signal_type&gt; and &lt;index&gt; in this command and are implied even if not written:                      #X-ROUTE                      out.sdi.5.in.sdi.1&lt;CR&gt;                      &gt;                      is interpreted as:                      #X-ROUTE                      out.sdi.5.video.1.in.sdi.1.video.1&lt;CR&gt;                      This is an Extended Protocol 3000 command.</p>	<p>#X-ROUTE?                      &lt;direction_type1&gt;.&lt;port_type1&gt;.&lt;port_index1&gt;.&lt;signal_type1&gt;.&lt;index1&gt;                      &lt;CR&gt;</p>	<p>~nn@X-ROUTE                      &lt;direction_type1&gt;.&lt;port_type1&gt;.&lt;port_index1&gt;.&lt;signal_type1&gt;.&lt;index1&gt;.&lt;direction_type2&gt;.&lt;port_type2&gt;.&lt;port_index2&gt;.&lt;signal_type2&gt;.&lt;index2&gt;&lt;CR&gt;&lt;LF&gt;</p>	<p>The following attributes comprise the signal ID:                      &lt;direction_type&gt; – Direction of the port:                      IN – Input                      OUT – Output                      BOTH – Bi-directional (e.g. for RS-232)                      &lt;port_format&gt; – Type of signal on the port:                      HDMI                      HDBT                      ANALOG_AUDIO                      AMPLIFIED_AUDIO                      TOS                      SPDIF                      MIC                      RS-232                      IR                      USB_A                      USB_B                      USB_C                      &lt;port_index&gt; – The port number as printed on the front or rear panel                      &lt;signal_type&gt; – Signal ID attribute:                      VIDEO                      AUDIO                      ARC                      RS232                      IR                      USB                      AV_TEST_PATTERN                      &lt;index&gt; – Indicates a specific channel number when there are multiple channels of the same type</p>	<p>Get the routing status:                      #X-ROUTE?                      out.hdmi.5.video.1&lt;CR&gt;</p>

## Result and Error Codes

### Syntax

In case of an error, the device responds with an error message. The error message syntax:

- **~NN@ERR XXX<CR><LF>** – when general error, no specific command
- **~NN@CMD ERR XXX<CR><LF>** – for specific command
- **NN** – machine number of device, default = 01
- **XXX** – error code

### Error Codes

Error Name	Error Code	Description
P3K_NO_ERROR	0	No error
ERR_PROTOCOL_SYNTAX	1	Protocol syntax
ERR_COMMAND_NOT_AVAILABLE	2	Command not available
ERR_PARAMETER_OUT_OF_RANGE	3	Parameter out of range
ERR_UNAUTHORIZED_ACCESS	4	Unauthorized access
ERR_INTERNAL_FW_ERROR	5	Internal FW error
ERR_BUSY	6	Protocol busy
ERR_WRONG_CRC	7	Wrong CRC
ERR_TIMEDOUT	8	Timeout
ERR_RESERVED	9	(Reserved)
ERR_FW_NOT_ENOUGH_SPACE	10	Not enough space for data (firmware, FPGA...)
ERR_FS_NOT_ENOUGH_SPACE	11	Not enough space – file system
ERR_FS_FILE_NOT_EXISTS	12	File does not exist
ERR_FS_FILE_CANT_CREATED	13	File can't be created
ERR_FS_FILE_CANT_OPEN	14	File can't open
ERR_FEATURE_NOT_SUPPORTED	15	Feature is not supported
ERR_RESERVED_2	16	(Reserved)
ERR_RESERVED_3	17	(Reserved)
ERR_RESERVED_4	18	(Reserved)
ERR_RESERVED_5	19	(Reserved)
ERR_RESERVED_6	20	(Reserved)
ERR_PACKET_CRC	21	Packet CRC error
ERR_PACKET_MISSED	22	Packet number isn't expected (missing packet)
ERR_PACKET_SIZE	23	Packet size is wrong
ERR_RESERVED_7	24	(Reserved)
ERR_RESERVED_8	25	(Reserved)
ERR_RESERVED_9	26	(Reserved)
ERR_RESERVED_10	27	(Reserved)
ERR_RESERVED_11	28	(Reserved)
ERR_RESERVED_12	29	(Reserved)
ERR_EDID_CORRUPTED	30	EDID corrupted
ERR_NON_LISTED	31	Device specific errors
ERR_SAME_CRC	32	File has the same CRC – not changed
ERR_WRONG_MODE	33	Wrong operation mode
ERR_NOT_CONFIGURED	34	Device/chip was not initialized

# KDS JSON Configuration API

**AutoSwitch** – Defines regret time delay, for auto switching

<b>Function:</b>	AutoSwitch
<b>URL:</b>	/device/json
<b>Method:</b>	POST
<b>Content-Type</b>	application/json;
<b>Example:</b>	<pre>{   "path": "/switch/auto_switch_delays.json",   "info": {     "auto_switch_delays": {       "cable_plugin": 0,       "cable_unplug": 0,       "manual_override_inactive_signal": 10,       "power_off_upon_signal_loss": 900,       "signal_detection": 0,       "signal_loss_switching": 10     }   } }</pre>
<b>Comment:</b>	
<b>Default:</b>	

**AV Channel Map** – Defines mapping between Channels ID and OSD Channel Name

Used in OSD menu for easier video channel source selection.

	AV Channel Map
	/device/json
	POST
	application/json;
	<pre>{   "path": "/channel/channel_map.json",   "info": {     "channels_list": [       {         "id": 1,         "name": "ch_001"       },       {         "id": 2,         "name": "ch_002"       }     ]   } }</pre>
<b>Comment:</b>	
<b>Default:</b>	

**AV Signal** – Configure AV stream parameters

<b>Function:</b>	AV Signal
<b>URL:</b>	/device/json
<b>Method:</b>	POST
<b>Content-Type</b>	application/json;
<b>Example:</b>	<pre>{   "path": "/av_signal/av_signal.json",   "info": {     "av_signal": {       "audio_connection_guard_time_sec": 10,       "force_rgb": "on",       "frame_rate_percentage": 100,       "maximum_bit_rate": "best_effort",       "output_resolution": "pass_through"     }   } }</pre>
<b>Comment:</b>	
<b>Default:</b>	

**Display Management** – Configure automatic display sleep/awake timeouts

<b>Function:</b>	Display Management
<b>URL:</b>	/device/json
<b>Method:</b>	POST
<b>Content-Type</b>	application/json;
<b>Example:</b>	<pre>{   "path": "/display/display_sleep.json",   "info": {     "display_delays": {       "shutdown_delay_on_signal_loss_sec": 0,       "sleep_delay_on_signal_loss_sec": 0,       "wake_up_delay_on_signal_detection_sec": 0     }   } }</pre>
<b>Comment:</b>	
<b>Default:</b>	

**Display Management** – Sleep image

<b>Function:</b>	Display Management								
<b>URL:</b>	/upload/sleepimage								
<b>Method:</b>	POST								
<b>Content-Type</b>	multipart/form-data;								
<b>Example:</b>	<table border="1"> <thead> <tr> <th>Form Name</th> <th>Form Value Type</th> <th>Form Value</th> <th>Note</th> </tr> </thead> <tbody> <tr> <td>file</td> <td>octet-stream</td> <td>(binary)</td> <td></td> </tr> </tbody> </table>	Form Name	Form Value Type	Form Value	Note	file	octet-stream	(binary)	
Form Name	Form Value Type	Form Value	Note						
file	octet-stream	(binary)							
<b>Comment:</b>									
<b>Default:</b>									

**EDID Management** – EDID Repository

<b>Function:</b>	EDID Management								
<b>URL:</b>	/upload/edid								
<b>Method:</b>	POST								
<b>Content-Type</b>	multipart/form-data;								
<b>Example:</b>	<table border="1"> <thead> <tr> <th>Form Name</th> <th>Form Value Type</th> <th>Form Value</th> <th>Note</th> </tr> </thead> <tbody> <tr> <td>file</td> <td>octet-stream</td> <td>(binary)</td> <td></td> </tr> </tbody> </table>	Form Name	Form Value Type	Form Value	Note	file	octet-stream	(binary)	
Form Name	Form Value Type	Form Value	Note						
file	octet-stream	(binary)							
<b>Comment:</b>									
<b>Default:</b>									

**Version** – Store software and hardware version related information

<b>Function:</b>	Generic Header
<b>URL:</b>	/device/json
<b>Method:</b>	POST
<b>Content-Type</b>	application/json;
<b>Example:</b>	<pre>{   "path": "/version/version.json",   "info": {     "version": {       "device": {         "fw_version": "v0.6.3",         "hw_version": "v0.3",         "model": "KDS-DEC7"       },       "standby_version": "v0.6.1",       "upg_time": "01-01-1970,00:45:16"     }   } }</pre>
<b>Comment:</b>	this is a generic file name header appendix
<b>Default:</b>	

**Log File** – Directory to store latest log file

<b>Function:</b>	Log File
<b>URL:</b>	/log/log
<b>Method:</b>	GET
<b>Content-Type</b>	text/plain;
<b>Example:</b>	N/A
<b>Comment:</b>	
<b>Default:</b>	

**On Screen Display** – Defines how channels are presented in OSD Menu

<b>Function:</b>	On Screen Display
<b>URL:</b>	/device/json
<b>Method:</b>	POST
<b>Content-Type</b>	application/json;
<b>Example:</b>	<pre>{   "path": "osd/osd.json",   "info": {     "channel_menu": {       "font_size": "medium",       "max_channels": 999,       "max_channels_per_page": 5,       "position": "top_left",       "timeout_sec": 30     },     "device_info": {       "enabled": "off",       "timeout": 2     }   } }</pre>
<b>Comment:</b>	seconds
<b>Default:</b>	

**Overlay** – Overlay image file

<b>Function:</b>	Overlay								
<b>File Name:</b>	/upload/overlayimage								
<b>Method:</b>	POST								
<b>Content-Type</b>	multipart/form-data;								
<b>Example:</b>	<table border="1"> <thead> <tr> <th>Form Name</th> <th>Form Value Type</th> <th>Form Value</th> <th>Note</th> </tr> </thead> <tbody> <tr> <td>file</td> <td>octet-stream</td> <td>(binary)</td> <td></td> </tr> </tbody> </table>	Form Name	Form Value Type	Form Value	Note	file	octet-stream	(binary)	
Form Name	Form Value Type	Form Value	Note						
file	octet-stream	(binary)							
<b>Comment:</b>									
<b>Default:</b>									

**Overlay Configuration** – Text overlay

<b>Function:</b>	Overlay Configuration
<b>File Name:</b>	/device/json
<b>Method:</b>	POST
<b>Content-Type</b>	application/json;
<b>Example:</b>	<pre>{   "path": "/overlay/overlay1_setting.json",   "info": {     "general": {       "enable": "off",       "timeout": 2,       "transparency": 50     },     "objects": [       {         "type": "text",         "position": "top_center",         "caption": "Hello KRAMER",         "size": "small",         "color": "0xfffff"       }     ]   } }</pre>
<b>Comment:</b>	
<b>Default:</b>	

## Overlay Configuration – Image overlay

<b>Function:</b>	Overlay Configuration
<b>URL:</b>	/device/json
<b>Method:</b>	POST
<b>Content-Type</b>	application/json;
<b>Example:</b>	<pre>{   "path": "/overlay/overlay2_setting.json",   "info": {     "genral": {       "enable": "off",       "timeout": 2,       "transparency": 50     },     "objects": [       {         "type": "image",         "position": "top_center",         "width": 300,         "height": 300,         "path": "test.png"       }     ]   } }</pre>
<b>Comment:</b>	
<b>Default:</b>	

## Security/HTTPS – HTTPS certificates

<b>Function:</b>	Security																				
<b>URL:</b>	/security/https																				
<b>Method:</b>	POST																				
<b>Content-Type</b>	multipart/form-data;																				
<b>Example:</b>	<table border="1"> <thead> <tr> <th>Form Name</th> <th>Form Value Type</th> <th>Form Value</th> <th>Note</th> </tr> </thead> <tbody> <tr> <td>mode</td> <td>plaintext</td> <td>on</td> <td>[on, off]</td> </tr> <tr> <td>method</td> <td>plaintext</td> <td>in</td> <td>[in, out]</td> </tr> <tr> <td>certificate</td> <td>octet-stream</td> <td>(binary)</td> <td></td> </tr> <tr> <td>password</td> <td>plaintext</td> <td></td> <td>Base64 Encoded</td> </tr> </tbody> </table>	Form Name	Form Value Type	Form Value	Note	mode	plaintext	on	[on, off]	method	plaintext	in	[in, out]	certificate	octet-stream	(binary)		password	plaintext		Base64 Encoded
Form Name	Form Value Type	Form Value	Note																		
mode	plaintext	on	[on, off]																		
method	plaintext	in	[in, out]																		
certificate	octet-stream	(binary)																			
password	plaintext		Base64 Encoded																		
<b>Comment:</b>																					
<b>Default:</b>																					

## Security/IEEE 802.1X – Provide interface for managing security/IEEE 802.1X certificates

<b>Function:</b>	Security																																																												
<b>URL:</b>	/security/802_1x																																																												
<b>Method:</b>	POST																																																												
<b>Content-Type</b>	multipart/form-data;																																																												
<b>Example:</b>	<table border="1"> <thead> <tr> <th>Form Name</th> <th>Form Value Type</th> <th>Form Value</th> <th>Note</th> </tr> </thead> <tbody> <tr> <td>default_authentication</td> <td>plaintext</td> <td>eap_tls</td> <td></td> </tr> <tr> <td>tls_username</td> <td>plaintext</td> <td></td> <td></td> </tr> <tr> <td>tls_client_certificate</td> <td>octet-stream</td> <td>(binary)</td> <td></td> </tr> <tr> <td>tls_private_key</td> <td>octet-stream</td> <td>(binary)</td> <td></td> </tr> <tr> <td>tls_private_key_password</td> <td>plaintext</td> <td></td> <td>Base64 Encoded</td> </tr> <tr> <td>server_ca_mode</td> <td>plaintext</td> <td>on</td> <td>[on, off]</td> </tr> <tr> <td>server_ca_file</td> <td>octet_stream</td> <td>(binary)</td> <td></td> </tr> <tr> <td colspan="4">Or</td> </tr> <tr> <th>Form Name</th> <th>Form Value Type</th> <th>Form Value</th> <th>Note</th> </tr> <tr> <td>default_authentication</td> <td>plaintext</td> <td>eap_mschap</td> <td></td> </tr> <tr> <td>mschap_username</td> <td>plaintext</td> <td></td> <td></td> </tr> <tr> <td>mschap_password</td> <td>plaintext</td> <td></td> <td>Base64 Encoded</td> </tr> <tr> <td>server_ca_mode</td> <td>plaintext</td> <td>on</td> <td>[on, off]</td> </tr> <tr> <td>server_ca_file</td> <td>octet_stream</td> <td>(binary)</td> <td></td> </tr> </tbody> </table>	Form Name	Form Value Type	Form Value	Note	default_authentication	plaintext	eap_tls		tls_username	plaintext			tls_client_certificate	octet-stream	(binary)		tls_private_key	octet-stream	(binary)		tls_private_key_password	plaintext		Base64 Encoded	server_ca_mode	plaintext	on	[on, off]	server_ca_file	octet_stream	(binary)		Or				Form Name	Form Value Type	Form Value	Note	default_authentication	plaintext	eap_mschap		mschap_username	plaintext			mschap_password	plaintext		Base64 Encoded	server_ca_mode	plaintext	on	[on, off]	server_ca_file	octet_stream	(binary)	
Form Name	Form Value Type	Form Value	Note																																																										
default_authentication	plaintext	eap_tls																																																											
tls_username	plaintext																																																												
tls_client_certificate	octet-stream	(binary)																																																											
tls_private_key	octet-stream	(binary)																																																											
tls_private_key_password	plaintext		Base64 Encoded																																																										
server_ca_mode	plaintext	on	[on, off]																																																										
server_ca_file	octet_stream	(binary)																																																											
Or																																																													
Form Name	Form Value Type	Form Value	Note																																																										
default_authentication	plaintext	eap_mschap																																																											
mschap_username	plaintext																																																												
mschap_password	plaintext		Base64 Encoded																																																										
server_ca_mode	plaintext	on	[on, off]																																																										
server_ca_file	octet_stream	(binary)																																																											
<b>Comment:</b>																																																													
<b>Default:</b>																																																													

## USB and KM – KM and USB configuration

Enable switch between KM and generic USB modes, define KM request timeout and configure KM Roaming.

KM Roaming allows user to control up to 17 computers using just one USB keyboard and mouse. K/M switch automatically and seamlessly between computers once mouse cursor crosses screen boundary.

<b>Function:</b>	USB and KM
<b>URL:</b>	/device/json
<b>Method:</b>	POST
<b>Content-Type</b>	application/json;
<b>Example:</b>	<pre>{   "path": "/usb/km_usb.json",   "info": {     "usb_kvm_config": {       "km_roaming": [         {           "h": 0,           "mac": "00-15-25-08-01-11",           "v": 0         },         {           "h": 1,           "mac": "00-15-25-08-02-98",           "v": 0         }       ]     },     "kvm_col": 2,     "kvm_row": 1,     "kvm_timeout_sec": 10,     "kvm_usb_mode": "km"   } }</pre>
<b>Comment:</b>	<p>"kmoip_roaming_layout" is a list of "mac,x,y" pairs. You can specify up to 16 clients in total (no need to specify 0,0 position, so, 17 in total). Where:</p> <ul style="list-style-type: none"> <li>• mac: A 17 characters long Ethernet MAC address with hyphen of client.</li> <li>• x: horizontal layout position of the client. Value can be -16,-15,-14,...-1,0,1,2,...,16.</li> <li>• y: vertical layout position of the client. Value can be -16,-15,-14,...-1,0,1,2,...,16.</li> </ul>
<b>Default:</b>	



The warranty obligations of Kramer Electronics Inc. ("Kramer Electronics") for this product are limited to the terms set forth below:

### **What is Covered**

This limited warranty covers defects in materials and workmanship in this product.

### **What is Not Covered**

This limited warranty does not cover any damage, deterioration or malfunction resulting from any alteration, modification, improper or unreasonable use or maintenance, misuse, abuse, accident, neglect, exposure to excess moisture, fire, improper packing and shipping (such claims must be presented to the carrier), lightning, power surges, or other acts of nature. This limited warranty does not cover any damage, deterioration or malfunction resulting from the installation or removal of this product from any installation, any unauthorized tampering with this product, any repairs attempted by anyone unauthorized by Kramer Electronics to make such repairs, or any other cause which does not relate directly to a defect in materials and/or workmanship of this product. This limited warranty does not cover cartons, equipment enclosures, cables or accessories used in conjunction with this product.

Without limiting any other exclusion herein, Kramer Electronics does not warrant that the product covered hereby, including, without limitation, the technology and/or integrated circuit(s) included in the product, will not become obsolete or that such items are or will remain compatible with any other product or technology with which the product may be used.

### **How Long this Coverage Lasts**

The standard limited warranty for Kramer products is seven (7) years from the date of original purchase, with the following exceptions:

1. All Kramer VIA hardware products are covered by a standard three (3) year warranty for the VIA hardware and a standard three (3) year warranty for firmware and software updates; all Kramer VIA accessories, adapters, tags, and dongles are covered by a standard one (1) year warranty.
2. Kramer fiber optic cables, adapter-size fiber optic extenders, pluggable optical modules, active cables, cable retractors, ring mounted adapters, portable power chargers, Kramer speakers, and Kramer touch panels are covered by a standard one (1) year warranty. Kramer 7-inch touch panels purchased on or after April 1st, 2020 are covered by a standard two (2) year warranty.
3. All Kramer Calibre products, all Kramer Minicom digital signage products, all HighSecLabs products, all streaming, and all wireless products are covered by a standard three (3) year warranty.
4. All Sierra Video MultiViewers are covered by a standard five (5) year warranty.
5. Sierra switchers & control panels are covered by a standard seven (7) year warranty (excluding power supplies and fans that are covered for three (3) years).
6. K-Touch software is covered by a standard one (1) year warranty for software updates.
7. All Kramer passive cables are covered by a lifetime warranty.

### **Who is Covered**

Only the original purchaser of this product is covered under this limited warranty. This limited warranty is not transferable to subsequent purchasers or owners of this product.

### **What Kramer Electronics Will Do**

Kramer Electronics will, at its sole option, provide one of the following three remedies to whatever extent it shall deem necessary to satisfy a proper claim under this limited warranty:

1. Elect to repair or facilitate the repair of any defective parts within a reasonable period of time, free of any charge for the necessary parts and labor to complete the repair and restore this product to its proper operating condition. Kramer Electronics will also pay the shipping costs necessary to return this product once the repair is complete.
2. Replace this product with a direct replacement or with a similar product deemed by Kramer Electronics to perform substantially the same function as the original product. If a direct or similar replacement product is supplied, the original product's end warranty date remains unchanged and is transferred to the replacement product.
3. Issue a refund of the original purchase price less depreciation to be determined based on the age of the product at the time remedy is sought under this limited warranty.

### **What Kramer Electronics Will Not Do Under This Limited Warranty**

If this product is returned to Kramer Electronics or the authorized dealer from which it was purchased or any other party authorized to repair Kramer Electronics products, this product must be insured during shipment, with the insurance and shipping charges prepaid by you. If this product is returned uninsured, you assume all risks of loss or damage during shipment. Kramer Electronics will not be responsible for any costs related to the removal or re-installation of this product from or into any installation. Kramer Electronics will not be responsible for any costs related to any setting up this product, any adjustment of user controls or any programming required for a specific installation of this product.

### **How to Obtain a Remedy Under This Limited Warranty**

To obtain a remedy under this limited warranty, you must contact either the authorized Kramer Electronics reseller from whom you purchased this product or the Kramer Electronics office nearest you. For a list of authorized Kramer Electronics resellers and/or Kramer Electronics authorized service providers, visit our web site at [www.kramerav.com](http://www.kramerav.com) or contact the Kramer Electronics office nearest you.

In order to pursue any remedy under this limited warranty, you must possess an original, dated receipt as proof of purchase from an authorized Kramer Electronics reseller. If this product is returned under this limited warranty, a return authorization number, obtained from Kramer Electronics, will be required (RMA number). You may also be directed to an authorized reseller or a person authorized by Kramer Electronics to repair the product.

If it is decided that this product should be returned directly to Kramer Electronics, this product should be properly packed, preferably in the original carton, for shipping. Cartons not bearing a return authorization number will be refused.

### **Limitation of Liability**

THE MAXIMUM LIABILITY OF KRAMER ELECTRONICS UNDER THIS LIMITED WARRANTY SHALL NOT EXCEED THE ACTUAL PURCHASE PRICE PAID FOR THE PRODUCT. TO THE MAXIMUM EXTENT PERMITTED BY LAW, KRAMER ELECTRONICS IS NOT RESPONSIBLE FOR DIRECT, SPECIAL, INCIDENTAL OR CONSEQUENTIAL DAMAGES RESULTING FROM ANY BREACH OF WARRANTY OR CONDITION, OR UNDER ANY OTHER LEGAL THEORY. Some countries, districts or states do not allow the exclusion or limitation of relief, special, incidental, consequential or indirect damages, or the limitation of liability to specified amounts, so the above limitations or exclusions may not apply to you.

### **Exclusive Remedy**

TO THE MAXIMUM EXTENT PERMITTED BY LAW, THIS LIMITED WARRANTY AND THE REMEDIES SET FORTH ABOVE ARE EXCLUSIVE AND IN LIEU OF ALL OTHER WARRANTIES, REMEDIES AND CONDITIONS, WHETHER ORAL OR WRITTEN, EXPRESS OR IMPLIED. TO THE MAXIMUM EXTENT PERMITTED BY LAW, KRAMER ELECTRONICS SPECIFICALLY DISCLAIMS ANY AND ALL IMPLIED WARRANTIES, INCLUDING, WITHOUT LIMITATION, WARRANTIES OF MERCHANTABILITY AND FITNESS FOR A PARTICULAR PURPOSE. IF KRAMER ELECTRONICS CANNOT LAWFULLY DISCLAIM OR EXCLUDE IMPLIED WARRANTIES UNDER APPLICABLE LAW, THEN ALL IMPLIED WARRANTIES COVERING THIS PRODUCT, INCLUDING WARRANTIES OF MERCHANTABILITY AND FITNESS FOR A PARTICULAR PURPOSE, SHALL APPLY TO THIS PRODUCT AS PROVIDED UNDER APPLICABLE LAW. IF ANY PRODUCT TO WHICH THIS LIMITED WARRANTY APPLIES IS A "CONSUMER PRODUCT" UNDER THE MAGNUSON-MOSS WARRANTY ACT (15 U.S.C.A. §2301, ET SEQ.) OR OTHER APPLICABLE LAW, THE FOREGOING DISCLAIMER OF IMPLIED WARRANTIES SHALL NOT APPLY TO YOU, AND ALL IMPLIED WARRANTIES ON THIS PRODUCT, INCLUDING WARRANTIES OF MERCHANTABILITY AND FITNESS FOR THE PARTICULAR PURPOSE, SHALL APPLY AS PROVIDED UNDER APPLICABLE LAW.

### **Other Conditions**

This limited warranty gives you specific legal rights, and you may have other rights which vary from country to country or state to state.

This limited warranty is void if (i) the label bearing the serial number of this product has been removed or defaced, (ii) the product is not distributed by Kramer Electronics or (iii) this product is not purchased from an authorized Kramer Electronics reseller. If you are unsure whether a reseller is an authorized Kramer Electronics reseller, visit our web site at [www.kramerav.com](http://www.kramerav.com) or contact a Kramer Electronics office from the list at the end of this document.

Your rights under this limited warranty are not diminished if you do not complete and return the product registration form or complete and submit the online product registration form. Kramer Electronics thanks you for purchasing a Kramer Electronics product. We hope it will give you years of satisfaction.



P/N:



2900-301543

Rev:



1



## SAFETY WARNING

Disconnect the unit from the power supply before opening and servicing

For the latest information on our products and a list of Kramer distributors, visit our website where updates to this user manual may be found.

We welcome your questions, comments, and feedback.

The terms HDMI, HDMI High-Definition Multimedia Interface, and the HDMI Logo are trademarks or registered trademarks of HDMI Licensing Administrator, Inc. All brand names, product names, and trademarks are the property of their respective owners.