

2386 Flat-Front Bi-Radial Horn

Professional Series

Key Features:

- ▶ 40° x 20° nominal dispersion
- ▶ Uniform horizontal on- and off-axis frequency response
- ▶ Precise horizontal and vertical pattern control
- ▶ Full horn loading to 400 Hz
- ▶ Flat front, compact size
- ▶ Lightweight construction
- ▶ 49 mm (2 in) throat entry



The JBL 2386 Flat-Front Bi-Radial™ horn¹ is designed for flush cabinet mounting or compact cluster applications. The 2386 has a nominal coverage pattern of 40° horizontal by 20° vertical. It provides uniform on-and-off-axis frequency response from 1 kHz to beyond 16 kHz in the horizontal plane and 2.5 kHz to 16 kHz in the vertical plane, with constant directivity above 2 kHz. The horn's small vertical mount dimension (just slightly larger than the compression driver used to drive the horn) allows very compact single and multiple horn/driver systems to be put together. Should vertical pattern control be required below 2.5 kHz, two or more horns may be stacked vertically to restore full Bi-Radial performance.

The exceptionally consistent horizontal dispersion eliminates the midrange narrowing and high frequency beaming problems typically associated with conventional horn designs. Additionally, the highly predictable performance of the 2386 greatly simplifies cluster design. The need for horn overlapping is minimized and lobing and comb filter effects are virtually eliminated.

Computer-aided design techniques were used to derive the horn contours in the horizontal and vertical planes. Utilizing sidewall contours based on a polynomial power series formula, the horn design yields smooth response, low distortion, and

even coverage. This design avoids the performance disadvantages of horns that feature sharp flare transitions and flat sidewalls. The Bi-Radial™ compound flare configuration provides constant coverage over defined, solid angles. To ensure lightweight, superior strength, and freedom from resonances, the horn bell is constructed of injection-molded, reinforced, solid polyurethane.

The 2386 will accept the 49 mm (2 in) diameter throat 2441, 2445, or 2482 compression driver. With the addition of the 2327 adapter, the horn will also accept the 25 mm (1 in) throat 2425 driver.

¹U.S. Patent No. 4,308,932. Foreign patents pending

▶ 2386 Flat-Front Bi-Radial Horn

Specifications:

Nominal Coverage:	40° Horizontal x 20° Vertical
Throw:	Long
Horizontal Coverage:	
Angle Degrees (-6 dB):	45 (+12 -14)
Average Range:	1 kHz-16 kHz
Vertical Coverage:	
Angle Degrees (-6 dB):	25 (+11 -10)
Average Range:	2.5 kHz-16 kHz
Directivity Factor (Q):	44.9 (+38.2 -18.1)
Directivity Index (Di):	16.5 dB (+2.7 -2.2)
Average Range:	2 kHz-16 kHz
Throat Diameter:	49 mm (2 in)
Usable Low Frequency Limit:	350 Hz
Minimum Recommended Crossover Frequency:	400 Hz
Axial Pressure Sensitivity:	116 dB SPL, 1W @ 1 m
Construction:	Injection-molded reinforced high-density solid polyurethane [nominal 10 mm (0.38 in) wall thickness]
Color:	Black
Overall Dimensions:	
Mouth Height:	279 mm (11 in)
Mouth Width:	445 mm (17.5 in)
Length:	359 mm (14-9/16 in)
Mounting Dimensions:	
Rear Height:	235 mm (9 1/4 in)
Rear Width:	400 mm (15 7/8 in)
Baffle Cutout Required: (Front mounting only)	
Height:	238 mm (9 3/8 in)
Width:	403 mm (15 7/8 in)
Net Weight:	5.5 kg (12 lb)
Shipping Weight:	7.3 kg (16 lb)

¹ Measured on axis in the far field with 1 watt (4.0 VRMS, 16 ohms) input and referenced to 1 meter distance using the inverse square law. Listed sound pressure represents an average from 1 kHz to 4 kHz using the JBL Model 2441, 2445 or 2482 driver.

Beamwidth vs Frequency

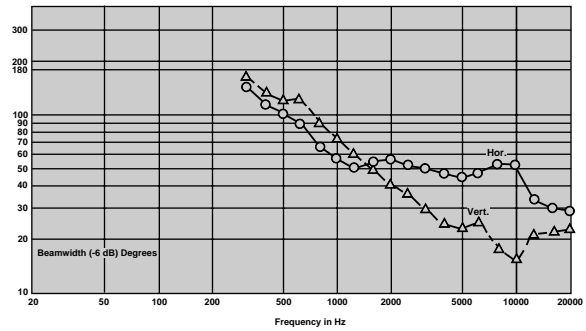

Directivity vs Frequency

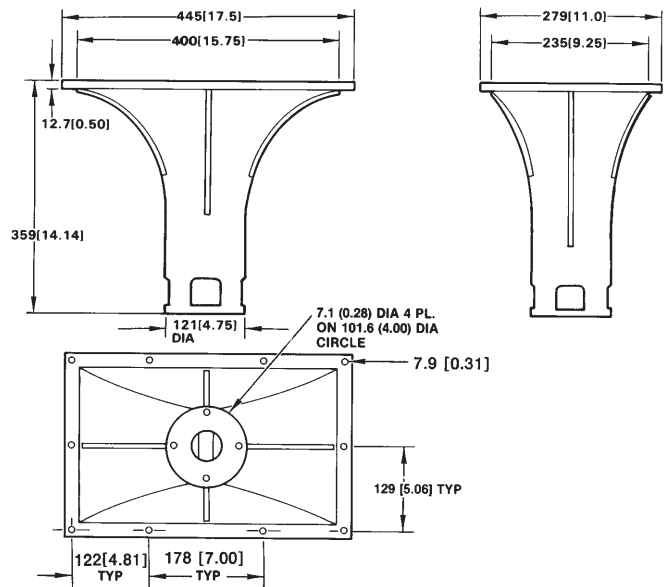
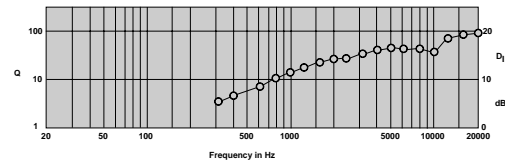

Frontal Isobar Contours

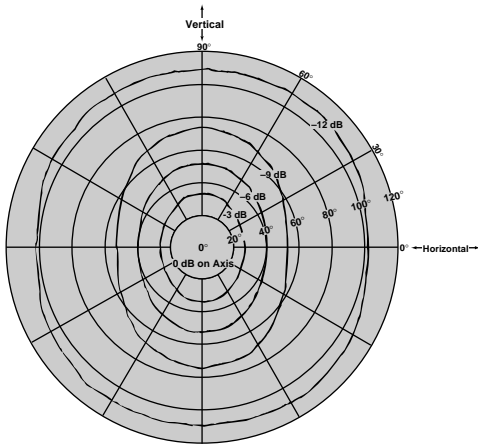

500 Hz octave bandwidth constant sound pressure contours of 0 to -18 dB in steps of -3 dB. The contours are plotted on polar grid lines with on axis being the center of the plot. The data was gathered by taking an octave polar plot at all oblique angles from 0° (horizontal) to 90° (vertical) in steps of 15°. Same test conditions as horizontal polar response.

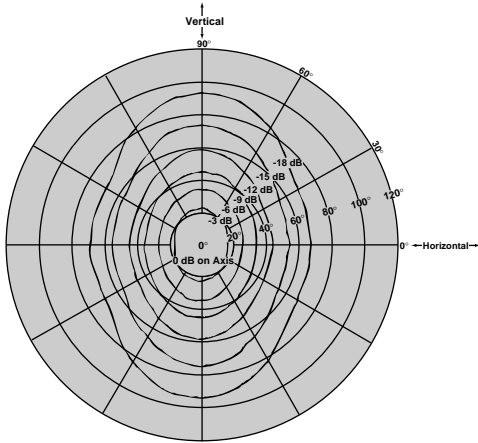

1 kHz octave bandwidth constant sound pressure contours. Same conditions as 500 Hz contours.

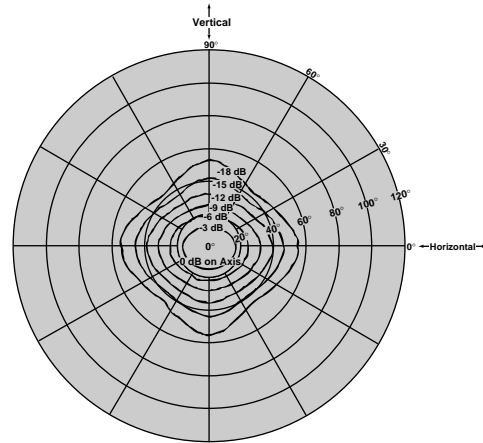

2 kHz octave bandwidth constant sound pressure contours. Same conditions as 500 Hz contours.

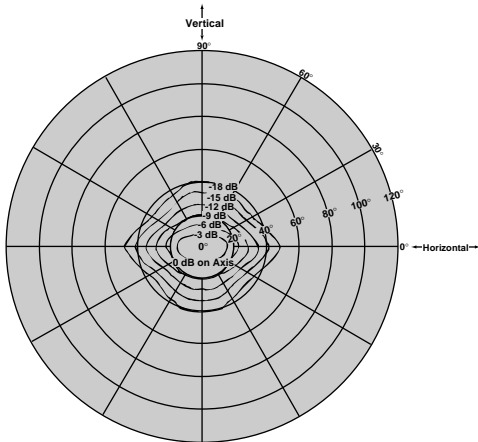

4 kHz octave bandwidth constant sound pressure contours. Same conditions as 500 Hz contours.

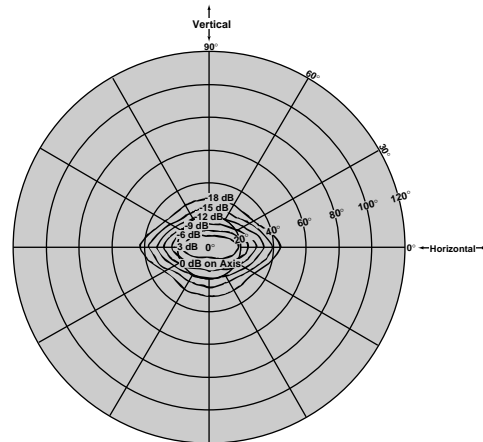

8 kHz octave bandwidth constant sound pressure contours. Same conditions as 500 Hz contours.

▶ 2386 Flat-Front Bi-Radial Horn

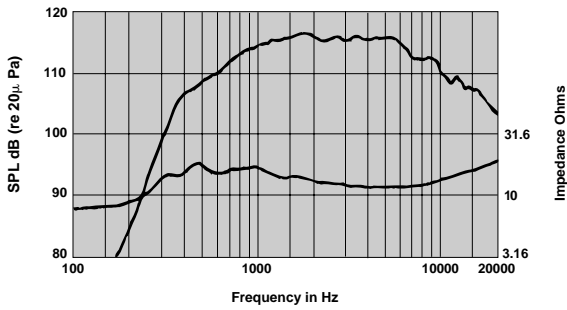

Frequency response and impedance. Frequency response of the 2386, measured on axis at a distance of 1 meter with 1 watt (4.0 V RMS) applied to JBL Model 2445 compression driver, in a reflection-free environment, with impedance vs. frequency curve.

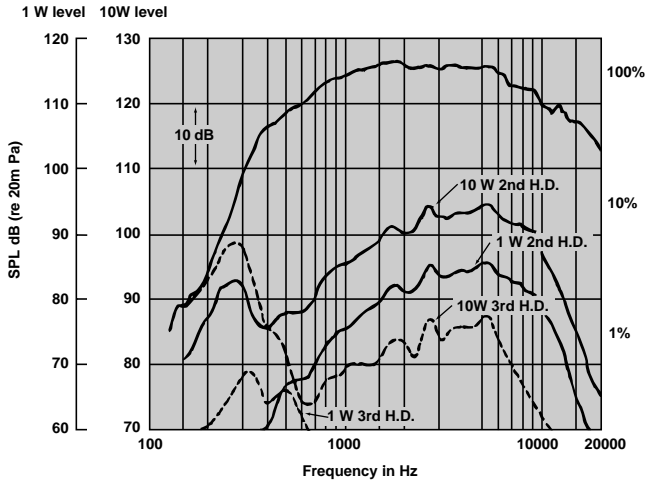

Harmonic distortion. Second and third harmonic distortion curves of the 2386 with 1 watt (4.0 V RMS) and 10 watts (12.65 V RMS) applied to the JBL Model 2445 compression driver. Measured on axis at a distance of 1 meter in a reflection-free environment.

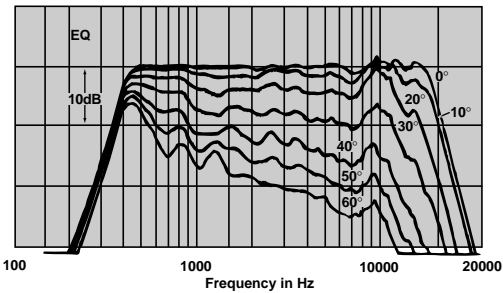
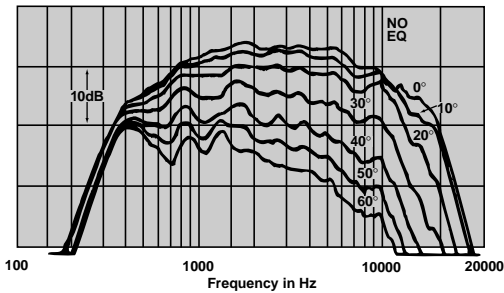

Horizontal off-axis response. Horizontal off-axis response taken at 10 degree intervals out to 60° off axis. Both normalized (equalized flat on-axis) and unequalized responses are shown.

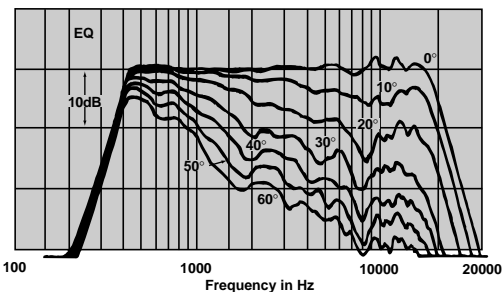
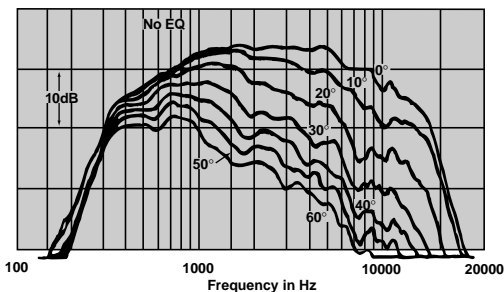

Vertical off-axis response. Vertical off-axis response taken at 10° intervals out to 60° off axis. Both normalized (equalized flat on-axis) and unequalized responses are shown.



JBL Professional
8500 Balboa Boulevard, P.O. Box 2200
Northridge, California 91329 U.S.A.

■ A Harman International Company

SS 2386
CRP 5M
12/97