



HD Mate Scaler

USER MANUAL

www.gefen.com

ASKING FOR ASSISTANCE

Technical Support:

Telephone (818) 772-9100
(800) 545-6900

Fax (818) 772-9120

Technical Support Hours:

8:00 AM to 5:00 PM Monday through Friday PST

Write To:

Gefen Inc.
c/o Customer Service
20600 Nordhoff St
Chatsworth CA 91311

www.gefen.com
support@gefen.com

Notice

Gefen Inc. reserves the right to make changes in the hardware, packaging and any accompanying documentation without prior written notice.

The HD Mate Scaler is a trademark of Gefen Inc.

TABLE OF CONTENTS

- 1** Introduction / Operation Notes
- 2** Features
- 3** Panel Layout
- 4** Operation Controls and Functions
- 5** Operation Controls and Functions
- 6** Operation Controls and Functions / Color Settings
- 7** Output Settings / OSD Adjustment / Information
- 8** Using the HD Mate Scaler
- 9** RMT-SR-IR Installation
- 10** Pin Configuration
- 11** Specifications
- 12** Terminology
- 13** Warranty

INTRODUCTION

Thank you for purchasing the HD Mate Scaler.

The HD Mate Scaler switches two Component sources and one DVI source, all with digital TOSlink and analog audio inputs.

The Gefen HD Mate Scaler allows you to upscale and switch your standard definition or high definition component sources to resolutions up to 1080p. Anything from set-top boxes, DVD players to the next generation of gaming consoles including the Xbox 360 and PS3 can be plugged into the HD Mate Scaler.

Note: The switching is done by using the RMT-SR-IR remote control. Any HDTV with HDMI inputs can be connected to the DVI output of the HD Mate by using a DVI to HDMI adapter, if the cable being used is HDMI.

OPERATION NOTES

READ THESE NOTES BEFORE INSTALLING OR OPERATING THE HD MATE

- The HD Mate works with all DVI and HDMI displays.
- The HD Mate is fully HDCP compliant.

FEATURES

Features

- Both digital and analog inputs are format converted and pixel re-scaled through the HD Mate Scaler. It outputs a large range of formats and resolutions that will easily match the native resolution/ format of your display to ensure highest picture quality.
- DVI/HDCP compliant input: Operates up to 165Mhz (Up to UXGA @60Hz)
- Supports digital HD output up to 1080p.
- Integrated 8-bit triple-ADC/PLL.
- Integrated DVI/HDCP compliant receiver.
- Dual high quality scaling engines.
- Dual 3-D motion video adaptive de-interlacers with smooth low-angle edge.
- Automatic 3:2 pull-down & 2:2 pull-down detection and recovery.
- High performance frame rate conversion engine.
- Operates through on-screen OSD menu control and remote control.

Includes:

- (1) HD Mate Scaler
- (1) 6 ft DVI cable (M-M)
- (1) 5V Power Supply
- (1) IR Remote control
- (1) User's Manual



PANEL LAYOUT

Mini Audio
Jack Inputs

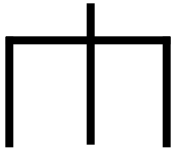

Component 2 Input

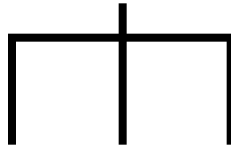

Component 1 Input

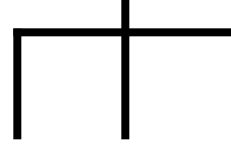

Optical
Input 2



Optical
Input 1

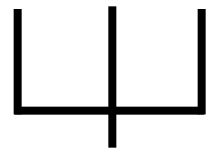

Analog Audio
Outputs

Optical
Output



DVI Output



Optical
Input 3



DVI Input



Connects 5V
Power Supply



IR Eye

OPERATION CONTROLS AND FUNCTIONS

The HD Mate accepts two component and one DVI inputs with audio inputs on each. The formats supported by these inputs are as follows:

COMPONENT	YPbPr	480p @ 50/60Hz 576p @ 50Hz 720p @ 50/60Hz 1080i @ 50/60Hz 1080p @ 50//60Hz
	YCbCr	480i @ 60Hz 576i @ 50Hz

PC INPUT:	RGBHV	VGA/SVGA/XGA/SXGA/UXGA/WXGA/WSXGA/WUXGA VGA @ (60//72/75/85)/SVGA @ (56/60/72/75/85) XGA @ (60/70/75/85)/SXGA @ (60/75/85)/UXGA @ 60/WXGA @ 60(1280x800)/WSXGA @ 60(1680x1050)/ WUXGA @ 60(1920x1200)/1360x768
DVI INPUT:	Digital	VGA @ (60/72/75/85)/SVGA @ (56/60/72/75/85)/ XGA @ (60/70/75/85)/SXGA @ (60/75/85)/UXGA @ 60/ WXGA @ (1280x800)/WSXGA @ 60(1680x1050)/ WUXGA @ 60(1920x1200)/1360x768

When connecting to a VGA PC source use a 15-pin D-sub cable to connect the output of a PC to the DVI-I input connector of the HD Mate via a VGA to DVI.

When connecting to a component source (either SD or HD resolution) use a 3RCA to 3RCA cable to connect the YPbPr or YCbCr output of a DVD or Set Top Box to the y-Cb/Pb-Cr/Pr input connector of the HD Mate.

When connecting to an HDMI source, use an HDMI to DVI cable to connect the HDMI output of a STB or DVD to the DVI input connector of the HD Mate.

When connecting to a DVI source, use a DVI cable to connect to the DVI output of a DVI source, such as a DVD or PC, to the DVI input of the HD Mate.

The HD Mate can automatically detect the input resolution of all three inputs.

OPERATION CONTROLS AND FUNCTIONS

After you power on the unit, press the menu button and it will bring up the main menu as follows:

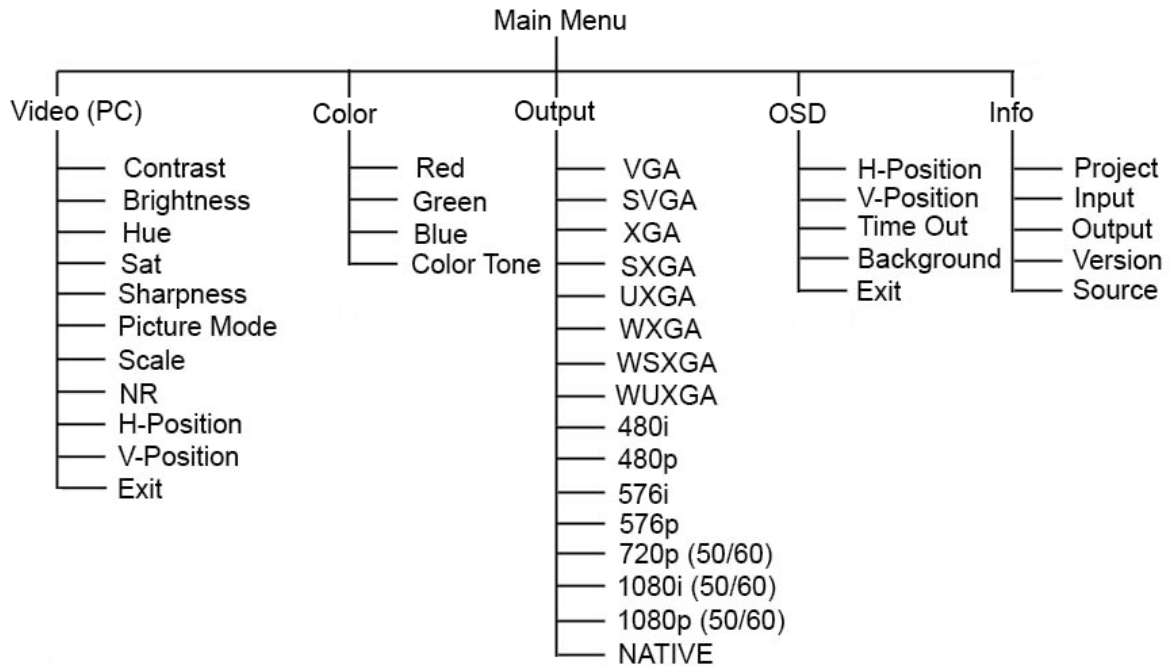

Video (or PC): When Video is selected, a sub menu as shown below, will come up.

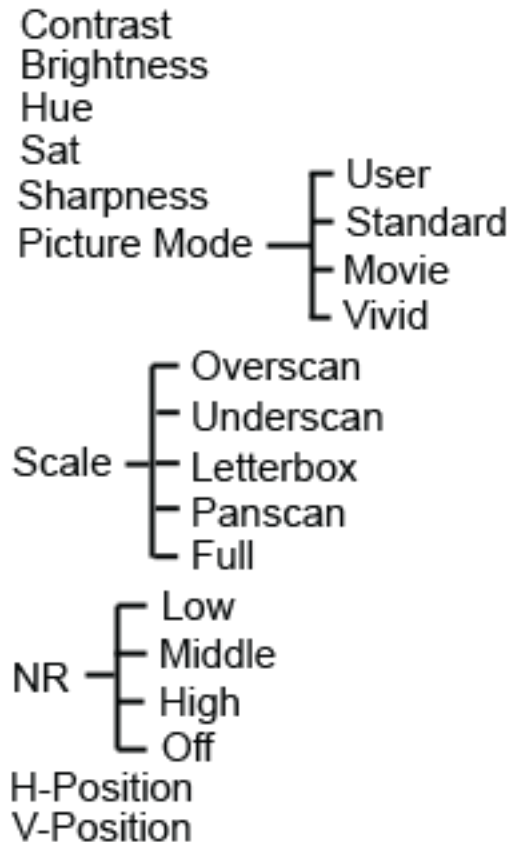

OPERATION CONTROLS AND FUNCTIONS

Picture mode: There are four picture modes for customers to choose from.

User: Select to adjust to your favorite setting and store it.

Standard: Standard factory default setting for optimal display in a normal environment.

Vivid: High saturation picture for optimal display in a bright room.

Movie: Picture for comfortable low brightness display in a dark room.

Scale: Select overscan when input source is SD or HD video to ensure there will be no black band around the screen border. Select underscan when input source is PC signal to ensure full picture content will fall within the screen border.

Noise Reduction (NR): This function only works when the input source is analog RGB or component, It will not work for the DVI input. There are four settings for Noise Reduction-Off, Low, Middle, and High. The Noise Reduction will remove the noise that results from the analog to digital conversion and digital scaling process.

H & V position: Adjust for the best horizontal and vertical position of the picture on the screen.

COLOR SETTINGS

User: Select to adjust to your favorite color temperature setting.

Normal: Normal color tone setting where white is pure white.

Warm: Warm color tone makes white a little reddish.

Cool: Cool color tone makes white a little bluish.

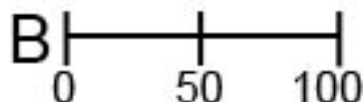
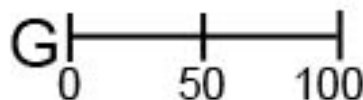
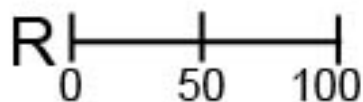

Value of normal setting

OUTPUT SETTINGS

Output: The HD Mate can output a wide variety of PC and HD resolutions as follows.

VGA (up to 100MH)	DVI/HDMI (up to 165 MH)	Resolution	i/p*	Format
480i	480i	720x480	i	RGBHV
480p	480p	720x480	p	RGBHV
576i	576i	720x576	i	RGBHV
576p	576p	720x576	p	RGBHV
720p @ (50/60)	720p @ (50/60)	1280x720	p	RGBHV
1080i @ (25/30)	1080i @ (25/30)	1920x1080	i	RGBHV
1080p @ (50/60)	1080p @ (50/60)	1920x1080	p	RGBHV
VGA @ 60	VGA @ 60	640x480	p	RGBHV
SVGA @ 60	SVGA @ 60	800x600	p	RGBHV
XGA @ 60	XGA @ 60	1024x768	p	RGBHV
SXGA @ 60	SXGA @ 60	1280x1024	p	RGBHV
UXGA	UXGA	1600x1200	p	RGBHV
WXGA @ 60	WXGA @ 60	1280x800	p	RGBHV
WSXGA @ 60	WSXGA @ 60	1680x1050	p	RGBHV
WUXGA @ 60	WUXGA @ 60	1920x1200	p	RGBHV

* i: interlaced p; progressive

Native: When selected, the HD Mate will automatically adjust its output timing to match the native timing of the display.

OSD ADJUSTMENT

H. Position: Adjust the horizontal position of the OSD graphic.

V. Position: Adjust the vertical position of the OSD graphic.

Time out: Set a pre-determined Time to turn off OSD menu on the screen.

Background: To select transparent or solid background of OSD graphic.

INFORMATION

Project: Show product model number.

Input: Show input resolution i.e. XGA.

Output: Show output resolution i.e. 720p.

Date: Show date of firmware version.

USING THE HD MATE SCALER

- 1 Connect all the sources to the DVI and/or Component Inputs to the HD Mate.
- 2 Connect the HDMI/DVI/VGA display to the DVI output, with the proper cable and/or adapter, on the HD Mate.
- 3 Connect the 5VDC power supply to the HD Mate
- 4 Controlling the HD Mate using the RMT-SR-IR:

By Pressing ...	Does...
input select	changes between sources
output select	changes between display outputs
power	power the scaler on/off
menu	bring up the on screen menu
exit	allows user to exit the on screen menu
up,down,left,right	allows user to navigate through menu
ok (enter)	allows user to confirm their selection
reset	press this button to reset the unit's firmware setting to the factory default value.
auto adjust	press this button to optimize the position of the picture (picture centering) on the screen.

***Note for computers connected to the HD Mate** - When your computer boots up, it looks for an EDID (extended display identification data) from the display to tell it what monitor is connected and what resolution to output. During boot up of the computer you should have the DVI input selected so that the computer gets the EDID of the display that is selected.

This step can also be eliminated by using a DVI Detective.

RMT-SR-IR INSTALLATION

1. Remove battery cover from the back of the RMT-SR-IR remote.
2. Verify that dip switches 1 & 2 are in the down (OFF) position.
3. Insert the battery, hold the battery so that you can see the positive side facing up. The side that is not marked must be facing down.
4. Test the RMT-SR-IR remote by pressing ONLY one button at a time. The indicator light on the remote will flash once each time you press a button. **WARNING:** Do not press multiple buttons simultaneously and do NOT press buttons rapidly. These actions will cause the remote to reset and steps 1-4 will have to be repeated.

Note* The RMT-SR-IR ships with two batteries. One battery is required for operation, the second battery is complimentary.



PIN CONFIGURATION

DVI-I Input Pin Assignment

DVI-Digital(DVI-D): Supports digital-only connections between the host computer and display. This interface is designed for a 12 or 24-pin connections to enable single or dual-link mod activation.

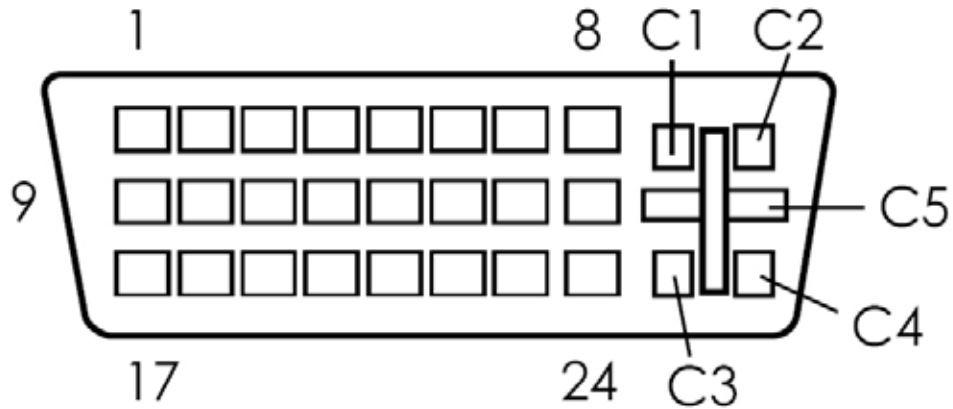

Pin	Signal Assignment	Pin	Signal Assignment	Pin	Signal Assignment
1	T.M.D.S. Data 2 -	9	T.M.D.S. Data 1 -	17	T.M.D.S. Data 0 -
2	T.M.D.S. Data 2 +	10	T.M.D.S. Data 1 +	18	T.M.D.S. Data 0 +
3	T.M.D.S. Data 2 Shield	11	T.M.D.S. Data 1 Shield	19	T.M.D.S. Data 0 Shield
4	N.C.	12	N.C.	20	N.C.
5	N.C.	13	N.C.	21	N.C.
6	DDC Clock	14	+5V Power	22	T.M.D.S. Clock Shield
7	DDC Data	15	Ground (for +5V)	23	T.M.D.S. Clock +
8	No Connect	16	Hot Plug Detect	24	T.M.D.S. Clock -
C1	N.C.	C3	N.C.	C3	N.C.
C2	N.C.	C4	N.C.		

SPECIFICATIONS

Digital Video Amplifier Bandwidth.....	1.65 Gbps
Component Video Bandwidth.....	350 Mhz
Input DDC Signal.....	5 volts p-p (TTL)
Input Video Signal.....	1.2 volts p-p
Single Link Range.....	1080p/1920 x 1200
Input/Output DVI Connector.....	DVI-I (29 pin) female
Component Video Connector.....	3 RCA
Digital Audio Connector.....	Optical TOSlink
Analog Audio Connector.....	mini-phone stereo 3.5mm
Power Supply.....	5V DC
Power Consumption.....	12 watts (max)
Dimensions.....	6.875"W x 2.125"H x 6.875"D
Shipping Weight.....	6 lbs.