



DD-65

YDD-60

Digital Percussion

Owner's Manual



EN

SPECIAL MESSAGE SECTION

This product utilizes batteries or an external power supply (adapter). DO NOT connect this product to any power supply or adapter other than one described in the manual, on the name plate, or specifically recommended by Yamaha.

This product should be used only with the components supplied or; a cart, rack, or stand that is recommended by Yamaha. If a cart, etc., is used, please observe all safety markings and instructions that accompany the accessory product.

SPECIFICATIONS SUBJECT TO CHANGE:

The information contained in this manual is believed to be correct at the time of printing. However, Yamaha reserves the right to change or modify any of the specifications without notice or obligation to update existing units.

This product, either alone or in combination with an amplifier and headphones or speaker/s, may be capable of producing sound levels that could cause permanent hearing loss. DO NOT operate for long periods of time at a high volume level or at a level that is uncomfortable. If you experience any hearing loss or ringing in the ears, you should consult an audiologist.

IMPORTANT: The louder the sound, the shorter the time period before damage occurs.

NOTICE:

Service charges incurred due to a lack of knowledge relating to how a function or effect works (when the unit is operating as designed) are not covered by the manufacturer's warranty, and are therefore the owners responsibility. Please study this manual carefully and consult your dealer before requesting service.

ENVIRONMENTAL ISSUES:

Yamaha strives to produce products that are both user safe and environmentally friendly. We sincerely believe that our products and the production methods used to produce them, meet these goals. In keeping with both the letter and the spirit of the law, we want you to be aware of the following:

Battery Notice:

This product MAY contain a small non-rechargeable battery which (if applicable) is soldered in place. The average life span of this type of battery is approximately five years. When replacement becomes necessary, contact a qualified service representative to perform the replacement.

This product may also use "household" type batteries. Some of these may be rechargeable. Make sure that the battery being charged is a rechargeable type and that the charger is intended for the battery being charged.

When installing batteries, do not mix batteries with new, or with batteries of a different type. Batteries MUST be installed correctly. Mismatches or incorrect installation may result in overheating and battery case rupture.

Warning:

Do not attempt to disassemble, or incinerate any battery. Keep all batteries away from children. Dispose of used batteries promptly and as regulated by the laws in your area. Note: Check with any retailer of household type batteries in your area for battery disposal information.

Disposal Notice:

Should this product become damaged beyond repair, or for some reason its useful life is considered to be at an end, please observe all local, state, and federal regulations that relate to the disposal of products that contain lead, batteries, plastics, etc. If your dealer is unable to assist you, please contact Yamaha directly.

NAME PLATE LOCATION:

The name plate is located on the bottom of the product. The model number, serial number, power requirements, etc., are located on this plate. You should record the model number, serial number, and the date of purchase in the spaces provided below and retain this manual as a permanent record of your purchase.

Model

Serial No.

Purchase Date

PLEASE KEEP THIS MANUAL

92-BP (bottom)

FCC INFORMATION (U.S.A.)

1. IMPORTANT NOTICE: DO NOT MODIFY THIS UNIT!

This product, when installed as indicated in the instructions contained in this manual, meets FCC requirements. Modifications not expressly approved by Yamaha may void your authority, granted by the FCC, to use the product.

2. IMPORTANT:

When connecting this product to accessories and/or another product use only high quality shielded cables. Cable/s supplied with this product MUST be used. Follow all installation instructions. Failure to follow instructions could void your FCC authorization to use this product in the USA.

3. NOTE:

This product has been tested and found to comply with the requirements listed in FCC Regulations, Part 15 for Class "B" digital devices. Compliance with these requirements provides a reasonable level of assurance that your use of this product in a residential environment will not result in harmful interference with other electronic devices. This equipment generates/uses radio frequencies and, if not installed and used according to the instructions found in the users manual, may cause interference harmful to the operation of other electronic devices. Compliance with FCC regulations does

not guarantee that interference will not occur in all installations. If this product is found to be the source of interference, which can be determined by turning the unit "OFF" and "ON", please try to eliminate the problem by using one of the following measures:

Relocate either this product or the device that is being affected by the interference.

Utilize power outlets that are on different branch (circuit breaker or fuse) circuits or install AC line filter/s.

In the case of radio or TV interference, relocate/reorient the antenna. If the antenna lead-in is 300 ohm ribbon lead, change the lead-in to co-axial type cable.

If these corrective measures do not produce satisfactory results, please contact the local retailer authorized to distribute this type of product. If you can not locate the appropriate retailer, please contact Yamaha Corporation of America, Electronic Service Division, 6600 Orangethorpe Ave, Buena Park, CA90620

The above statements apply ONLY to those products distributed by Yamaha Corporation of America or its subsidiaries.

* This applies only to products distributed by YAMAHA CORPORATION OF AMERICA.

(class B)

OBSERVERA!

Apparaten kopplas inte ur växelströmskällan (nätet) så länge som den är ansluten till vägguttaget, även om själva apparaten har stängts av.

ADVARSEL: Netspændingen til dette apparat er IKKE afbrudt, så længe netledningen sidder i en stikkontakt, som er t endt — også selvom der er slukket på apparatets afbryder.

VAROITUS: Laitteen toisiopiiriin kytketty käyttökytkin ei irroita koko laitetta verkosta.

(standby)

Entsorgung leerer Batterien (nur innerhalb Deutschlands)

Leisten Sie einen Beitrag zum Umweltschutz. Verbrauchte Batterien oder Akkumulatoren dürfen nicht in den Hausmüll. Sie können bei einer Sammelstelle für Altbatterien bzw. Sondermüll abgegeben werden. Informieren Sie sich bei Ihrer Kommune.

(battery)

IMPORTANT NOTICE FOR THE UNITED KINGDOM Connecting the Plug and Cord

IMPORTANT. The wires in this mains lead are coloured in accordance with the following code:

BLUE : NEUTRAL

BROWN : LIVE

As the colours of the wires in the mains lead of this apparatus may not correspond with the coloured markings identifying the terminals in your plug proceed as follows:

The wire which is coloured BLUE must be connected to the terminal which is marked with the letter N or coloured BLACK.

The wire which is coloured BROWN must be connected to the terminal which is marked with the letter L or coloured RED.

Making sure that neither core is connected to the earth terminal of the three pin plug.

• This applies only to products distributed by Yamaha-Kemble Music (U.K.) Ltd.

(2 wires)

PRECAUTIONS

PLEASE READ CAREFULLY BEFORE PROCEEDING

* Please keep this manual in a safe place for future reference.

WARNING

Always follow the basic precautions listed below to avoid the possibility of serious injury or even death from electrical shock, short-circuiting, damages, fire or other hazards. These precautions include, but are not limited to, the following:

Power supply/AC power adaptor

- Only use the voltage specified as correct for the instrument. The required voltage is printed on the name plate of the instrument.
- Use the specified adaptor (PA-5D, PA-150 or an equivalent recommended by Yamaha) only. Using the wrong adaptor can result in damage to the instrument or overheating.
- Check the electric plug periodically and remove any dirt or dust which may have accumulated on it.
- Do not place the AC adaptor cord near heat sources such as heaters or radiators, and do not excessively bend or otherwise damage the cord, place heavy objects on it, or place it in a position where anyone could walk on, trip over, or roll anything over it.

Do not open

- Do not open the instrument or attempt to disassemble the internal parts or modify them in any way. The instrument contains no user-serviceable parts. If it should appear to be malfunctioning, discontinue use immediately and have it inspected by qualified Yamaha service personnel.

Water warning

- Do not expose the instrument to rain, use it near water or in damp or wet conditions, or place containers on it containing liquids which might spill into any openings. If any liquid such as water seeps into the instrument, turn off the power immediately and unplug the power cord from the AC outlet. Then have the instrument inspected by qualified Yamaha service personnel.
- Never insert or remove an electric plug with wet hands.

Fire warning

- Do not put burning items, such as candles, on the unit. A burning item may fall over and cause a fire.

If you notice any abnormality

- If the AC adaptor cord or plug becomes frayed or damaged, or if there is a sudden loss of sound during use of the instrument, or if any unusual smells or smoke should appear to be caused by it, immediately turn off the power switch, disconnect the adaptor plug from the outlet, and have the instrument inspected by qualified Yamaha service personnel.

CAUTION

Always follow the basic precautions listed below to avoid the possibility of physical injury to you or others, or damage to the instrument or other property. These precautions include, but are not limited to, the following:

Power supply/AC power adaptor

- When removing the electric plug from the instrument or an outlet, always hold the plug itself and not the cord.
- Unplug the AC power adaptor when not using the instrument, or during electrical storms.
- Do not connect the instrument to an electrical outlet using a multiple-connector. Doing so can result in lower sound quality, or possibly cause overheating in the outlet.

Battery

- Always make sure all batteries are inserted in conformity with the +/- polarity markings. Failure to do so might result in overheating, fire, or battery fluid leakage.
- Always replace all batteries at the same time. Do not use new batteries together with old ones. Also, do not mix battery types, such as alkaline batteries with manganese batteries, or batteries from different makers, or different types of batteries from the same maker, since this can cause overheating, fire, or battery fluid leakage.
- Do not dispose of batteries in fire.

- Do not attempt to recharge batteries that are not intended to be charged.
- When the batteries run out, or if the instrument is not to be used for a long time, remove the batteries from the instrument to prevent possible leakage of the battery fluid.
- Keep batteries away from children.
- If the batteries do leak, avoid contact with the leaked fluid. If the battery fluid should come in contact with your eyes, mouth, or skin, wash immediately with water and consult a doctor. Battery fluid is corrosive and may possibly cause loss of sight or chemical burns.

Location

- Do not expose the instrument to excessive dust or vibrations, or extreme cold or heat (such as in direct sunlight, near a heater, or in a car during the day) to prevent the possibility of panel disfiguration or damage to the internal components.
- Do not use the instrument in the vicinity of a TV, radio, stereo equipment, mobile phone, or other electric devices. Otherwise, the instrument, TV, or radio may generate noise.
- Do not place the instrument in an unstable position where it might accidentally fall over.

- Before moving the instrument, remove all connected adaptor and other cables.
- When setting up the product, make sure that the AC outlet you are using is easily accessible. If some trouble or malfunction occurs, immediately turn off the power switch and disconnect the plug from the outlet. Even when the power switch is turned off, electricity is still flowing to the product at the minimum level. When you are not using the product for a long time, make sure to unplug the power cord from the wall AC outlet.
- Do not place objects in front of the instrument's air vent, since this may prevent adequate ventilation of the internal components, and possibly result in the instrument overheating.

Connections

- Before connecting the instrument to other electronic components, turn off the power for all components. Before turning the power on or off for all components, set all volume levels to minimum. Also, be sure to set the volumes of all components at their minimum levels and gradually raise the volume controls while playing the instrument to set the desired listening level.

Maintenance

- When cleaning the instrument, use a soft, dry cloth. Do not use paint thinners, solvents, cleaning fluids, or chemical-impregnated wiping cloths.

Handling caution

- Do not insert a finger or hand in any gaps on the instrument.
- Do not place vinyl, plastic or rubber objects on the instrument, since this might discolor the panel or keyboard.
- Do not rest your weight on, or place heavy objects on the instrument, and do not use excessive force on the buttons, switches or connectors.
- Do not use the instrument/device or headphones for a long period of time at a high or uncomfortable volume level, since this can cause permanent hearing loss. If you experience any hearing loss or ringing in the ears, consult a physician.

Saving data

Backing up your data

- Saved data may be lost due to malfunction or incorrect operation. Save the important data to your computer. For information on sending the data, see page 36.

Yamaha cannot be held responsible for damage caused by improper use or modifications to the instrument, or data that is lost or destroyed.

Always turn the power off when the instrument is not in use.

When using a power adaptor, even when the power switch is in the "STANDBY" position, electricity is still flowing to the instrument at the minimum level. When you are not using the instrument for a long time, make sure you unplug the AC power adaptor from the wall AC outlet.

Make sure to discard used batteries according to local regulations.

The illustrations and LED displays as shown in this owner's manual are for instructional purposes only, and may appear somewhat different from those on your instrument.

● COPYRIGHT NOTICE

This product incorporates and bundles computer programs and contents in which Yamaha owns copyrights or with respect to which it has license to use others' copyrights. Such copyrighted materials include, without limitation, all computer software, style files, MIDI files, WAVE data, musical scores and sound recordings. Any unauthorized use of such programs and contents outside of personal use is not permitted under relevant laws. Any violation of copyright has legal consequences. DON'T MAKE, DISTRIBUTE OR USE ILLEGAL COPIES.

Copying of the commercially available musical data including but not limited to MIDI data and/or audio data is strictly prohibited except for your personal use.

● Trademarks

- The company names and product names in this Owner's Manual are the trademarks or registered trademarks of their respective companies.

Congratulations!

*Thank you for purchasing the Yamaha DD-65/YDD-60.
The DD-65/YDD-60 has been developed to
respond and play like a drum set—
but with greater ease, flexibility and sophisticated functions.
Before you use the instrument, we recommend that
you carefully read through this manual.*

Main features

The DD-65/YDD-60 is a sophisticated yet easy-to-use instrument with the following features and functions.

■ Select and play 254 different percussion sounds

A wide variety of percussion voices is available, letting you play different sounds when you hit the pads—for example, changing a pad to play a snare, tom, conga or even special sound effects, such as a door slam or a lion's roar.

■ Select and play 100 different Songs

The 100 songs include Demos, Drum patterns and Fill in patterns. You can mute the individual parts and play the muted part on the pads and pedals yourself.

■ Record your own performance

Up to five of your performances can be saved to this instrument, and these songs can be played in the same manner as the preset songs.

● Supplied accessories

- Drum Stick (x2)
- Foot Pedal 1 & 2
- Owner's Manual

Contents

Main features	6
Setting Up	8
Power Requirements	8
Panel Controls	10
Playing the Demo Song	12
Adjusting the volume.....	12
SONG VOLUME	12
Play the Pads/Pedals	13
Pad Names	13
Setting the Hand Percussion ON/OFF	14
Lock the Hand Percussion ON.....	14
Selecting a Drum Kit and play it.....	15
Assigning Voices to Individual Pads and Pedals and saving to a Custom Kit (“[01–03]”).....	16
Setting the Reverb ON/OFF.....	17
Setting the Reverb type	17
Setting the Pad Sensitivity	18
Setting the Click ON/OFF	19
Setting the Time Signature of the Click.....	19
Setting Equalization On/Off.....	21
Playing a Song	22
Selecting and playing a Song	22
Tap Start	23
Pad Start	23
Setting the Auto Kit Select ON/OFF.....	24
Adjusting the Tempo	25
Play along with a Song	26
Setting the Track ON/OFF	26
Break.....	26
Using A-B Repeat	27
Recording a Song	28
Recording.....	28
Playing the recorded song	29
Song Clear	29

About MIDI **30**

What is MIDI?.....	30
What You Can Do With MIDI	30
Transferring Performance Data To and From Another Instrument	30
Local ON/OFF	31
Setting the MIDI Note Number	32
MIDI Note Number Auto Selection ON/OFF	33
Transferring Song files to and from a connected computer	34

Appendix **36**

Backup and Initialization	36
Troubleshooting	37
Drum Voice List.....	38
Song List	40
Drum Kit List.....	41
Voice List.....	44
Drum Map	48
MIDI Implementation Chart	52
Specifications	55
Drum Score	56

Be sure to do the following operations **BEFORE** turning on the power.

Power Requirements

Although the instrument will run either from an optional AC adaptor or batteries, Yamaha recommends use of an AC adaptor whenever possible. An AC adaptor is more environmentally friendly than batteries and does not deplete resources.

Using an AC Power Adaptor

- ① Make sure that the power of the instrument is off (display shows no indications).

⚠ WARNING

- Use the specified adaptor (PA-5D, PA-150, or an equivalent recommended by Yamaha) only. The use of other adaptors may result in irreparable damage to both the adaptor and the instrument.

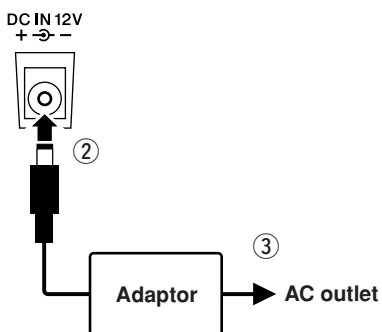

- ② Connect the AC adaptor to the power supply jack.
- ③ Plug the AC adaptor into an AC outlet.

⚠ CAUTION

- Unplug the AC Power Adaptor when not using the instrument, or during electrical storms.
- Never interrupt the power supply (e.g. remove the batteries or unplug the AC adaptor) during any DD-65/YDD-60 record operation! Doing so can result in a loss of data.
- Even when the instrument is turned off, electricity is still flowing to the instrument at the minimum level. When you are not using the instrument for a long time, make sure you unplug the AC power adaptor from the wall AC outlet.

Using Batteries

- ① Open the battery compartment cover located on the instrument's bottom panel.

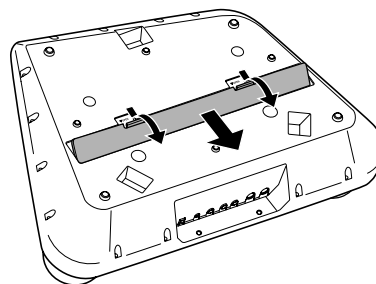

- ② Insert the six new alkaline batteries, being careful to follow the polarity markings on the side of the compartment.

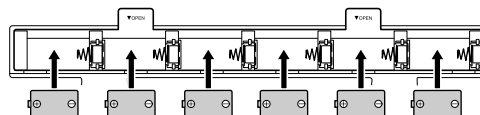

- ③ Replace the compartment cover, making sure that it locks firmly in place.

⚠ CAUTION

- Never connect or disconnect the AC power adaptor when the power is on and the batteries are installed. Doing so will turn the power off.

For battery operation the instrument requires six 1.5V "C" size, LR14 or equivalent batteries. (Alkaline batteries are recommended.) When battery power becomes too low for proper operation, the volume may be reduced, the sound may be distorted, and other problems may occur. When this happens, make sure to replace all batteries, following the precautions listed below.

⚠ CAUTION

- Use alkaline batteries for this instrument. Other types of batteries (including rechargeable batteries) may have sudden drops of power when battery power becomes low.
- Make sure to install the batteries with the proper orientation, maintaining the correct polarity (as shown). Incorrect battery installation may result in heat, fire and/or leaking of corrosive chemicals.
- When the batteries run down, replace them with a complete set of six new batteries. NEVER mix old and new batteries. Do not use different kinds of batteries (e.g. alkaline and manganese) at the same time.
- If the instrument is not to be in use for a long time, remove the batteries from it, in order to prevent possible fluid leakage from the battery.

Connecting headphones (PHONES/OUTPUT Jack)

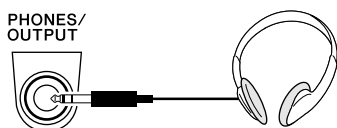

The DD-65/YDD-60 speakers are automatically shut off when a plug is inserted into this jack. The PHONES/OUTPUT jack also functions as an external output.

You can connect the PHONES/OUTPUT jack to a keyboard amplifier, stereo system, mixer, tape recorder, or other line-level audio device to send the instrument's output signal to that device.

WARNING

- *Avoid listening with the headphones at high volume for long periods of time; doing so may not only result in ear fatigue, it may be damaging to your hearing.*

CAUTION

- *To prevent damage to the speakers, set the volume of the external devices at the minimum setting and turn power off the devices before connecting them. Failure to observe these precautions may result in electric shock or equipment damage. Also, be sure to set the volumes of external devices at their minimum levels and gradually raise the volume controls while playing the instrument to set the desired listening level.*

Connecting an audio source (AUX IN Jack)

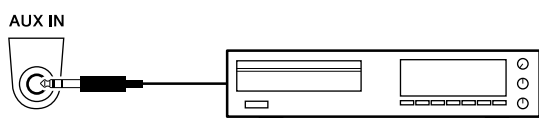

This jack is for connection to an external audio source. You can play the instrument with backing music and accompaniment, like playing with a full band. Adjust the input level from the volume control of the external audio source for optimum balance.

Connecting Pedals 1 and 2

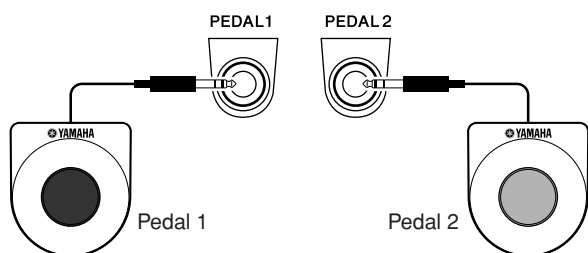

These jacks for connection of the Pedal 1 or Pedal 2 footswitches. These pedals can be used simultaneously play the drum set's hi-hat pedal or bass drum voices—or they can also be assigned to play other

voices as well. Connect the supplied Pedal 1 to the PEDAL 1 jack and Pedal 2 to the PEDAL 2 jack.



- *Make sure that the pedal plugs are properly connected to the PEDAL jacks before turning on the power.*

Using the MIDI Terminals

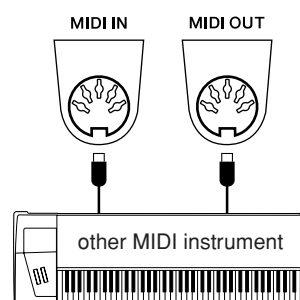

The instrument also features MIDI terminals, allowing you to interface the instrument with other MIDI instruments or computers. (For more information, see page 30.)



- *MIDI cables (sold separately) must be used for connecting to MIDI devices. They can be bought at music stores, etc.*
- *Always use a high-quality MIDI cable to connect MIDI OUT to MIDI IN terminals. Never use MIDI cables longer than about 15 meters, since cables longer than this can pick up noise which can cause data errors.*

Turn on the power

Turn down the volume by turning the [MASTER VOLUME] control to the left and press the [STANDBY/ON] switch to turn on the power. Press the [STANDBY/ON] switch again to turn the power off.

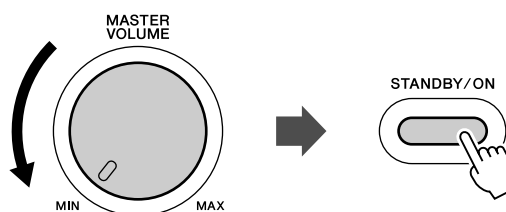

CAUTION

- *Even when the switch is in the "STANDBY" position, electricity is still flowing to the instrument at the minimum level. When you are not using the DD-65/YDD-60 for a long time, make sure you unplug the AC power adaptor from the wall AC outlet, and/or remove the batteries from the instrument.*
- *Never interrupt the power supply (e.g. remove the batteries or unplug the AC adaptor) during any record operation on the instrument! Doing so can result in a loss of data.*
- *While the data is being recorded ("-") appears and moves from left to right on the display, never interrupt the power supply (e.g., remove the batteries or unplug the AC adaptor). Doing so can result in a loss of data.*

● Front Panel

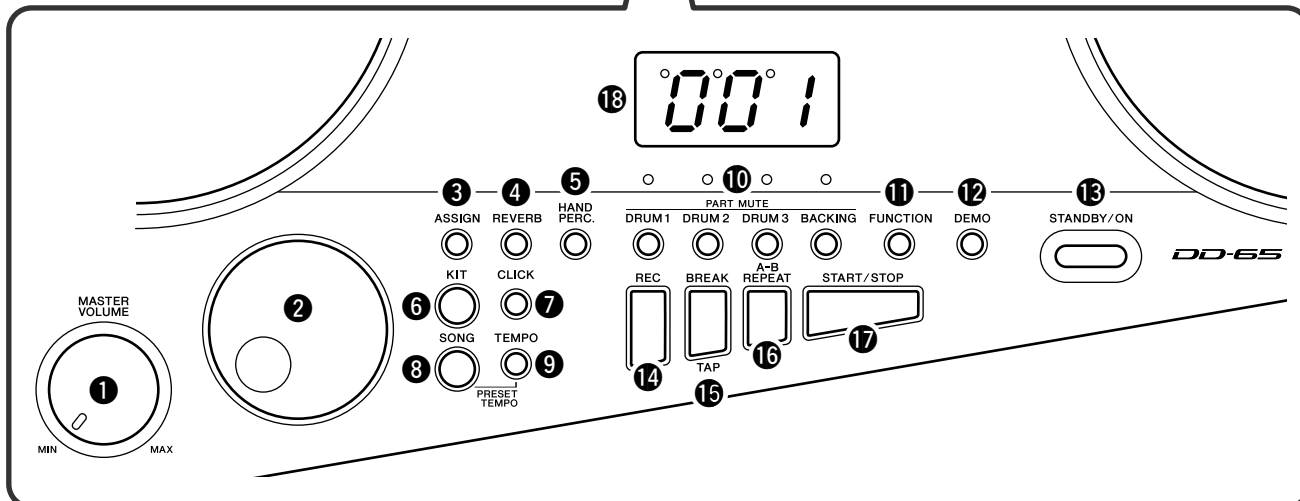
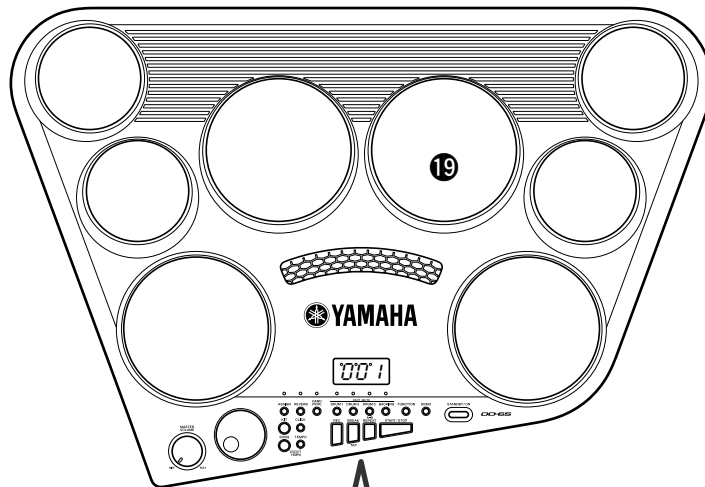

Front Panel

① [MASTER VOLUME] control.....	12	⑬ [STANDBY/ON] button	12, 36
② DIAL.....	15	⑭ [REC] button	28
③ [ASSIGN] button	16	⑮ [BREAK/TAP] button	23, 26
④ [REVERB] button.....	17	⑯ [A-B REPEAT] button.....	27
⑤ [HAND PERC.] button	14	⑰ [START/STOP] button	12, 22
⑥ [KIT] button.....	15	⑱ DISPLAY	15
⑦ [CLICK] button.....	19	⑲ DRUM PAD x 8	13
⑧ [SONG] button	22		
⑨ [TEMPO] button	25		
⑩ PART MUTE [DRUM 1–3], [BACKING] buttons	26		
⑪ [FUNCTION] button	12		
⑫ [DEMO] button	12		

● Rear Panel

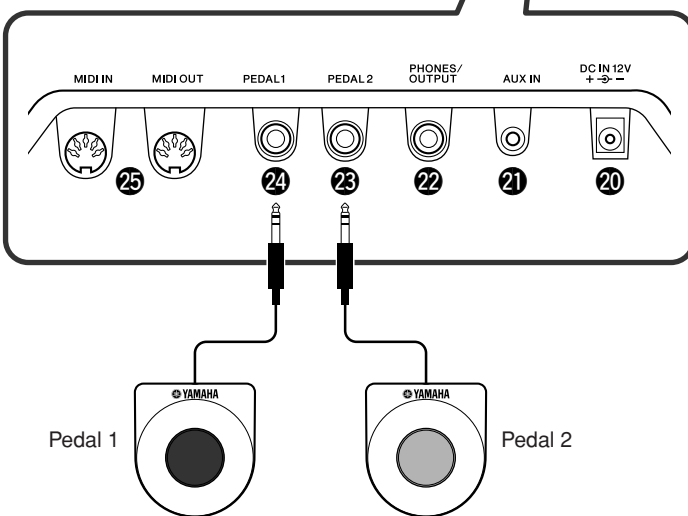
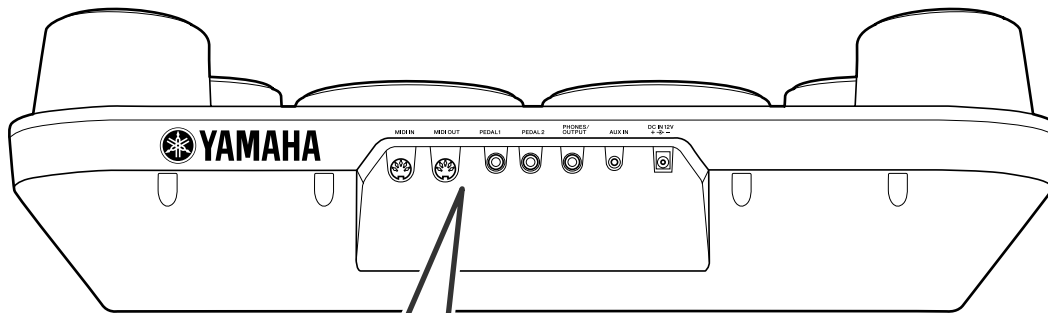

⚠ CAUTION

- Since speakers are built into the DD-65/YDD-60, you should be careful to never leave any video tapes, cassette tapes, floppy disks or any kind of magnetic storage media on the panel—doing so may result in data loss or damage to the items. Also avoid using the DD-65/YDD-60 near a television or computer monitor, since interference may result.
- Use the sticks with caution. Do not use them for anything other than playing the instrument. Also, to avoid damage or injury, refrain from waving them recklessly or throwing them.

● Drum Sticks

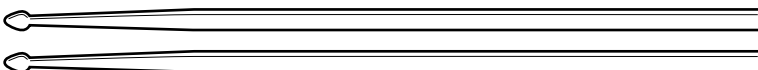

Rear Panel

20 [DC IN 12V] (AC Adaptor) jack	8
21 [AUX IN] jack	9
22 [PHONES/OUTPUT] jack	9
23 [PEDAL 2] Jack	9
24 [PEDAL 1] Jack	9
25 [MIDI IN/OUT] Terminals	9, 30

● Using the Foot Pedals (1/2)

When connected, these pedals can be used simultaneously play the drum set's hi-hat pedal or bass drum voices—or they can also be assigned to play other voices as well. Connect the supplied Pedal 1 to the PEDAL 1 jack 24 and Pedal 2 to the PEDAL 2 jack 23.

⚠ CAUTION

- Make sure that the pedal plugs are properly connected to the PEDAL jacks before turning on the power.
- Do not press the pedals while turning the power on. Doing this changes the recognized polarity of the pedal, resulting in reversed pedal operation.
- Avoid using the pedals directly on a soft floor, since they may scratch the surface of the floor.
- Avoid getting caught in or tripping over the pedal cords; this may cause the instrument to fall and result in damage or injury.

Playing the Demo Song

The DD-65/YDD-60 features several demonstration songs (001–005), specially created to show you the dynamic possibilities of the instrument.

1 Turn on the power.

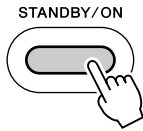

Turn on the [STANDBY/ON] switch on.

⚠ CAUTION

• Even when the switch is in the “STANDBY” position, electricity is still flowing to the instrument at the minimum level. When you are not using the DD-65/YDD-60 for a long time, make sure you unplug the AC power adaptor from the wall AC outlet, and/or remove the batteries from the instrument.

2 Start the Demo Song.

Press the [DEMO] button and the demo song starts playing.

3 Stop the Demo Song.

To stop playback, press the [DEMO] button again or press the [START/STOP] button.

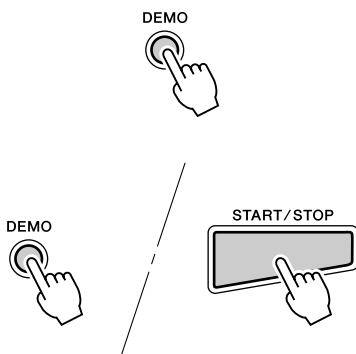

● Adjusting the volume

Turn the [MASTER VOLUME] control.

Decreases the overall volume.

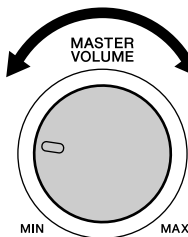

Increases the overall volume.

● SONG VOLUME

The SONG VOLUME can be used to adjust the balance between the song accompaniment and your own performance on the pads.

Enter the Function mode by pressing the [FUNCTION] button, then press the [DRUM 1] or [DRUM 2] button a number of times until the “50L” item appears. The current Song volume appears when it is released.

To raise the value, turn the **DIAL** to the right (clockwise), and to lower it, turn the **DIAL** to the left (counter-clockwise). Volume range is from 0 to 127.

Exit from the Function mode by pressing the [FUNCTION] button.

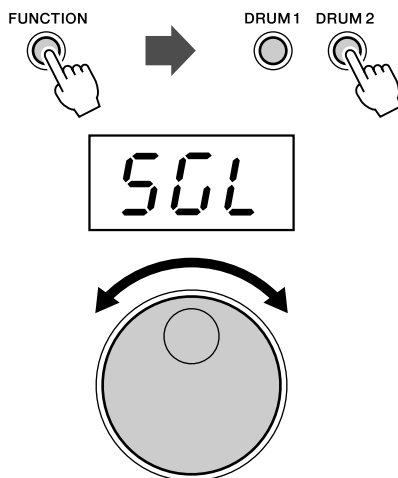

• The [DRUM 1] and [DRUM 2] buttons change the selected order of the function item.

Play the Pads/Pedals

Strike the pad with the supplied drum sticks or your hands to play the drum voices. When playing the pads with your hands, turn the Hand Percussion feature on by pressing the [HAND PERC.] button (the lamp lights).

The volume of the pads' sounds responds to your playing; when you play soft the volume is soft, and when you play strongly the volume is loud.

The actual loudness of the sound may vary according to which part of the pad is struck.

Pad Names

● Ex. shown, Drum Kit 1

A hi-hat sound is assigned to Small Pad 2 (Drum Kit 1). Striking Small Pad 2 while pressing Pedal 2 produces a closed hi-hat sound. Striking the Pad 2 without pressing the pedal produces an open hi-hat sound.

Small Pad 1

113: Crash Cymbal Stereo 1

Small Pad 2

100: Hi-Hat Closed Power 1

Pad 2

52: Tom Power 6

Pad 3

54: Tom Power 4

Small Pad 3

116: Ride Cymbal Stereo 2

Small Pad 4

119: Splash Cymbal Stereo

Pad 1

21: Snare Power 1

Pad 4

56: Tom Power 2



Pedal 2

101: Hi-Hat Pedal Power

Press Pedal 2 to control the Hi-hat. (This is in the case of Drum Kit 1.)



- When using Pedal 2, touch response does not function.

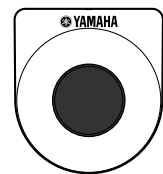

Pedal 1

3: Bass Drum Power Closed

Pedal 1 features touch response; the volume responds to how hard you press the pedal.



- If your pressing of the pedal is too slow or soft, there may be no sound.



Setting the Hand Percussion ON/OFF

You can play the pads of the instrument either with the supplied sticks or with your hands. Press and set the following button when you play the instrument with your hands.

1 Press the [HAND PERC.] button.

Hand Percussion on



When you press the [HAND PERC.] button, the button's lamp lights, and the pad sensitivity is automatically adjusted for optimum playing by hand. At the same time, an appropriate song (059) and drum kit(37) are automatically called up.

When Hand Percussion is off, Song (001) and drum kit (01) are automatically called up.



- Be sure to strike the pads only with your hands when HAND PERCUSSION is on, since the sensitivity is automatically set to appropriate level for hand playing.

Lock the Hand Percussion ON

If you perform on the instrument solely with your hands, we recommend that you use this operation to lock the Hand Percussion so that it is always on. This protects the instrument from being inadvertently changed during your performance.

1 Make sure that Hand Percussion is set to on (the lamp is lit).



Press and hold

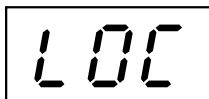

2 Set the Hand Percussion Lock to ON.

Press and hold the [HAND PERC.] button until "LOC" appears on the display.

3 To turn off Hand Percussion Lock, press and hold the [HAND PERC.] button until the "LOC" is no longer shown on the display.

Selecting a Drum Kit and play it

The instrument allows you to choose from 50 different Drum Kits (1–50: see the “Drum Kit List” page 41) quickly and easily. 50 of the kits have preset voice combinations that will be set to the pads and pedals when the kit is selected.

Select some different kits and try playing them.

The instrument also has three Custom Drum Kits allowing you to assign the desired voices to the eight pads or two pedals (see “Assigning Voices to Individual Pads and Pedals and saving to a Custom Kit (“[01–03]”)” page 16).



1 Press the [KIT] button.

When you press the [KIT] button, the currently selected Drum Kit number appears on the display.

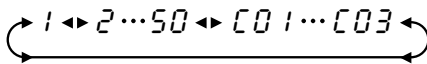
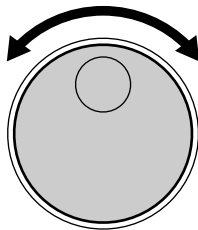

2 Select a Drum Kit Number.

Turn the **DIAL** to select a Drum Kit number. Drum Kit numbers will increase as the **DIAL** is turned to the right (clockwise), and decrease as the **DIAL** is turned to the left (counter-clockwise).



- Drum Kit number 1 is normally selected when the power is turned on.
 - The “[01–03]” Drum Kit are the Custom Kit.
- * Custom Kits are those that you’ve assigned the desired voice to each pad and pedal, then saved the entire assignments as a kit. (See “Assigning Voices to Individual Pads and Pedals and saving to a Custom Kit (“[01–03]”)” page 16.)

Assigning Voices to Individual Pads and Pedals and saving to a Custom Kit ("C01-C03")

The instrument contains a total of 254 high quality drum sounds plus 25 drum phrases (see the "Drum Voice List" page 38)—and you can assign these freely to each of the 8 drum pads and 2 pedals. Try assigning some different voices and save your own "C01-C03" Custom Drum Kits.



• Custom Kit "C01-C03" and "01" drum kit contents are the same until modified (see the "Drum Kit List" page 41).



1 Press the [ASSIGN] button.

When you press the [ASSIGN] button, the button's lamp lights, and "C01" appears on the display.

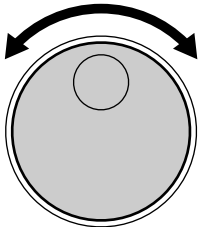

2 Turn the dial and select a Custom Kit "C01-C03" for saving.

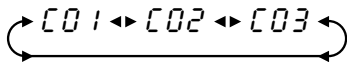

3 Select a pad or pedal to be assigned.

Strike any pad one time (or press a pedal), and the currently assigned voice number for that pad/pedal is shown in the display.

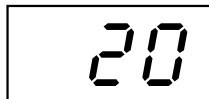
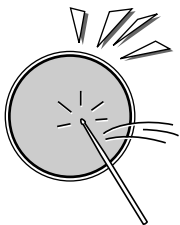

4 Select a Voice Number.

You can select the voice by repeatedly striking the pad or repeatedly pressing the pedal (while listening to the voice), or by turning the DIAL.

● Striking the pad or pressing the pedal to select a voice.

Every time the pad is struck or a pedal is pressed, voice numbers will increase by a value of one (1). In this method, you can hear and select an assigned voice.

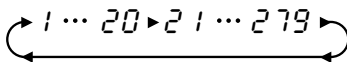

● Using the DIAL to select a voice.

Turn the DIAL to the right (clockwise), and voice numbers will increase. Turn the DIAL to the left (counter-clockwise), and voice numbers will decrease.

See the "Drum Voice List" on page 38.

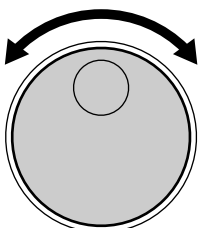

Repeat the previous steps 3 and 4 for any or all of the pads and pedals.



5 Save to a Custom kit.



Press the [ASSIGN] button to save to a Custom kit (the lamp will be off).

To cancel the saving, simply press the [KIT], [SONG] or [DEMO] button.

After you've assigned the voice, the instrument will automatically be set to the assigned custom kit.

You can now play the voice you have assigned to the pad/pedal.

Setting the Reverb ON/OFF

Different depths of the DD-65/YDD-60's reverb effect can be added to the DD-65/YDD-60's overall sound.

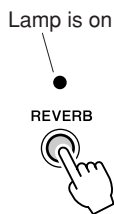

1 Press the [REVERB] button.

When you press the [REVERB] button the button's lamp lights, and the ambience of a room or concert hall is added to the sound.

2 To turn Reverb off, press the [REVERB] button again. (Make sure that the lamp is not lit.)

Setting the Reverb type

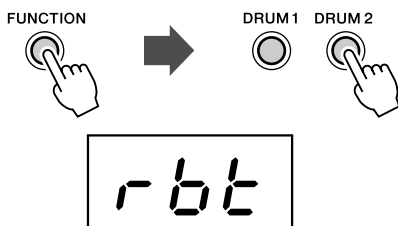

1 Enter the Reverb type setting function.

Press the [FUNCTION] button once, then press the [DRUM 1] or [DRUM 2] button a number of times until the "r b t" item appears. The currently selected Reverb type number appears next to the "r b t" indication.

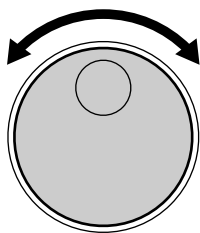

2 Change the reverb type by turning the DIAL.

● Reverb type List

No.	Reverb Type	No.	Reverb Type
1	Hall 1	6	Stage 1
2	Hall 2	7	Stage 2
3	Hall 3	8	Plate 1
4	Room 1	9	Plate 2
5	Room 2	10	Off

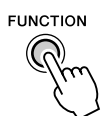

3 Press the [FUNCTION] button to exit from the Function mode.

Setting the Pad Sensitivity

The instrument allows you to custom-set the sensitivity of the pads (range 0–2). When set to a value of 2, the pad sensitivity is the highest, providing the most dynamic range for your playing (softest to loudest volume).

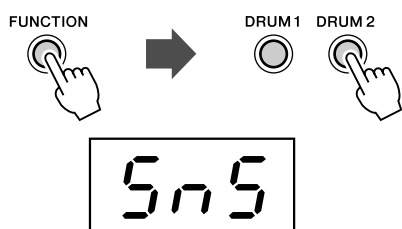

1 Enter the Pad Sensitivity setting function.

Press the [FUNCTION] button once, then press the [DRUM 1] or [DRUM 2] button a number of times until the “*Sn*” item appears. After a while, the current Sensitivity value appears next to the “*Sn*” indication.

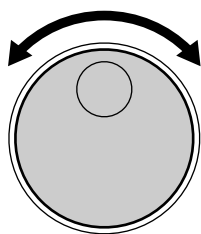

2 Set the Sensitivity.

To raise the value, turn the **DIAL** to the right (clockwise), and to lower it, turn the **DIAL** to the left (counter-clockwise).



• Default value is 1.

0 ◀▶ 1 ▶▶ 2

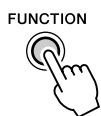

3 Exit from the Function mode by pressing the [FUNCTION] button.

About the Pad Sound Mechanism

Each time you strike a pad, the sensor which is located at the bottom of the pad triggers an electronic signal and makes a drum sound.

If you strike a pad too strongly, nearby sensors may also respond to the hit and trigger unwanted sounds. The DD-65/YDD-60 is set to ignore weak signals from the pads in order to prevent inadvertent, unwanted sounds. However, this may result in problems when intentionally striking two pads simultaneously. If one pad is struck strongly and the other weakly, the pad struck weakly may not sound (even though you want it to).

To solve this, you can change the DD-65/YDD-60 settings or alter your playing technique (as described below).

- **Striking two pads simultaneously results in one of the pads not sounding.**
 - Set the pad sensitivity level to 2. This may solve the problem if you strike one of the pads weakly.
 - Better yet, take care to strike both pads with equal force.
- **Striking one pad results in other pads also sounding, even though they were not struck.**
 - Set the pad sensitivity level to 0. With this setting, pads that are not struck are effectively kept from responding to strong hits on nearby pads.



Setting the Click ON/OFF

The instrument includes a click sound with adjustable tempo and time signature.



Press the [CLICK] button.

The click sounds in rhythm at the current tempo. (See “Adjusting the Tempo” on page 25.)

To turn the click off, press the button once again.

Setting the Time Signature of the Click

■ Setting the numerator of the time signature

The range is 0 to 16.

The first beat is accented with a bell sound and the rest with clicks.

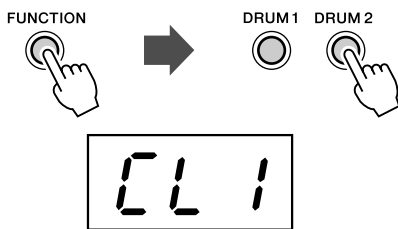

1 Enter the numerator value setting function.

Press the [FUNCTION] button once, then press the [DRUM 1] or [DRUM 2] button a number of times until the “CL I” item appears.

After a while, the current numerator value appears next to the “CL I” indication.

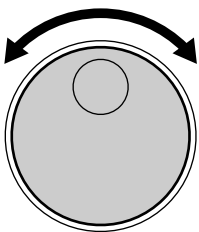

0 ◀▶ 1 ... 15 ▶▶ 16

2 Set the numerator value of the time signature.

To raise the value, turn the **DIAL** to the right (clockwise), and to lower it, turn the **DIAL** to the left (counter-clockwise).



- Default value is 4.

- When set to 00, the click sounds all beats with a click sound (no accent).

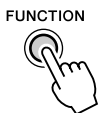

3 Press the [FUNCTION] button to exit from the Function mode.

■ Setting the denominator of the time signature

Set the basic note value for each measure.

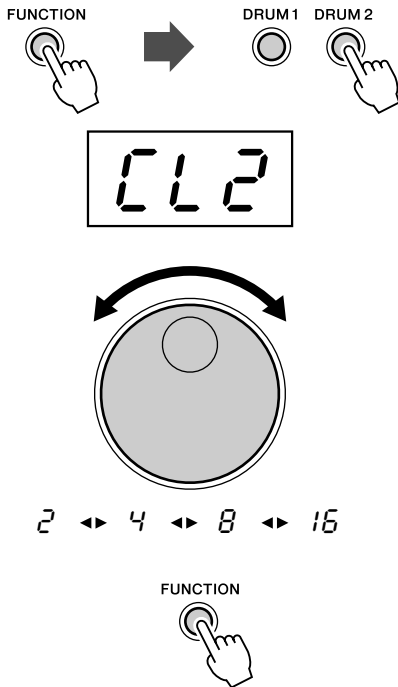

1 Enter the denominator value setting function.

Press the [FUNCTION] button once, then press the [DRUM 1] or [DRUM 2] button a number of times until the “CL 2” item appears. After a while, the current denominator value appears next to the “CL 2” indication.

2 Set the denominator value of the time signature.

Set the denominator value to one of the values 2 (♩), 4 (♩), 8 (♩), 16 (♩) by using the DIAL.



• Default value is 4.

3 Press the [FUNCTION] button to exit from the Function mode.

■ Setting the click volume

Sets the click volume (range: 1–127).

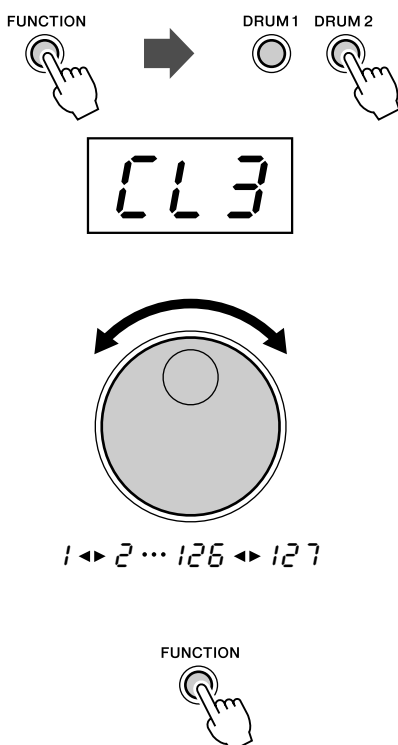

1 Enter the click volume setting function.

Press the [FUNCTION] button once, then press the [DRUM 1] or [DRUM 2] button a number of times until the “CL 3” item appears. After a while current click volume will appear next to the “CL 3” indication.

2 Set the click volume by using the dial.

3 Press the [FUNCTION] button to exit from the Function mode.

Setting Equalization On/Off

When you use the internal speakers, set Equalization to ON (default setting is on).
When you use headphones or external speakers, set this to off.

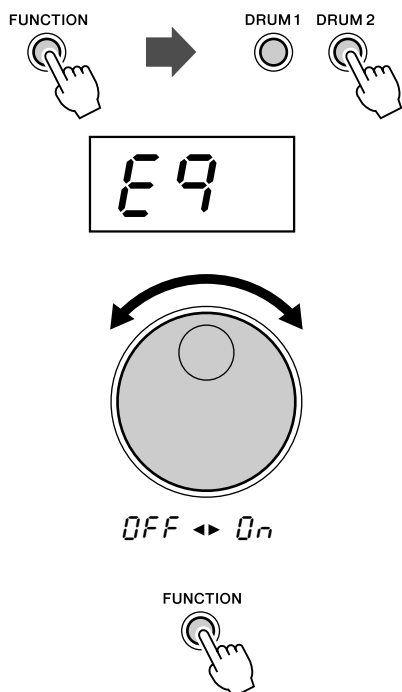

1 Enter the Equalization setting function.

Press the [FUNCTION] button once, then press the [DRUM 1] or [DRUM 2] button a number of times until the “EQ” item appears. After a while, the current On/Off setting will appear next to the “EQ” indication.

2 Set the Equalizer On/Off.

Turn the DIAL clockwise to set to ON, and turn it counter-clockwise to set it to OFF.

3 Press the [FUNCTION] button to exit from the Function mode.

Playing a Song

This instrument features 100 different songs (five demo songs, as well as Rhythm patterns and Fill-in patterns) that can be used to provide accompaniment.

(See the “Song List” on page 40.)

U01–U05 can also be used to playback songs you’ve recorded yourself and/or loaded from computer. Refer to the section “Transferring Song files to and from a connected computer” on page 34 for details. Select one of the songs and listen to it.

Selecting and playing a Song

1 Press the [SONG] button.

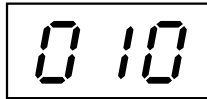

When you press the [SONG] button, the current song number appears in the display.

2 Select a Song Number.

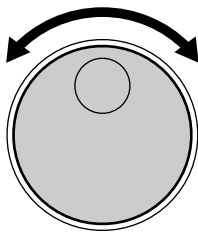

Use the **DIAL** to select a song number. Song numbers will increase as the **DIAL** is turned to the right (clockwise), and decrease as the **DIAL** is turned to the left (counter-clockwise). (See the “Song List” on page 40.)



- Song number “001” is automatically selected whenever the power is turned ON.
- With the Auto Kit Select feature turned on, selecting a song will also automatically select the best suited Drum Kit for that song. (See “Setting the Auto Kit Select ON/OFF” on page 24.)
- The complexity of each song can be shown at the Song list. (See the “Song List” on page 40.)

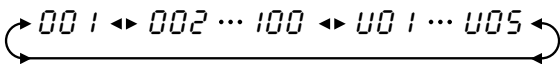

U01–U05 are User Songs which you’ve recorded yourself and/or loaded from computer.
Note that when you press [START/STOP] button, no sounds are played if there is no data.

3 Press the [START/STOP] button.

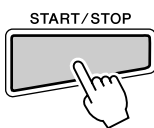

When you press the [START/STOP] button, a one- or two-measure count-in plays, and the song starts playing.

As the song is playing, the Song’s current measure will be shown in the display. Try playing the pads and pedals along with the song.

To stop playback of the song, press the [START/STOP] button once again.



- You can also use the TAP START function to start songs (see page 23).

Tap Start

The Tap Start function allows you to set the song's overall tempo as well as start the accompaniment—simply by tapping out the rhythm.

The accompaniment will playback at the tempo with which the pads are struck or the pedals are pressed.

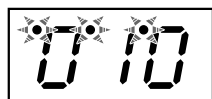

1 Press the [BREAK/TAP] button.

While song playback is stopped, press the [BREAK/TAP] button. All three of the beat lamps flash, indicating the instrument is set to Tap Start standby.

To cancel the Tap Start mode, simply press the [BREAK/TAP] button once again (the beat lamps will turn off).

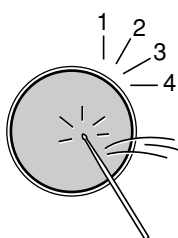

2 Play the Tap Start.

In the case of a song in 4/4, strike any pad or press any pedal four times, and the accompaniment will start at the desired tempo.



- The number of times needed to strike the pad will change according to the following time signatures; 5/4, 5 times; 4/4, 4 times; 3/4, 3 times; 6/8, 2 times.

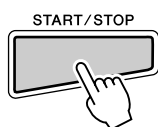

3 Stop the Song Playback.

Press the [START/STOP] button and the song accompaniment will stop.

Pad Start

The Pad Start function allows to start the song simply by striking a pad or pressing a pedal. To stop the song, press the [START/STOP] button.

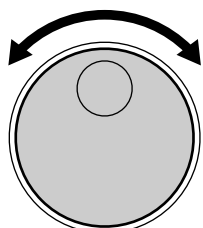
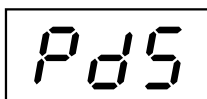
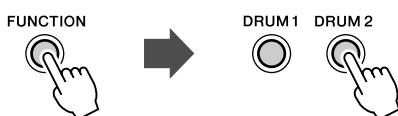

OFF ◀▶ On

1 Enter the Pad Start setting function.

Press the [FUNCTION] button once, then press the [DRUM 1] or [DRUM 2] button a number of times until the "Pd5" item appears. After a while, the current On/Off status appears next to the "Pd5" indication.

2 Turn Pad Start On/Off.

Turn the DIAL clockwise to set to ON, and turn it counter-clockwise to set it to OFF.



- Default setting is OFF.

3 Press the [FUNCTION] button to exit from the Function mode.

Setting the Auto Kit Select ON/OFF

With the Auto Kit Select feature turned on, the best suited Drum Kit for the song will automatically be selected.

If Auto Kit Select is OFF, the Drum kit does not change even if the song number is changed.

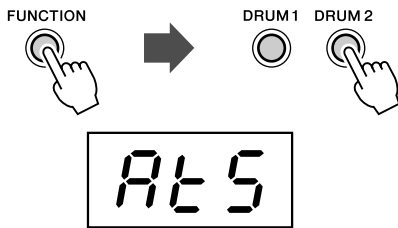

1 Enter the Auto Kit Select function.

Press the [FUNCTION] button once, then press the [DRUM 1] or [DRUM 2] button a number of times until the “AL5” item appears. After a while, the current On/Off status will appear next to the “AL5” indication.

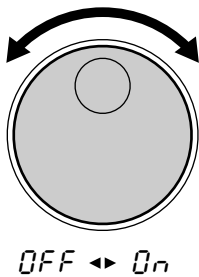

2 Turn Auto Kit Select On/Off.

Turn the DIAL clockwise to set to ON, and turn it counter-clockwise to set it to OFF.

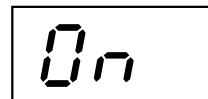

Auto Kit Select on



• Default setting is ON.

3 Press the [FUNCTION] button to exit from the Function mode.

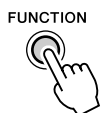

• Original factory setting is on.

Adjusting the Tempo

The song tempo and Click tempo can be set anywhere from 11 to 320 beats per minute. The higher the tempo value, the faster the tempo.

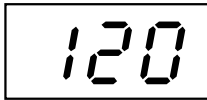

1 Press the [TEMPO] button.

The current tempo value (11–320) appears in the display.

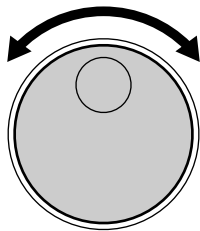

11 ◀▶ 12 ... 3 19 ▶◀ 320

2 Set the Tempo.

Use the **DIAL** to select the TEMPO. Turn the **DIAL** to the right (clockwise) to increase the Tempo value, and turn it to the left (counter-clockwise) to decrease the value.



- When both the [SONG] and [TEMPO] buttons are pressed simultaneously, the preset tempo of the currently selected song is automatically applied.

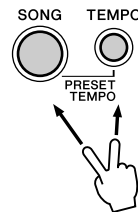

● About the Beat Indicator

During song playback, the three beat lamps in the display will flash in a specific pattern to help you in keeping the beat.

For a song in 4/4 time at a tempo of 120 bpm:

1st beat	2nd beat	3rd beat	4th beat
• 120	• 120	° 120	° 120

3 Press the [SONG] button to exit from the Tempo setting mode.



- The tempo value cannot be changed while the demo is playing or during recording.

Play along with a Song

Use the pads and pedals to play along with the song accompaniment.



- The instrument can play a total of 32 notes simultaneously. That includes notes produced by song accompaniment, pads, foot pedals, and note data received through the MIDI IN jack.

Setting the Track ON/OFF

The instrument's song accompaniment consists of 4 tracks: Drum tracks 1, 2, and 3, and the Backing track.

DRUM 1	Bass Drum
DRUM 2	Snare Drum
DRUM 3	Cymbal
BACKING	Backing

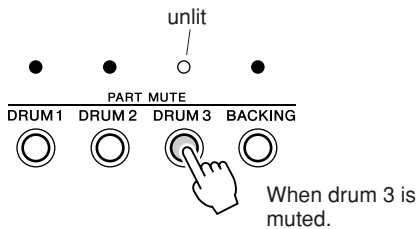

Pressing a Track button ([**DRUM 1**], [**DRUM 2**], [**DRUM 3**], [**BACKING**]) will mute (turn off the sound) the corresponding track and its indicator lamp will turn off.

Muting DRUM 1, DRUM 2 and DRUM 3 tracks allows you to play along with the song and practice the missing part.

Break

With the Break function, you can liven up songs by adding your own solos or fills, whenever you want.

Striking a pad while in the Break mode, the song's accompaniment will be muted until the end of the measure you have finished your fill or solo in.

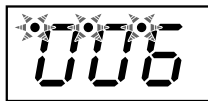

1 During song playback, press the [**BREAK/TAP**] button.

During song playback, press the [**BREAK/TAP**] button. The three beat lamps in the display flash, indicating the instrument is in Break standby mode. To cancel the Break mode, simply press the [**BREAK/TAP**] button once again. (The beat lamps flash in tempo.)

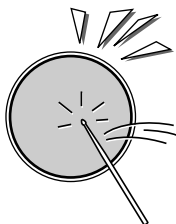

2 Play the Break.

Strike any pad or pedal, and the accompaniment will mute until the end of the measure you played in. You can play a drum fill or drum solo during this break.

The instrument returns to the Break standby mode when the Break measure is completed.

3 Exit the Break mode.



To exit the Break mode, press the **[BREAK/TAP]** button. The Break mode is also exited when the song is stopped.



• The Break does not function if DEMO is started.

Using A-B Repeat

If you want to practice a particular section of a song, you can specify that section's "A" (start repeat) and "B" (end repeat) points. The accompaniment will continuously repeat between points "A" and "B" allowing you to practice between those points for as long as you like.

1 Set the "A" (start repeat) point.

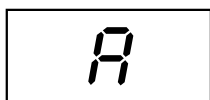

When the song playback has reached the start of the section you want to practice, press the **[A-B REPEAT]** button and the "A" repeat point is set. An "A" will appear in the display.

2 Set the "B" (end repeat) point.

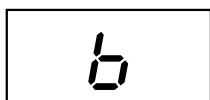

When the song playback has reached the end point of the section you want to practice, press the **[A-B REPEAT]** button once again to set the "B" point ("b" appears in the display). A one-measure count-in plays ("A - b" appears in the display), then the specified section plays back repeatedly. The current measure number will appear in the display during repeat playback.



• The A-B Repeat start and end points can only be set in measure steps.

3 Stop the A-B REPEAT.

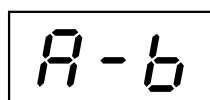
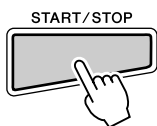

Press the **[START/STOP]** button and the song accompaniment will stop.

Press the **[START/STOP]** button once again and the accompaniment will again repeat between the set points.



• Repeat is canceled when a different song is selected.

● Exit the Repeat

To exit the A-B Repeat function, press the **[A-B REPEAT]** button during playback, and the A-B Repeat mode will be canceled (the A-B Repeat points will also be canceled) and normal playback of the accompaniment will continue.

When the song is stopped, pressing the **[A-B REPEAT]** button cancels the A-B Repeat points.



Recording a Song

The User Songs feature (song number UO1–UO5) allows you to record and playback five original songs (Maximum 10,000 notes approximately per song).

Data that can be recorded in the User Song Mode

- Drum pad and pedal played data
- Song data (the number cannot be changed while in the RECORD Mode)
- Track On/Off settings
- Tempo setting (The tempo cannot be changed while in the RECORD mode)
- Song Volume setting

Recording



1 Prepare to Record.

Select a desired song (001–100), drum kit, tempo and track on/off setting.



2 Press the [RECORD] button to enter the recording mode.

The dots flash indicating it is set to record standby.

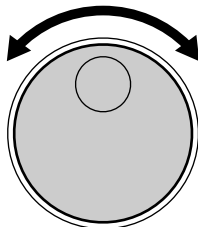

3 Turn the dial and select a User song "UO 1–UO3" for saving.

UO 1 ◀▶ UO2 ... UO4 ◀▶ UO5

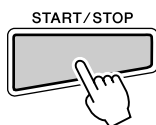

4 Press the [START/STOP] button to start recording.

Now you can play and record your performance.

As the recording progresses, the display changes as shown here:

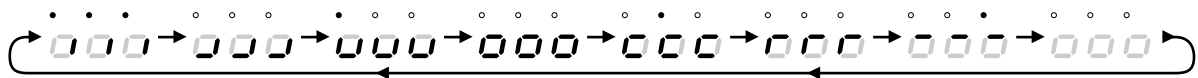

• Press the [CLICK] button to turn the click sound on or off during recording.

5 Stop Recording.

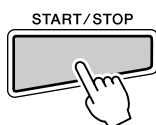

To stop recording, press the [START/STOP] button.



- If the memory becomes full while recording is in progress, "FL" will appear in the display and recording will automatically stop.

CAUTION

- Please note that if, in step 3, you select a User Song which has been recorded or contains data, it will be overwritten with new data.
- While the data is being recorded ("-" appears and moves from left to right on the display), never interrupt the power supply (e.g., remove the batteries or unplug the AC adaptor). Doing so can result in a loss of data.

Playing the recorded song

The recorded User Songs (U01–U05) can be played back in the same manner as any song (song numbers 001–100).



The user songs (U01–U05) are located to next to the number 100 (before 001).

Song Clear

The Song clear operation completely erases all recorded data on all tracks of a selected user song.



1 Press the [REC] button.

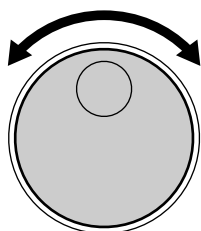

2 Turn the dial to select the desired song (U01–U05) to be cleared.

To cancel the Clear operation, press the [REC] button again.

U01 ◀▶ U02 ⋯ U04 ◀▶ U05

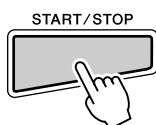

3 Press the [START/STOP] button two times.

The Clear operation will be executed.

CAUTION

- While the data is being cleared (a "-" mark appears and moves from left to right on the display), never interrupt the power supply (e.g., by removing the batteries or unplugging the AC adaptor). Doing so can result in loss of data.

The MIDI IN and MIDI OUT terminals, located on this instrument's rear panel, allow connection to other MIDI instruments, devices and computers for expanded musical functionality—for example, using this instrument to play sounds on other instruments, or for recording your performance to a sequencer or computer.



• Preset song data cannot be transmitted via the MIDI OUT terminal.

What is MIDI?

MIDI (Musical Instrument Digital Interface) is a world-standard interface for communication between electronic musical instruments and music devices. When MIDI-equipped instruments are connected via a MIDI cable, it becomes possible to transfer performance and setting data between them for significantly enhanced performance and production potential.

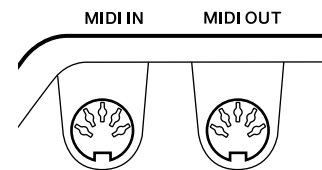

CAUTION

• Connect this instrument to external equipment only after turning off power for all devices. Then, turn on the power, first to this instrument, then to the connected external equipment.

What You Can Do With MIDI

- Transferring performance data between this instrument and MIDI-equipped instruments or computer. (page 30)
- Transferring SONG data between this instrument and computer. (page 34)

Transferring Performance Data To and From Another Instrument

By connecting this instrument to other MIDI devices or a computer, the performance data of the instrument can be used on those other MIDI devices or computer, and also the performance data from other MIDI devices and computer can be received and sounded with this instrument.

- When the instrument is connected with another MIDI device, it transmits/receives performance data.

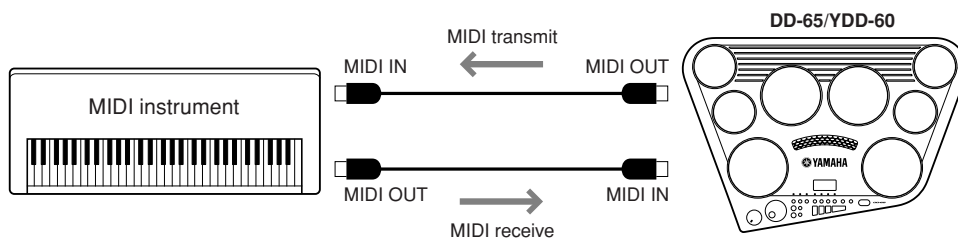

- When the instrument is connected with a computer, it transmits/receives performance data.

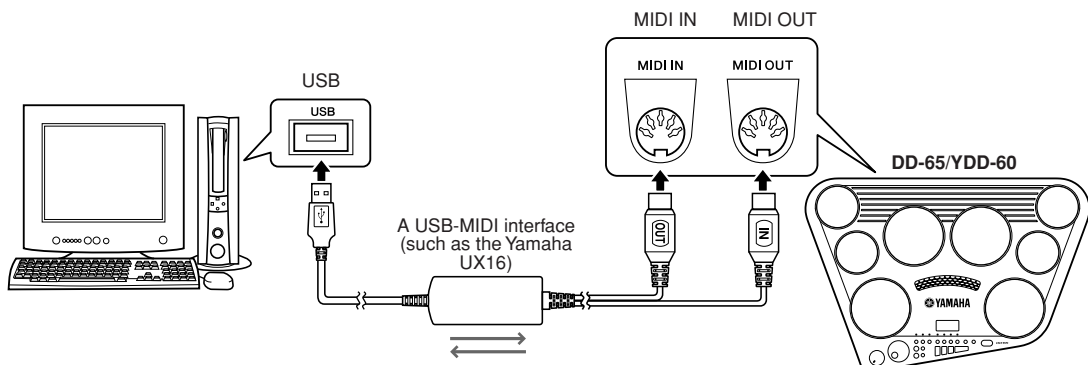

A Yamaha UX16 or similar USB-MIDI interface (sold separately) will be necessary for MIDI connection between the instrument and a USB equipped computer.
Make sure to purchase a Yamaha UX16 or a quality USB-MIDI interface at a musical instrument store, computer store or electrical appliance store.
If you use the UX16 interface, install the driver supplied with the interface on your computer.



• When using a computer, special software (sequencer software) is needed.

Local ON/OFF

Local Control determines whether or not notes played on the instrument are sounded by its internal tone generator system; the internal tone generator is active when local control is on, and inactive when local control is off.

- On (on)** This is the normal setting in which notes played on the instrument's keyboard are sounded by the internal tone generator system. Data received via the instrument's MIDI terminal will also be played by the internal tone generator.
- OFF (off)**..... With this setting the instrument itself produces no sound (pad or pedal performance), but the performance data is transmitted via the MIDI terminal. Data received via the instrument's MIDI terminal will also be played by the internal tone generator.



• Normally, this should be set to "on"—since you'll want to hear the sound of the instrument as you play it. However, for external sequencer applications, you may need to set this to "off" to avoid getting "double" notes, in which the sounds of the instrument are played twice—once from the pads and once again by the pad data routed through the sequencer.

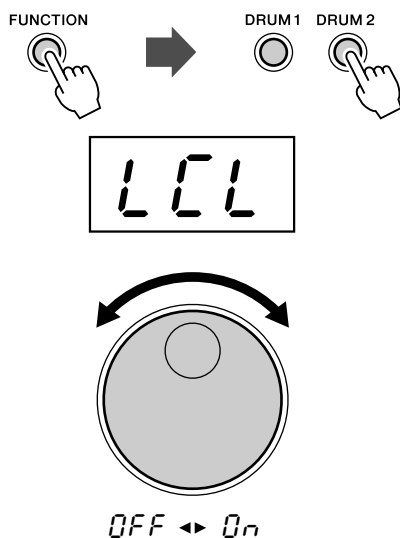

1 Enter the Local On/Off setting function.

Press the [FUNCTION] button once, then press the [DRUM 1] or [DRUM 2] button a number of times until the “LLL” item appears. After a while, the current On/Off status appears next to the “LLL” indication.

2 Turn Local On/Off.

Turn the **DIAL** clockwise to set to ON, and turn it counter-clockwise to set it to OFF.



• Default setting is ON.

3 Press the [FUNCTION] button to exit from the Function mode.



• Regardless of the Local ON/OFF setting, the instrument's performance data is always sent to the MIDI OUT terminals for transmission to external MIDI devices.

CAUTION

• No sound comes from speakers when Local control is set to OFF.

Setting the MIDI Note Number

Each pad and pedal (10 total) can be assigned a specific MIDI note number anywhere from C-2 to G8.



• For information on transmit notes and voices, refer to the “Drum Map” on page 48.

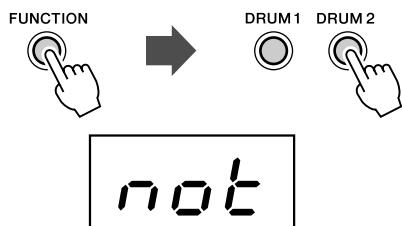

1 Enter the MIDI Note number setting function.

Press the [FUNCTION] button once, then press the [DRUM 1] or [DRUM 2] button a number of times until the “not” item appears. After a while, the MIDI note number currently assigned to Pad 1 appears next to the “not” indication.

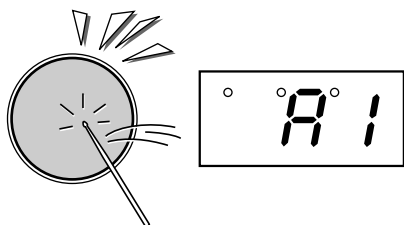

2 Select a pad or pedal to be assigned a MIDI Note Number.

Strike any pad to see the currently assigned MIDI note number for the pad in the display. Sharp notes are indicated by a beat lamp on the right side of the display.

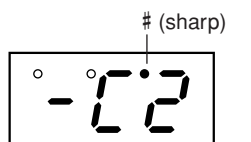

Indicates the note number is C#-2

3 Assign a MIDI Note Number.

To select the desired MIDI note number, turn the DIAL to the right (clockwise) and the MIDI note numbers will increase. Turn the DIAL to the left (counter-clockwise) and MIDI note numbers will decrease.

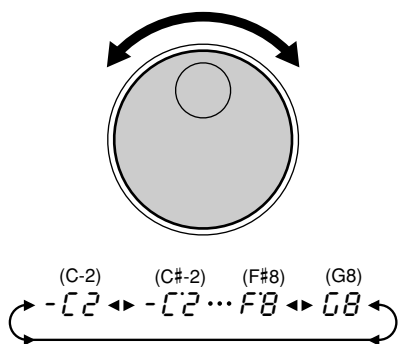

• You can also select the MIDI note number by striking the pad repeatedly. Every time the pad is struck, the value will increase by semitone steps.

4 Press the [FUNCTION] button to exit from the Function mode.

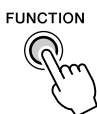

- When you select a drum Kit or Custom Kit, the MIDI Note Number will be applied to the preset value. If the Auto Kit Select is set to ON and another Song is selected, the MIDI Note Number will be applied to the preset value.
- MIDI Note Number Auto Selection ON/OFF is automatically turned off when a MIDI Note Number is changed.

MIDI Note Number Auto Selection ON/OFF

Ordinarily, you should keep this function set to on for the instrument (default setting is on).

When MIDI Number Auto Selection is on and you strike the pad, the MIDI note number corresponding to the pad (voice) you strike is sent via the MIDI OUT terminal.

On the other hand, when MIDI Number Auto Selection is off and you strike the pad, the MIDI note number that you've specifically assigned to the pad is sent via the MIDI OUT terminal.

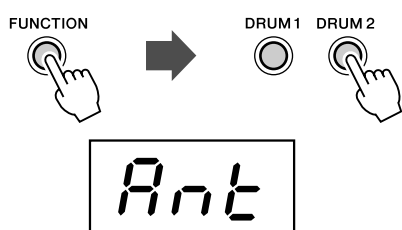

1 Enter the MIDI Number Auto Selection setting function.

After pressing the [FUNCTION] button, press the [DRUM 1] or [DRUM 2] button a number of times until the “Ant” item appears. After a while, the current setting (on/off) appears next to “Ant”.

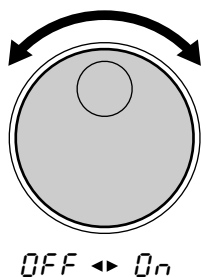

2 Set MIDI Number Auto Select on/off as desired.

Turn the DIAL clockwise to set to ON, and turn it counter-clockwise to set it to OFF.

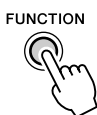

3 Press the [FUNCTION] button to exit from the Function mode.



• MIDI Note Number Auto Selection ON/OFF is automatically turned off when a MIDI Note Number is changed.

Transferring Song files to and from a connected computer

Even though this instrument has 100 preset songs, you can also transmit Song files from your computer to this instrument's Flash memory. Since the area in Flash memory is shared between User songs (U01–O05) and loaded songs, you may need to erase some User songs to load the data. Files of SMF format 0 that you've loaded to the instrument can be played. For details about how to transmit the data using the Musicsoft Downloader application, refer to the Online help topic "Transferring Data Between the Computer and Instrument (for unprotected data)" of the Musicsoft Downloader.

* The SMF (Standard MIDI File) format is one of the most common and widely compatible sequence formats used for storing sequence data. There are two variations: Format 0 and Format 1. A large number of MIDI devices are compatible with SMF Format 0, and most commercially available MIDI sequence data is provided in SMF Format.

■ Installing Musicsoft Downloader

You can download the "Musicsoft Downloader" application from the following website. Make sure that your computer has an Internet communication, and then install the application on your computer.

<http://music.yamaha.com/download/>



• You can obtain the latest version of the Musicsoft Downloader at the above website address.

● The minimum computer requirements for Musicsoft Downloader operation

OS	: Windows 98SE/Me/2000/XP Home Edition/XP Professional
CPU	: 233 MHz or higher; Intel® Pentium®/Celeron® processor family (500 MHz or more is recommended)
Memory	: 64 MB or more (256 MB or more is recommended)
Hard Disk	: at least 128 MB of free space (at least 512 MB of free space is recommended)
Display	: 800 x 600 HighColor (16-bit)
Other	: Microsoft® Internet Explorer®5.5 or higher

■ Connecting a personal computer

After installing the Musicsoft Downloader application on your computer, connect the instrument as described below.

A Yamaha UX16 or similar USB-MIDI interface (sold separately) will be necessary for MIDI connection between the instrument and a USB equipped computer.

Make sure to purchase a Yamaha UX16 or a quality USB-MIDI interface at a musical instrument store, computer store or electrical appliance store.

If you use the UX16 interface, install the driver supplied with the interface on your computer.

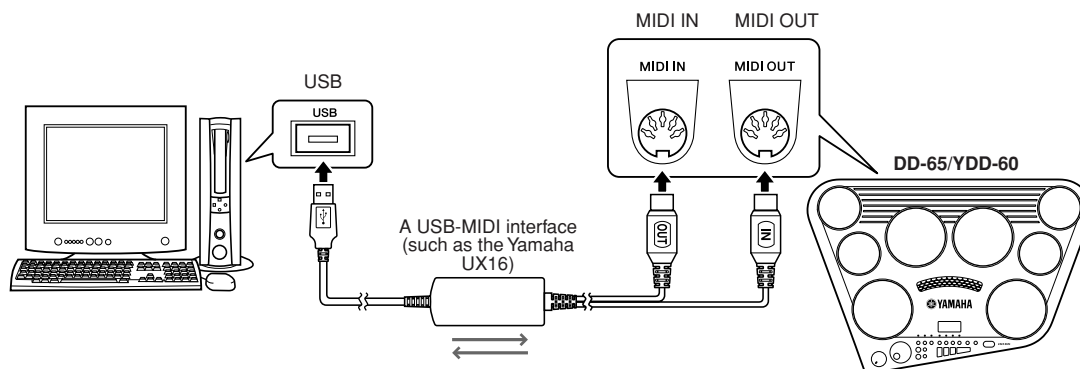

■ Transferring song files from a computer

You can transmit Song files from your computer to your instrument's Flash Memory. For details about how to transmit the data using the Musicsoft Downloader application, refer to the Online help topic "Transferring Data Between the Computer and Instrument (for unprotected data)" of the Musicsoft Downloader.



- The Musicsoft Downloader application may not be able to access the instrument in the following cases:
 - During Demo playback
 - During Song playback
 - During recording

● Data that can be loaded to the instrument from a computer

Songs	: 5 Songs max (U01–U05)
Data	: 70 Kbytes per song
Song data Format	: SMF Format 0
Song data	: *.MID (MIDI Song)

CAUTION

- Use the power adaptor when transferring data. The data can be corrupted if the batteries fail during the transfer.
- Note that user songs 01 to 05 are commonly used for songs you've recorded and/or loaded. Be careful not to erase your important data.
- Never turn the power off and never plug/unplug the AC power adaptor during data transmission. Not only will the data fail to be transferred and saved, but operation of the flash memory may become unstable and its contents may disappear completely when the power is turned on or off.



- Close the window to exit from the Musicsoft Downloader and re-enable control of the instrument.

■ Transferring user song files from the instrument to a computer ..

You can transfer the User Songs or loaded Songs from computer stored to the instrument, to a computer by using Musicsoft Downloader. For details about how to transmit Song data using the Musicsoft Downloader application, refer to the Online help topic "Transferring Data Between the Computer and Instrument (for unprotected data)" in the application.

● Data that can be transferred to a computer from the instrument

- User songs (U01–U05)



- Preset Song data cannot be transmitted from the instrument.
- Do not rename the user file on the computer. If you do so, it will not be recognized when transferred to the instrument.

● Erasing Transferred Song from the instrument's Memory

To erase all Memory (including data transferred from a computer), use the Initial Clear function on page 36.

To erase specific Songs transferred from the computer, use the Delete function on Musicsoft Downloader.

Backup and Initialization.....

Backup

Some internal parameters will be backed up to internal memory even if the power is turned off. You can initialize all internal memory to the default settings or initialize the memory excepting the Songs.

Following parameters remain in memory

- User Songs (including songs loaded from computer)
- Custom Kit
- Touch Sensitivity
- Auto Kit Select ON/OFF
- Song Volume
- Click Volume
- Pad Start ON/OFF
- MIDI note number
- MIDI Note Number Auto Selection ON/OFF
- Equalization ON/OFF

Initialization

This function erases all backup data in the instrument's flash memory and restores the initial default settings. The following initialization procedures are provided.

■ Initial Clear.....

To clear all data backed up to the internal flash memory (described above), turn the power on by pressing the [STANDBY/ON] switch while holding the [DEMO] button. The backed up data will be erased and the default values restored.

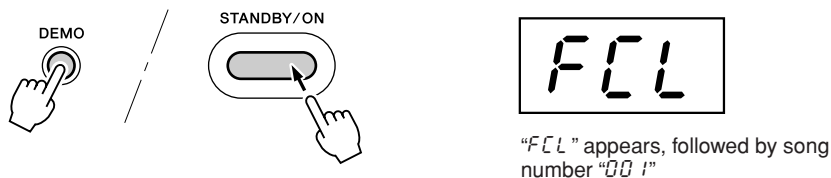

CAUTION

- When you execute the Initial Clear operation, all backup data will be cleared. You can save the data of the five built-in User Songs to a computer by using Musicsoft Downloader.

■ Back Up Clear.....

To clear all backed up data, with the exception of song data, that has been memorized to the internal flash memory, turn the power on by pressing the [STANDBY/ON] switch while holding the [FUNCTION] button.

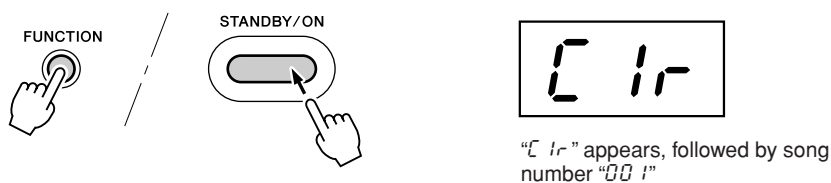

Troubleshooting

In many cases, problems or malfunctions that occur during use can be remedied easily. Please check the following list before deciding that your instrument is damaged. If the suggested remedy is ineffective, take the instrument to an authorized Yamaha dealer for proper diagnosis and repair. Do not attempt to repair this digital instrument by yourself as serious damage may occur.

Problem	Cause/Solution
A buzz or click occurs momentarily when the instrument is turned ON or OFF	This is a normal power surge noise that occurs when the POWER switch is operated.
The LED display is completely dark.	The batteries are low and should be replaced with a complete set of six new batteries immediately. Ideally, an optional AC adaptor should be used to power the instrument (see page 8).
When the pads are struck, the display is dark and returns to "00 1".	
The Custom Kit voice assignments have disappeared or defaulted.	
When using a mobile phone, noise is produced.	Using a mobile phone in close proximity to the instrument may produce interference. To prevent this, turn off the mobile phone or use it further away from the instrument.
No sound comes from the speakers.	<ul style="list-style-type: none"> • The volume is set too low. Adjust the volume (see page 12). • A plug is inserted into the PHONES/OUTPUT jack and should be taken out (see page 9). • The LOCAL ON/OFF is set to OFF. Set the LOCAL ON/OFF to ON (see page 31).
The selected voice does not sound when the pad is struck.	Use the PAD ASSIGN function to program the desired voice to the appropriate pad (see page 16).
The desired voice has not been assigned to the pad.	
Suddenly "FL" appears and recording is stopped.	The amount of recorded data has exceeded the limit of 10,000 notes.
Song is automatically started when Pad is struck.	Pad Start is set to ON. Set Pad Start to OFF. (See page 23.)

Drum Voice List

● Panel Voice List

Voice No.	Voice Name
*1	Bass Drum AMB+
*2	Bass Drum Power Open
*3	Bass Drum Power Closed
4	Bass Drum Soft
5	Bass Drum Hard
6	Bass Drum
7	Bass Drum 2
8	Bass Drum H
9	BD Rock
10	BD Gate
11	BD Analog L
12	BD Analog H
13	AnBD Dance-1
14	AnBD Dance-2
15	AnBD Dance-3
16	BD Jazz
17	Bass Drum L
18	Gran Cassa
19	Gran Cassa Mute
*20	Snare Soft Power 1
*21	Snare Power 1
*22	Snare Rough 1
*23	Open Rim Power 1
*24	Snare Power 2
*25	Snare Rough 2
26	Snare H Soft
27	Snare M
28	Snare H Hard
29	Open Rim Shot
30	Snare H Soft 2
31	Snare M 2
32	Snare H Hard 2
33	Open Rim Shot 2
34	SD Room L
35	SD Room H
36	SD Rock H
37	SD Rock L
38	SD Rock Rim
39	Snare L
40	SD Elec L
41	Analog Snare 1
42	AnSD Snappy
43	AnSD Q
44	AnSD Ana+Acoustic
45	AnSD OpenRim
46	SD Jazz L
47	SD Jazz M
48	Marching Sn M
49	Marching Sn H
50	Brush Tap
51	Brush Slap
*52	Tom Power 6
*53	Tom Power 5
*54	Tom Power 4

Voice No.	Voice Name
*55	Tom Power 3
*56	Tom Power 2
*57	Tom Power 1
58	High Tom
59	Mid Tom H
60	Mid Tom L
61	Low Tom
62	Floor Tom H
63	Floor Tom L
64	Room Tom 6
65	Room Tom 5
66	Room Tom 4
67	Room Tom 3
68	Room Tom 2
69	Room Tom 1
70	Rock Tom 6
71	Rock Tom 5
72	Rock Tom 4
73	Rock Tom 3
74	Rock Tom 2
75	Rock Tom 1
76	E Tom 6
77	E Tom 5
78	E Tom 4
79	E Tom 3
80	E Tom 2
81	E Tom 1
82	Analog Tom 6
83	Analog Tom 5
84	Analog Tom 4
85	Analog Tom 3
86	Analog Tom 2
87	Analog Tom 1
88	Jazz Tom 6
89	Jazz Tom 5
90	Jazz Tom 4
91	Jazz Tom 3
92	Jazz Tom 2
93	Jazz Tom 1
94	Brush Tom 6
95	Brush Tom 5
96	Brush Tom 4
97	Brush Tom 3
98	Brush Tom 2
99	Brush Tom 1
**100	Hi-Hat Closed Power 1
**101	Hi-Hat Pedal Power
**102	Hi-Hat Open Power
**103	Hi-Hat Closed Power 2
*104	Hi-Hat Closed
*105	Hi-Hat Pedal
*106	Hi-Hat Open
*107	Analog HH Closed 1
*108	Analog HH Closed 2

Voice No.	Voice Name
*109	Analog HH Open
*110	Analog HH Closed 3
*111	Analog HH Closed 4
*112	Analog HH Open 2
*113	Crash Cymbal Stereo 1
*114	Crash Cymbal Stereo 2
*115	Ride Cymbal Stereo 1
*116	Ride Cymbal Stereo 2
*117	Ride Cymbal Cup Stereo
*118	Chinese Cymbal Power
*119	Splash Cymbal Power
120	Crash Cymbal 1
121	Crash Cymbal 2
122	Ride Cymbal 1
123	Ride Cymbal 2
124	Ride Cymbal Cup
125	Chinese Cymbal
126	Splash Cymbal
127	Analog Cymbal
*128	Side Stick Power
129	Side Stick
130	Analog Side Stick
131	Hand Clap
132	Sticks
133	Castanet
134	Tambourine 1
135	Tambourine 2
136	Finger Snap
137	Vibraslap
138	Conga H Tip
139	Conga H Heel
140	Conga H Open
141	Conga H Mute
142	Conga H Slap Open
143	Conga H Slap
144	Conga H Slap Mute
145	Conga L Open
146	Conga L Mute
147	Conga L Slap Open
148	Conga L Slide
149	Bongo H Open 1 Finger
150	Bongo H Open 3 Finger
151	Bongo H Rim
152	Bongo H Tip
153	Bongo H Heel
154	Bongo H Slap
155	Bongo L Open 1 Finger
156	Bongo L Open 3 Finger
157	Bongo L Rim
158	Bongo L Slap
159	Timbale H Open
160	Timbale L Open
161	Timbale Paila H
162	Timbale Paila L

Voice No.	Voice Name
163	Cowbell Top
164	Agogo H
165	Agogo L
166	Cabasa
167	Maracas
168	Guiro Short
169	Guiro Long
170	Claves
171	Wood Block H
172	Wood Block L
173	Cuica Mute
174	Cuica Open
175	Triangle Mute
176	Triangle Open
177	Shaker
178	Jingle Bell
179	Wind Chime
180	Surdo Mute
181	Surdo Open
182	Tablah Tak 4
183	Tablah Tak 2
184	Tablah Sak 1
185	Tablah Dom 1
186	Daholla Dom
187	Riq Snouj 2
188	Riq Tak 1
189	Riq Tak 2
190	Riq Brass 2
191	Riq Dom
192	Kattem Dom
193	Kattem Sak 2
194	Sagat 2
195	Baya Ge
196	Baya Ke
197	Baya Ghe
198	Baya Ka
199	Tabla Na
200	Tabla Tin
201	Tabla Di
202	Tabla Ne
203	Bangu

Voice No.	Voice Name
204	Paigu Middle
205	Dagu Heavy
206	Zhongcha Open
207	Zhongcha Mute
208	Luo Big
209	Luo High
210	Zhongluo Open
211	Xiaoluo Open
212	Xiaocha Mute
213	Muyu Mid
214	Cajon Lo
215	Cajon Mute
216	Cajon Slap
217	Djembe Lo
218	Djembe Mute
219	Djembe Slap
220	PotDrum Open
221	PotDrum Close
222	TalkingDrum Open
223	TalkingDrum BendUp
224	TalkingDrum Slap
225	TalkingDrum LeftHand-Open
226	Oodaiko
227	Oodaiko Rim
228	Yaguradaiko
229	Yaguradaiko Rim
230	Atarigane
231	Shimedaiko
232	Tsudumi
233	Ainote
234	Scratch Cut
235	Scratch
236	Laugh
237	Scream
238	Punch
239	Car Crash
240	Yo!
241	Go!
242	Get up!
243	Whoow!
244	Huaah!

Voice No.	Voice Name
245	Uh!+Hit
246	Footsteps
247	Frog
248	Rooster
249	Dog
250	Cat
251	Owl
252	Horse Neigh
253	Cow
254	Lion

● Phrase List

Voice No.	Voice Name
255	Simple Rock
256	Pop Rock
257	R & R
258	Groove Rock
259	Hard Rock
260	Black Contemporary
261	Hard Shuffles
262	Blues Shuffle
263	AOR
264	Soul
265	Club Mix
266	House
267	Jazz Funk
268	Ballad
269	R & B
270	Motown
271	Urban Funk
272	Fusion
273	Fusion Samba
274	Jazz
275	Arabic
276	Indian
277	African
278	Conga
279	Timbal

◆ The voice is recorded in stereo.

* By assigning Closed and Open Hi-Hat voices to both the Pad and Foot Pedal 2, those voices can be controlled with the Foot Pedal 2 as follows:

- Strike the pad while pressing the Foot Pedal 2, the "Closed" Hi-Hat voice will sound.
- Strike the pad without pressing the Foot Pedal 2, the "Open" Hi-Hat voice will sound.
- Press the Foot Pedal 2 without striking the pad, the Hi-Hat "Pedal" voice will sound.
- If these voices have been assigned to more than one pad, only the left-most pad can be used with the Pedal function (Closed/Open).

NOTE:

- Phrase data cannot be transmitted.
- The pan data for each voice is fixed and cannot be changed, regardless of the pad assignments. For example, if a voice containing a "left" pan setting is assigned to a right pad, the actual sound will come from the left.

Song List

Song No.	Song Name	Difficulty
Demo		
001	DD Funk	-
002	16Beat Ballad	-
003	Swing Jazz	-
004	Latin Pop	-
005	World Beat	-
Pattern		
006	8 Beat 1	Easy
007	8 Beat 2	Easy
008	8 Beat 3	Easy
009	8 Beat 4	Easy
010	8 Beat Pop	Easy
011	8 Beat Rock'n Roll	Nomal
012	16 Beat 1	Nomal
013	16 Beat 2	Nomal
014	16 Beat 3	Nomal
015	16 Beat Dance	Nomal
016	Hard Rock 1	Nomal
017	Hard Rock 2	Nomal
018	Hard Rock 3	Difficult
019	8 Beat Ballad 1	Easy
020	8 Beat Ballad 2	Nomal
021	16 Beat Ballad 1	Easy
022	16 Beat Ballad 2	Nomal
023	16 Beat Ballad 3	Nomal
024	16 Beat Ballad 4	Nomal
025	16 Beat Shuffle 1	Difficult
026	16 Beat Shuffle 2	Difficult
027	6/8 Ballad	Easy
028	6/8 Slow Rock 1	Easy
029	6/8 Slow Rock 2	Nomal
030	Pop Shuffle 1	Nomal
031	Pop Shuffle 2	Nomal
032	Rock'n Roll Shuffle	Nomal
033	Dance Soul	Nomal
034	Dance Beat	Difficult
035	Hip Hop Ballad	Nomal

Song No.	Song Name	Difficulty
036	Hip Hop Shuffle 1	Nomal
037	Hip Hop Shuffle 2	Nomal
038	Techno Pop	Nomal
039	Disco 1	Nomal
040	Disco 2	Nomal
041	Disco 3	Nomal
042	4 Beat	Easy
043	Big Band	Nomal
044	Swing Jazz	Nomal
045	Swing	Easy
046	5/4 Jazz	Difficult
047	Dixieland	Nomal
048	Soul 1	Nomal
049	Soul 2	Nomal
050	Funk	Nomal
051	Soul Funk	Nomal
052	Rock'n Roll	Nomal
053	6/8 Blues	Nomal
054	Country	Nomal
055	Light Pop	Nomal
056	Samba	Nomal
057	Bossa Nova 1	Nomal
058	Bossa Nova 2	Nomal
059	Conga Bossa Nova	Easy
060	Montuno	Nomal
061	Mambo 1	Nomal
062	Mambo 2	Nomal
063	Chacha	Easy
064	Rhumba	Nomal
065	Salsa	Nomal
066	Beguine	Nomal
067	Reggae	Nomal
068	Waltz	Easy
069	Swing Waltz	Nomal
070	Jazz Waltz	Difficult
071	March 1	Nomal
072	March 2	Nomal

Song No.	Song Name	Difficulty
073	6/8 March	Nomal
074	Arabic	Difficult
075	Indian	Difficult
076	African	Difficult
077	Folklore	Difficult
078	Japanese 1	Nomal
079	Japanese 2	Nomal
080	Chinese	Nomal
Song		
081	8 Beat Pop	Nomal
082	8 Beat Rock	Nomal
083	16 Beat Pop	Nomal
084	Hard Rock	Nomal
085	16 Beat Ballad	Nomal
086	6/8 Ballad	Nomal
087	Pop Rock	Nomal
088	Bossa Nova	Nomal
089	Pop Shuffle	Nomal
090	Rock'n Roll	Nomal
091	Club Mix	Nomal
092	Fusion Shuffle	Nomal
093	Blues Shuffle	Nomal
094	Funk	Difficult
095	Disco	Nomal
096	Jazz Funk	Difficult
097	Fast Jazz 1	Difficult
098	Fast Jazz 2	Difficult
099	Fusion Samba	Difficult
100	Latin Fusion	Difficult

Demo: These songs demonstrate the drum sounds and rhythms.

Pattern: These are special loop-repeating patterns for drum practice. A variety of basic patterns are included in this type.

Song: These include drum and fill-in patterns, and are ideal for general practice purposes.

Drum Kit List

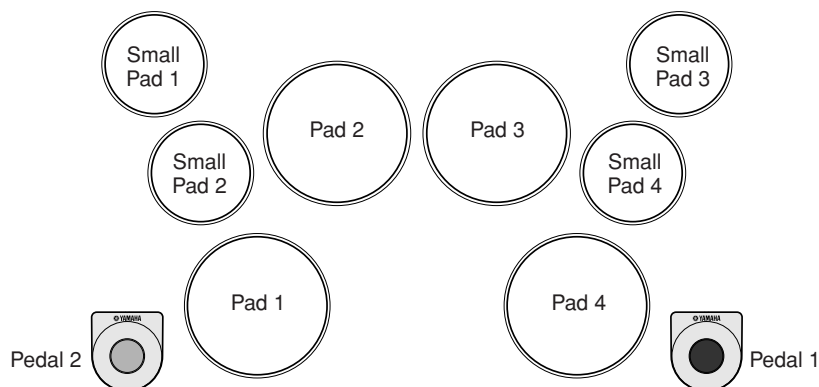

Kit No.	Kit Name	Voice #	Pedal 1	Voice #	Pedal 2
01	Stereo Kit 1	3	Bass Drum Power Closed	101	Hi-Hat Pedal Power
02	Stereo Kit 2	2	Bass Drum Power Open	101	Hi-Hat Pedal Power
03	Stereo Kit 3	1	Bass Drum AMB+	101	Hi-Hat Pedal Power
04	Stereo Kit 4	1	Bass Drum AMB+	101	Hi-Hat Pedal Power
05	Stereo Kit 5	3	Bass Drum Power Closed	101	Hi-Hat Pedal Power
06	Hard Rock Kit 1	9	BD Rock	105	Hi-Hat Pedal
07	Hard Rock Kit 2	9	BD Rock	105	Hi-Hat Pedal
08	Stereo Ballad Kit	1	Bass Drum AMB+	101	Hi-Hat Pedal Power
09	Ballad Kit 1	6	Bass Drum	105	Hi-Hat Pedal
10	Ballad Kit 2	7	Bass Drum 2	105	Hi-Hat Pedal
11	Analog Ballad Kit 1	12	BD Analog H	108	Analog HH Closed 2
12	Analog Ballad Kit 2	11	BD Analog L	108	Analog HH Closed 2
13	Stereo Shuffle Kit 1	2	Bass Drum Power Open	101	Hi-Hat Pedal Power
14	Stereo Shuffle Kit 2	3	Bass Drum Power Closed	101	Hi-Hat Pedal Power
15	Stereo Shuffle Kit 3	3	Bass Drum Power Closed	101	Hi-Hat Pedal Power
16	Stereo Slow Rock Kit	3	Bass Drum Power Closed	101	Hi-Hat Pedal Power
17	Electronic Kit 1	10	BD Gate	105	Hi-Hat Pedal
18	Electronic Kit 2	10	BD Gate	105	Hi-Hat Pedal
19	Dance Kit 1	14	AnBD Dance-2	111	Analog HH Closed 4
20	Dance Kit 2	15	AnBD Dance-3	111	Analog HH Closed 4
21	Analog Kit	12	BD Analog H	108	Analog HH Closed 2
22	DJ Kit	13	AnBD Dance-1	111	Analog HH Closed 4
23	Disco Kit 1	6	Bass Drum	105	Hi-Hat Pedal
24	Disco Kit 2	14	AnBD Dance-2	111	Analog HH Closed 4
25	Jazz Kit	16	BD Jazz	105	Hi-Hat Pedal
26	Brush Kit	5	Bass Drum Hard	105	Hi-Hat Pedal
27	5/4 Jazz Kit	4	Bass Drum Soft	105	Hi-Hat Pedal
28	Dixieland Kit	5	Bass Drum Hard	105	Hi-Hat Pedal
29	Soul Kit	2	Bass Drum Power Open	101	Hi-Hat Pedal Power
30	R & R Kit	6	Bass Drum	105	Hi-Hat Pedal
31	6/8 Blues Kit	1	Bass Drum AMB+	101	Hi-Hat Pedal Power
32	Country Kit	6	Bass Drum	105	Hi-Hat Pedal
33	Samba Kit	3	Bass Drum Power Closed	101	Hi-Hat Pedal Power
34	BossaNova Kit 1	5	Bass Drum Hard	105	Hi-Hat Pedal
35	BossaNova Kit 2	2	Bass Drum Power Open	101	Hi-Hat Pedal Power
36	Conga Kit	6	Bass Drum	163	Cowbell Top
37	Conga & Bongo Kit	7	Bass Drum 2	163	Cowbell Top
38	Salsa Kit	6	Bass Drum	171	Wood Block H
39	Beguine Kit	5	Bass Drum Hard	105	Hi-Hat Pedal
40	Reggae Kit	1	Bass Drum AMB+	101	Hi-Hat Pedal Power
41	Waltz Kit	16	BD Jazz	105	Hi-Hat Pedal
42	March Kit	18	Gran Cassa	105	Hi-Hat Pedal
43	Arabic Kit	192	Katem Dom	193	Katem Sak 2
44	Indian Kit	186	Daholla Dom	187	Riq Snouj 2
45	African Kit	6	Bass Drum	166	Cabasa
46	Folklore Kit	6	Bass Drum	178	Jingle Bell
47	Japanese Kit	233	Ainote	178	Jingle Bell
48	China Kit	205	Bangzi	207	Bangu
49	SE Kit 1	246	Footsteps	246	Footsteps
50	SE Kit 2	238	Punch	246	Footsteps

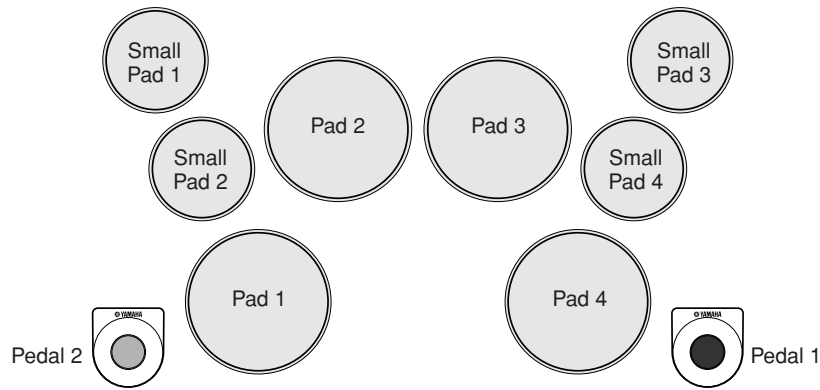

Kit No.	Kit Name	Voice #	Pad 1	Voice #	Pad 2	Voice #	Pad 3	Voice #	Pad 4
01	Stereo Kit 1	21	Snare Power 1	52	Tom Power 6	54	Tom Power 4	56	Tom Power 2
02	Stereo Kit 2	24	Snare Power 2	53	Tom Power 5	55	Tom Power 3	57	Tom Power 1
03	Stereo Kit 3	25	Snare Rough 2	52	Tom Power 6	54	Tom Power 4	56	Tom Power 2
04	Stereo Kit 4	20	Snare Soft Power 1	54	Tom Power 4	56	Tom Power 2	128	Side Stick Power
05	Stereo Kit 5	22	Snare Rough 1	52	Tom Power 6	54	Tom Power 4	56	Tom Power 2
06	Hard Rock Kit 1	38	SD Rock Rim	70	Rock Tom 6	72	Rock Tom 4	74	Rock Tom 2
07	Hard Rock Kit 2	37	SD Rock L	65	Room Tom 5	67	Room Tom 3	69	Room Tom 1
08	Stereo Ballad Kit	21	Snare Power 1	53	Tom Power 5	55	Tom Power 3	57	Tom Power 1
09	Ballad Kit 1	27	Snare M	60	Mid Tom L	62	Floor Tom H	129	Side Stick
10	Ballad Kit 2	30	Snare H Soft 2	60	Mid Tom L	62	Floor Tom H	129	Side Stick
11	Analog Ballad Kit 1	41	Analog Snare 1	82	Analog Tom 6	84	Analog Tom 4	86	Analog Tom 2
12	Analog Ballad Kit 2	41	Analog Snare 1	82	Analog Tom 6	84	Analog Tom 4	86	Analog Tom 2
13	Stereo Shuffle Kit 1	22	Snare Rough 1	52	Tom Power 6	54	Tom Power 4	56	Tom Power 2
14	Stereo Shuffle Kit 2	25	Snare Rough 2	52	Tom Power 6	54	Tom Power 4	56	Tom Power 2
15	Stereo Shuffle Kit 3	25	Snare Rough 2	52	Tom Power 6	54	Tom Power 4	56	Tom Power 2
16	Stereo Slow Rock Kit	20	Snare Soft Power 1	52	Tom Power 6	54	Tom Power 4	56	Tom Power 2
17	Electronic Kit 1	40	SD Elec L	76	E Tom 6	78	E Tom 4	80	E Tom 2
18	Electronic Kit 2	39	Snare L	76	E Tom 6	78	E Tom 4	80	E Tom 2
19	Dance Kit 1	43	AnSD Q	82	Analog Tom 6	84	Analog Tom 4	86	Analog Tom 2
20	Dance Kit 2	42	AnSD Snappy	82	Analog Tom 6	84	Analog Tom 4	86	Analog Tom 2
21	Analog Kit	41	Analog Snare 1	131	Hand Clap	85	Analog Tom 3	87	Analog Tom 1
22	DJ Kit	45	Analog Snare OpenRim	234	Scratch Cut	235	Scratch	87	Analog Tom 1
23	Disco Kit 1	28	Snare H Hard	59	Mid Tom H	61	Low Tom	63	Floor Tom L
24	Disco Kit 2	42	AnSD Snappy	131	Hand Clap	84	Analog Tom 4	86	Analog Tom 2
25	Jazz Kit	46	SD Jazz L	88	Jazz Tom 6	90	Jazz Tom 4	92	Jazz Tom 2
26	Brush Kit	51	Brush Slap	94	Brush Tom 6	96	Brush Tom 4	98	Brush Tom 2
27	5/4 Jazz Kit	30	Snare H Soft 2	58	High Tom	60	Mid Tom L	62	Floor Tom H
28	Dixieland Kit	30	Snare H Soft 2	50	Brush Tap	51	Brush Slap	63	Floor Tom L
29	Soul Kit	25	Snare Rough 2	53	Tom Power 5	55	Tom Power 3	57	Tom Power 1
30	R & R Kit	26	Snare H Soft	58	High Tom	60	Mid Tom L	62	Floor Tom H
31	6/8 Blues Kit	20	Snare Soft Power 1	53	Tom Power 5	55	Tom Power 3	57	Tom Power 1
32	Country Kit	34	SD Room L	66	Room Tom 4	68	Room Tom 2	129	Side Stick
33	Samba Kit	22	Snare Rough 1	165	Agogo L	164	Agogo H	181	Surdo Open
34	BossaNova Kit 1	129	Side Stick	95	Brush Tom 5	97	Brush Tom 3	51	Brush Slap
35	BossaNova Kit 2	21	Snare Power 1	52	Tom Power 6	54	Tom Power 4	128	Side Stick Power
36	Conga Kit	144	Conga H Slap Mute	140	Conga H Open	148	Conga L Slide	145	Conga L Open
37	Conga & Bongo Kit	140	Conga H Open	145	Conga L Open	149	Bongo H Open 1F	156	Bongo L Open 3F
38	Salsa Kit	61	Low Tom	156	Bongo L Open 3F	159	Timbale H Open	160	Timbale L Open
39	Beguine Kit	26	Snare H Soft	61	Low Tom	63	Floor Tom L	129	Side Stick
40	Reggae Kit	22	Snare Rough 1	159	Timbale H Open	160	Timbale L Open	57	Tom Power 1
41	Waltz Kit	51	Brush Slap	171	Wood Block H	172	Wood Block L	98	Brush Tom 2
42	March Kit	48	Marching Sn M	135	Tambourine 2	134	Tambourine 1	49	Marching Sn H
43	Arabic Kit	185	Tablah Dom 1	183	Tablah Tak 2	188	Riq Tak 1	191	Riq Dom
44	Indian Kit	197	Baya Ghe	195	Baya Ge	199	Tabla Na	201	Tabla Di
45	African Kit	219	Djembe Slap	217	Djembe Lo	225	TalkingDrum LeftHand-Open	223	TalkingDrum BendUp
46	Folklore Kit	220	PotDrum Open	215	Cajon Mute	216	Cajon Slap	214	Cajon Lo
47	Japanese Kit	226	Oodaiko	231	Shimedaiko	230	Atarigane	228	Yaguradaiko
48	China Kit	204	Paigu Middle	203	Bangu	212	Xiaocha Mute	208	Luo big
49	SE Kit 1	248	Rooster	252	Horse Neigh	253	Cow	254	Lion
50	SE Kit 2	236	Laugh	244	Huuah!	245	Uh!+Hit	237	Scream

Kit No.	Voice #	Small Pad 1	Voice #	Small Pad 2	Voice #	Small Pad 3	Voice #	Small Pad 4
01	113	Crash Cymbal Stereo 1	100	Hi-Hat Closed Power 1	116	Ride Cymbal Stereo 2	119	Splash Cymbal Stereo
02	113	Crash Cymbal Stereo 1	103	Hi-Hat Closed Power 2	116	Ride Cymbal Stereo 2	119	Splash Cymbal Stereo
03	113	Crash Cymbal Stereo 1	103	Hi-Hat Closed Power 2	116	Ride Cymbal Stereo 2	119	Splash Cymbal Stereo
04	113	Crash Cymbal Stereo 1	100	Hi-Hat Closed Power 1	116	Ride Cymbal Stereo 2	119	Splash Cymbal Stereo
05	113	Crash Cymbal Stereo 1	100	Hi-Hat Closed Power 1	116	Ride Cymbal Stereo 2	119	Splash Cymbal Stereo
06	120	Crash Cymbal 1	104	Hi-Hat Closed	122	Ride Cymbal 1	125	Chinese Cymbal
07	120	Crash Cymbal 1	104	Hi-Hat Closed	122	Ride Cymbal 1	125	Chinese Cymbal
08	113	Crash Cymbal Stereo 1	100	Hi-Hat Closed Power 1	116	Ride Cymbal Stereo 2	119	Splash Cymbal Stereo
09	120	Crash Cymbal 1	104	Hi-Hat Closed	122	Ride Cymbal 1	135	Tambourine 2
10	120	Crash Cymbal 1	104	Hi-Hat Closed	122	Ride Cymbal 1	135	Tambourine 2
11	127	Analog Cymbal	107	Analog HH Closed 1	123	Ride Cymbal 2	170	Claves
12	127	Analog Cymbal	107	Analog HH Closed 1	123	Ride Cymbal 2	170	Claves
13	113	Crash Cymbal Stereo 1	100	Hi-Hat Closed Power 1	116	Ride Cymbal Stereo 2	119	Splash Cymbal Stereo
14	113	Crash Cymbal Stereo 1	103	Hi-Hat Closed Power 2	116	Ride Cymbal Stereo 2	119	Splash Cymbal Stereo
15	113	Crash Cymbal Stereo 1	103	Hi-Hat Closed Power 2	116	Ride Cymbal Stereo 2	134	Tambourine 1
16	113	Crash Cymbal Stereo 1	100	Hi-Hat Closed Power 1	116	Ride Cymbal Stereo 2	119	Splash Cymbal Stereo
17	120	Crash Cymbal 1	104	Hi-Hat Closed	122	Ride Cymbal 1	125	Chinese Cymbal
18	120	Crash Cymbal 1	104	Hi-Hat Closed	122	Ride Cymbal 1	125	Chinese Cymbal
19	127	Analog Cymbal	110	Analog HH Closed 3	176	Triangle Open	175	Triangle Mute
20	127	Analog Cymbal	110	Analog HH Closed 3	131	Hand Clap	135	Tambourine 2
21	127	Analog Cymbal	107	Analog HH Closed 1	163	Cowbell Top	135	Tambourine 2
22	127	Analog Cymbal	110	Analog HH Closed 3	122	Ride Cymbal 1	121	Crash Cymbal 2
23	120	Crash Cymbal 1	104	Hi-Hat Closed	122	Ride Cymbal 1	126	Splash Cymbal
24	127	Analog Cymbal	110	Analog HH Closed 3	121	Crash Cymbal 2	135	Tambourine 2
25	120	Crash Cymbal 1	104	Hi-Hat Closed	122	Ride Cymbal 1	124	Ride Cymbal Cup
26	120	Crash Cymbal 1	104	Hi-Hat Closed	122	Ride Cymbal 1	124	Ride Cymbal Cup
27	120	Crash Cymbal 1	104	Hi-Hat Closed	122	Ride Cymbal 1	135	Tambourine 2
28	120	Crash Cymbal 1	104	Hi-Hat Closed	122	Ride Cymbal 1	125	Chinese Cymbal
29	113	Crash Cymbal Stereo 1	100	Hi-Hat Closed Power 1	116	Ride Cymbal Stereo 2	131	Hand Clap
30	120	Crash Cymbal 1	104	Hi-Hat Closed	122	Ride Cymbal 1	126	Splash Cymbal
31	113	Crash Cymbal Stereo 1	100	Hi-Hat Closed Power 1	116	Ride Cymbal Stereo 2	131	Hand Clap
32	120	Crash Cymbal 1	104	Hi-Hat Closed	122	Ride Cymbal 1	126	Splash Cymbal
33	113	Crash Cymbal Stereo 1	100	Hi-Hat Closed Power 1	116	Ride Cymbal Stereo 2	119	Splash Cymbal Stereo
34	120	Crash Cymbal 1	104	Hi-Hat Closed	122	Ride Cymbal 1	179	Bell Tree
35	113	Crash Cymbal Stereo 1	100	Hi-Hat Closed Power 1	116	Ride Cymbal Stereo 2	118	Chinese Cymbal Stereo
36	138	Conga H Tip	139	Conga H Heel	168	Guiro Short	169	Guiro Long
37	139	Conga H Heel	144	Conga H Slap Mute	121	Crash Cymbal 2	152	Bongo H Tip
38	170	Claves	149	Bongo H Open 1F	123	Ride Cymbal 2	163	Cowbell Top
39	120	Crash Cymbal 1	104	Hi-Hat Closed	122	Ride Cymbal 1	170	Claves
40	113	Crash Cymbal Stereo 1	100	Hi-Hat Closed Power 1	116	Ride Cymbal Stereo 2	125	Chinese Cymbal
41	120	Crash Cymbal 1	104	Hi-Hat Closed	122	Ride Cymbal 1	179	Wind Chime
42	120	Crash Cymbal 1	104	Hi-Hat Closed	122	Ride Cymbal 1	179	Wind Chime
43	184	Tablah Sak 1	182	Tablah Tak 4	189	Riq Tak 2	190	Riq Brass 2
44	196	Baya Ke	198	Baya Ka	202	Tabla Ne	200	Tabla Tin
45	120	Crash Cymbal 1	218	Djembe Mute	224	TalkingDrum Slap	222	TalkingDrum Open
46	164	Agogo H	221	PotDrum Close	165	Agogo L	163	Cowbell Top
47	232	Tsudumi	227	Oodaiko Rim	170	Claves	229	Yaguradaiko Rim
48	210	Zhongluo Open	206	Zhongcha Open	209	Luo High	211	Xiaocha Mute
49	250	Cat	249	Dog	247	Frog	251	Owl
50	241	Go!	242	Get up!	239	Car Crash	240	Yo!

Voice List

■ Maximum Polyphony

The instrument has 32-note maximum polyphony. This means that it can play a maximum of up to 32 notes at once, regardless of what functions are used. Auto accompaniment uses a number of the available notes, so when auto accompaniment is used the total number of available notes for playing on the pads is correspondingly reduced.

NOTE

- The Voice List includes MIDI program change numbers for each voice. Use these program change numbers when playing the instrument via MIDI from an external device.
- Program Numbers 001 to 128 directly relate to MIDI Program Change Numbers 000 to 127. That is, Program Numbers and Program Change Numbers differ by a value of 1. Remember to take this into consideration.

Bank Select		MIDI	Voice Name
MSB (0-127)	LSB (0-127)	Program Change# (1-128)	
PIANO			
0	112	1	Grand Piano
0	112	2	Bright Piano
0	112	7	Harpsichord
0	112	4	Honky-tonk Piano
0	112	3	MIDI Grand Piano
0	113	3	CP 80
E.PIANO			
0	114	5	Cool! Galaxy Electric Piano
0	113	6	Hyper Tines
0	112	5	Funky Electric Piano
0	112	6	DX Modern Electric Piano
0	114	6	Venus Electric Piano
0	112	8	Clavi
ORGAN			
0	112	17	Jazz Organ 1
0	113	17	Jazz Organ 2
0	112	19	Rock Organ
0	114	19	Purple Organ
0	112	18	Click Organ
0	116	17	Bright Organ
0	127	19	Theater Organ
0	121	20	16'+2' Organ
0	120	20	16'+4' Organ
0	113	20	Chapel Organ
0	112	20	Church Organ
0	112	21	Reed Organ
ACCORDION			
0	112	22	Musette Accordion
0	113	22	Traditional Accordion
0	113	24	Bandoneon
0	112	23	Harmonica
GUITAR			
0	112	25	Classical Guitar
0	112	26	Folk Guitar
0	112	27	Jazz Guitar
0	117	28	60's Clean Guitar
0	113	26	12Strings Guitar
0	112	28	Clean Guitar
0	113	27	Octave Guitar
0	112	29	Muted Guitar
0	112	30	Overdriven Guitar
0	112	31	Distortion Guitar
BASS			
0	112	34	Finger Bass
0	112	33	Acoustic Bass
0	112	35	Pick Bass
0	112	36	Fretless Bass
0	112	37	Slap Bass
0	112	39	Synth Bass
0	113	39	Hi-Q Bass
0	113	40	Dance Bass
STRINGS			
0	112	49	String Ensemble
0	112	50	Chamber Strings

Bank Select		MIDI	Voice Name
MSB (0-127)	LSB (0-127)	Program Change# (1-128)	
0	113	50	Slow Strings
0	112	45	Tremolo Strings
0	112	51	Synth Strings
0	112	46	Pizzicato Strings
0	112	41	Violin
0	112	43	Cello
0	112	44	Contrabass
0	112	47	Harp
0	112	106	Banjo
0	112	56	Orchestra Hit
CHOIR			
0	112	53	Choir
0	113	53	Vocal Ensemble
0	112	55	Air Choir
0	112	54	Vox Humana
SAXOPHONE			
0	112	67	Tenor Sax
0	112	66	Alto Sax
0	112	65	Soprano Sax
0	112	68	Baritone Sax
0	114	67	Breathy Tenor Sax
0	112	72	Clarinet
0	112	69	Oboe
0	112	70	English Horn
0	112	71	Bassoon
TRUMPET			
0	112	57	Trumpet
0	112	58	Trombone
0	113	58	Trombone Section
0	112	60	Muted Trumpet
0	112	61	French Horn
0	112	59	Tuba
BRASS			
0	112	62	Brass Section
0	113	62	Big Band Brass
0	113	63	80's Brass
0	119	62	Mellow Horns
0	114	63	Techno Brass
0	112	63	Synth Brass
FLUTE			
0	112	74	Flute
0	112	73	Piccolo
0	112	76	Pan Flute
0	112	75	Recorder
0	112	80	Ocarina
SYNTH			
0	112	81	Square Lead
0	112	82	Sawtooth Lead
0	115	82	Analogon
0	119	82	Fargo
0	112	99	Star Dust
0	112	86	Voice Lead
0	112	101	Brightness
0	112	92	Xenon Pad
0	112	95	Equinox

Bank Select		MIDI Program Change# (1-128)	Voice Name
MSB (0-127)	LSB (0-127)		
0	112	89	Fantasia
0	113	90	Dark Moon
0	113	101	Bell Pad
PERCUSSION			
0	112	12	Vibraphone
0	112	13	Marimba
0	112	14	Xylophone
0	112	115	Steel Drums
0	112	9	Celesta
0	112	11	Music Box
0	112	15	Tubular Bells
0	112	48	Timpani
DRUM KITS			
127	0	1	Standard Kit 1
127	0	2	Standard Kit 2
127	0	9	Room Kit
127	0	17	Rock Kit
127	0	25	Electronic Kit
127	0	26	Analog Kit
127	0	113	Dance Kit
127	0	33	Jazz Kit
127	0	41	Brush Kit
127	0	49	Symphony Kit
127	0	88	Stereo Power Kit 1
127	0	89	Stereo Power Kit 2
126	0	1	SFX Kit 1
126	0	2	SFX Kit 2
126	0	35	China Kit
126	0	37	Arabic Kit
126	0	40	Indian Kit
126	0	44	Pop Latin Kit
126	0	113	Sound Effect Kit
126	0	114	World Kit
XG PIANO			
0	0	1	Grand Piano
0	1	1	Grand Piano KSP
0	40	1	Piano Strings
0	41	1	Dream
0	0	2	Bright Piano
0	1	2	Bright Piano KSP
0	0	3	Electric Grand Piano
0	1	3	Electric Grand Piano KSP
0	32	3	Detuned CP80
0	0	4	Honky-tonk Piano
0	1	4	Honky-tonk Piano KSP
0	0	5	Electric Piano 1
0	1	5	Electric Piano 1 KSP
0	32	5	Chorus Electric Piano 1
0	0	6	Electric Piano 2
0	1	6	Electric Piano 2 KSP
0	32	6	Chorus Electric Piano 2
0	41	6	DX + Analog Electric Piano
0	0	7	Harpsichord
0	1	7	Harpsichord KSP
0	35	7	Harpsichord 2
0	0	8	Clavi
0	1	8	Clavi KSP
XG CHROMATIC			
0	0	9	Celesta
0	0	10	Glockenspiel
0	0	11	Music Box
0	64	11	Orgel
0	0	12	Vibraphone
0	1	12	Vibraphone KSP
0	0	13	Marimba
0	1	13	Marimba KSP
0	64	13	Sine Marimba
0	97	13	Balimba
0	98	13	Log Drums
0	0	14	Xylophone

Bank Select		MIDI Program Change# (1-128)	Voice Name
MSB (0-127)	LSB (0-127)		
0	0	15	Tubular Bells
0	96	15	Church Bells
0	97	15	Carillon
0	0	16	Dulcimer
0	35	16	Dulcimer 2
0	96	16	Cimbalom
0	97	16	Santur
XG ORGAN			
0	0	17	Drawbar Organ
0	32	17	Detuned Drawbar Organ
0	33	17	60's Drawbar Organ 1
0	34	17	60's Drawbar Organ 2
0	35	17	70's Drawbar Organ 1
0	37	17	60's Drawbar Organ 3
0	40	17	16+2'2/3
0	64	17	Organ Bass
0	65	17	70's Drawbar Organ 2
0	66	17	Cheezy Organ
0	67	17	Drawbar Organ 2
0	0	18	Percussive Organ
0	24	18	70's Percussive Organ
0	32	18	Detuned Percussive Organ
0	33	18	Light Organ
0	37	18	Percussive Organ 2
0	0	19	Rock Organ
0	64	19	Rotary Organ
0	65	19	Slow Rotary
0	66	19	Fast Rotary
0	0	20	Church Organ
0	32	20	Church Organ 3
0	35	20	Church Organ 2
0	40	20	Notre Dame
0	64	20	Organ Flute
0	65	20	Tremolo Organ Flute
0	0	21	Reed Organ
0	40	21	Puff Organ
0	0	22	Accordion
0	0	23	Harmonica
0	32	23	Harmonica 2
0	0	24	Tango Accordion
0	64	24	Tango Accordion 2
XG GUITAR			
0	0	25	Nylon Guitar
0	43	25	Velocity Guitar Harmonics
0	96	25	Ukulele
0	0	26	Steel Guitar
0	35	26	12-string Guitar
0	40	26	Nylon & Steel Guitar
0	41	26	Steel Guitar with Body Sound
0	96	26	Mandolin
0	0	27	Jazz Guitar
0	32	27	Jazz Amp
0	0	28	Clean Guitar
0	32	28	Chorus Guitar
0	0	29	Muted Guitar
0	40	29	Funk Guitar
0	41	29	Muted Steel Guitar
0	45	29	Jazz Man
0	0	30	Overdriven Guitar
0	43	30	Guitar Pinch
0	0	31	Distortion Guitar
0	40	31	Feedback Guitar
0	41	31	Feedback Guitar 2
0	0	32	Guitar Harmonics
0	65	32	Guitar Feedback
0	66	32	Guitar Harmonics 2
XG BASS			
0	0	33	Acoustic Bass
0	40	33	Jazz Rhythm
0	45	33	Velocity Crossfade Upright Bass

Bank Select		MIDI Program Change# (1-128)	Voice Name
MSB (0-127)	LSB (0-127)		
0	0	34	Finger Bass
0	18	34	Finger Dark
0	40	34	Bass & Distorted Electric Guitar
0	43	34	Finger Slap Bass
0	45	34	Finger Bass 2
0	65	34	Modulated Bass
0	0	35	Pick Bass
0	28	35	Muted Pick Bass
0	0	36	Fretless Bass
0	32	36	Fretless Bass 2
0	33	36	Fretless Bass 3
0	34	36	Fretless Bass 4
0	0	37	Slap Bass 1
0	32	37	Punch Thumb Bass
0	0	38	Slap Bass 2
0	43	38	Velocity Switch Slap
0	0	39	Synth Bass 1
0	40	39	Techno Synth Bass
0	0	40	Synth Bass 2
0	6	40	Mellow Synth Bass
0	12	40	Sequenced Bass
0	18	40	Click Synth Bass
0	19	40	Synth Bass 2 Dark
0	40	40	Modular Synth Bass
0	41	40	DX Bass
XG STRINGS			
0	0	41	Violin
0	8	41	Slow Violin
0	0	42	Viola
0	0	43	Cello
0	0	44	Contrabass
0	0	45	Tremolo Strings
0	8	45	Slow Tremolo Strings
0	40	45	Suspense Strings
0	0	46	Pizzicato Strings
0	0	47	Orchestral Harp
0	40	47	Yang Chin
0	0	48	Timpani
XG ENSEMBLE			
0	0	49	Strings 1
0	3	49	Stereo Strings
0	8	49	Slow Strings
0	35	49	60's Strings
0	40	49	Orchestra
0	41	49	Orchestra 2
0	42	49	Tremolo Orchestra
0	45	49	Velocity Strings
0	0	50	Strings 2
0	3	50	Stereo Slow Strings
0	8	50	Legato Strings
0	40	50	Warm Strings
0	41	50	Kingdom
0	0	51	Synth Strings 1
0	0	52	Synth Strings 2
0	0	53	Choir Aahs
0	3	53	Stereo Choir
0	32	53	Mellow Choir
0	40	53	Choir Strings
0	0	54	Voice Oohs
0	0	55	Synth Voice
0	40	55	Synth Voice 2
0	41	55	Choral
0	64	55	Analog Voice
0	0	56	Orchestra Hit
0	35	56	Orchestra Hit 2
0	64	56	Impact
XG BRASS			
0	0	57	Trumpet
0	32	57	Warm Trumpet
0	0	58	Trombone

Bank Select		MIDI Program Change# (1-128)	Voice Name
MSB (0-127)	LSB (0-127)		
0	18	58	Trombone 2
0	0	59	Tuba
0	0	60	Muted Trumpet
0	0	61	French Horn
0	6	61	French Horn Solo
0	32	61	French Horn 2
0	37	61	Horn Orchestra
0	0	62	Brass Section
0	35	62	Trumpet & Trombone Section
0	0	63	Synth Brass 1
0	20	63	Resonant Synth Brass
0	0	64	Synth Brass 2
0	18	64	Soft Brass
0	41	64	Choir Brass
XG REED			
0	0	65	Soprano Sax
0	0	66	Alto Sax
0	40	66	Sax Section
0	0	67	Tenor Sax
0	40	67	Breathy Tenor Sax
0	0	68	Baritone Sax
0	0	69	Oboe
0	0	70	English Horn
0	0	71	Bassoon
0	0	72	Clarinet
XG PIPE			
0	0	73	Piccolo
0	0	74	Flute
0	0	75	Recorder
0	0	76	Pan Flute
0	0	77	Blown Bottle
0	0	78	Shakuhachi
0	0	79	Whistle
0	0	80	Ocarina
XG SYNTH LEAD			
0	0	81	Square Lead
0	6	81	Square Lead 2
0	8	81	LM Square
0	18	81	Hollow
0	19	81	Shroud
0	64	81	Mellow
0	65	81	Solo Sine
0	66	81	Sine Lead
0	0	82	Sawtooth Lead
0	6	82	Sawtooth Lead 2
0	8	82	Thick Sawtooth
0	18	82	Dynamic Sawtooth
0	19	82	Digital Sawtooth
0	20	82	Big Lead
0	96	82	Sequenced Analog
0	0	83	Calliope Lead
0	65	83	Pure Lead
0	0	84	Chiff Lead
0	0	85	Charang Lead
0	64	85	Distorted Lead
0	0	86	Voice Lead
0	0	87	Fifths Lead
0	35	87	Big Five
0	0	88	Bass & Lead
0	16	88	Big & Low
0	64	88	Fat & Perky
0	65	88	Soft Whirl
XG SYNTH PAD			
0	0	89	New Age Pad
0	64	89	Fantasy
0	0	90	Warm Pad
0	0	91	Poly Synth Pad
0	0	92	Choir Pad
0	66	92	Itopia
0	0	93	Bowed Pad

Bank Select		MIDI Program Change# (1-128)	Voice Name
MSB (0-127)	LSB (0-127)		
0	0	94	Metallic Pad
0	0	95	Halo Pad
0	0	96	Sweep Pad
XG SYNTH EFFECTS			
0	0	97	Rain
0	65	97	African Wind
0	66	97	Carib
0	0	98	Sound Track
0	27	98	Prologue
0	0	99	Crystal
0	12	99	Synth Drum Comp
0	14	99	Popcorn
0	18	99	Tiny Bells
0	35	99	Round Glockenspiel
0	40	99	Glockenspiel Chimes
0	41	99	Clear Bells
0	42	99	Chorus Bells
0	65	99	Soft Crystal
0	70	99	Air Bells
0	71	99	Bell Harp
0	72	99	Gamelimba
0	0	100	Atmosphere
0	18	100	Warm Atmosphere
0	19	100	Hollow Release
0	40	100	Nylon Electric Piano
0	64	100	Nylon Harp
0	65	100	Harp Vox
0	66	100	Atmosphere Pad
0	0	101	Brightness
0	0	102	Goblins
0	64	102	Goblins Synth
0	65	102	Creeper
0	67	102	Ritual
0	68	102	To Heaven
0	70	102	Night
0	71	102	Glisten
0	96	102	Bell Choir
0	0	103	Echoes
0	0	104	Sci-Fi
XG WORLD			
0	0	105	Sitar
0	32	105	Detuned Sitar
0	35	105	Sitar 2
0	97	105	Tamboura
0	0	106	Banjo
0	28	106	Muted Banjo
0	96	106	Rabab
0	97	106	Gopichant
0	98	106	Oud
0	0	107	Shamisen
0	0	108	Koto
0	96	108	Taisho-kin
0	97	108	Kanoon
0	0	109	Kalimba
0	0	110	Bagpipe
0	0	111	Fiddle
0	0	112	Shanai
XG PERCUSSIVE			
0	0	113	Tinkle Bell
0	96	113	Bonang
0	97	113	Altair
0	98	113	Gamelan Gongs
0	99	113	Stereo Gamelan Gongs
0	100	113	Rama Cymbal
0	0	114	Agogo
0	0	115	Steel Drums
0	97	115	Glass Percussion
0	98	115	Thai Bells
0	0	116	Woodblock
0	96	116	Castanets

Bank Select		MIDI Program Change# (1-128)	Voice Name
MSB (0-127)	LSB (0-127)		
0	0	117	Taiko Drum
0	96	117	Gran Cassa
0	0	118	Melodic Tom
0	64	118	Melodic Tom 2
0	65	118	Real Tom
0	66	118	Rock Tom
0	0	119	Synth Drum
0	64	119	Analog Tom
0	65	119	Electronic Percussion
0	0	120	Reverse Cymbal
XG SOUND EFFECTS			
0	0	121	Fret Noise
0	0	122	Breath Noise
0	0	123	Seashore
0	0	124	Bird Tweet
0	0	125	Telephone Ring
0	0	126	Helicopter
0	0	127	Applause
0	0	128	Gunshot
64	0	1	Cutting Noise
64	0	2	Cutting Noise 2
64	0	4	String Slap
64	0	17	Flute Key Click
64	0	33	Shower
64	0	34	Thunder
64	0	35	Wind
64	0	36	Stream
64	0	37	Bubble
64	0	38	Feed
64	0	49	Dog
64	0	50	Horse
64	0	51	Bird Tweet 2
64	0	56	Maou
64	0	65	Phone Call
64	0	66	Door Squeak
64	0	67	Door Slam
64	0	68	Scratch Cut
64	0	69	Scratch Split
64	0	70	Wind Chime
64	0	71	Telephone Ring 2
64	0	81	Car Engine Ignition
64	0	82	Car Tires Squeal
64	0	83	Car Passing
64	0	84	Car Crash
64	0	85	Siren
64	0	86	Train
64	0	87	Jet Plane
64	0	88	Starship
64	0	89	Burst
64	0	90	Roller Coaster
64	0	91	Submarine
64	0	97	Laugh
64	0	98	Scream
64	0	99	Punch
64	0	100	Heartbeat
64	0	101	Footsteps
64	0	113	Machine Gun
64	0	114	Laser Gun
64	0	115	Explosion
64	0	116	Firework

The voice with an asterisk (*) is XGlite optional voice.

Drum Map

- " " indicates that in the column on the immediate left.
- Each percussion voice uses one note.
- The MIDI Note # and Note are actually one octave lower than listed. For example, in "Standard Kit 1", the "Seq Click H" (Note# 36/Note C1) corresponds to (Note# 24/Note C0).
- If you strike several pads simultaneously which are assigned to the same alternate assign number, the instrument will sound only one voice.
- The alternate assign number only applies to the voices of MSB 127.

MSB (0-127) / LSB (0-127) / PC (1-128)				127/000/001		127/000/002	127/000/009	127/000/017	127/000/025	127/000/026	
Keyboard		MIDI		Key Off	Alternate assign	Standard Kit 1	Standard Kit 2	Room Kit	Rock Kit	Electronic Kit	Analog Kit
Note#	Note	Note#	Note								
25	C# 0	13	C# -1		3	Surdo Mute					
26	D 0	14	D -1		3	Surdo Open					
27	D# 0	15	D# -1			Hi Q					
28	E 0	16	E -1			Whip Slap					
29	F 0	17	F -1		4	Scratch Push					
30	F# 0	18	F# -1		4	Scratch Pull					
31	G 0	19	G -1			Finger Snap					
32	G# 0	20	G# -1			Click Noise					
33	A 0	21	A -1			Metronome Click					
34	A# 0	22	A# -1			Metronome Bell					
35	B 0	23	B -1			Seq Click L					
36	C 1	24	C 0			Seq Click H					
37	C# 1	25	C# 0			Brush Tap					
38	D 1	26	D 0	O		Brush Swirl					
39	D# 1	27	D# 0			Brush Slap					
40	E 1	28	E 0	O		Brush Tap Swirl				Reverse Cymbal	Reverse Cymbal
41	F 1	29	F 0	O		Snare Roll					
42	F# 1	30	F# 0			Castanet				Hi Q 2	Hi Q 2
43	G 1	31	G 0			Snare H Soft	Snare H Soft 2		SD Rock H	Snare L	SD Rock H
44	G# 1	32	G# 0			Sticks					
45	A 1	33	A 0			Bass Drum Soft				Bass Drum H	Bass Drum H
46	A# 1	34	A# 0			Open Rim Shot	Open Rim Shot 2				
47	B 1	35	B 0			Bass Drum Hard			Bass Drum H	BD Rock	BD Analog L
48	C 2	36	C 1			Bass Drum	Bass Drum 2		BD Rock	BD Gate	BD Analog H
49	C# 2	37	C# 1			Side Stick					Analog Side Stick
50	D 2	38	D 1			Snare M	Snare M 2	SD Room L	SD Rock L	SD Rock L	Analog Snare 1
51	D# 2	39	D# 1			Hand Clap					
52	E 2	40	E 1			Snare H Hard	Snare H Hard 2	SD Room H	SD Rock Rim	SD Rock H	Analog Snare 2
53	F 2	41	F 1			Floor Tom L		Room Tom 1	Rock Tom 1	E Tom 1	Analog Tom 1
54	F# 2	42	F# 1	1		Hi-Hat Closed					Analog HH Closed 1
55	G 2	43	G 1			Floor Tom H		Room Tom 2	Rock Tom 2	E Tom 2	Analog Tom 2
56	G# 2	44	G# 1	1		Hi-Hat Pedal					Analog HH Closed 2
57	A 2	45	A 1			Low Tom		Room Tom 3	Rock Tom 3	E Tom 3	Analog Tom 3
58	A# 2	46	A# 1	1		Hi-Hat Open					Analog HH Open
59	B 2	47	B 1			Mid Tom L		Room Tom 4	Rock Tom 4	E Tom 4	Analog Tom 4
60	C 3	48	C 2			Mid Tom H		Room Tom 5	Rock Tom 5	E Tom 5	Analog Tom 5
61	C# 3	49	C# 2			Crash Cymbal 1					Analog Cymbal
62	D 3	50	D 2			High Tom		Room Tom 6	Rock Tom 6	E Tom 6	Analog Tom 6
63	D# 3	51	D# 2			Ride Cymbal 1					
64	E 3	52	E 2			Chinese Cymbal					
65	F 3	53	F 2			Ride Cymbal Cup					
66	F# 3	54	F# 2			Tambourine 2					
67	G 3	55	G 2			Splash Cymbal					
68	G# 3	56	G# 2			Cowbell					Analog Cowbell
69	A 3	57	A 2			Crash Cymbal 2					
70	A# 3	58	A# 2			Vibraslap					
71	B 3	59	B 2			Ride Cymbal 2					
72	C 4	60	C 3			Bongo H					
73	C# 4	61	C# 3			Bongo L					
74	D 4	62	D 3			Conga H Mute					Analog Conga H
75	D# 4	63	D# 3			Conga H Open					Analog Conga M
76	E 4	64	E 3			Conga L					Analog Conga L
77	F 4	65	F 3			Timbale H					
78	F# 4	66	F# 3			Timbale L					
79	G 4	67	G 3			Agogo H					
80	G# 4	68	G# 3			Agogo L					
81	A 4	69	A 3			Cabasa					
82	A# 4	70	A# 3			Maracas					Analog Maracas
83	B 4	71	B 3	O		Samba Whistle H					
84	C 5	72	C 4	O		Samba Whistle L					
85	C# 5	73	C# 4			Guiro Short					
86	D 5	74	D 4	O		Guiro Long					
87	D# 5	75	D# 4			Claves					Analog Claves
88	E 5	76	E 4			Wood Block H					
89	F 5	77	F 4			Wood Block L					
90	F# 5	78	F# 4			Cuica Mute			Scratch Push	Scratch Push	
91	G 5	79	G 4			Cuica Open			Scratch Pull	Scratch Pull	
92	G# 5	80	G# 4		2	Triangle Mute					
93	A 5	81	A 4		2	Triangle Open					
94	A# 5	82	A# 4			Shaker					
95	B 5	83	B 4			Jingle Bell					
96	C 6	84	C 5			Bell Tree					
97	C# 6	85	C# 5								
98	D 6	86	D 5								
99	D# 6	87	D# 5								
100	E 6	88	E 5								
101	F 6	89	F 5								
102	F# 6	90	F# 5								
103	G 6	91	G 5								

MSB (0-127) / LSB (0-127) / PC (1-128)				127/000/001		127/000/113	127/000/033	127/000/041	127/000/049	127/000/88	
Keyboard		MIDI		Key Off	Alternate assign	Standard Kit 1	Dance Kit	Jazz Kit	Brush Kit	Symphony Kit	Stereo Power Kit 1
Note#	Note	Note#	Note								
25	C# 0	13	C# -1		3	Surdo Mute					
26	D 0	14	D -1		3	Surdo Open					
27	D# 0	15	D# -1			Hi Q					
28	E 0	16	E -1			Whip Slap					
29	F 0	17	F -1		4	Scratch Push					
30	F# 0	18	F# -1		4	Scratch Pull					
31	G 0	19	G -1			Finger Snap					
32	G# 0	20	G# -1			Click Noise					
33	A 0	21	A -1			Metronome Click					
34	A# 0	22	A# -1			Metronome Bell					
35	B 0	23	B -1			Seq Click L					
36	C 1	24	C 0			Seq Click H					
37	C# 1	25	C# 0			Brush Tap					
38	D 1	26	D 0	O		Brush Swirl					
39	D# 1	27	D# 0			Brush Slap					
40	E 1	28	E 0	O		Brush Tap Swirl	Reverse Cymbal				
41	F 1	29	F 0	O		Snare Roll					
42	F# 1	30	F# 0			Castanet	Hi Q 2				
43	G 1	31	G 0			Snare H Soft	AnSD Snappy	SD Jazz H Light	Brush Slap L		Snare Soft Power 1
44	G# 1	32	G# 0			Sticks					
45	A 1	33	A 0			Bass Drum Soft	AnBD Dance-1			Bass Drum L	Bass Drum AMB+
46	A# 1	34	A# 0			Open Rim Shot	AnSD OpenRim				Open Rim Power 1
47	B 1	35	B 0			Bass Drum Hard	AnBD Dance-2				Bass Drum Power Open
48	C 2	36	C 1			Bass Drum	AnBD Dance-3	BD Jazz	BD Jazz	Gran Cassa	Bass Drum Power Closed
49	C# 2	37	C# 1			Side Stick	Analog Side Stick			Gran Cassa Mute	Bass Drum Power Closed
50	D 2	38	D 1			Snare M	AnSD Q	SD Jazz L	Brush Slap	Marching Sn M	Side Stick Power
51	D# 2	39	D# 1			Hand Clap					Snare Power 1
52	E 2	40	E 1			Snare H Hard	AnSD Ana+Acoustic	SD Jazz M	Brush Tap	Marching Sn H	Snare Rough 1
53	F 2	41	F 1			Floor Tom L	Analog Tom 1	Jazz Tom 1	Brush Tom 1	Jazz Tom 1	Tom Power 1
54	F# 2	42	F# 1	1		Hi-Hat Closed	Analog HH Closed 3				Hi-Hat Closed Power 1
55	G 2	43	G 1			Floor Tom H	Analog Tom 2	Jazz Tom 2	Brush Tom 2	Jazz Tom 2	Tom Power 2
56	G# 2	44	G# 1	1		Hi-Hat Pedal	Analog HH Closed 4				Hi-Hat Pedal Power
57	A 2	45	A 1			Low Tom	Analog Tom 3	Jazz Tom 3	Brush Tom 3	Jazz Tom 3	Tom Power 3
58	A# 2	46	A# 1	1		Hi-Hat Open	Analog HH Open 2				Hi-Hat Open Power
59	B 2	47	B 1			Mid Tom L	Analog Tom 4	Jazz Tom 4	Brush Tom 4	Jazz Tom 4	Tom Power 4
60	C 3	48	C 2			Mid Tom H	Analog Tom 5	Jazz Tom 5	Brush Tom 5	Jazz Tom 5	Tom Power 5
61	C# 3	49	C# 2			Crash Cymbal 1	Analog Cymbal			Hand Cym. L	Crash Cymbal Stereo 1
62	D 3	50	D 2			High Tom	Analog Tom 6	Jazz Tom 6	Brush Tom 6	Jazz Tom 6	Tom Power 6
63	D# 3	51	D# 2			Ride Cymbal 1				Hand Cym.Short L	Ride Cymbal Stereo 1
64	E 3	52	E 2			Chinese Cymbal					Chinese Cymbal Power
65	F 3	53	F 2			Ride Cymbal Cup					Ride Cymbal Cup Stereo
66	F# 3	54	F# 2			Tambourine 2					Tambourine 1
67	G 3	55	G 2			Splash Cymbal					Splash Cymbal Power
68	G# 3	56	G# 2			Cowbell	Analog Cowbell				
69	A 3	57	A 2			Crash Cymbal 2				Hand Cym. H	Crash Cymbal Stereo 2
70	A# 3	58	A# 2			Vibraslap					
71	B 3	59	B 2			Ride Cymbal 2				Hand Cym.Short H	Ride Cymbal Stereo 2
72	C 4	60	C 3			Bongo H					
73	C# 4	61	C# 3			Bongo L					
74	D 4	62	D 3			Conga H Mute	Analog Conga H				
75	D# 4	63	D# 3			Conga H Open	Analog Conga M				
76	E 4	64	E 3			Conga L	Analog Conga L				
77	F 4	65	F 3			Timbale H					
78	F# 4	66	F# 3			Timbale L					
79	G 4	67	G 3			Agogo H					
80	G# 4	68	G# 3			Agogo L					
81	A 4	69	A 3			Cabasa					
82	A# 4	70	A# 3			Maracas	Analog Maracas				
83	B 4	71	B 3	O		Samba Whistle H					
84	C 5	72	C 4	O		Samba Whistle L					
85	C# 5	73	C# 4			Guiro Short					
86	D 5	74	D 4	O		Guiro Long					
87	D# 5	75	D# 4			Claves	Analog Claves				
88	E 5	76	E 4			Wood Block H					
89	F 5	77	F 4			Wood Block L					
90	F# 5	78	F# 4			Cuica Mute	Scratch Push				
91	G 5	79	G 4			Cuica Open	Scratch Pull				
92	G# 5	80	G# 4		2	Triangle Mute					
93	A 5	81	A 4		2	Triangle Open					
94	A# 5	82	A# 4			Shaker					
95	B 5	83	B 4			Jingle Bell					
96	C 6	84	C 5			Bell Tree					WindChime
97	C# 6	85	C# 5								
98	D 6	86	D 5								
99	D# 6	87	D# 5								
100	E 6	88	E 5								
101	F 6	89	F 5								
102	F# 6	90	F# 5								
103	G 6	91	G 5								



MSB (0-127) / LSB (0-127) / PC (1-128)				127/000/001		127/000/89		126/000/001		126/000/002		126/000/035		126/000/037	
Keyboard		MIDI		Key Off	Alternate assign	Standard Kit 1	Stereo Power Kit 2	SFX Kit 1	SFX Kit 2	China Kit	Atabic Kit				
Note#	Note	Note#	Note												
25	C#	0	13	C#	-1	3	Surdo Mute								Zarb Back mf
26	D	0	14	D	-1	3	Surdo Open								Zarb Tom f
27	D#	0	15	D#	-1		Hi Q								Zarb Eshareh
28	E	0	16	E	-1		Whip Slap								Zarb Whipping
29	F	0	17	F	-1	4	Scratch Push								Tombak Tom f
30	F#	0	18	F#	-1	4	Scratch Pull								Neghareh Tom f
31	G	0	19	G	-1		Finger Snap								Tombak Back f
32	G#	0	20	G#	-1		Click Noise								Neghareh Back f
33	A	0	21	A	-1		Metronome Click								Tombak Snap f
34	A#	0	22	A#	-1		Metronome Bell								Neghareh Pelang f
35	B	0	23	B	-1		Seq Click L								Tombak Trill
36	C	1	24	C	0		Seq Click H								Luo Big
37	C#	1	25	C#	0		Brush Tap								Khaligi Clap 1
38	D	1	26	D	0	O	Brush Swirl								Zalgouta Open
39	D#	1	27	D#	0		Brush Slap								Khaligi Clap 2
40	E	1	28	E	0	O	Brush Tap Swirl								Zalgouta Close
41	F	1	29	F	0	O	Snare Roll								Arabic Hand Clap
42	F#	1	30	F#	0		Castanet								Tabel Tak 1
43	G	1	31	G	0		Snare H Soft								Sagat 1
44	G#	1	32	G#	0		Sticks								Tabel Dom
45	A	1	33	A	0		Bass Drum Soft								Sagat 2
46	A#	1	34	A#	0		Open Rim Shot								Tabel Tak 2
47	B	1	35	B	0		Bass Drum Hard								Sagat 3
48	C	2	36	C	1		Bass Drum			Cutting Noise	Phone Call	Bangu			Riq Tik 3
49	C#	2	37	C#	1		Side Stick			Cutting Noise 2	Door Squeak	Dagu Mute			Riq Tik 2
50	D	2	38	D	1		Snare M	Snare Power 2			Door Slam	Dagu Heavy			Riq Tik Hard 1
51	D#	2	39	D#	1		Hand Clap			String Slap	Scratch Cut	Paigu High			Riq Tik 1
52	E	2	40	E	1		Snare H Hard				Scratch	Paigu Middle			Riq Tik Hard 2
53	F	2	41	F	1		Floor Tom L				Wind Chime	Paigu Low			Riq Tik Hard 3
54	F#	2	42	F#	1	1	Hi-Hat Closed				Telephone Ring 2				Riq Tish
55	G	2	43	G	1		Floor Tom H								Riq Snouj 2
56	G#	2	44	G#	1	1	Hi-Hat Pedal								Riq Roll
57	A	2	45	A	1		Low Tom								Riq Snouj
58	A#	2	46	A#	1	1	Hi-Hat Open								Riq Sak
59	B	2	47	B	1		Mid Tom L								Riq Snouj 3
60	C	3	48	C	2		Mid Tom H								Riq Snouj 4
61	C#	3	49	C#	2		Crash Cymbal 1								Riq Tak 1
62	D	3	50	D	2		High Tom								Riq Brass 1
63	D#	3	51	D#	2		Ride Cymbal 1								Riq Tak 2
64	E	3	52	E	2		Chinese Cymbal			Flute Key Click	Car Engine Ignition	Zhongcha Mute			Riq Brass 2
65	F	3	53	F	2		Ride Cymbal Cup				Car Tires Squeal	Zhongcha Open			Riq Dom
66	F#	3	54	F#	2		Tambourine 2				Car Passing	Zhongluo Mute			Katem Tak Doff
67	G	3	55	G	2		Splash Cymbal				Car Crash	Zhongluo Open			Katem Dom
68	G#	3	56	G#	2		Cowbell				Siren	Xiaoluo Open			Katem Sak 1
69	A	3	57	A	2		Crash Cymbal 2				Train	Xiaocha Mute			Katem Tak 1
70	A#	3	58	A#	2		Vibraslap				Jet Plane	Xiaocha Open			Katem Sak 2
71	B	3	59	B	2		Ride Cymbal 2				Starship	Luo High			Katem Tak 2
72	C	4	60	C	3		Bongo H				Burst				Daholla Sak 2
73	C#	4	61	C#	3		Bongo L				Roller Coaster				Daholla Sak 1
74	D	4	62	D	3		Conga H Mute				Submarine				Daholla Tak 1
75	D#	4	63	D#	3		Conga H Open								Daholla Dom
76	E	4	64	E	3		Conga L								Daholla Tak 2
77	F	4	65	F	3		Timbale H								Tablah Prok
78	F#	4	66	F#	3		Timbale L								Tablah dom 2
79	G	4	67	G	3		Agogo H								Tabla Roll of Edge
80	G#	4	68	G#	3		Agogo L			Shower	Laugh	Bangzi			Tablah Tak Finger 4
81	A	4	69	A	3		Cabasa			Thunder	Scream	Muyu High			Tablah Tak Trill 1
82	A#	4	70	A#	3		Maracas			Wind	Punch	Muyu Mid-High			Tablah Tak Finger 3
83	B	4	71	B	3	O	Samba Whistle H			Stream	Heartbeat	Muyu Mid			Tablah Tak Trill 2
84	C	5	72	C	4	O	Samba Whistle L			Bubble	Footsteps	Muyu Mid-Low			Tablah Tak Finger 2
85	C#	5	73	C#	4		Guiro Short			Feed		Muyu Low			Tablah Tak Finger 1
86	D	5	74	D	4	O	Guiro Long								Tablah Tik 2
87	D#	5	75	D#	4		Claves								Tablah Tik 4
88	E	5	76	E	4		Wood Block H								Tablah Tik 3
89	F	5	77	F	4		Wood Block L								Tablah Tik 1
90	F#	5	78	F#	4		Cuica Mute								Tablah Tak 3
91	G	5	79	G	4		Cuica Open								Tablah Tak 1
92	G#	5	80	G#	4	2	Triangle Mute								Tablah Tak 4
93	A	5	81	A	4	2	Triangle Open								Tablah Tak 2
94	A#	5	82	A#	4		Shaker								Tablah Sak 2
95	B	5	83	B	4		Jingle Bell								Tablah Tremolo
96	C	6	84	C	5		Bell Tree								Tablah Sak 1
97	C#	6	85	C#	5			WindChime	Dog	Machine Gun					Tablah Dom 1
98	D	6	86	D	5				Horse	Laser Gun					
99	D#	6	87	D#	5				Bird Tweet 2	Explosion					
100	E	6	88	E	5					Firework					
101	F	6	89	F	5										
102	F#	6	90	F#	5										
103	G	6	91	G	5				Maou						

MSB (0-127) / LSB (0-127) / PC (1-128)				127/000/001	126/000/040	126/000/044	126/000/113	126/000/114		
Keyboard		MIDI		Key Off	Alternate assign	Standard Kit 1	Indian Kit	Pop Latin Kit	Sound Effect Kit	World Kit
Note#	Note	Note#	Note							
25	C# 0	13	C# -1		3	Surdo Mute				
26	D 0	14	D -1		3	Surdo Open				
27	D# 0	15	D# -1			Hi Q				
28	E 0	16	E -1			Whip Slap				
29	F 0	17	F -1		4	Scratch Push				
30	F# 0	18	F# -1		4	Scratch Pull		Hand Clap		
31	G 0	19	G -1			Finger Snap				
32	G# 0	20	G# -1			Click Noise				
33	A 0	21	A -1			Metronome Click				
34	A# 0	22	A# -1			Metronome Bell		Conga H Tip		
35	B 0	23	B -1			Seq Click L		Conga H Heel		
36	C 1	24	C 0			Seq Click H	Baya Ge	Conga H Open		
37	C# 1	25	C# 0			Brush Tap	Baya Ke	Conga H Mute		
38	D 1	26	D 0	O		Brush Swirl	Baya Ghe	Conga H Slap Open		
39	D# 1	27	D# 0			Brush Slap	Baya Ka	Conga H Slap		
40	E 1	28	E 0	O		Brush Tap Swirl	Tabla Na	Conga H Slap Mute		
41	F 1	29	F 0	O		Snare Roll	Tabla Tin	Conga L Tip		
42	F# 1	30	F# 0			Castanet	Tablabaya Dha	Conga L Heel	Drum Loop	
43	G 1	31	G 0			Snare H Soft	Tabla Tun	Conga L Open		
44	G# 1	32	G# 0			Sticks	Tablabaya Dhin	Conga L Mute		
45	A 1	33	A 0			Bass Drum Soft	Tabla Di	Conga L Slap Open		
46	A# 1	34	A# 0			Open Rim Shot	Tablabaya Dhe	Conga L Slap		
47	B 1	35	B 0			Bass Drum Hard	Tabla Ti	Conga L Slide		
48	C 2	36	C 1			Bass Drum	Tabla Ne	Bongo H Open 1 finger	Heartbeat	Cajon Lo
49	C# 2	37	C# 1			Side Stick	Tabla Taran	Bongo H Open 3 finger	Footsteps	Cajon Mute
50	D 2	38	D 1			Snare M	Tabla Tak	Bongo H Rim	Door Squeak	Cajon Slap
51	D# 2	39	D# 1			Hand Clap	Chipri	Bongo H Tip	Door Slam	
52	E 2	40	E 1			Snare H Hard	Kanjira Open	Bongo H Heel	Applause	
53	F 2	41	F 1			Floor Tom L	Kanjira Slap	Bongo H Slap	Camera	Djembe Lo
54	F# 2	42	F# 1	1		Hi-Hat Closed	Kanjira Mute	Bongo L Open 1 finger	Horn	Djembe Mute
55	G 2	43	G 1			Floor Tom H	Kanjira Bendup	Bongo L Open 3 finger	Hiccup	Djembe Slap
56	G# 2	44	G# 1	1		Hi-Hat Pedal	Kanjira Benddown	Bongo L Rim	Cuckoo Clock	
57	A 2	45	A 1			Low Tom	Dholak Open	Bongo L Tip	Stream	
58	A# 2	46	A# 1	1		Hi-Hat Open	Dholak Mute	Bongo L Heel	Frog	
59	B 2	47	B 1			Mid Tom L	Dholak Slap	Bongo L Slap	Rooster	
60	C 3	48	C 2			Mid Tom H	Dhol Open	Timbale L Open	Dog	PotDrum Open
61	C# 3	49	C# 2			Crash Cymbal 1	Dhol Mute		Cat	PotDrum Close
62	D 3	50	D 2			High Tom	Dhol Slap		Owl	
63	D# 3	51	D# 2			Ride Cymbal 1	Dhol Slide		Horse Gallop	
64	E 3	52	E 2			Chinese Cymbal	Mridangam Normal		Horse Neigh	
65	F 3	53	F 2			Ride Cymbal Cup	Mridangam Open	Timbale Paila L	Cow	TalkingDrum Open
66	F# 3	54	F# 2			Tambourine 2	Mridangam Mute	Timbale H Open	Lion	TalkingDrum BendUp
67	G 3	55	G 2			Splash Cymbal	Mridangam Slap		Scratch	TalkingDrum Slap
68	G# 3	56	G# 2			Cowbell	Mridangam Rim		Yo!	TalkingDrum LeftHand-Open
69	A 3	57	A 2			Crash Cymbal 2	Chimta Open		Go!	
70	A# 3	58	A# 2			Vibraslap	Chimta Normal		Get up!	
71	B 3	59	B 2			Ride Cymbal 2	Chimta Ring	Timbale Paila H	Whoow!	
72	C 4	60	C 3			Bongo H	Dholki Open	Cowbell Top		Oodaiko
73	C# 4	61	C# 3			Bongo L	Dholki Mute			Oodaiko Rim
74	D 4	62	D 3			Conga H Mute	Dholki Slap			
75	D# 4	63	D# 3			Conga H Open	Dholki Slide			
76	E 4	64	E 3			Conga L	Khol Open	Guiro Short		
77	F 4	65	F 3			Timbale H	Khol Slide	Guiro Long		
78	F# 4	66	F# 3			Timbale L	Khol Mute		Huuahh!	Yaguradaiko
79	G 4	67	G 3			Agogo H	Manjira Open			Yaguradaiko Rim
80	G# 4	68	G# 3			Agogo L	Manjira Closed	Tambourine		
81	A 4	69	A 3			Cabasa	Jhanji Open			
82	A# 4	70	A# 3			Maracas	Jhanji Closed			
83	B 4	71	B 3	O		Samba Whistle H	Mondira			Atarigane
84	C 5	72	C 4	O		Samba Whistle L	Mridang Open	Maracas		Shimedaiko
85	C# 5	73	C# 4			Guiro Short	Mridang Mute	Shaker		
86	D 5	74	D 4	O		Guiro Long	Mridang Rim	Cabasa		
87	D# 5	75	D# 4			Claves	Mridang Slide	Cuica Mute		
88	E 5	76	E 4			Wood Block H	Khomokh Normal	Cuica Open		Tsudumi
89	F 5	77	F 4			Wood Block L	Khomokh Mute			Ainote
90	F# 5	78	F# 4			Cuica Mute	Khomokh Mitak			
91	G 5	79	G 4			Cuica Open	Hateli Long			
92	G# 5	80	G# 4		2	Triangle Mute	Hateli Short			
93	A 5	81	A 4		2	Triangle Open		Triangle Mute		
94	A# 5	82	A# 4			Shaker		Triangle Open		
95	B 5	83	B 4			Jingle Bell				
96	C 6	84	C 5			Bell Tree		Wind Chime		
97	C# 6	85	C# 5							
98	D 6	86	D 5							
99	D# 6	87	D# 5							
100	E 6	88	E 5							
101	F 6	89	F 5							
102	F# 6	90	F# 5							
103	G 6	91	G 5							

Prog Change : True #	X *****	O 0 - 127	
System Exclusive	O *4	O *4	
: Song Pos.	X	X	
: Song Sel.	X	X	
: Tune	X	X	
System : Clock	O	X	
Real Time: Commands	O	X *2	
Aux : All Sound OFF	X	O (120, 126, 127)	
: Reset All Cntrl	X	O (121)	
: Local ON/OFF	X	O (122)	
: All Notes OFF	X	O (123-125)	
Mes- : Active Sense	O	O	
sages: Reset	X	X	

Mode 1 : OMNI ON , POLY Mode 2 : OMNI ON , MONO O : Yes
 Mode 3 : OMNI OFF, POLY Mode 4 : OMNI OFF, MONO X : No

NOTE:

- *1 Value of Pan for each drum pad and foot pedal is not transmitted via MIDI.
- *2 The DD-65/YDD-60 can accept Start/Stop signals, received via MIDI, by setting the MIDI clock to "External".
- *3 This data is transmitted only when it is contained in the song data.
- *4 Exclusive
 - <GM System ON> F0H, 7EH, 7FH, 09H, 01H, F7H
 - This message automatically restores all default settings for the instrument, with the exception of MIDI Master Tuning.
 - <MIDI Master Volume> F0H, 7FH, 7FH, 04H, 01H, ll, mm, F7H
 - This message allows the volume of all channels to be changed simultaneously (Universal System Exclusive).
 - The values of "mm" is used for MIDI Master Tuning. (Values for "ll" are ignored.)
 - <Reverb Type> F0H, 43H, 1nH, 4CH, 02H, 01H, 00H, mmH, llH, F7H
 - mm : Reverb Type MSB
 - ll : Reverb Type LSB
 Refer to the Effect Map (page 54) for details.

<Chorus Type> F0H, 43H, 1nH, 4CH, 02H, 01H, 20H, mmH, llH, F7H
 • mm : Chorus Type MSB
 • ll : Chorus Type LSB
 Refer to the Effect Map (page 54) for details.

<DRY Level> F0H, 43H, 1nH, 4CH, 08H, 0mH, 11H, llH, F7H
 • ll : Dry Level
 • 0m : Channel Number

- *5 Recording to an external sequencer from the DD-65/YDD-60 and playing back the data may result in selection of a different Reverb effect or a different kit.

Sending MIDI data from the DD-65/YDD-60 to an external tone generator may result in an unexpected voice, particularly if the tone generator doesn't have the same kind of voice as the DD-65/YDD-60.

■ **Effect map**

- * If the received value does not contain an effect type in the TYPE LSB, the LSB will be directed to TYPE 0.
- * The numbers in parentheses in front of the Effect Type names correspond to the number indicated in the display.

- * By using an external sequencer, which is capable of editing and transmitting the system exclusive messages and parameter changes, you can select the Reverb, Chorus and DSP effect types which are not accessible from the DD-65/YDD-60 panel itself.

● **REVERB**

TYPE MSB	TYPE LSB									
	00	01	02	08	16	17	18	19	20	
000	No Effect									
001	(1)Hall1				(2)Hall2	(3)Hall3				
002	Room					(4)Room1		(5)Room2		
003	Stage				(6)Stage1	(7)Stage2				
004	Plate				(8)Plate1	(9)Plate2				
005...127	No Effect									

● **CHORUS**

TYPE MSB	TYPE LSB									
	00	01	02	08	16	17	18	19	20	
000...064	No Effect									
065	Chorus		(2)Chorus2							
066	Celeste					(1)Chorus1				
067	Flanger			(3)Flanger1		(4)Flanger2				
068...127	No Effect									

Specifications

Drum Pads

8 pads (125mm x 4, 88mm x 4), Touch Sensitive

Maximum Polyphony

32

Drum Kits

50 Preset + 3 Custom

Songs

100

Tracks

4 (DRUM 1/DRUM 2/DRUM 3/BACKING)

Custom Song

5 Songs (approximately 10,000 notes per song)

Voices

Drum Voices 254 + phrase 25

Functions

HAND PERCUSSION ON/OFF, TRACK ON/OFF, TAP START, PAD START, BREAK, A-B REPEAT, DEMO

Panel Controls

ASSIGN button, REVERB button, HAND PERC. button, KIT button, CLICK button, SONG button, TEMPO button, PART MUTE DRUM 1-3, BACKING buttons, FUNCTION button, DEMO button, STANDBY/ON button, REC button, BREAK/TAP button, A-B REPEAT button, START/STOP button, DRUM PAD x 8

LED Display

Song/Drum Kit/Tempo etc.

Auxiliary jacks

DC IN12 V, AUX IN, PHONES/OUTPUT, MIDI IN/OUT, PEDAL 1/2

Main Amplifier

5W + 5W (EIAJ)

Speaker

8 cm x 2

Power Consumption

19 W

Power Supply

Adaptor : Yamaha PA-5D, PA-150, or an equivalent recommended by Yamaha (sold separately)

Batteries: Six "C" size, LR14 (R14P), or equivalent batteries (sold separately)

Dimensions (WxDxH)

602 x 411 x 180 mm (23-11/16" x 16-3/16" x 7-1/16")

Weight

4.5 kg (9 lbs., 15 oz.)

Supplied Accessories

Drum Stick x 2, Foot Pedal 1 & 2, Owner's Manual

Optional Accessories

AC Power Adaptor PA-5D, PA-150, or an equivalent

Headphones HPE-150/HPE-30

USB-MIDI interface UX16

Kick Pad KP65*

Hi-Hat Controller HH65

* Optional Foot Pedal is necessary when using the optional KP65.

Specifications and descriptions in this owner's manual are for information purposes only. Yamaha Corp. reserves the right to change or modify products or specifications at any time without prior notice. Since specifications, equipment or options may not be the same in every locale, please check with your Yamaha dealer.

Drum Score

There are many different types of drum score commercially available, but we've chosen the following common format for the examples below.

The following is an actual rhythm pattern using the notation.

■ 8 Beat (song No.010)

■ 16 Beat (song No.012)

■ 4 Beat (song No.042)

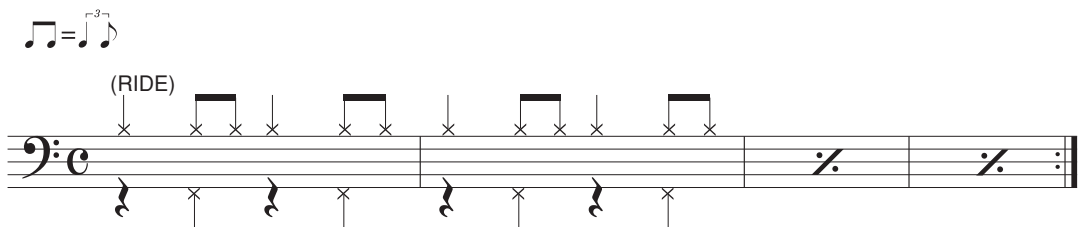

In the notation above, eighth notes are to be played with a triplet feel (as shown in the notation below). For swing and shuffle rhythms, this straight notation is preferable to the triplet indication since it is easier to read.

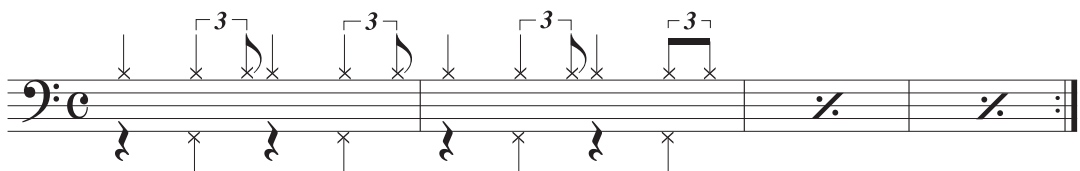

■ Shuffle (song No.030)

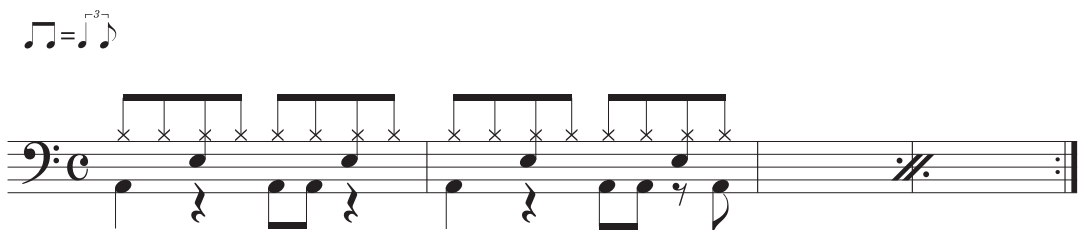

Play the above pattern with a swing feel.

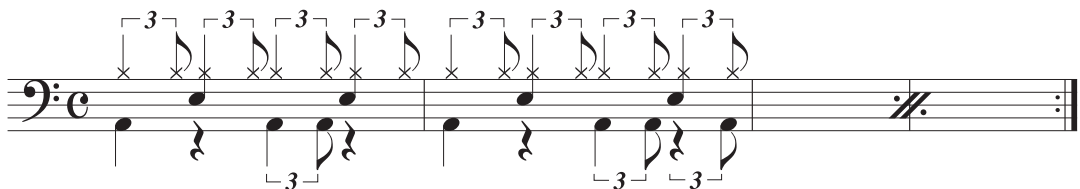

■ 16 Beat Shuffle (song No.026)

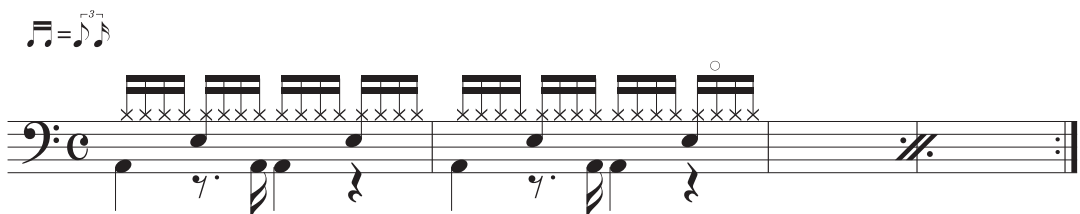

Play the above pattern with a swing feel.

Limited Warranty

90 DAYS LABOR

1 YEAR PARTS

Yamaha Corporation of America, hereafter referred to as Yamaha, warrants to the original consumer of a product included in the categories listed below, that the product will be free of defects in materials and/or workmanship for the periods indicated. This warranty is applicable to all models included in the following series of products:

DD, YDD SERIES OF Digital Percussion

If during the first 90 days that immediately follows the purchase date, your new Yamaha product covered by this warranty is found to have a defect in material and/or workmanship, Yamaha and/or its authorized representative will repair such defect without charge for parts or labor.

If parts should be required after this 90 day period but within the one year period that immediately follows the purchase date, Yamaha will, subject to the terms of this warranty, supply these parts without charge. However, charges for labor, and/or any miscellaneous expenses incurred are the consumers responsibility. Yamaha reserves the right to utilize reconditioned parts in repairing these products and/or to use reconditioned units as warranty replacements.

THIS WARRANTY IS THE ONLY EXPRESS WARRANTY WHICH YAMAHA MAKES IN CONNECTION WITH THESE PRODUCTS. ANY IMPLIED WARRANTY APPLICABLE TO THE PRODUCT, INCLUDING THE WARRANTY OF MERCHANT ABILITY IS LIMITED TO THE DURATION OF THE EXPRESS WARRANTY. YAMAHA EXCLUDES AND SHALL NOT BE LIABLE IN ANY EVENT FOR INCIDENTAL OR CONSEQUENTIAL DAMAGES.

Some states do not allow limitations that relate to implied warranties and/or the exclusion of incidental or consequential damages. Therefore, these limitations and exclusions may not apply to you.

This warranty gives you specific legal rights. You may also have other rights which vary from state to state.

CONSUMERS RESPONSIBILITIES

If warranty service should be required, it is necessary that the consumer assume certain responsibilities:

1. Contact the Customer Service Department of the retailer selling the product, or any retail outlet authorized by Yamaha to sell the product for assistance. You may also contact Yamaha directly at the address provided below.
2. Deliver the unit to be serviced under warranty to: the retailer selling the product, an authorized service center, or to Yamaha with an explanation of the problem. Please be prepared to provide proof purchase date (sales receipt, credit card copy, etc.) when requesting service and/or parts under warranty.
3. Shipping and/or insurance costs are the consumers responsibility.* Units shipped for service should be packed securely.

*Repaired units will be returned PREPAID if warranty service is required within the first 90 days.

IMPORTANT: Do NOT ship anything to ANY location without prior authorization. A Return Authorization (RA) will be issued that has a tracking number assigned that will expedite the servicing of your unit and provide a tracking system if needed.

4. Your owners manual contains important safety and operating instructions. It is your responsibility to be aware of the contents of this manual and to follow all safety precautions.

EXCLUSIONS

This warranty does not apply to units whose trade name, trademark, and/or ID numbers have been altered, defaced, exchanged removed, or to failures and/or damages that may occur as a result of:

1. Neglect, abuse, abnormal strain, modification or exposure to extremes in temperature or humidity.
2. Improper repair or maintenance by any person who is not a service representative of a retail outlet authorized by Yamaha to sell the product, an authorized service center, or an authorized service representative of Yamaha.
3. This warranty is applicable only to units sold by retailers authorized by Yamaha to sell these products in the U.S.A., the District of Columbia, and Puerto Rico. This warranty is not applicable in other possessions or territories of the U.S.A. or in any other country.

Please record the model and serial number of the product you have purchased in the spaces provided below.

Model _____ Serial # _____ Sales Slip # _____

Purchased from _____ Date _____
(Retailer)

YAMAHA CORPORATION OF AMERICA
Electronic Service Division
6600 Orangethorpe Avenue
Buena Park, CA 90620

KEEP THIS DOCUMENT FOR YOUR RECORDS. DO NOT MAIL!

For details of products, please contact your nearest Yamaha representative or the authorized distributor listed below.

Pour plus de détails sur les produits, veuillez-vous adresser à Yamaha ou au distributeur le plus proche de vous figurant dans la liste suivante.

Die Einzelheiten zu Produkten sind bei Ihrer unten aufgeführten Niederlassung und bei Yamaha Vertragshändlern in den jeweiligen Bestimmungsländern erhältlich.

Para detalles sobre productos, contacte su tienda Yamaha más cercana o el distribuidor autorizado que se lista debajo.

NORTH AMERICA

CANADA

Yamaha Canada Music Ltd.
135 Milner Avenue, Scarborough, Ontario,
M1S 3R1, Canada
Tel: 416-298-1311

U.S.A.

Yamaha Corporation of America
6600 Orangethorpe Ave., Buena Park, Calif. 90620,
U.S.A.
Tel: 714-522-9011

CENTRAL & SOUTH AMERICA

MEXICO

Yamaha de México S.A. de C.V.
Calz. Javier Rojo Gómez #1149,
Col. Guadalupe del Moral
C.P. 09300, México, D.F., México
Tel: 55-5804-0600

BRAZIL

Yamaha Musical do Brasil Ltda.
Rua Joaquim Floriano, 913 - 4º andar, Itaim Bibi,
CEP 04534-013 Sao Paulo, SP. BRAZIL
Tel: 011-3704-1377

ARGENTINA

Yamaha Music Latin America, S.A.
Sucursal de Argentina
Viamonte 1145 Piso2-B 1053,
Buenos Aires, Argentina
Tel: 1-4371-7021

PANAMA AND OTHER LATIN AMERICAN COUNTRIES/ CARIBBEAN COUNTRIES

Yamaha Music Latin America, S.A.
Torre Banco General, Piso 7, Urbanización Marbella,
Calle 47 y Aquilino de la Guardia,
Ciudad de Panamá, Panamá
Tel: +507-269-5311

EUROPE

THE UNITED KINGDOM

Yamaha-Kemble Music (U.K.) Ltd.
Sherbourne Drive, Tilbrook, Milton Keynes,
MK7 8BL, England
Tel: 01908-366700

IRELAND

Danfay Ltd.
61D, Sallynoggin Road, Dun Laoghaire, Co. Dublin
Tel: 01-2859177

GERMANY

Yamaha Music Central Europe GmbH
Siemensstraße 22-34, 25462 Rellingen, Germany
Tel: 04101-3030

SWITZERLAND/LIECHTENSTEIN

Yamaha Music Central Europe GmbH,
Branch Switzerland
Seefeldstrasse 94, 8008 Zürich, Switzerland
Tel: 01-383 3990

AUSTRIA

Yamaha Music Central Europe GmbH,
Branch Austria
Schleiergasse 20, A-1100 Wien, Austria
Tel: 01-60203900

CZECH REPUBLIC/SLOVAKIA/ HUNGARY/SLOVENIA

Yamaha Music Central Europe GmbH,
Branch Austria, CEE Department
Schleiergasse 20, A-1100 Wien, Austria
Tel: 01-602039025

POLAND

Yamaha Music Central Europe GmbH
Sp.z o.o. Oddział w Polsce
ul. 17 Stycznia 56, PL-02-146 Warszawa, Poland
Tel: 022-868-07-57

THE NETHERLANDS/ BELGIUM/LUXEMBOURG

Yamaha Music Central Europe GmbH,
Branch Benelux
Clarissenhof 5-b, 4133 AB Vianen, The Netherlands
Tel: 0347-358 040

FRANCE

Yamaha Musique France
BP 70-77312 Marne-la-Vallée Cedex 2, France
Tel: 01-64-61-4000

ITALY

Yamaha Musica Italia S.P.A.
Viale Italia 88, 20020 Lainate (Milano), Italy
Tel: 02-935-771

SPAIN/PORTUGAL

Yamaha-Hazen Música, S.A.
Ctra. de la Corona km. 17, 200, 28230
Las Rozas (Madrid), Spain
Tel: 91-639-8888

GREECE

Philippos Nakas S.A. The Music House
147 Skiathou Street, 112-55 Athens, Greece
Tel: 01-228 2160

SWEDEN

Yamaha Scandinavia AB
J. A. Wettergrens Gata 1
Box 30053
S-400 43 Göteborg, Sweden
Tel: 031 89 34 00

DENMARK

YS Copenhagen Liaison Office
Generatorvej 6A
DK-2730 Herlev, Denmark
Tel: 44 92 49 00

FINLAND

F-Musiikki Oy
Kluuvikatu 6, P.O. Box 260,
SF-00101 Helsinki, Finland
Tel: 09 618511

NORWAY

Norsk filial av Yamaha Scandinavia AB
Grini Næringspark 1
N-1345 Østerås, Norway
Tel: 67 16 77 70

ICELAND

Skifan HF
Skeifan 17 P.O. Box 8120
IS-128 Reykjavik, Iceland
Tel: 525 5000

OTHER EUROPEAN COUNTRIES

Yamaha Music Central Europe GmbH
Siemensstraße 22-34, 25462 Rellingen, Germany
Tel: +49-4101-3030

AFRICA

Yamaha Corporation,
Asia-Pacific Music Marketing Group
Nakazawa-cho 10-1, Naka-ku, Hamamatsu,
Japan 430-8650
Tel: +81-53-460-2312

MIDDLE EAST

TURKEY/CYPRUS

Yamaha Music Central Europe GmbH
Siemensstraße 22-34, 25462 Rellingen, Germany
Tel: 04101-3030

OTHER COUNTRIES

Yamaha Music Gulf FZE
LOB 16-513, P.O.Box 17328, Jubel Ali,
Dubai, United Arab Emirates
Tel: +971-4-881-5868

ASIA

THE PEOPLE'S REPUBLIC OF CHINA

Yamaha Music & Electronics (China) Co.,Ltd.
25/F., United Plaza, 1468 Nanjing Road (West),
Jingan, Shanghai, China
Tel: 021-6247-2211

HONG KONG

Tom Lee Music Co., Ltd.
11/F., Silvercord Tower 1, 30 Canton Road,
Tsimshatsui, Kowloon, Hong Kong
Tel: 2737-7688

INDONESIA

PT. Yamaha Music Indonesia (Distributor)
PT. Nusantik
Gedung Yamaha Music Center, Jalan Jend. Gatot
Subroto Kav. 4, Jakarta 12930, Indonesia
Tel: 21-520-2577

KOREA

Yamaha Music Korea Ltd.
8F, 9F, Dongsung Bldg. 158-9 Samsung-Dong,
Kangnam-Gu, Seoul, Korea
Tel: 080-004-0022

MALAYSIA

Yamaha Music Malaysia, Sdn., Bhd.
Lot 8, Jalan Perbandaran, 47301 Kelana Jaya,
Petaling Jaya, Selangor, Malaysia
Tel: 3-78030900

PHILIPPINES

Yupangco Music Corporation
339 Gil J. Puyat Avenue, P.O. Box 885 MCPO,
Makati, Metro Manila, Philippines
Tel: 819-7551

SINGAPORE

Yamaha Music Asia Pte., Ltd.
#03-11 A-Z Building
140 Paya Lebar Road, Singapore 409015
Tel: 747-4374

TAIWAN

Yamaha KHS Music Co., Ltd.
3F, #6, Sec.2, Nan Jing E. Rd. Taipei.
Taiwan 104, R.O.C.
Tel: 02-2511-8688

THAILAND

Siam Music Yamaha Co., Ltd.
891/1 Siam Motors Building, 15-16 floor
Rama 1 road, Wangmai, Pathumwan
Bangkok 10330, Thailand
Tel: 02-215-2626

OTHER ASIAN COUNTRIES

Yamaha Corporation,
Asia-Pacific Music Marketing Group
Nakazawa-cho 10-1, Naka-ku, Hamamatsu,
Japan 430-8650
Tel: +81-53-460-2317

OCEANIA

AUSTRALIA

Yamaha Music Australia Pty. Ltd.
Level 1, 99 Queensbridge Street, Southbank,
Victoria 3006, Australia
Tel: 3-9693-5111

NEW ZEALAND

Music Houses of N.Z. Ltd.
146/148 Captain Springs Road, Te Papapa,
Auckland, New Zealand
Tel: 9-634-0099

COUNTRIES AND TRUST TERRITORIES IN PACIFIC OCEAN

Yamaha Corporation,
Asia-Pacific Music Marketing Group
Nakazawa-cho 10-1, Naka-ku, Hamamatsu,
Japan 430-8650
Tel: +81-53-460-2312

HEAD OFFICE Yamaha Corporation, Pro Audio & Digital Musical Instrument Division
Nakazawa-cho 10-1, Naka-ku, Hamamatsu, Japan 430-8650
Tel: +81-53-460-3273



Yamaha Home Keyboards Home Page (English Only)
<http://music.yamaha.com/homekeyboard>
Yamaha Manual Library
<http://www.yamaha.co.jp/manual/>

U.R.G., Pro Audio & Digital Musical Instrument Division, Yamaha Corporation
© 2007 Yamaha Corporation

WJ46680 703POXXXX.X-01A0
Printed in China