

# **dji** MIC

## User Manual

v1.0 2021.12

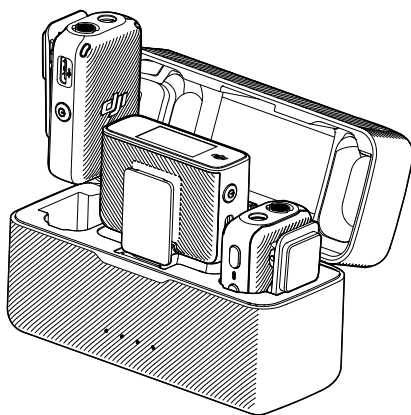

### **Searching for Keywords**

Search for keywords such as “battery” and “install” to find a topic. If you are using Adobe Acrobat Reader to read this document, press Ctrl+F on Windows or Command+F on Mac to begin a search.

### **Navigating to a Topic**

View a complete list of topics in the table of contents. Click on a topic to navigate to that section.

### **Printing this Document**

This document supports high resolution printing.

# Content

<b>Introduction</b>	2
DJI Mic Transmitter	2
DJI Mic Receiver	3
Charging Case	4
<b>Operation</b>	6
Linking	6
Using DJI Mic	6
OLED Touchscreen Operations	8
Transmitter Recording	9
Audio File	10
Updating Firmware	10
Charging Case Operations	10
<b>Specifications</b>	11
<b>After-Sales Information</b>	12

# Introduction

DJI™ Mic is a dual channel wireless microphone system, including two transmitters and one receiver, which is able to record two sound sources simultaneously at a distance of up to 250 m\*. The transmitter has a built-in omnidirectional microphone, supports the use of an external microphone, and can be clipped to clothing or any place close to a sound source. With the internal 8 GB storage, DJI Mic is able to record audio for up to 14 hours\*\*.

The receiver boasts an OLED touchscreen, on which users can view the real-time volume, wireless signal strength, gain, recording modes, and more. By utilizing the expansion port, the receiver can be connected to a camera or mobile phone to provide high quality audio. The receiver can also be connected to a computer to use as a microphone and with the monitor port the audio can be monitored in real time. The charging case provided is able to charge the transmitters and receiver simultaneously and link them automatically.

\* Tested in an obstruction-free outdoor environment.

\*\* Tested with a 48,000Hz sampling rate and 24-bit mono WAV audio format.

## DJI Mic Transmitter

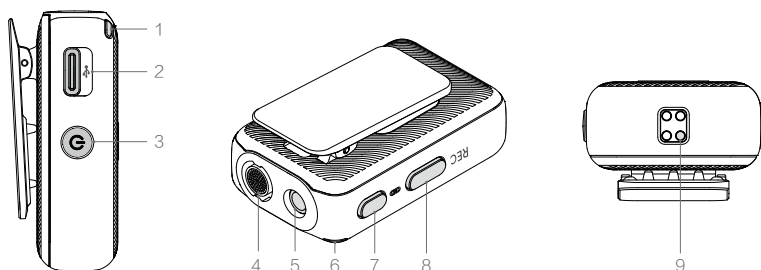

### 1. System Status Indicator

Indicates the connection status with the receiver and the battery level of the transmitter.

Blinking Pattern	Descriptions
<b>Connection Status</b>	
Solid on	Connected with the receiver
Blinks slowly	Disconnected from the receiver
Blinks quickly	Linking
Blinks red and green alternatively	Firmware updating
<b>Battery Level Descriptions</b>	
Solid green	Battery Level $\geq 20\%$
Solid red	Battery Level $< 20\%$
<b>Battery Level During Charging</b>	
Blinks green slowly	Battery level: 0~25%
Blinks green twice	Battery level: 26~50%
Blinks green three times	Battery level: 51~75%
Blinks green four times	Battery level: 76~100%
Off	Fully charged

**2. Data Port (USB-C)**

For copying audio or updating firmware after connecting to a computer. Can also be used for charging.

**3. Power Button**

Press and hold to power on or off. Press twice to mute.

**4. Internal Microphone**

For recording audio.

**5. 3.5 mm TRS Input**

For connecting external microphone. DO NOT connect a microphone with a power supply of 24 V or 48 V.

**6. Recording Status LED**

Indicates the record status of the transmitter.

Blinking Pattern	Descriptions
Solid red	Recording
Pulses red	Mute
Off	Not recording

**7. Linking Button**

Press and hold to start linking to the receiver. Once the receiver is attached to a mobile phone and the receiver and transmitter are linked, press once to take a photo or start or stop recording on the mobile phone (only supports mobile phones where the volume button can be used to take a photo or start or stop a video).

**8. Record Button**

Press once to start or stop recording.

**9. Charging Pad**

Charging will begin after connecting the transmitter to the charging pad of the charging case and the transmitter will automatically link with the receiver in the charging case.

**DJI Mic Receiver**

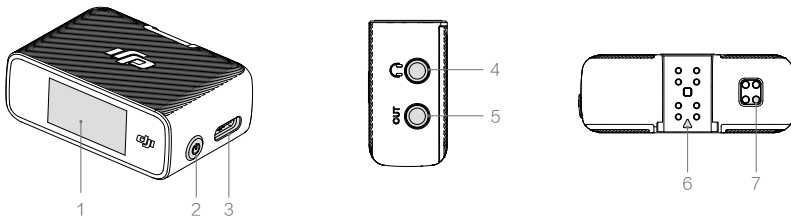

**1. OLED Touchscreen**

Displays information such as the real-time volume, battery level of the receiver and transmitter, charging status, wireless signal strength, gain, and recording modes. Slide down or up on the screen to access settings.

### 2. Power Button

Press and hold to power on or off. Press once to lock or unlock the screen.

### 3. Data Port (USB-C)

After connecting to a computer, can be used to update firmware or as a microphone for the computer. Can also be used for charging.

### 4. Monitor Port

Plug in a 3.5 mm TRS headphone to monitor the transmitter recording.

### 5. 3.5 mm TRS Output

For audio output to a camera. DO NOT connect to a device with an output of 24 V or 48 V.

### 6. Expansion Port

For connecting to a mobile phone using a mobile phone adapter or connecting to a camera using a hot shoe adapter.

### 7. Charging Pad

Charging will begin after connecting the receiver to the charging pad on the charging case and the receiver will link with the transmitter in the charging case automatically.

## Charging Case

---

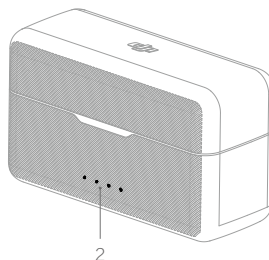
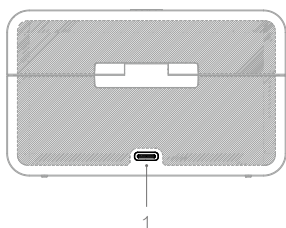

### 1. USB-C Charging Port

For charging the charging case.

### 2. Battery Level LEDs

Indicates the battery level of the charging case.

---

○ LED is on

◐ LED is flashing

○ LED is off

---

LED1	LED2	LED3	LED4	Battery Level During Charging (LEDs blink in sequence)
				76~99%
				51~75%
				26~50%
				≤25%
				Fully charged (Power off)
LED1	LED2	LED3	LED4	Battery Level
				76~100%
				51~75%
				26~50%
				10~25%
				<10%

# Operation

## Linking

The transmitters and the receiver are linked by default. Follow the steps below to link if the transmitter and receiver are disconnected.

1. Place the transmitters and the receiver in the charging case and they will link automatically.
2. Power on the transmitter and the receiver, press and hold the link button of the transmitter, slide down on the screen of the receiver, select Settings, and scroll through and tap Link Device to start linking. The status LED glow solid green to indicate linking is successful.

## Using DJI Mic

### Transmitter

The transmitter can be attached using the magnetic clip to either clothes or a stable surface. The clamp can also be used to attach the transmitter to clothes.

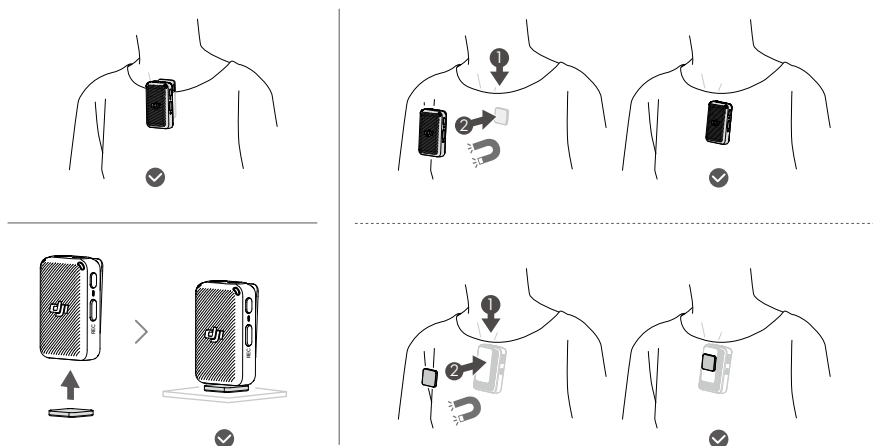

It is recommended to use the windscreen when using the transmitter outdoors or in a windy environment. Attach the windscreen to the transmitter by aligning it with the internal microphone and rotate the windscreen to lock in place.

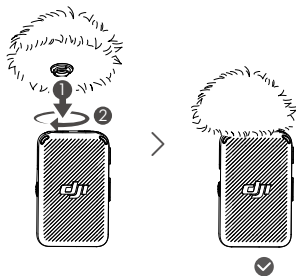





## Receiver

### 1. Using with a Camera

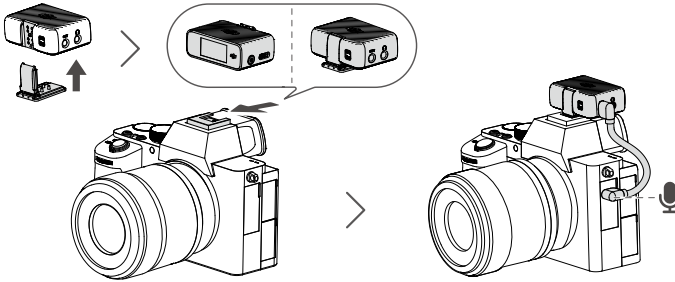
To record audio and transmit to a camera, attach the receiver to a camera using the hot shoe adapter and connect to the microphone port of the camera using the camera cable provided.



 Lower the volume of the camera to avoid sound distortion.

### 2. Using with a Mobile Phone

Attach the receiver to a mobile phone using the mobile phone adapter to record audio and transmit to a mobile phone. Audio can be played after the receiver is disconnected from the mobile phone.

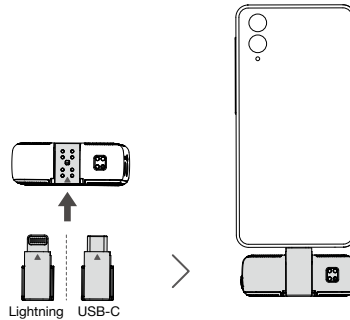

-  • The 3.5 mm TRS output port of the receiver cannot output after connecting to a mobile phone adapter.
- Only Mono mode can be used after connecting the receiver to the Lightning mobile phone adapter.
  - The mobile phone speaker cannot output sound after connecting the receiver to the mobile phone. Bluetooth headphones or speaker can be used instead.

### 3. Using with a Computer

Connect the receiver to a computer via the USB-C port as a microphone for a computer.

- ⚠ Use a standard charging cable to connect DJI Mic with a computer and enter the related input settings on the computer.

## OLED Touchscreen Operations

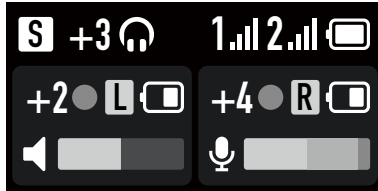

### Home

The top part of the screen indicates the status of receiver.

- [S]**: Recording Mode. Choose between S (Stereo), M (Mono), and Ms (Mono Safety Track).
- +3**: Indicates the receiver gain.
- 🎧**: Indicates there is external headphone connected.
- 1** (with signal strength bars): Indicates the wireless signal strength between transmitter 1 and the receiver. If there is only one transmitter connected, then only the information of one transmitter will be displayed.
- 2** (with signal strength bars): Indicates the wireless signal strength between transmitter 2 and the receiver.
- 🔋**: Indicates the battery level of the receiver.

The middle of the screen indicates the status of transmitters.

- +2 / +4**: Indicates the transmitter gain.
- : Indicates audio is being recorded.
- L / R**: Indicates the sound channel.
- 🔋**: Indicates the battery level of the transmitter.

The bottom of the screen indicates the real-time volume.

- 🔊**: Indicates the volume of the internal microphone.
- 🔇**: Indicates volume is muted.
- 🎤**: Indicated the volume of the external microphone.

### Settings

#### Slide Down

Slide down from the top of the screen to access Settings, slide left or right to select an option, and slide up to return to the previous screen.

#### Recording Mode Settings

Choose between S (Stereo), M (Mono), and Ms (Mono Safety track).

**M Mono**: Under Mono mode, the audio recorded by the two transmitters will be in one channel.

**M Mono with Safety Track:** Similar to Mono mode, the audio will be recorded in -6dB incase the main track gets distorted due to a sudden increase in the audio volume of the source.

**S Stereo:** Under Stereo mode, the audio will be separated into left and right channels.

**RX Gain:** Can be reduced if the sound is distorted.

**Monitor Volume:** Tap to adjust the volume of the receiver.

## General Settings

**Low Cut:** Sounds that are 150 Hz or lower will be filtered if Low Cut is enabled.

**Vibration Notification:** Enable or disable vibration notification. Once Vibration Notification is enabled, the transmitter will vibrate in the scenarios listed below.

Operation	Vibration
Power on	Vibrates for a short period
Power off	Vibrates for a longer period
Start recording	Vibrates for a short period
Stop recording	Vibrates twice

**Link Device:** Tap to link the transmitter and receiver.

**Transmitter Gain:** Tap to adjust the transmitter input gain according to the real-time volume. Reduce the gain accordingly when the volume bar turns red. Note that the transmitter gain will affect the volume of the recorded audio.

**Brightness:** Tap to adjust the brightness of the screen.

**Language:** The screen supports languages of English, Chinese Simplified, Chinese Traditional, Japanese, Korean, Thai, German, Spanish, French, Portuguese, Italian, Russian, Turkish, Indonesian, and Polish.

**Date and Time:** Set the date and time for the recording file.

**Restore:** Tap to reset default settings.

**Version:** Check the SN, receiver firmware version, and the connected transmitter firmware version.

**Compliance Information:** View the compliance information.

## Slide Up

Slide up from the bottom of the screen to view and control recording, enable or disable mute, and view the remaining recording time. Slide up from the bottom of the left side of the screen to adjust the settings for transmitter 1 and slide up from the bottom of the right side of the screen to adjust the settings of transmitter 2.

## Transmitter Recording

After powering on the transmitter, press the record button once to start recording and press again to stop recording.

The recorded audio format of the transmitter is 24-bit mono WAV. When recording for an extended period, the file will be separated automatically every 30 minutes. The max recording time is approximately 14 hours, at which point newly recorded audio will overwrite the older recorded audio if the storage is full.

## Audio File

The recorded audio can be exported or deleted after connecting to a computer and can be formatted via the receiver.

## Updating Firmware

When there is new firmware available, update the firmware by connecting the transmitter and the receiver to the computer separately.

How to update firmware:

1. Download the firmware on the product page at [www.dji.com/mic/downloads](http://www.dji.com/mic/downloads).
2. Connect the transmitter or receiver to the computer using the USB-C cable provided.
3. Place the downloaded firmware update package .bin file under the root directories of the transmitters and receiver.
4. The transmitters and receiver firmware updates will start automatically after disconnecting from the computer.

If the firmware update fails, download the firmware again, reboot the receiver or transmitter, and repeat the steps above. After the firmware update is completed, check the firmware version on the receiver to ensure the firmware is updated successfully.

## Charging Case Operations

It is recommended to charge the charging case using a 5V/2A charger. The charging case has a built-in battery with a 1800 mAh. Place the transmitter and receiver into the charging case to begin charging. With the charging case opened, the receiver displays the battery level of the three devices and the remaining recording time of the transmitter. The transmitter and receiver will be powered on once removed from the charging case. The total operating time is approximately 15 hours when using the transmitters, receiver, and the charging case together.

A mobile phone adapter and the hot shoe adapter can be placed into charging case either mounted to the receiver or not.

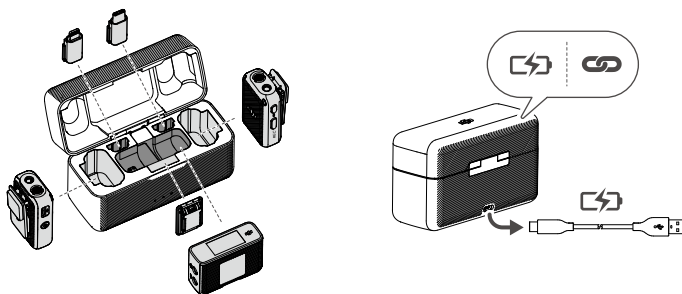

# Specifications

Name	DJI Mic Transmitter
Model	AST01
Dimensions	47.3×30.4×20.0 mm
Weight	30 g
Wireless Mode	GFSK 1 Mbps and 2 Mbps
Transmitter Power (EIRP)	<20 dBm
Operating Frequency	2400-2483.5 MHz
Battery Type	LiPo 1S
Capacity	320 mAh
Energy	1.23 Wh
Voltage	3.85 V
Charging Temperature	5° to 45° C (41° to 113° F)
Operating Temperature	-10° to 45° C (14° to 113° F)
Charging Time	1 hour 10 minutes
Operating Time	5 hours 30 minutes
Microphone Directions	Omnidirectional
Frequency Response	Low Cut Disabled: 50 Hz - 20 KHz Low Cut Enabled: 150 Hz - 20 KHz
Max Sound Pressure Level (SPL)	114 dB SPL
Max Input Level (3.5 mm)	-17 dBV (THD < 0.1%)
Equivalent Noise	23 dBA
Monitor Interface Output Power	Max Output 22mW@1kHz, 32Ω

Name	DJI Mic Receiver
Model	ASR01
Dimensions	47.4×32.2×17.4 mm
Weight	24.9 g
Wireless Mode	GFSK 1 Mbps and 2 Mbps
Transmitter Power (EIRP)	<20 dBm
Operating Frequency	2400-2483.5 MHz
Battery Type	LiPo 1S
Capacity	320 mAh
Energy	1.23 Wh
Voltage	3.85 V
Charging Temperature	5° to 45° C (41° to 113° F)
Operating Temperature	-10° to 45° C (14° to 113° F)
Charging Time	1 hour 10 minutes
Operating Time	5 hours

Name	Charging Case
Model	ASB01
Dimensions	103.1×61.9×41.5 mm
Weight	162.2 g
Battery Type	LiPo 1S
Capacity	1800 mAh
Energy	10 Wh
Voltage	3.87 V
Charging Temperature	5° to 45° C (41° to 113° F)
Operating Temperature	5° to 45° C (41° to 113° F)
Charging Time	2 hours 40 minutes
Operating time	Fully charge three devices simultaneously x1.8

---

## After-Sales Information

Visit <https://www.dji.com/support> to learn more about after-sales service policies, repair services, and support.

---

This content is subject to change.

Download the latest version from  
<https://www.dji.com/mic>

If you have any questions about this document, please contact DJI by sending a message to [DocSupport@dji.com](mailto:DocSupport@dji.com).

Copyright © 2021 DJI All Rights Reserved.