

# Sound Plus™ Value Courtroom System, Model WIR SYS 2

## ADA COURTROOM ASSISTIVE LISTENING SYSTEM

### Description:

The Value Courtroom System, model WIR SYS 2, is the ideal hearing assistance package for courtrooms with limited budget resources. Participants wear headset style receivers to listen to the courtroom proceeding at the volume of their comfort level anywhere in a 4,000 ft<sup>2</sup> area. For the severely hard of hearing, the RX12-4N receiver can be used with a neckloop (included) to amplify the participant's telecoil equipped hearing aid. SoundPlus® infrared technology ensures privacy and security: the message of the proceeding will not travel outside the walls of the courtroom.

Each WIR SYS 2 package includes: one (1) TX9 emitter, one (1) MOD 232 modulator, three (3) headset RX14-2 receivers, one (1) RX12-4N receiver, one (1) HED 021 Headphone, one (1) NKL 001 neckloop and one (1) RPK 005 rack panel kit. The WIR SYS 2 meets and exceeds government ADA regulations for public hearing assistance, and is backed by a five-year warranty.\*

### MOD 232 Modulator:

<b>Size, Weight:</b>	8.5" W x 8.2" D x 1.7" H (21.5 cm x 20.8 cm x 4.4 cm), 3.1 lbs (1.5kg)
<b>Color:</b>	Black epoxy paint with white legends
<b>Rack Mount:</b>	1/2 rack space wide, 1 rack space high, one or two modulators may be mounted in a single IEC rack space with RPK 005 (single) or RPK 006 (double) Rack Mount Kits
<b>Power Supply:</b>	Wall Transformer, 24 VAC, 50-60 Hz, 15 VA North America: TFP 016, UL/CSA Europe: TFP 027-01, 2-pin Schuko plug, CE UK: TFP 027-02, 3-pin UK plug, CE
<b>Modulation:</b>	FM Wideband, +50 kHz deviation, 50 uS pre-emphasis
<b>Carrier Frequency:</b>	Channel A: Selectable, 2.3/2.8/3.3/3.8 MHz Channel B: Selectable, 2.3/2.8/3.3/3.8 MHz
<b>Signal-to-Noise Ratio:</b>	More than 60 dB
<b>Frequency Response:</b>	30 to 16,000 Hz, +1 dB, -3dB, electrical response
<b>Total Harmonic Distortion:</b>	Less than 2%, electrical response
<b>Audio Processing:</b>	Compression (slope) adjustable from 1:1 to 4:1 Switchable compression gain: Moderate: 16 dB. Max: 33 dB
<b>Auto Carrier Shut-Off:</b>	30-minute timer shuts off carrier when no audio is present (can be disabled)

Fig. 1: MOD 232 Front Panel

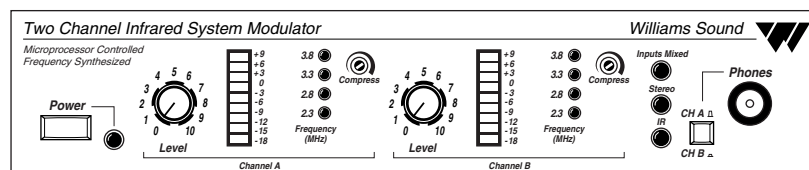

<b>Power Switch:</b>	Two-position push button, ON/OFF
<b>Power Indicator:</b>	Green LED
<b>Audio Level Controls:</b>	CHA and CHB Input Level, rotary knobs
<b>Audio Indicators:</b>	CHA and CHB Audio Level, 10-segment LED's
<b>Carrier LEDs:</b>	4 green LED carrier "on" indicators per channel (indicates frequency, malfunctions)
<b>Compress Control:</b>	1:1 to 4:1
<b>Input Mix LED:</b>	Indicates inputs A and B audio are mixed and transmitted by CHA. CHB off
<b>Stereo LED:</b>	Indicates stereo mode
<b>Phones Switch:</b>	Selects CH1 or CH2 for phones when not in stereo mode
<b>Phones Output:</b>	1/4" TRS headphone jack. Accepts stereo, mono and any impedance phones
<b>Infrared Test LED:</b>	IR LED for receiver testing, monitoring and audio signal testing

\*90 days on accessories

\*\*TX9 operation in single-channel mode

NOTE: SPECIFICATIONS SUBJECT TO CHANGE WITHOUT NOTICE!

# Sound Plus™ Value Courtroom System, Model WIR SYS 2

Fig. 2: MOD 232 Rear Panel

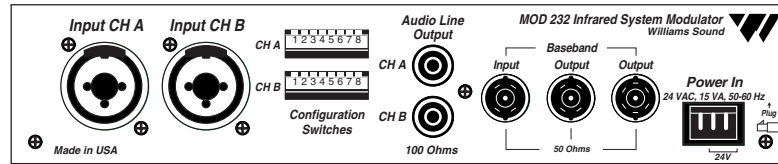

<b>Power Input:</b>	3-Pin Molex, 24 VAC, 50-60 Hz, 15 VA
<b>Audio Input Jack:</b>	CHA and CHB combination XLR/TRS jack
<b>Mic Level:</b>	Balanced, Lo-Z, 100 $\mu$ V min. to 90 mV max., 1mV nominal, 3 k $\Omega$ input impedance, supplies switchable simplex power per DIN 45596 for condenser mics
<b>Line Level:</b>	Balanced or unbalanced, 21 mV min. to 10V max., 212 mV nominal, 100 k $\Omega$
<b>Audio Line Output Jacks:</b>	RCA Jack, CHA and CHB, 500 mV, unbalanced, 100 $\Omega$ source impedance, load impedance must be greater than 1 k $\Omega$
<b>Configuration Switches:</b>	CHA and CHB 8-position DIP switch, selects Mic/Line input, compressor gain, simplex power, discrete or mixed inputs, carrier frequency, channel disable, auto shut-off timer
<b>Baseband Input Jack:</b>	BNC, allows mixing with additional MOD 232 Modulator (4CH operation), 100 mV, 50 $\Omega$ input impedance, use with MOD 232 or MOD 112 (111), BNC, RG-58 Cable
<b>Baseband Output Jack:</b>	Two BNC jacks carry baseband signal, 100 mV/channel, 50 $\Omega$ source impedance, for use with WIR TX9 or MOD 232 only
<b>Approvals:</b>	CE, FCC
<b>Operating Requirements:</b>	0-50° C ambient temperature, non-condensing, non-corrosive atmosphere
<b>Warranty:</b>	5 years on modulator, 90 days on accessories

## WIR TX9 Emitter:

<b>Dimensions, Weight:</b>	11.25" W x 6.25" H x 2.125" D (28.6 cm x 15.9 cm x 5.4 cm), 1.9 lbs (0.9 kg)
<b>Color:</b>	Black with white legends, red acrylic lens
<b>Power Supply:</b>	Wall Transformer, 24 VAC, 50-60 Hz, 35 VA, 3-pin MOLEX Connector
	North America: TFP 010, UL/CSA
	Europe: TFP 027-01, 2-pin Schuko plug, CE
	UK: TFP 027-02, 3-pin UK plug, CE
	Note: Each WIR TX9 requires its own power supply
<b>Power Cable:</b>	NEC Class 2 wiring, two-conductor, 18 ga., 200' (61m) max. length
<b>Indicators:</b>	Green LED power indicator, red LED baseband indicator
<b>Carrier Frequency:</b>	50 kHz to 8 MHz
<b>Emitter IR Power:</b>	3.5 watts
<b>Coverage Area:</b>	28,000 ft <sup>2</sup> (2,600 m <sup>2</sup> ) in single-channel mode when using the RX12-4 Receiver 11,000 ft <sup>2</sup> (1,000 m <sup>2</sup> ) in four-channel mode when using the RX12-4 Receiver 3,500 ft <sup>2</sup> (325 m <sup>2</sup> ) in single-channel mode when using the RX14-2 Receiver 3,063 ft <sup>2</sup> (285 m <sup>2</sup> ) in single-channel mode when using the RX16 Receiver (See coverage area diagrams)
<b>Baseband Input:</b>	BNC, 100 mV per carrier, 50 $\Omega$ , for use with WIR TX9 or MOD 232 only
<b>Baseband Output:</b>	BNC, 50 $\Omega$ , for use with TX9 only
<b>Baseband Cable:</b>	RG 58 Coax, BNC connectors, maximum 1000' (300m) length
<b>Operating Requirements:</b>	0-50° C ambient temperature, non-condensing, non-corrosive atmosphere
<b>Mounting Kits:</b>	Wall or Ceiling Mount: BKT 024 Omnidirectional mount, Mic Stand Kit: SS-11 or SS-6
<b>Warranty:</b>	5 years on emitter, 90 days on accessories
<b>Approvals:</b>	CE, FCC, RoHS, WEEE
<b>Compatible Receivers:</b>	WIR RX12-4 Four-Channel Receiver, RX14 Stereo Receiver, RX16 Two-Channel Receiver

Fig. 3: WIR TX9 Rear Panel

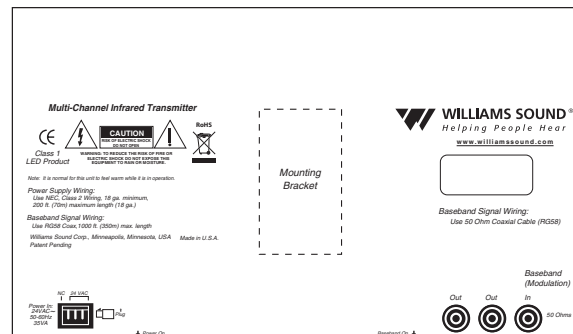

NOTE: SPECIFICATIONS SUBJECT TO CHANGE WITHOUT NOTICE!

## Coverage Patterns:

Fig. 4: Receiver Coverage Area with TX9 Emitter in Single Channel Mode

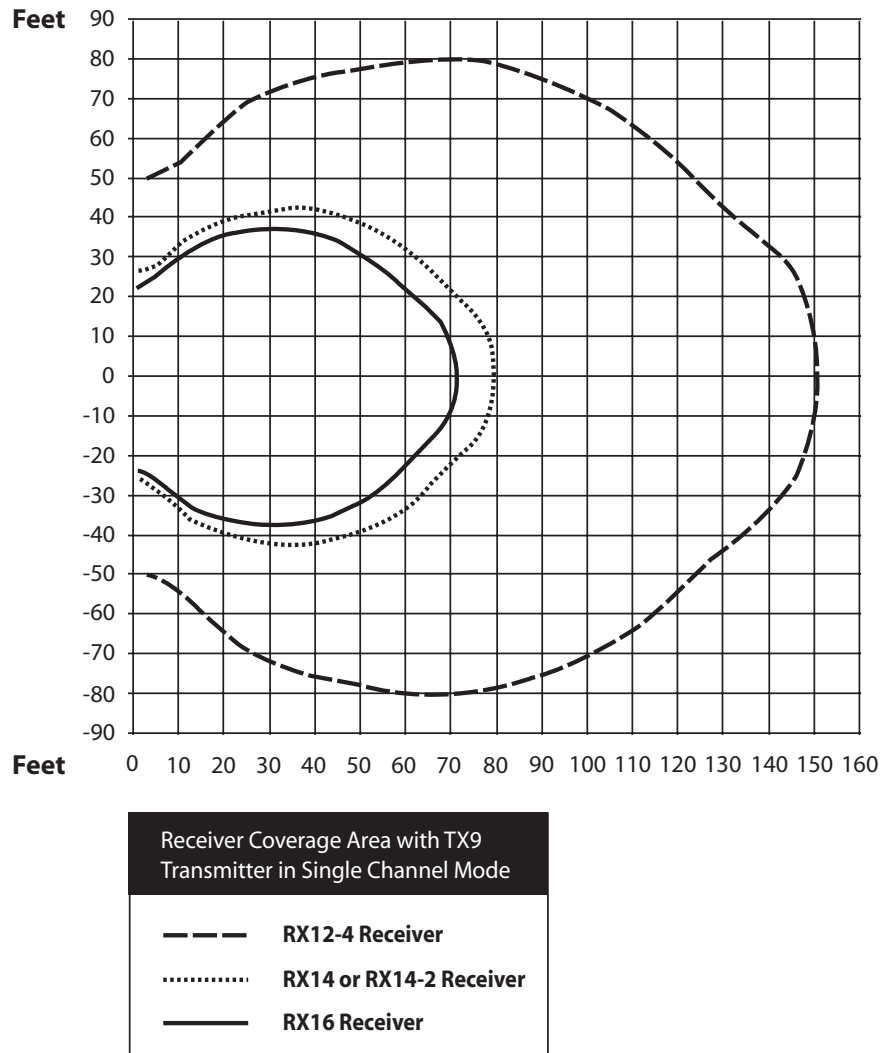

The coverage area for the TX9 will vary depending on the receiver being used. The diagram above demonstrates the receiver coverage when operating a single TX9 emitter in single channel mode. Patterns are direct radiation patterns.

Note: Reflections of the infrared light from walls, ceilings and floors may change these patterns.

NOTE: SPECIFICATIONS SUBJECT TO CHANGE WITHOUT NOTICE!

# Sound Plus™ Value Courtroom System, Model WIR SYS 2

**Fig. 5: 3-Dimension Foot Pattern**

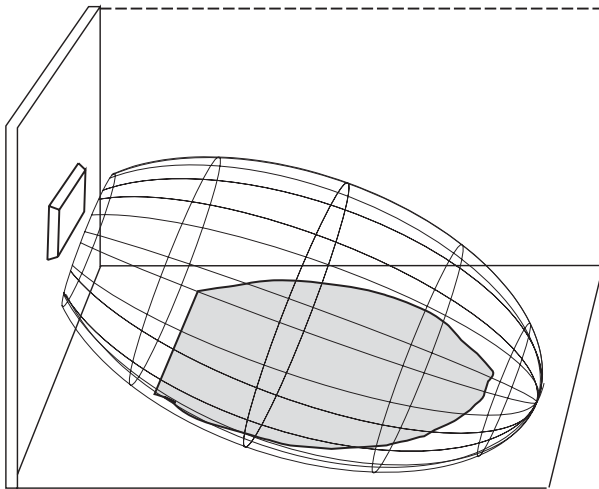

The TX9 floods the listening audience with a cone shape light pattern as shown here.

The path of the cone shape light leaves a pattern on the ground, or "foot print," and indicates where the strongest receiver reception will occur.

The actual coverage area will vary depending on the sensitivity of the receiver being used. Refer to Figures 4 and 7 to determine how many emitters are required for 100% coverage of the listening area.

To determine the best location for the emitter, it helps to think of the IR emitter as an invisible flood-light. You'll want to aim it so the listeners are "flooded" with the infrared light. The emitter should also be positioned high enough so it won't be blocked by people and other physical obstructions. See Figure 6 below. **Mount the emitter at least 2 ft. (.61 m) above the audience.** Position the emitter to face in a slightly downward angle, 20°, that will increase the "throw" of the infrared beam.

**Fig. 6: Vertical Beam Spread**

**Minimum Receiver Range When Operating with a TX9 Emitter in Single Channel Mode**

⋯ RX12-4 Receiver: 150' (45 m)    
 — RX14-2: 80' (24 m)    
 — RX16: 70' (21 m)

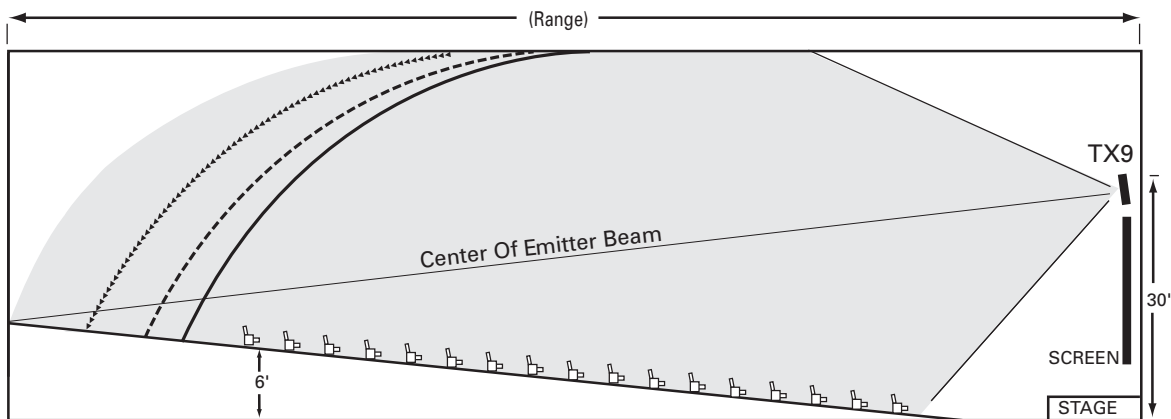

NOTE: SPECIFICATIONS SUBJECT TO CHANGE WITHOUT NOTICE!

# Sound Plus™ Value Courtroom System, Model WIR SYS 2

## Maximum Range When Using the RX12-4 Infrared Receiver

Fig. 7: Horizontal and Vertical Radiation Polar Plots

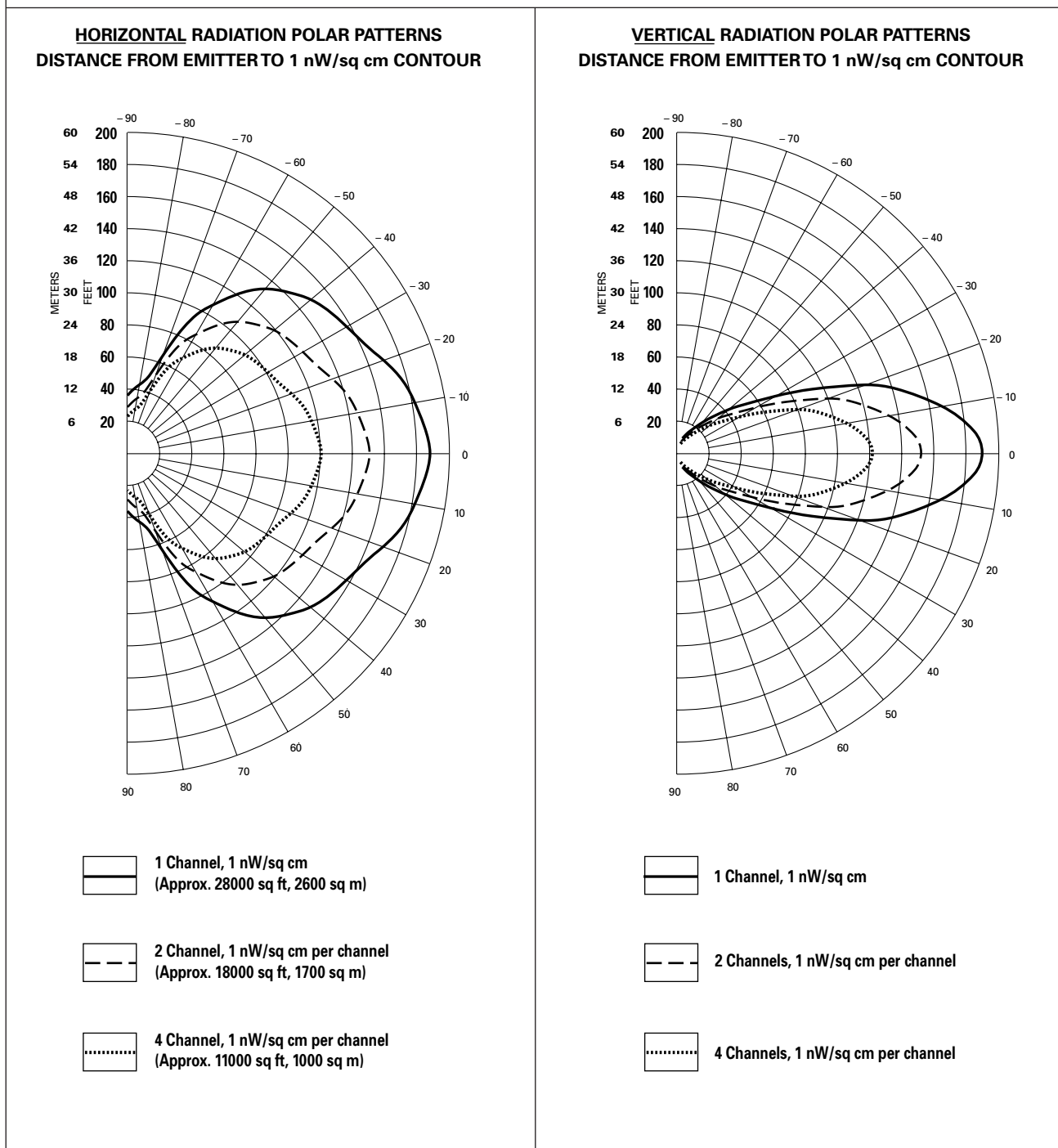

Reflections of the infrared light from walls, ceilings, and floors may change these patterns.  
**Important: Remember to point the emitter towards the listening audience!**

If you're not getting sufficient coverage with a single, properly installed TX9 Emitter, you may need to add additional WIR TX9 Emitters to achieve full coverage of your listening area. Figures 8a and 8b illustrate how multiple emitters can be used for large room installations.

NOTE: SPECIFICATIONS SUBJECT TO CHANGE WITHOUT NOTICE!

# Sound Plus™ Value Courtroom System, Model WIR SYS 2

Multiple Emitters Installed to Maximize Coverage

Fig. 8a: Overlapping Illumination Patterns to Cover Larger Listening Areas

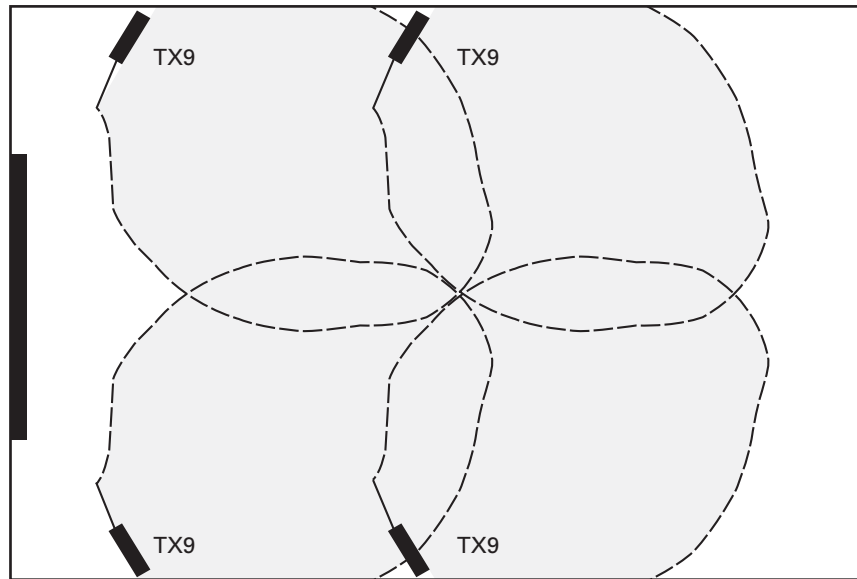
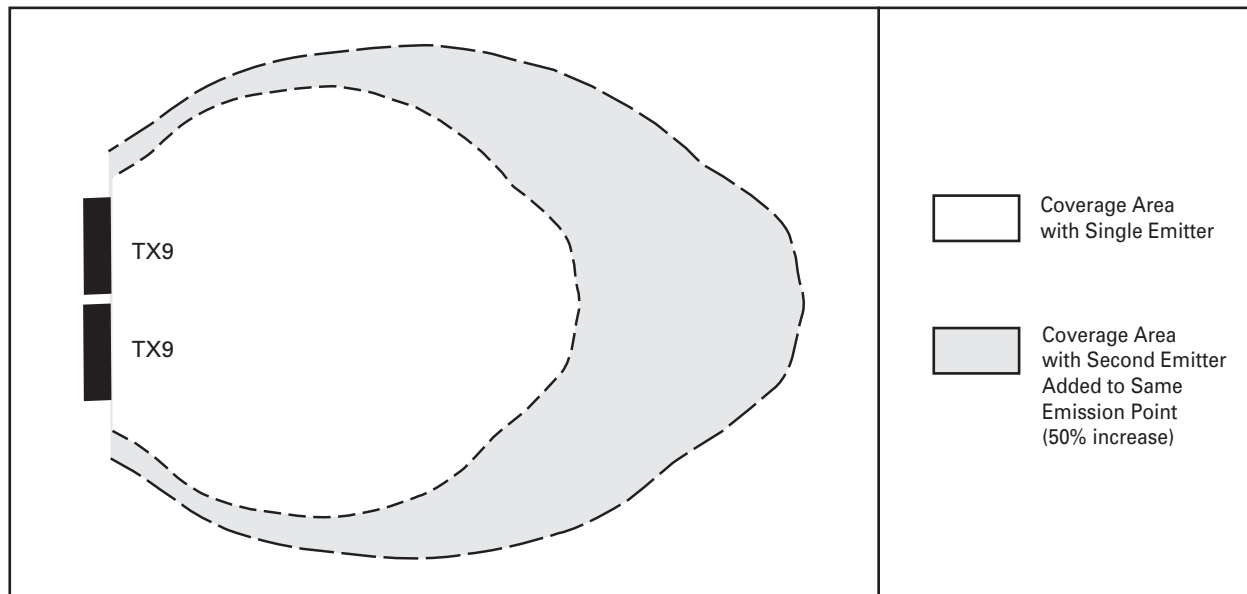

Fig. 8a above is a typical example of how multiple emitters are used to cover larger listening areas. Generally it is desirable for the illumination patterns to overlap. Note: The coverage area will vary depending on the infrared receiver being used; refer to Figures 4 and 7 to determine how many emitters are required to achieve full coverage of a listening area.

Fig. 8b: Overlapping Illumination Patterns to Cover Larger Listening Areas



When two emitters are used at the same emission point in *single channel mode*, the overall coverage area increases 50%. When using an RX12-4 receiver, as a result, the coverage area will increase to an estimated 42,000 ft<sup>2</sup> (3,902 m<sup>2</sup>); the RX14-2 will increase to 5,250 ft<sup>2</sup> (488 m<sup>2</sup>); the RX16 will increase to 4,590 ft<sup>2</sup> (426 m<sup>2</sup>).

NOTE: SPECIFICATIONS SUBJECT TO CHANGE WITHOUT NOTICE!

# Sound Plus™ Value Courtroom System, Model WIR SYS 2

## WIR RX14-2 Receiver:

<b>Receiver Style:</b>	Headset
<b>Earpad Size:</b>	2.5" (6.5 cm) diameter, adjustable headband
<b>Weight:</b>	6.7 oz (191 g) without batteries
<b>Color and Material:</b>	Black, plastic
<b>Operating Range:</b>	Up to 3,500 ft <sup>2</sup> (325 m <sup>2</sup> ) when using a single WIR TX9 Emitter. (See coverage drawing)
<b>Battery Type:</b>	AAA Alkaline batteries (BAT 010). AAA NiMH (BAT 022) optional.
<b>Battery Life:</b>	Alkaline: 50 hours, NiMH: 8 hours/charge
<b>Battery Drain:</b>	25 mA, nominal
<b>Controls:</b>	ON/OFF switch (2) Thumbwheel volume control knob, left and right (1) Frequency push-button selector, 2.3 MHz or 2.8 MHz
<b>Warranty:</b>	1-year warranty (excludes physical damage)
<b>Approvals:</b>	CE

Fig. 9: WIR RX14-2 Side View

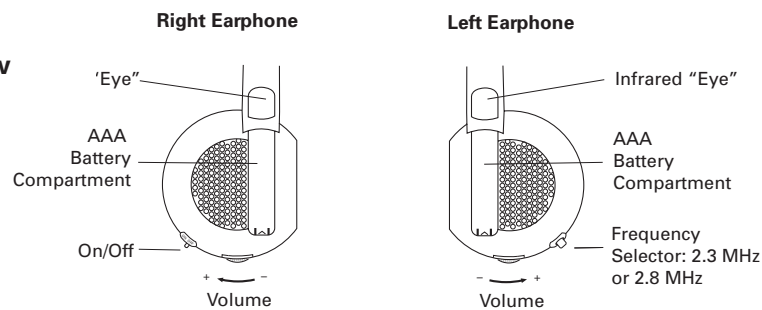

## WIR RX12-4 Receiver:

<b>Receiver Style:</b>	Body-pack, dual-lens detector, lanyard
<b>Size:</b>	3-5/8" L x 2-3/8" W x 7/8" H (9.2 cm x 6 cm x 2.2 cm)
<b>Weight:</b>	4.5 oz (127 g) with batteries
<b>Color and Material:</b>	Gray, shatter-proof polyallomer
<b>Lanyard:</b>	3 ft (.91 m), allows receiver to be worn around the neck
<b>Operating Temperature:</b>	-10° C to +50° C
<b>Battery Type:</b>	2 x AA, alkaline (BAT 001) or NiMH (BAT 026)
<b>Battery Life:</b>	Alkaline: 60 hours, NiMH: 30 hours/charge
<b>Battery Drain:</b>	25 mA, nominal
<b>Charging Contacts:</b>	For use only with CHG 200 and CHG 1600 Chargers
<b>Carrier Frequency:</b>	Channel 1: 2.3MHz, Channel 2: 2.8 MHz Channel 3: 3.3MHz, Channel 4: 3.8MHz
<b>Operating Range:</b>	Up to 28,000 ft <sup>2</sup> (2,600 m <sup>2</sup> ) when using a single TX9 Emitter in single channel mode. (See coverage drawing)
<b>De-Emphasis:</b>	50 uS
<b>FM Deviation:</b>	±50 kHz
<b>Signal-to-Noise Ratio:</b>	>60 dB min.
<b>Squelch:</b>	Receiver squelches (mutes) at 40 dB S/N ratio
<b>Frequency Response:</b>	25 Hz to 16 KHz, +1 dB, -3 dB, electrical response
<b>Total Harmonic Distortion:</b>	Less than 1%, electrical response
<b>Controls:</b>	ON/OFF/VOLUME: Combination thumbwheel knob Channel Selector: Four position rotary switch
<b>Indicators:</b>	Red LED "ON" indicator, flashes to indicate Low battery
<b>Audio Output Jacks:</b>	3.5 mm stereo mini phone jack. Accepts 3.5 mm mono or stereo phone plug.
<b>Audio Output Power:</b>	15 mW max at 32 Ω
<b>Acoustic Output:</b>	110 dB SSPL90 w/ EAR 013
<b>Sensitivity:</b>	Better than 1 nW/cm <sup>2</sup> for 40 dB signal to noise ratio
<b>Approvals:</b>	CE, FCC
<b>Warranty:</b>	5 years on receiver, 90 days on accessories
<b>Compatible Headphones/Earpad:</b>	Mono or stereo, 8-32 ohms, 3.5 mm mini phone plug, HED 021, EAR 013, EAR 014, EAR 022

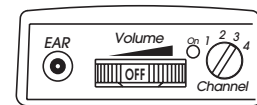

Fig. 10a: RX12-4 Top View

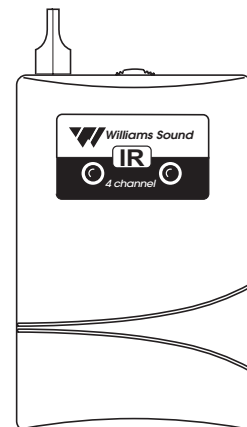

Fig. 10b: RX12-4 Front View

NOTE: SPECIFICATIONS SUBJECT TO CHANGE WITHOUT NOTICE!

# Sound Plus™ Value Courtroom System, Model WIR SYS 2

## Two-Channel System Diagram:

Fig. 11: Two-Channel System

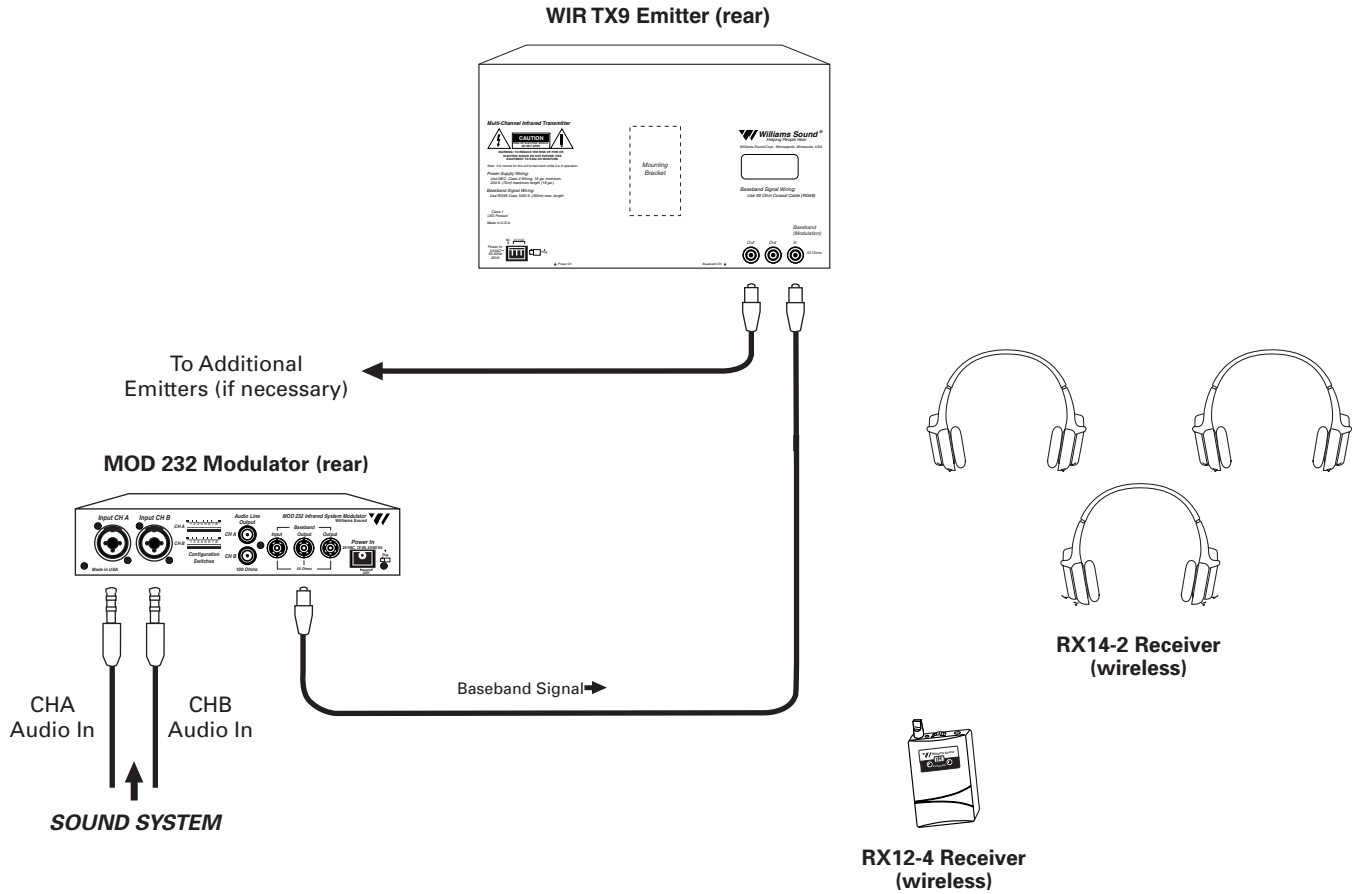

NOTE: SPECIFICATIONS SUBJECT TO CHANGE WITHOUT NOTICE!



# Sound Plus™ Value Courtroom System, Model WIR SYS 2

## Bid Specs:

### **Modulator, Model MOD 232**

The infrared system shall consist of separate modulator and emitter units, with portable receivers. The modulator unit shall be a half-rack style, metal enclosure. A rack panel shall be available to mount one or two modulator units within a single EIA rack space. An adjustable floor stand and mounting bracket shall be available to mount the modulator and emitter together for portable operation.

The modulator shall provide two channels of selectable FM carrier signals; 2.3/2.8/3.3/3.8 MHz, so that a single modulator can be used to simultaneously transmit up to two channels, and two modulators can be ganged together to transmit up to four channels simultaneously. The carrier signals shall use 50 kHz deviation and 50  $\mu$ S pre-emphasis. The carrier signals (baseband) shall be transmitted to one or more emitters by 50 ohm RG58 coaxial cable with BNC-type connectors. A BNC-type baseband input jack and baseband output jack shall be provided on the modulator. The modulator shall be powered by an external 24 VAC, 10 VA, 50-60 Hz power supply, connected via a 3-pin Molex power connector.

It shall have a rocker-type power switch, power LED indicator, four carrier indicator LEDs and two bar graph-type LED audio indicators. The modulator shall have a modulated IR LED on the front panel for testing purposes, and a headphone jack that accommodates mono and stereo 1/4" headphones and channel monitoring switch. The modulator shall have two rotary audio input level controls, and a screwdriver adjustable control for varying the input compression from 1:1 to 4:1. The modulator shall have two timers that automatically shut off the carriers when there is no audio signal present for 30 minutes. The modulator shall have two combination input jacks that accept 3-pin XLR plugs for balanced microphone input or 1/4" TRS plugs for balanced or unbalanced line-level inputs. The XLR inputs shall be low impedance, accept signal levels from 100  $\mu$ V to 90 mV, and supply 15 V simplex power per DIN45596. The TRS jacks shall accept balanced or unbalanced audio signal levels from 21 mV to 10 V. The modulator shall have CE, FCC, Industry Canada and AS approval and carry a five-year parts and labor warranty.

The modulator shall be the Williams Sound Corp. model MOD 232.

### **Emitter, Model WIR TX9**

The emitter shall be contained in a metal enclosure with a shatter-resistant lens. The emitter shall include an omnidirectional mounting bracket for permanent installation and a bracket shall be available for mounting on a floor stand for portable installations. Each emitter shall be powered by a 24 VAC, 50 VA, 50-60 Hz power supply. The power connector shall be a 3-pin Molex-type. The emitter shall have a BNC-type 50 ohm baseband input and a BNC-type baseband 50 ohm output jack. The emitter shall have a repeater circuit to allow multiple numbers of emitters to operate from the baseband signal. The emitter shall have a visible LED indicator for power and for baseband signal. Carrier frequency is 50KHz to 8 MHz. The emitter shall shut off when the baseband signal is not present. The emitter shall provide an effective coverage area of 28,000 sq ft (2,600 sq m) in single channel mode and 18,000 sq ft (1,700 sq m) in two channel mode when using the RX12-4 or RX16 receiver. The emitter shall be convection-cooled, without fans. The emitter shall have CE, FCC, RoHS, and WEEE approval and carry a five-year warranty on parts and labor.

The emitter shall be Williams Sound Corp. model WIR TX9.

### **Receiver, Model WIR RX14-2**

The receiver shall be a headset style with IR detectors positioned on top of each individual earphone. The receiver shall operate on 2.3 MHz or 2.8 MHz frequency. The receiver shall have an individual rotary-type volume control on each individual earphone and a on/off selection switch on the right earphone. The receiver shall have a push button frequency selector to choose between 2.3 MHz or 2.8 MHz operation. The receiver shall operate up to 50 hours when using AAA alkaline non-rechargeable batteries and 8 hours per charge when using AAA NiMH rechargeable batteries. The receiver shall be encased in a black, plastic case. The receiver shall operate up to 3,500 ft<sup>2</sup> (325 m<sup>2</sup>) when using a single WIR TX9 Emitter. The receiver shall be covered by a one-year parts and labor warranty, not including batteries or accessories.

The receiver shall be the Williams Sound Corp. model WIR RX14-2.

NOTE: SPECIFICATIONS SUBJECT TO CHANGE WITHOUT NOTICE!

# Sound Plus™ Value Courtroom System, Model WIR SYS 2

## Four-Channel Receiver, Model WIR RX12-4

The receiver shall be a body-pack type with an IR detector lens on the face of the unit. The unit shall have a lanyard for hands-free operation. The receiver shall have a rotary-type volume control. The receiver shall operate for 60 hours with two AA alkaline batteries and for 30 hours per charge with NiMH AA batteries. The receiver shall be charged without battery removal via charger contacts in the case. A drop-in charger accessory shall recharge the batteries in 14 hours. The receiver shall be housed in an impact resistant plastic case with a hinged battery door that does not separate from the receiver. The receiver shall receive 2.3 MHz, 2.8 MHz, 3.3 MHz or 3.8 MHz modulated IR signals with 50 µS de-emphasis. The receiver shall have a 3.5 mm stereo phone jack and accommodate low-impedance mono or stereo earphones and headphones. The receiver shall accommodate neckloop telecoil couplers. The receivers shall provide 125 dB SSPL90 output with HED 021 and 110 dB SSPL90 with EAR 013 earbud-type earphones.

The system electrical frequency response shall be 25 Hz to 16 kHz, +1, -3 dB and the signal-to-noise ratio shall be 60 dB. The receiver shall have CE, FCC, Industry Canada and AS approval. The receiver shall be covered by a five-year parts and labor warranty, excluding earphones, headphones, batteries and chargers.

The receiver shall be the Williams Sound Corp. model WIR RX12-4.

## Contact:

### United States

Williams Sound Corp.  
10321 W. 70th Street  
Eden Prairie, MN 55344  
Ph: 800-328-6190 / 952-943-2252 / FAX: 952-943-2174  
Web: [www.williamssound.com](http://www.williamssound.com)  
Email: [info@williamssound.com](mailto:info@williamssound.com)

### Canada

Thorvin Electronics  
2861 Sherwood Heights Dr. Units 36-37  
Oakville, ON L6J-7K1 Canada  
Ph: 800-323-6634 / 905-829-3040 / FAX: 905-829-4196  
Web: [www.thorvinelectronics.com](http://www.thorvinelectronics.com)

### South America

DPTech  
SIA Trecho 3/4 Lote 335 2°. Andar  
71200-030 Brasília, DF  
BRAZIL  
Ph: (5561) 361-1384  
Fax: (5561) 361-0948  
Web: [www.dpotech.com.br](http://www.dpotech.com.br)  
Email: [ws@dpotech.com.br](mailto:ws@dpotech.com.br)

### United Kingdom

Sound Associates  
Keeble House, 81 Island Farm Road  
West Molesey, Surrey KT 2SA  
United Kingdom  
Ph: (44) 020 8939 5900  
Fax: (44) 020 8939 5901  
Web: [www.soundassociates.co.uk](http://www.soundassociates.co.uk)  
Email: [jmurdoch@soundassociates.com](mailto:jmurdoch@soundassociates.com)

### Asia, Europe, Latin America, Mexico

International Sales Department  
Williams Sound Corp.  
10321 W. 70th Street  
Eden Prairie, MN 55344 USA  
Phone: +1 952 224 7791  
Fax: +1 952 943 2174  
Email: [info@williamssound.com](mailto:info@williamssound.com)  
Web: [www.williamssound.com](http://www.williamssound.com)