

SONY[®]

MSW-970

MPEG IMX CAMCORDER

MPEG IMX[™]



A New MPEG IMX Camcorder: the Best Choice for Creativity, Quality, and Reliability

As the industry has moved to embrace digital networked broadcasting, professionals at every level now appreciate the significant benefits of consistent MPEG compression throughout the entire production process. MPEG-2, the standard for DTV distribution, selected for its quality, cost efficiency, and transmission efficiency, has naturally become the strategic choice in a variety of production and postproduction applications.

Sony's first response to this demand was the MPEG IMX Series, consisting of the MSW-2000 Series VTRs and the associated MSW-900 camcorder, which operate on MPEG-2 4:2:2P@ML, I-frame-only compression. The MSW-900 camcorder demonstrated the flexibility of using MPEG compression with its 50-, 40-, and 30-Mb/s-selectable bit-rate recording – a significant advantage when running costs versus quality is a prime concern.

With drastic changes in today's and tomorrow's production environments, Sony now introduces its second-generation MPEG IMX camcorder, the MSW-970, which inherits the full functionality of the MSW-900 and adds much more. Maintaining its core concept as the workhorse model for ENG (Electronic News Gathering) and EFP (Electronic Field Production) operations, the MSW-970 brings a new level of creativity and quality into many production fields. As well as using new Power HAD™ EX CCDs and 14-bit A/D conversion for uncompromised camera image quality, this camcorder expands your shooting creativity by incorporating unique shooting functions including 24P capability* and a slow shutter function.

These factors, combined with the ultra-robust designs for which Sony camcorders are renowned, make the MSW-970 an ideal and affordable solution for a variety of applications from daily ENG and EFP operations to digital cinema productions.

**For MSW-970 (NTSC model) only.*

Brilliant performance

High Picture Quality using MPEG-2 4:2:2P@ML 50 Mb/s I-frame Compression

The MSW-970 employs MPEG-2 4:2:2P@ML recording, which uses a high bit rate of 50 Mb/s to provide outstanding picture quality. The MSW-970 camcorder also offers the wide flexibility of using MPEG compression and full 4:2:2 processing with its 50-, 40- and 30-Mb/s selectable bit-rate recording. Combining high picture quality with MPEG interoperability, the MSW-970 seamlessly works in a wide range of applications including ENG and EFP.

Power HAD EX CCD

The MSW-970 camcorder is equipped with proven state-of-the-art three-chip 2/3-inch type Sony Power HAD EX CCDs. This CCD imager achieves a high sensitivity of F11, an excellent signal-to-noise ratio of -65 dB (NTSC)/-63 dB (PAL) and a remarkably low smear level of -145 dB (typical), allowing the MSW-970 to produce pictures of stunning quality. Integration of the Power HAD EX CCDs also allows for progressive scanning, including 24P* for film-like effects.

**For MSW-970 (NTSC model) only, optional CBK-FC01 required.*

Advanced Digital Signal Processing (ADSP)

A key to quality in DSP cameras is how many bits are used in their nonlinear process, such as gamma correction. The ADSP of the MSW-970 camcorder uses more than 30 bits in its nonlinear process, minimizing round-off errors to maintain the high quality of the Power HAD EX CCDs. The ADSP also enables highly sophisticated image controls, such as the multi-matrix function, triple skin-tone detail control, and adaptive highlight control.

14-bit A/D Conversion

The MSW-970 incorporates a high-integrity 14-bit A/D conversion circuit so that images captured by the Power HAD EX CCDs are processed with great precision. This high-resolution A/D conversion allows the contrast to be reproduced faithfully in both mid-to-dark tone and bright areas of the picture.



Long Recording Times

The MPEG IMX camcorder provides long recording times, up to 60 minutes for NTSC signals and 71 minutes for PAL. These are achieved by the efficient MPEG compression algorithm, which provides the optimum balance between image quality and recording time.

High-quality Audio Recordings

Audio can be recorded in either 20- or 16-bit resolution. The recording format provides up to four channels in 20-bit mode and eight channels in 16-bit mode. Up to four channels can be recorded in either mode by the camcorder. If recordings are made on channels 1-4 in the 8-channel, 16-bit mode, then channels 5-8 are available for use with a studio VTR. The inputs to audio tracks 1-4 can be accessed by any four microphones connected to the camcorder including the front microphone and additional wired or wireless microphones.

Operational versatility

Rugged and Ergonomic Design

The design of the MSW-970 is based on years of Sony experience in camera ergonomics, and provides high mobility and balance. All switches, indicators, and an LCD panel are in the most logical places and are positioned for optimum functionality and ease of use. Operators will immediately feel at home with the MSW-970, which takes user comfort to new levels.

Compact, Lightweight, and Low Power Consumption

The MSW-970 is designed to be extremely compact and lightweight, providing a high level of mobility in the field. It weighs approximately 11 lb. 14 oz. (5.4 kg) including a viewfinder, microphone, BP-GL95 Battery Pack, and BCT-60MX cassette tape. With its new-generation LSI, the camcorder achieves a low power consumption of just 27W.

Versatile Interfaces

The MSW-970 provides an analog composite output as standard, with an SDI output board (the CBK-SD01) available as a plug-in option. An optional composite input board (the MSDW-904) is also available for pool feed applications. These optional boards install within the camcorder chassis to eliminate the need for an external camera adaptor unit, maintaining the compactness and balance of the camcorder.

Camera Remote Control

Camera settings and basic VTR functions can be remotely controlled using an optional RM-B150 or RM-B750 Remote Control Unit via its 8-pin remote connector.



Dual Optical Filters Plus Electric Color Correction

The MSW-970 comes equipped with dual optical filters for Color Correction (CC) and Neutral Density (ND) for flexible color and exposure control. In addition, it is equipped with an electronic Color Correction function, which gives operators the choice of correcting color temperature optically or electronically, according to their needs.

Assignable Functions

Functions frequently used in the field can be assigned to a push button and a simple slide switch, allowing the operator to make rapid changes when working in the field. The following functions can be assigned:

- **Push button:** disable, picture cache on/off, test out character on/off, VF marker on/off, re-take, ATW on/off, return video, lens return, recording start/stop, turbo gain on/off, zebra on/off, D5600 on/off
- **Slide switch:** disable, picture cache on/off, test out character on/off, marker on/off, recording video source selection (camcorder/external equipment), zebra on/off, D5600 on/off



*Lens, battery, and WRR-855A/855B are optional.

User-friendly Menu Controls

The MSW-970 offers an easy-to-use menu system to facilitate detailed camera settings. Setup parameters are well organized in a two-layer menu system: a user menu and a sub menu. The user menu allows access only to the standard setup functions needed by the camera operator, and can be customized for fast access to the menus they use frequently. The sub menu makes all menus accessible, each of which is categorized into groups such as paint, file, and maintenance. Menu pages can be displayed in the camcorder viewfinder, as well as on a monitor screen via the video outputs, and the menu control system can be operated easily using a rotary switch on the camcorder.

Battery Remaining Display on Viewfinder

With a Sony Professional Info Battery, the remaining capacity is automatically detected and transmitted to the MSW-970 camcorder. The remaining capacity is indicated in the camcorder viewfinder in 10% steps.



Intelligent Light System

An optional portable light (maximum 50 W) can be attached to the camcorder, using a standard lighting connector and specially designed short cable for operation from the camcorder battery. The light can be switched on and off manually, or automatically synchronized with the camcorder's REC start function.



Slot-in Mechanism for Wireless Microphone Receiver

An optional Sony wireless microphone receiver, the WRR-855A/855B, slots directly into the camcorder body without requiring a cable connection. This maintains camcorder balance and keeps the body compact, avoiding any loss of mobility.



Turbo Gain

The Turbo Gain function boosts the gain level up to +48 dB at the touch of a button. This makes it possible to shoot in extremely low light conditions. The Turbo Gain value can be selected from the menu.

Memory Stick™ System Stores Camera Setup Parameters

The MSW-970 incorporates the Sony Memory Stick system for the storage and recall of setup parameters. This is an easy, effective system for storing and recalling camera parameters for individual scenes, plus individual operators' camera-setup preferences including assignable button settings.



Adjustable Shoulder Pad

The position of the shoulder pad can be adjusted either forwards or backwards without using a screwdriver — to provide operators with a comfortable and well-balanced camera.



Creative versatility

Film-like Images with Progressive Mode

Incorporating Sony Power HAD EX CCDs, the MSW-970 generates progressive images of 29.97P and 25PD, delivering outstanding clarity as well as a cinematic look. In addition, the MSW-970 can produce 24P* images when an optional CBK-FC01 Pull-down Board is installed, offering film-like motion effects. Images captured in 24P scanning mode in the camera head are processed with 2-3 pull-down and recorded on tape at 59.94i field rate.

*For MSW-970 (NTSC model) only.

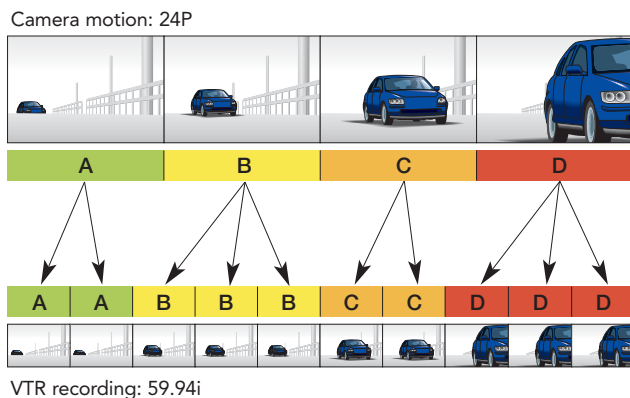

Slow Shutter

The MSW-970 offers a Slow Shutter function for shooting in low-light conditions, which can be used depending on the shooting situation or the operator's preferences. Slow Shutter allows the operator to use shutter speeds longer than the frame rate.

- NTSC: 1/30, 1/15, 1/10, 1/7.5, 1/6, 1/4.3, 1/3.8, and 1/1.9 seconds
 - PAL: 1/25, 1/12.5, 1/8.3, 1/6.3, 1/5, 1/4.2, 1/3.6, 1/3.1, and 1/1.6 seconds
- (1 to 8 and 16 frame accumulation)

Picture Cache Recording

Picture Cache Recording* is a convenient function whereby up to eight seconds of video signal are buffered into memory before the REC button is even pressed. This means that everything that happened eight seconds before the REC button was pressed, in Standby mode, will still be recorded to tape – a capability that can help prevent the loss of unexpected but important events occurring before the operator even has the chance to press the REC button.

*Optional MSDW-903 required.

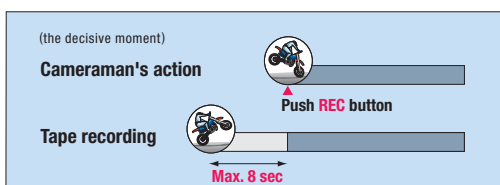

Interval Recording

Interval Recording* is also a useful function that intermittently records signals at pre-determined intervals (automatic and manual), ideal for recording over long periods. In manual mode, up to eight frames are recorded every time the REC button is pressed. In auto mode, the camera records frames at pre-determined intervals over a pre-determined total shooting time. In both modes, frames are initially stored in memory (the Picture Cache board) and, when this becomes full, the contents are copied to tape. This allows recordings to be made over long time periods on a single tape, and minimizes wear of the tape-drive mechanism.

*Optional MSDW-903 required.

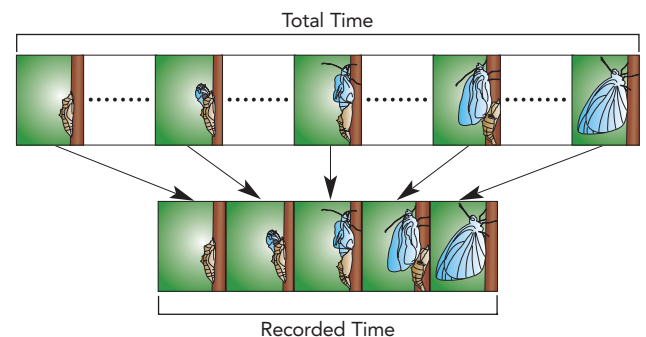

TruEye™ Processor

The Sony TruEye processor is one of the most innovative features of Sony digital signal processing technology. This technology makes it possible to virtually eliminate hue distortion, particularly obvious in high light conditions that result from conventional RGB analog or digital processing. By processing the video signal data at three levels – brightness, hue, and saturation – similar to how the human eye works, the TruEye feature assists in the reproduction of natural skin tones.



Conventional Video Equipment



TruEye
Simulated image

Adaptive Highlight Control

The MSW-970 camcorder provides multiple knee-points/slopes for superior overexposure control. The camcorder analyzes the highlight areas of a scene and automatically sets and optimizes multiple knee points/slopes accordingly. This enables the reproduction of extremely difficult images (such as an interior scene that includes a brightly sunlit window) with much more overexposure latitude. This function applies only to input video levels in excess of the knee point; the middle- and low-luminance parts of the video signal are unaffected by this control.

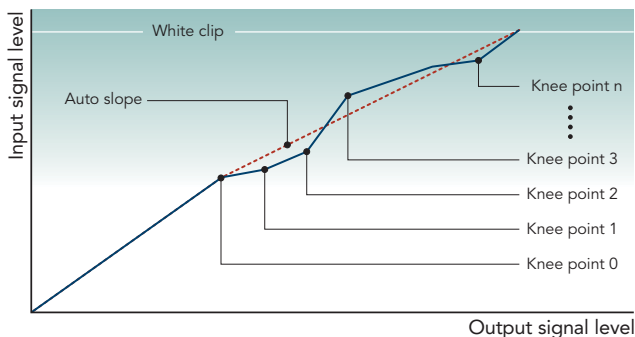

Selectable Gamma Table Including Film-like Gamma

A selectable gamma table is provided to easily give a specific look to a picture by selecting from multiple fixed gamma patterns including so-called film-like gamma. Five patterns of film-like gamma and six patterns of standard gamma can be selected.

Triple Skin Tone Detail Control

The MSW-970 comes equipped with a Triple Skin Tone Detail function, which allows for independent detail control over three specified colors. This enhances the capability of Skin Tone Detail correction - enabling one color selection to be used for reducing the detail level of skin color, and two other selections to be used for either increasing or decreasing the detail level of two other objects.

Variable Black Gamma Range

The Variable Black Gamma Range function allows for fine adjustment of tonal reproduction in the shadow area. This feature can help to bring out details from the dark parts of the picture without affecting mid-tones while maintaining the absolute black level. The variable range is LOW, Low MID, High MID, and HIGH.

Auto Tracing White Balance (ATW)

The MSW-970 offers an Auto Tracing White Balance function that automatically adjusts the camera's color temperature in real time with a change of the lighting. This is especially useful when a shoot is performed across different environments, such as from indoors to outdoors.

Multi-matrix Function

The Multi-matrix function enables color adjustments to be applied over a color and/or hue range as specified by the operator. The color spectrum is divided into 16 areas of adjustment, where the hue and/or saturation of each area can be adjusted. This provides interesting in-camera color effects - similar to secondary color correction.



Multi-matrix ON
Simulated image

Electronic Soft Focus

The Electronic Soft Focus included in the camcorder applies an effect similar to using an optical soft-focus filter - but in a much more convenient way. Electronic Soft Focus uses the detail signal to reduce, rather than increase, the sharpness of the picture. By subtracting the detail signal from the original signal (as opposed to adding it as in conventional image enhancement), Electronic Soft Focus is able to provide a picture that is "softer" than that achieved when detail is switched off completely. Electronic Soft Focus can be used in conjunction with Skin Tone Detail to change only the sharpness within a specific color or hue range.

Color Temperature Control

It is possible to dial in the required color temperature of the camera. The overall color balance of the picture can be changed to make it warmer or cooler. This feature can be used very creatively, particularly in scenes with mixed color lighting.

Metadata handling

UMID*1 Recording

The UMID is a globally unique identifier for created picture, audio, and data material. The MSW-970 automatically generates and records UMID information on tape at every scene change. By adding UMID information during the acquisition process, it is far easier to search for material during editing and archiving. Sony supports UMID as well as Extended UMID*2 for further operational convenience.

*1 UMID is recognized as a standard under SMPTE 330M.

*2 Extended UMID adds signature metadata, time, positioning, and user information to the Basic UMID.

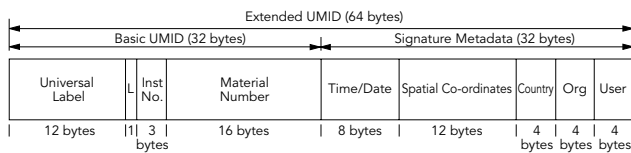

Essence Mark Handling

Essence Marks can be set during the shoot either manually or automatically. Each time the 'return' button on the lens is pressed, an Essence Mark is set. When a tape containing Essence Marks is played back on a MSW-2000 Series VTR, the Essence Mark positions are automatically detected and a list of all marks is generated for display on a video monitor. This allows operators to quickly select and cue-up to the scenes of interest.



MSW-970 Menu

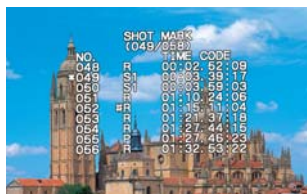

MSW-2000 Series Time Code List
Simulated image



MSW-2000 Series VTR

Tele-File™ System

The Sony Tele-File system stores and recalls various types of production data, such as shot data and shot marks, onto and from a cassette label with a built-in memory IC. The MSW-970 camcorder is equipped with a Tele-File reader/writer module as standard, allowing for this information to be managed electronically. Use of the Tele-File system can significantly raise efficiency in the subsequent editing process and management of archives.



MPEG IMX tape and Tele-File system



A wide range of optional accessories

A wide variety of accessories are available to greatly increase the versatility and operational performance of the MSW-970, making it suitable for many different applications.

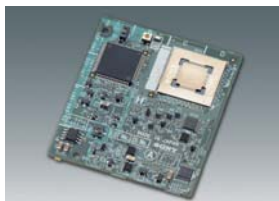

CBK-SD01
SDI Output Board



CBK-FC01
24P (2-3 pulldown) Mode Board



MSDW-903
Picture Cache Board



MSDW-904
Analog Composite Input Board



BKW-401
Viewfinder Rotation Bracket



RM-B150
Remote Control Unit



RM-B750
Remote Control Unit



AC-DN10
AC Adaptor



AC-DN2B
AC Adaptor



BP-GL65/GL95
Lithium Ion Battery Pack



BC-L70
Battery Charger



BC-M150
Battery Charger



VCT-14
Tripod Adaptor



BCT-6MX/12MX/22MX/32MX/60MX
MPEG IMX Tapes



MSH-32/64/128
Memory Stick® media



WRR-855A/855B
Wireless Microphone Receiver



WRR-862A/862B
Dual Diversity Microphone Receiver



WLL-CA50
Wireless Camera Transmitter



WLL-RX55
Wireless Camera Receiver



ECM-670/672/678
Shotgun-type Electret Condenser Microphone

- 1-547-341-12 Fog-proof Filter
- A-8262-537-A Viewfinder Eye-piece (high magnification)
- A-8262-538-A Viewfinder Eye-piece (low magnification)
- A-8267-737-A Viewfinder Eye-piece (standard magnification with special compensation for aberrations)
- A-8314-798-A Viewfinder Eye-piece (high performance, x3)
- X-3608-271-1 Standard Viewfinder Lens
- A-8278-057-A Mounting Bracket for WRR-862A/862B

System configuration

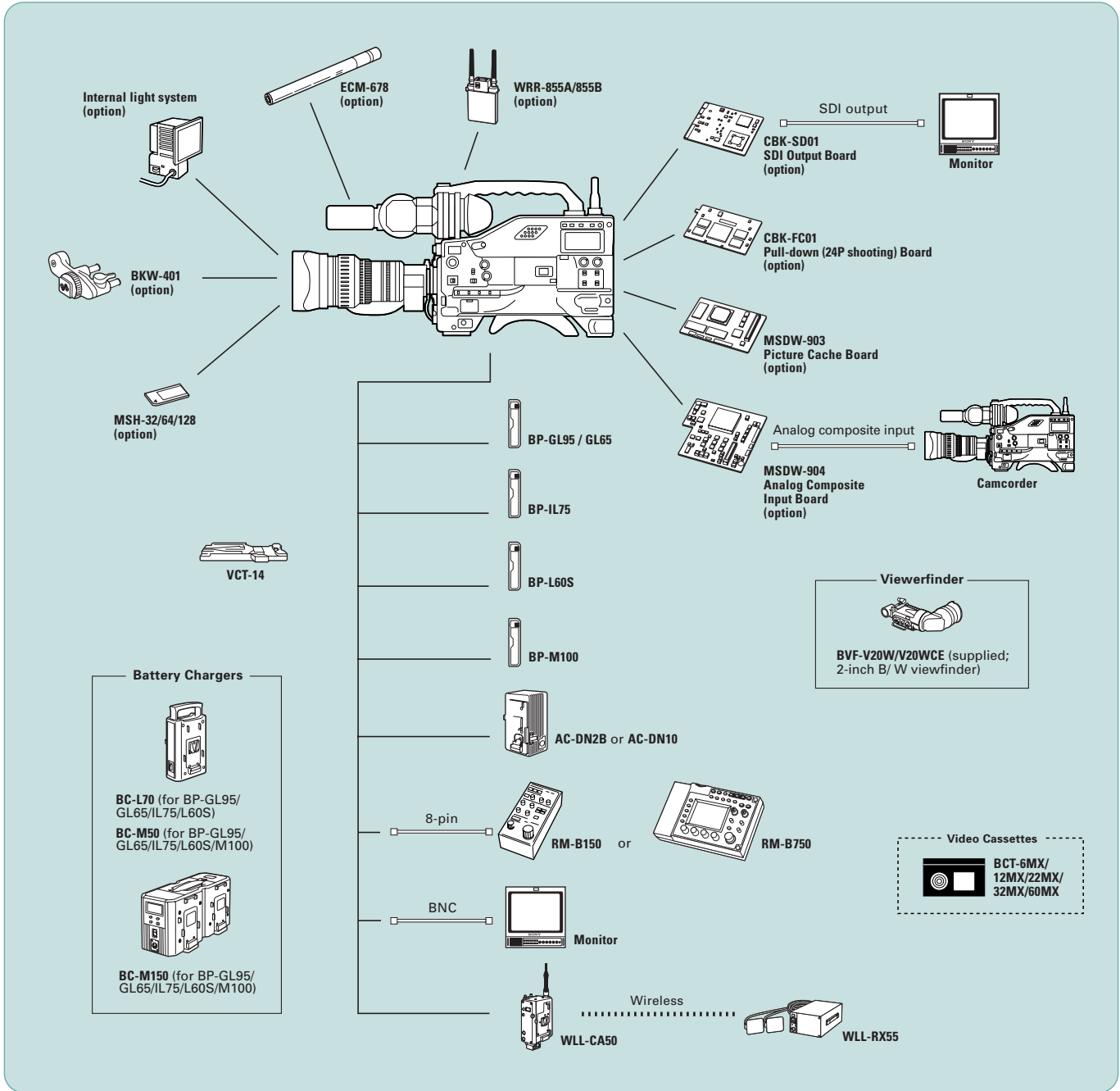

Dimensions

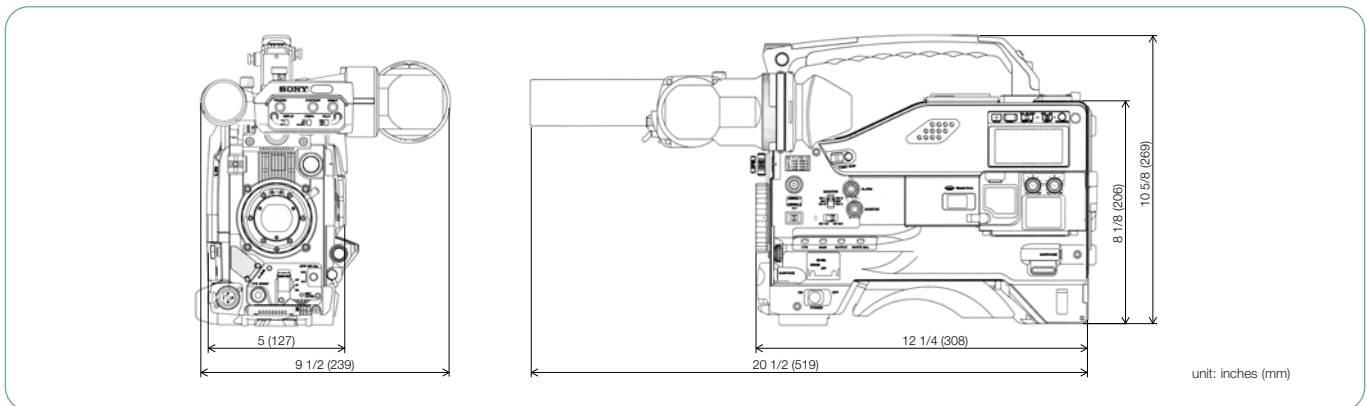

Specifications

		MSW-970	MSW-970P
General	Weight	Approx. 8 lb 3 oz (3.7 kg) 11 lb 14 oz (with VF, Mic, BCT-60MX, BP-GL95) (5.4 kg)	
	Power requirements	DC 12 V +5.0 V/-1.0 V	
	Power consumption	Approx. 27 W (with DC 12V power supply, REC mode with VF)	
	Operating temperature	+32 °F to +104 °F (0 to 40 °C)	
	Storage temperature	-4 °F to +140 °F (-20 to +60 °C)	
	Humidity	25 to 85% (relative humidity)	
	Continuous operating time	Approx. 180 min with BP-GL95 battery at 77°F (25°C), REC mode	
Signal inputs	Genlock video	BNC type x1, 1.0 Vp-p, 75 Ω	
	Time code input	BNC type x1, 0.5 to 18 Vp-p, 10 kΩ	
	Video outputs	SDI BNC type x1, 0.8 Vp-p, 75 Ω (with the CBK-SD01)	
	Audio input (CH-1/2)	XLR-3-31 type x2, -60/-50/+4 dBu selectable, high impedance, balanced (0 dBu = 0.775 Vrms.)	
	Mic input	XLR-3-31 type x1, -60/-50 dBu	
Signal outputs	Video output (Analog composite)	BNC type x1, 1.0 Vp-p, 75 Ω	
	Video test output	BNC type x1, 1.0 Vp-p, 75 Ω	
	Time code output	BNC type x1, 1.0 Vp-p, 75 Ω	
	Earphone	Minijack x2	
	Audio output (CH-1/CH-2)	XLR-5-pin male (stereo)	
Others	Lens	12-pin	
	VF	20-pin	
	Remote	8-pin	
	Light	2-pin, DC 12 V, max. 50 W	
	DC input	XLR-4-pin (male, DC 11 to 17V)	
	DC output	4-pin (for wireless microphone receiver), DC 12 V (max. 0.1 A)	
	Battery terminal	5-pin	
	Wireless receiver input	D-Sub 15-pin	
	VTR section	Recording format	Video MPEG IMX (50/40/30 Mb/s) Audio 4 ch/16 bits/48 kHz, 4 ch/20 bits/48 kHz
Tape speed		64.467 mm/s	53.776 mm/s
Playback/Recording time		Max. 60 min. with BCT-60MX cassette	Max. 71 min. with BCT-60MX cassette
Fast forward time		Approx. 5 min. with BCT-60MX	
Rewind time		Approx. 5 min. with BCT-60MX	
Recommended tape		Sony MPEG IMX S cassette (BCT-6MX/12MX/22MX/32MX/60MX)	
Digital video performance		Sampling frequency	Y: 13.5 MHz, R-Y/B-Y: 6.75 MHz
	Quantization	8 bits/sample	
	K-factor (2T pulse)	Less than 1%	
	Y/R-Y/B-Y delay	Less than 15 ns	
	Digital audio performance	Sampling frequency	48 kHz (synchronised with video)
Quantization		20/16bits/ sample (selectable)	
Frequency response		20 Hz to 20 kHz, +0.5 dB/-1.0 dB	
Dynamic range		More than 85 dB (emphasis ON)	
Distortion (at 1 kHz, emphasis ON, reference level)		Less than 0.08%	
Cross talk (at 1 kHz, reference level)		Less than -70 dB	
Wow & flutter		Below measurable limit	
Head room		20 dB (ex-factory setting)	
* The specifications given above were measured via CA-701/702 Camcorder Adapter or MSDW-902 SDI output board.			
Camera section	Pickup device	3-chip 2/3-inch type Power HAD EX CCD	
	Aspect ratio	16:9/4:3 switchable	
	Total picture elements	1038 (H) x 1008 (V)	1038 (H) x 1188 (V)
	Optical system	F1.4 prism (with quarts filter)	
	Built-in optical filters	1: Clear, 2: 1/4ND, 3: 1/16ND, 4: 1/64ND, A: CROSS, B: 3200K, C: 4300K, D: 6300K	
	Lens mount	2/3 inch type Sony bayonet mount	
	Scan format	525/59.94i, 525/29.97p, 525/23.976p	625/50i, 625/25p
	Sensitivity (2000 lx, 89.9% reflectance)	F11 (typical) (2000 lx, 89.9% reflectance)	
	Minimum illumination	0.008 lx (F1.4 lens, +48 dB gain, with slow shutter mode at 16-frame accumulation)	
	Smear level	-145 dB (typical)	
	Video S/N ratio	65 dB (typical)	63 dB (typical)
	Vertical resolution	450 TV lines (with EVS) and 400 TV lines (without EVS) at 525/59.94i mode 485 TV lines at 525/29.97p and 525/23.976p modes	480 TV lines (with EVS) and 530 TV lines (without EVS) at 625/50i mode 575 TV lines at 625/25p mode
	Shutter speed	1/100, 1/125, 1/250, 1/500, 1/1000, 1/2000 s at 525/59.94i mode 1/40, 1/60, 1/120, 1/125, 1/250, 1/500, 1/1000, 1/2000 s at 525/29.97p mode 1/32, 1/48, 1/96, 1/125, 1/250, 1/500, 1/1000, 1/2000 s at 525/23.976 mode	1/60, 1/125, 1/250, 1/500, 1/1000, 1/2000 s at 625/50i mode 1/33, 1/50, 1/100, 1/125, 1/250, 1/500, 1/1000, 1/2000 s at 625/25p mode
	ECS	60 to 6000 Hz at 525/59.94i mode, 30 to 7000 Hz at 525/29.97 mode, 24 to 5000 Hz at 525/23.976 mode	50 to 6000 Hz at 625/50i mode, 25 to 6000 Hz at 625/25p mode
	Slow shutter	1/30, 1/15, 1/10, 1/7.5, 1/6, 1/4.3, 1/3.8, 1/1.9 s (1 to 8, 16 frames)	1/25, 1/12.5, 1/8.3, 1/6.3, 1/5, 1/4.2, 1/3.6, 1/3.1, 1/1.6 s (1 to 8, 16 frames)
	Gain selection	-3, 0, 3, 6, 9, 12, 18, 24, 30, 36, 42, 48 dB (for GAIN LOW, GAIN MID, GAIN HIGH and GAIN TURBO positions)	
	Registration	0.05% (all zones without lens)	
	Warm-up time	2 s	
Modulation depth at 5MHz	70% (16:9, typical) /55% (4:3, typical)		
Viewfinder	CRT	2.0-inch type monochrome	
	Controls	BRIGHT, CONTRAST, PEAKING controls, TALLY, ZEBRA, DISPLAY switches	
	Horizontal resolution	450 TV lines (16:9)	
	Microphone	Electret condenser microphone (Ultra-directional) (Detachable)	
Supplied accessories	Operation manual (x1), Viewfinder (x1), Lens cap (x1), Shoulder belt (x1), Monaural microphone (x1), XLR connector cap (x4)		

SONY

SONY[®]

Sony Electronics Inc.
1 Sony Drive
Park Ridge, NJ 07656
www.sony.com/professional

© 2005 Sony Electronics Inc. All rights reserved.
Reproduction in whole or in part without written permission is prohibited.
Features and specifications are subject to change without notice.
Sony, MPEG IMX, Memory Stick, Power HAD, Tele-File, and
TruEye are trademarks of Sony.