



LCD Digital Color TV



Operating Instructions

KDL-26S3000
KDL-32S3000
KDL-40S3000
KDL-46S3000

BRAVIA

Owner's Record

The model and serial numbers are located at the rear of the TV. Record these numbers in the spaces provided below. Refer to them whenever you call upon your Sony dealer regarding this TV.

Model Name

Serial No.

WARNING

To reduce the risk of fire or electric shock, do not expose this TV to rain or moisture.



This symbol is intended to alert the user to the presence of uninsulated "dangerous voltage" within the TV's enclosure that may be of sufficient magnitude to constitute a risk of electric shock to persons.



This symbol is intended to alert the user to the presence of important operating and maintenance (servicing) instructions in the literature accompanying the TV.

The TV shall not be exposed to dripping or splashing and no objects filled with liquids, such as vases, shall be placed on the TV.

CAUTION

To prevent electric shock, do not use this polarized AC plug with an extension cord, receptacle or other outlet unless the blades can be fully inserted to prevent blade exposure.

Declaration of Conformity

Trade Name: SONY
 Model: KDL-26S3000/KDL-32S3000/
 KDL-40S3000/KDL-46S3000
 Responsible Party: Sony Electronics Inc.
 Address: 16530 Via Esprillo,
 San Diego, CA 92127 U.S.A.
 Telephone Number: 858-942-2230

This device complies with part 15 of the FCC rules. Operation is subject to the following two conditions: (1) This device may not cause harmful interference, and (2) this device must accept any interference received, including interference that may cause undesired operation.

NOTIFICATION

This equipment has been tested and found to comply with the limits for a Class B digital device, pursuant to Part 15 of the FCC Rules. These limits are designed to provide reasonable protection against harmful interference in a residential installation. This equipment generates, uses and can radiate radio frequency energy and, if not installed and used in accordance with the instructions, may cause harmful interference to radio communications.

However, there is no guarantee that interference will not occur in a particular installation. If this equipment does cause harmful interference to radio or television reception, which can be determined by turning the equipment off and on, the user is encouraged to try to correct the interference by one or more of the following measures:

- Reorient or relocate the receiving antenna.
- Increase the separation between the equipment and receiver.
- Connect the equipment into an outlet on a circuit different from that to which the receiver is connected.
- Consult the dealer or an experienced radio/TV technician for help.

Pursuant to FCC regulations, you are cautioned that any changes or modifications not expressly approved in this manual could void your authority to operate this equipment.

For Customers in Canada

This Class B digital apparatus complies with Canadian ICES-003.

Safety

- Operate the TV only on 120 - 240 V AC.
- Use the AC power cord specified by Sony and suitable for the voltage where you use it.
- The plug is designed, for safety purposes, to fit into the wall outlet only one way. If you are unable to insert the plug fully into the outlet, contact your dealer.
- If any liquid or solid object should fall inside the cabinet, unplug the TV immediately and have it checked by qualified service personnel before operating it further.
- If you will not be using the TV for several days, disconnect the power by pulling the plug itself. Never pull on the cord.
- When disconnecting AC power cord, the power cord should be easily accessible for disconnection.
- For details concerning safety precautions, see "Important Safety Instructions" on page 4.

Installing

- The TV should be installed near an easily accessible power outlet.
- To prevent internal heat buildup, do not block the ventilation openings.
- Do not install the TV in a hot or humid place, or in a place subject to excessive dust or mechanical vibration.
- Avoid operating the TV at temperatures below 41°F (5°C).
- If the TV is transported directly from a cold to a warm location, or if the room temperature changes suddenly, the picture may be blurred or show poor color due to moisture condensation. In this case, please wait a few hours to let the moisture evaporate before turning on the TV.
- To obtain the best picture, do not expose the screen to direct illumination or direct sunlight. It is recommended to use spot lighting directed down from the ceiling or to cover the windows that face the screen with opaque drapery. It is desirable to install the TV in a room where the floor and walls are not of a reflective material.

CAUTION

Use the following Sony TV only with the following WALL-MOUNT BRACKET.

Sony TV Model No.		
	KDL-26S3000	KDL-32S3000 KDL-40S3000 KDL-46S3000
Sony Wall-Mount Bracket Model No.	SU-WL100	SU-WL500
Sony TV-Stand Model No.	-	RHT-G800

Use with other WALL-MOUNT BRACKET or TV stand may cause instability and possibly result in injury.

To Customers

Sufficient expertise is required for installing the specified TV. Be sure to subcontract the installation to a Sony dealer or licensed contractor and pay adequate attention to safety during the installation.

Note

This television includes a QAM demodulator which should allow you to receive unscrambled digital cable television programming via subscription service to a cable service provider. Availability of digital cable television programming in your area depends on the type of programming and signal provided by your cable service provider.

Trademark Information

Macintosh is a trademark licensed to Apple Computer, Inc., registered in the U.S.A. and other countries.

HDMI, the HDMI logo and High-Definition Multimedia Interface are trademarks or registered trademarks of HDMI Licensing LLC.

Manufactured under license from Dolby Laboratories. "Dolby" and double-D symbol are trademarks of Dolby Laboratories.

Blu-ray Disc is a trademark.

"BRAVIA" and BRAVIA, S-Force, BRAVIA Theatre Sync,  and DME^x are trademarks or registered marks of Sony Corporation.

"XMB", "XrossMediaBar" and "PS3" are trademarks of Sony Corporation and/or Sony Computer Entertainment Inc.



Contents

Important Safety Instructions	4
-------------------------------------	---

Welcome to the World of BRAVIA™

The Four Steps to Stunning HD Experience: Set, Sound, Source, and Setup	8
--	---

Picture Quality and Aspect Ratio.....	8
---------------------------------------	---

TV Home Menu: XMB™ (XrossMediaBar)	9
--	---

Getting Started

1. Installing the TV.....	11
Preventing the TV from Toppling Over	11
Preparation for Wall-Mounting.....	12

2. Locating Inputs and Outputs	13
Left side	13
Rear.....	14

3. Connecting the TV.....	16
Cable System or VHF/UHF	
Antenna System.....	16
Cable System and VHF/UHF	
Antenna System.....	16
HD Cable Box/HD Satellite Box.....	16
PC.....	18
Other Equipment	19
Using HDMI Control for	
BRAVIA Theatre Sync™	20
Bundling the Connecting Cables	20

4. Setting up the Channel List	
– Initial Setup	21















Remote Control and TV	
Controls/Indicators.....	22
Inserting Batteries into the Remote	
control	22
Remote Control	22
Indicators	26

How to Use P&P and PIP Features	27
To display a picture in the Sub Window	27
To change channels in the Sub Window	27
To exit from P&P and PIP	27

Using TV Features

 Adjust TV Settings	28
 Watching TV.....	28
 Access the equipment connected to your TV	28

Navigating through TV Home Menu on XMB™	29
--	----

TV Settings Descriptions.....	30
 Product Support.....	30
 Clock/Timers Settings.....	30
 Picture Settings	30
 Sound Settings	32
 Screen Settings	32
 Video Options Settings	34
 Audio Options Settings	34
 Channel Settings	35
 Closed Captions (CC) Settings.....	36
 Parental Lock Settings.....	36
 External Inputs Settings.....	39
 HDMI Settings	39
 General Settings.....	40
 Initial Setup.....	40

Other Information

Troubleshooting.....	41
Specifications	44
Index	45





Quick Setup Guide (separate volume)
Provides a variety of optional equipment
connection diagrams.



Customer Support
<http://www.sony.com/tvsupport>
On-line Registration
United States
<http://productregistration.sony.com>
Canada
<http://www.SonyStyle.ca/registration>

Important Safety Instructions

- 1) Read these instructions.
- 2) Keep these instructions.
- 3) Heed all warnings.
- 4) Follow all instructions.
- 5) Do not use this apparatus near water.
- 6) Clean only with dry cloth.
- 7) Do not block any ventilation openings. Install in accordance with the manufacturer's instructions.
- 8) Do not install near any heat sources such as radiators, heat registers, stoves, or other apparatus (including amplifiers) that produce heat. 
- 9) Do not defeat the safety purpose of the polarized or grounding-type plug. A polarized plug has two blades with one wider than the other. A grounding type plug has two blades and a third grounding prong. The wide blade or the third prong are provided for your safety. If the provided plug does not fit into your outlet, consult an electrician for replacement of the obsolete outlet.
- 10) Protect the power cord from being walked on or pinched particularly at plugs, convenience receptacles, and the point where they exit from the apparatus.
- 11) Only use attachments/accessories specified by the manufacturer.
- 12) Use only with the cart, stand, tripod, bracket, or table specified by the manufacturer, or sold with the apparatus. When a cart is used, use caution when moving the cart/apparatus combination to avoid injury from tip-over. 
- 13) Unplug this apparatus during lightning storms or when unused for long periods of time.
- 14) Refer all servicing to qualified service personnel. Servicing is required when the apparatus has been damaged in any way, such as power-supply cord or plug is damaged, liquid has been spilled or objects have fallen into the apparatus, the apparatus has been exposed to rain or moisture, does not operate normally, or has been dropped.

USE

AC power cord

Observe the followings to prevent the AC power cord from being damaged. If the AC power cord is damaged, it may result in a fire or an electric shock. Stop using it and ask your dealer or Sony service center to exchange it.

- Do not place the TV where the power cord is subject to wear or abuse.
- Do not pinch, bend, or twist the cord excessively. The core lines may be bared and cut, causing a short-circuit, and resulting in a fire or an electric shock.
- Do not convert or damage the power cord.
- Do not allow anything to rest on or roll over the power cord.
- Do not move the TV with the power cord plugged in.
- Keep the power cord away from heat sources.
- When you disconnect the AC power cord, disconnect it from the wall outlet first.
- Be sure to grasp the plug when disconnecting the power cord. Do not pull the power cord.
- Do not use the supplied AC power cord on any other equipment.
- Use only an original Sony AC power cord, not other brands.



Wall outlet

The TV set with a three-wire grounding type AC power cord plug must be connected to an AC power socket outlet with a protective earthing connection.

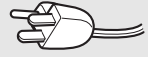

Do not use a poor fitting outlet.

Insert the plug fully into the outlet. If it is loose, it may cause arcing and result in a fire.

Contact your electrician to have the outlet changed.



Wiring

When connecting cables, be sure to unplug the AC power cord for your safety.

Take care not to catch your feet on the cables. It may damage the TV set.

Electric shock

Do not touch the AC power cord or the TV with a wet hand. If you plug/unplug the AC power cord from the TV with a wet hand, it may cause electric shock.



Lightning storms

For added protection for this TV during a lightning storm, or when it is left unattended and unused for long periods of time, unplug it from the wall outlet and disconnect the antenna. This will prevent damage to the TV due to lightning and power line surges.



When not in use

If you will not be using the TV set for several days, the TV set should be disconnected from the AC power outlet for environmental and safety reasons. The TV set is not disconnected from the AC power source when the TV set is switched off. To disconnect the TV set completely, pull the plug from the AC power outlet.



Overloading

This TV set is designed to operate on a 120 - 240 V AC supply only. Take care not to connect too many appliances to the same AC power outlet as this could result in a fire or an electric shock.



Optional equipment

Do not install optional equipment too close to the TV set. Keep optional equipment at least 11 7/8 inches (30 cm) away from the TV set. If a VCR is installed in front of the TV set or beside the TV set, the picture may become distorted. Picture distortion and/or noisy sound may occur if the TV set is positioned in close proximity to any equipment emitting electromagnetic radiation.

Small accessories

Keep small accessories out of children's reach.

ANTENNAS

Outdoor antenna grounding

If an outdoor antenna is installed, follow the precautions below. An outdoor antenna system should not be located in the vicinity of overhead power lines or other electric light or power circuits, or where it can come in contact with such power lines or circuits.

WHEN INSTALLING AN OUTDOOR ANTENNA SYSTEM, EXTREME CARE SHOULD BE TAKEN TO KEEP FROM CONTACTING SUCH POWER LINES OR CIRCUITS AS CONTACT WITH THEM IS ALMOST INVARIABLY FATAL.

Be sure the antenna system is grounded so as to provide some protection against voltage surges and built-up static charges.

Section 810 of the National Electrical Code (NEC) in USA and Section 54 of the Canadian Electrical Code in Canada provides information with respect to proper grounding of the mast and supporting structure, grounding of the lead-in wire to an antenna discharge unit, size of grounding conductors, location of antenna discharge unit, connection to grounding electrodes, and requirements for the grounding electrode.

Antenna grounding according to the National Electrical Code, ANSI/NFPA 70

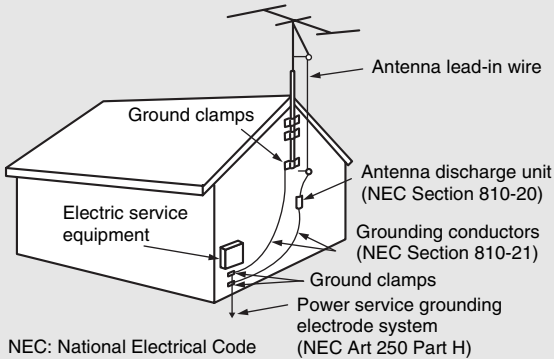

BATTERIES

- Do not dispose of batteries in a fire.
- Do not short circuit, disassemble or overheat the batteries.
- Danger of explosion if battery is incorrectly replaced. Replace only with the same or equivalent type.

Disposal of used batteries

To preserve our environment, dispose of used batteries according to your local laws or regulations.

CLEANING

Cleaning the AC power plug

Unplug the AC power plug and clean it regularly. If the plug is covered with dust and it picks up moisture, its insulation may deteriorate and result in a fire.



Cleaning the screen surface/ cabinet of the TV set

Unplug the AC power cord when cleaning this TV. If not, it may result in electric shock. Clean the cabinet of the TV with a dry soft cloth. To remove dust from the screen, wipe it gently with a soft cloth. Stubborn stains may be removed with a cloth slightly dampened with a solution of mild soap and warm water. Never use strong solvents such as thinner or benzine for cleaning. If using a chemically pretreated cloth, please follow the instruction provided on the package. The ventilation holes can accumulate dust over time. To ensure proper ventilation, we recommend removing the dust periodically (once a month) using a vacuum cleaner.



MAGNETIC INFLUENCE

This TV contains a strong magnet in the speaker unit that generates a magnetic field. Keep any items susceptible to magnetic fields away from the speaker.

SOUND

If a snapping or popping sound from the TV is continuous or frequent while the TV is operating, unplug the TV and consult your dealer or service technician. It is normal for some TV's to make occasional snapping or popping sounds, particularly when being turned on or off.



CARRYING THE TV

Carry the TV in the specified manner

To avoid dropping the TV and causing serious injury, be sure to follow these guidelines:

- Before carrying the TV, disconnect all cables.
- Carrying the large size TV requires two or more people.
- When you carry the TV, place your hand as illustrated and hold it securely. Do not put stress on the LCD panel.

KDL-26S3000



KDL-32S3000/
KDL-40S3000/
KDL-46S3000

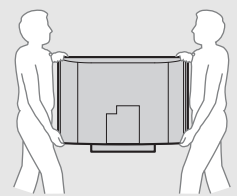

- When lifting or moving the TV, hold it firmly from the bottom. Place your palm directly under the panel.

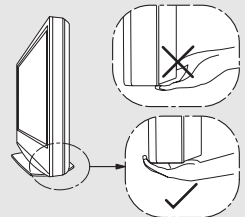

- When carrying, do not subject the TV to shocks or vibration, or excessive force.

VENTILATION

The slots and openings in the TV are provided for necessary ventilation. To ensure reliable operation of the TV and to protect it from overheating, these slots and openings must never be blocked or covered.

Unless proper ventilation is provided, the TV may gather dust and get dirty. For proper ventilation, observe the following:

- Do not install the TV face up, down or sideways.
- Do not install the TV turned over or upside down.



(Continued)

- ❑ Never cover the slots and openings with a cloth or other materials.



- ❑ Never block the slots and openings by placing the TV on a bed, sofa, rug or other similar surface.



- ❑ Never place the TV in a confined space, such as a bookcase or built-in cabinet, unless proper ventilation is provided.

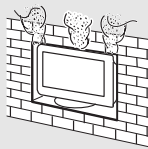

Leave some space around the TV set as shown below. Otherwise, air-circulation may be inadequate and cause overheating, which may cause a fire or damage to the TV set.

Installed on the wall

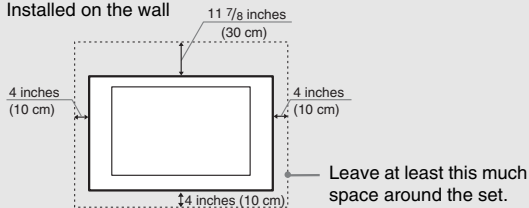

Installed with stand

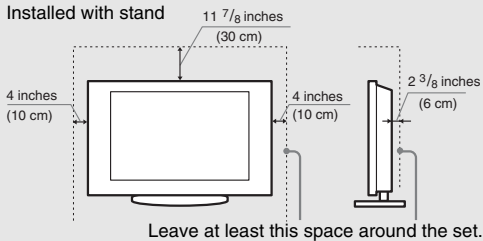

Never install the TV set as follows:

Air circulation is blocked.

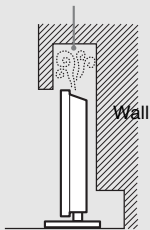

Air circulation is blocked.

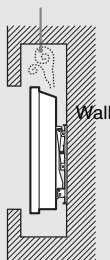

Objects and ventilation holes

Never push objects of any kind into the TV through the cabinet slots as they may touch dangerous voltage points or short out parts that could result in a fire or an electric shock. Do not place any objects on the TV.



MOISTURE

Moisture and flammable objects

- ❑ The TV must not be exposed to dripping or splashing. Do not place objects filled with liquids, such as vases, on the TV.
- ❑ Do not use power-line operated TV sets near water — for example, near a bathtub, washbowl, kitchen sink, or laundry tub, in a wet basement, or near a swimming pool, etc. It may result in a fire or an electric shock.
- ❑ Do not let this TV get wet. Never spill liquid of any kind on the TV. If any liquid or solid object does fall through, do not operate the TV. It may result in electric shock or damage to the TV. Have it checked immediately by qualified personnel.
- ❑ To prevent fire, keep flammable objects or open flame (e.g. candles) away from the TV.



INSTALLATION

Wall mount installation requires the use of a Wall-Mount Bracket. When installing or removing the TV, using a Wall-Mount Bracket, be sure to use qualified contractors. If not properly secured during installation or removal from the Wall-Mount Bracket, the TV may fall and cause serious injury.

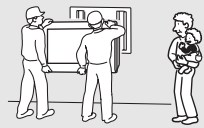

Optional wall mount

Observe the following when installing the TV using a wall-mount bracket.

- ❑ Be sure to follow the operating instructions supplied with the wall-mount bracket when installing the TV.
- ❑ Be sure to attach the brackets supplied with the wall-mount bracket.
- ❑ Do not hang the TV from the ceiling. It may fall and cause serious injury.

Placement

The TV should be installed near an easily accessible AC power outlet.

Observe the following in placing the TV. Otherwise the TV may fall from the stand or wall mount, causing damage or serious injury.

- ❑ Place the TV on a stable, level surface.
- ❑ Do not hang anything on the TV. Do not allow children to climb on the TV.



Do not install the TV in places subject to extreme temperatures, such as in direct sunlight, near a radiator, or near a heating vent. If the TV is exposed to extreme temperature, the TV may overheat and cause deformation of the enclosure or cause the TV to malfunction. Do not install the TV in a place exposed to direct air conditioning. If the TV is installed in such a location, moisture may condense inside and may cause a malfunction.

- ❑ Never place the TV in hot, oily, humid or excessively dusty places.
- ❑ Do not install the TV where insects may enter.
- ❑ Do not install the TV where it may be exposed to mechanical vibration.
- ❑ Do not install the TV in a location where it may protrude, such as on or behind a pillar, or where you might bump your head on it. Otherwise, it may result in injury.



Preventing the TV from toppling over

Take measures to prevent the TV from toppling over and causing injury. To prevent the TV from toppling over, secure the TV to a wall or stand.

Placement for viewing

It is recommended to watch the TV at a distance of 3 - 7 times that of the screen height, and in moderate brightness. Watching the TV for too long or in a dark room may cause eye fatigue. To obtain a clear picture, do not expose the screen to direct illumination or direct sunlight. If possible, use spot lighting directed down from the ceiling.

Outdoor use

Do not install this TV outdoors. If the TV is exposed to rain, it may result in a fire or an electric shock. Do not expose the TV to direct sunlight, it may heat up and become damaged.



Vehicle, ships and other vessels

Do not install this TV in a vehicle.

Bumping of the vehicle may cause the TV to fall down and cause injury.



Do not install this TV in a ship or vessel. If the TV is exposed to seawater, it may cause a fire or damage the TV.



Medical institutions

Do not place this TV in a place where medical equipment is in use.

It may cause a malfunction of medical equipment.

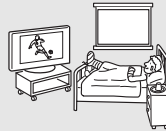

Attachments

Do not use attachments not recommended by the manufacturer, as they may cause hazards.

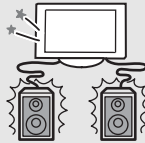

VOLUME ADJUSTMENT

- Adjust the volume so as not to trouble your neighbors. Sound carries very easily at night. Therefore, closing the windows or using headphones is suggested.
- When using headphones, adjust the volume so as to avoid excessive levels, as hearing damage may result.

LCD SCREEN

- Although the LCD screen is made with high-precision technology and has effective pixels of 99.99% or more, black dots or bright points of light (red, blue, or green) may appear constantly on the LCD screen. This is a structural property of the LCD panel and is not a malfunction.
- The LCD screen is made with high-precision technology and to achieve a high level of performance and picture quality, this TV's backlight setting is set to maximize the brightness of the TV. However, uneven brightness may be observed when the LCD TV is viewed in a dark ambient without an input source or a blank screen. This condition is normal and not a malfunction of the TV. Changing the Picture mode, Backlight setting, enabling the Light Sensor, or turning on the Power management will improve this condition.
- Do not expose the LCD screen surface to direct sunlight. Doing so may damage the LCD panel.
- Do not push or scratch the LCD screen, or place objects on top of the TV. The image may be uneven or the LCD panel may be damaged.
- If the TV is used in a cold place, a smear may occur in the picture or the picture may become dark. This does not indicate a failure. These phenomena improve as the temperature rises.
- Ghosting may occur when still pictures are displayed continuously. It should disappear after a few moments.

- The screen and cabinet get warm when the TV is in use. This is not a malfunction.
- Avoid spraying insect repellent with volatile material on the screen.
- Avoid prolonged contact with rubber or plastic material.

Broken pieces

Do not throw anything at the TV.

The screen glass may break by the impact and cause serious injury.



If the surface of the TV cracks, do not touch it until you have unplugged the AC power cord.

Otherwise electric shock may result.

Handling of broken glass and liquid crystal leakage

If the LCD panel gets damaged, crystalline liquid leakage may occur, or scattered broken glass may result. Do not touch broken glass or crystalline liquid which is toxic, with bare hands as cuts, poisoning or skin irritation may occur. Also, do not let glass fragments or leaked crystalline liquid get into your eyes or mouth. Should either contact your eyes or mouth, rinse the contacted area thoroughly with water and consult your doctor.

SERVICING

Do not attempt to service the TV yourself since opening the cabinet may expose you to dangerous voltage or other hazards. Refer all servicing to qualified service personnel.



Replacement parts

When replacement parts are required, be sure the service technician certifies in writing that he/she has used replacement parts specified by the manufacturer that have the same characteristics as the original parts.



Unauthorized substitutions may result in a fire, an electric shock or other hazards.

Safety check

Upon completion of any service or repairs to the TV, ask the service technician to perform routine safety checks (as specified by the manufacturer) to determine that the TV is in safe operating condition, and to so certify. Ask a qualified service technician to dispose of the TV.



For Customers in the United States

Lamp in this product contains mercury. Disposal of these materials may be regulated due to environmental considerations. For disposal or recycling information, please contact your local authorities or the Electronic Industries Alliance (www.eiae.org).

Welcome to the World of BRAVIA™

Thank you for purchasing this Sony BRAVIA™ high-definition television. The quality of the image you see on your BRAVIA TV is only as good as the quality of the signal it receives. To experience the stunning detail of your new BRAVIA TV, you need access to HD programming. Your BRAVIA TV can receive and display HD programming from:

- Over-the-air broadcasting via HD-quality antenna
- HD cable subscription
- HD satellite subscription
- Blu-ray Disc™ player or other external equipment

Contact your cable or satellite provider for information on upgrading to HD programming.

To learn more about HDTV, visit: <http://www.sony.com/HDTV>

The Four Steps to Stunning HD Experience: Set, Sound, Source, and Setup

Along with your BRAVIA TV **set**, a complete HD system requires an HD **sound** system, a **source** of HD programming and proper **setup** connections. This manual explains basic setup connections (see page 16). The Quick Setup Guide, enclosed separately, illustrates how to connect other optional equipment.

Picture Quality and Aspect Ratio

You can enjoy crisp, clear images, smooth movement and high-impact visuals from 1080 HD signals. When you compare a high-definition signal to a standard analog signal, you will notice a big difference. The 1080 HD signals provide more than twice the vertical resolution of the standard TV signal.

High-definition and standard-definition signals are transmitted with different aspect ratios (the width-to-height ratio of the image). HDTV uses a wider screen than conventional standard-definition TV.



16:9 (high-definition) source

Most HDTV signals use a wide screen aspect ratio of 16:9. The 16:9 fills your BRAVIA screen, maintaining a crisp, clear, vivid picture.

4:3 (standard-definition) source

Most standard-definition signals use a boxy 4:3 aspect ratio. When a 4:3 image is displayed on an HDTV, you will see black bars on the sides. The picture quality may not be as sharp as with HD sources.



- You can use the **Wide Mode** function of the TV to adjust the 4:3 image to fit the entire screen (see pages 24, 32 and 34).

TV Home Menu: XMB™ (XrossMediaBar)

The **XMB™** is a menu of BRAVIA features and input sources displayed on the TV screen. The **XMB™** is an easy way to select programming and adjust settings on your BRAVIA TV. Press the **HOME** button on your remote control to access the **XMB™**.

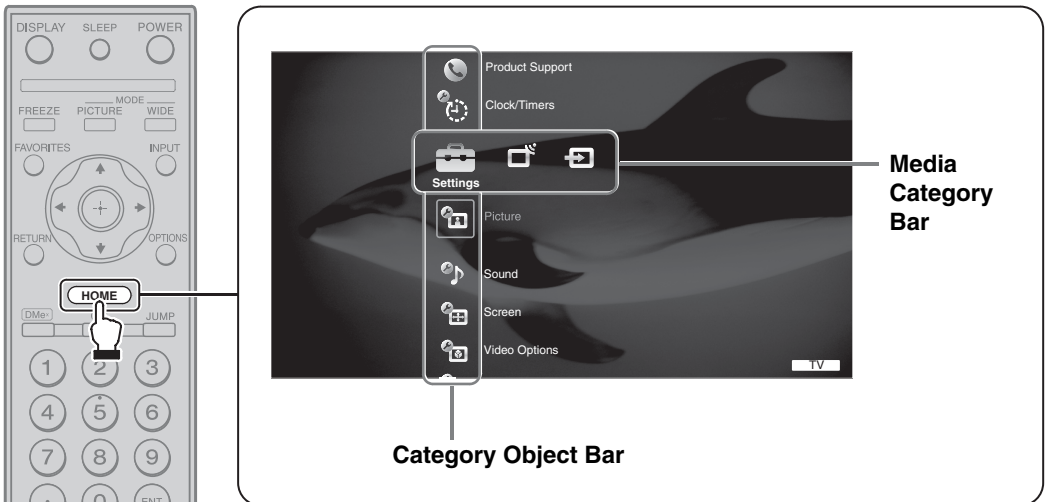

From the horizontal Media Category Bar you can control:

- **Settings:** timer, picture, sound, screen and other options (see page 30 for customization options).
- **TV Channels:** available channels are displayed on the vertical Category Object Bar.
- **External Inputs:** cable, satellite, VCR, DVD players or other inputs can also be selected from the Category Object Bar for the **External Inputs**.



- This manual is for the 26, 32 class, 40 and 46 inch BRAVIA KDL-S Series models with screen size measured diagonally. The 32 class has a 31.5 inch viewable image size (measured diagonally).

Getting Started

1. Installing the TV

Preventing the TV from Toppling Over

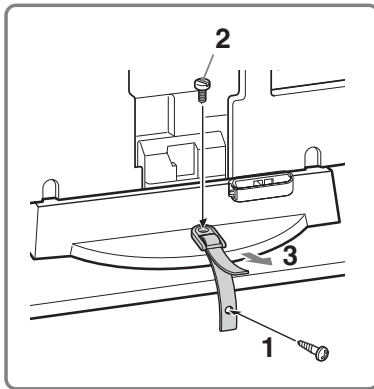
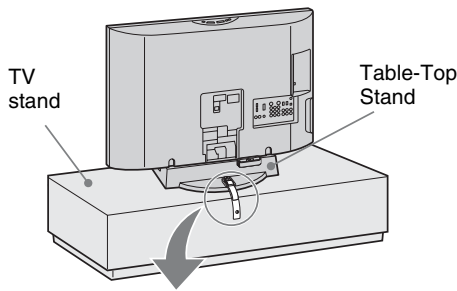

- 1** Screw the support belt (supplied) to the TV stand with a wood screw (supplied).
- 2** Attach the support belt to the Table-Top Stand with the securing screw (supplied) using a coin, etc.
- 3** Adjust the length by pulling the support belt toward you while holding the Table-Top Stand.



- Be sure to take measures to prevent the TV from toppling over and causing injury.
- The supplied wood screw may not be used depending on the type of TV stand. In this case, or when the securing strength is not enough, use commercial screws $\frac{1}{8}$ to $\frac{3}{16}$ inch (3 to 4 mm) diameter to fit to the TV stand. Consult your dealer about the types of screw(s).

Preparation for Wall-Mounting

This TV can be installed on a wall by using a Wall-Mount Bracket (sold separately). Before mounting the TV on a wall, the Table-Top Stand must be removed from the TV.



- Do not remove the Table-Top Stand for any reason other than to wall-mount the TV.

Follow the simple steps below to remove the Table-Top Stand:

- 1** Disconnect all the cables from the TV.
- 2** Gently lay the TV, face down, onto a level and stable surface covered with a thick and soft cloth. Make sure the Table-Top Stand is hanging over the edge.
- 3** Remove the screws as shown in the illustration for your model and pull the Table-Top Stand out.
- 4** Do not remove any other screws from the TV.



- Be sure to store the removed screws and Table-Top Stand in a safe place until you are ready to reattach the Table-Top Stand. Keep the screws away from small children.
- For bracket installation, refer to the instruction guide provided by the Wall-Mount Bracket model for your TV. Sufficient expertise is required in installing this TV, especially to determine the strength of the wall for withstanding the TV's weight.
- **For product protection and safety reasons, Sony strongly recommends that you use the Wall-Mount Bracket model designed for your TV and the wall-mounting of your TV should be performed by a Sony dealer or licensed contractor.**

Models: KDL-26S3000/KDL-32S3000

Remove 3 designated screws only.

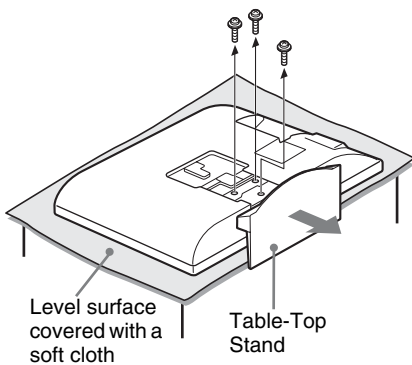

Models: KDL-40S3000/KDL-46S3000

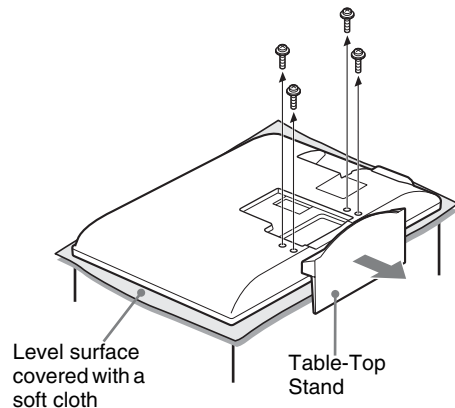

Remove 4 designated screws only.



2. Locating Inputs and Outputs

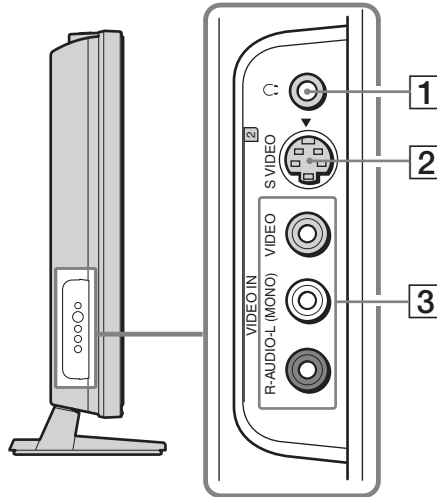



Left side

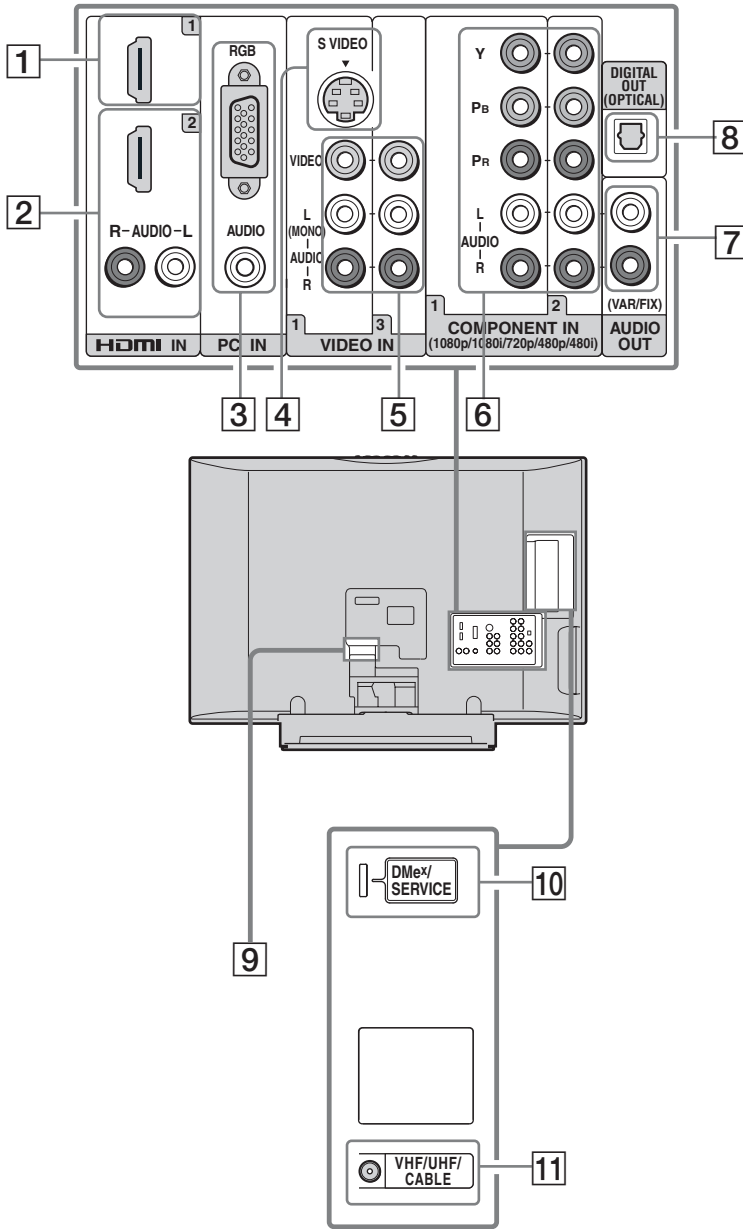

Item	Description
1 Headphone jack	Connects to your headphones. If your headphones do not match the jack, use a suitable plug adapter (not supplied).  <ul style="list-style-type: none">• While headphones are connected, the TV speakers are muted.
2 VIDEO IN 2 S VIDEO	Connects to the S VIDEO output jack on your camcorder or other video equipment that has S VIDEO. The S VIDEO provides better picture quality than composite video (3). (See Auto S Video on page 39.)
3 VIDEO IN 2 R-AUDIO-L (MONO)/VIDEO	Connects to the composite video and audio output jacks on your camcorder or other video equipment such as a VCR or video game equipment.  <ul style="list-style-type: none">• If you have mono equipment, connect its audio output jack to the TV's L (MONO) audio input jack.

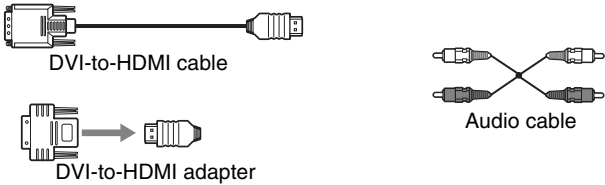
Rear



Item	Description
1 HDMI IN 1 HDMI	HDMI (High-Definition Multimedia Interface) provides an uncompressed, all-digital audio/video interface between this TV and any HDMI-equipped audio/video equipment, such as a set-top box, DVD player, Blu-ray Disc player, A/V receiver as well as PC. HDMI supports enhanced, or high-definition video, plus digital audio.
2 HDMI IN 2 HDMI/ R-AUDIO-L	If the equipment has a DVI jack and not an HDMI jack, connect the DVI jack to the HDMI IN 2 (with DVI-to-HDMI cable or adapter) jack, and connect the audio jack to the AUDIO IN (L/R) jacks of HDMI IN 2.
	 <p>The diagrams illustrate three connection options: a DVI-to-HDMI cable, a DVI-to-HDMI adapter, and an audio cable. The DVI-to-HDMI cable is shown as a single cable with a DVI connector on one end and an HDMI connector on the other. The DVI-to-HDMI adapter is shown as a separate component that fits into a DVI jack and has an HDMI jack extending from it. The audio cable is shown as a standard stereo cable with two RCA connectors.</p>
	 <ul style="list-style-type: none"> • HDMI connection is necessary to view 480i, 480p, 720p, 1080i and 1080p formats. Note that this TV displays all video input signals in a resolution of 1,366 dots × 768 lines. • Be sure to use only an HDMI cable that bears the HDMI logo.
3 PC IN (RGB/AUDIO)	Connects to a personal computer's video output connector using HD15-HD15 cable (analog RGB). Can also be connected to other analog RGB equipment. See "PC Input Signal Reference Chart" on page 18 for the signals that can be displayed.
	 <ul style="list-style-type: none"> • For some Apple Macintosh computers, it may be necessary to use an adapter (not supplied). If this is the case, connect the adapter to the computer before connecting the HD15-HD15 cable. • If the picture is noisy, flickering or not clear, adjust Phase and Pitch of Screen settings on page 33.
4 VIDEO IN 1 S VIDEO	Connects to the S VIDEO output jack of your VCR or other video equipment that has S VIDEO. S VIDEO provides better picture quality than composite video (5). (See Auto S Video on page 39.)
5 VIDEO IN 1/3 VIDEO/ L(MONO)- AUDIO-R	Connects to the composite video and audio output jacks on your A/V equipment such as a VCR or other video equipment. A third composite video and audio (VIDEO 2 IN) is located on the left side of the TV.
6 COMPONENT IN 1/2 (1080p/1080i/ 720p/480p/480i)/ L-AUDIO-R	Connects to your TV's component video (YPbPr) and audio (L/R) jacks. Component video provides better picture quality than the S VIDEO (4) or the composite video (5) connections.
	 <ul style="list-style-type: none"> • Component video (YPbPr) connection is necessary to view 480i, 480p, 720p, 1080i and 1080p formats. Note that this TV displays all video input signals in a resolution of 1,366 dots × 768 lines.
7 AUDIO OUT (VAR/FIX)	Connects to the left and right audio input jacks of your analog audio equipment. You can use these outputs to listen to your TV's audio through your stereo system.
8 DIGITAL OUT (OPTICAL)	Connects to the optical audio input of your digital audio equipment that is PCM/Dolby Digital compatible.
9 AC IN	Connects the supplied AC power cord.
10 DMe^x/ SERVICE	This USB port is for service only unless you are connecting the optional BRAVIA external module (DMe ^x).
11 VHF/UHF/CABLE	RF input that connects to your Cable or VHF/UHF antenna.

3. Connecting the TV

Cable System or VHF/UHF Antenna System

You can enjoy high-definition and standard-definition digital programming (if available in your area) along with standard-definition analog programming.



- This TV is capable of receiving unscrambled digital programming for both cable (QAM and 8VSB) and external VHF/UHF antenna (ATSC).
- It is strongly recommended that you connect the antenna/cable input using a 75-ohm coaxial cable to receive optimum picture quality. A 300-ohm twin lead cable can be easily affected by radio frequency interference, resulting in signal degradation.

Cable or VHF/UHF (or VHF only)

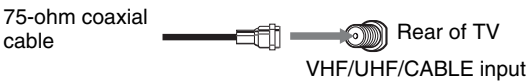

Cable System and VHF/UHF Antenna System

Use an optional A-B RF switch (not supplied) to switch between the cable and over-the-air antenna programming, as indicated below.

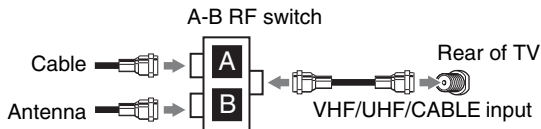

- Be sure to set the **Cable** setting to **On** or **Off** in the **Channel** settings for the type of input signal you choose (see page 35).

HD Cable Box/HD Satellite Box

You can also enjoy high-definition programming by subscribing to a high-definition cable service or a high-definition satellite service. For the best possible picture, make sure you connect this equipment to your TV via the HDMI or component video (with audio) input on the back of your TV.

Shown with HDMI Connection

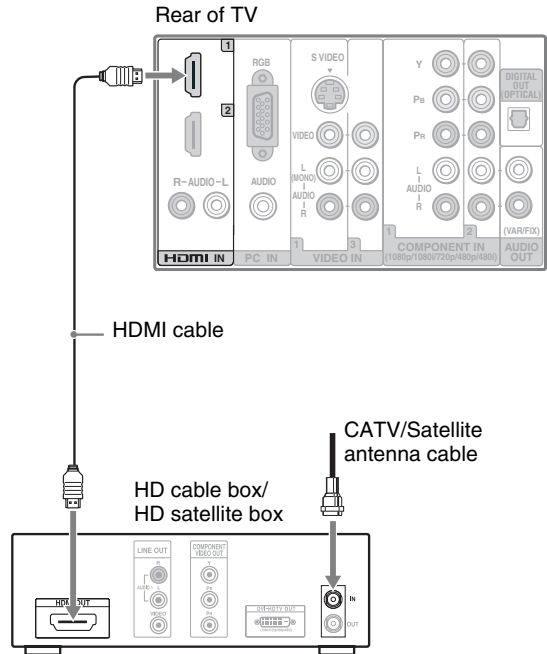

Shown with DVI Connection

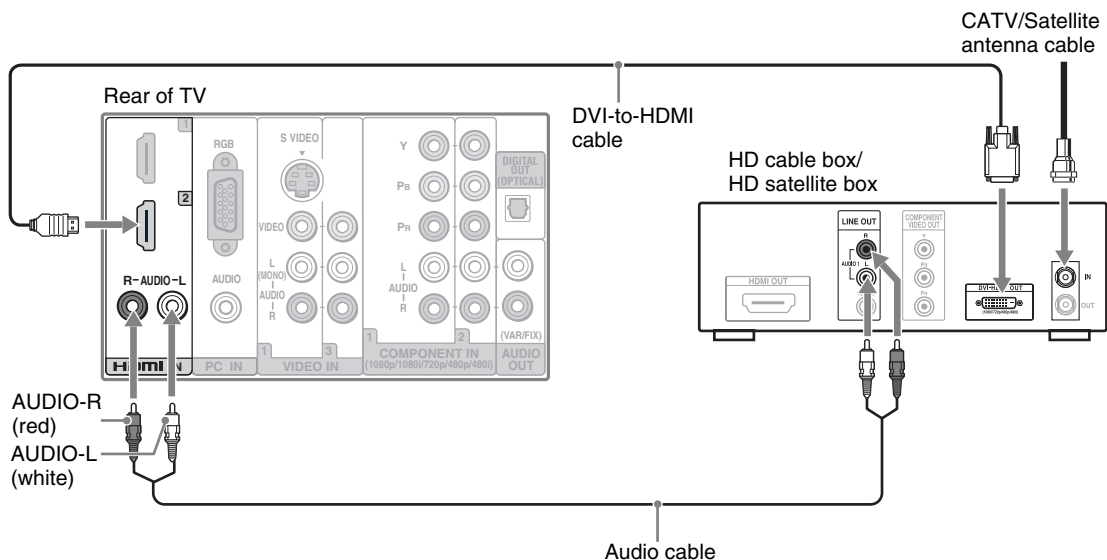

- If the equipment has a DVI jack and not an HDMI jack, connect the DVI jack to the HDMI IN 2 (with DVI-to-HDMI cable or adapter) jack and connect the audio jack to the AUDIO IN (L/R) jacks of HDMI IN 2. For details, see page 15.

Shown with Component Connection

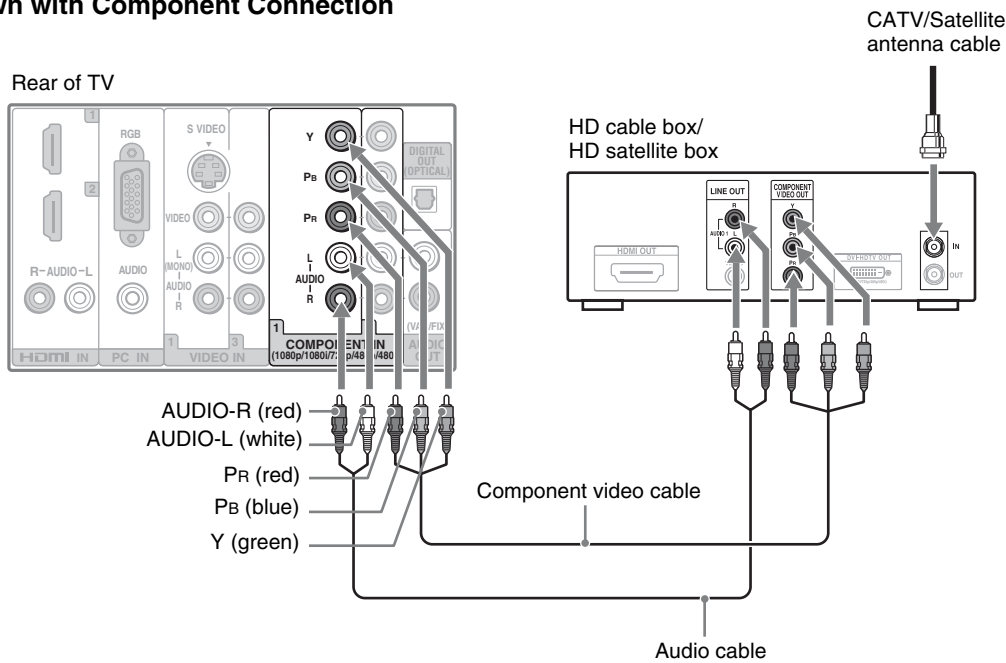

PC

Use the TV as a monitor for your PC.

Shown below with the HD15 to HD15 connection. This TV can also be connected to a PC with DVI or HDMI output. (Refer to the separate Quick Setup Guide.)

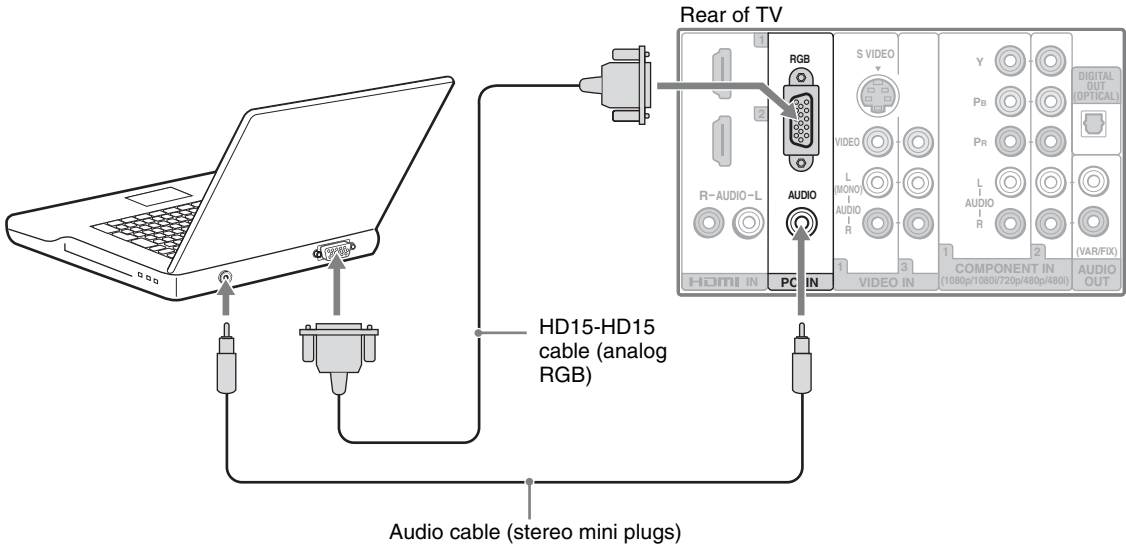

- Connect the PC IN jack to the PC using the HD15-HD15 cable with ferrite core (analog RGB) and audio cable (page 15).
- If the PC is connected to the TV and no signal has been input from the PC for more than 30 seconds, the TV enters the standby mode automatically (page 40).

PC Input Signal Reference Chart

After connecting the PC to the TV, set the output signal from the PC according to the chart below.

Resolution						
Signals	Horizontal (Pixel)	x	Vertical (Line)	Horizontal frequency (kHz)	Vertical frequency (Hz)	Standard
VGA	640	x	480	31.5	60	VGA
	640	x	480	37.5	75	VESA
	720	x	400	31.5	70	VGA-T
SVGA	800	x	600	37.9	60	VESA Guidelines
	800	x	600	46.9	75	VESA
XGA	1024	x	768	48.4	60	VESA Guidelines
	1024	x	768	56.5	70	VESA
	1024	x	768	60.0	75	VESA
WXGA	1280	x	768	47.4	60	VESA
	1280	x	768	47.8	60	VESA
	1360	x	768	47.7	60	VESA

- This TV's PC input does not support Sync on Green or Composite Sync.
- This TV's PC VGA input does not support interlaced signals.
- For the best picture quality, it is recommended to use the signals (boldfaced) in the above chart with a 60 Hz vertical frequency from a personal computer. In plug and play, signals with a 60 Hz vertical frequency will be detected automatically. (PC reboot may be necessary.)

Other Equipment

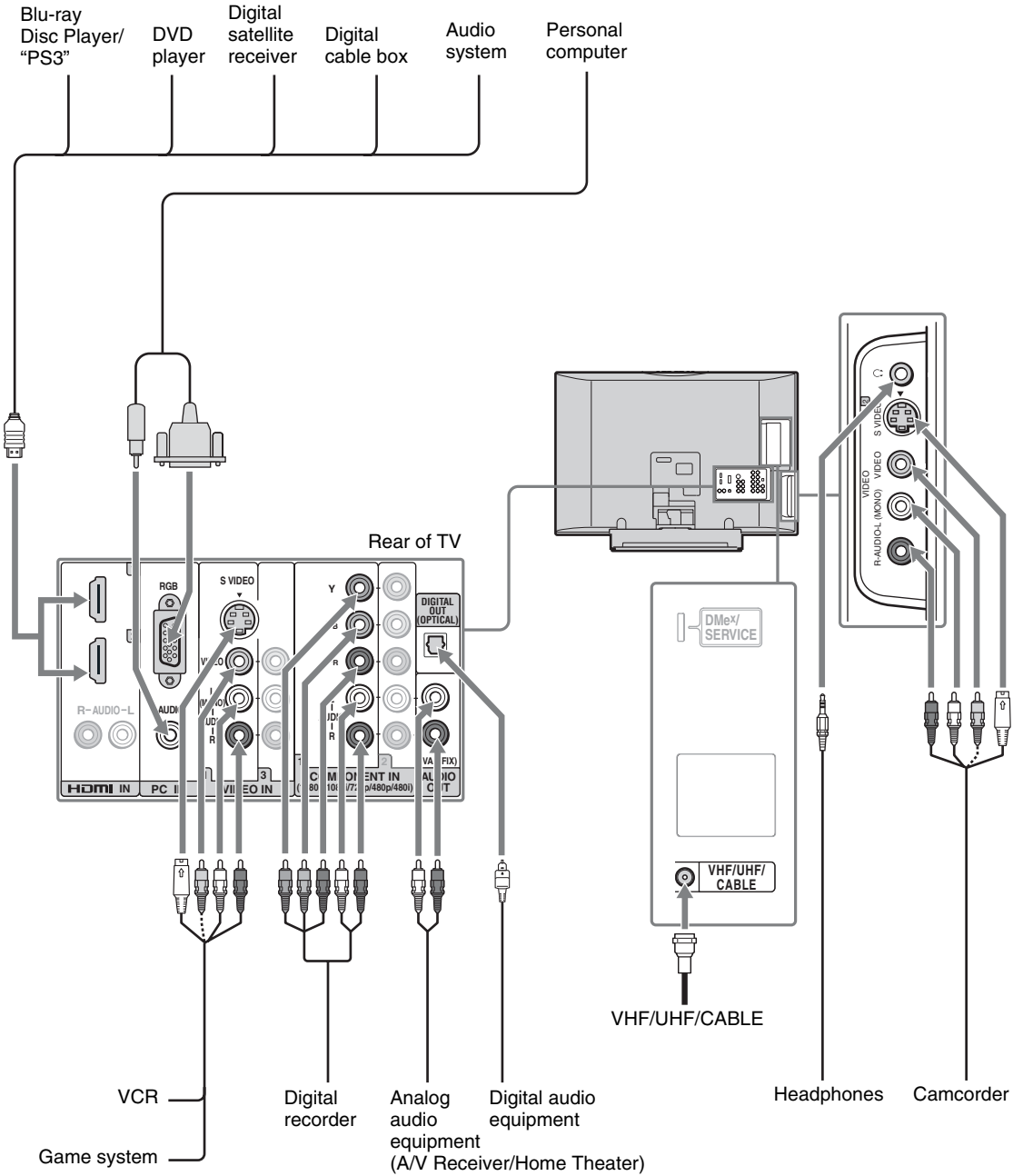

- Refer to the Quick Setup Guide (supplied) when connecting other equipment to your TV.

Using HDMI Control for BRAVIA Theatre Sync™

This TV is equipped with BRAVIA Theatre Sync. The **HDMI Control** function enables BRAVIA Theatre Sync to allow communication between Sony TV's and Sony equipment. Only Sony equipment with HDMI Control capability is supported.

To connect HDMI Control equipment

Use an HDMI cable that bears the HDMI logo for connection. See pages 16 to 19 or see the HDMI connection shown in the Quick Setup Guide provided with the TV documentation.

Setting the HDMI Control

In order for the **HDMI Control** function to operate, the TV and other Sony **HDMI Control** equipment must be setup. See page 39 on how to turn the **HDMI Control On**. For other equipment, refer to the operating instruction for that equipment.

HDMI Control available with your TV

Once the supported equipment is connected, the following operations are available:

- Turn off the equipment automatically when you turn off the TV.
- When the connected equipment is turned on by One-Touch-Play, the TV will automatically turn on and select the respective HDMI input.
- Automatically turn on equipment listed under the **External Inputs** on the **XMB™** (XrossMediaBar) when selected, see pages 9 and 28.

When a Sony A/V receiver with BRAVIA Theatre Sync is connected, the following additional operations are possible:

- Turning on the A/V receiver when the TV is turned on.
- Automatically switching to the audio output of the A/V receiver's attached speakers.
- Adjusting the volume and muting of the A/V receiver with the TV's remote control.



- The A/V receiver cannot be selected from the **XMB™**.

Bundling the Connecting Cables

You can bundle the connecting cables as illustrated below.

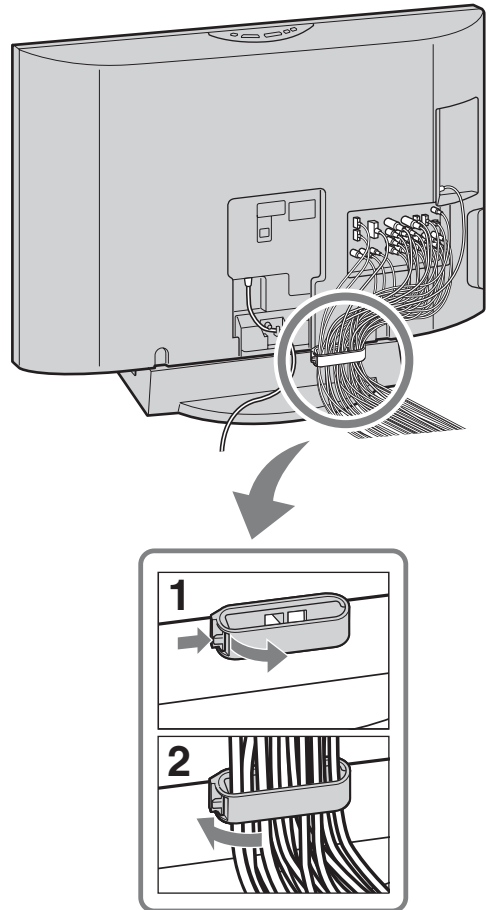

- Do not bundle the AC power cord with other connecting cables.

4. Setting Up the Channel List – Initial Setup

The **Initial Setup** screen appears when you turn on the TV for the first time.

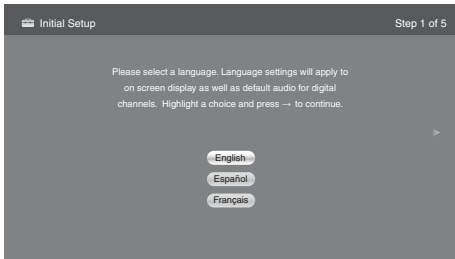

After you finish connecting the TV, you can run **Initial Setup** to create a list of available analog and digital channels if you have connected an antenna or cable directly to the TV's VHF/UHF/CABLE input.

You will be prompted to select the language of your choice to be used for all the on-screen settings.

Use the remote control to navigate through the **Initial Setup**:

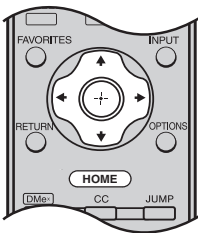

↑/↓ button:
Allows you to highlight options where applicable.

⊕ button:
Allows you to select the highlighted option and advance to the next screen.

← button:
Allows you to move back to the previous screen.

→ button:
Allows you to move to the next screen.

Follow the help text provided on the screen to run **Auto Program** with the connected signal source or select **Skip** to skip the **Auto Program** if you are receiving channels from a cable box or satellite receiver and the VHF/UHF/CABLE input is not connected. The **Auto Program** will scan for available channels. When the **Auto Program** is completed, the TV will display how many analog and digital channels are found.



- If you accidentally turn off the TV during the **Initial Setup** process, the **Initial Setup** will restart from the beginning when the TV is turned back on.
- The **Auto Program** may be canceled while the channels are being scanned. Press **RETURN** first then press either **←/→** on the remote control, highlight "Yes" to cancel or "No" to resume **Auto Program**.

□ To Run Initial Setup Again or Auto Program at a Later Time

Select the **Initial Setup** feature from the **XMB™** (XrossMediaBar) or refer to the **Initial Setup** described on page 40. To run **Auto Program**, see page 35.

□ To Add Digital Channels

Use the **Add Digital Channels** feature as described on page 35. (Useful for antenna installations.)

□ To Display the Picture in Your Preferred Aspect Ratio

Select the proper **Wide Mode** as described on pages 24 and 32.

You may want to set up convenient features such as **Favorites** (see page 23), **Show/Hide Channels** (page 35), **Edit Channel Labels** (page 35) when **Auto Program** is completed.

Remote Control and TV Controls/Indicators

Inserting Batteries into the Remote control

Insert two size AA batteries (supplied) by matching **+** and **-** on the batteries to the diagram inside the battery compartment of the remote control.

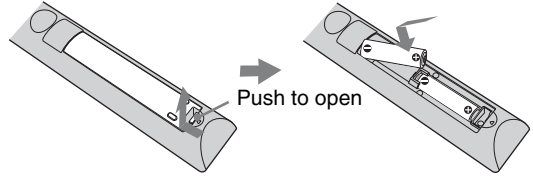

Remote Control

Buttons located at the top of the TV will operate the same as these buttons on the remote control.

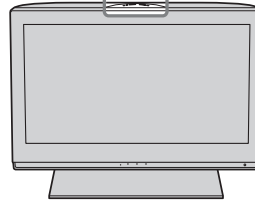
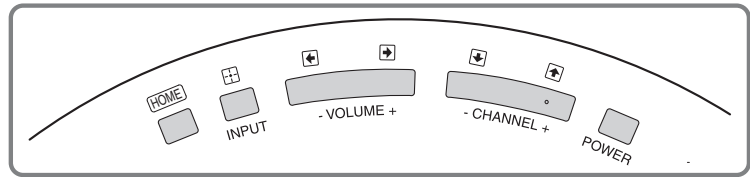
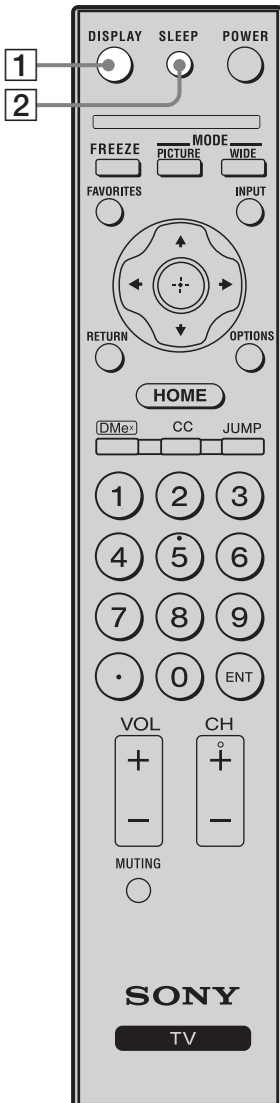

- The **5** button and **CH +** have a tactile dot. Use them as a reference when operating the TV.
- This remote control cannot be programmed to use with other equipment.

Button	Description
1 DISPLAY	Press once to display the information pertaining to the channel and/or program when available. The OSD (On Screen Display) will time out in a few seconds or press again to immediately turn off the display. You can also set the display to show minimal information. See Info Banner on page 40.
2 SLEEP	Press repeatedly until the TV displays the time in minutes (Off, 15min, 30min, 45min, 60min, 90min or 120min) that you want the TV to remain on before shutting off. To cancel Sleep Timer , press SLEEP repeatedly until Off appears.

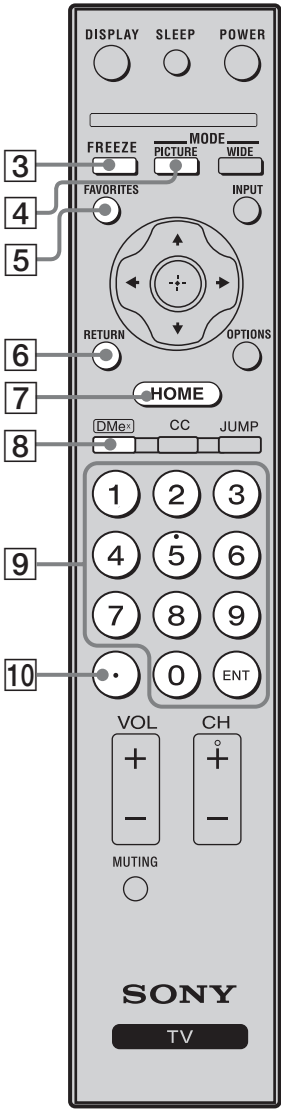

Button	Description
--------	-------------

3 FREEZE	Press once to display a frozen image with the current program in a window. Press again to fill the screen with the frozen image. Press 3rd time to return to the current program.
-----------------	---



Current program Frozen picture

Press the **▲/▼/◀/▶** to move the small window showing current program to a different location on the screen.



- With the **Freeze** feature active, some features are unavailable.
- While the **Freeze** feature is active, pressing **HOME** will deactivate the **Freeze** and display the **XMB™**.

4 PICTURE	Press repeatedly to cycle through the available picture modes: Vivid, Standard, Cinema, Video, Text . (Available options depend on the current mode.) The picture modes can also be accessed in the Picture settings. For details, see Picture settings on page 30.
------------------	--

5 FAVORITES	Press once to display the stored favorite channel list. You can store up to 30 channels in your Favorites list.
--------------------	--

How to Add to Favorites

While tuned to the channel you want to add to the list, press **OPTIONS** and highlight “Add to Favorites”, then press **+**. A confirmation message of “Channel added to Favorites” will appear for a few seconds.

How to Remove from Favorites

While tuned to a channel that exists in the **Favorites** list, press **OPTIONS** and highlight “Remove from Favorites”, then press **+**. A confirmation message of “Channel removed from Favorites” will appear for a few seconds.



Your **Favorites** list will be cleared each time you run **Auto Program** (see pages 21 and 35 for **Auto Program**).

6 RETURN	Press to go back to the previous screen or exit from the screen when displaying menu items and settings.
-----------------	--

7 HOME	Press to display the TV Home Menu/XMB™ (XrossMediaBar) to access the TV Home Menu items such as the TV Settings , TV channels and External Inputs list (see pages 9 and 28).
---------------	---



8 DMe^x	Press to access features in the optional BRAVIA external module (e.g. DMX-NV1). See your dealer or www.sony.com/bravia for more information. The module may not be available in your region.
--------------------------	---

9 0-9 ENT	Press 0-9 to select a channel; the channel changes after two seconds. Press ENT to change channels immediately.
------------------	---

10	Use with 0-9 and ENT to select digital channels. For example, to enter 2.1, press 2 , . , 1 and ENT .
-----------	---



Button	Description
11 VOL +/-	Press to adjust the volume.
12 MUTING	Press to mute the sound. Press again or press VOL + to restore the sound.
13 POWER	Press to turn on and off the TV.
14 WIDE	Press repeatedly to step through the Wide Mode settings: Wide Zoom , Normal , Full , Zoom . The Wide Mode settings can be also accessed in the Screen settings (see page 32).

Changing the Wide Screen Mode

(For PC timing, see below)

4:3 Original source Standard-definition source	16:9 Original source High-definition source
↓	↓
Wide Zoom 	Wide Zoom
Normal 	Normal This mode is not available
Full 	Full
Zoom 	Zoom





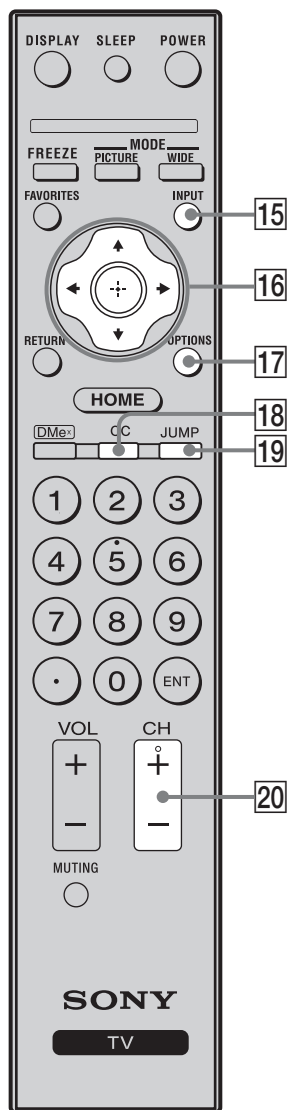

- When the TV receives a 720p, 1080i or 1080p signal, **Normal** cannot be selected.

Changing the Wide Screen Mode for PC timing

Incoming PC signal 800 × 600	Incoming PC signal 1280 × 768
↓	↓
Normal 	Normal
Full 1 	Full 1
Full 2 	Full 2



Button	Description																								
15 INPUT	Press to display the list of External Inputs and TV mode. Press repeatedly to toggle through the inputs.  • See page 39 on setting up the External Inputs labels, including the Skip feature.																								
16 	Press  to move the on-screen cursor. Press  to select/confirm an item.																								
17 OPTIONS	Press to display a list of convenient functions and menu shortcuts. The OPTIONS menu items vary based on input and content.																								
	<table border="1"> <thead> <tr> <th>Menu Item</th> <th>Reference Page</th> </tr> </thead> <tbody> <tr> <td>Picture</td> <td>See page 30</td> </tr> <tr> <td>Sound</td> <td>See page 32</td> </tr> <tr> <td>P&P or PIP</td> <td>See page 27</td> </tr> <tr> <td>Audio Swap</td> <td>See page 27</td> </tr> <tr> <td>Exit P&P or Exit PIP</td> <td>See page 27</td> </tr> <tr> <td>Speakers</td> <td>See page 34</td> </tr> <tr> <td>Add to Favorites/ Remove from Favorites</td> <td>See page 23</td> </tr> <tr> <td>MTS</td> <td>See page 34</td> </tr> <tr> <td>Alternate Audio</td> <td>See page 34</td> </tr> <tr> <td>Digital Rating</td> <td>See page 37</td> </tr> <tr> <td>Screen</td> <td>See page 32</td> </tr> </tbody> </table>	Menu Item	Reference Page	Picture	See page 30	Sound	See page 32	P&P or PIP	See page 27	Audio Swap	See page 27	Exit P&P or Exit PIP	See page 27	Speakers	See page 34	Add to Favorites/ Remove from Favorites	See page 23	MTS	See page 34	Alternate Audio	See page 34	Digital Rating	See page 37	Screen	See page 32
Menu Item	Reference Page																								
Picture	See page 30																								
Sound	See page 32																								
P&P or PIP	See page 27																								
Audio Swap	See page 27																								
Exit P&P or Exit PIP	See page 27																								
Speakers	See page 34																								
Add to Favorites/ Remove from Favorites	See page 23																								
MTS	See page 34																								
Alternate Audio	See page 34																								
Digital Rating	See page 37																								
Screen	See page 32																								
18 CC	Press to turn on and off the Closed Captions (CC). To change or customize the CC Display , see page 36.																								
19 JUMP	Press to jump back and forth between two channels. The TV alternates between the current channel and the last channel that was selected. 																								
20 CH +/-	Press to scan through channels. To scan quickly through channels, press and hold down either +/- .																								

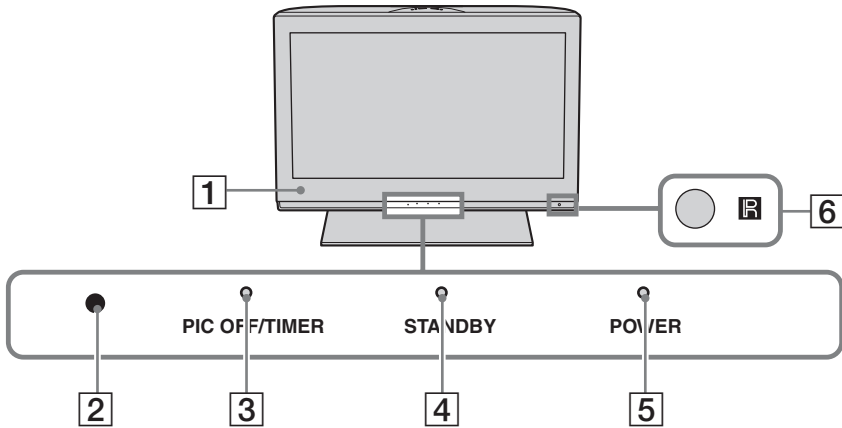

Item	Description
1 Speaker	Outputs the audio signal.
2 Light Sensor	Senses room light level and adjusts the screen brightness accordingly (see page 40 for details). Do not put anything near the sensor, as its function may be affected.
3 PIC OFF/TIMER LED	Lights up in green when the Picture Off feature is activated. Lights up in orange when the timer is set. When the timer is set, this LED will remain lit even if the TV is turned off. For details, see page 30.
4 STANDBY LED	Lights up in red when your TV is in PC standby mode. If the LED blinks in red continuously, this may indicate the TV needs servicing (see contacting Sony information on the back cover).
5 POWER LED	Lights up in green when the TV is turned on.
6 (IR) Infrared Receiver	Receives IR signals from the remote control.

How to Use P&P and PIP Features

This TV comes with the **P&P** and **PIP** features which allow you to view two pictures simultaneously. **P&P** (picture and picture) provides two windows side by side. **PIP** (picture in picture) provides PC input signal and TV channels.



- The VHF/UHF/CABLE input must be connected to use the **P&P/PIP** feature.
- These features are not available when the **Parental Lock** settings are set to block programs by ratings. If channel blocking is set, these features can still be used.
- **Closed Captions (CC)** is not available in these features.

P&P

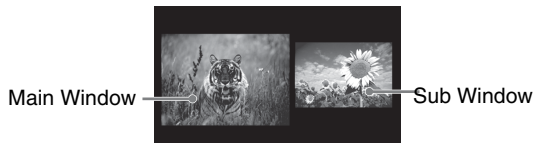

PIP



To display a picture in the Sub Window

- 1 While watching one of the following inputs: Component, HDMI or PC; press **OPTIONS** to display the **OPTIONS** menu.



- The input you are watching will become the Main Window.
- 2 Press **↑/↓** to highlight the **P&P** or **PIP** and press **⊕** to display the TV channels in the Sub Window.



- To swap audio in **P&P** mode, use the **←/→** button to swap the highlight between the Main Window and Sub Window.
- To swap audio in **PIP** mode, press **OPTIONS**, then press **↑/↓** to highlight **Audio Swap**.

To change channels in the Sub Window

Press **CH +/-** to change the channels or enter the channel number using the **0-9** numeric buttons.

To exit from P&P and PIP

- 1 Press the **OPTIONS**.
- 2 Press **⊕** while **Exit P&P** or **Exit PIP** (depends on the mode your are in) is highlighted.



- You may also press **RETURN** while in this feature to exit.
- Additional compatible device with television tuner required to watch two simultaneous live television programs.

P&P Availability	
In Main Window	In Sub Window
Component 1	TV Channel (VHF/UHF/CABLE IN)
Component 2	
HDMI IN 1 (except PC timing)	
HDMI IN 2 (except PC timing)	

PIP Availability	
In Main Window	In Sub Window
PC	TV Channel (VHF/UHF/CABLE IN)
HDMI IN 1 (PC timing)	
HDMI IN 2 (PC timing)	



- Compatible PC Timings can be found on page 18.

Using TV Features

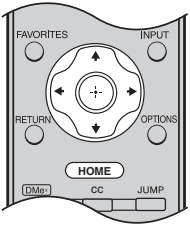

The **HOME** button allows you to access the **TV Home Menu** on the **XMB™** (XrossMediaBar) as well as a variety of TV features.

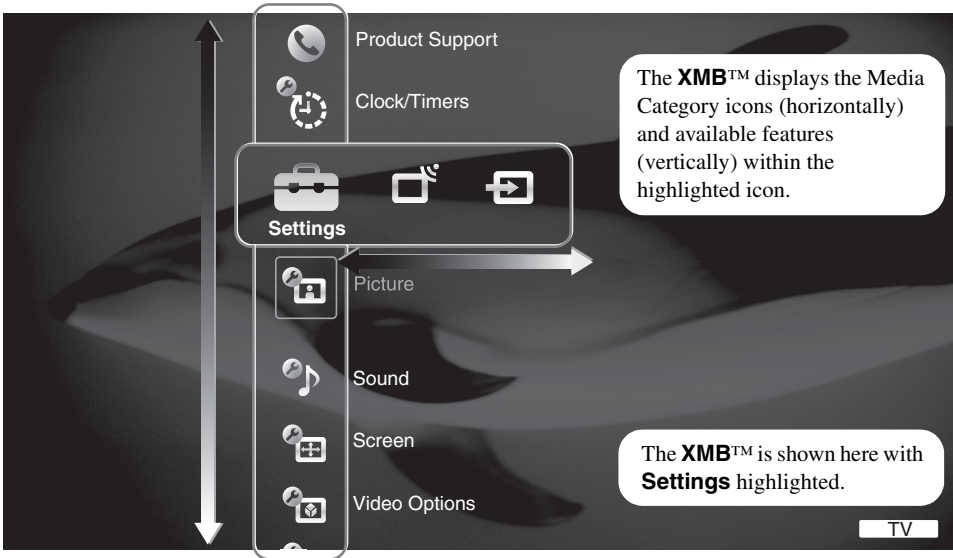

Media Category Icons



Settings

Adjust TV Settings

Customize the TV settings with various options.

Explanations of different **Settings** start from page 30.

- The available options vary depending on the situations and conditions applied. Unavailable options are grayed out or not displayed.



TV

Watching TV

Select a channel.

- You can also select a TV channel using the number **0-9** or **CH+/-** buttons (see remote control section pages 23 and 25).



External
Inputs

Access the equipment connected to your TV

Watch a movie, play a game, record a program or work on your PC.

Assign a label using the **Label Inputs** feature for your convenience, see page 39.

Navigating through TV Home Menu on XMB™

1  Press **HOME** to display the **XMB™**.

2  Press **←/→** to select a Media Category icon.



Available TV settings and features are listed under the **Settings** icon.

Available channels are listed under the **TV** icon.

Select inputs from **Video1-3**, **Component 1-2**, **HDMI 1-2**, **PC** under the **External Inputs** icon.

3  Press **↑/↓** to move within the Category Object Bar.

(The Category Object Bar shown below is for the **Settings**.)

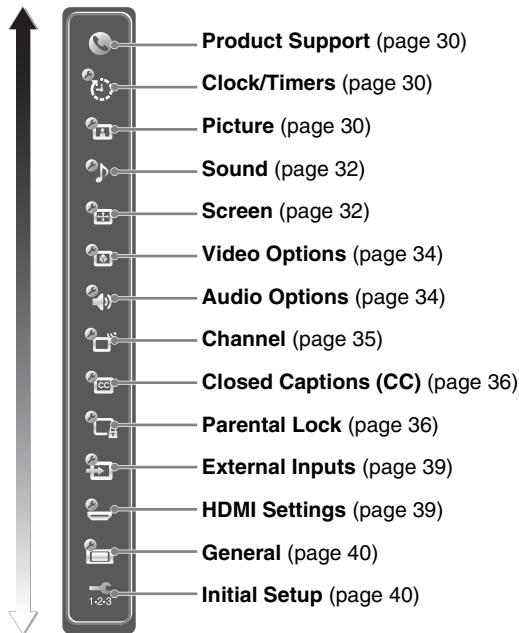

4  Press **⏏** when desired item is highlighted.

5  Press **⏏** or **↑/↓** to select the highlighted item.

6  Press **RETURN** or **HOME** to exit.



TV Settings Descriptions



Product Support

Contact Sony

Sony contact information is available from this screen for your convenience. Your TV's specific information such as Model Name, Serial Number, Software Version and downloadable ratings if available from the TV are displayed here.

Signal Diagnostics

Press to display the diagnostics information for the current signal.



Clock/Timers Settings

Current Time

Set the current time (day, hour, minutes, and AM/PM). The **Timer** feature will not be available until you set the **Current Time**.

- 1 Use the button to highlight the **Clock/Timers** icon and press .
- 2 Use the button to set the current time.
- 3 Press **RETURN** to display the confirmation screen.
- 4 Select **Yes** or **No** to save changes you made. Selecting **Yes** will save your settings and exit the **Current Time** setting screen.

Timer

After the **Current Time** is set, you can set the **Timer** to automatically turn the TV on and off and tune to a specific channel at a scheduled time.

- 1 Use the button to highlight the **Timer** icon and press .
- 2 Press to select **On** to set the timer.
- 3 Use the button to set the following: **Day of the Week**, **Time**, **Duration**, **Channel**, and **Volume**.
- 4 Press **RETURN** to display the confirmation screen.
- 5 Select **Yes** or **No** to save changes you made. Selecting **Yes** will save your settings and will light up the TIMER LED. Exit the **Timer** setting screen.

Sleep Timer

Sets the time in minutes (**Off**, **15min**, **30min**, **45min**, **60min**, **90min**, or **120min**) that you want the TV to remain on before shutting off automatically. This can also be set using the **SLEEP** button on the remote control (see page 22).



Picture Settings

Picture Mode

(Except for PC timing)

Vivid

For enhanced picture contrast and sharpness.

Standard

For standard picture settings. Recommended for home entertainment.

Cinema

For viewing film-based content. Most suitable for viewing in a theater-like environment.

Picture Mode

(For HDMI or PC timing)

Video

This option is available for PC timing (HDMI or PC input) signal for viewing video.

Text

This option is available for PC timing (HDMI or PC input) signal to enhance the text shown on the screen.



- **Picture Mode** for all inputs can also be accessed by pressing **PICTURE** on the remote control to directly toggle the modes.

Reset	Resets the current Picture Mode setting to the default values.	
Backlight	Brightens or darkens the backlight.	
Picture	Increases or decreases picture contrast.	
Brightness	Brightens or darkens the picture.	
Color	Increases or decreases color intensity.	
Hue	Increases or decreases the green tones.	
Color Temperature <i>White adjustment</i>	Cool	Gives the white colors a bluish tint.
	Neutral	Gives the white colors a neutral tint.
	Warm 1, 2	Gives the white colors a reddish tint.



- **Picture Mode** settings determines the available **Color Temperature** options:

Color Temperature options	Picture Mode for all modes excluding PC timing			PC timing only (HDMI or PC input)	
	Vivid	Standard	Cinema	Video	Text
Cool	yes	yes	yes	yes	yes
Neutral	yes	yes	yes	yes	yes
Warm1, 2	n/a	yes	yes	yes	yes

Sharpness	Sharpens or softens the picture.
Noise Reduction	Reduces the noise level of connected equipment, and the VHF/UHF/CABLE input.
MPEG Noise Reduction	Reduces the mosaic effect in MPEG-compressed video. Useful for DVDs and Digital TV channels.

Advanced Settings **Advanced Settings** are available for the following conditions:

	Vivid	Standard	Cinema	PC timing (HDMI or PC input)
Advanced Settings	n/a	yes	yes	n/a

Reset	Resets all the advanced settings to the default values.
Black Corrector	Enhances black areas of the picture for stronger contrast.
Advanced C.E. (Advanced Contrast Enhancer)	Automatically optimizes the backlight and contrast. This setting is especially effective for dark picture scenes. It will increase the contrast distinction of the dark picture scenes.
Gamma	Adjusts the balance between the light and dark areas of the picture.
Clear White	Emphasizes white and light colors.
Color Space	Selects the range of color reproduction from Wide or Normal .
Live Color	When Color Space is set to Wide , this option makes colors more vivid and reproduces clear skin tones.

Picture settings for PC timings (HDMI or PC input) are available with the following options (see above for details).



Picture Mode	Reset	Backlight	Picture	Brightness	Color Temperature
--------------	-------	-----------	---------	------------	-------------------





- **Picture** settings for all inputs can also be accessed by pressing **OPTIONS** on the remote control, then selecting **Picture** from the **OPTIONS** menu.



Sound Settings

Available **Sound** settings depend on the **Speakers** setting under **Audio Options** settings (page 34) or headphone connection.

Sound Mode	Dynamic	Enhances treble and bass.
	Standard	Suitable for spoken dialog.
	Custom	Customizes the sound settings including the Sound Booster setting.
		<ul style="list-style-type: none">• Sound Mode can also be accessed by pressing OPTIONS on the remote control.
Reset	Resets the current Sound Mode setting to the default values.	
Treble	Increases or decreases higher-pitched sounds.	
Bass	Increases or decreases lower-pitched sounds.	
Balance	Emphasizes left or right speaker balance.	
Surround	S-FORCE	Provides a virtual surround sound experience made possible using just two front speakers.
	Front Surround	
	Off	Select for normal stereo or mono reception.
Sound Booster	The Sound Booster provides a fuller sound with a greater sense of depth and width, by emphasizing the High and Low frequency sounds. Select High or Low for the amount of boost you desire while in the Custom Sound Mode . Selecting Off will bypass the emphasis.	
		<ul style="list-style-type: none">• The Sound Booster is automatically in the High position for Dynamic Sound Mode and Low position for Standard Sound Mode.
Steady Sound	On	Stabilizes the volume across all programs and commercials.
	Off	Turns off Steady Sound .
Volume Offset	Adjusts the volume level of the current input (TV or video input) relative to other inputs.	

Screen Settings

Wide Mode	Wide Zoom	Fills the screen with minimum distortion.
	Normal	Displays the 4:3 picture in its original aspect ratio when the original source is 4:3.
		<ul style="list-style-type: none">• Normal is not available when you are watching 720p, 1080i or 1080p sources.
	Full	Enlarges the picture horizontally to fill the screen when the original source is 4:3 (Standard-definition source). When the original source is 16:9 (High-definition source), select this mode to display the 16:9 picture in its original size.
	Zoom	Select to enlarge the picture horizontally and vertically to fill the screen while maintaining the aspect ratio.
		<ul style="list-style-type: none">• Wide Mode can also be accessed by pressing the WIDE button.• See WIDE button description on page 24 for accessing the Wide Mode.

Auto Wide	On	Automatically changes Wide Mode setting based upon content. If frequent screen changes are disturbing to you, select Off .
	Off	Turns off the Auto Wide option. Choose a Wide Mode from the Wide Mode option.
4:3 Default <i>Select the default screen mode to use for 4:3 sources</i>	Wide Zoom	Enlarges the 4:3 picture to fill the 16:9 screen, displaying as much of the original image as possible.
	Normal	Displays the 4:3 picture in its original aspect ratio.
	Full	Select to enlarge the 4:3 picture horizontally only, to fill the screen.
	Zoom	Select to enlarge the picture horizontally and vertically to fill the screen while maintaining the aspect ratio.
	Off	Select to continue using the current Wide Mode setting when the channel or input is changed.
		<ul style="list-style-type: none"> • This option is not available if Auto Wide is set to Off. • If 4:3 Default is set to anything but Off, the Wide Mode setting applies only to the current channel. When you change channels (or inputs), Wide Mode is automatically replaced with the 4:3 Default setting for 4:3 sources. To retain the current Wide Mode setting as channels and inputs are changed, set 4:3 Default to Off.
Display Area	Normal	Displays the picture in its original size.
	-1/-2	Enlarges the picture to hide the edge of the picture.
Screen Position	Adjust the Vertical positioning by pressing the ▲/▼ buttons. Press the ◀/▶ buttons to adjust the Horizontal positioning.	
		<ul style="list-style-type: none"> • Screen Position option is available for standard-definition signals only. Vertical adjustment is available only when Wide Mode is set to Zoom. • Screen Position feature is useful if the TV is connected to game equipment.
Vertical Size	Adjusts the vertical size of the picture. (Available only in Wide Zoom and Zoom .) Press ◀/▶ and press ⊕ to adjust.	
Screen settings for PC timings (HDMI or PC input) differ from all other input modes and are shown below.		
Auto Adjust	Select Yes to start the auto adjust to display the PC input.	
Reset	Resets the current screen setting to the default values.	
Phase	Adjust after Pitch to fine tune overall sharpness.	
Pitch	Adjust uneven sharpness on screen.	
		<ul style="list-style-type: none"> • For the PC input Signal Reference Chart, see page 18.
H Center	Allows you to move the position of the picture horizontally (left and right). To Adjust the H Center Press ▲/▼ to highlight H Center and press ⊕ . Press ◀/▶ to correct the centering then press ⊕ .	
V Center	Allows you to move the position of the picture vertically (up and down). To Adjust the V Center Press ▲/▼ to highlight V Center and press ⊕ . Press ◀/▶ to correct the centering then press ⊕ .	

(Continued)

Wide Mode	Normal	Select to display the picture in its original resolution and aspect ratio.
	Full 1	Select to enlarge the picture to fill the screen, while maintaining its original aspect ratio.
	Full 2	Select to enlarge the picture to fill the screen.

 • **Wide Mode** can also be accessed by pressing the **WIDE** button.



Video Options Settings

CineMotion	Select Auto to automatically detect film content and apply a reverse 3-2 pulldown process. Moving pictures will appear cleaner and more natural looking. The CineMotion feature can be set separately for each external input. Select Off to disable the detection.
-------------------	--



Audio Options Settings

MTS <i>Enjoy stereo, bilingual and mono programs</i>	Stereo	For stereo reception when viewing a TV program broadcast in stereo.
	Auto SAP	Automatically switches the TV to second audio programs when a SAP signal is received. If no SAP signal is present, the TV remains in Stereo mode.
	Mono	For mono reception. Use to reduce noise during weak stereo broadcasts.

 • **MTS** is available only for analog programs.

Speakers	TV Speakers	Select to use the TV speakers for audio.
	Audio System	Select this option if you wish to use an external audio system for the TV sound. By selecting this option you are disabling the TV speakers.



Audio Out <i>Easy control of volume adjustment</i>	Fixed	Select to fix the audio output and allow you to adjust the volume with your audio system's remote control. (The TV's remote control's VOLUME and MUTING buttons have no effect on the Audio Out .)
	Variable	Select to control the Audio Out 's volume and muting with your TV's remote control.



- **Alternate Audio** feature is available only for digital programs. If the program you are watching is also available in other languages from the audio tracks, and if that language is what you have selected in the **Language** setting, your TV will automatically switch to the matching language with the **Alternate Audio** feature. The **Alternate Audio** option may be accessed by pressing the **OPTIONS** button on the remote control when alternate audio stream is available from the broadcaster.



Channel Settings

Cable	On	For receiving cable channels via cable TV provider.
	Off	For using an antenna.
		<ul style="list-style-type: none">You should run Auto Program after changing the Cable setting.
Auto Program		Automatically sets up the channel list on the TV for all receivable channels. Channel scanning will be based on the Cable On/Off setting. <ol style="list-style-type: none">Select Auto Program.Select OK to start Auto Program. When Auto Program is completed, the screen will display the number of channels found.Press RETURN to exit the Auto Program.  <ul style="list-style-type: none">Running Auto Program will clear Favorites list.If you run Auto Program again, previously scanned channels will be overwritten with the newly scanned channels.
Add Digital Channels		Select to add digital channels. Be sure to have the Cable option selected appropriately for the signal source. (Useful for antenna installations.)
Show/Hide Channels		Allows you to show or hide channels when you surf with the CH +/- button or in the TV channel list on the XMB™ . <ol style="list-style-type: none">Press ▲/▼ to scroll through the channels until you highlight the channel to show or hide.Press ⊕ to select Shown or Hidden. To show or hide more channels, repeat steps 1-2.  <ul style="list-style-type: none">Hidden channels can be accessed by entering the channel number with 0-9 buttons on the remote control.
Edit Channel Labels		Assigns labels (such as station call letters) to channel numbers. <ol style="list-style-type: none">Press ▲/▼ to scroll through the channel numbers. Then press ⊕ to select the channel number to assign a label.Press ▲/▼ to scroll through the label characters (A-Z, 0-9, etc.). Press ▶ to move to the next character. Repeat to add up to 7 characters to the label. Press ⊕ to set it. To assign labels to more channels, repeat steps 1-2.

Closed Captions (CC) Settings

CC Display	This option allows you to turn On or Off the Closed Captions (CC) feature.
Analog CC	Select this option for the basic analog (EIA-608) closed caption options. CC1, CC2, CC3, CC4 Displays a printed version of the dialogue or sound effects of a program. (Should be set to CC1 for most programs.) Text1, Text2, Text3, Text4 Displays network/station information presented using either half or the whole screen (if available).
Digital CC	Select this option for both analog (EIA-608) and digital (EIA-708) closed caption options. Select from CC1-4 and Service 1-6 (advanced digital closed caption options).
Display Options	Customize the Closed Captions (CC) displays with Text, Character Size, Character Style, Character Color, Character Opacity, Edge Type, Edge Color, Background Color and Background Opacity .



- **Closed Captions (CC)** can be turned on and off directly by pressing the **CC** button on the remote control.

Parental Lock Settings

The **Parental Lock** feature allows you to block programs according to their content and rating levels and block channels (regardless of the programs). Password is necessary in setting up blocking.

To View Blocked Programs

Press **ENT** when tuned to a blocked program, then enter the password. To reactivate the **Parental Lock** settings, turn off and on the TV.

Password Use **0-9** button on the remote control to enter a four-digit password. The first time the password is created, you must re-enter it again to confirm the password. "Password Set" message will appear on the screen upon confirmation.

Change Password

You can change your password by entering the **Parental Lock** setting with the previously set password, highlight and select the **Change Password** then enter the new password.



- You need your password for any future access into the **Parental Lock** settings. If you lose your password, see "Lost password" on page 43.

Country Select the country name of **U.S.A.** or **Canada** for the appropriate ratings. The rating system varies between these two countries. See Custom Rating System Chart on page 38.

Rating	Off	Turns off Parental Lock . No programs are blocked from viewing based on their ratings.
	Child	Maximum ratings permitted are: U.S.: TV-Y, TV-G, G Canada: C, G, TV-Y
	Youth	Maximum ratings permitted are: U.S.: TV-PG, PG Canada: C8+, PG, 8 ans+, TV-PG
	Young Adult	Maximum ratings permitted are: U.S.: TV-14, PG-13 Canada: 14+, 13 ans+, TV-14
	Custom	Sets ratings manually. U.S.: See page 38 for details. Canada: See page 38 for details.



- If you are not familiar with the parental guideline rating system, you should select **Child**, **Youth**, or **Young Adult** to help simplify the rating selection. To set more specific ratings, select **Custom**.

Digital Rating (Available only in U.S.A. where advanced ratings exist)	Off	Turn Digital Rating off. No programs containing digital ratings are blocked from viewing.
	Custom	Select to customize the Parental Lock with downloadable digital ratings.
	Clear All	Select to clear the downloaded ratings.

Unrated (Available only when Country is set to U.S.A.) Block programs or movies that are broadcast without a rating	Allow	Allows programs and movies that are broadcast without a rating.
	Block	Blocks all programs and movies that are broadcast without a rating.



- If you block unrated TV programs, be aware that the following types of programs may be blocked: programs broadcast from another country, emergency broadcasts, political programs, sports, news, public service announcements, religious programs and weather.

Channel Block	This option allows you to block channels regardless of program ratings. The password needs to be set up prior to blocking channels. The blocked channel can only be viewed by entering the correct password.
	To View a Blocked Channel Press ENT button when tuned to the blocked channel then enter the password.

(Continued)

Custom Rating System Chart

For **Country** selection of **U.S.A.**:

Movie Rating	G	All children and general audience
	PG	Parental guidance suggested
	PG-13	Parental guidance for children under 13
	R	Restricted viewing, parental guidance is suggested for ages under 17
	NC-17 and X	No one 17 or under allowed
TV Rating <i>Block programs by their rating, content or both</i>	Age-Based Ratings	
	TV-Y	All children
	TV-Y7	Directed to children age 7 and older
	TV-G	General audience
	TV-PG	Parental guidance suggested
	TV-14	Parents strongly cautioned
	TV-MA	Mature audience only
	Content-Based Ratings	
	FV	Fantasy violence
	D	Suggestive dialogue
	L	Strong language
	S	Sexual situations
	V	Violence
		• To ensure maximum blocking capability, set the Age-Based Ratings.

For **Country** selection of **Canada**:

English Rating	C	All children
	C8+	Children 8 years and older
	G	General programming
	PG	Parental guidance
	14+	Viewers 14 and older
	18+	Adult programming
French Rating	G	General programming
	8 ans+	Not recommended for young children
	13 ans+	Not recommended for ages under 13
	16 ans+	Not recommended for ages under 16
	18 ans+	Programming restricted to adults
U.S.A. Rating	See TV Rating under U.S.A. for details.	



External Inputs Settings

Label Inputs	<p>You can label your inputs with the name of equipment you have connected. To assign your own label or Skip the input:</p> <ol style="list-style-type: none"> 1 Press ▲/▼ to highlight the video input (Video 1-3, Component 1-2 and HDMI 1-2, PC), then press ⊕ to select the desired input. 2 Press ▲/▼ to highlight the display label you want to assign, then press ⊕. <p></p> <ul style="list-style-type: none"> • You can select from the following labels for each input. Video 1-3, Component 1-2 and HDMI 1-2: –, DVD, Cable Box, Satellite, BD, VCR, Receiver, DVR, Game, Camcorder, PC, Skip. PC: –, Skip. • “–” indicates that no labels are assigned and displayed with the default labeling.
Auto S Video	<p>Both Video 1 and Video 2 are equipped with S VIDEO. Select Auto to connect the S VIDEO cable instead of the composite video cable for auto video detection. If you are using the composite video cable, set the setting to Off. The Off setting will disable the auto detect and allows composite connection.</p>





HDMI Settings

HDMI inputs of this TV will recognize and communicate with other Sony equipment equipped with **HDMI Control**.

HDMI Control	On/Off feature allows your TV to communicate with other equipment that supports HDMI Control .
Device Auto Power Off	Select On to have your connected HDMI Control equipment to power off automatically when the TV is turned off. Select Off to disable this function.
TV Auto Power On	Select On to control your TV’s power on from your connected HDMI Control equipment. Select Off to disable this function.
Device List	Displays a list of HDMI Control equipment connected to the TV.

General Settings

Language	Select the language of your choice from English , Español and Français to be used for displaying all the on-screen settings.
Info Banner	<p>Displays the program name and the program information such as program title and program rating (if available from the broadcaster) when option is set to On. Select Off for minimal display information. Selecting Off will not completely disable the banner display. Info Banner also appears on the screen each time the channel is changed or DISPLAY button on the remote control is pressed.</p> <p></p> <ul style="list-style-type: none">• To see the rating information on the banner, Info Banner setting must be set to On.
Power Saving	Reduces the power consumption by adjusting the backlight brightness. This also enhances the black level. Select from Off , Low , High and Picture Off .
Light Sensor	<p>Enables the automatic picture (screen) brightness control. The Light Sensor measures the room brightness which allows the TV to automatically adjust the backlight brightness based on the picture settings and the ambient room light conditions.</p> <p></p> <ul style="list-style-type: none">• Be sure not to put anything around the sensor, as its function may be affected (see page 26).• In low light the range of the backlight control is reduced when the Light Sensor is set to On.
PC Power Management	<p>On Automatically enters to standby mode when there is no signal input for more than 30 seconds. The STANDBY LED on the front panel will illuminate when PC Power Management switches the TV to standby mode.</p> <hr/> <p>Off Turns off PC Power Management.</p> <p></p> <ul style="list-style-type: none">• To bring the TV out of standby mode and recover TV features, press POWER on the remote control.• PC Power Management is not VESA-compliant.

Initial Setup

If you have missed the **Initial Setup** when you first connected the TV or if you want to scan all receivable channels, you can run the **Initial Setup**. Follow the instructions on the screen. Settings such as picture and sound adjustments will not be affected by this **Initial Setup**.



- **Favorites** list will be cleared each time you run the **Initial Setup**.

Other Information

Troubleshooting

If you have questions, service needs, or require technical assistance related to the use of your Sony TV, please visit our website or call one of the following numbers:

<http://www.sony.com/tvsupport>
 1-800-222-SONY(7669) for US Support
 1-877-899-SONY(7669) for Canadian Support

Condition	Explanation/Solution
No picture	
No picture	<ul style="list-style-type: none"> • Check the Power Saving settings (see page 40).
Cannot receive any channels	<ul style="list-style-type: none"> • Make sure the power cord is connected securely. • Turn on the power of the TV. • Check antenna/cable connections. • Make sure the Cable setting is correct for your TV signal source.
TV is locked to one channel	<ul style="list-style-type: none"> • Perform Auto Program to add receivable channels that are not present in the TV's memory (see pages 21 and 35).
Cannot receive or select channels	<ul style="list-style-type: none"> • Perform Auto Program to add receivable channels that are not present in the TV's memory (see pages 21 and 35). • To receive or select cable channels, make sure that Cable in the Channel settings is set to On (see page 35). To receive or select UHF channels over an antenna, make sure Cable is set to Off.
The TV turns off automatically	<ul style="list-style-type: none"> • Check if Sleep Timer is activated, or confirm the Duration setting of Timer (see page 30). • Check PC Power Management in General Settings (see page 40).
No picture from some video sources	<ul style="list-style-type: none"> • Check the connection between the optional video equipment and the TV. • Press INPUT on the remote control (see page 25). • Press HOME on the remote control. Select your desired input from the External Inputs list.
Poor picture	
The quality of the images is not as good as what I saw at the store	<ul style="list-style-type: none"> • Picture quality depends on the signal content. See Quick Setup Guide (supplied) to display the best possible picture for that signal.
Double images or ghosts	<ul style="list-style-type: none"> • Check antenna/cable connections. • Check the antenna location and direction.
Only snow and noise appear on the screen	<ul style="list-style-type: none"> • Check if the antenna is broken or bent. • Check if the antenna has reached the end of its serviceable life. (3-5 years in normal use, 1-2 years at the seaside.)
Dotted lines or stripes	<ul style="list-style-type: none"> • Keep the TV away from noise sources such as cars, motorcycles, or hair-dryers. • If using 300 ohm twin lead, move the excess lead away from the TV or try using 75 ohm coaxial cable instead.
No color/Dark picture/Color is not correct/The picture is too bright	<ul style="list-style-type: none"> • Press PICTURE to select the desired Picture Mode (see page 23). • Adjust the Picture Mode options in the Picture settings (see page 30). • If you set the Power Saving mode to Low or High, it will enhance the black level (see page 40).
Noisy picture	<ul style="list-style-type: none"> • Make sure that the antenna is connected using a 75-ohm coaxial cable. • Keep the antenna cable away from other connecting cords. • To avoid TV interference, make sure to use an undamaged antenna cable.

(Continued)

Condition	Explanation/Solution
No sound/Noisy sound	
Good picture, no sound	<ul style="list-style-type: none"> • Check the volume control. • Press MUTING or VOL + so that “Muting” disappears from the screen (page 24). • Disconnect your headphones. • Set Speakers to TV Speakers in the Audio Options settings (see page 34). If it is set to Audio System, sound is not output from the TV’s speakers regardless of the TV’s volume control.
Audio noise	<ul style="list-style-type: none"> • Make sure that the antenna is connected using a 75-ohm coaxial cable. • Keep the antenna cable away from other connecting cords. • To avoid TV interference, make sure to use an undamaged antenna cable.
PC Input	
No Picture / No Signal	<ul style="list-style-type: none"> • Confirm the PC is correctly connected to the TV with either the PC IN (with an HD15 cable) or with the HDMI IN. • Ensure the output signal from the PC is one of the formats listed on page 18. • Turn the PC off. Confirm the PC connection and restart the PC. Plug and play will auto-detect the TV and correctly set up PC timing. • Verify PC Power Management is activated (see page 40).
Poor Picture	<ul style="list-style-type: none"> • Adjust the resolution (see page 18). • Adjust Pitch and Phase.
General	
Wide Mode changes automatically	<ul style="list-style-type: none"> • The current Wide Mode setting is automatically replaced with the 4:3 Default setting when you change the channel or video input, if 4:3 Default in the Screen settings is set to other than Off. If you want to lock in Wide Mode selected with WIDE on the remote control, set 4:3 Default to Off in the Screen settings (see page 32). • Check the Auto Wide option in the Screen settings (see page 33).
Suddenly the picture gets smaller	<ul style="list-style-type: none"> • The picture gets smaller during the commercials, this is due to the method the provider broadcasts their contents. When HD content channels switch to SD definition content (commercials), the picture may be small with a black border.
“Black box” on screen	<ul style="list-style-type: none"> • You have selected a text option and no text is available (see page 36). To turn off this feature, set the CC Display option to Off. If you were trying to select closed captioning, select CC1 instead of Text1-4.
Black bands appear at the edges of the screen	<ul style="list-style-type: none"> • Some wide screen programs are filmed in aspect ratios that are greater than 16:9 (this is especially common with theatrical releases). Your TV will show these programs with black bands at the top and bottom of the screen. For more details, check the documentation that came with your DVD (or contact your program provider). • Programs in 4:3 aspect ratio will have bands on left and right sides of the screen.
Certain programs on DVD or other digital sources display a loss of detail, especially during fast-motion or dark scenes	<ul style="list-style-type: none"> • This is due to the digital compression of the source content used by certain digital broadcasts and DVDs which may cause your TV’s screen to display less detail than usual, or cause artifacts (small blocks or dots, pixelations) to appear on your screen. These signal compressions are more visible and are dependent on the clarity and resolution of the television.
Remote control does not operate	<ul style="list-style-type: none"> • Check the polarity of the batteries or replace the batteries. • Point the remote control at the remote control sensor located at the front of the TV. • Fluorescent lamps can interfere with your remote control operation; try turning off the fluorescent lamps. • Keep the remote control sensor area clear from obstacles.
Some digital cable channels are not being displayed	<ul style="list-style-type: none"> • Certain cable companies have limitations on the broadcast of digital cable channels. Check with your cable company for more information. • The digital cable channel may be set to Hidden in the Show/Hide Channels setting (see page 35).

Condition	Explanation/Solution
Lost password	<ul style="list-style-type: none"> • Select the Password settings on the Parental Lock settings, then enter the following master password: 4357. The master password clears your previous password and allows you to enter a new password (see page 36).
How to reset the TV to factory settings	<ul style="list-style-type: none"> • Turn on the TV. While holding down ▲ on the remote control, press POWER on the TV. (The TV will turn itself off, then back on again.) Release ▲. WARNING: The Reset will clear all of your customized settings including the Parental Lock setting.

Specifications

Model	KDL-26S3000	KDL-32S3000	KDL-40S3000	KDL-46S3000
System				
Television system	NTSC: American TV standard ATSC (8VSB terrestrial): ATSC compliant 8VSB QAM on cable: ANSI/SCTE 07 2000 (Does not include CableCARD functionality)			
Channel coverage	Analog terrestrial: 2-69 / Digital terrestrial: 2-69 Analog Cable: 1-125 / Digital Cable: 1-135			
Panel system	LCD (Liquid Crystal Display) Panel			
Speaker output	10 W + 10 W			
Input/Output jacks				
Antenna	75-ohm external terminal for VHF/UHF			
VIDEO IN 1/2/3	S VIDEO (4-pin mini DIN)(VIDEO 1/2 only): Y: 1.0 Vp-p, 75 ohms unbalanced, sync negative / C: 0.286 Vp-p (Burst signal), 75 ohms VIDEO: 1 Vp-p, 75 ohms unbalanced, sync negative AUDIO: 500 mVrms (100% modulation)/ Impedance: 47 kilohms			
COMPONENT IN 1/2	YPBPR (Component Video): Y: 1.0 Vp-p, 75 ohms unbalanced, sync negative / PB: 0.7 Vp-p, 75 ohms / PR: 0.7 Vp-p, 75 ohms / Signal format: 480i, 480p, 720p, 1080i, 1080p AUDIO: 500 mVrms (100% modulation)/ Impedance: 47 kilohms			
HDMI IN 1/2	HDMI: Video: 480i, 480p, 720p, 1080i, 1080p / Audio: Two channel linear PCM 32, 44.1 and 48 kHz, 16, 20 and 24bits AUDIO (HDMI IN 2 only): 500 mVrms (100% modulation)/ Impedance: 47 kilohms			
AUDIO OUT	500 mVrms (100% modulation)/ More than 1 Vrms at the maximum volume setting (Variable)/ More than 500 mVrms (Fixed)			
PC IN	D-sub 15-pin, analog RGB, 0.7 Vp-p, 75 ohms, positive See the PC Input Signal Reference Chart on page 18.			
PC AUDIO INPUT	Stereo mini jack, 500 mVrms, 1 kilohm			
Headphones	Stereo mini jack / Impedance: ≥ 16 ohms			
Power and others				
Power requirement	120 V-240 V AC, 50/60 Hz			
Power consumption				
in use	105 W	158 W	180 W	215 W
in standby	All models less than 0.1 W			
Screen size (inches measured diagonally)	26	31.5 (32 class)	40	46
Display resolution (horizontal × vertical)	1,366 dots × 768 lines			
Speaker/Full range (2)	42 × 150 mm 1 11/16 × 6 inches	42 × 150 mm 1 11/16 × 6 inches	55 × 150 mm 2 1/4 × 6 inches	70 × 130 mm 2 3/4 × 5 7/16 inches
Dimensions				
with stand (mm) (inches)	656 × 500 × 214 26 7/8 × 19 3/4 × 8 1/2	790 × 577 × 214 31 1/8 × 22 3/4 × 8 1/2	981 × 692 × 265 38 5/8 × 27 1/4 × 10 1/2	1114 × 778 × 306 43 7/8 × 30 3/4 × 12 1/8
without stand (mm) (inches)	656 × 452 × 96 25 7/8 × 17 7/8 × 3 7/8	790 × 530 × 100 31 1/8 × 20 7/8 × 4	981 × 643 × 110 38 5/8 × 25 3/8 × 4 3/8	1114 × 730 × 115 43 7/8 × 28 3/4 × 4 5/8
wall-mount hole pattern (mm)	200 × 100	200 × 200	300 × 200	300 × 200
Mass				
with stand	13.5 kg 30 lb.	17.0 kg 38 lb.	25.0 kg 56 lb.	32.0 kg 71 lb.
without stand	11.0 kg 25 lb.	14.5 kg 32 lb.	21.0 kg 47 lb.	27.5 kg 61 lb.
Supplied accessories	Remote control RM-YD018 (1) / Size AA batteries (2) / AC power cord (1) / Support belt (1) / Securing screw (1) / Wood screw (1) / Cable holder (1 attached to the TV) / Operating Instructions (1) / Quick Setup Guide (1) / Warranty Card (1) / Online Registration Card (U.S.A. only) (1)			
Optional accessories	Headphones plug adapter / Connecting cables / Wall-Mount Bracket: SU-WL100 (KDL-26S3000), SU-WL500 (KDL-32S3000/KDL-40S3000/KDL-46S3000) / TV stand: RHT-G800 (for all models excluding KDL-26S3000)			



- Optional accessories availability depends on its stock.
- Design and specifications are subject to change without notice.

Index

0-9 buttons 23
4:3 Default 33

A

AC IN 15
Add Digital Channels 35
Advanced Settings 31
Analog CC 36
Audio Out 34
AUDIO OUT jack, described 15
Auto Adjust 33
Auto Program 21, 35
Auto S Video 39
Auto SAP, MTS setting 34
Auto Wide 33

B

Backlight 31
Balance 32
Bass 32
Bilingual audio 34
Brightness 31

C

Cable 35
Cable holder 20
CC button 25
CC Display 36
CH +/- button 25
Channel Block 37
CineMotion 34
Color 31
Color Temperature 31
COMPONENT IN jack (1080p/1080i/
720p/480p/480i), described 15
Contact Sony 30
Country 36
Current Time 30

D

Device Auto Power Off 39
Device List 39
Digital CC 36
DIGITAL OUT (OPTICAL) jack,
described 15
Digital Rating 37
Display Area 33
DISPLAY button 22
Display Options 36
DMe^x button 23
DMe^x, described 15

E

Edit Channel Labels 35
English Rating 38
ENT button 23

F

FAVORITES button 23
FREEZE button 23

French Rating 38

H

H Center 33
HDMI Control 39
HDMI IN jack, described 15
Headphones jack, described 13
HOME button 23
Hue 31

I

Info Banner 40
Infrared Receiver (IR) 26
INPUT button 25
Installing the TV on a wall 12

J

JUMP button 25

L

Label Inputs 39
Language 40
Light Sensor
Described 26
Setting 40

M

Movie Rating 38
MPEG Noise Reduction 31
MTS 34
MUTING button 24

N

Noise Reduction 31

O

OPTIONS button 25

P

P&P 27
Password 36
PC IN jack, described 15
PC Power Management 40
Phase 33
PIC OFF/TIMER LED 26
Picture 31
PICTURE button 23
Picture Mode 30
PIP 27
Pitch 33
POWER button 24
POWER LED 26
Power Saving 40

R

Rating 37
Reset 31, 32, 33, 43
RETURN button 23

S

S VIDEO jack, described 13, 15
Screen Position 33
Setting up channels 21
Settings
Audio Options 34
Channel 35
Clock/Timers 30
Closed Captions (CC) 36
External Inputs 39
General 40
HDMI Settings 39
Initial Setup 40
Parental Lock 36
Picture 30
Product Support 30
Screen 32
Sound 32
Video Options 34
Sharpness 31
Show/Hide Channels 35
Signal Diagnostics 30
SLEEP button 22
Sleep Timer 30
Sound Booster 32
Sound Mode 32
Speaker 26
Speakers 34
STANDBY LED 26
Steady Sound 32
Surround 32

T

Timer 30
Timer Settings 30
Treble 32
Troubleshooting 41–43
TV Auto Power On 39
TV Rating 38

U

U.S.A. Rating 38
Unrated 37

V

V Center 33
Vertical Size 33
VHF/UHF/CABLE input, described 15
VIDEO IN jack, described 13, 15
VIDEO/AUDIO (L/R) jacks, described
13, 15
VOL +/- button 24
Volume Offset 32

W

WIDE button 24
Wide Mode 32, 34

For Your Convenience

Please contact Sony directly if you:

- Have questions on the use of your television after reading your Operating Instruction manual and Quick Setup Guide
- Experience difficulty operating your television

Contact Sony Customer Support at:

<http://www.sony.com/tvsupport>

or to speak with a support representative:

United States

1-800-222-SONY (7669)

Canada

1-877-899-SONY (7669)

Sony will work to resolve your questions more quickly than your retailer or place of purchase.

Please Do Not Return the Product to the Store

