

The top half of the page features a complex, abstract background of overlapping, semi-transparent blue triangles and polygons, creating a dynamic, crystalline effect. The colors range from light sky blue to deep navy blue.

User Guide

020-001715-01

SUHD983-P LCD Panel

CHRISTIE®

NOTICES

COPYRIGHT AND TRADEMARKS

Copyright © 2019 Christie Digital Systems USA, Inc. All rights reserved.

All brand names and product names are trademarks, registered trademarks or trade names of their respective holders.

GENERAL

Every effort has been made to ensure accuracy, however in some cases changes in the products or availability could occur which may not be reflected in this document. Christie reserves the right to make changes to specifications at any time without notice. Performance specifications are typical, but may vary depending on conditions beyond Christie's control such as maintenance of the product in proper working conditions. Performance specifications are based on information available at the time of printing. Christie makes no warranty of any kind with regard to this material, including, but not limited to, implied warranties of fitness for a particular purpose. Christie will not be liable for errors contained herein or for incidental or consequential damages in connection with the performance or use of this material. Manufacturing facilities in Canada and China are ISO 9001 certified. Manufacturing facilities in Canada are also ISO 14001 certified.

WARRANTY

Products are warranted under Christie's standard limited warranty, the complete details of which are available by contacting your Christie dealer or Christie. In addition to the other limitations that may be specified in Christie's standard limited warranty and, to the extent relevant or applicable to your product, the warranty does not cover:

- a) Problems or damage occurring during shipment, in either direction.
- b) Problems or damage caused by combination of a product with non-Christie equipment, such as distribution systems, cameras, DVD players, etc., or use of a product with any non-Christie interface device.
- c) Problems or damage caused by misuse, improper power source, accident, fire, flood, lightning, earthquake, or other natural disaster.
- d) Problems or damage caused by improper installation/alignment, or by equipment modification, if by other than Christie service personnel or a Christie authorized repair service provider.
- e) Use of third party product enclosures for environmental protection during outside use must be approved by Christie.
- f) Problems or damage caused by use of a product on a motion platform or other movable device where such product has not been designed, modified or approved by Christie for such use.
- g) Except where the product is designed for outdoor use, problems or damage caused by use of the product outdoors unless such product is protected from precipitation or other adverse weather or environmental conditions and the ambient temperature is within the recommended ambient temperature set forth in the specifications for such product.
- h) Image retention on LCD flat panels.
- i) Defects caused by normal wear and tear or otherwise due to normal aging of a product.

The warranty does not apply to any product where the serial number has been removed or obliterated. The warranty also does not apply to any product sold by a reseller to an end user outside of the country where the reseller is located unless (i) Christie has an office in the country where the end user is located or (ii) the required international warranty fee has been paid.

The warranty does not obligate Christie to provide any on site warranty service at the product site location.

PREVENTATIVE MAINTENANCE

Preventative maintenance is an important part of the continued and proper operation of your product. Failure to perform maintenance as required, and in accordance with the maintenance schedule specified by Christie, will void the warranty.

REGULATORY (if applicable)

The product has been tested and found to comply with the limits for a Class A digital device, pursuant to Part 15 of the FCC Rules. These limits are designed to provide reasonable protection against harmful interference when the product is operated in a commercial environment. The product generates, uses, and can radiate radio frequency energy and, if not installed and used in accordance with the instruction manual, may cause harmful interference to radio communications. Operation of the product in a residential area is likely to cause harmful interference in which case the user will be required to correct the interference at the user's own expense.

CAN ICES-3 (A) / NMB-3 (A)

이 기기는 업무용(A급)으로 전자파적합등록을 한 기기이오니 판매자 또는 사용자는 이점을 주의하시기 바라며, 가정 외의 지역에서 사용하는 것을 목적으로 합니다.

ENVIRONMENTAL

The product is designed and manufactured with high-quality materials and components that can be recycled and reused. This symbol  means that electrical and electronic equipment, at their end-of-life, should be disposed of separately from regular waste. Please dispose of the product appropriately and according to local regulations. In the European Union, there are separate collection systems for used electrical and electronic products. Please help us to conserve the environment we live in!

Content

Package handling	5
Unpacking the panel	5
Handling and mounting guidelines for extreme narrow bezel series panels	6
Cleaning the panel	6
Product documentation	6
Related documentation	7
Important safeguards	7
General safety precautions	7
Introduction.....	9
Description, Features and Benefits	9
Controls and Functions	10
Display at a Glance	10
In/Output Panel	12
Remote Control Unit	13
Installation.....	14
Remote Control.....	14
Notes on Batteries	14
Notes on Remote Control Operation	14
Quick Setup.....	15
Installation Considerations	15
Mounting the Display	16
Connections to the Display	16
Connecting a Control System or PC	17
IR Receiver Kit Connection	18
Connecting Source Components to the Display	19
Turning ON the Power.....	20
Avoiding Image Retention	21
Avoid Static Content.....	21
Changing the OSD Language	21

- Operation..... 22**
 - Using the On-Screen Menus..... 22
 - Picture Settings 24
 - Sound Settings 27
 - OSD Settings..... 28
 - Setup Settings..... 29
 - Multi-Window..... 30
 - Multi-Window Edit 32
 - About 34
 - OPS (Open Plugable Standard) 34
 - Supported Timings 36

- Network Guide 38**
 - Connection Setting 38
 - PC Setting 39
 - Ping Test..... 39
 - Connect Web server 40

- Maintenance and Troubleshooting 42**
 - Maintenance 42
 - Troubleshooting 42

Package handling

Learn how to remove the display panel from the packaging and how to handle the display panel.

Unpacking the panel

Learn how to remove the panel from the packaging.

Each LCD panel is packed inside a box carton. To protect the panel during transportation, additional packing material has been placed within the carton.

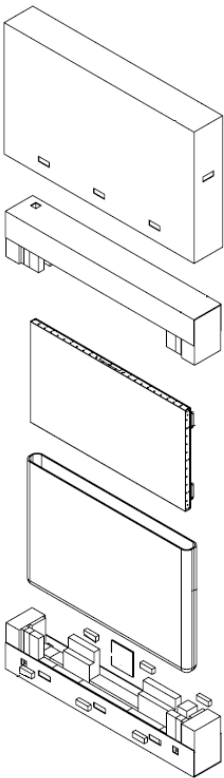

1. Before unpacking, prepare a stable, level, and clean surface near a wall outlet.
2. Set the box in an upright position and pull out the white carton locks.
3. Lift up the top cover carton.
4. Remove the polybag before removing the display from the bottom tray carton.
5. Remove any additional packaging, such as protective stickers, from the display panel.

Handling and mounting guidelines for extreme narrow bezel series panels

Follow these best practices when handling and mounting extreme narrow bezel panels.



Notice. If not avoided, the following could result in property damage.

- When moving the panel, always use the handles. Do not carry the panel by the frame.
- Do not twist, bend, or tilt the panel.
- Do not apply excessive force to the sides of the bezel when mounting the panel or pushing into its locked position.
- Always handle the display panel from the sides or handles.

Follow the following guidelines before removing the panel from the packaging.

- To verify normal operation before handling, power on the panel in the packaging.
- Always use the handles to pick up and carry the panel.
- Leave the panel in the box until the mount is on the wall and you are ready to install the panel.
- To avoid putting undue stress on the panel when mounted, make sure the mount is square, flat, and level.
- Do not rest panels on top of a lower panel.
- When inserting the panel into the wall, pay close attention to adjacent panels.
- Make sure there is a minimum of 0.5 mm between mounted panels to allow for thermal expansion.

Cleaning the panel

Learn how to clean the display panel.

After disconnecting the power cable, wipe contaminated parts and each part of the product screen lightly with a dry and soft cloth.

Do not use a liquid, spray cleaners, or any abrasive cleaners to clean the LCD panel.

Washing with various cleaning agents, brighteners, abrasives, waxes, benzene, alcohol, solvent, surface active agent, may damage the surface of the product.

Product documentation

For installation, setup, and user information, see the product documentation available on the Christie website. Read all instructions before using or servicing this product.

1. Access the documentation from the Christie website:
 - Go to this URL: <http://bit.ly/2CqwJJO> .

- Scan the QR code using a QR code reader app on a smartphone or tablet.



2. On the product page, select the model and switch to the **Downloads** tab.

Related documentation

Additional information on the LCD panels is available in the following documents.

- *SUHD983-P LCD Panels Product Safety Guide (P/N: 020-001714-XX)*
- *SUHD983-P LCD Display Panels External Commands (P/N: 020-001766-XX)*
- *SUHD983-P LCD Panels Service Guide (P/N: 020-001723-XX)*

Important safeguards

To prevent personal injury and to protect the device from damage, read and follow these safety precautions.

General safety precautions

Observe these important safety rules to avoid personal injury or damage to the product.



Warning! If not avoided, the following could result in death or serious injury.

- Christie products must be installed and serviced by Christie qualified technicians.
- A minimum of four people or adequately rated lifting equipment are required to safely lift, install, or move the product.
- **SHOCK HAZARD!** Only use the AC power cord provided with the product or recommended by Christie.
- **SHOCK HAZARD!** Disconnect the product from AC before servicing, cleaning, removing components, or opening any enclosure.
- **FIRE HAZARD!** Do not use a power cord that appears damaged.
- **SHOCK HAZARD!** Do not attempt operation if the AC supply is not within the specified voltage and power range, as specified on the license label.
- **SHOCK HAZARD!** The AC power cord must be inserted into an outlet with grounding.
- Always connect the ground first to reduce shock hazard.
- **TRIP OR FIRE HAZARD!** Position all cables where they cannot contact hot surfaces, be pulled, be tripped over, or damaged by persons walking on or objects rolling over the cables.
- Do not drop the panel (even a short distance), or apply pressure to the sides of the bezel. The small size of the bezel, means there is reduced protection of the LCD glass and components. Dropping the panel or applying unnecessary force to the sides of the bezel will result in permanent damage.
- To avoid serious injury and/ or serious damage to the LCD panel, moving the panel requires at least four people.
- Extreme care must be taken when pushing the mounted display into its locked position. Always handle the display on the opposing corners of the frame to avoid direct contact with the LCD glass.



Caution! If not avoided, the following could result in minor or moderate injury.

- Do not tilt the product more than ± 15 degrees.
- Use the handles when moving the shipping package.
- Do not twist, bend, or tilt the panel.



Notice. If not avoided, the following could result in property damage.

- Install the product at least 10 cm from the wall.
- Do not install in locations where has vibration or in an unstable position as the product may fall and cause damage.
- Do not install in places where dirt, moisture, smoke, much water or rain water can reach the product.
- Avoid exposure to direct sunlight and do not place near hot objects such as a fire or heater heat. This may cause a fire or shortening the product life.
- Do not place heavy objects on the product.
- Always provide proper ventilation for the product to prevent overheating.
- Do not place the screen on a hard surface

Introduction

This User Guide describes how to install, set up and operate the SUHD983-P LCD Panels. Throughout this manual, the SUHD983-P LCD Panels are referred to collectively as the “display.”

Christie has prepared this manual to help end users get the most out of the display.

Christie has made every effort to ensure that this manual is accurate as of the date it was printed. However, because of ongoing product improvements and customer feedback, it may require updating without notice from time to time.

Description, Features and Benefits

The SUHD983-P LCD Panels a 98” high performance UHD display featuring 500 nits brightness, advance input connectivity and multi-source viewing

Key Features and Benefits

The display offers these key features and benefits:

- Ultra-HD Native Resolution: 3840 x 2160 (16:9 Native Aspect Ratio)
- High Brightness: Up to around 500 nits
- Ultra-wide 178-degree Viewing Angle
- Modern connectivity with Display Port 1.4, HDMI2.0 Inputs with High-bandwidth Digital Content Protection(HDCP)
- Supported OPS(Open Pluggable Specification) slot : HDMI2.0, Display Port 1.2, RS232

Parts List

Your display is shipped with the following items. If any items are missing or damaged, please contact your dealer or Customer Service.

- SUHD983-P LCD Panel
- IR Remote Controller Unit and battery (AAA Size x 2ea)
- RS232 Cable (Length 1800mm)
- HDMI Cable (Length 3000mm)
- External IR Receiver Kit
- Screw (M3x6) 2ea

Controls and Functions

The appearance of actual components may differ from the image shown.

Display at a Glance

The illustration below shows the key display components, and the paragraphs that follow describe them.

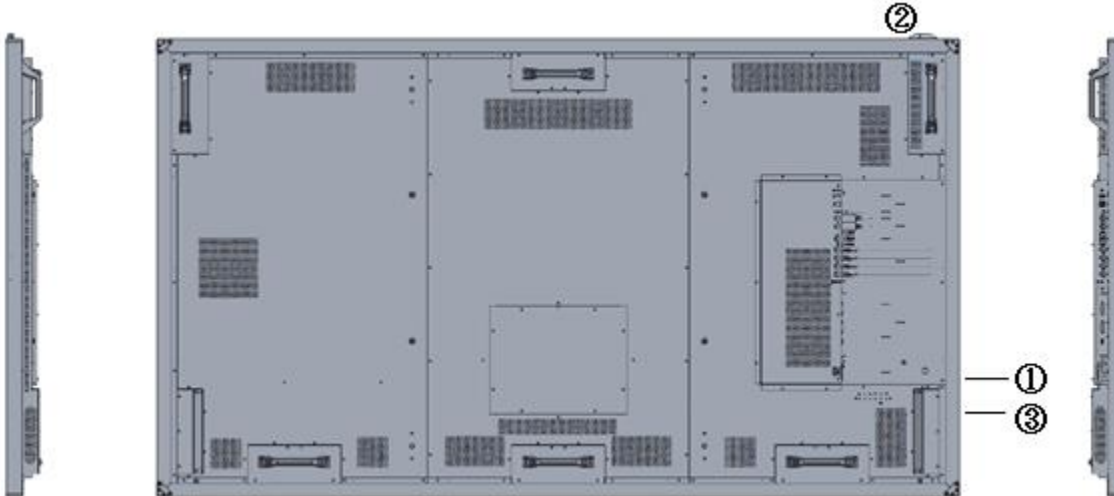

① MAIN POWER INPUT & SWITCH

Connects or disconnects the display panel from the AC power source.
100 to 240 VAC, 50/60Hz

② IR RECEIVER / POWER STATUS LED

Power Status LED

On	No color
Standby	Red
Power Save	Red blinking

③ KEYPAD



You can use the keypad instead of the remote control unit to operate the on-screen display (OSD) controls. The keypad operates as follows:

On/Standby ()

Press once to toggle from standby mode to on mode.

Press it again to return to standby mode.

▲ (SOURCE)

To select a source, press the **▲ (SOURCE)** button repeatedly (with no menus visible on-screen).

When a menu is visible on-screen, this button operates identically to the up-arrow..



When a menu is visible on-screen, this button operates identically to the down-arrow button on the display remote control unit.



Press this button to increase the volume.

When a menu is visible on-screen, this button operates identically to the right-arrow (or **SEL**) button on the display remote control unit.



Press this button to decrease the volume.

When a menu is visible on-screen, this button operates identically to the left-arrow button on the display remote control unit.

M (MENU)

Press this button to display the on-screen display (OSD), or to exit the on-screen display (OSD) and return to the previous one.

In/Output Panel

The illustration below shows the display input panel.

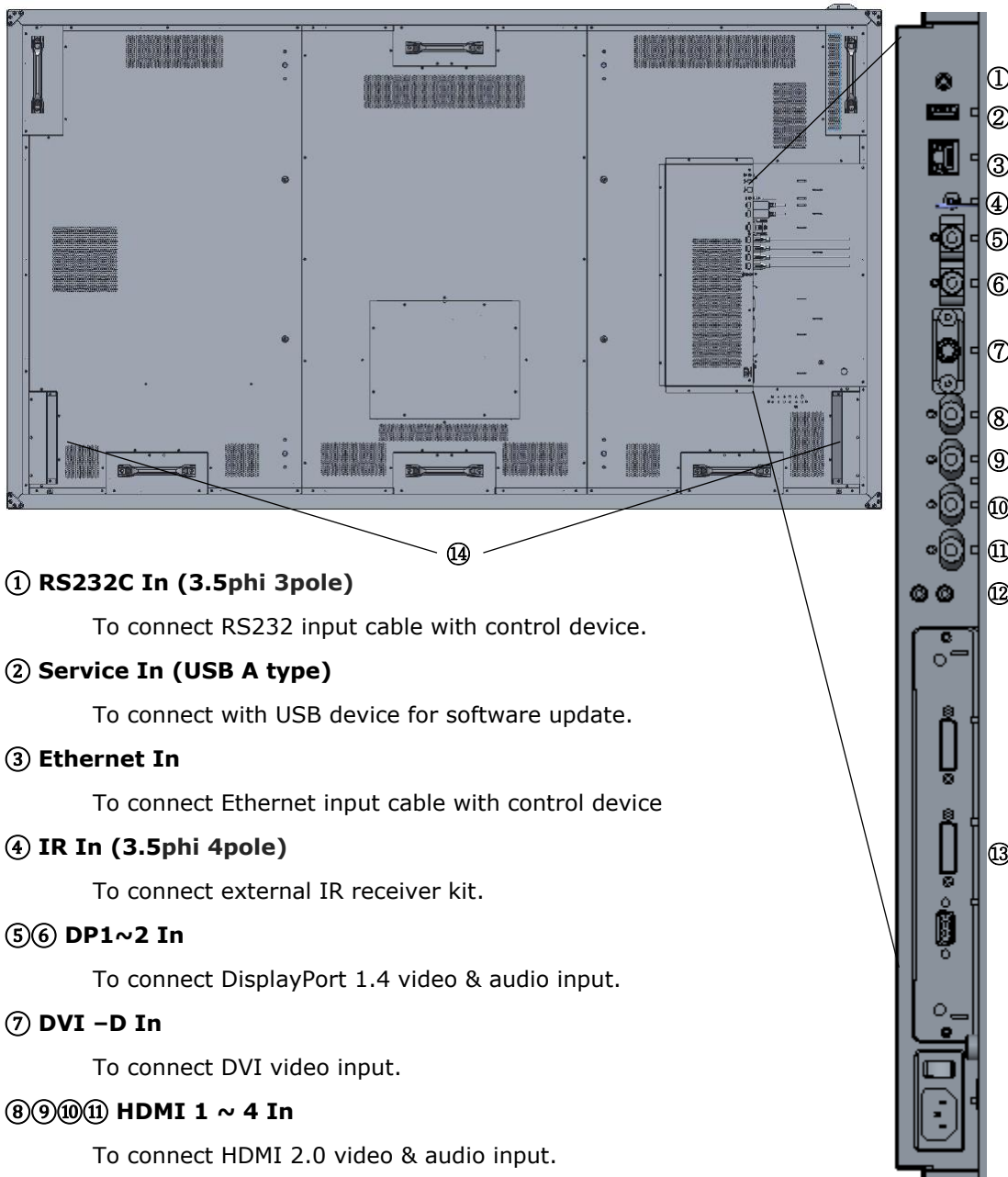

- ① **RS232C In (3.5phi 3pole)**
To connect RS232 input cable with control device.
- ② **Service In (USB A type)**
To connect with USB device for software update.
- ③ **Ethernet In**
To connect Ethernet input cable with control device
- ④ **IR In (3.5phi 4pole)**
To connect external IR receiver kit.
- ⑤⑥ **DP1~2 In**
To connect DisplayPort 1.4 video & audio input.
- ⑦ **DVI -D In**
To connect DVI video input.
- ⑧⑨⑩⑪ **HDMI 1 ~ 4 In**
To connect HDMI 2.0 video & audio input.
- ⑫ **Audio In/Out (3.5phi 3pole)**
To connect audio stereo Input/output.
- ⑬ **OPS Slot (optional)**
To connect OPS (Open Pluggable Specification) PC
- ⑭ **Internal Speaker (15W x 2ea)**

Remote Control Unit

The illustration below shows the display remote control, and the table that follows describes its functionality.



Label	Description
	Turns on or off the product
SOURCE	Select a connected source device
▲	Move to the up menu
▼	Move to the down menu
SEL	Confirm a menu selection
◀ or -	Decreases the sound volume or Move to the left menu
▶ or +	Increases the sound volume or Move to the right menu
MENU	Opens the product on-screen menu system. When the menu system is already open, pressing this button will select the previous submenu
INFO	Provides source and resolution information
MUTE	Turns off the sound
1	Direct Key Preset 1
2	Direct Key Preset 2
3	Direct Key Preset 3
4	Direct Key Preset 4
5	Direct Key Preset 5
6	Direct Key Preset 6
7	Direct Key Preset 7
8	Direct Key Preset 8
9	Direct Key Preset 9
0	Direct Key Preset 10

Installation

Installation must be performed by a qualified installation specialist.

Remote Control

The appearance of actual components may differ from the image shown.

To install batteries in the remote control:

1. Press the tab on the battery case and open it.
2. Insert the battery (1.5V AAA) into the battery case.
3. Insert the battery case until clack sounds.

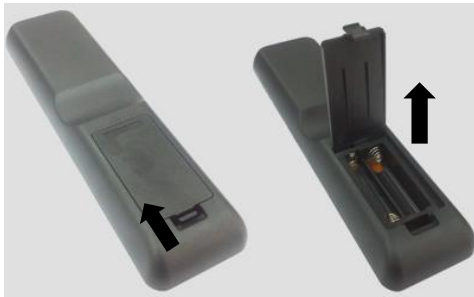

Notes on Batteries

- Make sure that the battery polarities are correct when installing the batteries.
- If you will not use the remote control for a long time, remove the batteries to avoid damage from battery leakage.
- Do not expose batteries to excessive heat such as from sunshine, fire or the like.

Notes on Remote Control Operation

- Make sure that there is nothing obstructing the infrared beam between the remote control and the IR receiver on the display.
- If the effective range of the remote control decreases, or it stops working, replace the batteries with new ones.
- The remote control may fail to operate if the infrared remote sensor is exposed to bright sunlight or fluorescent lighting.

Quick Setup

Here is a quick overview of the display installation process. The following sections provide detailed instructions.

Step	Procedure	More details
1	Mount the display(s) on a wall (optional)	<i>Mounting the Display on page 16</i>
2	Connect other external equipment to the display : Automation/control system (RS232)	<i>Connecting a Control System or PC on page 17</i>
3	Connect signal sources to the display	<i>Connecting Source Components to the Display on page 19</i>
4	Apply power to the display	<i>Turning ON the Power on page 20</i>
5	Change the OSD language	<i>Changing the OSD Language on page 21</i>
6	Display calibration: adjust the following for each input: <ul style="list-style-type: none"> • Brightness • Contrast • Black level • Color • Sharpness • Color temperature 	<i>Picture Settings on page 24</i>

Installation Considerations

Proper installation of your display will ensure a satisfying viewing experience. Whether you are installing a display temporarily or permanently, you should take the following into account to ensure your display performs optimally.

Ambient Light

In general, minimize or eliminate light sources directed at the screen. Images may then appear washed out and less vibrant if light, such as sunlight through a window or floodlight, directly strikes the screen.

Ambient Heat

Your display will perform best and achieve longer life if it is operated in normal office environment conditions. The ambient temperature should be kept below 40°C (95°F). Keep the display away from heating and/or air conditioning vents.

Ventilation Considerations

The appearance of actual components may differ from the image shown.

If you are mounting the display in an enclosure, leave sufficient space on all sides between it and surrounding objects, as shown below. This allows heat to disperse, maintaining the proper operating temperature.

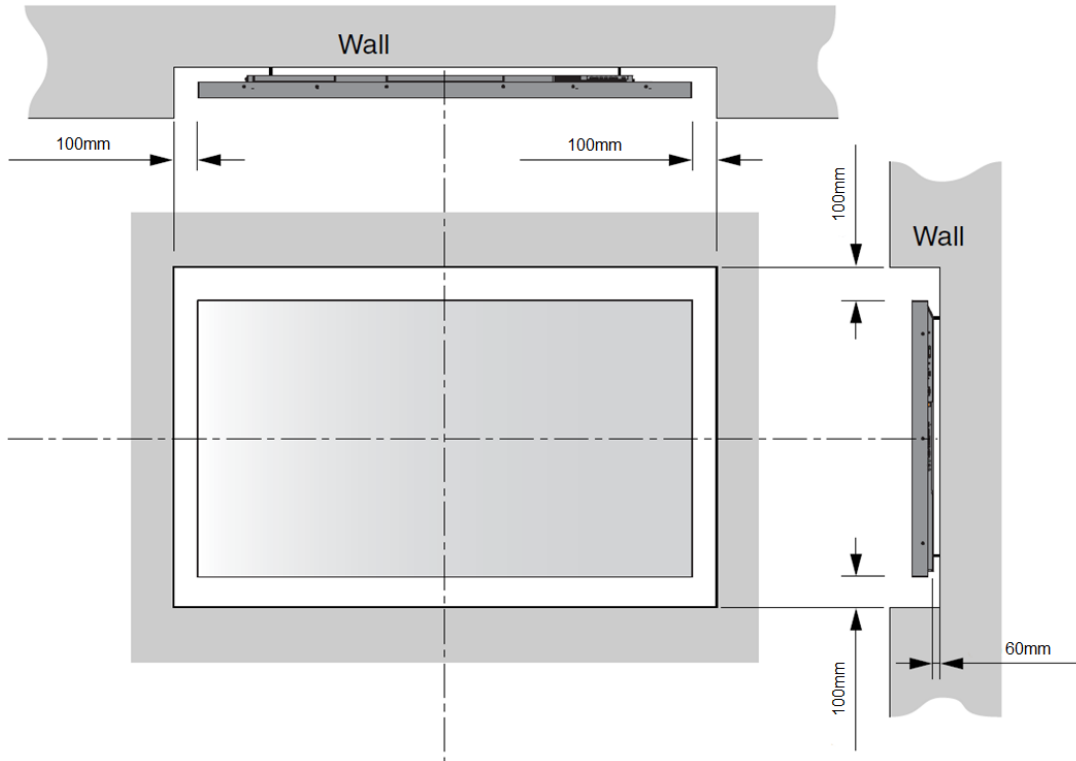

Mounting the Display

If you do decide to wall-mount the display, ensure that the wall-mount bracket is installed according to the instructions included with it. The wall must be capable of supporting a multiple weight factor of three (3) times the weight of the display, or be reinforced. We recommend that this be done by a custom installation specialist.



- Use only the approved wall-mount kit designed for your display
- When mounting the SUHD983-P in portrait mode, connect signal cables before mounting the panel.

Connections to the Display

The appearance of actual components may differ from the image shown.

Proceed as follows to connect the display to your video sources, external controller(s) – if present – and AC power.

When connecting your equipment:

- Turn off all equipment before making any connections.
- Use the correct signal cables for each source.
- For best performance and to minimize cable clutter, use high-quality cables that are only as long as necessary to connect two devices. (Don't use a 20-foot cable when a 6-foot cable will suffice.)

- Ensure that the cables are securely connected. Tighten the thumbscrews on connectors that have them.

Connecting a Control System or PC

RS232 Connection

Use a straight-through RS232 cable with a 3.5Ø stereo connector to connect a PC or control/automation system (if present) to the RS232 port on the display. For more information about using this connection, refer to API control manual document.

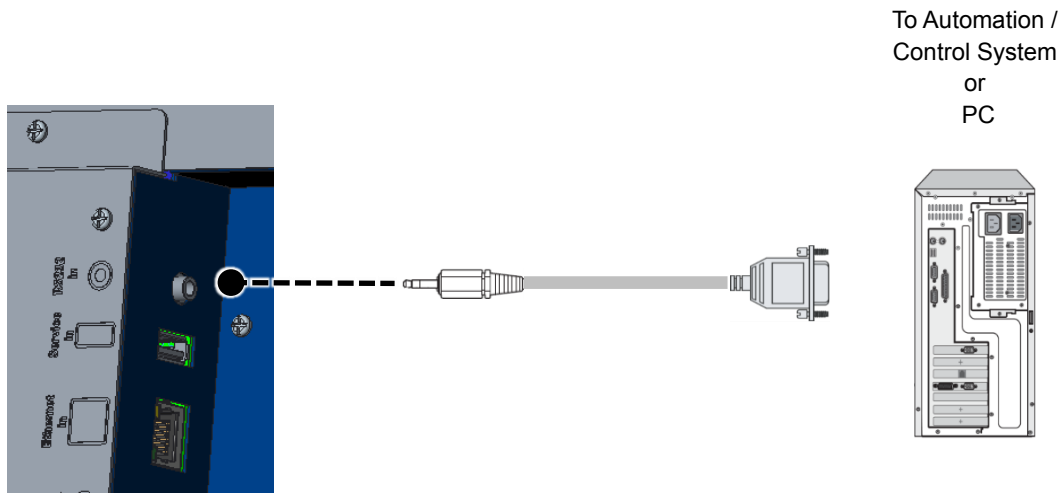

P1		P2				
Stereo 3.5mm	Tx	1	←	2	Rx	DSUB9P (Female)
	Rx	2	→	3	Tx	
	Gnd	3	—	5	Gnd	

IR Receiver Kit Connection

Connect the provided External **IR Receiver Kit** to the **IR input** as shown below.

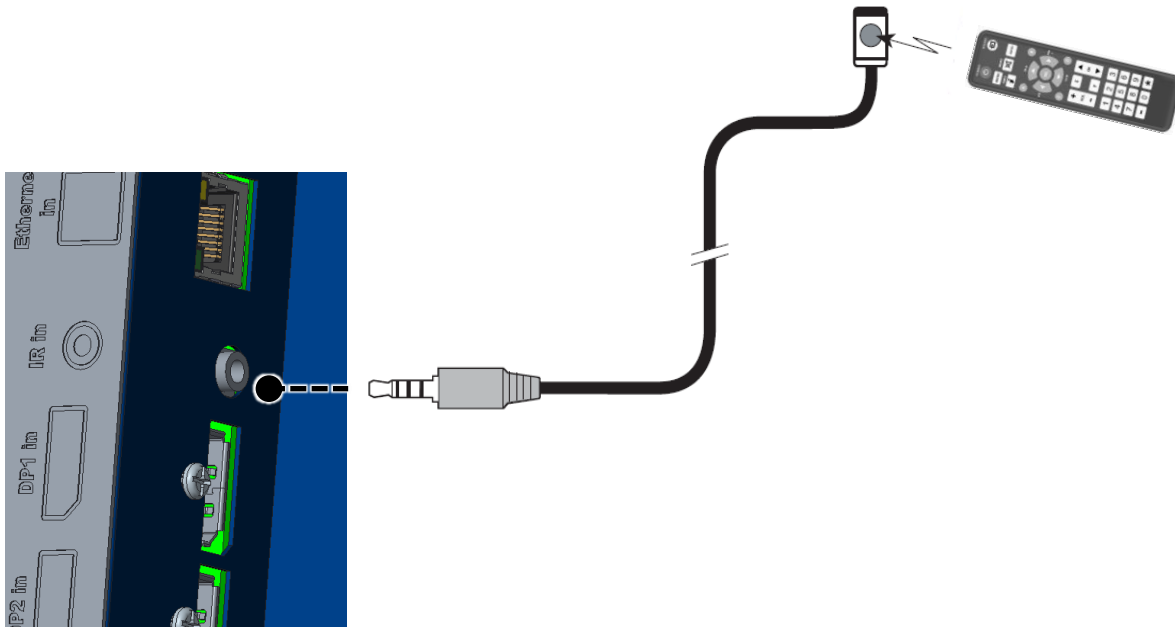

The included external remote sensor should be fixed to external remote sensor on the product by removing two screws on the top/bottom of the left/middle/right of the front, and re-using the screw.

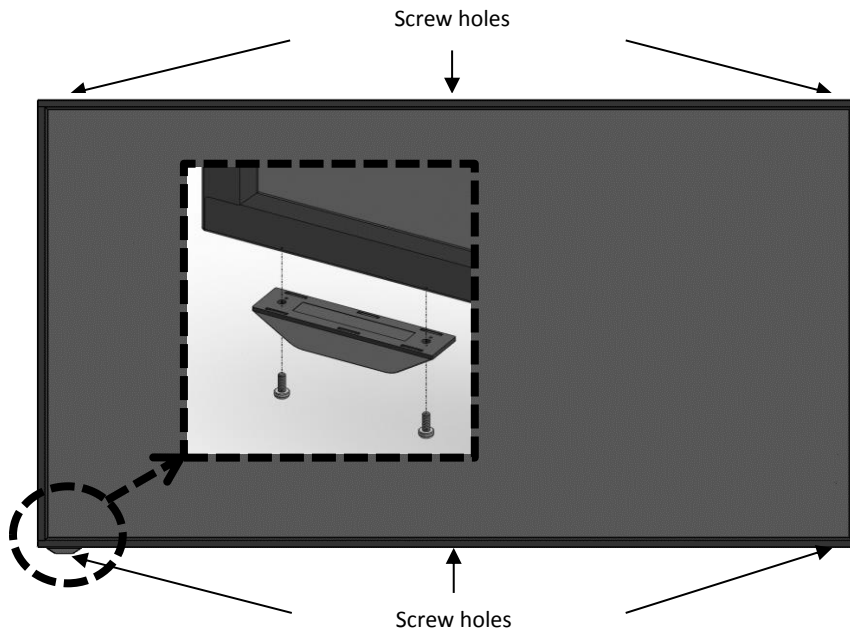

Connecting Source Components to the Display

Connect your video sources to the display as shown and described in the sections that follow.

DP(DisplayPort) Source Connection

Refer to *Supported Timings* on page 36 for a list of compatible input signals. This display supports the VESA Display Data Channel (DDC) standard. This standard provides “Plug and Play” capability; the display and a VESA DDC-compatible computer communicate their setting requirements, allowing for quick and easy setup.

For Plug and Play to work correctly, you must turn on the display before you turn on the connected computer

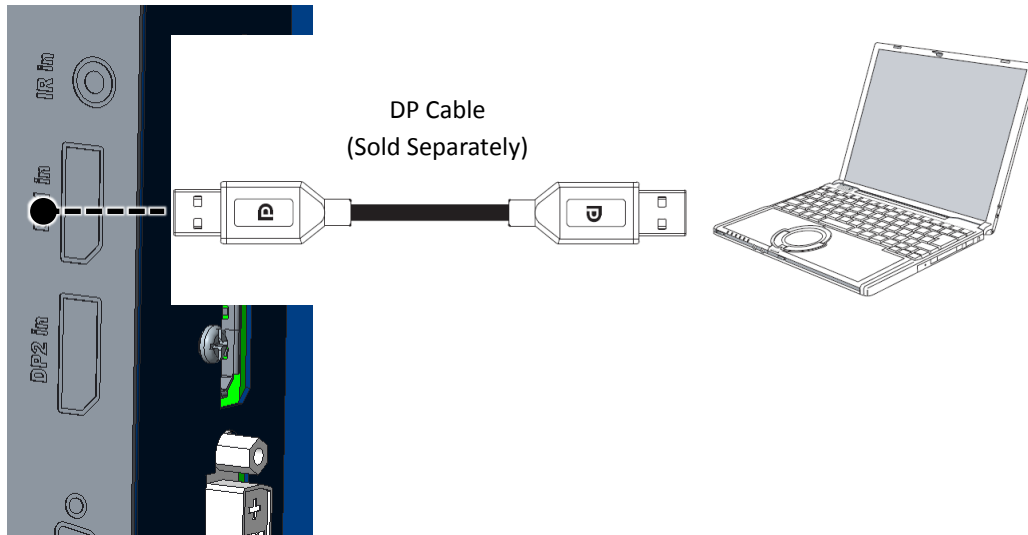

Ensure the use of a certified Display Port cable. Otherwise, the picture may not display or a connection error may occur.

HDMI Source Connections

Use the HDMI inputs whenever possible. This ensures the highest video quality because the signal is carried in the digital domain throughout the entire signal path, from source component output into the display.

Refer to *Supported Timings* on page 36 for a list of compatible input signals. This display supports the VESA Display Data Channel (DDC) standard. This standard provides “Plug and Play” capability; the display and a VESA DDC-compatible computer communicate their setting requirements, allowing for quick and easy setup.

For Plug and Play to work correctly, you must turn on the display before you turn on the connected computer.

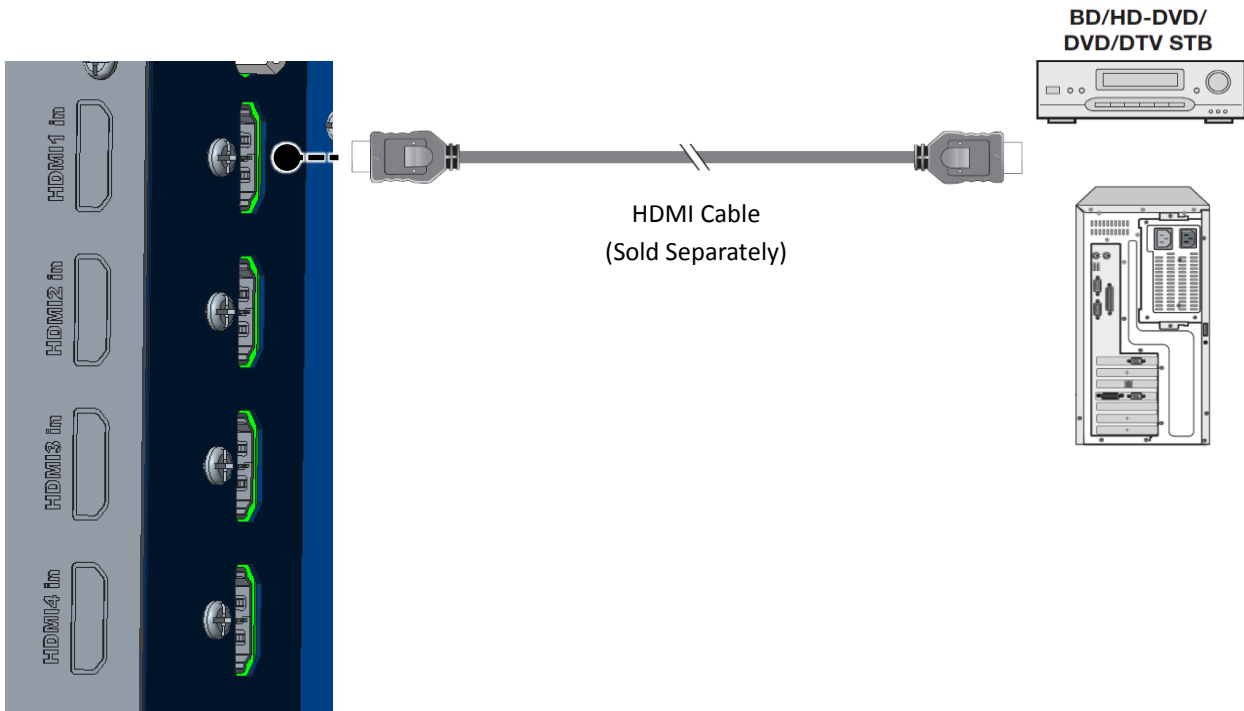

Ensure the use of a certified HDMI cable. Otherwise, the picture may not display or a connection error may occur.

DVI Source Connection

Connect a personal computer or other DVI source to the DVI input as shown below. Refer to *Supported Timings* on page 36 for a list of compatible input signals.

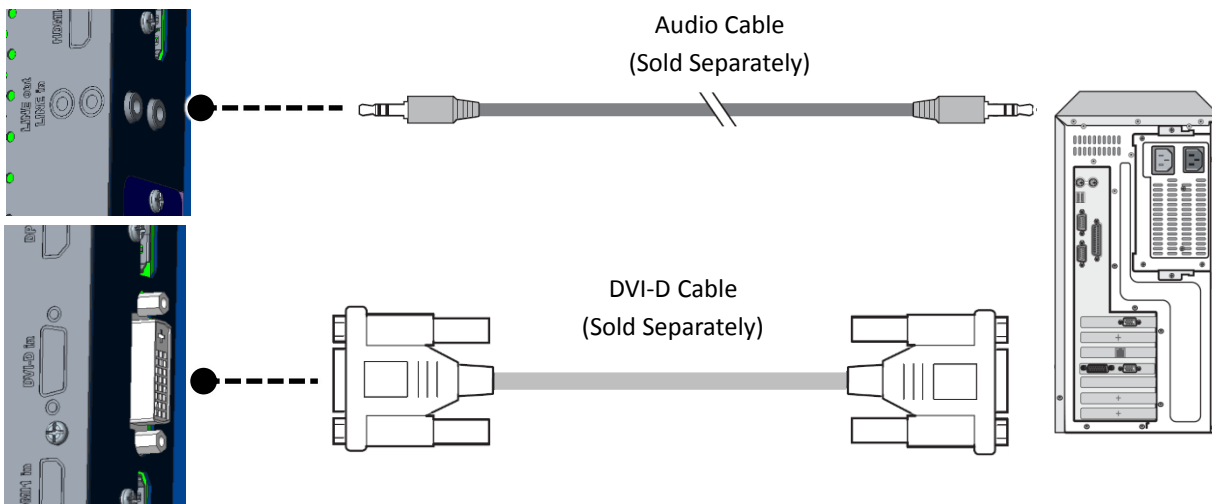

Turning ON the Power

1. Connect the power cable of the display into an outlet with AC 100-240V 50/60Hz.
2. Turn on the main AC power switch.

3. If the power indicator is green, the screen turns on automatically.
4. If the power indicator is red not green, press the power key on the remote control or on the keypad to turn on the power.

Avoiding Image Retention

Follow the recommendations below to prolong the life of the display.

- Operate the Display Within Its Rated Ambient Environment
- Operating temperature: 5°C to 35°C (41°F to 95°F)
- Relative humidity: 80%, maximum.



Notice. If not avoided, the following could result in property damage.

- Do not display static (non-moving) content on the display for long periods of time. This may cause image image retention, which is not covered under warranty.

Avoid Static Content

- Display dynamic (moving) images whenever possible consider using a screen saver to avoid displaying static (fixed) video content continuously.
- Turn off the display when not in use.

Changing the OSD Language

Select the language used for the menus and on screen display.

1. Press the **Menu** button to go to the menu.
2. Select the **OSD** from the main menu.
3. Select **Language**.
4. Select the preferred language, and then exit the menu.

Operation

Using the On-Screen Menus

1. To display the on-screen menus, press **MENU** on the remote control or built-in keypad.
2. To select a sub-menu, use the **▲** and **▼** buttons to highlight it. Then, press **SEL** to enter that sub-menu.
3. To select a menu item, use the **▲** and **▼** and buttons to highlight it. Then, press **▲** or **▼** to adjust that setting, and then the menu by pressing the menu button to exit.

The OSD menus are arranged hierarchically, as shown below. Depending on the selected input source and signal characteristics, some menu options may not be available.

Picture	Input	Window1	Window1/Window2/ Window3/Window4	For Multi-window
	Picture Mode	Standard	Standard/Dynamic/User	Default : Standard Select User to adjust Brightness, Contrast and other settings
	Brightness	70	0-100	Default : 70
	Contrast	100	0-100	Default : 100
	Black Level	50	0-100	Default : 50
	Color	50	0-100	Default : 50
	Sharpness	50	0-100	Default : 50
	Color Temperature	Normal	Normal/Warm/Cool/Studio1/Studio2/User	Default : Normal
	Red	86	0-100	Default : 86
	Green	86	0-100	Default : 86
	Blue	86	0-100	Default : 86
Sound	Audio Select		DP1/DP2 /HDMI1/HDMI2/ HDMI3/HDMI4/DVI/OPS-HDMI/OPS-DP	Different depends on current input
	Volume	50	0-100	Default : 50
	Balance	0	-50 - +50	Default : 0
OSD	Language	English	English / Spanish /French / Russian / German /Italian / Korean	Default : English
	OSD Turn Off	Off	Off/5/10/20sec	Default : 20sec
	OSD Positon	C	TL/TR/C/BL/BR	Default : C
	OSD Rotation	Off	Off/On	Default : Off

Setup	Power Save	On	Off/On	Default : On
	Power off Mode	Standby	Standby, Sleep, Deep Sleep	Default : Standby
	Movie Mode	Off	Off / Low / Middle / High	Default : Off
	Interface Select	Off	Off/RS232/OPS-RS232t	Default : RS232
	FRC Mode	Free run	Lock/Free run	Default : Free run
	CEC Control	Off	Off/On	Default : Off
	Factory Reset			Reset the all MENU
Multi-Window	Off	Off	-	Default : Off
	Preset1		One /HDMI1	
	Preset2		Dual1 /HDMI1/HDMI2	
	Preset3		Dual2 /HDMI1/HDMI2	
	Preset4		Dual3 /HDMI1/HDMI2	
	Preset5		Dual4 /HDMI1/HDMI2	
	Preset6		Triple1/HDMI1/HDMI2/HDMI3	
	Preset7		Triple2/HDMI1/HDMI2/HDMI3	
	Preset8		Triple3/HDMI1/HDMI2/HDMI3	
	Preset9		Triple4/HDMI1/HDMI2/HDMI3	
	Preset10		Quad/HDMI1/HDMI2/ HDMI3/HDMI4	
	Preset11		One /DP1	
	Preset12		Dual1 /DP1/DP2	
	Preset13		Dual2 /DP1/DP2	
	Preset14		Dual3 /DP1/DP2	
	Preset15		Dual4 /DP1/DP2	
	Preset16		Triple1/DP1/DP2/HDMI1	
	Preset17		Triple2/DP1/DP2/HDMI1	
	Preset18		Triple3/DP1/DP2/HDMI1	
	Preset19		Triple4/DP1/DP2/HDMI1	
	Preset20		Quad/DP1/DP2/ HDMI1/HDMI2	
Multi-Window Edit	Multi-Window Mode		Off/One/Dual1/Dual2/Dual3/Dual4/ Triple1/Triple2/Triple3/Triple4/ Quad	Default : Off
	Window1		DP1/DP2/HDMI1/HDMI2/HDMI3/ HDMI4/DVI/OPS-HDMI/OPS-DP	
	Window2			
	Window3			
	Window4			
LAN Setting	DHCP	Off	Off/On	Default : Off
	IP Address		192.168.10.10	Default : 192.168.10.10

	Subnet Mask		255.255.255.0	Default : 255.255.255.0
	Gate Way		192.168.10.1	Default : 192.168.10.1
LAN Setting	DNS		168.126.63.1	Default : 168.126.63.1
	LAN Setting Reset			Reset the all Lan Setting
ABOUT	Model		The read-only System menu provides the following status information about the display	
	Version			
	MAC			
	S/N			
	Window1			
	Resolution			
	Window2			
	Resolution			
	Window3			
	Resolution			
	Window4			
	Resolution			

Specifications are subject to change without notice to improve quality.

Picture Settings

Picture	Input	Window 1
Sound	Picture Mode	Standard
OSD	Brightness	70
Setup	Contrast	100
Multi-Window	Black Level	50
LAN Setting	Color	50
About	Sharpness	50
	Color Temperature	Normal
	Red	86
	Green	86
	Blue	86

Input

The image quality set depends on the input modes when Multi-Window is On.

The Input function will be disabled when Multi-Window is OFF.

Picture Mode

Select **Picture Mode** from the Picture Settings menu, then press ▲ or ▼ to select one of two image quality presets (Standard or Dynamic) depending on the type of program material you are viewing. These presets automatically adjust the other image settings for optimal image quality. Or, select User to adjust Brightness, Contrast and other settings manually.

Brightness

The Brightness control changes the apparent brightness of the displayed image.

Contrast

On your external test pattern source, select a stepped, gray-bar pattern like the one shown below.



Select **Contrast** and press ▲ or ▼ to adjust the contrast to a point just below which the white rectangle starts to increase in size.

Black Level

On your external test pattern source, select a PLUGE pattern. (PLUGE is an acronym for “Picture Line- Up Generation Equipment.”)

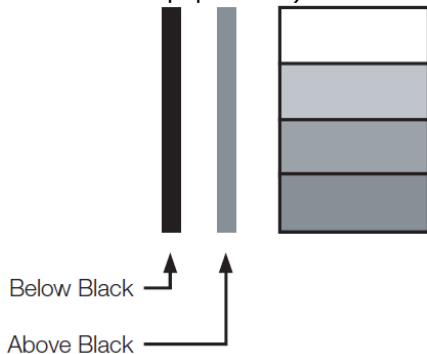

PLUGE patterns vary but generally consist of some combination of black, white and gray areas against a black background. The example above includes two vertical bars and four shaded boxes.

Select **Black Level** from the Picture Settings menu and press ▲ or ▼ to adjust the black level so that:

- • The darkest black bars disappear into the background.
- • The dark gray areas are barely visible.
- • The lighter gray areas are clearly visible.
- • The white areas are a comfortable level of true white.
- • The image contains only black, gray and white (no color).

Contrast and Black Level controls are interactive. A change to one may require a subtle change to the other in order to achieve the optimum setting.

Color

“Color” (“Hue” or “tint”) is essentially the ratio of red to green in the color portion of the image. When Color is decreased, the image appears redder; when it is increased the image appears greener. To adjust the color, use a blue filter when viewing the color bar pattern, as you would for adjusting color saturation.

Select **Color** from the Picture Settings menu and press ▲ or ▼ to adjust it until the cyan and magenta color bars (on either side of the green bar) appear to be a single shade of blue.

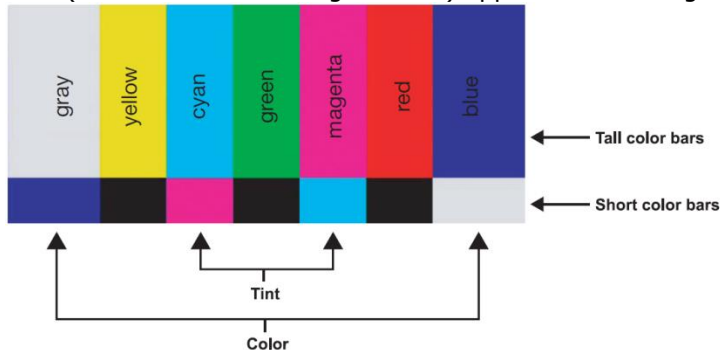

Like the brightness and contrast controls, the color and tint controls are interactive. A change to one may require a subtle change to the other in order to achieve the optimum setting.

Sharpness

“Sharpness” is the amount of high-frequency detail in the image. To adjust sharpness, select **Sharpness** from the Picture Settings menu. On your external test pattern source, select a pattern like the one shown below. Adjust as needed, looking for white edges around the transitions from black to gray and differently-sized lines in the “sweep” patterns at the top and bottom. Lower the sharpness setting to eliminate them.

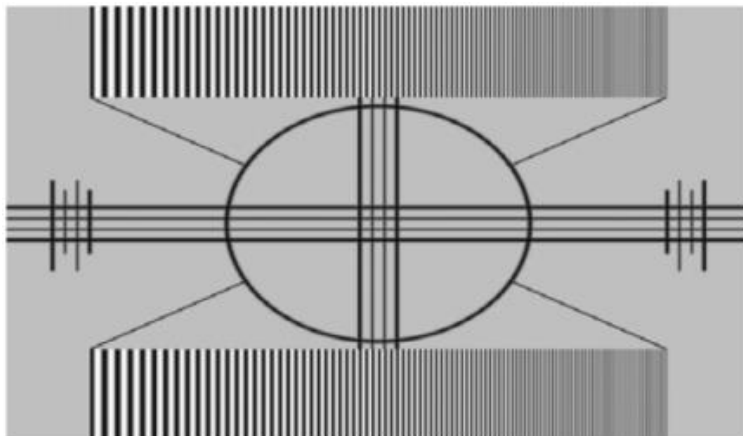

Color Temperature

Select **Color Temperature** from the Picture Settings menu to adjust the color temperature.

- Studio1 = 3200K
- Studio2 = 5600K

- Warm = 6500K
- Normal = 10000K
- Cool = 11500K



A "Color Temperature" is an x/y coordinate pair that defines a color's location on the standard CIE chromaticity graph, shown below. (CIE stands for "Commission Internationale de l'Éclairage" (International Commission on Illumination), the organization responsible for color measurement and management.)

Select a value of from 3200K (Studio1) to 11500K (Cool). Higher settings produce a "bluer" picture; lower ones impart a reddish hue to the image. To select a custom color temperature, select User and set the Gain and Offset as described below.

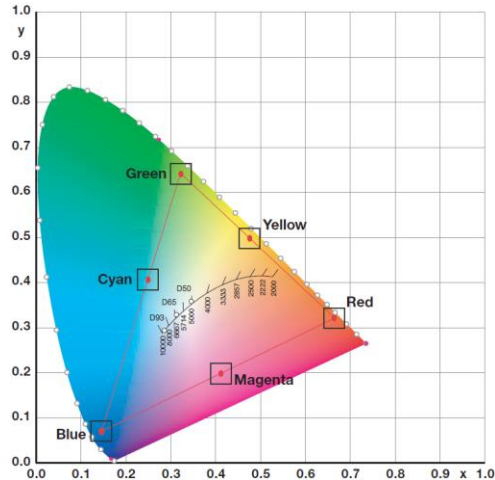

Sound Settings

Picture	Audio Select	HDMI
Sound	Volume	50
OSD	Balance	0
Setup		
Multi-Window		
LAN Setting		
About		

Audio Input

Select audio input source [DP1],[DP2],[HDMI1],[HDMI2],[HDMI3],[HDMI4],[DVI],[OPS-HDMI],[OPS-DP]

Volume

The volume can be changed or the sound can be muted only for displays that are turned on. The Volume can be adjusted using the slider bar in the range of 0 to 100.

Balance

Adjust the volume of the left and right speakers of the selected display device. (-50 ~ +50)

OSD Settings

Picture	Language	English
Sound	OSD Turn Off	20sec
OSD	OSD Position	C
Setup	OSD Rotation	Off
Multi-Window		
LANSetting		
About		

Language

Select OSD Language from the **OSD** Settings menu and press ▲ or ▼ to select the OSD Language. (English, French, German, Italian, Russian, Spanish and Korean)

OSD Turn off

Select **OSD Timeout** from the Basic Settings menu to specify how long the menus remain on-screen after selecting them (5s / 10s / 20s / Off).

OSD Position

Select OSD Position in the Basic Settings menu to specify the position displayed on the screen after selecting the menu.(TL/TR/C/BL/BR)

- TL : Top Left
- TR : Top Right
- C : Center
- BL : Bottom Left
- BR : Bottom Right

OSD Rotation

Select OSD Rotation from the Basic Settings menu to select the menu, and then specify the settings on the screen. (Off/On)

Setup Settings

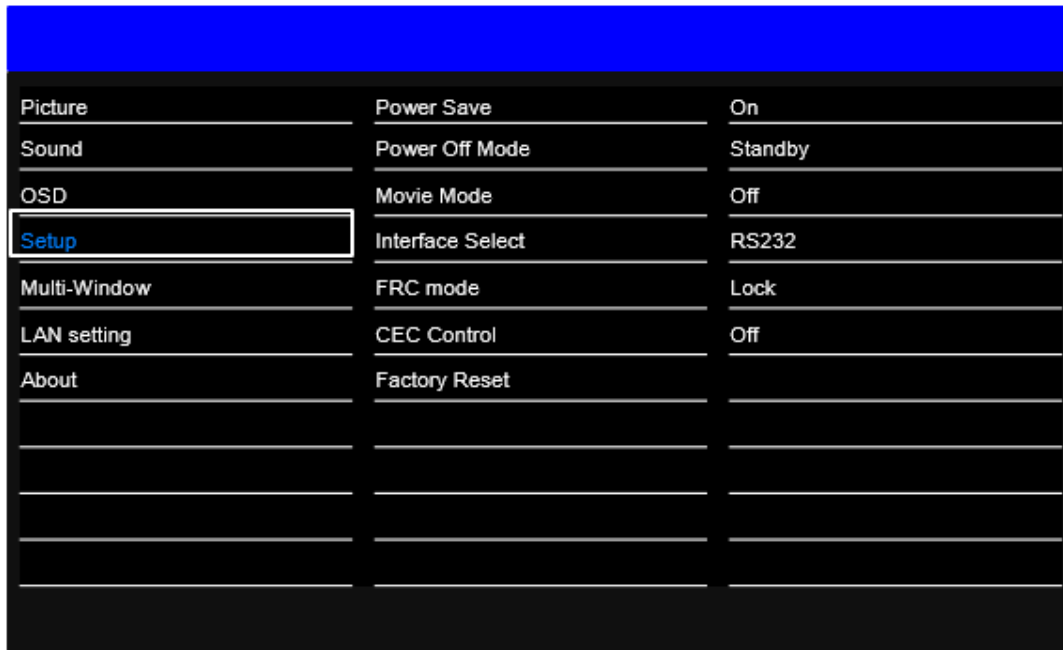

Power Save

After 40 seconds of no signal, the display enters the power-saving mode.

Power Off Mode

Determines the option when the display goes into power save mode.

Power Off Mode	IR	RS232 control	Ethernet control	Crestron control	Power consumption
Standby	Yes	Yes	Yes	Yes	< 5W
Sleep	Yes	Yes	No	No	< 2W
Deep Sleep	Yes	No	No	No	< 0.5W

When the power off mode is set to 'sleep', do not enter sleep mode before Mac address appears in the about menu of OSD. Mac address display indicates that all booting is complete.

Movie Mode

Adjusts the amount of blurring and juddering of the moving image.

- Off : When connecting to a PC or game console, you can enjoy a more realistic gaming experience by Selecting Off.
- Low / Middle / High : When you watch movies, you can enjoy a smoother image.

Interface Select

Select the **control Interface**, RS232 or OPS-RS232 or Off

FRC Mode

Adjusts the amount FRC frequency. (Free Run/Lock)

When the input vertical frequency 50Hz is applied, the screen is correctly displayed on the high-speed motion screen.

- Free Run : Only 120Hz
- Lock : 100Hz/120Hz

CEC Control

Select the CEC Control Enable or Disable (Off/On)CEC Control allows you to power the display on/off using a CEC command.

Factory Reset

To reset ALL display settings (including image settings) back to their factory defaults, choose **Factory Reset** from the Setup Settings menu.

Resettiing to factory defaults will lose all settings adjusted. Proceed with caution!

Multi-Window

The multi-window mode allows you to display multiple inputs simultaneously and save them to a preset which can be quickly recalled.

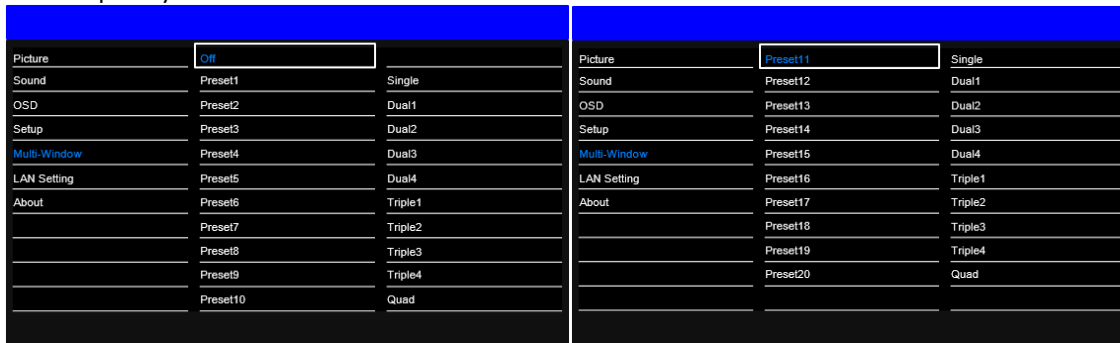

Off

The Multi-Window Off

Preset1 ~ Preset20

You can store up to 20 different configured multi-window presets

Number	Window count & Input
Preset1	One /HDMI1
Preset2	Dual1 /HDMI1/HDMI2
Preset3	Dual2 /HDMI1/HDMI2
Preset4	Dual3 /HDMI1/HDMI2
Preset5	Dual4 /HDMI1/HDMI2
Preset6	Triple1/HDMI1/HDMI2/HDMI3
Preset7	Triple2/HDMI1/HDMI2/HDMI3
Preset8	Triple3/HDMI1/HDMI2/HDMI3
Preset9	Triple4/HDMI1/HDMI2/HDMI3
Preset10	Quad/HDMI1/HDMI2/HDMI3/HDMI4
Preset11	One /DP1
Preset12	Dual1 /DP1/DP2
Preset13	Dual2 /DP1/DP2
Preset14	Dual3 /DP1/DP2
Preset15	Dual4 /DP1/DP2
Preset16	Triple1/DP1/DP2/HDMI1
Preset17	Triple2/DP1/DP2/HDMI1
Preset18	Triple3/DP1/DP2/HDMI1
Preset19	Triple4/DP1/DP2/HDMI1
Preset20	Quad/DP1/DP2/HDMI1/HDMI2

Edit

To change the configuration or the source for the preset select "Edit".

Apply

To recall a previously configured Preset select "Apply".

Multi-Window Edit

Preset3		
Picture	Multi-Window Mode	Dual2
Sound	Window1	HDMI1
OSD	Window2	HDMI2
Setup	Window3	HDMI3
Multi-Window	Window4	DP1
LANSetting	Apply	
About		

Preset1		
Picture	Multi-Window Modes	Single
Sound	Window1	Dual1
OSD	Window2	Dual2
Setup	Window3	Dual3
Multi-Window	Window4	Dual4
LANSetting	Apply	Triple1
About		Triple2
		Triple3
		Triple4
		Quad

Multi-Window Modes

There are several modes that you are able to select and save to a preset

1. Select **Multi-Window Modes** from the Multi-Window Settings menu.

(Off/One/Dual1/Dual2/Dual3/ Dual4/Triple1/Triple2/Triple3/Triple4/Quad)

2. Select a One/Dual1/Dual2/Dual3/Dual4/Triple1/Triple2/Triple3/Triple4/Quad input source.

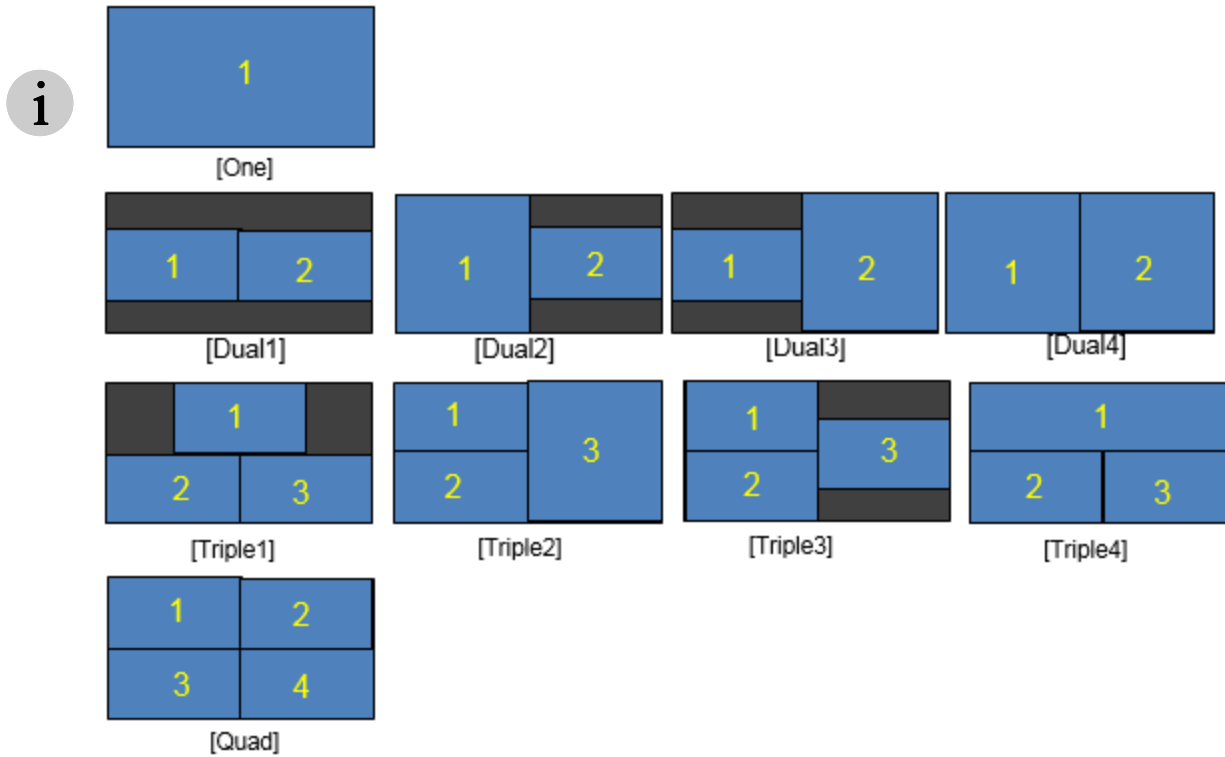

Window1 – Window4

To configure which source is in the respective window, select a Source in Window 1-4. There are some limitations to which sources can be applied in some modes. (see below)

Dual/Quad		Sub screen								
		DP1	DP2	HDMI1	HDMI2	HDMI3	HDMI4	DVI	OPS HDMI	OPS DP
Main Screen	DP1	Yes	Yes	Yes	Yes	Yes	Yes	Yes	Yes	Yes
	DP2	Yes	Yes	Yes	Yes	Yes	Yes	Yes	Yes	Yes
	HDMI1	Yes	Yes	Yes	Yes	Yes	Yes	No	Yes	Yes
	HDMI2	Yes	Yes	Yes	Yes	Yes	Yes	Yes	Yes	Yes
	HDMI3	Yes	Yes	Yes	Yes	Yes	Yes	Yes	Yes	Yes
	HDMI4	Yes	Yes	Yes	Yes	Yes	Yes	Yes	No	No
	DVI	Yes	Yes	No	Yes	Yes	Yes	Yes	Yes	Yes
	OPS-HDMI	Yes	Yes	Yes	Yes	Yes	No	Yes	Yes	No
	OPS-DP	Yes	Yes	Yes	Yes	Yes	No	Yes	No	Yes

About

Picture	Model : SUHD983-P	MAC: 88:3F:4A:30:86:13
Sound	Version : 0.0.1.0 - 3	S/N : SUHD98V450000
OSD	Window1	HDMI1
Setup	Resolution	1920x1808@60Hz
Multi-Window	Window2	HDMI2
LANSetting	Resolution	1920x1808@60Hz
About	Window3	HDMI3
	Resolution	1920x1808@60Hz
	Window4	DP1
	Resolution	1920x1808@60Hz

The read-only "About" menu provides the following status information about the display:

- The resolution and refresh rate of the active source.
- The currently-installed firmware version.

OPS (Open Pluggable Standard)

The purpose of this part is to describe the electrical, mechanical specifications of the Open Pluggable Specification (OPS), which enables a standard and easier integration of a pluggable module into the display panel.

Throughout this part the 80pin JAE TX24A/TX25A series connector will be referred to as the "JAE connector".

Dimensions shown in all figures are in unit mm.

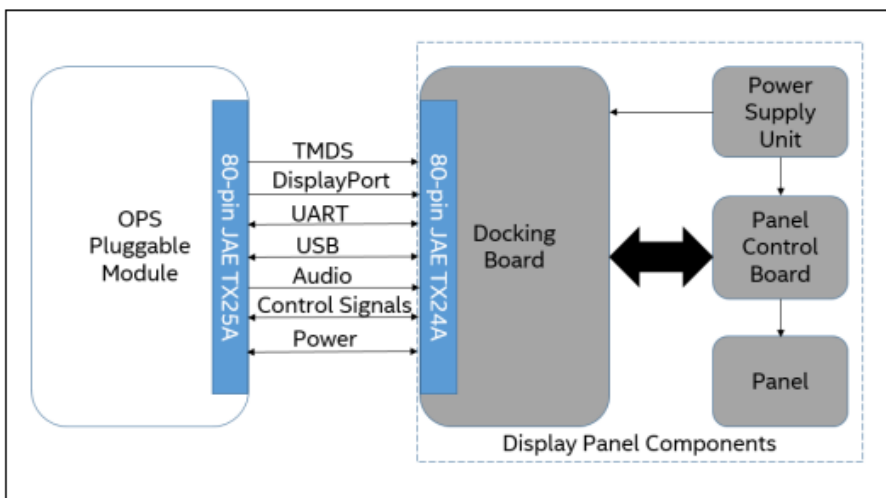

The OPS involves the integration concept of a Pluggable Module into the display panel thru a single and standard interfacing based on the 80 pin JAE plug and receptacle connectors.



The connector used for the Pluggable Module and the docking board interconnect is based on the JAE TX24A/TX25A family of plug and receptacle connectors. The JAE connector pins are capable of supporting up to a maximum current of 1A. The 80-pin right angle blind mate plug connector (P/N: TX25A-80P-LT-H1E) and its receptacle (P/N: TX24A-80R-LT-H1E) provide interfacing for the following features.

- Power: DC IN +12V~+19V @ 8A max.
- Display Interface: DVI-D/TMD5+ and DisplayPort
- Audio: Left and Right Channel
- USB: 3xUSB 2.0 (when USB3.0 is not used) or 2xUSB 2.0 and 1xUSB 3.0
- UART: Serial communication (Tx and Rx only)
- Control Signals: Pluggable Module Power Status, Power ON via display panel, Pluggable Board Detect, Consumer Electronics Control (CEC), and System Fan Control.

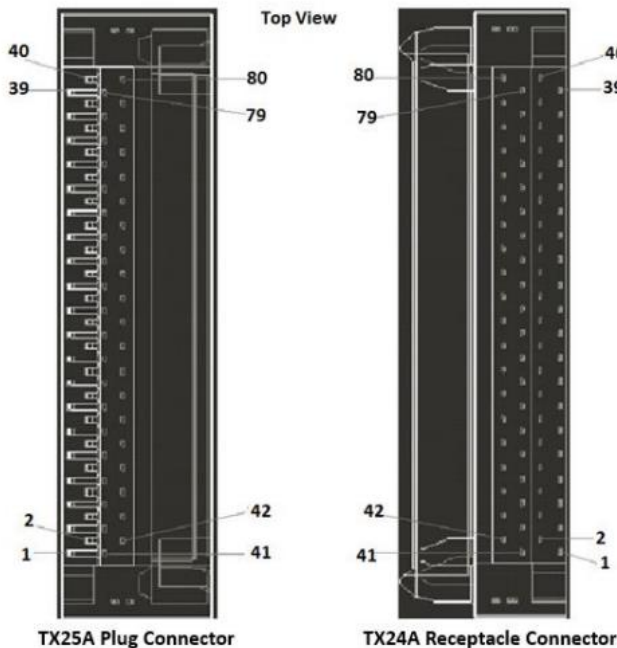

Left: Plug connector (p/n: TX25A-80P-LT-H1E).

Right: Receptacle connector (p/n: TX24A-80R-LT-H1E). Connector series image, reference only.



Caution! If not avoided, the following could result in minor or moderate injury.

- Always use screws to install OPS
- Do not swap OPS modules while the display is powered on.
- This display supports OPS power consumption up to 60W

Supported Timings

Signal Type	Format	Hres	Vres	Frame rate (Hz)	Sampling	Bit-Depth
DVI	640x480	640	480	50,60	RGB/4:4:4	8bpc
	800x600	800	600	50,60	RGB/4:4:4	8bpc
	1024x768	1024	768	50,60	RGB/4:4:4	8bpc
	1280x720	1280	720	50,60	RGB/4:4:4	8bpc
	1280x800	1280	800	50,60	RGB/4:4:4	8bpc
	1280x1024	1280	1024	50,60	RGB/4:4:4	8bpc
	1600x900	1600	900	50,60	RGB/4:4:4	8bpc
	1920x1080	1920	1080	50,60	RGB/4:4:4	8bpc
HDMI	640x480	640	480	50,60	RGB/4:4:4/4:2:2	8/10/12bpc
	800x600	800	600	50,60	RGB/4:4:4/4:2:2	8/10/12bpc
	1024x768	1024	768	50,60	RGB/4:4:4/4:2:2	8/10/12bpc
	1280x720	1280	720	50,60	RGB/4:4:4/4:2:2	8/10/12bpc
	1280x800	1280	800	50,60	RGB/4:4:4/4:2:2	8/10/12bpc
	1280x1024	1280	1024	50,60	RGB/4:4:4/4:2:2	8/10/12bpc
	1600x900	1600	900	50,60	RGB/4:4:4/4:2:2	8/10/12bpc
	1920x1080	1920	1080	50,60	RGB/4:4:4/4:2:2	8/10/12bpc
	3840x2160	3840	2160	30,50,60	RGB/4:4:4/4:2:2	8/10/12bpc
DP	640x480	640	480	50,60	RGB/4:4:4	8/10/12bpc
	800x600	800	600	50,60	RGB/4:4:4	8/10/12bpc
	1024x768	1024	768	50,60	RGB/4:4:4	8/10/12bpc
	1280x720	1280	720	50,60	RGB/4:4:4	8/10/12bpc
	1280x800	1280	800	50,60	RGB/4:4:4	8/10/12bpc
	1280x1024	1280	1024	50,60	RGB/4:4:4	8/10/12bpc
	1600x900	1600	900	50,60	RGB/4:4:4	8/10/12bpc
	1920x1080	1920	1080	50,60	RGB/4:4:4	8/10/12bpc
	3840x2160	3840	2160	30,50,60	RGB/4:4:4	8/10/12bpc
	7680x4320	7680	4320	30	RGB/4:4:4	8/10/12bpc

OPS HDMI, OPS DP	640x480	640	480	50,60	RGB/4:4:4/4:2:2	8/10/12bpc
	800x600	800	600	50,60	RGB/4:4:4/4:2:2	8/10/12bpc
	1024x768	1024	768	50,60	RGB/4:4:4/4:2:2	8/10/12bpc
	1280x720	1280	720	50,60	RGB/4:4:4/4:2:2	8/10/12bpc
	1280x800	1280	800	50,60	RGB/4:4:4/4:2:2	8/10/12bpc
	1280x1024	1280	1024	50,60	RGB/4:4:4/4:2:2	8/10/12bpc
	1600x900	1600	900	50,60	RGB/4:4:4/4:2:2	8/10/12bpc
	1920x1080	1920	1080	50,60	RGB/4:4:4/4:2:2	8/10/12bpc
	3840x2160	3840	2160	30,50,60	RGB/4:4:4/4:2:2	8/10/12bpc

Network Guide

Connecting the monitor and the computer via the network, remote control and status monitoring of the monitor can be performed by Web browser.

Connection Setting

1. To use a static IP address, Select Disable under DHCP.

Picture	DHCP	Disable
Sound	IP Address	192.168.10.10
OSD	Subnet Mask	255.255.255.0
Setup	Gate Way	192.168.10.1
Multi-Window	DNS	168.126.63.1
LAN Setting	LAN Setting Reset	
About		

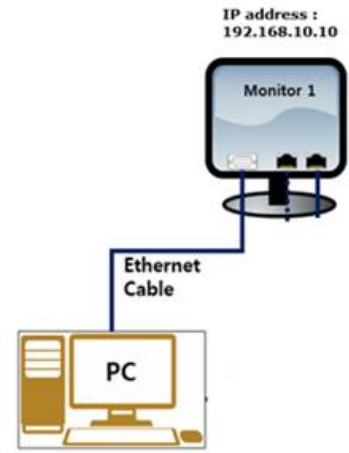

The default static IP address is 192.168.10.10

2. Select DHCP Enable to use a dynamic IP address.
 - If there is router, the IP address starts with 192.168.
 - If there is no router, the IP address starts with 169.254.

Picture	DHCP	Enable
Sound	IP Address	192.168.1.3
OSD	Subnet Mask	255.255.255.0
Setup	Gate Way	192.168.10.1
Multi-Window	DNS	168.126.63.1
LAN Setting	LAN Setting Reset	
About		

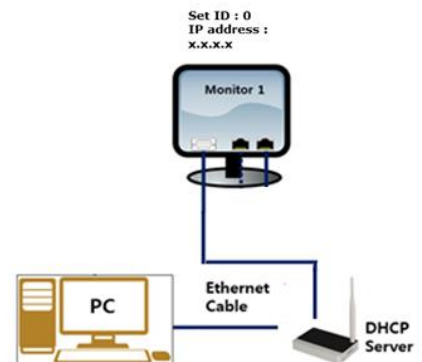

PC Setting

1. Go to Local Network Setting > Internet protocol version 4 (TCP/IPv4).
2. If DHCP is disabled, set the IP address and Subnet mask.

IP address must be a different address than the display.

IP address : 192.168.10.50

Subnet Mask : 255.255.255.0

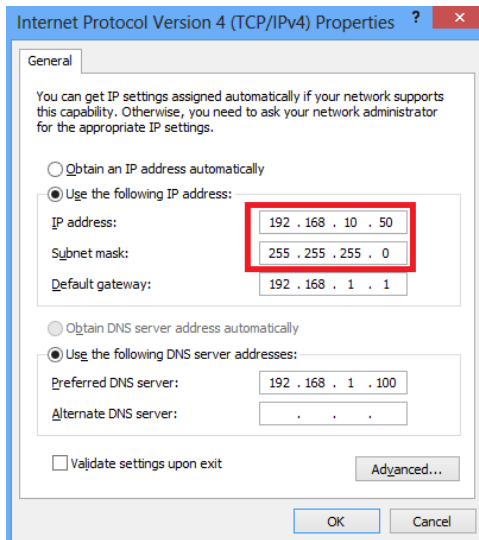

3. If DHCP is enabled, select Obtain an IP address automatically.

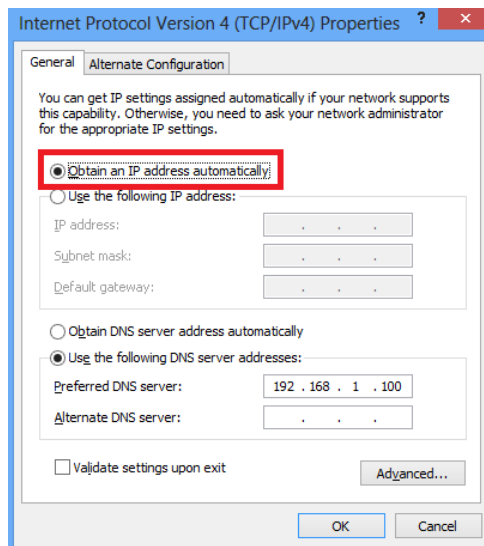

Ping Test

Ping test checks the Ethernet connection.

1. Press Windows + R.
2. Type `cmd` and click **OK**.

- Type `ping -t 192.168.10.10`.

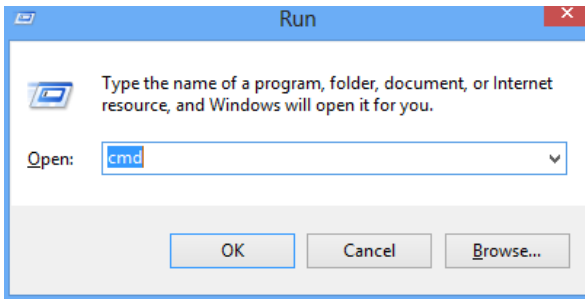

Replace the IP address with the address of the display panel.

If there are response like below, it is success

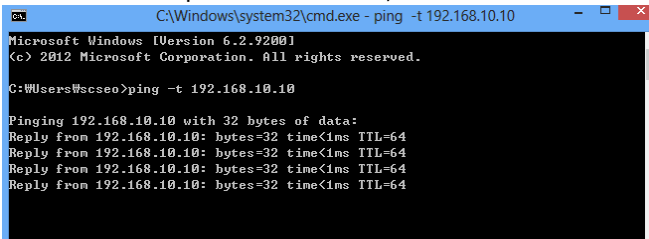

If there are no response like below, it is fail.

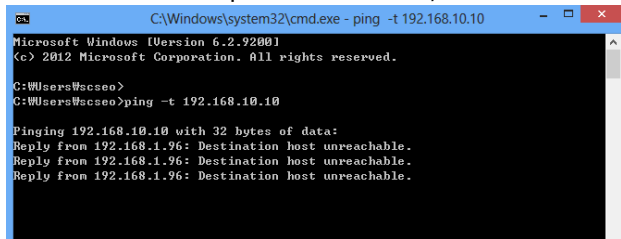

Connect Web server

To connect to the built-in web server open a Web browser (ex. Internet Explorer, Chrome) and follow the instructions below.

- In a web browser, go to the address of the display panel.
Web page provide all menu controls on the on-screen display.
- To set a value, click **Apply**.
- To display the current value, click **Read**.

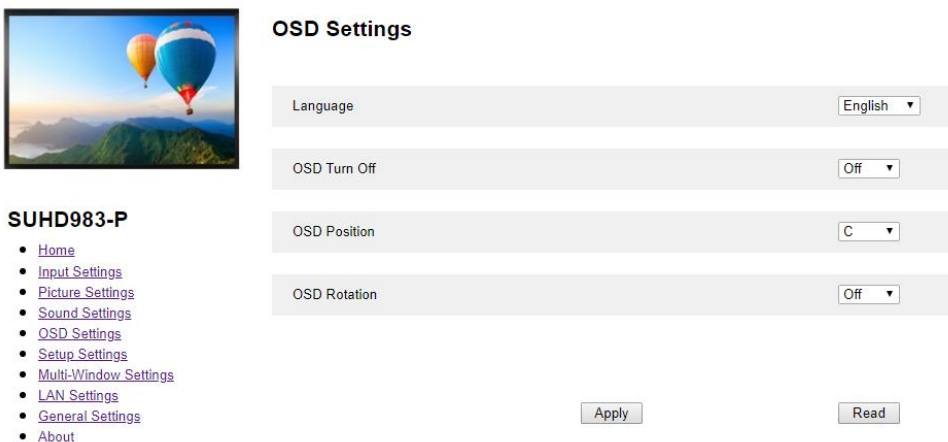

- To upgrade the Ethernet or Scaler firmware, go to the General settings page.

Ethernet firmware update time: about 5 minutes. Scaler firmware update time: about 8 minutes

CHRISTIE®



General Settings

Scaler F/W Update No file chosen

Ethernet F/W Update No file chosen

SUHD983-P

- [Home](#)
- [Input Settings](#)
- [Picture Settings](#)
- [Sound Settings](#)
- [OSD Settings](#)
- [Setup Settings](#)
- [Multi-Window Settings](#)
- [LAN Settings](#)
- [General Settings](#)
- [About](#)

Maintenance and Troubleshooting

Maintenance

Under normal operating conditions, routine maintenance is not required. There are no user-serviceable or replaceable parts. Unless you are a qualified, factory-trained technician, do not attempt to repair or replace any system component or the product warranty may be voided.

Troubleshooting

The table below provides some general guidelines for troubleshooting problems you may encounter with your display. If the suggested solutions fail to resolve the problem or if you encounter an issue not described here, please contact your dealer.

Symptom	Possible Cause(s)	Solution
The display does not turn on.	<ul style="list-style-type: none"> The display is not plugged in or the AC outlet is not active. The main power switch is off. The remote control batteries have run out. 	<ul style="list-style-type: none"> Ensure that the display is plugged in and that the AC outlet is active. Set the main power switch to the on position. (See <i>Display at a Glance</i> on page 10) Replace the batteries.
The display is on and menus appear, but there is no picture.	<ul style="list-style-type: none"> Incorrect source selection. Source component is not turned on. Source component is connected incorrectly or not at all. 	<ul style="list-style-type: none"> Select the correct source. Turn on the source component. Check connections from the source component to the display. Try rebooting or restarting the source.
The remote control does not work.	<ul style="list-style-type: none"> The remote control batteries have run out. 	<ul style="list-style-type: none"> Replace the batteries.
The display is jittery or unstable.	<ul style="list-style-type: none"> Poor-quality or improperly connected source. The horizontal or vertical scan frequency of the input signal may be out of range for the display. 	<ul style="list-style-type: none"> Ensure that the source is properly connected and of adequate quality for detection. Correct at the source. Try using a different certified cable.
Image is too bright and/or lacks definition in the bright areas of the image.	<ul style="list-style-type: none"> Contrast is set too high. 	<ul style="list-style-type: none"> Decrease the contrast setting.
Image appears “washed out” and/or dark areas appear too bright.	<ul style="list-style-type: none"> Black level is set too high. 	<ul style="list-style-type: none"> Decrease the black level setting.

Image is too dark.	<ul style="list-style-type: none"> • Black level and/or brightness are set too low. 	<ul style="list-style-type: none"> • Increase the black level and/or brightness settings.
Images from an HDMI source do not display.	<ul style="list-style-type: none"> • The resolution and frequency of the video card in the computer are not compatible with the display. • HDMI cable from source to display is either defective or too long. 	<ul style="list-style-type: none"> • Select a compatible resolution and vertical frequency (refer to <i>Supported Timings</i> on page 36). • Try a known-good and/or shorter HDMI cable.
Computer images do not display correctly.	<ul style="list-style-type: none"> • The resolution and frequency of the video card in the computer are not compatible with the display. • Clock and Phase settings need adjustment. 	Select a compatible resolution and vertical frequency (refer to <i>Supported Timings</i> on page 36).

Corporate offices

Christie Digital Systems USA, Inc.
Cypress
ph: 714 236 8610

Christie Digital Systems Canada Inc.
Kitchener
ph: 519 744 8005

Worldwide offices

Australia
ph: +61 (0) 7 3624 4888

Brazil
ph: +55 (11) 2548 4753

China (Beijing)
ph: +86 10 6561 0240

China (Shanghai)
ph: +86 21 6278 7708

France
ph: +33 (0) 1 41 21 44 04

Germany
ph: +49 2161 664540

India
ph: +91 (080) 6708 9999

Japan (Tokyo)
ph: 81 3 3599 7481

Korea (Seoul)
ph: +82 2 702 1601

Mexico
ph: +52 55 4744 1790

Republic of South Africa
ph: +27 (0)11 510 0094

Russian Federation
and Eastern Europe
ph: +36 (0) 1 47 48 100

Singapore
ph: +65 6877 8737

Spain
ph: +34 91 633 9990

United Arab Emirates
ph: +971 4 3206688

United Kingdom
ph: +44 (0) 118 977 8000

United States (Arizona)
ph: 602 943 5700

United States (New York)
ph: 646 779 2014

Independant sales consultant offices

Italy
ph: +39 (0) 2 9902 1161



For the most current technical documentation, visit www.christiedigital.com.

