

User's Guide



Fireface UCX II

The most powerful USB audio interface ever!

24 Bit / 192 kHz ✓

TotalMix FX™



SteadyClock FS™



SyncCheck™

USB 2.0 Digital I/O System
8 Channel Analog Interface
2 + 2 Channel AES / SPDIF Interface
8 Channel ADAT Interface
24 Bit / 192 kHz Digital Audio
40 x 20 Matrix Router
MIDI Input / Output
Full Stand-Alone Operation
Direct USB Recording
Class Compliant Operation

Safety Instructions and Proper use



Read the manual carefully and completely before using the device. Pay attention to the following information on how to use and operate the Fireface UCX II safely. Improper use can lead to loss of warranty claims (see warranty statement on page 82).

Proper Use

The Fireface UCX II is a digital interface for professional audio applications for use with CE approved class B computers.



To comply with the European CE standard, the Fireface UCX II must be used with CE approved Class B computers. All connecting cables must be shielded. The computer and all cables connected to the Fireface UCX II must be properly grounded. Operation with non-certified computers and cables may cause interference to other devices as well as the Fireface UCX II.



Do not open chassis

No user serviceable parts inside. Refer service to qualified service personnel.



To reduce the risk of fire or electric shock do not expose this device to rain or moisture. Prevent moisture and water from entering the device. Never leave a pot with liquid on top of the device. Do not use this product near water, i. e. swimming pool, bathtub or wet basement. Danger of condensation inside – don't turn on before the device has reached room temperature.



Installation

Surface may become hot during operation – ensure sufficient ventilation. Avoid direct sun light and do not place it near other sources of heat, like radiators or stoves. When mounting in a rack, leave some space between this device and others for ventilation.



Unauthorized servicing/repair voids warranty. Only use accessories specified by the manufacturer.

▶	Safety Instructions and Proper Use	2
---	---	---

▶ **General**

1	Introduction	8
2	Package Contents	8
3	System Requirements	8
4	Brief Description and Characteristics	8
5	First Usage - Quick Start	
5.1	Connectors – Controls - Display	9
5.2	Quick Start	11
5.3	Menu and Navigation	11
5.4	Overview Menu Structure.....	13
5.5	Special Options	14

▶ **Installation and Operation - Windows**

6	Hardware, Driver and Firmware Installation	
6.1	Hardware and Driver Installation.....	16
6.2	De-installing the Drivers	16
6.3	Firmware Update	16
7	Configuring the Fireface – Settings Dialog	
7.1	General	17
7.2	Pitch	19
7.3	Option WDM Devices	20
8	Operation and Usage	
8.1	Playback.....	20
8.2	DVD Playback (AC-3 / DTS).....	21
8.3	Channel Count under WDM.....	22
8.4	Multi-client Operation	22
8.5	Analog Recording.....	23
8.6	Digital Recording.....	23
8.7	Clock Modes - Synchronization.....	24
9	Operation under ASIO	
9.1	General	25
9.2	Channel Count under ASIO	25
9.3	Known Problems	26
10	Using more than one Fireface UCX II	26
11	DIGICheck Windows	27
12	Hotline – Troubleshooting	28

► Installation and Operation - Mac OS X

13	Hardware, Driver and Firmware Installation	
13.1	Hardware and Driver Installation	30
13.2	De-installing the Drivers	30
13.3	Firmware Update.....	30
14	Configuring the Fireface	
14.1	Settings Dialog	31
14.2	Clock Modes - Synchronization.....	33
15	Mac OS X FAQ	
15.1	MIDI doesn't work.....	34
15.2	Repairing Disk Permissions	34
15.3	Supported Sample Rates	34
15.4	Channel Count under Core Audio	34
15.5	Various Information	35
16	Using more than one Fireface	35
17	DIGiCheck Mac	36
18	Hotline – Troubleshooting	37

► Inputs and Outputs

19	Analog Inputs	
19.1	Line Rear	40
19.2	Microphone / Line Front	40
19.3	Instrument / Line Front	41
20	Analog Outputs	
20.1	Line.....	42
20.2	Headphones / Line Out	42
21	Digital Connections	
21.1	ADAT.....	43
21.2	AES/EBU.....	43
21.3	SPDIF (Coaxial, Optical)	44
21.4	MIDI.....	44
22	Word Clock	
22.1	Word Clock Input / Output.....	45
22.2	Technical Description and Background.....	46
22.3	Cables and Termination	47
22.4	General Operation.....	47

► Stand-Alone Operation

23	Operation and Usage	
23.1	General.....	50
23.2	Settings at the Unit	50
23.3	Store / Load Setups at the Unit	50
23.4	Storing Setups from the Computer.....	50
24	Examples	
24.1	8-Channel AD/DA-Converter	51
24.2	2-Channel Mic Preamp	51
24.3	Monitor Mixer.....	51
24.4	Digital Format Converter	51
24.5	Analog/Digital Routing Matrix	51
24.6	Stand-Alone Recorder/Player.....	51

► **TotalMix FX**

25	Routing and Monitoring	
25.1	Overview	54
25.2	The User Interface	56
25.3	The Channels.....	57
25.3.1	Settings	59
25.3.2	Equalizer	60
25.3.3	Dynamics	62
25.4	Section Control Room.....	63
25.5	The Control Strip	64
25.5.1	View Options	65
25.5.2	Snapshots - Groups	66
25.5.3	Channel Layout – Layout Presets	67
25.5.4	Scroll Location Markers.....	68
25.6	Reverb and Echo	69
25.7	Preferences.....	72
25.7.1	Store for Current or All Users.....	73
25.8	Settings	74
25.8.1	Mixer Page	74
25.8.2	MIDI Page	75
25.8.3	OSC Page	76
25.8.4	Aux Devices	77
25.9	Hotkeys and Usage.....	78
25.10	Menu Options.....	79
25.11	Menu Window	80
26	The Matrix	
26.1	Overview	80
26.2	Elements of the Matrix View	80
26.3	Operation	81
27	Tips and Tricks	
27.1	ASIO Direct Monitoring (Windows)	81
27.2	Copy a Submix.....	81
27.3	Doubling the Output Signal (Mirror)	81
27.4	Delete a Submix.....	82
27.5	Copy and Paste everywhere	82
27.6	Recording a Submix - Loopback.....	82
27.7	MS Processing	83
28	MIDI Remote Control	
28.1	Overview	84
28.2	Mapping	84
28.3	Setup.....	85
28.4	Operation	85
28.5	MIDI Control	86
28.6	Stand-Alone MIDI Control	87
28.7	Loopback Detection	89
28.8	OSC (Open Sound Control)	89
29	DAW Mode	89
30	TotalMix Remote	90

▶ Class Compliant Mode

31	General	94
32	System Requirements	94
33	Operation	95
	33.1 Useful Hints	95
	33.2 Class Compliant under Windows/Mac OS X	96
34	Supported Inputs and Outputs	96
35	Front panel Operation	97
36	Audio Routing and Processing	97
37	Setups	98

▶ DUREC - Direct USB Recording

38	Direct USB Recording	
	38.1 Overview	100
	38.2 Operation	100
	38.3 Limitations and Important Notes	103
	38.4 Multichannel WAV File Batch Processor	104
	38.5 Technical Background	105

▶ Technical Reference

39	Technical Specifications	
	39.1 Analog	108
	39.2 MIDI	109
	39.3 Digital	109
	39.4 Digital Inputs	109
	39.5 Digital Outputs	110
	39.6 General	110
40	Technical Background	
	40.1 Lock and SyncCheck	111
	40.2 Latency and Monitoring	112
	40.3 USB Audio	113
	40.4 DS – Double Speed	114
	40.5 QS – Quad Speed	114
	40.6 Noise Level in DS / QS Mode	115
	40.7 SteadyClock	115
41	Diagrams	
	41.1 Block Diagram Fireface UCX II	116
	41.2 Connector Pinouts	117

▶ Miscellaneous

42	Accessories	120
43	Warranty	120
44	Appendix	121
45	Declaration of Conformity	122

User's Guide



Fireface UCX II

► General

1. Introduction

Thank you for choosing the Fireface UCX II. This unique audio system is capable of transferring analog and digital audio data directly to Windows and Mac computers. The latest Plug and Play technology guarantees a simple installation, even for the inexperienced user. Numerous unique features like a well thought-out Settings dialog and an integrated routing solution realize a quick, comfortable and efficient operation of the Fireface UCX II.

The package contains drivers for Windows 7 / 8 / 10 and Mac OS X x86 (Intel).

2. Package Contents

Please check your Fireface UCX II package contains each of the following:

- Fireface UCX II
- Cable USB 2.0, 1.8 m (6 ft)
- Optical cable (TOSLINK), 2 m (6.6 ft)
- B0968 Digital breakout cable (XLR/RCA)
- External switched power supply, lockable connector, DC 12 V 24 W
- Power cord

3. System Requirements

- Windows 7 or up, Intel Mac OS X (10.12 or up)
- 1 x USB 2.0 or USB 3.0 port
- Computer with at least Intel Core i3 CPU

4. Brief Description and Characteristics

- All settings can be changed in real-time
- Buffer sizes/latencies from 48 up to 8192 samples selectable
- 4 channels 96 kHz/24 bit Record/Playback via ADAT optical (S/MUX)
- 2 channels 192 kHz/24 bit Record/Playback via ADAT optical (S/MUX4)
- Clock modes slave and master
- Automatic and intelligent master/slave clock control
- Unsurpassed Bitclock PLL (audio synchronization) in ADAT mode
- SteadyClock FS: Jitter-immune, super-stable digital clock
- DDS technology for free setting of the sample rate
- SyncAlign guarantees sample aligned and never swapping channels
- SyncCheck tests and reports the synchronization status of input signals
- TotalMix for latency-free submixes and perfect ASIO Direct Monitoring
- TotalMix: 800 channel mixer with 46 bit internal resolution
- TotalMix FX: 3-band EQ, Low Cut, Reverb, Echo, Compressor, Expander, Auto Level
- 1 x MIDI I/O, 16 channels high-speed Low-Jitter MIDI
- 1 x Hi-power low impedance headphone output
- DIGICheck DSP: Level meter in hardware, peak- and RMS calculation

5. First Usage – Quick Start

5.1 Connectors – Controls – Display

The front of the Fireface UCX II features two instrument and microphone inputs, a stereo headphone output, a rotary encoder with push functionality, four buttons, a graphical colour display and two status LEDs.

The Neutrik combo sockets of the two **Mic/Line** inputs provide XLR and 6.3 mm / 1/4" TRS connection. They have LEDs for phantom power (48V) indication.

Inputs 3/4, **INST/LINE**, accept both a balanced line signal as well as an unbalanced instrument signal via 1/4" TRS plug.



The analog outputs 7 and 8 feed the headphones output **Phones**. This low impedance output of highest quality is able to drive headphones at higher levels undistorted, no matter if low or high impedance headphones are used.

The four **keys** and the **encoder**, the high-resolution and clear **colour display**, and a well thought-out menu structure enable the user to quickly change and configure the device's settings completely without a computer. Help notes and clear markers in the display guide the user through all functions.



When the Global Level Meter screen is shown, the rotary encoder sets the monitoring volume of Main Out directly at the device. Pushing the button will change to Phones volume control, as indicated in the right lower corner of the screen.

Digital State. On the right side the main screen shows the current sample rate and the state of all digital input signals. WCK, SPDIF, AES and ADAT indicate a valid input signal separately for each digital input. Additionally, RME's exclusive *SyncCheck* indicates if one of these inputs is locked, but not synchronous to the others, in which case the corresponding field will flash. See also chapter 8.7 / 14.2, Clock Modes - Synchronization. The field USB will change to CC when in Class Compliant mode.

State MIDI. Between ADAT and USB two yellow lines indicate incoming and outgoing MIDI data.

The rear panel of the Fireface UCX II features 4 analog inputs and 6 analog outputs, the power socket, USB, DURec (USB-A), word clock, MIDI I/O, ADAT I/O, and a connector for the included breakout cable D-sub to XLR/RCA (SPDIF/AES I/O).

Balanced Line Level Inputs. 4 balanced analog inputs via 6.3 mm stereo TRS connectors.

Balanced Line Level Outputs. 6 balanced analog outputs via 6.3 mm stereo TRS.

AES/EBU & SPDIF. XLR. Via breakout cable the Fireface UCX II supports both SPDIF coaxial as well as AES/EBU.

Word. BNC. Can be set to operate as word clock output or input. The input can be terminated with 75 Ohms internally via Settings dialog, Options.

ADAT I/O. TOSLINK. Standard ADAT optical port, 8 channels. Can also be used as optical SPDIF input and output, if set up accordingly in the Settings dialog.

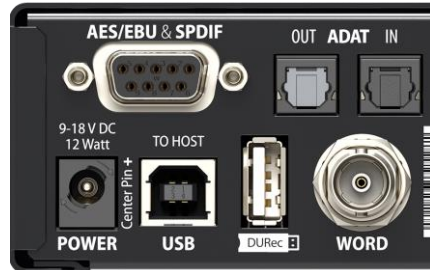

DURec (Remote). Connector for USB stick or USB hard drive. Offers direct recording to / playback from the external memory device. Alternatively connector for the optional Advanced Remote Control USB (ARC USB) when the UCX II is used in stand-alone and Class Compliant mode. This port can also be used instead of connecting the ARC USB to the computer.

USB 2.0. USB socket for connection to the computer. Compatible to USB 3.0.

MIDI I/O. Two 5-pin DIN connectors provide MIDI input and output.

Hook. Secure any loose cable by feeding it through the hook first.

Power. The included hi-performance switch mode power supply operates in the range of 100V to 240V AC at highest power efficiency. It is short-circuit-proof, has an integrated line filter, is fully regulated against voltage fluctuations, suppresses mains interference, and offers hum-free operation. It supplies 12 V DC at up to 2 A with the center pin + and outer pin GND.

The connector at the power supply and the socket at the unit come with a **turn to lock** feature. **When inserting the connector make sure the little wings are aligned correctly so that the connector is fully inserted.** Then turn the connector so that it is locked and can no longer be removed. If not fully inserted the connection will be loose and cause power loss when the cable is moved.



5.2 Quick Start

After the driver installation (chapter 6 / 13) connect the TRS jacks or the XLR inputs with the analog signal source. The input sensitivity of the rear inputs can be changed in TotalMix (Input Channel Settings, +13 dBu / +19 dBu and Gain), assuring the highest signal to noise ratio will be achieved. Also try to achieve an optimum input level by adjusting the source itself. Raise the source's output level until the peak level meters in TotalMix reach about -3 dB.

The signal level of the front inputs can also be optimized directly at the Fireface. The key MIC/GAIN gives direct access to this setting, which is then controlled by the encoder VALUE.

The digital outputs of the Fireface UCX II provide AES/EBU, SPDIF coaxial, SPDIF optical and ADAT optical at the respective ports.

On the analog playback side (the DA side), a coarse adjustment of the analog output level at the rear jacks is again available in TotalMix (Output Channel Settings, Level), or the Channel Settings directly at the device. The big encoder VALUE controls the Main Out volume (default: Line Out 1/2).

The output signal of channels 7/8, Phones, can also be controlled directly from the VALUE encoder.

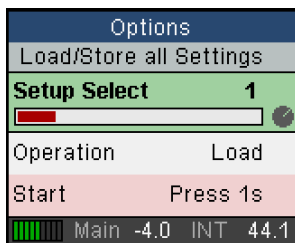
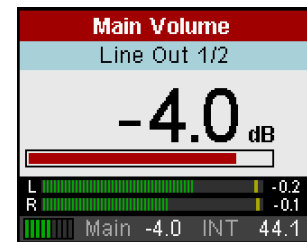
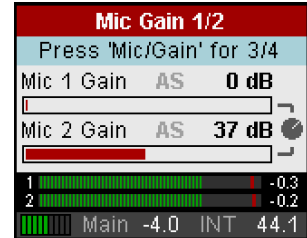

The Fireface UCX II can store and load its current state in 6 different memory slots, called Setups (SETUP/REV, Options, Load/Store all Settings). With this, the Fireface UCX II can be used stand-alone after setting it up accordingly, replacing lots of dedicated devices (see chapter 24).

In online mode some settings are greyed out, as these should be changed only at the computer, in the Settings dialog or in TotalMix FX. These include the choice of sample rate and the mix settings.

5.3 Menu and Navigation

The Fireface UCX II has a simple and clear menu structure, for fast and efficient operation directly at the device. In most cases, however, all settings will be done via the Settings dialog and TotalMix FX of the host computer. The operation on the device is typically limited to a direct adjustment of the monitoring volume (loudspeaker and headphones), the microphone gain, and DUREc (Direct USB Recording). In stand-alone mode, all settings are available directly on the device.

Navigation through the menus of the display and control of the settings is done via four quick select buttons and a rotary encoder with push function.

Default in the display is the Global Level Meter screen, which shows the current signal levels for all I/Os. By pressing the encoder knob VALUE for half a second, only the analog I/Os (Analog Level Meter screen) are displayed, which makes the level display larger and thus easier to read.

The Global and Analog Level Meter Screen on the far right also shows:

- The current sample rate
- Clock mode and Lock/Sync status of the Word, SPDIF, AES and ADAT inputs
- MIDI I/O activity by two yellow dots
- USB and Class Compliant mode active (CC)
- Current output of the volume setting, dB value to it
- DSP meter, shows the load of the DSP by activated FX

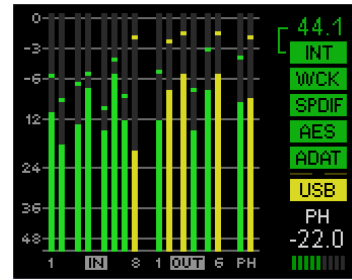

Turning the knob displays the volume screen of the currently selected output. Pressing the knob toggles the display between *Main Out* and *Phones*. At the bottom right, the current selection and dB value of the Volume setting is shown, so it is visible even when the Volume screen is not active.

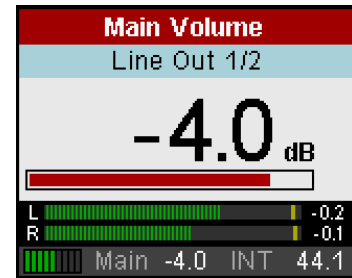

The title bar shows the currently selected output and the assigned channels (Default Main is Line Out 1/2, Phones is fixed to Line Out 7/8).

The quick select buttons MIC/GAIN, REC/PLAY, CHAN/MIX and SETUP/REV are described in chapter 23.2.

Navigation

The Fireface UCX II has a simple and fast **1-button operation**. Pressing the VALUE encoder switches between adjusting the parameter and moving horizontally through the menu and moving vertically through the menu. Here is an example: the BNC socket's mode is to be switched from Input to Output (or vice versa).

Press the SETUP/REV key. The *Options* menu appears. The cursor is in the second line and has the button symbol. Turning the encoder switches horizontally between the pages *Clock*, *Hardware/Diagnosis*, *Load/Store all Settings* and *Control Room*. After selecting *Clock*, press the encoder. The knob symbol changes to double arrows. By turning the encoder, the cursor now moves vertically through the menu.

Scroll down to *BNC as WCK*. Press the encoder so that the button symbol appears. Select the desired mode Input or Output by turning the knob. Quickly exit the menu by pressing the SETUP/REV button twice. Otherwise the menu will automatically switch to the Level Meter screen after 90 seconds without any user input.

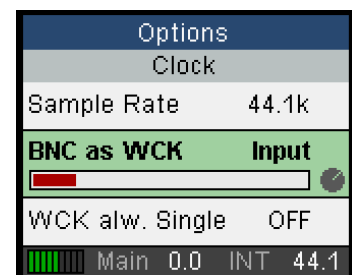
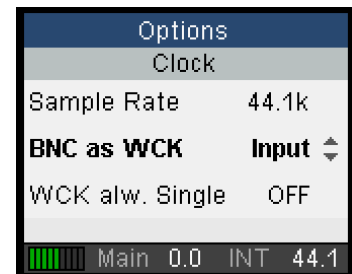
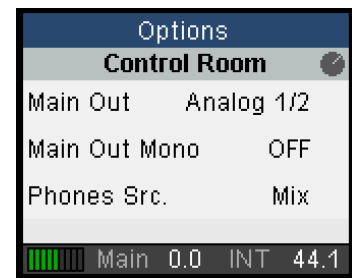

5.4 Overview Menu Structure

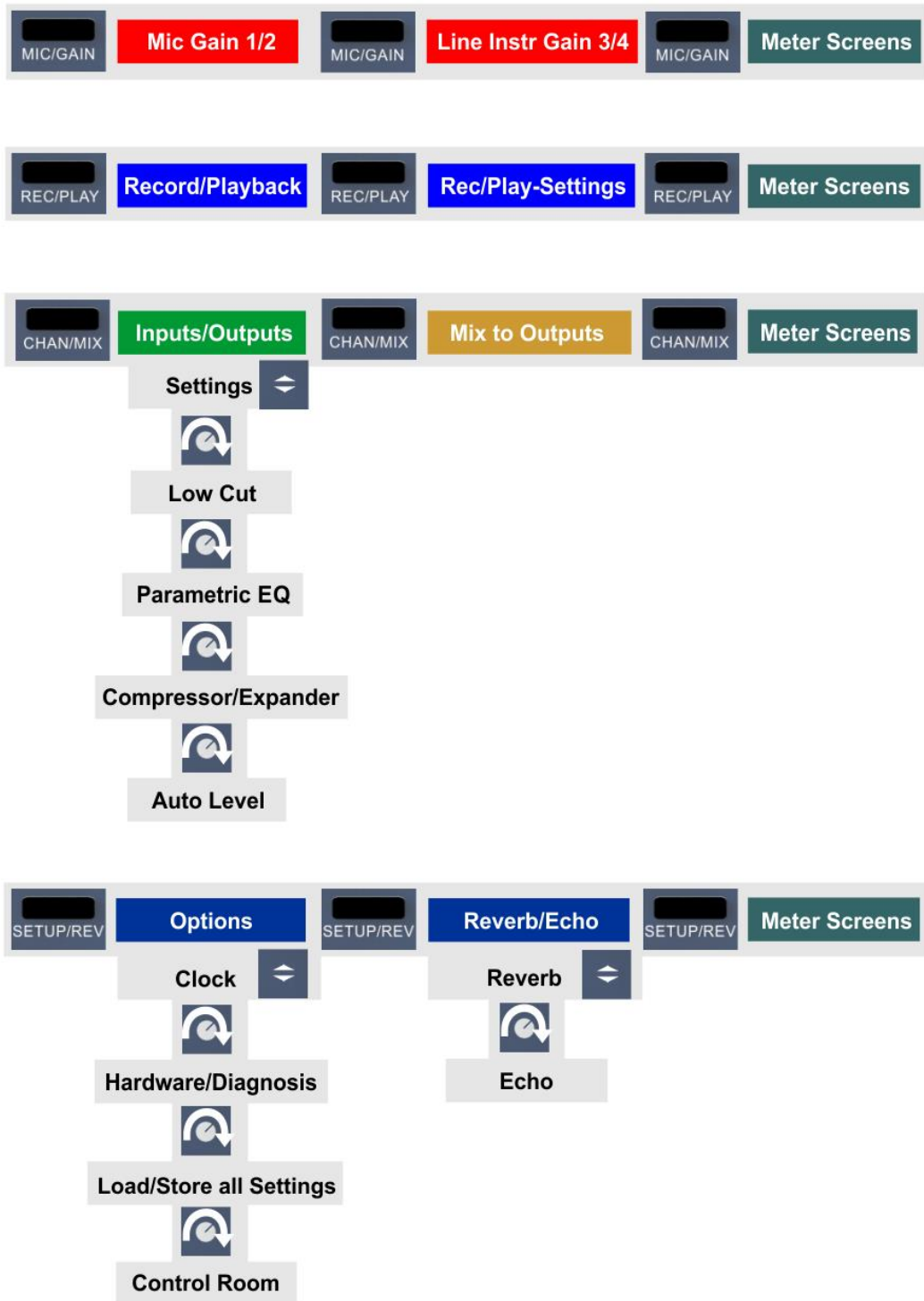

5.5 Special Options

In the menu *SETUP/REV - Options - Hardware/Diagnosis* there are some additional setting options which are not described elsewhere in this manual.

Standalone ARC. For the optional ARC USB (Advanced Remote Control), when connected directly to the UCX II, the following options are available:

Standalone ARC Volume. Deactivates all keys. Only the encoder wheel works, with a fixed assignment to Main Volume.

This option is also a safety function in case the ARC USB is connected to the UCX II, but operated online (with computer). When the system goes offline (computer removed, sleep state...) the functions on the keys change, because online mode changed to stand-alone mode. Operating the keys then could activate unintended functionality or changes.

Standalone ARC 1 s op

Each key has to be pressed for one second to activate the programmed functionality. This safety function prevents unintentional changes. It can be stored within the Setups, activating this mode automatically when such a Setup is loaded. When loading a Setup where this function had not been active this mode is automatically deactivated at the UCX II.

Standalone ARC normal

Normal operation of the ARC USB.

Lock Keys. OFF, KEYS, ALL. Press SETUP/REV key for 2 seconds to unlock.

Remap Keys. OFF, ON. Allows assigning 28 different functions/actions to the four quick select buttons on the device. The configuration is done in the following four entries:

MIC/GAIN, REC/PLAY, CHAN/MIX, SETUP/REV. Available functions/actions:

Default, Meter, Setup 1-6, DIM, Recall, Mute Enable, Main Mono, Main Mute, Main Out Low Cut, Main Out EQ, Main Out Dynamics, Main Out AutoLevel, Phones Mute, Phones Low Cut, Phones EQ, Phones Dynamics, Phones AutoLevel, Reverb enable, Echo enable, Record*, Play/Pause* Stop*, Previous*, Next*. (* DUREC functions).

The original function of the key on the device, calling up the menu, is still possible by pressing the key on the device for a longer time (0.5 s).

Level Meters. All, Analog. Global Level Meter or Analog Level Meter screen. Same function as pressing the VALUE encoder for half a second.

Scroll Type. cw up, cw down. Allows changing the scroll direction when turning the encoder.

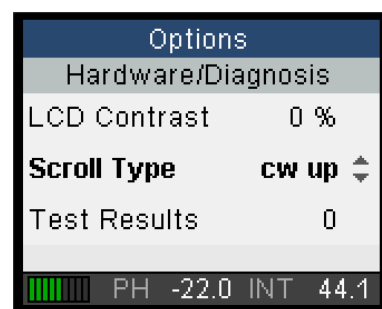

User's Guide



Fireface UCX II

► Installation and Operation – Windows

6. Hardware, Driver and Firmware Installation

6.1 Hardware and Driver Installation

To simplify installation it is recommended to first install the drivers before the unit is connected to the computer. But it will also work the other way round.

RME is constantly improving the drivers. Please download the latest drivers from the RME website. Driver version 4.30 or higher is available via <http://rme.to/downloads>. Unzip the downloaded file and start the driver installation with *rmeinstaller.exe*.

Start *rmeinstaller.exe* and follow the instructions of the installer. After installation connect computer and UCX II using a USB 2 cable. Windows detects the new hardware as **Fireface UCX II** and installs the drivers automatically.

After a reboot, the icons of TotalMix FX and Settings dialog appear in the notification area. If not a click on the chevron leads to the settings that control the icon display.

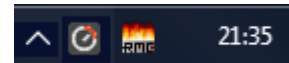

Driver Updates do not require to remove the existing drivers. Simply install the new driver over the existing one.

6.2 De-Installing the Drivers

A de-installation of the driver files is not necessary – and not supported by Windows anyway. Thanks to full Plug & Play support, the driver files will not be loaded after the hardware has been removed. If desired these files can then be deleted manually.

Unfortunately Windows Plug & Play methods do not cover the additional autorun entries of TotalMix, the Settings dialog, and the registration of the ASIO driver. Those entries can be removed from the registry through a software de-installation request. This request can be found (like all de-installation entries) in *Control Panel, Software*. Click on the entry 'RME MADiface'.

6.3 Firmware Update

The Flash Update Tool updates the firmware of the Fireface UCX II to the latest version. It requires an already installed driver.

Start the program **fut_usb.exe**. The Flash Update Tool displays the current revision of the Fireface firmware, and whether it needs an update or not. If so, then simply press the 'Update' button. A progress bar will indicate when the flash process is finished (Verify Ok).

After the update the unit needs to be reset. This is done by powering down the unit for a few seconds. A reboot of the computer is not necessary.

When the update unexpectedly fails (status: failure), the unit's Safety BIOS will be used from the next boot on, the unit stays fully functional. The flash process should then be tried again.

7. Configuring the Fireface – Settings Dialog

7.1 General

Configuration of the Fireface UCX II is done via its own settings dialog. The panel **Settings** can be opened by clicking on the fire or hammer symbol in the Task Bar's system tray.

The mixer of the Fireface UCX II, **TotalMix FX**, can be opened by clicking on the DSP FX symbol in the Task Bar's system tray

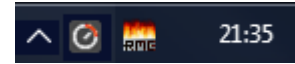

The hardware of the Fireface UCX II offers a number of helpful practical functions and options to suit many different requirements. The 'Settings' dialog includes options for:

- Latency
- Operation of the DSP
- Configuration of the digital I/Os
- Current sample rate
- Synchronization behaviour
- State of input and output

Any changes made in the Settings dialog are applied immediately - confirmation (e.g. by clicking on OK or exiting the dialog) is not required.

However, settings should not be changed during playback or record if it can be avoided, as this can cause unwanted noises. Also, please note that even in 'Stop' mode, several programs keep the recording and playback devices open, which means that any new settings might not be applied immediately.

The tab **About** includes information about the current driver and firmware version of the Fireface UCX II. **About** offers four more options:

Lock Registry

Default: off. Checking this option brings up a dialog to enter a password. Changes in the Settings dialog are no longer written to the registry. As the settings are always loaded from the registry when starting the computer, this method provides an easy way to define an initial state of the Fireface UCX II.

Enable MMCSS for ASIO activates support with higher priority for the ASIO driver. Note: At this time, activating this option seems to be useful only with the latest Cubase/Nuendo at higher load. With other software this option can decrease performance. The change becomes active after an ASIO reset. Therefore it is easy to quickly check which setting works better.

Sort ASIO Devices

Changes the order only of the ASIO channels when using more than one interface.

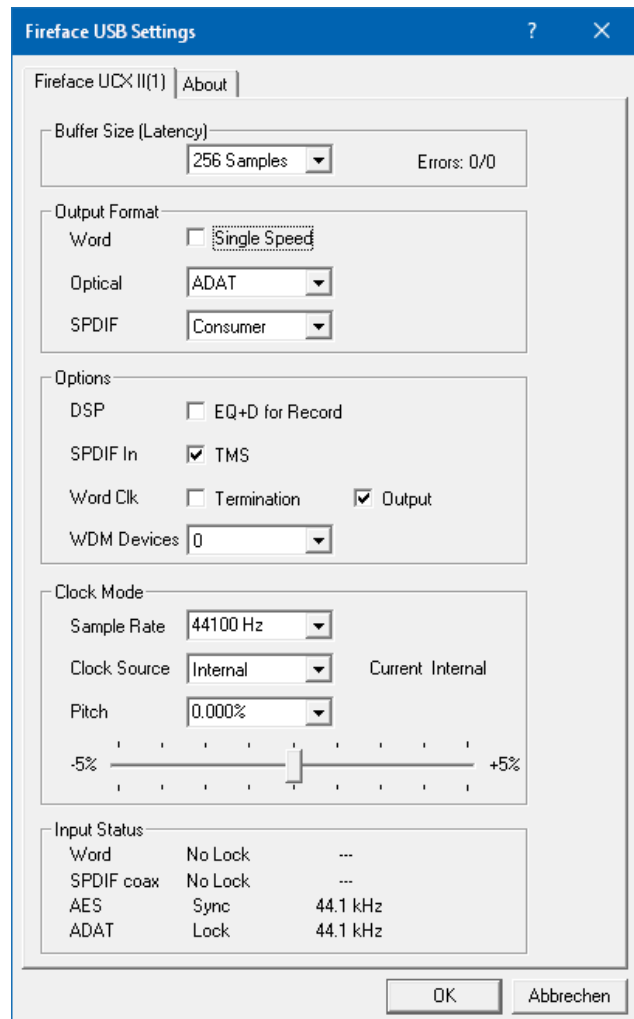

Buffer Size (Latency)

The setting *Buffer Size* determines the latency between incoming and outgoing ASIO and WDM data, as well as affecting system stability (see chapter 9.1).

USB Diagnosis indicates USB transmission errors. The display will be reset on any start of a playback/record. More information can be found in chapter 40.3.

Output Format

Word – Single Speed

The word clock output signal usually equals the current sample rate. Selecting *Single Speed* causes the output signal to always stay within the range of 32 kHz to 48 kHz. So at 96 kHz and 192 kHz sample rate, the output word clock is 48 kHz.

Optical

The optical TOSLINK output can operate as ADAT or SPDIF output. ADAT: includes channels ADAT 1 to 8. SPDIF: includes channels SPDIF opt. L/R, in TotalMix ADAT ½. In SPDIF mode Channel Status is fixed to Consumer.

SPDIF

The output SPDIF coaxial (RCA) can have the Channel Status Professional or Consumer. For further details please refer to chapter 21.3.

Options

DSP - EQ+D for Record

Switches EQ and Dynamics of all input channels into the recording path. In case Loopback has been activated the EQ and Dynamics of the Output channel are within the recording path. See also chapter 27.6.

TMS activates the transmission of Channel Status data and Track Marker information on AES and SPDIF inputs. In case these information are not required the feature should be turned off.

Word Clock In Termination

Checking this option terminates the word clock input internally with 75 Ohms.

Word Clock Output

This option switches the BNC socket into word clock output mode.

WDM Devices

Reduce the number of WDM devices to the ones really needed to improve performance of the operating system.

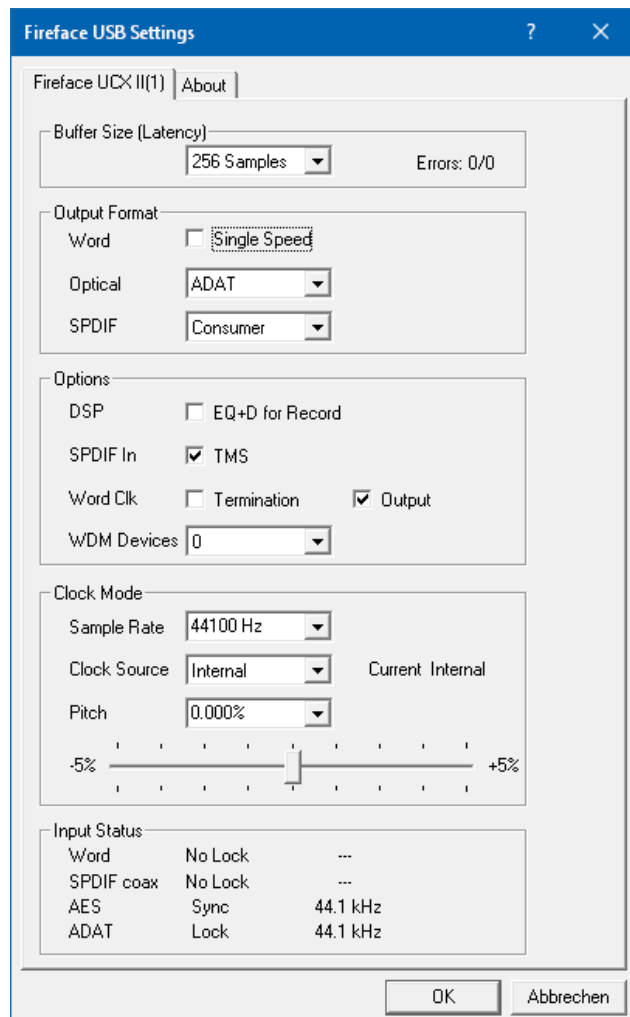

Clock Mode

Sample Rate

Sets the currently used sample rate. Offers a central and comfortable way of configuring the sample rate of all WDM devices to the same value, as since Vista the audio software is no longer allowed to set the sample rate. However, an ASIO program can still set the sample rate by itself.

During record/playback the selection is greyed out, so no change is possible.

Clock Source

The unit can be configured to use its own clock (Internal = Master), or one of the input signals (Word, SPDIF, AES, ADAT). If the selected source isn't available (Input Status No Lock), the unit will change to the next available one (AutoSync). If none is available then the internal clock is used. The current clock source is displayed to the right.

Pitch

More information on Pitch is available in chapter 7.2.

Input Status

Indicates for each input (Word, SPDIF coaxial, AES, ADAT) whether there is a valid signal (Lock, No Lock), or if there is a valid *and* synchronous signal (Sync). The third column shows the sample frequency detected by the hardware (coarse recognition, 32 kHz, 44.1 kHz, 48 kHz etc.).

7.2 Pitch

Usually soundcards and audio interfaces generate their internal clock (master mode) by a quartz. Therefore the internal clock can be set to 44.1 kHz or 48 kHz, but not to a value in between. SteadyClock, RME's sensational Low Jitter Clock System, is based on a Direct Digital Synthesizer (DDS). This superior circuitry can generate nearly any frequency with highest precision.

The section Pitch includes both a list of typical video frequencies (so called pull up/pull down at 0.1% and 4%) and a fader to freely change the basic sample rate in steps of 1 Hz (!) over a range of +/- 5%.

- ! *The Pitch function requires the Fireface to be in clock mode Master! The frequency setting will only be applied to this one specific Fireface!*
- ! *Changing the sample rate during record/playback often results in a loss of audio, or brings up warning messages of the audio software. Therefore the desired sample rate should be set at least coarsely before starting the software.*

Coarse

Coarse modification in steps of 50 Hz is done by clicking with the mouse to the left and right of the fader knob.

Fine

Fine modification in steps of 1 Hz is done by using the left/right cursor keys.

Reset

Ctrl key plus left mouse click.

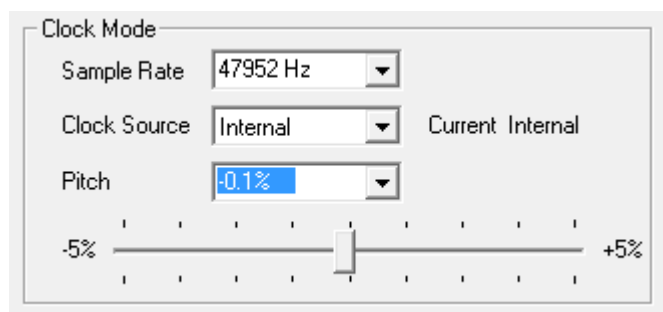

Application examples

Pitch allows for a simultaneous change of speed and tune during record and playback. From alignment to other sources up to creative effects – everything is possible.

Pitch enables you to intentionally de-tune the complete DAW. This way, the DAW can match instruments which have a wrong or unchangeable tuning.

7.3 Option WDM Devices

The area WDM Devices gives configuration access, a status display showing the number of currently enabled WDM devices, and a listbox to choose *Stereo* or *Multi-Channel* devices. The number represents both record and playback devices, so '1' means one input and one output device.

WDM streaming is Microsoft's current driver and audio system, directly embedded into the operating system.

Several programs do not offer any direct device selection. Instead they use the *playback device* selected in Windows under <Control Panel/ Sound/ Playback>.

! *Activating all 15 stereo devices at once may cause temporary freezing or 'not responding' effects. Therefore activate only the ones which are really needed.*

After leaving the dialog with OK the WDM devices are reloaded so Windows sees their new properties.

Multi-Channel using WDM

The WDM Streaming device *Loudspeaker* (Analog 1+2) of the RME driver can operate as usual stereo device, or as up to 8-channel device. Using a multi-channel WDM device allows for the use of multi-channel playback with specialized software as well as Surround sound from DVD or Blu-Ray player software.

An 8-channel playback using the Windows Media Player requires the speaker setup *7.1 Surround*. Configure as follows: >Control Panel /Sound /Playback /Loudspeaker /Configure <.

8. Operation and Usage

8.1 Playback

In the audio application being used, Fireface UCX II must be selected as output device. This can often be found in the *Options*, *Preferences* or *Settings* menus under *Playback Device*, *Audio Devices*, *Audio* etc.

! *WDM playback devices are not available if the number of WDM devices is set to 0 in the Settings dialog.*

We recommend switching all system sounds off (via >Control Panel /Sounds<). Although the Fireface UCX II comes with extensive support for system audio, setting it to be the *Default Device* for playback could cause problems when working with ASIO.

Increasing the number and/or size of audio buffers may prevent the audio signal from breaking up, but also increases latency i.e. output is delayed. For synchronized playback of audio and MIDI (or similar), be sure to activate the checkbox 'Get position from audio driver'.

Note: Since Windows Vista the audio application can no longer control the sample rate under WDM. Therefore the driver of the Fireface UCX II includes a way to set the sample rate globally for all WDM devices within the Settings dialog, see chapter 7.1. As the change within the system requires some time, record/playback should not be started immediately, but only after at least 5 seconds after a change.

Tip: the current CPU load can be used to determine if the audio subsystem has finished the re-configuration.

8.2 DVD-Playback (AC-3/DTS)

Popular DVD software players can send their audio data stream to any AC-3/DTS capable receiver via the Fireface UCX II SPDIF output.

! *The sample rate must be set to 48 kHz in the UCX II Settings dialog, or the software will only playback the down-mixed analog signal via SPDIF.*

In some cases an UCX II output device has to be selected in *>Control Panel / Sound / Playback<* and be set as *Default* for the software to recognize it.

The DVD software's audio properties now show the options 'SPDIF Out' or similar. When selecting it, the software will transfer the non-decoded digital multichannel data stream to the Fireface.

Note: This 'SPDIF' signal sounds like chopped noise at highest level. Try to avoid mixing and routing the signal to your loudspeakers, as they might get damaged.

Multichannel

DVD software player can also operate as software decoder, sending a DVD's multichannel data stream directly to the analog outputs of the Fireface UCX II. For this to work select the WDM playback device 'Loudspeaker' of the Fireface UCX II in *>Control Panel/ Sound/ Playback <* as *Default*.

The playback software's audio properties now list several multichannel modes. If one of these is selected, the software sends the decoded analog multichannel data to the Fireface UCX II. TotalMix can then be used to play back via any desired output channels.

The typical channel assignment for surround playback is:

1 – Left 2 – Right 3 – Center 4 - LFE (Low Frequency Effects)
5 - SL (Surround Left) 6 - SR (Surround Right)

Note 1: Selecting the Fireface to be used as system playback device is against our recommendation, as professional interfaces should not be disturbed by system events. Make sure to re-assign the selection after usage or to disable any system sounds (tab Sounds, scheme 'No audio').

Note 2: The DVD player will be synced backwards from the Fireface. This means when using AutoSync and/or word clock, the playback speed and pitch follows the incoming clock signal.

8.3 Channel Count under WDM

The Fireface ADAT optical ports support sample rates of up to 192 kHz. For this to work single-channel data is spread to two or four ADAT channels using the *Sample Multiplexing* technique. This reduces the number of available ADAT channels from 8 to 4 or 2 per ADAT port.

Whenever the Fireface changes into Double Speed (88.2/96 kHz) or Quad Speed mode (176.4/192 kHz) all devices no longer available vanish automatically.

WDM Stereo device	Double Speed	Quad Speed
Fireface Analog (1+2)	Fireface Analog (1+2)	Fireface Analog (1+2)
Fireface Analog (3+4)	Fireface Analog (3+4)	Fireface Analog (3+4)
Fireface Analog (5+6)	Fireface Analog (5+6)	Fireface Analog (5+6)
Fireface Analog (7+8)	Fireface Analog (7+8)	Fireface Analog (7+8)
Fireface SPDIF	Fireface SPDIF	Fireface SPDIF
Fireface AES	Fireface AES	Fireface AES
Fireface ADAT 1 (1+2)	Fireface ADAT 1 (1+2)	Fireface ADAT 1 (1+2)
Fireface ADAT 1 (3+4)	Fireface ADAT 1 (3+4)	Fireface ADAT 1 (3+4)
Fireface ADAT 1 (5+6)	Fireface ADAT 1 (5+6)	Fireface ADAT 1 (5+6)
Fireface ADAT 1 (7+8)	Fireface ADAT 1 (7+8)	Fireface ADAT 1 (7+8)

8.4 Multi-client Operation

RME audio interfaces support multi-client operation. Several programs can be used at the same time. The formats ASIO and WDM can even be used on the same playback channels simultaneously. But as WDM uses a real-time sample rate conversion (ASIO does not), all active ASIO software has to use the same sample rate.

However, a better overview is maintained by using the channels exclusively. This is no limitation at all, because TotalMix allows for any output routing, and therefore a playback of multiple software on the same hardware outputs.

Inputs can be used from an unlimited number of WDM and ASIO software at the same time, as the driver simply sends the data to all applications simultaneously.

RME's sophisticated tool *DIGICheck* is an exception to this rule. It operates like an ASIO host, using a special technique to access playback channels directly. Therefore DIGICheck is able to analyse and display playback data from any software, no matter which format it uses.

8.5 Analog Recording

For recordings via the analog inputs the corresponding record device has to be chosen (Fireface UCX II Analog (x+x)).

The input sensitivity of the rear inputs can be changed in two steps and with adjustable gain in TotalMix (Input Channel Settings, Level), assuring the highest signal to noise ratio will be achieved. A further optimization can be achieved by adjusting the source itself. Raise the source's output level until the peak level meters in TotalMix reach about -3 dB.

The level of the front-side analog inputs can be optimized via TotalMix (Input Channel Settings, Gain), or directly at the Fireface UCX II by the key Mic/Gain and the encoders 1/2. The multi-colour level meters shown on the display also provide useful information about the current level state.

Further information is found in chapter 19.

It often makes sense to monitor the input signal or send it directly to the output. This can be done at zero latency using **TotalMix FX** (see chapter 25).

An *automated* control of real-time monitoring can be achieved by Steinberg's ASIO protocol with RME's ASIO drivers and all ASIO 2.0 compatible programs. When 'ASIO Direct Monitoring' has been switched on, the input signal is routed in real-time to the output whenever a recording is started (punch-in).

8.6 Digital Recording

Unlike analog soundcards which produce empty wave files (or noise) when no input signal is present, digital interfaces always need a valid input signal to start recording.

Taking this into account, RME added a comprehensive I/O signal status display to the Fireface UCX II, showing sample frequency, lock and sync status for every input, and several status-fields in the unit's display.

The sample frequency shown in the fields Clock Mode and Input Status of the Settings dialog is useful as a quick display of the current configuration of the unit and the connected external equipment. If no sample frequency is recognized, it will read 'No Lock'.

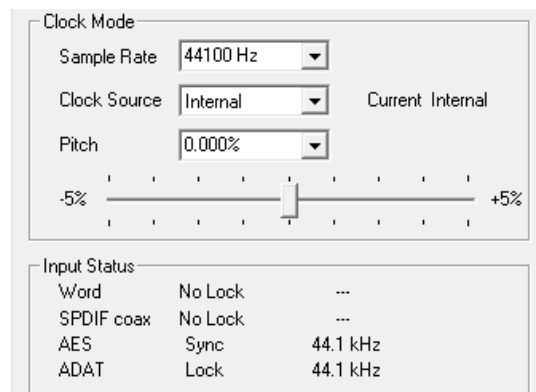

This way, configuring any suitable audio application for digital recording is simple. After selecting the correct input, Fireface UCX II displays the current sample frequency. This parameter can then be changed in the application's audio attributes (or similar) dialog.

8.7 Clock Modes - Synchronization

In the digital world, all devices must be either Master (clock source) or Slave (clock receiver). Whenever several devices are linked within a system, there must always be a single master clock.

! *A digital system can only have one master! If the Fireface's clock mode is set to 'Master', all other devices must be set to 'Slave'.*

The Fireface UCX II utilizes a very user-friendly, intelligent clock control, called **AutoSync**. In AutoSync mode, the system constantly scans the digital input for a valid signal. If any valid signal is found, the Fireface switches from the internal quartz (*Clock Source* – Current Internal) to a clock extracted from the input signal (*Clock Source* – Current ADAT, SPDIF, AES or Word). The difference to a usual slave mode is that whenever the clock reference fails, the system will automatically use its internal clock and operate in clock mode Master.

AutoSync guarantees that record and record-while-play will always work correctly. In certain cases however, AutoSync may cause feedback in the digital carrier, so synchronization breaks down. To remedy this, switch the Fireface clock mode to 'Internal'.

RME's exclusive **SyncCheck** technology enables an easy to use check and display of the current clock status. *SyncCheck* indicates whether there is a valid signal (Lock, No Lock) for each input (Word Clock, SPDIF, ADAT, AES), or if there is a valid *and* synchronous signal (Sync). See chapter 40.1.

Via *Clock Source* a preferred input can be defined. As long as the Fireface sees a valid signal there, this input will be designated as the sync source, otherwise the other inputs will be scanned in turn. If none of the inputs are receiving a valid signal, the Fireface automatically switches clock mode to 'Internal'.

Under WDM the Fireface will (has to) set the sample rate. Therefore the error shown to the right can occur. An AES, SPDIF or ADAT signal with a sample rate of 48 kHz is used as sync source, but Windows audio had been set to 44100 Hz before. The red color of the text label signals the error condition, and prompts the user to set 48000 Hz manually as sample rate.

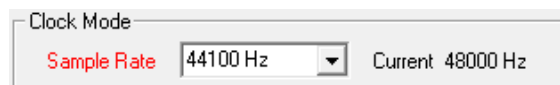

Under ASIO the audio software sets the sample rate, so that such an error will usually not happen – but it can too. In slave mode the external sample rate has priority. Feeding 44.1 kHz will prevent the ASIO software to set 48 kHz – obviously, as the only way to do so would be to enter a different clock mode (Master/Internal).

In practice, SyncCheck provides the user with an easy way of checking whether all digital devices connected to the system are properly configured. With SyncCheck, finally anyone can master this common source of error, previously one of the most complex issues in the digital studio world.

9. Operation under ASIO

9.1 General

Start the ASIO software and select **ASIO MADiface USB** as the audio I/O device or the ASIO audio driver.

The Fireface UCX II supports *ASIO Direct Monitoring* (ADM).

The Fireface UCX II MIDI I/Os can be used with both MME MIDI and DirectMusic MIDI.

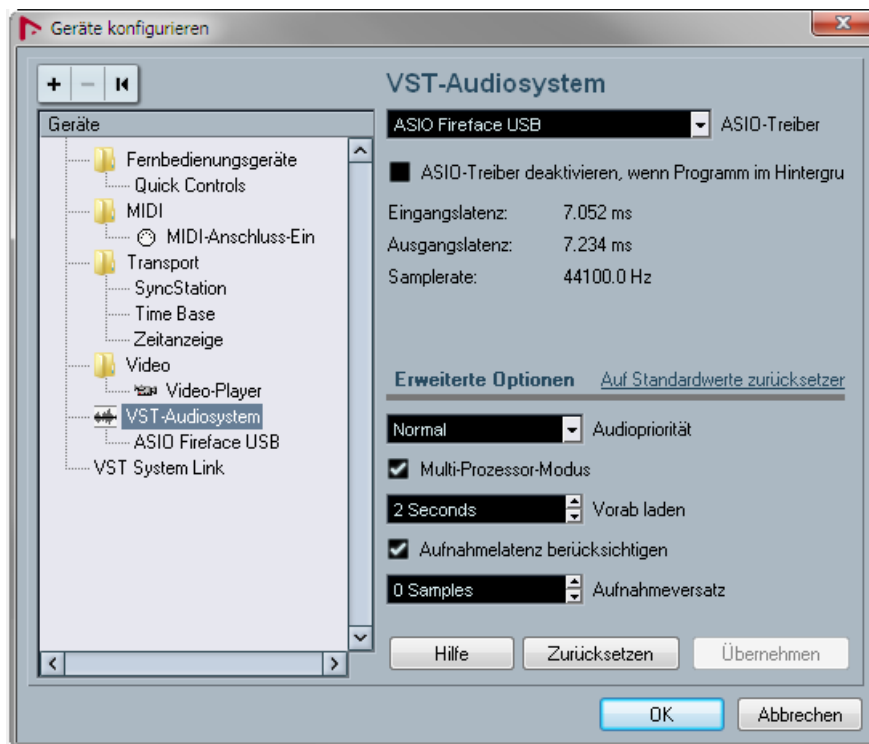

9.2 Channel Count under ASIO

At a sample rate of 88.2 or 96 kHz, the ADAT optical input and outputs operate in S/MUX mode, so the number of available channels per port is reduced from 8 to 4. At a sample rate of 176.4 and 192 kHz, the ADAT optical input and output operates in S/MUX4 mode, so the number of available channels is limited to 2.

Note: When changing the sample rate range between Single, Double and Quad Speed the number of channels presented from the ASIO driver will change too. This may require a reset of the I/O list in the audio software.

Single Speed	Double Speed	Quad Speed
Fireface Analog 1 to 8	Fireface Analog 1 to 8	Fireface Analog 1 to 8
Fireface SPDIF L / R	Fireface SPDIF L / R	Fireface SPDIF L / R
Fireface AES L / R	Fireface AES L / R	Fireface AES L / R
Fireface ADAT 1 to 8	Fireface ADAT 1 to 4	Fireface ADAT 1 to 2

9.3 Known Problems

If a computer does not provide sufficient CPU-power, and/or sufficient USB or PCI bus transfer rates, and/or sufficient PCIe-bus transfer rates, then drop outs, crackling and noise will appear. Raising the buffer size in the Settings dialog of the Fireface UCX II helps in most cases. It is also recommended to deactivate all PlugIns to verify that these are not the reason for such effects. Further information is found in chapter 40.3.

Another common source of trouble is incorrect synchronization. ASIO does not support asynchronous operation, which means that the input and output signals not only have to use the same sample frequency, but also have to be in sync. All devices connected to the Fireface UCX II must be properly configured for full duplex operation. As long as SyncCheck (in the Settings dialog) only displays *Lock* instead of *Sync*, the devices have not been set up properly.

The same applies when using more than one Fireface UCX II - they all have to be in sync. Else a periodically repeated noise will be heard.

RME devices support *ASIO Direct Monitoring (ADM)*. Please note that not all programs support ADM completely or error-free. The most often reported problem is the wrong behaviour of panorama in a stereo channel. Also try to avoid setting the TotalMix FX hardware outputs (third row) to mono mode. This will most likely break ADM compatibility.

In case of a drift between audio and MIDI, or in case of a fixed deviation (MIDI notes placed close before or behind the correct position), the settings in Cubase/Nuendo have to be changed. At the time of print the option 'Use System Timestamp' should be activated. The Fireface UCX II supports both MME MIDI and DirectMusic MIDI. It depends on the used application which one will work better.

10. Using more than one Fireface UCX II

The driver supports up to three Fireface UCX II or a combination of up to three supported interfaces. All units have to be in sync, i.e. have to receive valid sync information (either via word clock or by using AutoSync and feeding synchronized signals).

- If one of the Firefaces is set to clock mode Master, all others have to be set to clock mode AutoSync, and have to be synced from the master, for example by feeding word clock. The clock modes of all units have to be set up correctly in the Fireface Settings dialog.
- If all units are fed with a synchronous clock, i.e. all units show *Sync* in their Settings dialog, all channels can be used at once. This is especially easy to handle under ASIO, as the ASIO driver presents all units as one.

Please be aware that operating more than one Fireface UCX II may cause resource problems on the computer side.

Note: TotalMix is part of the hardware of each Fireface. Up to three mixers are available, but these are separated and can't interchange data. Therefore a global mixer for all units is not possible.

11. DIGICheck Windows

The DIGICheck software is a unique utility developed for testing, measuring and analysing digital audio streams. Although this Windows software is fairly self-explanatory, it still includes a comprehensive online help. DIGICheck 5.94 operates as multi-client ASIO host, therefore can be used in parallel to any software, be it WDM or ASIO, with both inputs and outputs (!). The following is a short summary of the currently available functions:

- **Level Meter.** High precision 24-bit resolution, 2/8/20 channels. Application examples: Peak level measurement, RMS level measurement, over-detection, phase correlation measurement, dynamic range and signal-to-noise ratios, RMS to peak difference (loudness), long term peak measurement, input check. Oversampling mode for levels higher than 0 dBFS. Vertical and horizontal mode. Slow RMS and RLB weighting filter. Supports visualization according to the K-System.
- **Hardware Level Meter for Input, Playback and Output.** Reference Level Meter freely configurable, causing near zero CPU load, because calculated from the Fireface hardware.
- **Spectral Analyser.** World wide unique 10-, 20- or 30-band display in analog bandpass-filter technology. 192 kHz-capable!
- **Vector Audio Scope.** World wide unique Goniometer showing the typical afterglow of a oscilloscope-tube. Includes Correlation meter and level meter.
- **Totallyser.** Spectral Analyser, Level Meter and Vector Audio Scope in a single window.
- **Surround Audio Scope.** Professional Surround Level Meter with extended correlation analysis, ITU weighting and ITU summing meter.
- **ITU1770/EBU R128 Meter.** For standardized loudness measurements.
- **Bit Statistics & Noise.** Shows the true resolution of audio signals as well as errors and DC offset. Includes Signal to Noise measurement in dB and dBA, plus DC measurement.
- **Channel Status Display.** Detailed analysis and display of SPDIF and AES/EBU Channel Status data.
- **Global Record.** Long-term recording of all channels at lowest system load.
- **Completely multi-client.** Open as many measurement windows as you like, on any channels and inputs or outputs!

DIGICheck is free but works only with RME interfaces. It is constantly improved and updated. The latest version is always available on our website www.rme-audio.com, section **Downloads / Software**.

12. Hotline – Troubleshooting

The newest information can always be found on our website www.rme-audio.com, section FAQ, Latest Additions.

The 8 ADAT channels don't show up at the optical output

- The optical output has been switched to 'SPDIF'. The ADAT playback devices are still usable by routing and mixing them in TotalMix to other outputs.

Playback works, but record doesn't

- Check that there is a valid signal at the input. If so, the current sample frequency is displayed in the Settings dialog.
- Check whether the Fireface UCX II has been selected as recording device in the audio application.
- Check whether the sample frequency set in the audio application ('Recording properties' or similar) matches the input signal.
- Check that cables/devices have not been connected in a closed loop. If so, set the system's clock mode to Master.

Crackle during record or playback

- Increase the number and size of buffers in the 'Settings' dialog or in the application.
- Try different cables (coaxial or optical) to rule out any defects here.
- Check that cables/devices have not been connected in a closed loop. If so, set the system's clock mode to 'Master'.
- Check the Settings dialog for displayed Errors.

Driver installation and Settings dialog/TotalMix work, but a playback or record is not possible

- While recognition and control of the device are low bandwidth applications, playback/record needs the full transmission performance. Therefore, defective USB cables with limited transmission bandwidth can cause such an error scheme.

User's Guide



Fireface UCX II

- ▶ **Installation and Operation – Mac OS X**

13. Hardware, Driver and Firmware Installation

13.1 Hardware and Driver Installation

After the Fireface has been connected to the computer and switched on install the drivers.

RME is constantly improving the drivers. Please download the latest drivers from the RME website at <http://rme.to/downloads>. Unzip the downloaded file and start the driver installation by double-clicking **Fireface USB.pkg**.

During driver installation the programs **Totalmix** (TotalMix FX) and **Fireface USB Settings** are copied to the Applications folder. They will automatically start into the dock if a Fireface UCX II is connected. A reboot of the computer is not required.

Driver Updates do not require to remove the existing drivers. Simply install the new driver over the existing one.

- ! For the latest M1 drivers for macOS please read the included readme carefully, as on such machines the driver installation requires additional steps to enable third party kernel extensions

13.2 De-installing the Drivers

In case of problems the driver files can be deleted manually by dragging them to the trash bin:

USB

/Applications/Fireface USB Settings

/Applications/Totalmix

/System/Library/Extensions/FirefaceUSB.kext

/Users/username/Library/Preferences/de.rme-audio.TotalmixFX.plist

/Users/username/Library/Preferences/de.rme-audio.Fireface_USB_Settings.plist

/Library/LaunchAgents/de.rme-audio.firefaceUSBAgent.plist

Under the latest Mac OS the User/Library folder is not visible in the Finder. To unhide it start Finder, click on the menu item Go. Hold down the option (alt) key, then click on Library.

13.3 Firmware Update

The Flash Update Tool updates the firmware of the Fireface UCX II to the latest version. It requires an already installed Thunderbolt or USB driver.

Start the program **Fireface USB Flash**. The Flash Update Tool displays the current revision of the UCX II firmware, and whether it needs an update or not. If so, simply press the 'Update' button. A progress bar will indicate when the flash process is finished (Verify Ok).

After the update the Fireface UCX II needs to be reset. This is done by powering down the Fireface for a few seconds. A reboot of the computer is not necessary.

When the update fails (status: failure), the unit's second BIOS will be used from the next cold boot on (Secure BIOS Technology). Therefore the unit stays fully functional. The flash process should then be tried again on a different computer.

14. Configuring the Fireface UCX II

14.1 Settings Dialog

Configuring the Fireface is done via its own settings dialog. Start the program **Fireface USB Settings**. The mixer of the Fireface UCX II (TotalMix FX) can be configured by starting the program **Totalmix**.

The Fireface's hardware offers a number of helpful, practical functions and options to suit many different requirements. The following is available in the 'Settings' dialog:

- Operation of the DSP
- Configuration of digital I/Os
- Current sample rate
- Synchronization behaviour
- State of input and output

Any changes performed in the Settings dialog are applied immediately - confirmation (e.g. by exiting the dialog) is not required.

However, settings should not be changed during playback or record if it can be avoided, as this can cause unwanted noises.

Use the drop down menu **Properties For** to select the unit to be configured.

On the right of it the current firmware and driver version of the Fireface UCX II is shown.

Input Options

Word Clock Input

This option switches the BNC socket into word clock input mode

Word Clock - Termination

Checking this option terminates the word clock input internally with 75 Ohms.

DSP – Record EQ+D

Switches EQ and Dynamics of all input channels into the recording path. In case Loopback has been activated the EQ and Dynamics of the Output channel are within the recording path. See also chapter 27.6.

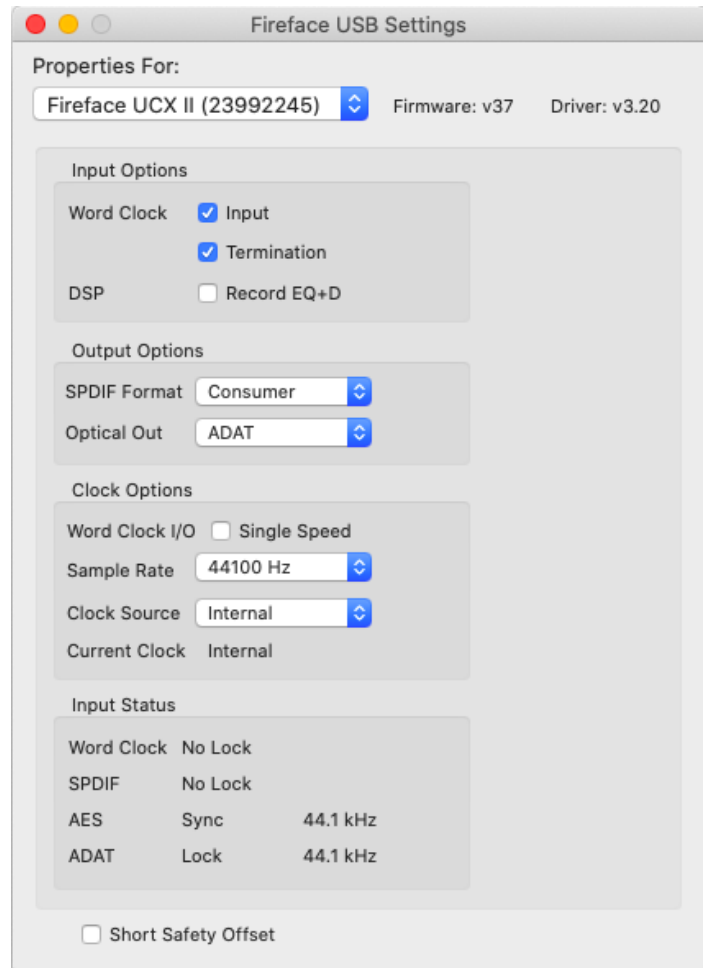

Output Options

SPDIF Format

The SPDIF coaxial output signal can have the Channel Status Professional or Consumer. For further details please refer to chapter 21.3.

Optical Out

The optical TOSLINK output can operate as ADAT or SPDIF output.

Clock Options

Word Clock I/O – Single Speed

The word clock output signal usually equals the current sample rate. Selecting *Single Speed* causes the output signal to always stay within the range of 32 kHz to 48 kHz. So at 96 kHz and 192 kHz sample rate, the output word clock is 48 kHz.

The word clock input usually adapts to the current sample rate range. For example a 48 kHz word clock signal can be used to sync the internal clock of 96 and 192 kHz. When the option *Single Speed* is **not** checked the interface's sample rate follows the external sample rate directly. A word signal of 192 kHz will cause the UCX II to use 192 kHz internally. This feature is also called *Follow Clock*.

Sample Rate

Used to set the current sample rate. This is the same setting as in the Audio MIDI Setup, just added here for your convenience.

Clock Source

The unit can be configured to use its own clock (Internal = Master), or one of the input signals (Word, SPDIF, AES, ADAT). If the selected source isn't available (Input Status No Lock), the unit will change to the next available one (AutoSync). If none is available then the internal clock is used. The current clock source is displayed below.

Input Status

Indicates for inputs Word, SPDIF, AES and ADAT whether a valid signal (Lock, No Lock) or a valid *and* synchronous signal (Sync) is present. The third column shows the sample frequency detected by the hardware (coarse recognition, 32 kHz, 44.1 kHz, 48 kHz etc.).

Short Safety Offset

Reduces overall latency by using smaller Safety Offsets (12 samples instead of 24 samples). Change is performed in real-time. Smaller Safety Offsets might cause clicks and dropouts.

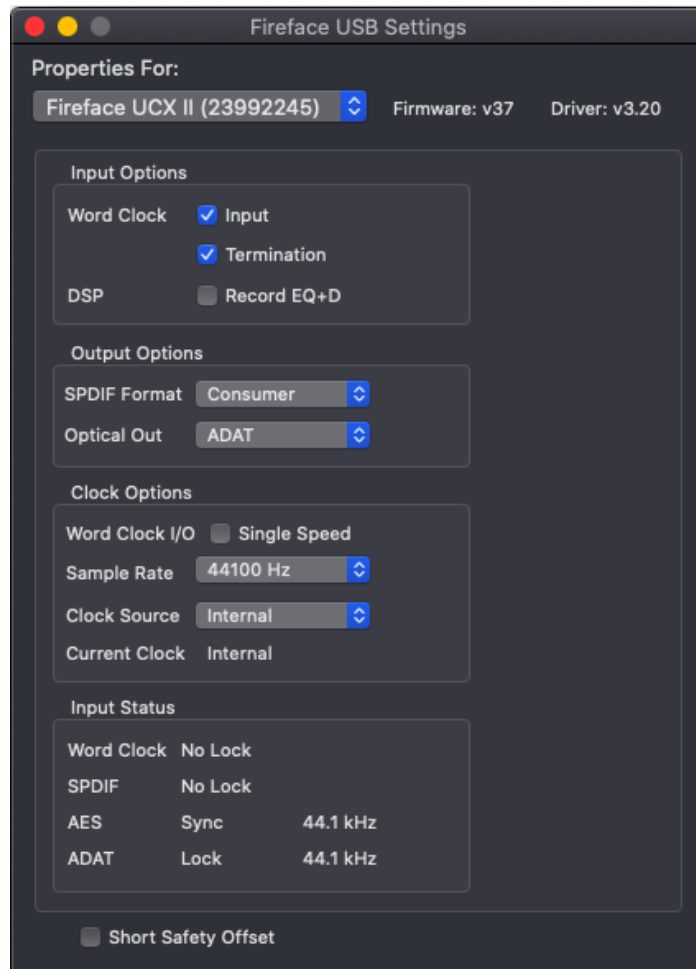

14.2 Clock Modes - Synchronization

In the digital world, all devices must be either Master (clock source) or Slave (clock receiver). Whenever several devices are linked in a system, there must always be a single master clock.

! *A digital system can only have one master! If the Fireface's clock mode is set to 'Master', all other devices must be set to 'Slave'.*

The Fireface UCX II utilizes a very user-friendly, intelligent clock control, called **AutoSync**. In AutoSync mode, the system constantly scans the digital input for a valid signal. If any valid signal is found, the Fireface switches from the internal quartz (*Clock Mode* – Current Internal) to a clock extracted from the input signal (*Clock Mode* – Current SPDIF, ADAT, AES or Word). The difference to a usual slave mode is that whenever the clock reference fails, the system will automatically use its internal clock and operate in clock mode Master.

AutoSync guarantees that record and record-while-play will always work correctly. In certain cases however, AutoSync may cause feedback in the digital carrier, so synchronization breaks down. To solve this problem switch the Fireface clock mode to 'Internal'.

RME's exclusive **SyncCheck** technology enables an easy to use check and display of the current clock status. *SyncCheck* indicates whether there is a valid signal (Lock, No Lock) for each input (Word Clock, SPDIF, ADAT, AES), or if there is a valid *and* synchronous signal (Sync). In the field *Clock Mode* the clock reference is shown. See chapter 40.1.

Via *Clock Source* a preferred input can be defined. As long as the Fireface sees a valid signal there, this input will be designated as the sync source, otherwise the other inputs will be scanned in turn. If none of the inputs are receiving a valid signal, the Fireface automatically switches clock mode to 'Internal'.

In some situations changing the clock mode can not be avoided. Example: An ADAT recorder is connected to the ADAT input (ADAT immediately becomes the AutoSync source) and a CD player is connected to the AES input. Try recording a few samples from the CD and you will be disappointed - few CD players can be synchronized. The samples will inevitably be corrupted, because the signal from the CD player is read with the clock from the ADAT. In this case the Clock Source should be temporarily set to *AES*.

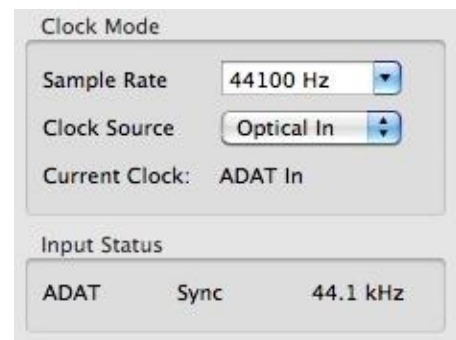

In practice, SyncCheck provides the user with an easy way of checking whether all digital devices connected to the system are properly configured. With SyncCheck, finally anyone can master this common source of error, previously one of the most complex issues in the digital studio world.

15. Mac OS X FAQ

15.1 MIDI doesn't work

In some cases the applications do not show the MIDI port. The reason for this is usually visible within the **Audio MIDI Setup**. It displays no RME MIDI device, or the device is greyed out and therefore inactive. Mostly, removing the greyed out device and searching for MIDI devices again will solve the problem.

The Fireface' MIDI is class compliant. Therefore it comes without a driver. OS X recognizes it as MIDI device and will be using it with the driver included in the operating system.

15.2 Repairing Disk Permissions

Repairing permission can solve problems with the installation process - plus many others. To do this, launch **Disk Utility** located in **Utilities**. Select your system drive in the drive/volume list to the left. The **First Aid** tab to the right now allows you to check and repair disk permissions.

15.3 Supported Sample Rates

RME's Mac OS X driver supports all sampling frequencies provided by the hardware. This includes **32 kHz** and **64 kHz**, and even **128 kHz**, **176.4 kHz** and **192 kHz**.

But not any software will support all the hardware's sample rates. The hardware's capabilities can easily be verified in the **Audio MIDI Setup**. Select **Audio devices** under **Properties of:** and choose the Fireface. A click on **Format** will list the supported sample frequencies.

15.4 Channel Count under Core Audio

At a sample rate of 88.2 or 96 kHz, the ADAT optical input and outputs operate in S/MUX mode, so the number of available channels per port is reduced from 8 to 4. At a sample rate of 176.4 and 192 kHz, the ADAT optical input and output operates in S/MUX4 mode, so the number of available channels is limited to 2.

It is not possible to change the number of Core Audio channels without a reboot of the computer. Therefore whenever the Fireface changes into Double Speed (88.2/96 kHz) or Quad Speed mode (176.4/192 kHz) all channels stay present, but become partly inactive.

Single Speed	Double Speed	Quad Speed
Fireface Analog 1 to 8	Fireface Analog 1 to 8	Fireface Analog 1 to 8
Fireface SPDIF	Fireface SPDIF	Fireface SPDIF
Fireface AES	Fireface AES	Fireface AES
Fireface ADAT 1 to 8	Fireface ADAT 1 to 4	Fireface ADAT 1 to 2

15.5 Various Information

Programs that don't support card or channel selection will use the device chosen as **Input** and **Output** in the **System Preferences – Sound** panel.

Via **Launchpad – Other – Audio MIDI Setup** the Fireface can be configured for the system wide usage in more detail.

Programs that don't support channel selection will always use channels 1/2, the first stereo pair. To access other inputs, use the following workaround with TotalMix: route the desired input signal to output channels 1/2. In the channel settings of outputs 1/2 activate *Loopback*. Result: the desired input signal is now available at input channel 1/2, without further delay/latency.

Use **Configure Speakers** to freely configure the stereo or multichannel playback to any available channels.

16. Using more than one Fireface

OS X supports the usage of more than one audio device within an audio software. This is done via the Core Audio function **Aggregate Devices**, which allows to combine several devices into one.

The current driver supports up to three Fireface UCX II. All units have to be in sync, i.e. have to receive valid sync information either via word clock or by feeding synchronized signals.

- If one of the Firefaces is set to clock mode Master, all others have to be set to clock mode Slave, and have to be synced from the master, for example by feeding word clock. The clock modes of all units have to be set up correctly in the Fireface Settings dialog.
- If all units are fed with a synchronous clock, i.e. all units show *Sync* in their Settings dialog, all channels can be used at once.

Note: TotalMix is part of the Fireface hardware. Up to three mixers are available, but these are separated and can't interchange data. Therefore a global mixer for all units is not possible.

Please be aware that operating more than one Fireface UCX II may cause resource problems on the computer side.

17. DIGICheck NG Mac

The DIGICheck software is a unique utility developed for testing, measuring and analysing digital audio streams. Although the software is fairly self-explanatory, it still includes a comprehensive online help. DIGICheck NG 0.86 operates in parallel to any software, showing all input data. The following is a short summary of the currently available functions:

- **Level Meter.** High precision 24-bit resolution, 2/8/20 channels. Application examples: Peak level measurement, RMS level measurement, over-detection, phase correlation measurement, dynamic range and signal-to-noise ratios, RMS to peak difference (loudness), long term peak measurement, input check. Oversampling mode for levels higher than 0 dBFS. Vertical and horizontal mode. Slow RMS and RLB weighting filter. Supports visualization according to the K-System.
- **Hardware Level Meter for Input, Playback and Output.** Reference Level Meter freely configurable, causing near zero CPU load, because calculated from the Fireface hardware.
- **Spectral Analyser.** World wide unique 10-, 20- or 30-band display in analog bandpass filter technology. 192 kHz-capable!
- **Vector Audio Scope.** World wide unique Goniometer showing the typical afterglow of a oscilloscope-tube. Includes Correlation meter and level meter.
- **Totalyser.** Spectral Analyser, Level Meter and Vector Audio Scope in a single window.
- **Surround Audio Scope.** Professional Surround Level Meter with extended correlation analysis, ITU weighting and ITU summing meter.
- **ITU1770/EBU R128 Meter.** For standardized loudness measurements.
- **Bit Statistics & Noise.** Shows the true resolution of audio signals as well as errors and DC offset. Includes Signal to Noise measurement in dB and dBA, plus DC measurement.
- **Completely multi-client.** Open as many measurement windows as you like, on any channels and inputs or outputs!

DIGICheck is constantly updated. The latest version is always available on our website www.rme-audio.com, section **Downloads / DIGICheck**.

18. Hotline – Troubleshooting

The newest information can always be found on our website www.rme-audio.com, section FAQ, latest Additions.

The unit and drivers have been installed correctly, but playback does not work:

- Has Fireface been selected as current playback device in the audio application?

The 8 ADAT channels don't seem to work

- The optical output ADAT has been switched to SPDIF. The ADAT playback devices are still usable by routing and mixing them in TotalMix to other outputs.

Playback works, but record doesn't:

- Check that there is a valid signal at the input. If so, the current sample frequency is displayed in the Settings dialog.
- Check whether the Fireface UCX II has been selected as recording device in the audio application.
- Check whether the sample frequency set in the audio application ('Recording properties' or similar) matches the input signal.
- Check that cables/devices have not been connected in a closed loop. If so, set the system's clock mode to 'Master'.

Crackle during record or playback:

- Increase the number and size of buffers in the application.
- Try different cables (coaxial or optical) to rule out any defects here.
- Check that cables/devices have not been connected in a closed loop. If so, set the system's clock mode to 'Master'.
- Check the Settings dialog for displayed Errors.

Possible causes for a Fireface not working

- The USB cable is not, or not correctly inserted into the socket

Driver installation and Settings dialog/TotalMix work, but a playback or record is not possible

- While recognition and control of the device are low bandwidth applications, playback/record needs the full transmission performance. Therefore, defective USB cables with limited transmission bandwidth can cause such an error scheme.



User's Guide



Fireface UCX II

► Inputs and Outputs

19. Analog Inputs

19.1 Line Rear

The Fireface has four balanced Line inputs as 1/4" TRS jacks on the back of the unit. The electronic input stage is built in a servo balanced design which handles unbalanced (mono jacks) and balanced (stereo jacks) correctly, automatically adjusting the level reference.

- ! *When using unbalanced cables with TRS jacks: be sure to connect the 'ring' contact of the TRS jack to ground. Otherwise noise may occur, caused by the unconnected negative input of the balanced input.*

One of the main issues when working with an AD-converter is to maintain the full dynamic range within the best operating level. Therefore the Fireface UCX II internally uses hi-quality electronic switches, which allow for a perfect adaptation of all rear inputs individually to the most often used studio levels. The Fireface UCX II offers the following level references:

Reference	0 dBFS @	Max Gain	0 dBFS @
+19 dBu	+19 dBu	12 dB	+7 dBu
+13 dBu	+13 dBu	12 dB	+1 dBu

A reference level of +4 dBu can be set by using +13 dBu and adding 9 dB of gain with the Gain knob in the TotalMix FX channel settings.

19.2 Microphone / Line Front

The two balanced microphone inputs of the Fireface UCX II offer a digitally controlled gain of 0 to 75 dB via XLR/TRS combo jacks. The gain range is 0 to 75 dB, adjustable in steps of 1 dB. The soft switching, hi-current Phantom power (48 Volt), switchable per channel, provides a professional handling of condenser mics. Up to a level of +18 dBu, the front XLR input can also be used as balanced and unbalanced Line input.

The TRS jacks of the two combo jacks are free of phantom power and fully compatible to unbalanced (mono jack) sources. They have a fixed level attenuation of 6 dB. The maximum input level is therefore +24 dBu, balanced and unbalanced.

Channels 1 to 4 feature an automatic overload protection. **AutoSet** tries to keep a headroom of 6 dB. Levels higher than -6 dBFS will permanently reduce the gain. To check set the channels to a high gain and apply an input signal. The button will quickly rotate back to a gain that is appropriate.

While with extreme overloads distortion will occur for the fraction of a second before the level is set correctly, AutoSet works quite well in real-world applications and prevents distorted recordings reliably.

Using stereo channels AutoSet operates ganged. AutoSet can be activated in TM FX or directly at the unit in the channel settings. A push on Encoder 1/2 toggles AS on/off.

As soon as AutoSet reduces the gain the label AS, shown in the front display, changes its colour from black to blue.

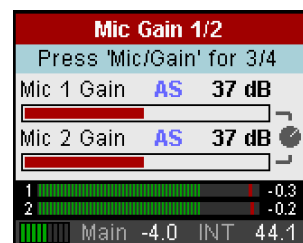

19.3 Instrument / Line Front

Inputs 3/4 of the Fireface UCX II are exceptionally flexible. Several gain and impedance options make them the ideal receivers for both line and instrument signals.

Line

Inputs 3/4 have balanced line inputs as 1/4" TRS jacks. The electronic input stage is built in a servo balanced design which handles unbalanced (mono jacks) and balanced (stereo jacks) correctly, automatically adjusting the level reference.

Inputs 3/4 operate in perfect harmony with the rear inputs 5 to 8, as they are identical in all technical specifications.

Adjustable Input Gain

Via **Gain** in TotalMix channel settings, or by using the rotary encoder on the front, an additional gain can be applied to the input signals of channels 3/4. The gain range is 0 dB up to 12 dB, in steps of 0.5 dB. This option not only allows for the use of sources with low level output signals, but also for example to adjust the balance between channel 3 and 4 precisely, already before the recording takes place.

Two reference levels plus 12 dB adjustable gain offer universal connectivity. Be it keyboards, samplers, CD players or what ever one likes to connect: These inputs handle levels from +1 dBu up to +19 dBu and also perfectly handle your

Instrument

The main difference between a line- and instrument input is the input's impedance. Via the option **Inst** in the TotalMix channel settings, the input impedance changes from 10 kOhm to 1 MOhm (also called Hi-Z). At the same time the input sensitivity rises by 6 dB.



The instrument input operates unbalanced. Please don't use (stereo) TRS jacks in that mode.

For **AutoSet** please read chapter 19.2.

20. Analog Outputs

20.1 Line

The short circuit protected, low impedance line outputs of channels 1 to 6 are available as 1/4" TRS jacks on the back of the unit. The electronic output stage is built in a servo balanced design which handles unbalanced (mono jacks) and balanced (stereo jacks) correctly.

To maintain an optimum level for devices connected to the analog outputs, the Fireface UCX II internally uses hi-quality electronic switches, which allow for a perfect adaptation of all outputs individually to the three most often used studio levels.

As with the analog inputs, the analog output levels are defined to maintain a problem-free operation with most other devices.

Reference	0 dBFS @	Older RME units
+19 dBu	+19 dBu	Hi Gain/Lo Gain (15 dB HR)
+13 dBu	+13 dBu	+4 dBu (9 dB HR)
+4 dBu	+4 dBu	-10 dBV (12 dB HR)

In older RME devices, the references refer to a working level plus headroom (HR). In the UCX II the maximum level is used as name instead, which is less confusing in our opinion. The levels of the table are identical in each respective case and thus fully compatible.

20.2 Headphones / Line Out

Channels 7/8 of the Fireface are available on the front as 1/4" TRS jack. These channels use the same converters as the other Line outputs, therefore offer the same technical data.

Two hardware-based reference levels are available (set in TotalMix Output Channel Settings, Level, High or Low). High equals the setting +19 dBu of the other channels, Low equals +4 dBu (see table above). They can thus also be used as high-quality, unbalanced line outputs.

These outputs are special low impedance types (1 Ohms), perfectly suited for headphone use.

Setting the output level, i.e. the monitoring volume, is done – besides the pre-setting High/Low - via TotalMix (Hardware Output, Phones) or directly at the unit via the encoder. Changing the monitoring volume is therefore very easy and quickly done.

In case the Phones output should operate as line outputs, an adapter TRS plug to RCA phono plugs, or TRS plug to TS plugs is required.

The pin assignment follows international standards. The left channel is connected to the tip, the right channel to the ring of the TRS jack/plug.

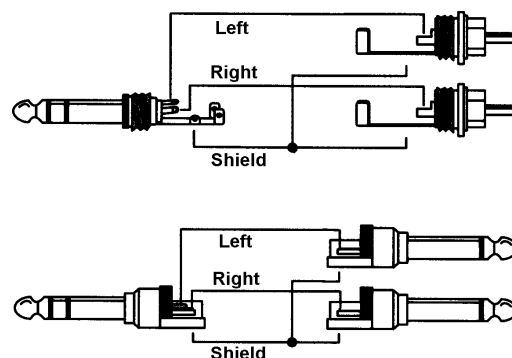

20.3 DC-coupled Outputs (CV/Gate)

All eight analog outputs of the UCX II are DC-coupled. AC coupling via capacitor is common, both directly after the DAC chip and directly at the output socket. This prevents a fixed DC component at the output, which could cause negative effects such as popping noise or malfunctions in other devices that are also DC-coupled. However, it also serves as protection against dangerous DC from the outside.

DC coupling has the obvious advantage of allowing the output to operate level-linearly down to 0 Hz. Even at extremely low bass (16 Hz) phase shifts are avoided. DC-coupled inputs are rare, especially for power amplifiers, so a possible DC offset of a playback normally does not cause serious issues.

In order to realize the outputs stable and reliable (robust) as DC-coupled, the circuitry was designed for low DC-offsets and sufficient overvoltage protection. That this works has been proven for years, not only by RME's ADI series.

To be able to generate DC is quite useful in measurement technology, also in connection with audio. However, DC coupling is especially desirable in combination with analog, electronic sound generators (synthesizers). These have an input that can control the pitch as well as other functions via a DC voltage. Control Voltage, short CV, often also CV/Gate (gate determines tone on or off), CV Filter etc. is mostly based on the voltage range 0 to +5 Volt. If an audio interface can output such DC voltages then synthesizers can be controlled via suitable software and the analog outputs of the audio interface.

The DA converters and analog output stages used in the UCX II have a very low DC drift and generate the DC voltages very reliably and reproducibly, so they are very well suited for this application.

Polarity - Phase

Since the outputs (of course) have a correct polarity, and TotalMix fully supports DC (via fader and level meter), a positive voltage appears at the analog output when a digital positive DC is played. The amount of voltage can be measured accurately and directly with any cheap multimeter.

- ! *Negative output voltages should be avoided, because they could theoretically lead to defects in the CV input. Even if the software used generates only positive signals, a simple phase inversion in TotalMix can invert the signal so that a negative voltage is send out.*

Voltage Ranges

Line Out 1-6, unbalanced (mono jack), unloaded:

+19 dBu: +9.5 V, +13 dBu: +4.75 V, +4 dBu: +1.7 V

Phones 7/8, unbalanced, unloaded:

High (+19 dBu): +9.5 V, Low (+4 dBu): +1.7 V

Note: The level meters in TotalMix show DC 3 dB higher due to its factory default setting. This can be changed by disabling the *Settings - Level Meters - RMS +3 dB* option in TotalMix FX.

21. Digital Connections

21.1 ADAT

The ADAT optical input of the Fireface UCX II is fully compatible with all ADAT optical outputs. RME's unsurpassed Bitclock PLL prevents clicks and drop outs even in extreme varipitch operation, and guarantees a fast and low jitter lock to the digital input signal. A usual TOSLINK cable is sufficient for connection.

ADAT In

Interface for receiving an ADAT signal. Carries the channels 1 to 8. When receiving a Double Speed signal, this input carries the channels 1 to 4, at Quad Speed the channels 1 and 2.

ADAT Out

Interface for sending an ADAT signal. Transmits channels 1 to 8. When sending a Double Speed signal, this port carries channels 1 to 4, at Quad Speed the channels 1 and 2. Can also be used as a 2-channel SPDIF optical output.

21.2 AES/EBU

The Fireface UCX II's digital breakout cable (BO968) provides one XLR AES/EBU input and output each. Connection is accomplished using balanced cables with XLR plugs. Input and Output are transformer-balanced and ground-free. The incoming channel status is ignored.

AES/EBU (and SPDIF) can contain Emphasis information. Audio signals with Emphasis have a high frequency boost, requiring high frequency attenuation on playback.

! *An Emphasis indication gets lost as there exists no standardized interface on computers to handle this information!*

Operation as second SPDIF I/O

Thanks to a highly sensitive input stage SPDIF coaxial can be fed too by using a simple cable adapter RCA/XLR. To achieve this, pins 2 and 3 of a male XLR plug are connected individually to the two pins of a RCA plug. The cable shielding is only connected to pin 1 of the XLR - not to the RCA plug.

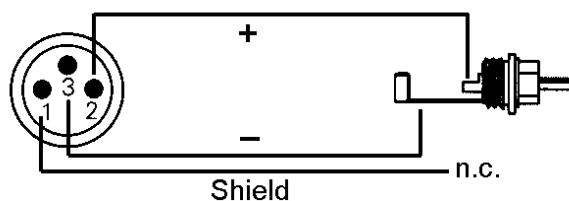

Using the cable adapter XLR/RCA described above, devices with coaxial SPDIF interface can be connected to the AES output of the Fireface UCX II as well. Note that most consumer equipment with phono (SPDIF) inputs will only accept signals having a Channel Status *Consumer*. In such cases the above adapter cable will not work.

21.3 SPDIF (Coaxial, Optical)

The Fireface UCX II has up to three SPDIF inputs and outputs: coaxial, optical and AES can be used simultaneously, with different audio signals. Note that the sources have to be synchronous, as the unit does not have a dedicated sample rate converter.

The SPDIF coaxial input accepts SPDIF and AES/EBU, Consumer as well as Professional format.

To receive signals in AES/EBU format, an adapter cable is required. Pins 2 and 3 of a female XLR plug are connected individually to the two pins of a phono plug. The cable shielding is connected to pin 1 of the XLR and the ground contact of the phono plug.

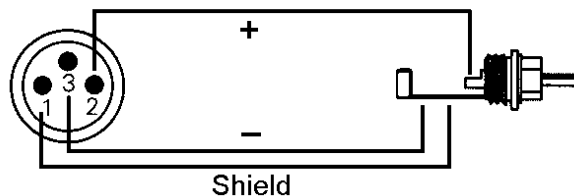

The optical input automatically switches to SPDIF operation when such a signal is detected. The audio information is then shown in TotalMix on the first two ADAT channels ADAT 1/2, which are channels 13 and 14.

SPDIF coaxial Output

Apart from the audio data itself, digital signals in SPDIF or AES/EBU format have a header containing channel status information. False channel status is a common cause of malfunction. The Fireface UCX II ignores the received header and creates a totally new one for the output signal. The output SPDIF coaxial can have the Channel Status Consumer or Professional, changed in the Settings dialog. When selecting Professional, the carrier level is also doubled for better AES/EBU compatibility.

Operation as second AES/EBU Output

Professional AES/EBU equipment can be connected to the output SPDIF coaxial thanks to its format option *Professional* and a doubled output voltage. Output cables should have the same pinout as those used for input (see above), but with a male XLR plug instead of a female one.

SPDIF optical output

To send out SPDIF from the optical output, select the option *Output Format Optical – SPDIF* in the Settings dialog. The output signal in TotalMix has to be present on the ADAT channels 1/2.

! *Note that most consumer HiFi equipment (with optical or phono SPDIF inputs) will only accept signals in 'Consumer' format!*

Therefore in SPDIF mode the optical output is fixed to Consumer status.

21.4 MIDI

Fireface UCX II offers one MIDI I/O via two 5-pin DIN sockets. The MIDI ports are added to the system by the driver. Using MIDI capable software, these ports can be accessed under the name *UCX II MIDI Port*.

The MIDI ports support multi-client operation. A MIDI input signal can be received from several programs at the same time. Even the MIDI output can be used by multiple programs simultaneously. However, due to the limited bandwidth of MIDI, this kind of application will often show various problems.

Note: The MIDI input indicator displays any kind of MIDI activity, including MIDI Clock, MTC and Active Sensing. The latter is sent by most keyboards every 0.3 seconds.

22. Word Clock

22.1 Word Clock Input / Output

SteadyClock guarantees an excellent performance in all clock modes. Based on the highly efficient jitter suppression, the Fireface refreshes and cleans up any clock signal, and provides it as reference clock at the BNC output (see chapter 40.8).

The Fireface UCX II has one BNC socket with dual functionality – it can serve as word clock input OR word clock output. The current mode is set in the Settings dialog by the user.

Input Mode

The Fireface's word clock input is active when the BNC socket has been switched to input mode in the Settings dialog, and a valid word clock signal is present. The signal at the BNC input can be Single, Double or Quad Speed, the Fireface UCX II automatically adapts to it. As soon as a valid signal is detected, the WCK field is lit, and the Settings dialog shows either Lock or Sync (see chapter 40.1).

Thanks to RME's *Signal Adaptation Circuit*, the word clock input still works correctly even with heavily mis-shaped, dc-prone, too small or overshoot-prone signals. Thanks to automatic signal centering, 300 mV (0.3V) input level is sufficient in principle. An additional hysteresis reduces sensitivity to 1.0 V, so that over- and undershoots and high frequency disturbances don't cause a wrong trigger.

The Fireface UCX II word clock input can be high impedance or internally terminated (75 Ohms). The state is comfortably selected within the Settings dialog. To terminate the input check the option *Word Clock In Termination* under *Options*.

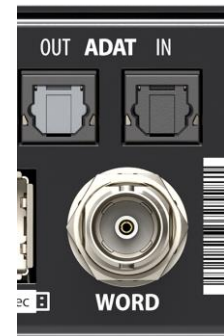

Output Mode

The same BNC socket can be used as word clock output instead of input, again configured in the Settings dialog. The word clock output is constantly active, providing the current sample frequency as word clock signal. As a result, in Master mode the provided word clock is defined by the currently used software. In Slave mode the provided frequency is identical to the one present at the currently chosen clock source. When the current clock signal fails, the Fireface UCX II switches to Master mode and adjusts itself to the next, best matching frequency (44.1 kHz, 48 kHz etc.).

Selecting *Single Speed* in the Settings dialog causes the output signal to always stay within the range of 32 kHz to 48 kHz. So at 96 kHz and 192 kHz sample rate, the output word clock is 48 kHz.

Thanks to a low impedance, short circuit proof output, the Fireface delivers 4 Vpp to 75 Ohms. For wrong termination with 2 x 75 Ohms (37.5 Ohms), there are still 3.3 Vpp at the output.

22.2 Technical Description and Usage

In the analog domain one can connect any device to another device, a synchronization is not necessary. Digital audio is different. It uses a clock, the sample frequency. The signal can only be processed and transmitted when all participating devices share the same clock. If not, the signal will suffer from wrong samples, distortion, crackle sounds and drop outs.

AES/EBU, SPDIF and ADAT are self-clocking, an additional word clock connection in principle isn't necessary. But when using more than one device simultaneously problems are likely to happen. For example any self-clocking will not work in a loop cabling, when there is no 'master' (main clock) inside the loop. Additionally the clock of all participating devices has to be synchronous. This is often impossible with devices limited to playback, for example CD players, as these have no SPDIF input, thus can't use the self clocking technique as clock reference.

In a digital studio synchronisation is maintained by connecting all devices to a central sync source. For example the mixing desk works as master and sends a reference signal, the word clock, to all other devices. Of course this will only work as long as all other devices are equipped with a word clock or sync input, thus being able to work as slave (some professional CD players indeed have a word clock input). Then all devices get the same clock and will work in every possible combination with each other.

! *A digital system can only have one master! If the Fireface's clock mode is set to 'Master', all other devices must be set to 'Slave'.*

But word clock is not only the 'great problem solver', it also has some disadvantages. The word clock is based on a fraction of the really needed clock. For example SPDIF: 44.1 kHz word clock (a simple square wave signal) has to be multiplied by 256 inside the device using a special PLL (to about 11.2 MHz). This signal then replaces the one from the quartz crystal. Big disadvantage: because of the high multiplication factor the reconstructed clock will have great deviations called jitter. The jitter of a word clock is typically 15 times higher as when using a quartz based clock.

The actual end of these problems is offered by the **SteadyClock** technology of the Fireface UCX II. Combining the advantages of modern and fastest digital technology with analog filter techniques, re-gaining a low jitter clock signal of 22 MHz from a slow word clock of 44.1 kHz is no problem anymore. Additionally, jitter on the input signal is highly rejected, so that even in real world usage the re-gained clock signal is of highest quality.

22.3 Cabling and Termination

Word clock signals are usually distributed in the form of a network, split with BNC T-adapters and terminated with resistors. We recommend using off-the-shelf BNC cables to connect all devices, as this type of cable is used for most computer networks. You will find all the necessary components (T-adapters, terminators, cables) in most electronics and/or computer stores. The latter usually carries 50 Ohms components. The 75 Ohms components used for word clock are part of video technology (RG59).

Ideally, the word clock signal is a 5 Volt square wave with the frequency of the sample rate, of which the harmonics go up to far above 500 kHz. To avoid voltage loss and reflections, both the cable itself and the terminating resistor at the end of the chain should have an impedance of 75 Ohm. If the voltage is too low, synchronization will fail. High frequency reflection effects can cause both jitter and sync failure.

Unfortunately there are still devices on the market which provide a word clock output that can only be called unsatisfactory. If the output breaks down to 3 Volts when terminating with 75 Ohms, you have to take into account that a device, of which the input only works from 2.8 Volts and above, does not function correctly already after 3 meter cable length. So it is not astonishing that because of the higher voltage, word clock networks are in some cases more stable and reliable if cables are not terminated at all. In some cases the 75 Ohms are built into the device and cannot be switched off. In this case the network load is often 2 x 75 Ohms, and the user is forced to buy a special word clock distributor (such a device is generally recommended for bigger studios).

Therefore it seems of advantage to design outputs of word clock as low impedance types, but all word clock inputs as high impedance types, in order to not weaken the signal on the chain.

The Fireface's word clock input can be high-impedance or terminated internally, ensuring maximum flexibility. If termination is necessary (e.g. because the Fireface is the last device in the chain), check the option *Word Clock In Term.* under *Options* (see chapter 7.1 / 14.1).

In case the UCX II resides within a chain of devices receiving word clock, plug a T-adapter into its BNC input jack, and the cable supplying the word clock signal to one end of the adapter. Connect the free end to the next device in the chain via a further BNC cable. The last device in the chain should be terminated using another T-adapter and a 75 Ohm resistor (available as short BNC plug). Of course devices with internal termination do not need T-adaptor and terminator plug.

22.4 Operation

The field WCK on the display will light up green as soon as a word clock signal is detected. To change to word clock as clock source, activate the Clock Source Word in the field Clock Mode within the Settings dialog. The status display *Current* changes to *Word* as soon as a valid signal is present at the BNC jack. This message has the same meaning as the green State field, but appears on the monitor, i.e. the user can check immediately whether a valid word clock signal is present and is currently being used.

User's Guide



Fireface UCX II

▶ Stand-Alone Operation

23. Operation and Usage

23.1 General

Using the rotary encoder, the four buttons and the clear colour display the Fireface UCX II can be configured and set up completely at the device. Additionally internal memory allows for the permanent storage of six different states of the unit. Therefore the Fireface UCX II is able to operate fully stand-alone, without any connected computer. In stand-alone operation it can transform into totally different devices by the simple click of a button. Furthermore TotalMix FX, and with this the application examples shown below, can also be controlled via MIDI, see chapter 28.6, *Stand-Alone MIDI Control*.

23.2 Settings at the Unit

The Fireface UCX II has a simple menu structure, depending on the button pressed.

MIC/GAIN. First push brings up the *Mic.Gain 1/2*, second push *Line/Instr. Gain 3/4*, third push returns to the meter screen.

REC/PLAY. Brings up the *Record/Playback* (Direct USB Recording) menu, second *Rec/Play Settings*, third push returns to the meter screen.

CHAN/MIX. First push brings up the *Channel* menu, second push the *Mix to* menu, third push returns to the meter screen.

The *Mix to* menu gives access to the whole submix functionality, mix destination and source. A source can be modified in mix level and panorama.

SETUP/REV. First push brings up the Options menu with access to the subpages *Clock*, *Load/Store all Settings*, *Hardware/Diagnosis* and *Control Room*. Second push brings up *Reverb/Echo* with the subpages *Reverb* and *Echo*.

23.3 Store / Load Setups at the Unit

After hitting the key SETUP/REV, the encoder gives access to the subpage Load/Store all Settings. First select the preferred memory slot, then the desired process (load or store). The load/store process is completed by pushing the encoder for more than one second.

The UCX II has six memory slots for free usage. Three fixed slots offer convenient and quick reset and configuration of the unit:

Factory. Sets the unit into factory default state.

AD/DA. Configures an ADAT analog to digital and vice versa converter (8 analog I/Os).

Clear Mix. Performs a Total Reset of TotalMix FX.

23.4 Storing Setups from the Computer

Setups can be loaded into the unit from the computer. As the Setups are usually generated at the computer the final step of transmission offers a convenient workflow. In TotalMix FX use *Options / Store current state into device* to select the desired storage place (Setup) within the unit.

24. Examples

24.1 8-Channel AD/DA-Converter

TotalMix' super-flexible routing functions make it easy to turn the UCX II into an 8-channel AD/DA converter, analog from/to ADAT.

It's easy to build the setup. For a clean start perform a *Total Reset* from the Options menu. Then select the ADAT Output 1/2 in the third row, and pull up the fader of the Analog input 1/2 in the first row. Then select ADAT 3/4, pull up Analog 3/4 and so on until all 8 analog inputs are routed to the corresponding (8) ADAT channels.

Now do the same for the analog outputs: select Analog Output 1/2 and move the fader of ADAT Input 1/2 to 0 dB, and so on. An additional monitoring of all or selected I/Os can be easily set up for any digital output, or as analog mixdown on the the phones output.

24.2 2-Channel Mic Preamp

Use TotalMix to route the two microphone inputs directly to the analog outputs. This turns the Fireface UCX II into a 2-channel microphone preamp. The AD- and DA-conversion will cause a small delay of the signals of around 0.1 ms (at 192 kHz, see chapter 40.2). But this is nothing to worry about, as it is the same delay that would be caused by changing the microphone's position by about 3.3 centimeter (1.3 inches).

24.3 Monitor Mixer

TotalMix allows ANY configuration of all I/Os of the Fireface. For example, set up the device as monitor mixer for 8 analog signals, 8 digital via ADAT, 2 via AES and 2 via SPDIF. Additionally, TotalMix lets you set up ANY submixes, so all existing outputs can be used for different and independent monitorings of the input signals. The perfect headphone monitor mixer!

24.4 Digital Format Converter

As TotalMix allows for any routing of the input signals, the Fireface UCX II can be used as ADAT to AES converter, ADAT to AES/SPDIF and AES/SPDIF to ADAT converter.

24.5 Analog / Digital Routing Matrix

The Matrix in TotalMix enables you to route and link all inputs and outputs completely freely. All the above functionalities are even available simultaneously, can be mixed and combined in many ways. Simply said: the Fireface UCX II is a perfect analog/digital routing matrix!

24.6 Stand-Alone Recorder/Player

The UCX II can be used for recording as well as playback of audio signals. As all settings are available directly at the unit it is possible to record a live concert completely without a computer. Music that was copied to a USB thumb drive before can be played back any time. Of course both in combination to any of the other examples above!

User's Guide



Fireface UCX II

► TotalMix FX

25. Routing and Monitoring

25.1 Overview

The Fireface UCX II includes a powerful digital real-time mixer, the *Fireface UCX II mixer*, based on RME's unique, sample-rate independent **TotalMix** technology. It allows for practically unlimited mixing and routing operations, with all inputs and playback channels simultaneously, to any hardware outputs. **TotalMix FX** adds 3-band parametric Equalizer, Low Cut, Echo, Reverb, Compressor, Expander and Auto Level.

Here are some typical applications for TotalMix:

- Setting up delay-free submixes (headphone mixes). The Fireface UCX II allows for up to 10 fully independent stereo submixes. On an analog mixing desk, this would equal 20 Aux sends.
- Unlimited routing of inputs and outputs (free utilisation, patchbay functionality).
- Distributing signals to several outputs simultaneously. TotalMix offers state-of-the-art splitter and distributor functions.
- Simultaneous playback of different programs via a single stereo output. The ASIO multi-client driver supports the usage of several programs at the same time. If this happens on different playback channels TotalMix provides the means to mix and monitor these on a single stereo output.
- Mixing of the input signal to the playback signal (complete ASIO Direct Monitoring). RME is not only *the* pioneer of ADM, but also offers the most complete implementation of the ADM functions.
- Integration of external devices. Use TotalMix to insert external effects devices, be it in the playback or in the record path. Depending on the current application, the functionality equals insert or effects send and effects return, for example as used during real-time monitoring when adding some reverb to the vocals.

Every single input channel, playback channel and hardware output features a Peak and RMS level meter, calculated in hardware. These level displays are very useful to determine the presence and routing destinations of the audio signals.

For a better understanding of the TotalMix mixer you should know the following:

- As shown in the block diagram (next page), the record signal usually stays un-altered. TotalMix does not reside within the record path, and does not change the record level or the audio data to be recorded (exceptions: *EQ+D for Record* and *Loopback* mode).
- The hardware input signal can be passed on as often as desired, even with different levels. This is a big difference to conventional mixing desks, where the channel fader always controls the level for all routing destinations simultaneously.
- The level meters of input and playback channels are connected pre-fader, to be able to visually monitor where a signal is currently present. The level meters of the hardware outputs are connected post-fader, thus displaying the actual output level.

RME TotalMix FX
 Fireface UCX II
 Mixer Overview
 Block Diagram, 05/2021

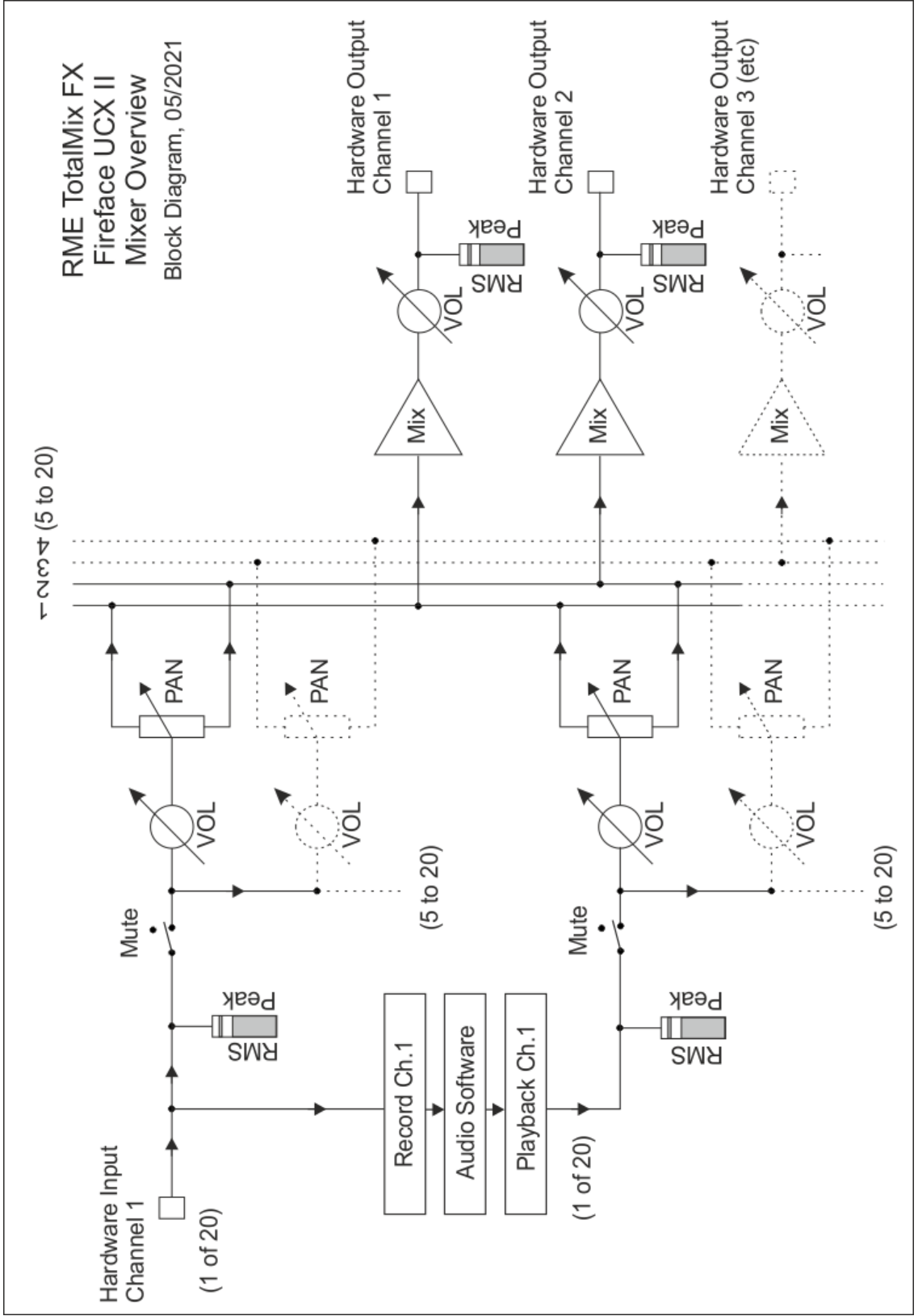

25.2 The User Interface

The visual design of the TotalMix mixer is a result of its capability to route hardware inputs and software playback channels to any hardware output. The Fireface UCX II has 20 input channels, 20 software playback channels, and 20 hardware output channels:

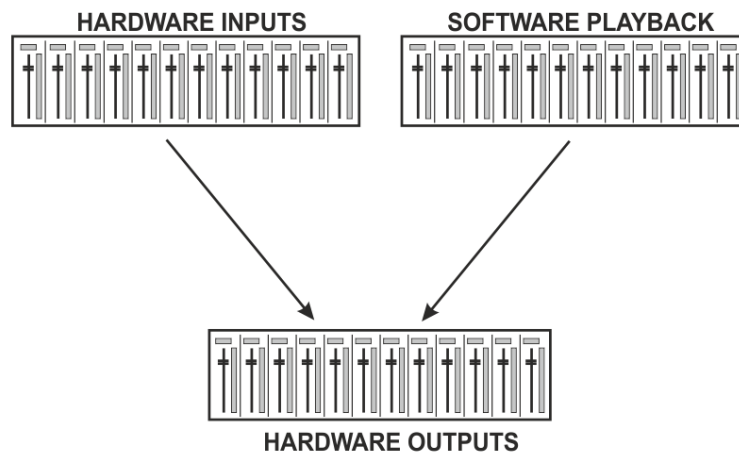

TotalMix can be used in the above view (View Options **2 Rows**). However, the default is a vertical alignment in three rows as known from an Inline desk, so that the row *Software Playback* equals the *Tape Return* of a real mixing desk:

- Top row: Hardware inputs. The level shown is that of the input signal, i.e. fader independent. Via fader and routing menu, any input channel can be routed and mixed to any hardware output (bottom row).
- Middle row: Playback channels (playback tracks of the audio software). Via fader and routing menu, any playback channel can be routed and mixed to any hardware output (bottom row).
- Bottom row: Hardware outputs. Here, the total level of the output can be adjusted. This may be the level of connected loudspeakers, or the level of any submix.

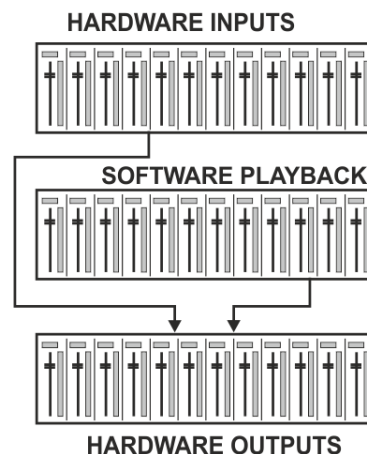

Usage in mode Submix View (Default)

Click on the Hardware Output channel in the third row where the audio signal is supposed to show up. This channel turns brighter, means it is selected as current submix. Now move the faders up from all sources – these are the input and playback channels, in the first and second row. That's it. The input (monitoring) and playback (DAW software) audio signals are now available at that very output, which can be verified immediately from the level meters reacting accordingly.

The following chapters explain step by step all functions of the user interface.

25.3 The Channels

A single channel can be switched between mono and stereo mode. The mode is set in the channel settings.

Channel name. The name field is the preferred place to select a channel by a mouse click. A double click opens a dialog to assign a different name. The original name will be shown when activating the option *Names* in the View Options.

Panorama. Routes the input signal freely to the left and right routing destination (lower label, see below). The level reduction in center position is -3 dB.

Mute and Solo. Input channels and playback channels each have a mute and solo button.

Numerical level display. Shows the current RMS or Peak level, updated twice per second. OVR means overload. The setting Peak/RMS is changed in the View Options.

Level meter. The meter shows both peak values (zero attack, 1 sample is enough for a full scale display) by means of a yellow line, and mathematically correct RMS values by means of a green bar. The RMS display has a relatively slow time constant, so that it shows the average loudness quite well. Overs are shown in red at the top of the bar. In the Preferences dialog (F2) the Peak Hold time, the over detection and the RMS reference can be set.



Fader. Determines the gain/level of the signal routed to the current routing destination (lower label). Please note that this fader is not *the* fader of the channel, but only the fader of the current routing. Compared to a standard mixing desk TotalMix does not have a channel fader, but only Aux Sends, as many as there are hardware outputs. Therefore TotalMix can create as many different Submixes as there are hardware outputs. This concept is understood best in the Submix View, but more on that later.

Below the fader the **Gain** is shown in a numerical display field, according to the current fader position. The fader can be:

- dragged with the left mouse button pressed
- moved by the mouse wheel
- set to 0 dB and $-\infty$ by a double click. The same happens with a single click plus held down Ctrl key.
- adjusted in fine mode by mouse drag and mouse wheel when holding the Shift key down

A Shift-click on a fader adds the fader to the **temporary fader group**. All faders now marked yellow are ganged, and move simultaneously in a relative way. The temporary fader group is deleted by a click on the F symbol in the upper right of the window.



The **arrow symbol** at the bottom minimizes the channel width to that of the level meters. Another click maximizes it again. A mouse click with held Ctrl key causes all channels to the right to enlarge and minimize at once.

The lowest field shows the current **routing target**. A mouse click opens the routing window to select a routing target. The list shows all activated routings of the current channel by arrows in front of the listed entries, the current one is shown in bold letters.

An arrow is only shown with an activated routing. A routing is seen as activated when audio data is sent. As long as the fader is set to $-\infty$ the current routing will be shown in bold letters, but not have an arrow in the front.



Trim Gain. After a click on the **T**-button one channel's faders are all synchronized. Instead of changing only a single routing the fader affects all the channel's active routings. For a better overview the faders currently not visible are indicated by orange triangles beside the fader path. When moving the fader the triangles also move to a new position, equalling the invisible faders' new settings.

Note that the fader button is automatically set to the highest routing gain of all routings so that best control is offered. The gain (fader knob position) of the currently active routing (the submix selected in the third row) is shown as white triangle.

Background: TotalMix has no fixed channel fader. In case of the Fireface UCX II there are 20 mono Aux sends, shown alternately as single fader within the channel strip. The high number of Aux sends enables multiple and fully independent routings.

In some cases it is necessary to synchronize the gain changes of these routings. An example is the Post fader function, where a change of the singer's volume shall be performed identical to the volume change of the signal sent to the reverb device, so that the reverb level keeps its relation to the original signal. Another example is the signal of a guitar that is routed to different submixes, means hardware outputs, which gets much too loud during the solo part, and therefore needs to be reduced in volume on all outputs simultaneously. After a click on the Trim button this can be done easily and with a perfect overview.



As all channel's routings change simultaneously when Trim is active, this mode basically causes the same behaviour as a trim pot within the input channel, affecting the signal already before the mixer. That's how this function got its name.

In the *View Options / Show* the function Trim Gains can be globally switched on and off for all channels. The global Trim mode is recommended when using TotalMix FX as live mixing desk.

The Context Menu. With a right click on the input, playback and output channels their context menus provide advanced functionality (these menus are also available in the Matrix, but only directly on the channel labels). The entries are self-explanatory and automatically adjust to where the click is performed. On all of these the first entry opens the *Channel Layout* dialog. The input channels offer *Clear*, *Copy input*, *paste the input mix* and *paste its FX*. On a playback channel *Copy*, *Paste and Clear the playback mix* are available. On an output channel *Copy* and *Mirror* functionality for the current submix and *copying* of the FX settings is offered.

25.3.1 Settings

A click on the tool symbol opens the channel's **Settings** panel with differing elements. For example the option **Inst** exists only in input channels 3-4, and the ADAT channels do not offer the phantom power option.

Stereo. Switches the channel to mono or stereo mode.

48V. Activates phantom power at the corresponding input. Serves as power supply for high quality condenser mics. This option should stay off with other sources to prevent failure by spikes.

Inst. Switches inputs 3 and 4 individually to Instrument (Hi-Z) mode.

Gain (1-2). Sets the gain for the four front inputs. The knob can be adjusted by dragging the mouse or by the mouse wheel. This also works when the mouse has been moved over the two gain displays. Then the gain can be changed separately for left and right channel, even when the channel is in stereo mode.

Gain (3-8). Additionally to the reference level setting, Line inputs 3 to 8 have an adjustable gain option from 0 dB to +12 dB.

Level. Sets the reference level individually for the Line inputs. The available settings are +13 dBu and +19 dBu.

AutoSet. Activates an automatic gain reduction preventing overloads caused by too high gain settings. See chapter 19.2 for details.

Width. Defines the stereo width. 1.00 equals full stereo, 0.00 mono, -1.00 swapped channels.

FX Send. Setting the level of the signal sent to the FX bus which feeds Echo and Reverb. The current setting is also visible with closed channel settings, because knob and small fader are always synchronized. To make this function as useful as possible FX Send is locked to the highest submix, thus imitating the *Aux Post Fader* function of a standard mixing desk. When moving the big fader both knob and small fader will also move. This way the reverb signal will always have the same relation to the dry signal.

The level of the signal sent to the effects can be controlled by the *FX In* level meters of the FX window. It becomes visible after a click on FX in the View Options.

MS Proc. Activates M/S processing within the stereo channel. Monaural information is sent to the left channel, stereo information to the right.

Phase L. Inverts the phase of the left channel by 180°.

Phase R. Inverts the phase of the right channel by 180°.

Note: the functions Width, MS Proc, Phase L and Phase R affect all routings of the respective channel.



Besides Stereo/Mono, Phase L und Phase R the settings of the Hardware Outputs have further options:

Level. Sets the reference levels of the 6 analog Line outputs. The available settings are +4 dBu, +13 dBu and +19 dBu. The Phones (channels 7-8) have a Low (+4 dBu) and High (+19 dBu) setting to choose from.

FX Return. The effect signal (Echo and Reverb) is mixed to the respective hardware output by the duo knob/small fader.

Talkback. Activates this channel as receiver and output of the Talkback signal. This way Talkback can be sent to any outputs, not only the Phones in the Control Room section. Another application could be to send a certain signal to specific outputs by the push of a button.

No Trim. Sometimes channels need to have a fixed routing and level, which should not be changed in any case. An example is the stereo mix-down for recording of a live show. With *No Trim* active, the routing to this output channel is excluded from the Trim Gains function, therefore is not changed unintentionally.



Loopback. Sends the output data to the driver as record data. The corresponding submix can be recorded then. This channel's hardware input sends its data only to TotalMix, no longer to the recording software.

Another difference to the input and playback channels is the **Cue** button instead of Solo. A click on Cue sends the respective Hardware Output's audio to the **Main** Out, or any of the Phones outputs (option *Assign / Cue to* in the Control Room section). With this any hardware output can be controlled and listened to through the monitoring output very conveniently.

25.3.2 Equalizer

A click on EQ opens the **Equalizer** panel. It is available in all input and output channels, and affects all routings of the respective channel (pre fader). The panel includes a low cut and a 3-band parametric equalizer which can be activated separately.

EQ. Activated by the EQ button.

Type. Band 1 and 3 can operate in peak (bell) or shelf (shelving) mode. The middle band is fixed to peak mode. Band 3 can also operate as *Hi Cut* (low pass filter), especially useful for LFE and subwoofer purposes.

Gain. All three bands can change their amplification between +20 dB to -20 dB.

Freq. The center frequency of the filters is adjustable between 20 Hz and 20 kHz. While in peak mode the center frequency is adjusted, in shelf mode the cut-off point (-3 dB) will be changed.

Q. The Quality factor of the filter is adjustable from 0.7 (wide) to 5.0 (narrow).



Lo Cut. Activated by the button Lo Cut. The slope of the high-pass filter is adjustable between 6, 12, 18 and 24 dB per octave. The cut-off point (-3 dB) is adjustable between 20 Hz and 500 Hz.

The frequency graphics give a precise overview of the filter results. Overlapping filters influence each other. This can be used to achieve more than 20 dB amplitude, or to generate difficult frequency response optimizations.

Note: TotalMix has an internal headroom of 24 dB. Extreme boosts with overlapping filters can therefore cause an internal overload. In any case such an overload is displayed by the Over LED of the channel's level meter.

Preset. Settings of the EQ and the Low Cut can be stored, loaded, and copied between channels at any time. A click on Preset opens a menu with several entries:

- **Recall:** Presets stored before by the user can be selected and loaded
- **Save to:** There are 16 storage places available (EQ Preset 1 to 16)
- **Import:** Loads a previously stored TM EQ file (.tmeq)
- **Export:** Stores the current state as TM EQ file (.tmeq)
- **Factory:** Includes 14 examples for the creative use of Low Cut and Equalizer
- **Reset:** Resets the Low Cut and EQ to have zero influence (Gain 0 dB)
- **Rename:** The EQ Presets 1 to 16 can be renamed. The changes will be shown in both lists Recall and Save to.

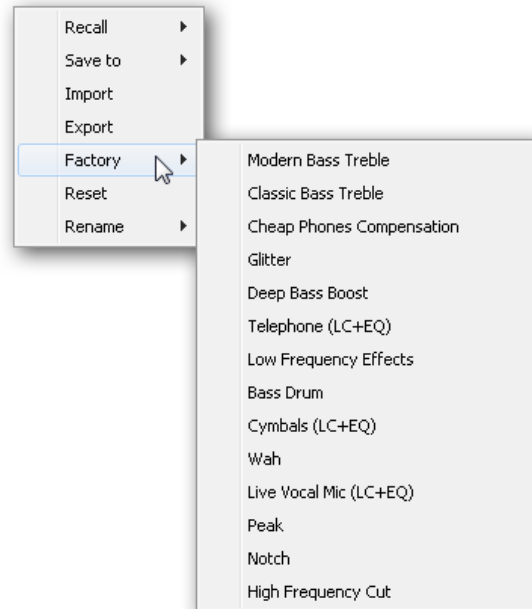

Notes on the EQ Presets

Copy between channels: The EQ Preset menu of all channels is identical. If an EQ setup is stored via *Save to* on one of the 16 storage places, it is then also available in any other channel via *Recall*.

Copy between Snapshots: The Presets are not saved in Snapshots, therefore do not change when a different Snapshot is loaded. Presets are saved in Workspaces and also loaded with these.

Copy between Workspaces: is done by the export and import function of the Preset menu. Important and useful Presets should always be saved as TM EQ file, so that they can not get lost even on accidental overwrite.

Factory Presets: loaded like all Presets the settings of both Low Cut and EQ simultaneously. The current state, On or Off, is neither saved nor activated on load. With this a preset can be loaded anytime, but will not become active before the user decides to switch the EQ and/or LC on – except they had been active already before the load process. For this reason some Factory Presets have special names. For example Telephone (LC+EQ) will sound much better when the LC has been activated additionally to the EQ, as the LC is set to an unusual high frequency of 500 Hz here.

25.3.3 Dynamics

A click on D opens the **Dynamics** panel with Compressor, Expander and Auto Level. They are available in all input and output channels, and affects all routings of the respective channel.

Dynamics. Activated by this button.

Thresh. Threshold where Compressor or Expander start to work. The Compressor is adjustable from -60 dB to 0 dB, the Expander is adjustable from -99 dB to -20 dB.

Ratio. Ratio of input to output signal. Defines the intensity of the signal processing. Adjustable from 1 to 10.

Gain. Gain stage to compensate a loss in level caused by the Compressor. Adjustable from -30 to +30 dB. With inactive Compressor (Threshold 0 dB, Ratio 1:1) this function can also be used as universal digital gain stage.

Attack. Defines the rise time for the control voltage of Compressor/Expander. Adjustable from 0 ms to 200 ms.

Release. Defines the release time for the control voltage of Compressor and Expander. Adjustable from 100 ms to 999 ms.



The amplitude graphics give a precise overview of the level changes caused by the current settings of Compressor and Expander. The white dot shows the level of the input signal and with this whether the signal is within the processing range or not. The small light blue lines in the level meter show the currently active gain reduction. Settings for these *Dynamic Meters* are found in the Preferences dialog (F2).

Auto Level. Activated by this button.

Max. Gain. Defines the maximum amplification of the input signal. Adjustable from 0 dB to 18 dB.

Headroom. To minimize short-time overloads and clipping of the signal peaks Auto Level can be set to operate at a fixed offset to 0 dBFS. Adjustable from 3 dB to 12 dB.

Rise Time. Defines the speed of a level increase after a level reduction. Adjustable from 0.1 s to 9.9 s.

Preset. Includes the same functions as described on the previous page for the Equalizer. The names of the Factory Presets make clear whether Compressor, Auto Level or both (C+A) have to be switched on.

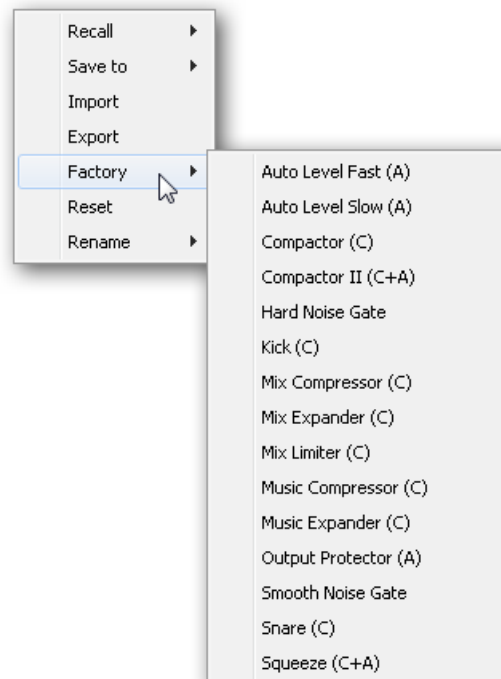

25.4 Section Control Room

In the section Control Room the menu *Assign* defines the **Main Out** which is used for listening in the studio. For this output the functions Dim, Recall, Mono, Talkback, External In and Mute FX are automatically applied. At the unit the VOLUME knob follows this assignment.

Additionally the channel will be shifted from the Hardware Outputs into the Control Room section, and renamed *Main*. The same happens when assigning Main Out B or the Phones. The original name can be displayed by the function *Names* in the View Options menu at any time.

Phones 1 to 4 will have Dim (set in Settings) and a special routing applied when Talkback is activated. Putting them beside the Main Out increases the overview within the output section greatly.

Dim. The volume will be reduced by the amount set in the Settings dialog (F3).

Recall. Sets the gain value defined in the Settings dialog.

Speaker B. Switches playback from Main Out to Main Out B. The faders of the channels Main and Speaker B can be ganged via Link.

Mono. Mixes left and right channel. Useful to check for mono compatibility and phase problems.

Talkback. A click on this button will dim all signals on the *Phones* outputs by an amount set up in the Settings of TotalMix FX. At the same time the control room's microphone signal (source defined in Settings) is sent to the *Phones*. The microphone level is adjusted with the channel's input fader.

External Input. Switches Main monitoring from the mix bus to the stereo input defined in the Settings dialog (F3). The relative volume of the stereo signal is adjusted there as well.

Mute FX. Mutes Reverb and Echo on the Main Out, to hear the mix without those effects.

Assign. Allows to define the Main Out, Main Out B (Speaker B), and up to four Phones outs.

The output for the Cue signal, which is usually Main, can also be set to one of four *Phones* outputs. The setting *Cue/PFL to* also controls the PFL monitoring.

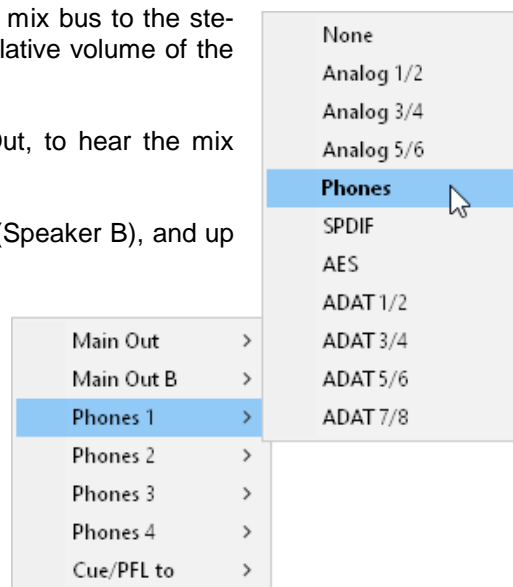

25.5 The Control Strip

The Control Strip on the right side is a fixed element. It combines different functions that are either required globally, or constantly used, and therefore should not be hidden in a menu. It can still be hidden via the top menu Window – Hide Control Strip.

The areas described in the following chapters can be minimized by a click on the arrow in their title bar.

Device selection. Select the unit to be controlled in case more than one is installed on the computer.

FX - DSP Meter. Shows the DSP load caused by activated EQ, Low Cut, Compressor, Auto Level, Echo and Reverb. The DSP of the Fireface UCX II has an automatic load limiter. If no DSP resources are left further effects can not be activated. When switching to DS and QS modes effects will be deactivated automatically until the DSP is not overloaded anymore.

Undo / Redo. With the unlimited Undo and Redo changes of the mix can be undone and redone, at any time. Undo/Redo does not cover graphical changes (window size, position, channels wide/narrow etc.), and also no changes to the Presets. The accidental overwrite of an EQ Preset can not be made undone.

Undo/Redo also operates across Workspaces. Therefore a completely differently set up mixer view can be loaded via Workspace, and with a single click on Undo the previous internal mixer state is returned – but the new mixer view stays.



Global Mute - Solo - Fader.

Mute. Global Mute operates in a pre fader style, muting all currently activated routings of the channel. As soon as any Mute button is pressed, the *Mute Master* button lights up in the Control Strip area. With this button all selected mutes can be switched off and on again. One can comfortably set up a mute group or activate and deactivate several mute buttons simultaneously.

Solo. As soon as any Solo button is pressed, the *Solo Master* button lights up in the Control Strip area. With this button all selected Solos are switched off and on again. Solo operates as Solo-in-Place, post fader style, as known from common mixing desks. A typical limitation for mixing desks, Solo working only globally and only for the Main Out, does not exist in TotalMix. Solo is always activated for the current submix only.

Fader. A Shift-click on a fader adds the fader to the **temporary fader group**. All faders now marked yellow are ganged, and move simultaneously in a relative way. The temporary fader group is deleted by a click on the F symbol.

25.5.1 View Options

The field **Show** combines different functions of routing, the level meters and the mixer view.

Routing Mode

- **Submix.** The Submix view (default) is the preferred view and delivers the quickest overview, operation and understanding of TotalMix. The click on one of the Hardware Output channels selects the respective submix, all other outputs are darkened. At the same time all routing fields are set to this channel. With Submix view, it is very easy to generate a submix for any output: select the output channel, adjust the fader and pans of first and second row – finished.
- **Free.** The Free view is for advanced users. It is used to edit several submixes simultaneously, without the need to change between them. Here one works with the routings fields of the input and playback channels only, which then show different routing destinations.

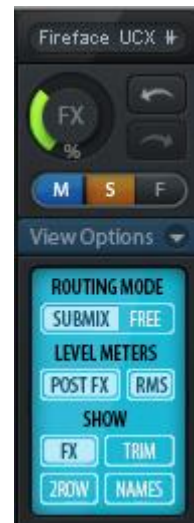

Level Meters

- **Post FX.** Switches all level meters before (pre) or after (post) the effects. Level changes by these can be easily checked using this feature. Additionally the input signal can be checked for overloads. It is recommended to use Post FX as default setting, as the extreme reduction of a signal by LC/EQ is very seldom. Also all OVR displays of all level meters operate both pre and post, efficiently preventing overloads going unnoticed.
- **RMS.** The numerical level display in the channels displays peak or RMS.

Show

- **FX.** Opens the window to set up the effects Reverb and Echo.
- **Trim.** Activates all Trim buttons on all channels. TotalMix thus behaves like a conventional, simple mixing desk. Each fader affects all active routings of the channel simultaneously, as if the fader were a trim-pot in the hardware input.
- **2 Row.** Switches the mixer view to 2 rows. Hardware Inputs and Software Playbacks are placed side by side. This view saves a lot of space, especially in height.
- **Names.** Display of the original names of channels when they had been renamed by the user.

25.5.2 Snapshots - Groups

Snapshots. Snapshots include all mixer settings, but no graphical elements like window positions, window size, number of windows, visible EQs or Settings, scroll states, Presets etc. Only the state wide/narrow of the channels is registered. Moreover the Snapshot is only temporarily stored. Loading a Workspace causes the loss of all stored Snapshots, when these all had not been saved before in a Workspace, or separately via *File / Save Snapshot as*. Via *File / Load Snapshot* the mixer states can be loaded individually.

Eight different mixes can be stored under individual names in the Snapshot section. A click on any of the eight buttons loads the corresponding Snapshot. A double click on the name field opens the dialog *Input Name* to edit the name. As soon as the mixer state is changed the button starts flashing. A click on Store lets all buttons flash, whereby the last loaded one, the base of the current state, flashes inversely. The storage finishes by clicking the desired button (means storage place). The storage process is exited by another click on the flashing Store button.

The area Snapshots can be minimized by a click on the arrow in the title bar.

Groups. The area Groups provides 4 storage places each for fader, mute and solo groups. The groups are valid per Workspace, being active and usable in all 8 Snapshots. But with this they are also lost when loading a new workspace, in case they have not been saved before in a different Workspace.

Note: The Undo function will help in case of an accidental overwrite or deletion of the groups.

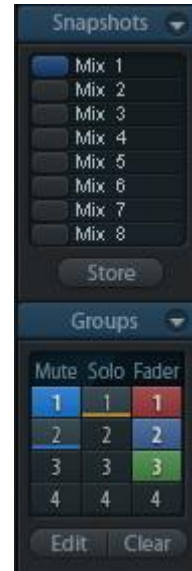

TotalMix uses flashing signals to guide you through the group setup. After a click on Edit and click on the desired storage place all desired functions for this group have to be activated or selected. The storage process is finished by another click on Edit.

When setting up a fader group make sure to not add faders that are at the top or low position, unless all faders of that group have this position.

The Mute groups operate – other than the global mute – exclusively for the current routing. This way you can not mute signals on all outputs unintentionally. Instead signals can be muted on specific submixes by the push of a button.

A solo group operates exactly like the global solo, signals outside the current routing are not affected.

25.5.3 Channel Layout - Layout Presets

To maintain overview within TotalMix FX channels can be hidden. Channels can also be excluded from being remototed. Under *Options / Channel Layout* a dialog lists all I/Os with their current state. Selecting one or several channels enables the options to the right:

- **Hide Channel in Mixer/Matrix.** The selected channels are no longer shown in TotalMix FX, nor are they available via MIDI or OSC remote control.
- **Hide Channel in MIDI Remote 1-4.** The selected channels are hidden for MIDI remote (CC and Mackie Protocol).
- **Hide Channel in OSC Remote 1-4.** The selected channels are hidden for OSC remote control.

Hidden channels in Mixer/Matrix are still fully functional. An existing routing/mixing/FX processing stays active. But as the channel is no longer visible it can not be edited anymore. At the same time the hidden channels are removed from the list of remote controllable channels, to prevent them from being edited unnoticed.

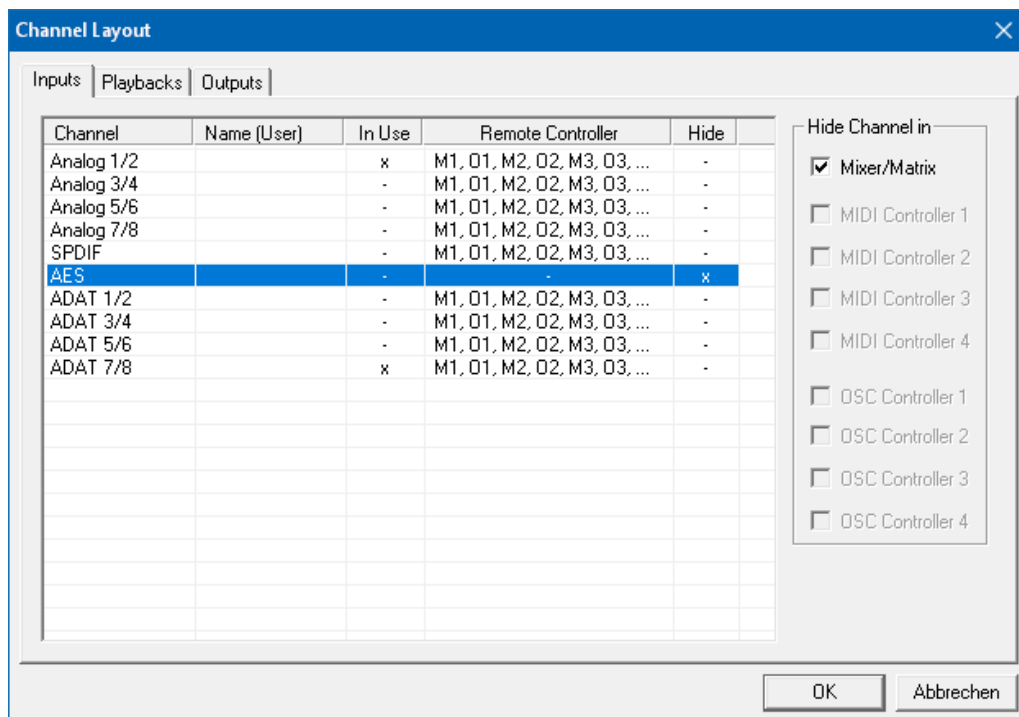

Hidden channels in *MIDI Remote* x are removed from the list of remote controllable channels. Within an 8-channel block of a Mackie compatible control they are skipped. The control therefore is no longer bound to consecutive orders. For example it will control channels 1, 2, and 6 to 11, when channels 3 to 5 are hidden. The same can be done for OSC. With unnecessary channels made invisible for the OSC remote the more important channels are available as one block on the remote.

The dialog can be called directly from TotalMix by a right mouse click on any channel. The corresponding channel will then be preselected in the dialog.

In the above example the AES input channel has been made invisible. When AES is not used this is an easy way to remove it from the mixer completely.

Rows Inputs, Playbacks and Outputs are set up individually by the tabs at the top. *In Use* shows which channels are currently used in the mixing process. A double click onto any line opens the edit field for the *Name (User)* column. Editing channel names in this dialog is quick, Enter jumps to the next line. The names of the channels in the Control Room section can only be changed this way.

After finishing those settings the whole state can be stored as **Layout Preset**. A click on *Store* and the desired memory slot makes the current channel layout recallable anytime. The button *All* makes all channels temporarily visible again.



With a simple click on a button it will then be possible to easily switch views of only the channels involved with the mixing of the drum section, the horn section, the violins, or any other useful view. An optimized remote layout can be activated here as well, with or without visible changes. Double-click the default slot name to enter any other name.

! *Layout Presets are stored within the Workspace, so make sure to save the current state before loading a different Workspace!*

The button *Sub* activates another useful special view. When in *Submix view*, *Sub* will cause all channels to disappear that are not part of the currently selected Submix/Hardware Output. *Sub* temporarily shows the mix based on all channels from Inputs and Playback row, independent from the current Layout Preset. That makes it very easy to see and to verify which channels are mixed/routed to the current output. *Sub* makes checking and verifying of mixes, but also the mix editing itself, a lot easier, and maintains perfect overview even with lots of channels.

25.5.4 Scroll Location Markers

Another feature to improve overview and working with TotalMix FX are scroll location markers (TotalMix view only). These are displayed automatically when the horizontal size of the TotalMix FX window is smaller than the channel display requires. Shown on the right side of the scrollbar of each row they have four elements:

- **Arrow to the left.** A left mouse click let the channels scroll to the very first one, or most left.
- **1.** Marker number 1. Scroll to the desired position and perform a right mouse click on 1. A dialog comes up with precise information. Once stored, a left mouse click will scroll the channels to the stored position.
- **2.** Marker number 2. See 1 for details.
- **Arrow to the right.** A left mouse click let the channels scroll the last one, or most right.

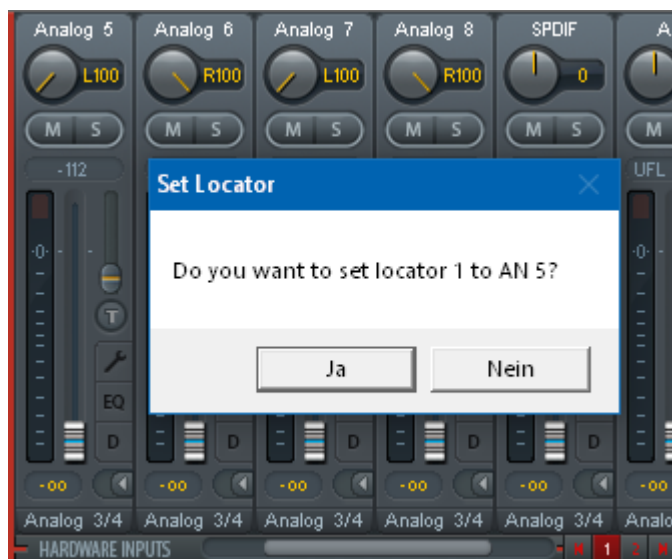

Location markers are stored in the Workspace.

Application Examples

While originally added to improve navigation in the HDSPe MADI FX (having 196 channels that never fit on any screen), the scroll location markers are also helpful with units having less channels:

- When the TotalMix FX window is intentionally made small in width, so only a few channels are shown.
- When some or all EQ or Dynamics panels are open. Then all relevant settings are always visible, but require a lot of space horizontally.

25.6 Reverb and Echo

A click on FX in the *View Options / Show* brings up the Output FX panel. Here all parameters for the effects Reverb and Echo are adjusted.

Reverb. Activated by the On button.

Type. Lists different reverb types for selection. Available are:

- **Rooms Small, Medium, Large, Walls.** Room simulation of rooms in different size and behaviour.
- **Shorty** provides a short, rich and warm reverb.
- **Attack** slaps back.
- **Swagger** enriches and blows up the original sound source.
- **Old School** is just that.
- **Echoistic** has a heavy echo part within the reverb sound which brings some nice stereo effect as well.
- **8plus9** is a mixture of Old School and Echoistic.
- **Grand Wide** stands for a wide and open room and space.
- **Thicker** can be used as short reverb to enrich the original signal.
- **Space** has the most sizzle and longest reverb time.
- **Envelope.** Reverb effect where the volume course (envelope) is freely adjustable.
- **Gated.** Simpler version of the Envelope reverb for cut reverb effects.

Please note that all these reverb types are extremely flexible due to the available Smooth and Room Scale controls. Most of them can be used as short and long reverb, and sound totally different with Smooth turned to maximum or minimum.

TotalMix FX comes with factory presets and default values for all reverb types to ensure a fast setup time and quick results. Please take the time to experiment with them with different signals and different settings, to learn how different they can sound and can be used.



General Settings

PreDelay. Delay of the reverb signal. Adjustable from 0 ms up to 999 ms.

Low Cut. High-pass filter *before* the reverb generation, removes low frequency signals which should not cause a reverb sound. Adjustable from 20 Hz up to 500 Hz.

High Cut. Low-pass filter *after* the reverb generation. A reduction of the treble often lets the reverb sound more natural. Adjustable from 5 kHz up to 20 kHz.

Smooth. Softens the reverb effect, affects stereo width, density and sound colour. Adjustable from 0 up to 100.

Width. Adjusts the stereo width of the reverb signal from 100 (stereo) to 0 (mono).

Volume. Adjusts the level of the reverb effects signal sent to the FX return bus.

Special Settings for Room Types

Room Scale. Determines the size of the room, thus changing density and length of the reverb effect. Adjustable from 0.5 up to 3.0.

Special Settings for Envelope and Gated

Attack. Length of time for the volume increase of the reverb signal. Also called rise time. Adjustable from 5 ms up to 400 ms.

Hold. Length of time for the fixed volume part of the reverb signal. Adjustable from 5 ms up to 400 ms.

Release. Length of time for the volume decrease of the reverb signal. Adjustable from 5 ms up to 400 ms.

Special Settings for Space

Reverb Time. Sets the duration of the reverb referenced to a volume drop of 20 dB. Adjustable from 0.1 s up to 4.9 s.

High Damp. Sets the treble damping over time for the reverb signal. In principle, this is a low-pass filter like High Cut. Because of the operation principle of this reverb it shows a slightly different behaviour. Adjustable from 5 kHz up to 20 kHz.

Echo. Activated by the On button.

Type. Lists different echo algorithms for selection. Available are:

- **Stereo Echo.** Separated echo generators on left and right channel. As a result the echo follows the sound source within the stereo field.
- **Stereo Cross.** Echo generator on left and right channel with cross coupled feedback which is only working for the stereo parts of the input signal. In case the input signal is only left or right the Stereo Cross acts exactly like the Pong Echo.
- **Pong Echo.** Generates an echo that jumps between left and right channel, independent from the source signal's stereo position.

Settings

Delay Time. Sets the delay time for the first echo.

BPM. A double click on the lower value field offers a delay adjustment as *Beats Per Minute*.

Feedback. Feedback to produce further echoes.

Width. Adjusts the stereo width of the echo signal from 100 (stereo) to 0 (mono).

Volume. Adjusts the level of the echo effects signal sent to the FX return bus.

High Cut (HC). Option for more natural sound or intentional damping of the delayed signal.

Preset. Settings of the Reverb and the Echo can be stored, loaded, and copied between channels at any time. A click on Preset opens a menu with several entries:

- **Recall:** Presets stored before by the user can be selected and loaded
- **Save to:** There are 16 storage places available (Reverb/Echo Preset 1 to 16)
- **Import:** Loads a previously stored TM FX Reverb file (.tmrv) or a TM FX Echo file (.tmeo)
- **Export:** Stores the current state as TM FX Reverb file (.tmrv) or as TM FX Echo file (.tmeo)
- **Factory:** Includes 10 examples for the configuration of the Reverb
- **Reset:** Resets the Reverb or Echo
- **Rename:** The Presets 1 to 16 can be renamed. The changes will be shown in both lists Recall and Save to.

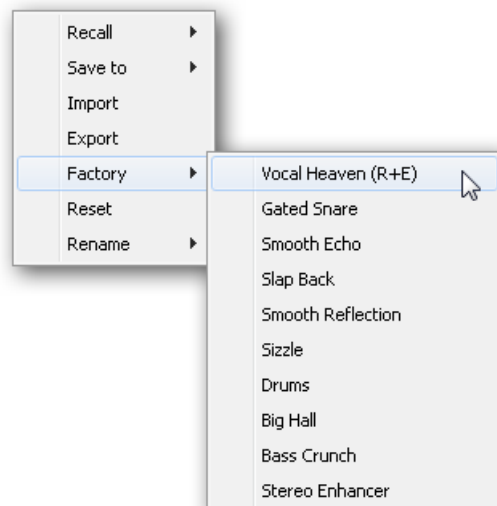

25.7 Preferences

The dialog Preferences can be opened via the *Options* menu or directly via F2.

Level Meters

- **Full scale samples for OVR.** Number of consecutive samples to trigger an over detection (1 to 10).
- **Peak Hold Time.** Hold time of the peak value. Adjustable from 0.1 up to 9.9 s.
- **RMS +3 dB.** Shifts the RMS value by +3 dB, so that full scale level is identical for Peak and RMS at 0 dBFS.

Mixer Views

- **FX Send follows highest Submix.** Locks the FX Send knob to the channel fader. As TotalMix supports multiple routings per channel, a definition is needed which fader (only one is visible) is the one that FX Send will follow. This is always the one with the highest fader position, means the highest gain.
- **FX Send follows Main Out.** Locks the FX Send knob to the channel fader only for the Main Out submix. This is a typical Live feature, where the FX Send is always tied to the fader for the most important output - the Main Out. When adjusting other submixes the FX send will not follow the fader movement.
- **Center Balance/Pan when changing Mono/Stereo.** When switching a stereo channel into two mono channels the pan-pots are set fully left and right. This option will set them to center instead.
- **Disable mouse wheel operation.** Prevents unintentional changes when using the mouse wheel.
- **Disable double click fader action.** Prevents unintentional gain settings, for example when using sensitive touchpads.
- **Store channel open/close in Layout Preset.** Also loads the state of the channel panels (Settings/EQ Panel).

Dynamic Meters

- **Compressor/Expander.** Activates the display of the Compressor/Expander's gain reduction as thin blue line in the level meters of the corresponding channel.
- **Include Gain setting.** The currently set fixed amplification value (by the Gain knob) is included in the display. This can lead to positive values, with the display limited to +6 dB. In case the option Compressor/Expander is deactivated this option is also not available, therefore grayed out.
- **Auto Level.** Activates the display of the variable amplification of the Auto Leveler. As Auto Level can both amplify and attenuate the audio signal, depending on its configuration, the display can show negative (typical gain reduction) as well as positive (above 0 dB, amplification) values.

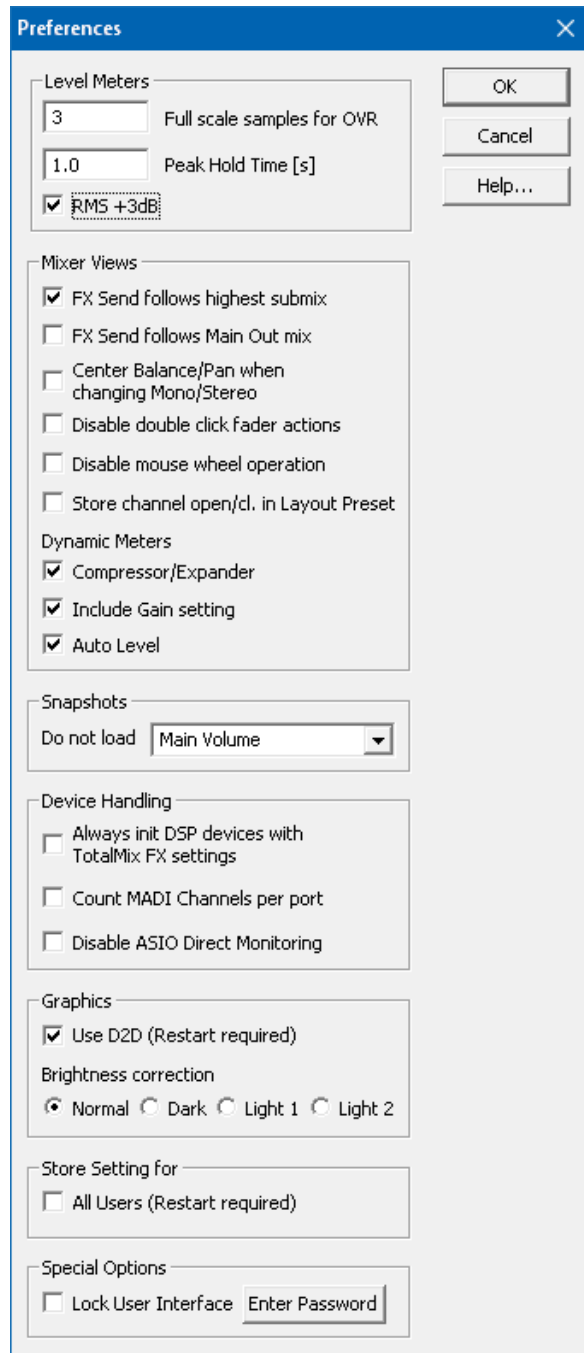

Snapshots

- **Do not load - Main Volume, Main/Phones Volumes, Control Room Settings.** The selected values stored in the Snapshot are not loaded, so the current setting is not changed.

Device Handling

- **Always init DSP devices with TotalMix FX settings.** Used to suppress the mismatch message after using the unit stand-alone. Settings in the unit are lost.
- **Count MADI Channels per port.** Not available with the Fireface UCX II.
- **Disable ASIO Direct Monitoring.** Disables ASIO Direct Monitoring (ADM) for the Fireface UCX II within TotalMix FX.

Graphics

- **Use D2D (Change requires restart).** Default on. Can be deactivated to use a compatible but CPU-taxing graphics mode, in case graphics problems show up.
- **Brightness Correction.** Adjusts the brightness of the TotalMix FX graphics.

Store Setting for

- **All Users (Restart required).** See next chapter.

Special Options

- **Lock User Interface.** Default off. Can be activated to freeze the current mix state. Faders, buttons and knobs relating to the mix state can not be moved anymore.
- **Enter Password (Windows only).** Secures the locked user interface with an additional password.

25.7.1 Store for Current or All Users

TotalMix FX stores all settings, workspaces and snapshots for the *current user* in:

XP: C:\Documents and Settings\Username\Local Settings\Application Data\TotalMixFX

Since Vista: C:\Users\Username\AppData\Local\TotalMixFX

Current User ensures that when workstations are used by several people they all find their own settings. In case the settings should be identical or given for any user, TotalMix FX can be changed to use the *All User* directory. An admin could even write protect the file **last-FirefaceUCXII1.xml**, which results in a complete reset to that file's content whenever TotalMix FX is restarted. The xml-file is updated on exit, so simply set up TotalMix as desired and exit it (right mouse click on the symbol in the notification area or Exit), then change the file attribute.

Paths under macOS X

Mac Current User: user/Library/Application Support/RME TotalMix FX

Mac All Users: /Library/Application Support/RME TotalMix FX

25.8 Settings

The dialog Settings can be opened via the *Options* menu or directly via F3.

25.8.1 Mixer Page

On the mixer page some typical settings for the mixer operation are set, like Talkback source, Dim amount when Talkback is active, the stored main volume or the input used for the External Input function.

Talkback

- **Input.** Selects the input channel of the Talkback signal (microphone in control room). Default: None.
- **Dim.** Amount of attenuation of the signals routed to the *Phones* in dB.

Listenback

- **Input.** Selects the input channel of the Listenback signal (microphone in recording room). Default: None.
- **Dim.** Amount of attenuation of the signals routed to the *Main Out* in dB.

Main Out

- **Recall.** User defined listening volume, activated by the Recall button at the unit or in TotalMix.
- **Dim.** Amount of attenuation for the Main Out in dB.
- **External Input.** Selects the stereo input that replaces the mix signal on the Main Out when activated. The volume of the stereo signal is adjusted by the slider Gain.

PFL Mode

- **Live Mode, PFL replaces Solo.** PFL means Pre Fader Listening. This feature is very useful when operating TotalMix in a live environment, as it allows to quickly listen/monitor any of the inputs by hitting the Solo button. The monitoring happens on the output set for the Cue signal via the Assign dialog.
- **Exclusive Solo/PFL Mode.** Only a single Solo or PFL can be active at a time. Activating a different one automatically deactivates the previous one.
- **2-Row Mode with only Input in first row.** The Software Playback channels are shifted to the lower row, beside the Hardware Outputs.

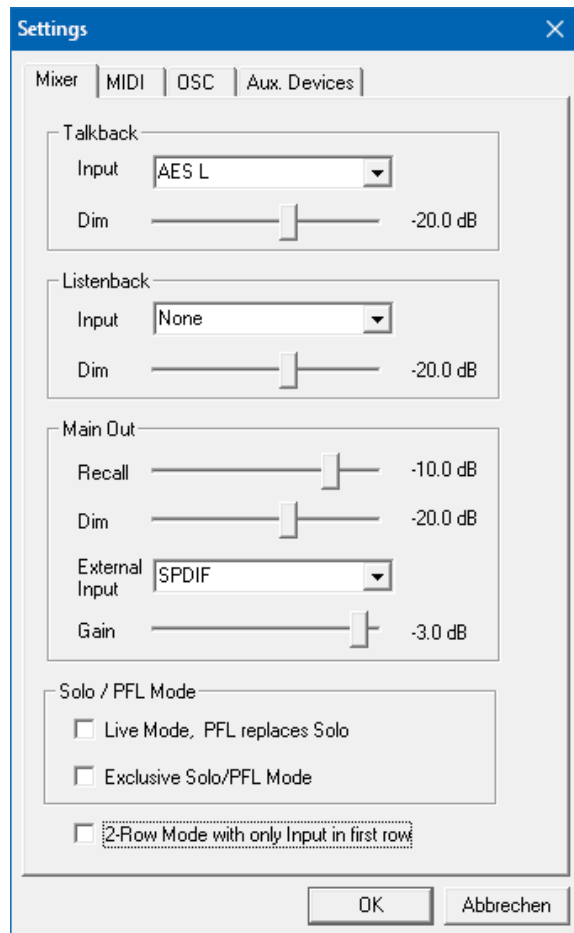

25.8.2 MIDI Page

The MIDI page has four independent settings for up to four MIDI remote controls, using CC commands or the Mackie Control protocol.

Index

Select one of four settings pages and thus remote controls. Settings are remembered automatically. To activate or deactivate any of the four remote controls check or uncheck 'In Use'.

MIDI Remote Control

- **MIDI In.** Input where TotalMix receives MIDI Remote data.
- **MIDI Out.** Output where TotalMix sends MIDI Remote data.
- **Disable MIDI in background.** Deactivates MIDI Remote Control as soon as another application is in the focus, or when TotalMix has been minimized.

Mackie Control Options

- **Enable Protocol Support.** When disabled TM FX will only react on the Control Change commands of chapter 28.5.
- **Extender to.** Sets the current remote to be an extender to the main remote. Both remotes will be shown as one block and navigate simultaneously.
- **Map Stereo to 2 Mono Channels.** One fader controls one (mono) channel. Should be disabled when stereo channels are used.
- **Submix Selection in Input/Playback Row.** Enables a selection of the submix when in first row, without having to change to the third row first. However, when using both mono and stereo channels first and third row usually do not match anymore, so the selection often becomes unclear this way.
- **Enable full LCD support.** Activates full Mackie Control LCD support with eight channel names and eight volume/pan values.
- **Send User defined Names.** Channel names defined by the user will be sent to the remote device via MIDI and – if supported – shown in its display.
- **Send Level Messages.** Activates the transmission of the level meter data. *Peak Hold* activates the peak hold function as set up for the TotalMix level meters in the preferences.

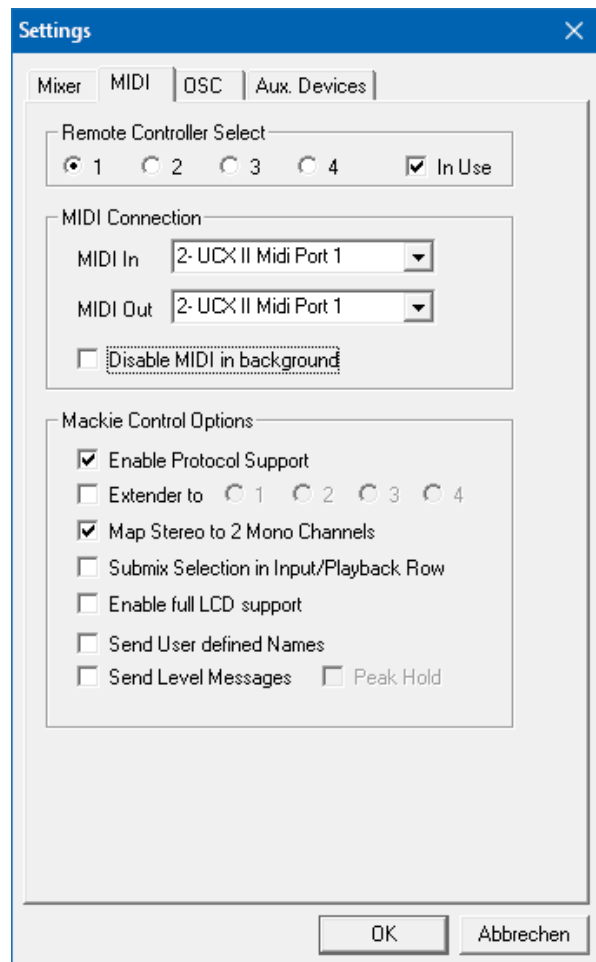

Note: When MIDI Out is set to NONE then TotalMix FX can still be controlled by Mackie Control MIDI commands, but the 8-channel block is not marked as remote target.

25.8.3 OSC Page

The OSC page has four independent settings for up to four MIDI remote controls via Open Sound Control (OSC). This is a network based remote protocol that can be used for example by Apple's iPad with the app *TouchOSC* or *Lemur* to wirelessly remote control TotalMix FX running on a Mac or Windows computer.

Index

Select one of four settings pages and thus remote controls. Settings are remembered automatically. To activate or deactivate any of the four remote controls check or uncheck 'In Use'.

TotalMix FX OSC Service

- **IP.** Shows the network address of the computer running TotalMix FX (local host). This address must be entered on the remote side.
- **Host Name.** Local computer name.
- **Port incoming.** Must match the remote entry 'Port outgoing'. Typical values are 7001 or 8000.
- **Port outgoing.** Must match the remote entry 'Port incoming'. Typical values are 9001 or 9000.

Remote Control

- **IP or Host name.** Enter the IP or host name of the remote control. Please note that the IP number usually works better than the host name.

Options

- **Send Peak Level Data.** Activates the transmission of the peak level meter data. *Peak Hold* activates the peak hold function as set up for the TotalMix level meters in the preferences.
- **Lock Remote to submix.** When activated the current remote control can only modify the submix selected from the drop-down list. This prevents havoc in multi-remote monitoring environments.
- **Number of faders per bank.** Available choices are 8 (default), 12, 16, 24, 32 and 48. Note that when working in underperforming networks, especially wireless, a higher number of faders might not work as smooth as expected.

The screenshot shows the 'Settings' dialog box with the 'OSC' tab selected. The 'Index' section has four radio buttons labeled 1, 2, 3, and 4, with radio button 1 selected and an 'In Use' checkbox checked. The 'Totalmix FX OSC Service' section contains fields for IP (192.168.178.66), Host Name (XPS15), Port incoming (7001), and Port outgoing (9001). The 'Remote Control' section has an 'IP or Host Name' field containing 192.168.178.92. The 'Options' section includes checkboxes for 'Send Peak Level Data' and 'Peak Hold', a 'Lock Remote to submix' checkbox with a dropdown menu showing 'AN 1/2', and a 'Number of faders per bank' dropdown menu showing '8'. 'OK' and 'Cancel' buttons are at the bottom.

25.8.4 Aux Devices

The RME OctaMic XTC is a highly flexible hi-quality 8-channel microphone, line and instrument preamp with integrated AD-conversion to ADAT, AES/EBU and MADI, plus 4 channels of DA-conversion for monitoring. It can be used as universal front-end for the Fireface UCX II and other interfaces.

To simplify operation the most important parameters of the XTC (gain, 48V, phase, mute, AutoSet) can be controlled directly from the TotalMix FX input channels. This special remote control uses MIDI of any format (DIN, USB, MIDI over MADI).

Device Settings

- **Digital Channels.** Select where the OctaMic XTC sends its 8 analog channels to (UCX II: ADAT channels 1-8)
- **Device.** At this time only the OctaMic XTC is supported and can be chosen.

MIDI Settings

- **MIDI In.** Set the currently used MIDI connection to the OctaMic XTC.
- **MIDI Out.** Set the currently used MIDI connection to the OctaMic XTC.
- **Device ID.** Default 0. This setting relates to the current choice in Digital Channels.

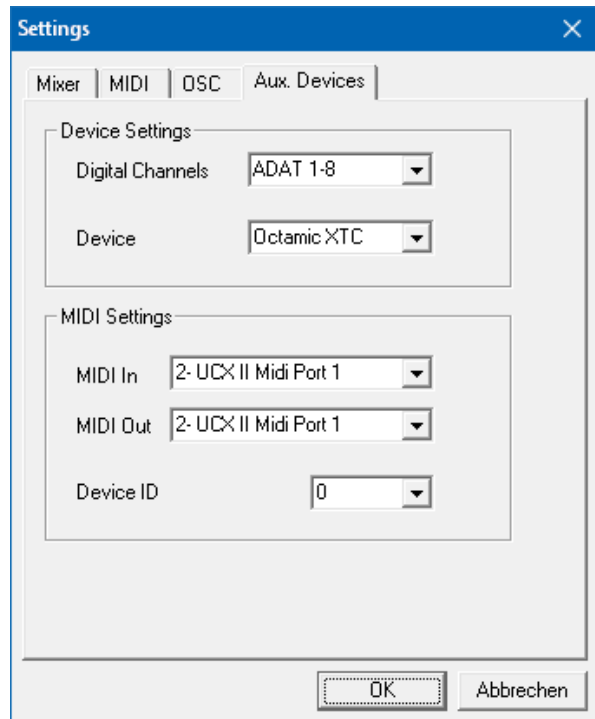

When using more than one OctaMic XTC these must have different Device IDs (configuration is done at the OctaMic XTC). *Aux Devices* supports to set different Device IDs to the 8-channel blocks as well. Storing the setting is done automatically when selecting a Device ID. To check the current assignments toggle the two 8-channel blocks.

The screenshot to the right shows what happens as soon as the above settings have been confirmed with OK. The MADI channels show new elements for phantom power, Inst/PAD, Gain and AutoSet. Control operates bidirectional, so changing the gain at the unit will be mirrored in the TotalMix channels. Changing the gain in TotalMix FX will set the gain in the unit, which is also shown on the unit's display.

For the remote to work the XTC's currently used MIDI I/Os have to be set to *Control*. More details are found in the manual of the OctaMic XTC.



25.9 Hotkeys and Usage

TotalMix FX has many hotkeys and mouse/hotkey combinations to speed up and simplify the usage. The below description refers to Windows. On Mac substitute *Ctrl* in the below list with the command key (⌘).

The **Shift** key enables a fine-tuning of the gain with all faders and in the Matrix. On all knobs it will speed up the setting.

A click on a **fader** with held down **Shift** key adds the fader to the temporary fader group.

A click in the **fader path** with held down **Ctrl** key will let the fader jump to 0 dB, at the next click to $-\infty$. Same function: Double click of the mouse.

Clicking on one of the **Panorama** or **Gain** knobs with held down **Ctrl** key lets the knob jump to center position. Same function: Double click of the mouse.

Clicking on the **Panorama** knob with held down **Shift** key lets the knob jump to fully left, with **Shift-Ctrl** to fully right.

Clicking on one of the channel settings buttons (slim/normal, Settings, EQ, Dynamics) with held down **Ctrl** key lets all channels to the right change their state. For example all panels can be opened/closed simultaneously.

A **double click** of the mouse on a knob or its numerical field opens the according *Input Value* dialog. The desired value can then be set by keyboard.

Dragging the mouse from a parameter field increases (move up) or decreases (move down) the value in the field.

Ctrl-N opens the dialog *Function Select* to open a new TotalMix window.

Ctrl-W opens the dialog *File Open* of the operating system to load a TotalMix Workspace file.

The key **W** starts the dialog *Workspace Quick Select* for a direct selection or storage of up to 30 Workspaces.

The key **M** switches the active window to Mixer view. The key **X** switches the active window to Matrix view. **Ctrl-M** opens a new Mixer window, **Ctrl-X** opens a new Matrix window. Another Ctrl-M or Ctrl-X closes the new window again.

F1 opens the online help. The Level Meter setup dialog can be opened with **F2** (same as in DIGICheck). The dialog Preferences is opened with **F3**.

Alt-F4 closes the current window.

Alt and **number** keys 1 to 8 (not on the numeric keypad!) will load the corresponding Workspace from the Workspace Quick Select feature (hotkey W).

25.10 Menu Options

Deactivate Screensaver: When active (checked) any activated Windows screensaver will be disabled temporarily.

Always on Top: When active (checked) the TotalMix window will always be on top of the Windows desktop. Note: This function may result in problems with windows containing help text, as the TotalMix window will even be on top of those windows, so the help text isn't readable.

Enable MIDI /OSC Control: Activates external MIDI control of the TotalMix mixer. In Mackie Protocol mode the channels which are currently under MIDI control are indicated by a colour change of the name field.

Submix linked to MIDI / OSC controller (1-4). The 8-channel group follows the currently selected submix, means Hardware Output, when a different submix is chosen on the remote as well as when doing this in TotalMix. When using multiple windows it can be useful to deactivate this feature for specific windows. The view will not change then.

Preferences: Opens a dialog box to configure several functions of the level meters and the mixer. See chapter 25.7.

Settings. Opens a dialog box to configure several functions like Talkback, Listenback, Main Out and the MIDI Remote Control. See chapter 25.8.

Channel Layout. Hide channels visually and from remote. See chapter 25.5.3.

ARC & Key Commands. Opens a window to configure the programmable buttons of the Standard, Advanced and Advanced Remote USB, and of the computer's keyboard keys F4 to F8.

Reset Mix. Offers several options to reset the mixer state:

- **Straight playback with all to Main Out.** All Playback channels are routed 1:1 to the Hardware Outputs. Simultaneously all playbacks are mixed down to the Main Out. The faders in the third row are not changed.
- **Straight Playback.** All Playback channels are routed 1:1 to the Hardware outputs. The faders in the third row are not changed.
- **Clear all submixes.** Deletes all submixes.
- **Clear channel effects.** Switches off all EQs, Low Cuts, Reverb, Echo, Dynamics and Stereo Width and sets their knobs to default position.
- **Set output volumes.** All faders of the third row set to 0 dB, Main and Speaker B to -10 dB.
- **Reset channel names.** Removes all names assigned by the user.
- **Set all channels mono.** Reconfigures all TotalMix FX channels to mono mode.
- **Set all channels stereo.** Reconfigures all TotalMix FX channels to stereo mode.
- **Set inputs mono / outputs stereo (ADM).** Preferred setup for best ASIO Direct Monitoring compatibility. In most cases mono hardware outputs will break ADM. Mono inputs are in most cases compatible. If not wrong panning might occur.
- **Total Reset.** Playback routing 1:1 with mixdown to Main Out. Switches off all other functions.

Operational Mode. Defines TotalMix FX basic operational mode. Choices are *Full Mode* (default, mixer active, all routing options available), and *Digital Audio Workstation Mode* (straight playback routing, no input mix). See chapter 29 for details.

Network Remote Settings. Settings to remote control TotalMix FX by TotalMix Remote via network. See chapter 30.

Store Current state into device. The unit can store up to 6 setups (the current state) in its own memory. This function has been developed especially for the stand-alone mode operation, where there are no playback channels. Therefore using it under Windows, Mac or iOS will result in incomplete setups.

25.11 Menu Window

Zoom Options 100%, 135%, 200%, 270%. Depending on the size of the monitor and the current resolution TotalMix FX might be much too small and the controls too tiny to easily operate them. Together with the 2 Row mode these options give a lot of different window sizes that suit all monitors and resolutions currently existing.

Hide Control Strip. Shifts the Control Strip out of the visible area to gain more space for other elements.

26. The Matrix

26.1 Overview

The mixer window of TotalMix looks and operates similar to mixing desks, as it is based on a conventional stereo design. The matrix display presents a different method of assigning and routing channels, based on a single channel or monaural design. The matrix view of the Fireface UCX II has the look and works like a conventional patchbay, adding functionality way beyond comparable hardware and software solutions. While most patchbays will allow you to connect inputs to outputs with just the original level (1:1, or 0 dB, as known from mechanical patchbays), TotalMix allows you to use a freely definable gain value per crosspoint.

Matrix and TotalMix are different ways of displaying the same processes. Because of this both views are always fully synchronized. Each change in one view is immediately reflected in the other view as well.

26.2 Elements of the Matrix View

The visual design of the Matrix is determined by the architecture of the Fireface UCX II system:

- **Horizontal labels.** All hardware outputs
- **Vertical labels.** All hardware inputs. Below are all playback channels.
- **Green 0.0 dB field.** Standard 1:1 routing
- **Dark grey field with number.** Shows the current gain value as dB
- **Blue field.** This routing is muted
- **Red field.** Phase 180° (inverted)
- **Dark grey field.** No routing.

	Out 1	Out 2	Out 3	Out 4	Out 5
Analog 1/2	0.0				
AN 3		-5.5			
AN 4			0.0		
Analog 5/6				-18.4	
Analog 7/8					

To maintain overview when the window size has been reduced, the labels are floating. They won't leave the visible area when scrolling. A right mouse click on the labels brings up the context menu with the exact same options as in the mixer view: Copy / Mirror / Paste / Clear input channels and submixes.

26.3 Operation

Using the Matrix is a breeze. It is very easy to indentify the current crosspoint, because the outer labels light up in orange according to the mouse position.

- If input 1 is to be routed to output 1, use the mouse and click one time on crosspoint **In 1 / AN 1** with held down Ctrl key. Two green 0.0 dB field pop in, another click removes them.
- To change the gain (equals the use of a different fader position, see simultaneous display of the mixer view), drag the mouse up or down, starting from the gain field. The value within the field changes accordingly. The corresponding fader in the mixer view is moving simultaneously, in case the currently modified routing is visible.
- On the right side is the Control Strip from the mixer window, adapted to the Matrix. The button for the temporary fader group is missing as well as all View options, as they don't make sense here. Instead the button *Mono Mode* lets you decide whether all the actions performed in the Matrix are valid for two channels or just one.

The Matrix not always replaces the mixer view, but it significantly enhances the routing capabilities and - more important - is a brilliant way to get a fast overview of all active routings. It shows you in a glance what's going on. And since the Matrix operates monaural, it is very easy to set up specific routings with specific gains.

27. Tips and Tricks

27.1 ASIO Direct Monitoring (Windows)

Programs that support ADM (ASIO Direct Monitoring - Samplitude, Sequoia, Cubase, Nuendo etc.) send control commands to TotalMix. This is directly shown by TotalMix. When a fader is moved in the ASIO host the corresponding fader in TotalMix will move too. TotalMix reflects all ADM gain and pan changes in real-time.

But: the faders only move when the currently activated routing (the selected submix) corresponds to the routing in the ASIO host. The Matrix on the other hand will show any change, as it shows all possible routings in one view.

27.2 Copy a Submix

TotalMix allows you to copy complete submixes to other outputs. In case a complex submix is need with only a few changes on a different output, the whole submix can be copied to that output. Right click with the mouse on the original submix output, means Hardware Output. In the context menu select Copy Submix. Then right click on the new submix output, choose Paste Submix in the context menu. Now fine tune the submix.

27.3 Doubling the Output Signal (Mirror)

If a mix should be sent out via two (or more) different hardware outputs simply mirror that mix to any number of other outputs. A right click on the original output brings up the option to *Copy/Mirror <name>*. Another right click on the new output, then selecting *Mirror of Output <name>* will paste the whole submix and then synchronize it automatically to any future changes. The outputs now always send out the same signals, but their main volume (fader) and the EQ and Dynamics settings stay fully independent.

27.4 Delete a Submix

The easiest and quickest way to delete complex routings is by selection of the according output channel in the mixer view by a right mouse click, and selection of the menu entry *Clear Submix*. As TotalMix FX includes an unlimited undo the delete process can be undone without any problem.

27.5 Copy and Paste everywhere

The above three tips use functions found in the right click context menu available on all channels of the mixer view. These menus are also available in the Matrix, but only directly on the channel labels. They are self-explanatory and automatically adjust to where the click is performed. The input channels offer *Clear*, *Copy input*, *Paste the input mix* and *Paste its FX*. On a playback channel *Copy*, *Paste* and *Clear the playback mix* are available. On an output channel *Copy* and *Mirror* functionality for the current submix and *copying* of the FX settings is offered.

These options are very advanced and mighty tools to quickly do the impossible. Still there is no need to fear breaking something, as a simple click (or several) on the Undo button will get you back to where you started!

27.6 Recording a Submix - Loopback

TotalMix includes an internal loopback function, from the Hardware Outputs to the recording software. Instead of the signal at the hardware input, the signal at the hardware output is sent to the record software. This way, submixes can be recorded without an external loopback cable. Also the playback from a software can be recorded by another software.

The function is activated by the **Loopback** button in the Settings panel of the Hardware Outputs. In loopback mode, the signal at the hardware input of the corresponding channel is no longer sent to the recording software, but still passed through to TotalMix. Therefore TotalMix can be used to route this input signal to any hardware output. Using the subgroup recording, the input can still be recorded on a different channel.

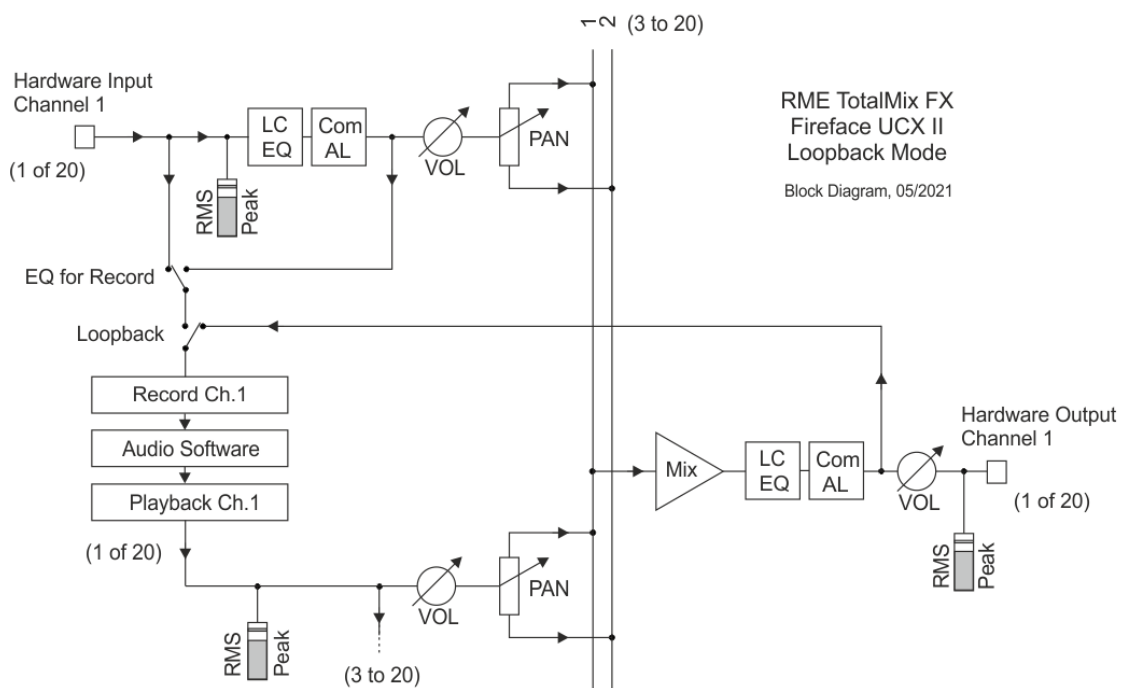

As each of the 10 stereo hardware outputs can be routed to the record software, and none of these hardware inputs get lost, TotalMix offers an overall flexibility and performance not rivalled by any other solution.

The risk of feedbacks, a basic problem of loopback methods, is low, because the feedback can not happen within the mixer, only when the audio software is switched into monitoring mode.

The block diagram shows how the software's input signal is played back, and fed back from the Hardware Output to the software input.

The block diagram also shows why with activated Loopback the EQ of the Hardware Output is now within the record path. With Loopback active the EQ of the input is not in the record path, only in the monitoring path, even when the Option *DSP – EQ+D for Record* is activated.

Recording a Software's playback

In real world application, recording a software's output with another software will show the following problem: The record software tries to open the same playback channel as the playback software (already active), or the playback one has already opened the input channel which should be used by the record software.

This problem can easily be solved. First make sure that all rules for proper multi-client operation are met (not using the same record/playback channels in both programs). Then route the playback signal via TotalMix to a hardware output in the range of the record software, and activate Loopback for recording.

Mixing several input signals into one record channel

In some cases it is useful to record several sources into only one track. For example when using two microphones recording instruments and loudspeakers, TotalMix' Loopback mode saves an external mixing desk. Simply route/mix the input signals to the same output (third row), then redefine this output into a record channel via Loopback. This way any number of input channels from different sources can be recorded into one single track.

27.7 MS Processing

The mid/side principle is a special positioning technique for microphones, which results in a mid signal on one channel and a side signal on the other channel. This information can be transformed back into a stereo signal quite easily. The process sends the monaural mid channel to left and right, the side channel too, but phase inverted (180°) to the right channel. For a better understanding: the mid channel represents the function L+R, while the side channel represents L-R.

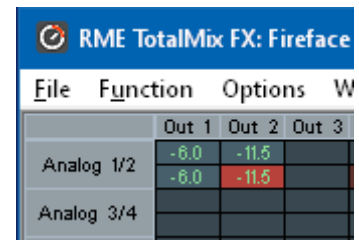

File	Function	Options	W	
		Out 1	Out 2	Out 3
Analog 1/2		-6.0	-11.5	
Analog 3/4		-6.0	-11.5	

During record the monitoring needs to be done in 'conventional' stereo. Therefore TotalMix also offers the functionality of a M/S-decoder. Activation is done in the Settings panel of the Hardware Input and Software Playback channels via the **MS Proc** button.

The M/S-Processing automatically operates as M/S encoder or decoder, depending on the source signal format. When processing a usual stereo signal, all monaural information will be shifted into the left channel, all stereo information into the right channel. Thus the stereo signal is M/S encoded. This yields some interesting insights into the mono/stereo contents of modern music productions. Additionally some very interesting methods of manipulating the stereo base and generating stereo effects come up, as it is then very easy to process the side channel with Low Cut, Expander, Compressor or Delay.

The most basic application is the manipulation of the stereo width: a change of the level of the side channel allows to manipulate the stereo width from mono to stereo up to extended.

28. MIDI Remote Control

28.1 Overview

TotalMix can be remote controlled via MIDI. It is compatible to the widely spread Mackie Control protocol, so TotalMix can be controlled with all hardware controllers supporting this standard. Examples are the Mackie Control, Tascam US-2400 or Behringer BCF 2000.

Additionally, the stereo output faders (lowest row) which are set up as *Main Out* in the Control Room section can also be controlled by the standard **Control Change Volume** via **MIDI channel 1**. With this, the main volume of the Fireface is controllable from nearly any MIDI equipped hardware device.

MIDI Remote Control always operates in View *Submix* mode, even when the View Option *Free* is currently selected in TotalMix FX.

28.2 Mapping

TotalMix supports the following Mackie Control surface elements*:

Element:	Meaning in TotalMix:
Channel faders 1 – 8	volume
Master fader	Main Out channel fader
V-Pots 1 – 8	pan
pressing V-Pot knobs	pan = center
CHANNEL LEFT or REWIND	move one channel left
CHANNEL RIGHT or FAST FORWARD	move one channel right
BANK LEFT or ARROW LEFT	move eight channels left
BANK RIGHT or ARROW RIGHT	move eight channels right
ARROW UP or Assignable1/PAGE+	move one row up
ARROW DOWN or Assignable2/PAGE-	move one row down
EQ	Master Mute
PLUGINS/INSERT	Master Solo
STOP	Dim Main Out
PLAY	Talkback
PAN	Mono Main Out
FLIP	Speaker B
DYN/INSTRUMENT	TrimGains
MUTE Ch. 1 – 8	Mute
SOLO Ch. 1 – 8	Solo
SELECT Ch. 1 – 8	Select
REC Ch. 1 – 8	select output bus (Submix)
RECORD	Recall
F1 - F8	load Snapshot 1 - 8
F9	select Main Out
F10 - F12	select Cue Phones 1 - 3

*Tested with Behringer BCF2000 Firmware v1.07 in Mackie Control emulation for Steinberg mode and with Mackie Control under Mac OS X.

28.3 Setup

Open the Preferences dialog (menu Options or F3). Select the MIDI Input and MIDI Output port where your controller is connected to.

When no feedback is needed select NONE as MIDI Output.

Check *Enable MIDI Control* in the Options menu.

28.4 Operation

The channels being under Mackie MIDI control are indicated by a colour change of the name field, black turns to brown.

The 8-fader block can be moved horizontally and vertically, in steps of one or eight channels.

Faders can be selected to gang them.

In Submix View mode, the current routing destination (output bus) can be selected via REC Ch. 1 – 8. This equals the selection of a different output channel in the lowest row by a mouse click when in Submix View. In MIDI operation it is not necessary to jump to the lowest row to perform this selection. This way even the routing can be easily changed via MIDI.

Full LC Display Support. This option in Preferences (F3) activates complete Mackie Control LCD support with eight channel names and eight volume/pan values. When *Full LC Display Support* is turned off, only a brief information about the first fader of the block (channel and row) is sent. This brief information is also available on the LED display of the Behringer BCF2000.

Disable MIDI in Background (menu Options, Settings) disables the MIDI control as soon as another application is in the focus, or in case TotalMix has been minimized. This way the hardware controller will control the main DAW application only, except when TotalMix is in the foreground. Often the DAW application can be set to become inactive in background too, so that MIDI control is switched between TotalMix and the application automatically when switching between both applications.

TotalMix also supports the 9th fader of the Mackie Control. This fader (labelled Master) will control the stereo output faders (lowest row) which are set up as *Main Out* in the Control Room section.

28.5 MIDI Control

The hardware output which is set up as *Main Out* can be controlled by the standard **Control Change Volume** via **MIDI channel 1**. With this, the main volume of the Fireface is controllable from nearly any MIDI equipped hardware device.

Even if you don't want to control all faders and pans, some buttons are highly desired to be available in 'hardware'. These are mainly the *Talkback* and the *Dim* button, and the monitoring options (listen to Phones submixes). Fortunately a Mackie Control compatible controller is not required to control these buttons, as they are steered by simple Note On/Off commands on MIDI channel 1.

The notes are (hex / decimal / keys):

Dim: 5D / 93 / **A 6**

Mono: 2A / 42 / **#F 2**

Talkback: 5E / 94 / **#A 6**

Recall: 5F / 95 / **B 6**

Speaker B: 32 / 50 / **D3**

Cue Main Out: 3E / 62 / **D 4**

Cue Phones 1: 3F / 63 / **#D 4**

Cue Phones 2: 40 / 64 / **E 4**

Cue Phones 3: 41 / 65 / **F 4**

Cue Phones 4: 42 / 66 / **#F 4**

Snapshot 1: 36 / 54 / **#F 3**

Snapshot 2: 37 / 55 / **G 3**

Snapshot 3: 38 / 56 / **#G 3**

Snapshot 4: 39 / 57 / **A 3**

Snapshot 5: 3A / 58 / **#A 3**

Snapshot 6: 3B / 59 / **B 3**

Snapshot 7: 3C / 60 / **C 4**

Snapshot 8: 3D / 61 / **#C 4**

Trim Gains: 2D / 45 / **A 2**

Master Mute: 2C / 44 / **#G 2**

Master Solo: 2B / 43 / **G 2**

Note: The hex value is standardized, the key is not. If it doesn't work try all notes one octave lower.

Furthermore all faders of all three rows can be controlled via simple **Control Change** commands. The format for the Control Change commands is:

Bx yy zz

x = MIDI channel

yy = control number

zz = value

The first row in TotalMix is addressed by MIDI channels 1 up to 4, the middle row by channels 5 up to 8 and the bottom row by channels 9 up to 12.

16 Controller numbers are used: 102 up to 117 (= hex 66 to 75). With these 16 Controllers (= faders) and 4 MIDI channels each per row, up to 64 faders can be controlled per row (as required by the HDSPe MAD1).

Examples for sending MIDI strings:

- Set input 1 to 0 dB: B0 66 68
- Set input 17 to maximum attenuation: B1 66 0
- Set playback 1 to maximum: B4 66 7F
- Set Output 16 to 0 dB: B8 75 68

Note: Sending MIDI strings requires to use programmer's logic for the MIDI channel, starting with 0 for channel 1 and ending with 15 for channel 16.

Further functions:

- Trim Gains On: BC 66 xx (BC = MIDI channel 13, xx = any value)
- Trim Gains Off: BC 66 xx or select a submix

Select submix (fader) in third row:

- channel 1/2: BC 68/69 xx
 - channel 3/4: BC 6A/6B xx
- etc.

Input Gain control is available via CC9, value range as the gain itself (up to 65). The MIDI channel determines the controlled channel, from 1 to 16 (UCX II: 1 to 8). For this to work, *Enable MIDI Control* in the Options menu has to be activated.

The **Reverb** and **Echo User Presets** can be changed via MIDI CC: B2 0C nn for Reverb preset 1 to 16, B3 0C nn for Echo preset 1 to 16

28.6 Stand-Alone MIDI Control

When not connected to a computer, the Fireface UCX II can be controlled directly via MIDI. The **stand-alone MIDI control mode** is activated in the unit's menu *Options, Hardware/Diagnosis, Standalone MIDI*.

Note: When not needed the stand-alone MIDI operation should not be active, as the unit will react on MIDI notes after power-on, and will also send MIDI notes.

Control is performed via both the **Mackie Control protocol** and some **standard** MIDI functions (see below). In stand-alone mode not all functions known from TotalMix are available, because some of them aren't hardware, but software routines. Functions like *Talkback, Mono, Solo, relative* ganging of the faders, *Monitor Main* and *Monitor Phones* are realized by complex software code, therefore not available in stand-alone MIDI control operation.

Still many functions, and especially the most important functions to control the Fireface UCX II, are implemented in hardware, thus available also in stand-alone mode:

- All faders and pans of the first and third row
- Mute of the input signal per channel
- Ganging via 'Select'
- Choice of the routing destination, i.e. the current submix
- Sending of LED and display data to the MIDI controller

The second row (software playback) is skipped. The Fireface UCX II sends display data as brief information, enabling an easy navigation through lines and rows. Other data like PAN and miscellaneous status LEDs are supported as well.

In stand-alone mode the unit always operates in **View Submix** mode. Only this way the routing destination can be changed, and several mixdowns/submixes can be set up quickly and easily. If the current TotalMix setup is transferred into the Fireface via 'Flash current mixer state', the currently selected submix output is also pre-configured in the hardware for stand-alone MIDI remote operation.

Mackie Control Protocol

The stand-alone operation supports the following Mackie Control surface elements*:

*Tested with Behringer BCF2000 Firmware v1.07 in Mackie Control emulation for Steinberg mode.

Element:	Meaning in Fireface:
Channel faders 1 – 8	volume
V-Pots 1 – 8	pan
pressing V-Pot knobs	pan = center
CHANNEL LEFT or REWIND	move one channel left
CHANNEL RIGHT or FAST FORWARD	move one channel right
BANK LEFT or ARROW LEFT	move eight channels left
BANK RIGHT or ARROW RIGHT	move eight channels right
ARROW UP or Assignable1/PAGE+	move one row up
ARROW DOWN or Assignable2/PAGE-	move one row down
STOP	Dim Main Out
EQ	Master Mute
MUTE Ch. 1 – 8	Mute
SELECT Ch. 1 – 8	Select
REC Ch. 1 – 8	select output bus (current submix)
F1 – F6	load Setup 1 - 6

Additionally the following functions are available via simple MIDI notes on MIDI channel 1:

Dim: 5D / 93 / A 6

Setup 1: 36 / 54 / #F 3

Setup 2: 37 / 55 / G 3

Setup 3: 38 / 56 / #G 3

Setup 4: 39 / 57 / A 3

Setup 5: 3A / 58 / #A 3

Setup 6: 3B / 59 / B 3

Loading the Setups stored in the device enables a quick configuration change of the UFX. With this any possible operation state can be activated by the push of a button at any time.

28.7 Loopback Detection

The Mackie Control protocol requires feedback of the received commands, back to the hardware controller. So usually TotalMix will be set up with both a MIDI input and MIDI output. Unfortunately any small error in wiring and setup will cause a MIDI feedback loop here, which then completely blocks the computer (the CPU).

To prevent the computer from freezing, TotalMix sends a special MIDI note every 0.5 seconds to its MIDI output. As soon as it detects this special note at the input, the MIDI functionality is disabled. After fixing the loopback, check *Enable MIDI Control* under Options to reactivate the TotalMix MIDI.

28.8 OSC (Open Sound Control)

Besides simple MIDI notes, the Mackie Protocol and Control Change commands, TotalMix FX can also be controlled by the Open Sound Control, OSC. For details on setup and usage see chapter 25.8.3.

An OSC implementation chart can be downloaded from the RME website:

http://www.rme-audio.de/downloads/osc_table_totalmix_new.zip

RME offers a free iPad template for the iOS app TouchOSC (by Hexler, available in the Apple App-Store):

http://www.rme-audio.de/downloads/tosc_tm_ipad_template.zip

The RME forum hosts further information, more templates (iPhone...) and lots of useful user feedback.

29. DAW Mode

Users that work exclusively with their DAW software, and don't want to use TotalMix FX for additional routing tasks, need a way to be sure that TotalMix FX currently doesn't change the DAW's routing. While *Reset Mix* can do so, those users would be better served with a very simple surface that offers the interface's hardware controls (gain, phantom control, instrument...), but guarantees a straight 1:1 routing for all playback channels, and has no hardware monitoring of the input channels (which is then done by the DAW software).

For such cases TotalMix FX includes an alternative operating mode. It can be booted into the so called *DAW mode*. This simplified interface is for anyone performing all monitoring and routing within the DAW. The DAW mode restarts TM FX into a light version with just two rows, no playback row, and no mixing faders in the input row. Routing is 1:1 only. Just the hardware controls (if existing) and hardware output levels are available.

To change the current mode go to the menu, Options, and click on *Operational Mode*. Choices are *Full Mode* (default, mixer active, all routing options available), and *Digital Audio Workstation Mode* (straight playback routing, no input mix).

Several useful, advanced features are still available in TotalMix FX in DAW mode:

- Talkback, External Input
- Phones definition and handling with Talkback
- Speaker A / B
- All FX (EQ, Dynamics, Echo, Reverb)
- Mute and Solo
- Cue / PFL

30. TotalMix Remote

TotalMix Remote is a remote control for TotalMix FX v1.50 and up, to control the hardware mixer and effects in RME audio interfaces. TotalMix Remote mirrors the current state of the host system on the iPad and Windows/Mac computers - the entire mixing state, the complete routing, all FX settings, up to the level meters, and everything in real-time. TotalMix Remote supports up to three hosts with multiple interfaces each, allowing Apple's popular iPad and Windows/Mac computers to adjust all the mixer and FX settings from a distance, via Ethernet and WiFi.

Supported Hardware

TotalMix Remote communicates with TotalMix FX 1.50 or up. Any RME hardware that can be used with TotalMix FX is supported automatically.

Quick Start

On the host (the computer with the connected audio interface) go to the TotalMix FX menu *Options, Network Remote Settings*. Click *Enable TotalMix Remote Server* to start this service. Under Windows a Firewall warning will come up. Allow TotalMix FX or it won't work. This dialog also shows the host's IP, like 192.168.1.45.

Make sure both host and remote computer / iPad reside in the same network. Start TotalMix Remote on the remote computer / iPad (not on the host!). On the iPad, tap on the gear symbol in the upper right corner, then on *Host Connection Settings*. On Windows / Mac either the dialog comes up automatically or can be called from the *Search Connected Hosts* dialog. Type in the **host's** IP address (like 192.168.1.45) into the IP field of *Host Connection 1*, and make sure it is activated. The port defaults to 7009 and usually must not be changed. In case this port is unexpectedly occupied a warning message will be issued. Choose a different port then. Under Windows a Firewall warning will come up. Allow TotalMix Remote or it won't work.

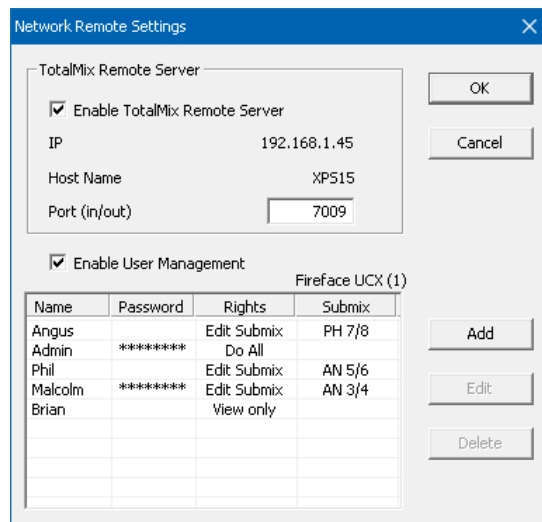

Tap Done on top or click Ok. In the mixer view the state should change from *offline* to *connected* within a few seconds.

The Add button provides access to the user-management that can be configured in detail. Here users can be defined, with and without a password, and the rights can be assigned to viewing only, changing a specific sub-mix, or full access. For example, using TotalMix FX as a monitor controller for all band members, user-management prevents the bassist from changing the guitarist's monitor mix. Or the drummer making himself too loud. Etc.

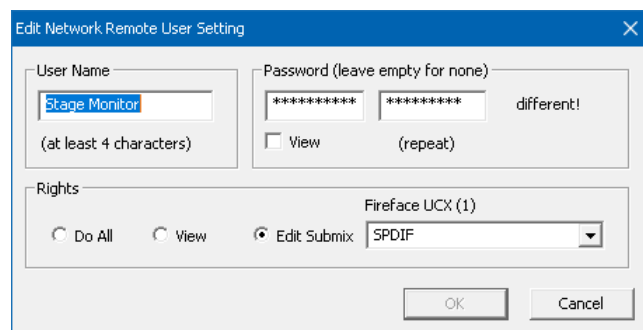

Tip

The remotes have the option *Sync Channel Layouts* active as default (in Preferences). This option transfers the Layout Presets and the current Channel Layout state from host to remote. Apart from the channel width state this option makes a mirror-style setup most easy. But when using the remote as individual setup, make sure to disable this option to have independent Layout Presets on the remote.

Limitations

- Mixer View & GUI. When connected the remote computer / iPad will immediately have the complete routing and FX settings of the host, including mono and stereo channels, but not the host's GUI setup, like panel states open/closed of Settings/EQ/Dynamic, FX panel visibility, 2-Row or 3-Row mode and channel width. Channel width states can be stored as usual per Snapshot and completely as Workspace, locally on the remote computer. They need to be loaded manually after loading a Workspace on the host in case a 100% identical view is required.
- Workspaces. The Remote shows the Quick Workspaces (hotkey W on Windows/Mac) stored on the host, and allows to remotely load them. It is not possible to save complete Workspaces with mixer state from the Remote, or on the Remote. The Workspaces saved locally include GUI information only (Channel state wide/narrow, Channel Layouts, window size and position) and further local settings, to be able to have personalized views on the remote computer, independent from the view on the host.
- Real-time behaviour. Can suffer when the network is overloaded or the WiFi reception is insufficient. Level Meters will stutter then and faders do not move smoothly.
- Background operation on iPad - is not possible. This should not be a problem as the Remote doesn't need to do anything in background, and when called up very quickly reconnects and synchronizes its state.
- State. Is shown in the upper right corner (offline or connected), or the Mac/Windows title bar.

Downloads

Remote Windows

http://www.rme-audio.de/downloads/tmfx_win_remote.zip

Remote Mac

http://www.rme-audio.de/downloads/tmfx_mac_remote.zip

iPad

From the Apple App Store, search for 'TotalMix Remote'. This app is free.



User's Guide



Fireface UCX II

▶ Class Compliant Mode

31. General

The Fireface UCX II operates in two different modes: **driver-based USB2** and **Class Compliant**. The latter describes a standard that is natively supported by operating systems like Windows, Mac OS X and Linux. No proprietary drivers are required, the device will be directly recognized when the CC firmware is loaded. The natively available features will be limited in comparison to those provided by the RME driver for the UCX II. For example there will be no hardware settings, no (Total) Mix and no settings for the effects. However, on the iPad (iOS) the UCX II can be fully controlled by the optional app *TotalMix FX for iPad*.

The Class Compliant mode can be activated and deactivated directly at the unit, as long as it is not connected to a Mac or PC: SETUP/REV, Options, Hardware/Diagnosis, CC Mode On.

Neither Windows nor Mac Class Compliant support is relevant, though, since there are dedicated and matured drivers for both OS X and Windows, which provide ALL the device's features at lowest latencies. The main reason for implementing Class Compliant mode was to allow connecting the UCX II to an **Apple iPad®!**

The UCX II provides the iPad with the professional analog I/O connections it lacks. Superb microphone preamps with EQ, dynamics, even with the AutoSet feature, in addition to professional balanced line outputs, and hi-power headphone outputs which also excel with high impedance phones. Plus level and gain adjustments, AES and ADAT I/O, reverb, echo, zero latency monitoring, digitally via USB, without any limitation in quality, at up to 96 kHz and 24 bit. And of course a Sysex-capable MIDI I/O.

DURec, the direct USB recording on USB memory stick or portable external hard drive, is also available in Class Compliant mode. Especially in regard to recording on the iPad it is not only a world-wide unique and extraordinary feature, it also proves to be something you don't want to miss in real-world usage.

TotalMix FX for iPad also provides full support for the optional ARC USB, an Advanced Remote Control specifically for the UCX II, making operation and handling of the iPad DAW even more easy and comfortable.

32. System requirements

- UCX II in Class Compliant mode
- Any Apple iPad with at least iOS 6
- iPhone with iOS 7 or up
- Apple iPad Camera Connection Kit or Lightning to USB adapter
- iPad Pro: no adapter, only a USB-B to USB-C cable

33. Operation

Activation of the Class Compliant mode

Remove USB cable from the UCX II. Press SETUP/REV so that the page *Options* is shown in the display.

Turn the encoder until *Hardware/Diagnosis* appears in the display. Pushing the encoder the knob symbol changes into a double arrow symbol. Now turn the encoder to move the cursor vertically through the menu page. Scroll down to the entry *CC Mode*. Press the encoder again to change back to the knob symbol, then turn the encoder to select *On*. The unit now reboots. After that the field USB in the level meter screen shows CC.

Below CC Mode you'll find the option CC Mix, which offers different modes and routings of the playback signals. See chapter 36.

Connect the USB cable to the UCX II and the Lightning to USB adapter. Start the iPhone/iPad and plug-in the adapter. If everything works as expected, the unit will enter CC host mode, indicated by the yellow CC field. Audio playback will automatically be performed by the UCX II, using analog outputs 1/2 and the phones outputs 7/8 (with routing option *8 Ch. + Phones* activated).

33.1 Useful hints

If the unit is not in CC mode, the iPhone/iPad will detect an incompatible USB device, and display a message saying "Cannot Use Device – The connected USB device is not supported".



No sound: Incorrect output gain settings, see chapter 36. Note that the iPhone/iPad volume control is inactive during USB operation.

If the unit does not enter Host mode: Remove and reconnect the Connection Kit.

Since 2016 Apple offers another version of the *USB to Lightning Adapter*, called *Lightning to USB 3 Camera Adapter*. It has an additional Lightning port for power supply that charges the iPhone/iPad even when used with the UCX II.

The iPad Pro with its USB-C socket operates as regular USB host. Therefore no adapter is needed, only a matching cable (USB-C to USB-B).

33.2 Class Compliant Mode under Windows and Mac OS X

The Class Compliant mode of the UCX II is not compatible to Windows. The UCX II will be detected, but automatic driver installation will fail.

Mac OS X can be used in Class Compliant mode, although without Settings dialog and TotalMix FX it makes not much sense to do so. At least one can use the *Audio MIDI Setup* to check the available CC modes.

The Audio window in the Audio MIDI Setup lists four modes: 8, 14, 16 and 20 channels. The sample rate shown is the one set in the UCX II.

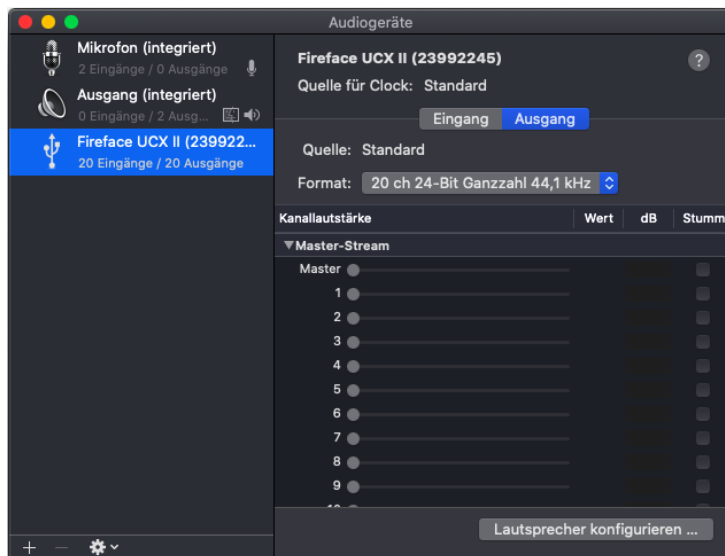

With 8 and 14 channels chosen up to 192 kHz sample rate can be used. Under iOS 192 kHz is not possible, as there exists no way to select the second or further *Alternate Setting* on the record side. iOS and all apps always use the first setting, 20 channels, which limits the sample rate for record and playback to 96 kHz.

34. Supported Inputs and Outputs

When connected to an iPhone/iPad, the analog mic/line input 1 works with mono apps, inputs 1 and 2 with stereo apps (both dual mono and stereo), and up to 8 inputs with 8-channel applications like *MultiTrack DAW* and *Music Studio*. *Garage Band* supports all inputs, but only two at a time. *Auria* and *Cubasis* can record all 20 inputs simultaneously.

Playback will use the rear-side analog outputs 1 and 2, or even more channels if the app supports such operation. The UCX II can optionally copy the playback channels 1/2 to outputs 7/8, SPDIF and ADAT 1/2 for easier monitoring (CC Mix: *8-Channel + Phones*). The current routing can easily be checked and verified with the level meter display. All outputs can be processed independently (volume, EQ, dynamics, FX return).

Configuring the UCX II is ideally done via the app *TotalMix FX for iPad*, otherwise by loading Setups. These are written into the unit while operated with PC/Mac via TotalMix FX, also storing control clock mode master or AutoSync and the current sample rate.

Using RME's iPad app the Mix modes are automatically disabled as all routing is now controlled by the app.

The UCX II (and with it the iPhone/iPad) will be synchronized to an external digital sample rate if there is a valid digital input signal. With a wrong sample rate heavy audio noise will occur. Without an AES/SPDIF or ADAT input signal the UCX II enters master mode and uses the sample rate set by Mac OS X or iOS (the app in use).

While the MIDI I/O will send and receive Sysex messages, not all apps are ready to do this. The app *Midi Tool Box* can be used to verify that the UCX II is working correctly.

35. Front panel operation

The front panel operation is identical to the one under Windows and OS X, or standalone operation. The display therefore gives the usual easy access to all features and offers a quick editing of: input gains, playback levels, routing and monitoring, echo, reverb, EQ, dynamics, sample rate, status of the optical output (ADAT/SPDIF), and much more.

36. Audio Routing and Processing

In Class Compliant mode, the UCX II features operation very similar to normal operation with TotalMix FX, with two major differences:

- There is no second TotalMix row (no software playback channels), hence no individual routing or mixing of playback channels (unless the optional app *TotalMix FX for iPad* is used). These will always be connected either straight to the physical outputs (CC Mix 20 Ch.), or have an additional signal copy, see below.
- The input effects EQ/Dyn will always be active in the recording path

The UCX II can be pre-configured for CC mode via TotalMix FX under Windows/Mac by saving up to 6 configurations into its setup memory, see next chapter.

The input signal will pass through all activated functions of the TM FX input channel, namely settings, EQ, and Dynamics, and is then sent to the iPhone/iPad. Like under Windows and Mac, the input fader setting controls direct monitoring to the specified outputs. The FX send control for echo/reverb is also active.

! As in normal TotalMix FX use, the options *Stereo Width*, *MS Proc* and *Phase L/R* are NOT within the recording path, but in the monitor path. This is technically determined and can not be changed.

The iPhone/iPad output signal passes through all activated functions of the TM FX hardware outputs, namely settings, EQ, and dynamics. Configuring the Phones output is done by output channels 7/8.

CC Mix Modes

The CC Mix modes can be activated at any time and do not influence the mixer state loaded via the Setups, as Mix modes only influence the playback routing. The current routing can easily be checked and verified with the level meter display.

The unit offers four different *Mix modes* to ease using the CC mode without *TotalMix FX for iPad*. They copy playback signals to various channels.

TotalMix App. Locks various settings in several menus to avoid conflicts with *TotalMix FX for iPad*, in case the app is not in background mode. Note that all copy modes are automatically disabled when the TotalMix app is detected.

8 Ch. + Phones. 8 channels of playback. Channels 1/2 are copied to Phones, SPDIF and ADAT 1/2. Channels 3/4 are copied to AES and ADAT 3/4, channels 5/6 and 7/8 to ADAT 5/6 and 7/8.

8 Ch. Playback. Same, but no copy of 1/2 to Phones, so the output Phones (7/8) is available for separate playback.

20 Ch. Playback. No copy mode active, all 20 channels are available separately.

37. Setups

TotalMix FX can transfer all current settings to the device (Options/Store Current State into Device). There are six memory slots (Setups) available. An example:

- Inputs with no processing, gain set to +30 dB and phantom power active. Outputs without processing, faders for 1/2 set to 0 dB, 9/10 at – 20 dB, clock mode master, saved in Setup 1.
- Inputs with Compressor, Factory Preset Mix Limiter (digital overload protection), gain set to +30 dB, no phantom power, outputs 1/2 with EQ (factory preset Modern Bass Treble), outputs 9/10 with EQ (factory preset Cheap Phones Compensation), faders for 1/2 at 0 dB, 9/10 at -20dB, clock mode AutoSync, saved in Setup 2.

Via the menu SETUP/REV, Setups, one can switch between setups 1 and 2 at any time, alternating between entirely different configurations. Further examples would be activating reverb/echo, or temporary monitoring of the input signal. Very comfortable is the use of the Advanced Remote USB, as its buttons can load the Setups 1 to 6 directly

On the iPad the optional app *TotalMix FX for iPad* gives full control of all functions and parameters in real-time and with full overview, similar to working under Windows and Mac.

User's Guide



Fireface UCX II

▶ **DURec™ - Direct USB Recording**

38. Direct USB Recording

38.1 Overview

The Fireface UCX II can record and playback up to 40 channels of audio via the DUREC USB port on the rear panel. This functionality is provided by the internal DSP and is therefore independent from a Windows or Mac computer connected via USB.

As all settings are also available directly at the unit it is possible to even record a whole live concert completely without a computer. Music that was copied onto the stick earlier can be played back anytime on any outputs.

The following chapters explain features, capabilities, but also restrictions of this functionality.

38.2 Operation

In *TotalMix FX* the **DURECORDER** panel controls the record and playback functions. The configuration of record/playback is stored in the workspace, therefore identical in all eight Snapshots. In case the panel is not fully visible minimize one of the other panles by a click on the arrow in the respective title bar.

File selection. Multi-purpose dialog. Displays detailed information on current USB media conditions. No Media (no media recognized), Initializing (Medium is currently initialized), FS Error (File System Error, no FAT32), No Files (no audio files found).

In case the media contains audio material, files can be selected from the file dialog box after a click on the arrow to the right.

Clicking on the red button will initiate recording, and a new file will be created immediately, with an increment file number according to present files.

Info. Opens a dialog with information about the selected file: file name, number of channels, sample rate, length (time), free memory.

Delete. Offers direct erasure of the current file. After deletion, the media is read again (Initializing) which can take some time on larger hard drives. Deleting further files is possible even while the initialization is still in progress.

Status Panel. The overview window shows current position or length of the file, free memory, current USB Load and Errors.

Position display. The position of the knob shows the current playback position within the file. The knob, and with it the playback position, can also be changed by dragging it with the mouse.

Transport bar. Stop, Play/Pause and Record. Two clicks on Stop cause a jump to the beginning of the file. Below: Previous File / Next File and Playback Modes with the options Single, UFX single, Continuous, Single next, Repeat single, Repeat all. See next page.

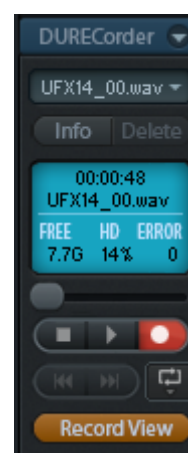

Record View. Switches from Mixer View to Record View. In Record View Mute and Solo buttons in first and third row are replaced by Play and Record (Arm) buttons.

A click on the Playback button opens a dialog to assign channels. A flashing playback button indicates playback channels have been selected that are not found in the played back file. A playback is not only possible at the outputs but also at the mixer input. This way, signals can also be processed with Echo/Reverb and mixed with any other signal to any output

Note: The level meters only show the DURec playback signal when in *Post FX* mode.

The Record buttons behave in a similar way to other buttons in TotalMix: Activation/deactivation of all channels to the right by Ctrl + mouse click, flashing buttons when the maximum number of channels has been exceeded after changing the sample rate. When loading a different workspace during ongoing recording and playback, the configuration of record and playback is not updated or changed.



The display of the Fireface UCX II brings up the **Record/Playback** menu automatically when a storage medium is connected and recognized, or after pushing the REC/PLAY button.

File. Name of the currently selected file.

Status. This line changes its content depending on the current operation: information on the selected file, the ongoing or just completed recording: xx channels selected (number of channels armed for recording), SR xx kHz (sample rate), USB xx%, x Err (USB Load and number of errors).

Time. Length of the recording or current playback position. When selecting the record button at the unit the medium's remaining total record time is shown. Due to the limitation to 100 files the actual recording time may be shorter. In Stop and Playback mode turning the encoder allows to change the current playback position.

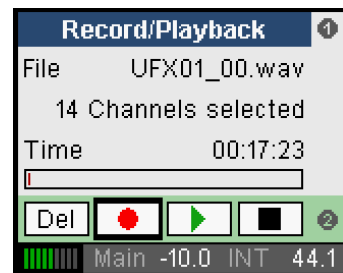

Transport Bar. Turning the encoder moves the cursor over *Del* (Delete), *Record*, *Play/Pause* and *Stop*. The selected function is initiated by pressing the encoder. During playback the buttons Del / Record will change to Previous File / Next File.

Turning the encoder brings up the **Rec/Play** Settings with subpages **USB Media**, **Record**, **Playback** and **Time & Date**.

USB Media.

DURec/Partition. Default is 1, which means the first partition found on the USB media will be used. On some media it will be necessary to use partition 2 or up.

Capacity. Storage size of the media.

Free. Free space on the media.

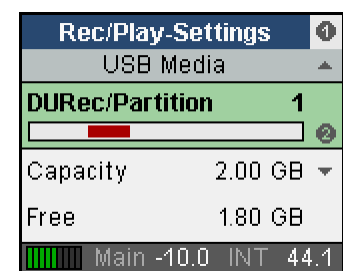

Record.

Remain (Rec.). The medium's remaining total record time (limited by disk space and a maximum of 100 files).

Free. Free space on the media.

Max R/W Time. The time needed for the read or write operation. Details see chapter 38.5.

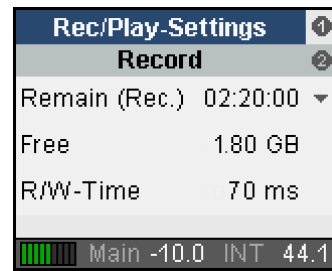

Playback.

Remain (File). Remaining play time of the current file.

Next. Shows and allows to select the next file to be played.

Play Mode. The following modes are available:

Single: Stop after playback of the current file

Single next: Stop after playback of the current file, file selection jumps to the next file. Start of playback therefore always continuous with the next file.

UFX single: Plays all consecutive files that belong to one recording session, when these files follow the UFX naming scheme.

Continuous: Plays all existing files consecutively.

Repeat single: The current file will be played back in a loop, unlimited.

Repeat all: Plays all existing files consecutively in a loop. After the last file playback starts again with the first file.

During playback it is possible to pre-select the next to be played file by navigating to the Next line and select any of the available files. Single mode is extended by the next file and will stop after that, unless another file had been selected again.

Continuous plays all existing files consecutively. Next can still be used to re-play or interactively change the playlist by selecting any file during playback.

UFX single plays all files following the incremental UFX name scheme (UFX01_00.wav, UFX01_01.wav, UFX01_02.wav etc). This feature can be used to build playlists by renaming other wav files to the same name scheme, then playing them via play mode UFX from a thumb drive.

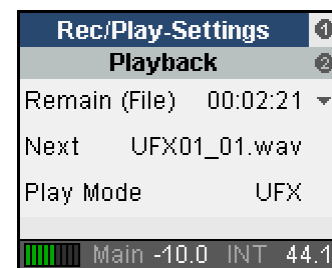

Time & Date.

The UCX II has a real-time clock that is set automatically when connecting the UCX II to a computer with TotalMix FX running. The clock is used to timestamp the recorded DUREC files with the current time and date values (file attribute). Time & Date can also be set manually using this easy to use dialog.

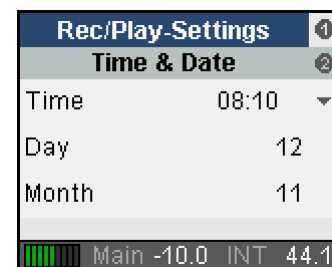

38.3 Limitations and Important Notes

The media must be formatted as FAT32, primary type. Logical partitions are not supported. With volumes having more than one partition, a different partition than default partition 1 can be selected in Rec/Play Settings, USB Media.

A recording is always stopped when the sample rate changes.

Changing the record configuration (armed channels) is not possible during an ongoing recording. Channels are recorded without placeholders and without labelling, in straight ascending order. For a playback on the exact same channels, the playback channels have to be selected accordingly in TM FX or the unit.

The recording is done at the current sample rate as 24 bit WAV file. A file can be up to 2 GB in size and includes all (up to 40) channels in interleaved format. The filename is UFX01_00.wav. After reaching the 2 GB limit a new file is automatically written, with an incremental file number (UFX01_01.wav). The UFX will write up to 100 files consecutively (UFX_01_99.wav). After that, a new recording has to be started (UFX02_00.wav).

At a sample rate of 48 kHz, up to 40 channels (all inputs and outputs), at 96 kHz 32 channels, at 192 kHz 16 channels can be selected. Therefore at 48 kHz and 96 kHz all available inputs and outputs can be recorded simultaneously. The actual number of channels that can be used error-free depends on the media, see chapter 38.5.

The playback from a storage device does not change the current sample rate. To match pitch and speed, the sample rate has to be set manually to the correct value. Playback can be assigned to multiple outputs.

The UFX can play back externally recorded WAV files, as long as these have 16 or 24 bit resolution.

The recording signal is taken before EQ and Dynamics, on both inputs and outputs. To record with EQ/Dyn, activate REC on an output and route a signal processed by the input EQ/Dyn to that output. The insert point of playback is at the same place.

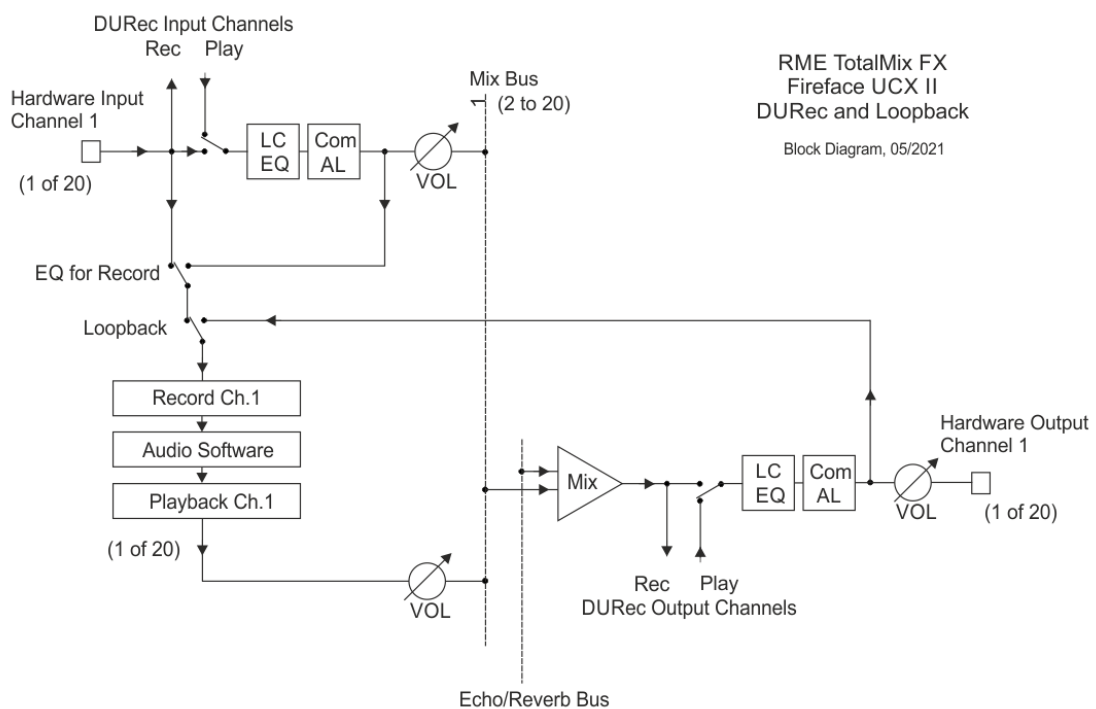

The block diagram shows the signal flow for various situations, depending on the state of *Loopback*, *EQ for Record* and *Play active*. In the diagram Loopback and EQ are switched to off, but a playback is active in the input.

Some extra notes that are worth to be pointed out again:

- The signal recorded by audio software is usually that from the input. But when the option *DSP – EQ for Record* has been activated in the Settings dialog the software receives the Play input signal – as soon as a playback is started from the USB device.
- On an output Echo/Reverb gets recorded. To add Echo/Reverb to a playback the playback must be assigned to an input.
- A playback via USB can not be processed and immediately recorded again via DURec. While the block diagram seems to present such functionality please remember that DURec can do only one thing at a time – record *or* playback.

38.4 Multichannel WAV File Batch Processor

To avoid any kind of performance problems the recording of all channels is done into a single multi-channel interleaved file, guaranteeing highest streaming performance with any media.

Most digital audio workstations can import such multi-channel wave files directly into their projects. Also there already exist some free tools to split those multi-channel files into standard stereo or single channel files. The need for the special RME tool arises from the fact that fully compatible wave files can not be bigger than 2 GByte. With higher track counts and longer recording times this limit is quickly exceeded. The DURec process of the Fireface UCX II therefore writes multiple consecutive files of 2 GByte each. Importing these files into typical DAWs requires the user to adjust and align the content of each file to the previous one.

RME's Multichannel WAV File Batch Processor offers the easiest way to combine and split those multichannel interleaved files into single or dual channel files. The content of consecutive files is automatically combined into a single file. In the rare case that these again exceed the 2 GB limit the tool automatically writes RF64 files. The Mac version can also write CAF (Core Audio Format) files.

The RME tool can also perform multiple conversions of different recordings. Once all the single tasks are set up the software will process them one after the other automatically.

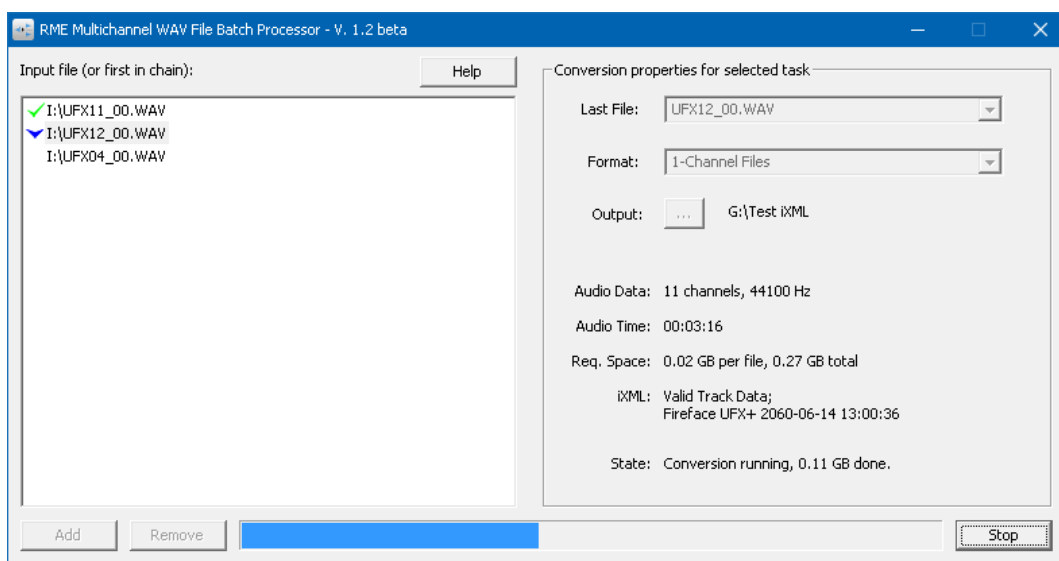

The free software is available for Windows and Mac OS X and can be downloaded from the RME website, www.rme-audio.com, section **Downloads / Software**.

The Fireface UCX II adds some meta data to the recorded files, like date, time, recording device and channel number. The WAV File Batch Processor reads these data and writes them accordingly into the generated wav files. Additionally the processor adds the channel info to the file names. For example UFX01_I_05.wav is the record data of input channel 5, and UFX01_O_03.wav the recording of output channel 3.

38.5 Technical Background

Compared to a computer, the rear DUREC USB port of the UCX II has a limited buffer to compensate for interruptions to the write process. Unfortunately, these occur quite often with USB thumb drives, and sometimes are of an astonishing duration. The effect of the buffer depends on the amount of data to be transmitted, which is the combination of sample rate and channel count. The higher the data rate, the shorter the available buffer time. When a medium causes a pause that is longer than the buffer time, data is lost.

Information on the performance of the record media

To determine the highest record channel count of a hard drive or USB thumb drive the UCX II displays several values. On the page *Record/Playback*:

USB Load: should exceed 80% only for a short time.

Errors: Each single error means a buffer with a bigger block of samples has been lost. Although that is not always audible only a display of 0 is acceptable.

On the page *USB Media, Record*:

Max R/W Time (Read/Write Time): This constantly updated value is the quickest way to identify slow media that suffer from interruptions of the write process. Quick media like SSD and hard drives show values in the range of 80 to 100 ms at full channel count, while thumb drives can show more than 800 (!) ms.

Checking the performance of the record media

Different USB based media can be used for recording – but USB thumb drivers, even USB 3.0 models, are often too slow to record more than a few channels.

To determine the maximum channel count of a medium, activate 16 channels at a sample rate of 192 kHz. This configuration causes the highest data throughput (9.2 MB/s) with the smallest internal buffer. Most hard drives manage an error-free recording until the drive is full. In case the UCX II shows errors, reduce the number of channels step by step until no errors are shown anymore.

Note: 16 channels at 192 kHz equal 32 channels at 96 kHz and 64 channels at 48 kHz (9.2 MB/s).

A more realistic example is the recording of all 20 inputs and of two submixes (24 channels) at 48 kHz. With 3.4 MB/s data transfer better USB sticks will handle this task without any problem. The display of USB Load, Max Write Time and errors quickly reveals where the limit of the particular thumb drive lies.

Note: Playback is usually not affected by the mentioned performance problems.

Examples of high performance media for DURec

An example of a USB thumb drive that handled the maximum transfer bandwidth error-free was the *SanDisk Extreme Memory*. It worked without write pausing under USB 2. It was able to write 40 channels at 96 kHz on a UFX+, at USB loads below 90% and R/W Times below 100 ms. When Western Digital bought SanDisk some years ago the controller of this particular model was changed and performance from then on was disappointing.

Fortunately these days there are many alternatives, even for low costs:

- SSD based hard drives. Use a cheap SATA SSD, add a cheap USB 3 to SATA adapter cable, format the SSD to FAT32 – full performance will be available.
- SSD based Thumb drives. While these are a bit more expensive than standard USB Thumb drives, they are still not much expensive (not anymore), and offer stellar write performance without pausing.
- Mobile hard drives, often directly with USB port. These old dogs usually work ok and can be used perfectly after formatting them to FAT32.
- Micro SD cards. Used in a small micro SD to USB adapter they look like a miniature Thumb drive. These cards are built to not have the dreaded write pause, because in cameras – their main application – there is not much memory for buffering. Fast serial shots as well as high resolution videos have the same demand as DURec. And these micro SD cards are cheap as well. Note the exact type details for best performance: the card should have **U3 and V30** specification. Additionally these cards are usually formatted with exFAT. They need to be wiped completely, a new volume created and formatted with FAT32 to be accepted by the UFX+.

User's Guide



Fireface UCX II

► **Technical Reference**

39. Technical Specifications

39.1 Analog

AD, Line In 5-8, rear

- Resolution AD: 24 bit
- Signal to Noise ratio (SNR): 112 dB RMS unweighted, 115 dBA
- Frequency response @ 44.1 kHz, -0.1 dB: 5 Hz – 20.8 kHz
- Frequency response @ 96 kHz, -0.5 dB: 3 Hz – 45.8 kHz
- Frequency response @ 192 kHz, -1 dB: 2 Hz – 92 kHz
- THD: < -110 dB, < 0.00032 %
- THD+N: < -104 dB, < 0.00063 %
- Channel separation: > 110 dB
- Input: 6.3 mm TRS jack, electronically balanced
- Input impedance: 8 kOhm unbalanced, 12 kOhm balanced
- Input sensitivity switchable to +19 dBu and +13 dBu
- Variable gain: 0 to +12 dB
- Minimum level for 0 dBFS: +1 dBu, -1.2 dBV

Line In 3-4, front

- as AD, but:
- Additional digital Gain stage: 0 up to +12 dB
- Maximum input level, +19 dBu, Gain 0 dB: Line +19 dBu, Inst +13 dBu
- Maximum input level, +13 dBu, Gain 12 dB: Line +1 dBu, Inst -5 dBu
- Input impedance: Instrument 1 MOhm. Line 13 kOhm balanced, 9 kOhm unbalanced
- Input Gain Inst: +6 dB
- Input mode: Line balanced (TRS), Inst unbalanced (TS)

Microphone In 1-2, front

As AD, but:

- Input: XLR, electronically balanced
- Input impedance: 5.4 kOhm
- Gain range: 75 dB
- Maximum input level, Gain 0 dB: +18 dBu
- Maximum input level, Gain 75 dB: -57 dBu
- EIN: -128 dBu A-weighted, 60 dB gain, 150 Ohm, 20 Hz – 20 kHz

Line In 1-2

As AD, but:

- Input: TRS, electronically balanced
- Input impedance: 10 kOhm balanced, 5 kOhm unbalanced
- Maximum input level, Gain 0 dB: +24 dBu
- Maximum input level, Gain 75 dB: -51 dBu

DA, Line Out 1-6, rear

- Resolution: 24 bit
- Dynamic range (DR): 112 dB RMS unweighted, 115 dBA
- Frequency response @ 44.1 kHz, -0.5 dB: 5 Hz – 20.8 kHz
- Frequency response @ 96 kHz, -0.5 dB: 5 Hz – 45 kHz
- Frequency response @ 192 kHz, -1 dB: 5 Hz - 89 kHz
- THD: < -108 dB, < 0.0004 %
- THD+N: < -104 dB, < 0.00063 %
- Channel separation: > 110 dB
- Maximum output level: +19 dBu
- Output: 6.3 mm TRS jack, servo-balanced
- Output impedance: 75 Ohm
- Output level switchable +19 dBu, +13 dBu, +4 dBu

DA - Stereo Monitor Output Phones (7-8)

As DA, but:

- Output: 6.3 mm TRS stereo jack, unbalanced
- Maximum output level at 0 dBFS, High: +19 dBu
- Maximum output level at 0 dBFS, Low: +4 dBu
- Output impedance: 1 Ohm
- Max power per channel @ 32 Ohm load, 0.1% THD: 210 mW (2.6 Vrms, +10.5 dBu)

39.2 MIDI

- 1 x MIDI I/O via 5-pin DIN jacks
- Galvanically isolated by optocoupled input
- Hi-speed mode: Jitter and response time typically below 1 ms
- Separate 128 byte FIFOs for input and output

39.3 Digital

- Clocks: Internal, ADAT, AES, SPDIF, word clock
- Jitter suppression of external clocks: > 50 dB (2.4 kHz)
- Effective clock jitter influence on AD and DA conversion: near zero
- PLL ensures zero dropout, even at more than 100 ns jitter
- Digital Bitclock PLL for trouble-free varispeed ADAT operation
- Supported sample rates: 28 kHz up to 200 kHz

39.4 Digital Inputs

AES/EBU

- 1 x XLR, transformer-balanced, galvanically isolated, according to AES3-1992
- High-sensitivity input stage (< 0.3 Vpp)
- SPDIF compatible (IEC 60958)
- Accepts Consumer and Professional format
- Lock range: 27 kHz – 200 kHz
- Jitter suppression: > 50 dB (2.4 kHz)

SPDIF coaxial

- 1 x RCA, according to IEC 60958
- High-sensitivity input stage (< 0.3 Vpp)
- Accepts Consumer and Professional format, copy protection will be ignored
- Lock Range: 27 kHz – 200 kHz
- Jitter suppression: > 50 dB (2.4 kHz)

ADAT Optical

- 1 x TOSLINK, format according to Alesis specification
- Standard: 8 channels 24 bit, up to 48 kHz
- Double Speed (S/MUX): 4 channels 24 bit 96 kHz
- Quad Speed (S/MUX4): 2 channels 24 bit 192 kHz
- Bitclock PLL ensures perfect synchronisation even in varispeed operation
- Lock range: 31.5 kHz – 50 kHz
- Jitter suppression: > 50 dB (2.4 kHz)

Word Clock

- BNC
- Internal termination 75 Ohm switchable
- Automatic Double/Quad Speed detection and internal conversion to Single Speed
- SteadyClock guarantees super low jitter synchronization even in varispeed operation
- Not affected by DC-offsets within the network
- Signal Adaptation Circuit: signal refresh through auto-center and hysteresis
- Overvoltage protection
- Level range: 1.0 Vpp – 5.6 Vpp
- Lock Range: 27 kHz – 200 kHz
- Jitter suppression: > 50 dB (2.4 kHz)

39.5 Digital Outputs

AES/EBU

- XLR, transformer-balanced, galvanically isolated, according to AES3-1992
- Output level Professional 4.5 Vpp, Consumer 2.6 Vpp
- Format Professional according to AES3-1992 Amendment 4
- Format Consumer (SPDIF) according to IEC 60958
- Single Wire mode, sample rate 28 kHz up to 200 kHz

SPDIF coaxial

- 1 x RCA, according to IEC 60958
- Output level Professional 1.2 Vpp, Consumer 0.6 Vpp
- Format Professional according to AES3-1992 Amendment 4
- Format Consumer (SPDIF) according to IEC 60958
- Single Wire mode, sample rate 28 kHz up to 200 kHz

ADAT

- 1 x TOSLINK
- Standard: 8 channels 24 bit, up to 48 kHz
- Double Speed (S/MUX): 4 channels 24 bit 96 kHz
- Quad Speed (S/MUX4): 2 channels 24 bit 192 kHz

Word Clock

- BNC
- Max. output voltage: 5 Vpp
- Output voltage @ 75 Ohm termination: 4.0 Vpp
- Output impedance: 10 Ohm
- Frequency range: 27 kHz – 200 kHz

39.6 General

- Power supply: external power supply
- Typical power consumption: 13 Watts
- Current at 12 Volt operating voltage: 910 mA (11 Watts)
- Dimensions incl. rack ears, full depth (WxHxD): 258 x 44 x 155 mm (10.16" x 1.73" x 6.1")
- Dimensions without rack ears, body depth (WxHxD): 215 x 44 x 130 mm (8.5" x 1.73" x 5.1")
- Weight: 910 g (2.0 lbs)
- Temperature range: +5° up to +50° Celsius (41° F up to 122°F)
- Relative humidity: < 75%, non condensing

40. Technical Background

40.1 Lock and SyncCheck

Digital signals consist of a carrier and the data. If a digital signal is applied to an input, the receiver has to synchronize to the carrier clock in order to read the data correctly. To achieve this, the receiver uses a PLL (Phase Locked Loop). As soon as the receiver meets the exact frequency of the incoming signal, it is locked. This **Lock** state remains even with small changes of the frequency, because the PLL tracks the receiver's frequency.

If an ADAT or SPDIF signal is applied to the Fireface UCX II, the corresponding input field starts flashing. The unit indicates LOCK, i. e. a valid input signal (in case the signal is also in sync, the field is constantly lit, see below).

Unfortunately, LOCK does not necessarily mean that the received signal is correct with respect to the clock which processes the read out of the embedded data. Example: The Fireface is set to 44.1 kHz internally (clock mode Master), and a mixing desk with ADAT output is connected to input ADAT. The corresponding field will show LOCK immediately, but usually the mixing desk's sample rate is generated internally (also Master), and thus slightly higher or lower than the Fireface's internal sample rate. Result: When reading out the data, there will frequently be read errors that cause clicks and drop outs.

Also when using multiple inputs, a simple LOCK is not sufficient. The above described problem can be solved elegantly by setting the Fireface from Master to AutoSync (its internal clock will then be the clock delivered by the mixing desk). But in case another, un-synchronous device is connected, there will again be a slight difference in the sample rate, and therefore clicks and drop outs.

In order to display those problems optically at the device, the Fireface includes **SyncCheck**. It checks all clocks used for *synchronicity*. If they are not synchronous to each other (i. e. absolutely identical), the SYNC field of the asynchronous input flashes. In case they are completely synchronous, all fields are constantly lit. In the above example it would have been obvious that the field ADAT kept on flashing after connecting the mixing desk.

In practice, SyncCheck allows for a quick overview of the correct configuration of all digital devices. So one of the most difficult and error-prone topics of the digital studio world finally becomes easy to handle.

The same information is presented in the Fireface's Settings dialog. In the status display the state of all clocks is decoded and shown as simple text (No Lock, Lock, Sync).

40.2 Latency and Monitoring

The term **Zero Latency Monitoring** has been introduced by RME in 1998 for the DIGI96 series of audio cards. It stands for the ability to pass-through the computer's input signal at the interface directly to the output. Since then, the idea behind has become one of the most important features of modern hard disk recording. In the year 2000, RME published two ground-breaking Tech Infos on the topics *Low Latency Background*, which are still up-to-date: *Monitoring, ZLM and ASIO*, and *Buffer and Latency Jitter*, both found on the RME website.

How much Zero is Zero?

From a technical view there is no zero. Even the analog pass-through is subject to phase errors, equalling a delay between input and output. However, delays below certain values can subjectively be claimed to be a zero-latency. This applies to analog routing and mixing, and in our opinion also to RME's Zero Latency Monitoring. The term describes the digital path of the audio data from the input of the interface to its output. The digital receiver of the Fireface UCX II can't operate un-buffered, and together with TotalMix and the output via the transmitter, it causes a typical delay of 3 samples. At 44.1 kHz this equals about 68 μ s (0.000068 s), at 192 kHz only 15 μ s. The delay is valid for ADAT and SPDIF in the same way.

Oversampling

While the delays of digital interfaces can be disregarded altogether, the analog inputs and outputs do cause a significant delay. Modern converter chips operate with 64 or 128 times oversampling plus digital filtering, in order to move the error-prone analog filters away from the audible frequency range as far as possible. This typically generates a delay of one millisecond. A playback and re-record of the same signal via DA and AD (loopback) then causes an offset of the newly recorded track of about 2 ms.

Low Latency!

The Fireface UCX II uses AD and DA converters with an innovative digital filter, causing a delay of only a few samples. With 5 samples AD and 6 samples DA the delay caused by the conversion is only a fraction of previous generations. The exact delays of the UCX II converters are:

Sample frequency kHz	44.1	48	88.2	96	176.4	192
AD (5 x 1/fs) ms	0.11	0.10				
AD (5 x 1/fs) ms			0.057	0.052		
AD (6 x 1/fs) ms					0.034	0.031
DA (5.8 x 1/fs) ms	0.13	0.12	0.066	0.06	0.033	0.03

Buffer Size (Latency)

Windows: This option found in the Settings dialog defines the size of the buffers for the audio data used in ASIO and WDM (see chapter 9).

Mac OS X: The buffer size is defined within the application. Only some do not offer any setting. For example iTunes is fixed to 512 samples.

General: A setting of 64 samples at 44.1 kHz causes a latency of 1.5 ms, for record and playback each. But when performing a digital loopback test no latency/offset can be detected. The reason is that the software naturally knows the size of the buffers, therefore is able to position the newly recorded data at a place equalling a latency-free system.

AD/DA Offset under ASIO and OS X: ASIO (Windows) and Core Audio (Mac OS X) allow for the signalling of an offset value to correct buffer independent delays, like AD- and DA-conversion or the Safety Buffer described below. An analog loopback test will then show no offset, because the application shifts the recorded data accordingly. Because in real world operation analog record and playback is unavoidable, the drivers include an offset value matching the Fireface's converter delays.

Therefore, in a **digital** loopback test a *negative* offset of about 3 ms occurs. This is no real problem, because this way of working is seldom, and usually the offset can be compensated manually within the application. Additionally, keep in mind that even when using the digital I/Os usually at some place an AD- and DA-conversion is involved (no sound without...).

Safety Buffer

An additional small safety buffer on the playback side has proven to be very efficient and useful. It is therefore implemented in all RME interfaces. Under Windows the Fireface UCX II uses a fixed additional buffer of 32 samples, under Mac 24 samples, which is added to the current buffer size. The main advantage is the ability to use lowest latency at highest CPU loads. Furthermore, the fixed buffer does not add to the latency jitter (see Tech Info), the subjective timing is extraordinary.

Core Audio's Safety Offset

Under OS X, every audio interface has to use a so called *Safety Offset* on record and playback, otherwise Core Audio won't operate click-free. The Fireface uses a Safety Offset of 24 samples. This offset is signalled to the system, and the software can calculate and display the total latency of buffer size plus AD/DA offset plus 2 x Safety Offset plus Safety Buffer for the current sample rate. The option *Short Safety Offset* in the Settings dialog reduces this to 12 samples each.

40.3 USB Audio

USB audio is in several ways different from PCI based audio interfaces. A good performance and click-free operation at a low buffer size are indeed possible on current computers. However, using older computers a simple stereo playback will begin to cause a CPU load of more than 30%.

A computer blocked for a short time – no matter if ASIO or WDM – will lose one or more data packets. Such problems can only be solved by increasing the buffer size (latency).

The Fireface features a unique data checking, detecting errors during transmission via USB and displaying them in the Settings dialog.



Additionally the Fireface provides a special mechanism to continue recording and playback in case of drop-outs, and to correct the sample position in real-time.

Best USB 2 performance is achieved by connecting the UCX II to its own bus, which should be no big problem as most USB 2.0 interfaces are a double bus design. A check in the Device Manager can be done as follows:

- Connect the UCX II to a USB 2 port
- Start the Device Manager, View set to Devices by Connection
- Select ACPI x86-based PC, Microsoft ACPI-Compliant System, expand PCI Bus

This branch normally includes two entries of a *USB2 Enhanced Host Controller*. A USB Root Hub can be seen, which then connects all USB devices, including the UCX II. By reconnecting to a different port this view shows at which of the two controllers the UCX II is connected. With multiple devices it can be checked if they are connected to the same controller.

Furthermore this information can be used to operate an external USB drive without disturbing the UCX II, by simply connecting the drive to the other controller.

Especially with notebooks it can happen that all internal devices and all the sockets/ports are connected to the same controller, with the second controller not used at all. In that case all devices have to use the same bus and will interfere with each other.

40.4 DS - Double Speed

Sample rates above 48 kHz were not always taken for granted, and are still not widely used because of the CD format (44.1 kHz) dominating everything. Before 1998 there were no receiver/transmitter circuits available that could receive or transmit more than 48 kHz. Therefore a work-around was used: instead of two channels, one AES line only carries one channel, whose odd and even samples are being distributed to the former left and right channels. By this, you get the double amount of data, i. e. also double sample rate. Of course in order to transmit a stereo signal two AES/EBU ports are necessary then.

This transmission mode is called *Double Wire* in the professional studio world, and is also known as *S/MUX (Sample Multiplexing)* in connection with the multichannel ADAT format.

Because the ADAT interface does not allow for sampling frequencies above 48 kHz (a limitation of the interface hardware), the Fireface UCX II automatically uses *Sample Multiplexing* in DS mode. One channel's data is distributed to two channels. As the transmission of double rate signals is done at standard sample rate (Single Speed), the ADAT outputs still deliver a 44.1 kHz or 48 kHz carrier.

40.5 QS – Quad Speed

Due to the small number of available devices that use sample rates up to 192 kHz, but even more due to a missing real world application (CD...), Quad Speed has had no broad success. An implementation of the ADAT format as double S/MUX (S/MUX4) results in only two channels per optical output. Devices using this method are few.

In earlier times the transmission of 192 kHz had not been possible via Single Wire, so once again sample multiplexing was used: instead of two channels, one AES line transmits only one half of a channel. A transmission of one channel requires two AES/EBU lines, stereo requires even four. This transmission mode is being called *Quad Wire* in the professional studio world.

Because the ADAT interface does not allow for sampling frequencies above 48 kHz (a limitation of the interface hardware), the Fireface UCX II automatically uses *Sample Multiplexing* in QS mode. One channel's data is distributed to four channels. As the transmission of quad rate signals is done at standard sample rate (Single Speed), the ADAT outputs still deliver a 44.1 kHz or 48 kHz carrier.

40.6 Noise level in DS / QS Mode

The outstanding signal to noise ratio of the Fireface UCX II AD-converters can be verified even without expensive test equipment, by using record level meters of various software. But when activating the DS and QS mode, the displayed noise level will rise from -113 dB to -105 dB at 96 kHz, and -79 dB at 192 kHz. This is not a failure. The software measures the noise of the whole frequency range, at 96 kHz from 0 Hz to 48 kHz (RMS unweighted), at 192 kHz from 0 Hz to 96 kHz.

When limiting the measurement range from 20 Hz to 20 kHz (so called audio bandpass) the value would be -113 dB again. This can be verified with RME's *DIGICheck*. The function **Bit Statistic & Noise** measures the noise floor by *Limited Bandwidth*, ignoring DC and ultrasound.

Subframe	MSB	Audio Data	LSB	AUX	CUV	RMS LB [dB+3]	RMS [dBA+3]	DC [dB]
1 - Left	XXXX	XXXXXXXXXXXXXXXXXXXX	XXXX	XXXX	000	-112.7	-115.5	-137.9
2 - Right	XXXX	XXXXXXXXXXXXXXXXXXXX	XXXX	XXXX	000	-112.6	-115.6	-137.8
Bits	4	8	12	16	20	24	20Hz ... 20kHz	A-weighting

Press F1 for help. SR 192kHz

The reason for this behaviour is the noise shaping technology of the analog to digital converters. They move all noise and distortion to the in-audible higher frequency range, above 24 kHz. That's how they achieve their outstanding performance and sonic clarity. Therefore the noise is slightly increased in the ultrasound area. High-frequent noise has a high energy. Add the doubled (quadrupled) bandwidth, and a wideband measurement will show a significant drop in SNR, while the human ear will notice absolutely no change in the audible noise floor.

40.7 SteadyClock

The SteadyClock technology of the Fireface UCX II guarantees an excellent performance in all clock modes. Thanks to a highly efficient jitter suppression, the AD- and DA-conversion always operates on highest sonic level, being completely independent from the quality of the incoming clock signal.

SteadyClock has been originally developed to gain a stable and clean clock from the heavily jittery MADI data signal (the embedded MADI clock suffers from about 80 ns jitter). Using the Fireface's input signals AES and ADAT, you'll most probably never experience such high jitter values. But SteadyClock is not only ready for them, it would handle just on the fly.

Common interface jitter values in real world applications are below 2 ns, a very good value is less than 2 ns.

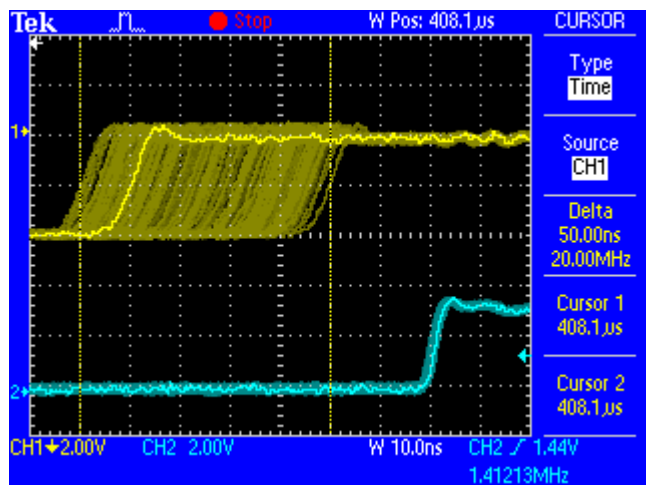

de-
jit-
bed-
er
ues.
them
in
10

The screenshot shows an extremely jittery SPDIF signal of about 50 ns jitter (top graph, yellow). SteadyClock turns this signal into a clock with less than 2 ns jitter (lower graph, blue). The signal processed by SteadyClock is of course not only used internally, but also used to clock the digital outputs. Therefore the refreshed and jitter-cleaned signal can be used as reference clock without hesitation.

41. Diagrams

41.1 Block Diagram Fireface UCX II

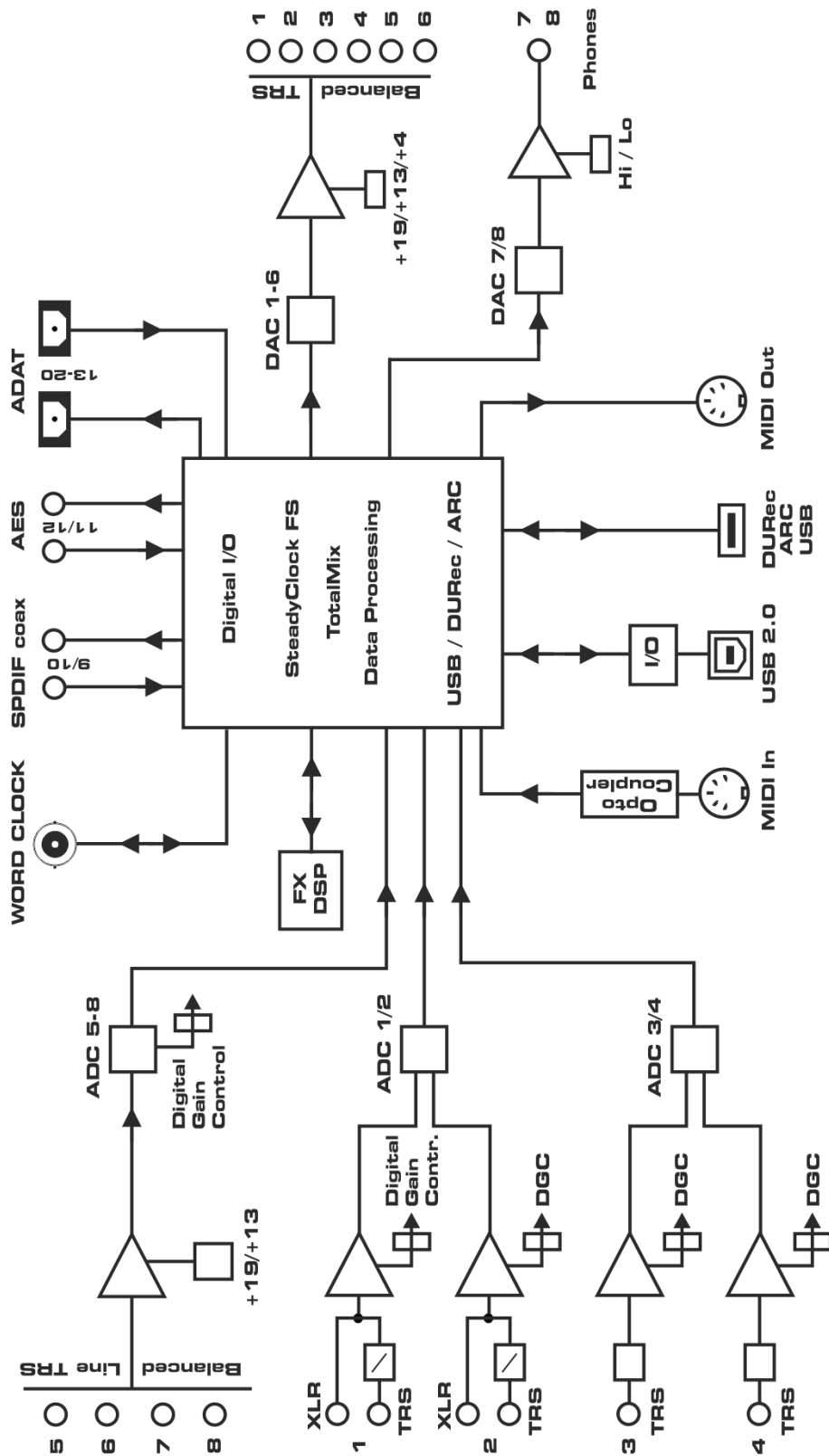

41.2 Connector Pinouts

TRS jacks of analog input / output

The stereo 1/4" TRS jacks of the rear analog inputs and outputs are wired according to international standards:

Tip = + (hot)
Ring = - (cold)
Sleeve = GND

The servo balanced input and output circuitry allows to use monaural TS jacks (unbalanced) with no loss in level. This is the same as when using a TRS-jack with ring connected to ground.

XLR jacks of analog inputs

The XLR jacks are wired according to international standards:

1 = GND (shield)
2 = + (hot)
3 = - (cold)

TRS Phones jack

The analog monitor outputs on the front are accessible through stereo 1/4" TRS jacks. This allows a direct connection of headphones. In case the output should operate as Line output, an adapter TRS plug to RCA phono plugs, or TRS plug to TS plugs is required.

The pin assignment follows international standards. The left channel is connected to the tip, the right channel to the ring of the TRS jack/plug.

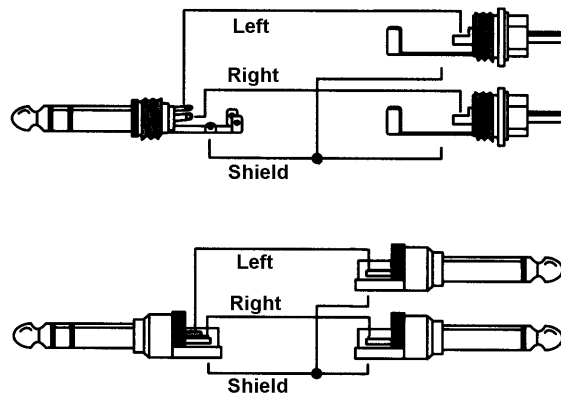

Pin assignment of the 9-pin D-Sub connector, breakout cable BO968 SPDIF / AES

Pin	Name	Pin	Name	Pin	Name
1	GND	4	AES Out +	7	SPDIF In -
2	SPDIF Out +	5	AES In +	8	AES Out -
3	SPDIF In +	6	SPDIF Out -	9	AES In -

Note: The digital breakout cable BO968 is also used on the HDSP9632, HDSPe AIO, HDSPe AIO Pro and the ADI-2 Pro versions.



User's Guide



Fireface UCX II

► Miscellaneous

42. Accessories

RME offers several optional components for the Fireface UCX II:

Part Number	Description
OK0100PRO	Optical cable, TOSLINK, 1 m (3.3 ft)
OK0200PRO	Optical cable, TOSLINK, 2 m (6.6 ft)
OK0300PRO	Optical cable, TOSLINK, 3 m (9.9 ft)
ARC-USB	Advanced Remote Control USB for TotalMix FX

43. Warranty

Each individual Fireface UCX II undergoes comprehensive quality control and a complete test at IMM before shipping. The usage of high grade components should guarantee a long and trouble-free operation of the unit.

If you suspect that your product is faulty, please contact your local retailer.

Audio AG grants a limited manufacturer warranty of 6 months from the day of invoice showing the date of sale. The length of the warranty period is different per country. Please contact your local distributor for extended warranty information and service. Note that each country may have regional specific warranty implications.

In any case warranty does not cover damage caused by improper installation or maltreatment - replacement or repair in such cases can only be carried out at the owner's expense.

No warranty service is provided when the product is not returned to the local distributor in the region where the product had been originally shipped.

Audio AG does not accept claims for damages of any kind, especially consequential damage. Liability is limited to the value of the Fireface UCX II. The general terms of business drawn up by Audio AG apply at all times.

44. Appendix

RME news, driver updates and further product information are available on RME's website:

<https://www.rme-audio.com>

Worldwide distribution: Audio AG, Am Pfanderling 60, D-85778 Haimhausen, Tel.: (49) 08133 / 918170

Support via e-mail: support@rme-audio.com

List of international supporters: <https://www.rme-audio.de/support.html>

RME user forum: <https://forum.rme-audio.de>

Manufacturer: IMM electronics GmbH, Leipziger Strasse 32, D-09648 Mittweida

Trademarks

All trademarks, registered or otherwise, are the property of their respective owners. RME, DIGICheck and Hammerfall are registered trademarks of RME Intelligent Audio Solutions. DIGI96, SyncAlign, ZLM, SyncCheck, TMS, TotalMix, DURec and Fireface are trademarks of RME Intelligent Audio Solutions. Alesis and ADAT are registered trademarks of Alesis Corp. ADAT optical is a trademark of Alesis Corp. Microsoft, Windows, Windows 7/8/10 are registered trademarks or trademarks of Microsoft Corp. Steinberg, Cubase and VST are registered trademarks of Steinberg Media Technologies GmbH. ASIO is a trademark of Steinberg Media Technologies GmbH. Apple, iPhone, iPad, iOS, Mac OS and macOS X are registered trademarks of Apple Inc.

Copyright © Matthias Carstens, 06/2021. Version 1.2

Current driver and Firmware versions

Driver: Windows 1.1212, Mac OS X: 3.21 / 3.25, TotalMix FX: 1.73

Firmware: USB 37, CC 16, DSP 24

Although the contents of this User's Guide have been thoroughly checked for errors, RME can not guarantee that it is correct throughout. RME does not accept responsibility for any misleading or incorrect information within this guide. Lending or copying any part of the guide or the RME Driver CD, or any commercial exploitation of these media without express written permission from RME Intelligent Audio Solutions is prohibited. RME reserves the right to change specifications at any time without notice.

Note on Disposal

According to the guide line RL2012/19/EU (WEEE – Directive on Waste Electrical and Electronic Equipment), valid for all European countries, this product has to be recycled at the end of its lifetime.

In case a disposal of electronic waste is not possible, the recycling can also be done by IMM electronics GmbH, the manufacturer of the Fireface UCX II.

For this the device has to be sent **free to the door** to:

IMM electronics GmbH
Leipziger Straße 32
D-09648 Mittweida
Germany



Shipments not prepaid will be rejected and returned on the original sender's costs.

45. CE / FCC Compliance

CE

This device has been tested and found to comply with the limits of the European Council Directive on the approximation of the laws of the member states relating to electromagnetic compatibility according to RL2014/30/EU, and European Low Voltage Directive RL2014/35/EU.

FCC

This device complies with Part 15 of the FCC Rules. Operation is subject to the following two conditions: (1) This device may not cause harmful interference, and (2) This device must accept any interference received, including interference that may cause undesired operation.

Warning: Changes or modifications to this unit not expressly approved by the party responsible for compliance could void the user's authority to operate the equipment.

Responsible Party in USA:

Synthax United States, 6600 NW 16th Street, Suite 10, Ft Lauderdale, FL 33313
T.:754.206.4220

Trade Name: RME, Model Number: Fireface UCX II

This equipment has been tested and found to comply with the limits for a Class B digital device, pursuant to Part 15 of the FCC Rules. These limits are designed to provide reasonable protection against harmful interference in a residential installation. This equipment generates, uses, and can radiate radio frequency energy and, if not installed and used in accordance with the instructions, may cause harmful interference to radio communications. However, there is no guarantee that interference will not occur in a particular installation. If this equipment does cause harmful interference to radio or television reception, which can be determined by turning the equipment off and on, the user is encouraged to try to correct the interference by one or more of the following measures:

- Reorient or relocate the receiving antenna.
- Increase the separation between the equipment and receiver.
- Connect the equipment into an outlet on a circuit different from that to which the receiver is connected.
- Consult the dealer or an experienced radio/TV technician for help.

Caution: To comply with the limits of the Class B digital device, pursuant to Part 15 of the FCC Rules, this device must be operated with computer equipment certified to comply with Class B limits. All cables used to connect to the computer and peripherals must be shielded and grounded. Operation with non-certified computers or unshielded cables may cause interference to radio or television reception.

RoHS Notice

This product has been soldered lead-free and fulfils the requirements of the RoHS directive.