

Marshall

Broadcast A/V Division

CV605-BK (Black) **CV605-WH (White)**

5x HD60 IP PTZ Camera with 3GSDI



User Manual

Content

- 1. FAST INSTALLATION 5**
- 1.2 POWER ON INITIAL CONFIGURATION5
- 1.3 VIDEO OUTPUT5
- 2. PRODUCT OVERVIEW 6**
- 2.1 PRODUCT INTRODUCTION.....6
- 2.1.1 Dimension.....6
- 2.1.2 Accessory.....6
- 2.2 MAIN FEATURES7
- 2.3 TECHNICAL SPECIFICATION7
- 2.4 INTERFACE INSTRUCTION8
- 2.4.1 External Interface8
- 3. APPLICATION INSTRUCTION..... 9**
- 3.1 REMOTE CONTROLLER 10
- 3.1.1 SETTING EXPLANATION..... 10**
- 3.1.2 Applications..... 10
- 3.2 MENU SETTING12
- 3.2.1 Main Menu12
- 3.2.2 System Setting13
- 3.2.3 Camera Setting.....13
- 3.2.4 P/T/Z.....16
- 3.2.5 Video Format.....17
- 3.2.6 Network settings17
- 3.2.7 Audio settings.....18
- 3.2.8 Version.....18
- 3.2.9 Restore Default.....19
- 4. NETWORK CONNECTION 19**
- 4.1 CONNECTING MODE19
- 4.2 IE LOG IN.....21
- 4.2.1 Web client.....21
- 2)Download/Install Plug in.....21
- 4.2.2 Preview21
- 4.2.4 Configuration.....21
- 1) Audio Configuration22
- 2) Video configuration.....22
- 4.2.6 Network Configure24
- 4.2.7 System Configure.....24

- 4.2.8 Logout.....25
- 5. SERIAL COMMUNICATION CONTROL..... 25**
- 5.1 VISCA PROTOCOL LIST26
- 5.1.1 Command list.....26
- 5.1.2 Inquiry command.....27
- 5.2 PELCO-D PROTOCOL COMMAND LIST28
- 5.3 PELCO-P PROTOCOL COMMAND LIST28
- 6. CAMERA MAINTENANCE AND TROUBLESHOOTING 29**
- 6.1 CAMERA MAINTENANCE29
- 6.2 TROUBLESHOOTING.....29

Please Note

This manual details features, functions, installation, operation and recommendation. Please read this manual completely before installation and use.

Description of use

1. In order to prevent damage to this camera or other components within the workflow, please use it within its prescribed purpose and scope of operation.
2. Keep the device away from rain, moisture, or heavy humidity.
3. To prevent electric shock or damage to internal components, do not open the main case; only qualified technicians should conduct repairs.
4. Do not use the device beyond scope of its temperature, humidity or power supply specification.
5. When cleaning the camera lens, use a soft dry cloth. If dirt is harder to remove please use water or mild soap. Do not use strong or corrosive detergent, it may scratch the lens and/or cause chemical residue to remain.

Careful handling

6. Avoid damage from heavy pressure, strong vibration or immersion during transportation, storage and installation.

Power supply polarity

7. This product uses DC 12V power supply (higher or lower voltage may cause damage)

Install with caution

8. Do not carry the camera by the camera head or rotate it with force, otherwise it may cause mechanical malfunction and damage internal belts and gears.
9. This product should be placed on a stable desktop or other horizontal surfaces. Do not install the product on anything other than a level position, otherwise it may display inclined or off axis image.
10. This product shell is made of organic materials. Do not expose it to any liquid, gas or solids which may corrode the shell.
11. During installation, ensure that there are no obstacles within rotation range of the head to limit it's movement (Pan/Tilt).
12. Do not power on before installation is complete, as it may be restricted in movement.

Do not disassemble the product without permission from manufacturer.

13. This product contains no parts which can be repaired in field or at site. Any damage arising from disassembly voids the product warranty

Magnetic field interference

14. Magnetic fields within a specific frequency may affect camera video images; this is a Class A product. Some applications within a household environment may cause radio interference. Make sure there are no other radio interference present.

1. Fast Installation

1.1 Camera Layout Explanation

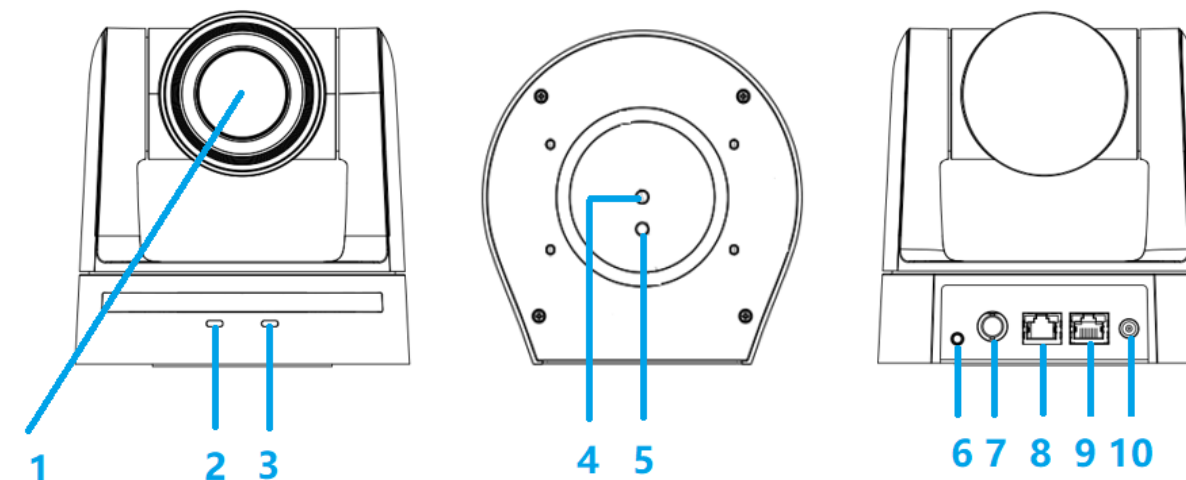

Figure 1.1 Interface of SDI Model

Interface of SDI Model:

1. Camera Lens	2. Power Indicator
3. Remote Control Receiver Light	4. Position Lock
5. 1/4"-20 Mounting Hole	6. Audio Input (TRS)
7. 3GSDI (BNC)	8. Ethernet (IP) Port
9. RS232 (RJ45) Port	10. DC12V Input Power Supply Socket

1.2 Power-ON initial setup

- 1) Power ON: Connect the DC12V power supply included in box to power outlet and camera power input.
- 2) Initial configuration: Once powered up the power indicator light will start blinking, camera head will move from bottom left to the bottom, and then moves to the HOME position (horizontal and vertical center), while the camera module boots up. As soon as remote-control receiver light stops blinking, the self-check and boot up is complete.

Note:

1. The default address of the remote controller is the 1# address.
2. If you SET preset to "0" then after self-check and boot up is complete, the camera will then automatically move to the preset 0 position.

1.3 Video Output

- 1) Network output:
 - a. Network Cable Connection Port: No.8 in Figure1.1

- b. Webpage Login: Open web browser and enter default IP address **192.168.5.163** in the address bar (factory default); press Enter and enter the LOGIN prompt. Then enter the default user name **admin** and password **admin** (factory default); then press Enter to see preview page, users can carry out PTZ control, playback, configuration and other operations from this software GUI.

2) 3GSDI (BNC) output: Connect the camera to a monitor or switching equipment using 3GSDI (RG6) coaxial cable, then the monitor or other equipment will display image.

2. Product overview

2.1 Product Introduction

2.1.1 Dimension

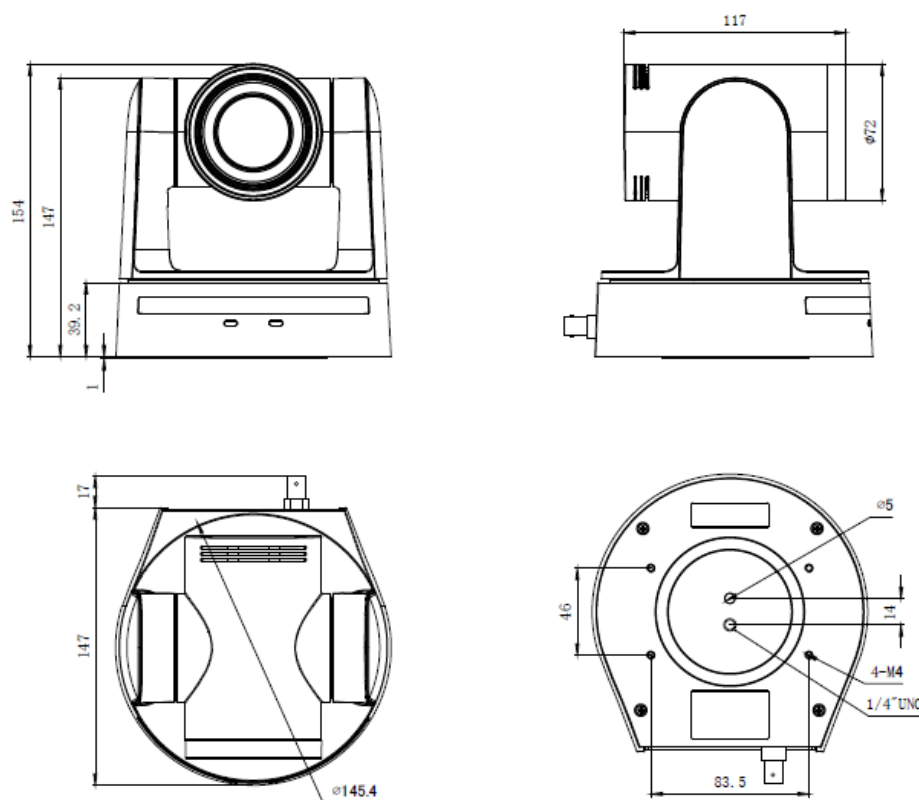

Figure 2.2 Camera dimension

2.1.2 Accessory

During unpacking the box, please check that all the supplied accessories are included:

Model NO.	Accessories
CV605-BK/ CV605-WH	Power adapter
	IR Remote controller
	Thank You Card
	Warranty card

Optional Accessories (sold separately):

- CV605-WM (Wall Mount-Black)
- CV605-WMW (Wall Mount-White)
- CV605-CM Ceiling Mount

2.2 Main Features

The CV605 camera series offers high quality performance with rich feature sets. The features include advanced ISP processing algorithms to provide vivid images with deep color depth, crisp and clear HD images and accurate color reproduction. The CV605 also supports H.265/H.264 encoding which creates smooth IP video performance and clear images under less-than-ideal bandwidth conditions.

1. **True High-Definition Image:** 1/2.8-inch-high quality CMOS sensor. Resolution is up to 1920x1080p up to 60 fps.
2. **Optical Zoom Lens:** 5X zoom lens reaches a wide angle 85° AOV with very low distortion
3. **Leading Auto Focus Technology:** Cutting edge auto focus algorithm makes lens a fast, accurate and stable auto-focus.
4. **Low Noise and High SNR:** Low Noise CMOS effectively ensure high SNR of camera video. Advanced 2D/3D noise reduction technology is also used to further reduce the noise, while ensuring image sharpness.
5. **Quiet PTZ:** By designing in a high accuracy step motor technology, camera movement is extremely quiet with smooth maneuvers and fast accurate destinations (presets).
6. **Video Outputs:** Support up to 3GSDI and LAN interfaces.
7. **Multiple Video compression:** Support H.265/H.264 video compression
8. **Audio Input Interface:** Supports 16000,32000,44100,48000 sampling frequency and AAC, MP3, G.711A audio coding.
9. **Multiple Network Protocol Support:** ONVIF, RTSP, RTMP protocols
10. **Low-power sleep function:** Supports ultra-low power consumption while in sleep mode (less than 400mW)
11. **Multiple Control Protocols:** Support VISCA, Pelco-D, Pelco-P and supports auto-recognize protocol discovery.
12. **255 Presets Positions:** Up to 255 presets (10 presets available on IR remote controller).

2.3 Technical specification

Model	CV605-BK / CV605-WH
Camera Specs	
Optical Zoom	5X Optical Zoom (3~15.5mm)
Sensor	1/2.8-inch-high quality HD CMOS sensor
Effective Pixels	16:9, 2 Megapixel
Video Format	3G/HD-SDI video formats 1920x1080p @ 60/59.94/50/30/29.97/25 fps 1920x1080i @ 60/59.94/50 fps 1280x720p @ 60/59.94/50/30/29.97/25 fps
Viewing Angle	85° (wide open) through 16° (telephoto)
Digital Zoom	10X additional
Minimum Illumination	0.5Lux (F1.8, AGC ON)
DNR	2D & 3D DNR
White Balance	Auto / Manual/ One Push/ VAR
Focus	Auto/Manual/One Push
Iris	Close/F11/9.6/8.0/6.8/5.6/4.8/4.0/3.4/2.8/2.4/2.0/1.8
Electronic Shutter	Auto/Manual
BLC	ON/OFF
Video Adjustment	Brightness, Color, Saturation, Contrast, Sharpness, B/W mode, Gamma curve
SNR	>55dB
Input/ Output Interface	

Available Video I/O	3G/HD-SDI, LAN, RS232 (RJ45), Audio-IN
Image Output Multiple Code Source	Dual Code Source output (3GSDI, LAN)
Video Compression Format	H.264 & H.265
Audio Input Interface	Two-channel 3.5mm (Line or Mic level)
Audio Output	3G/HD-SDI, LAN (IP) embedded
Audio Compression Format	AAC/MP3/G.711A
IP Interface	100M IP port (100BASE-TX)
Network Protocol	RTSP/RTMP, ONVIF, GBT28181; Visca over IP control protocol
Control Interface	RS232
Control Protocol	VISCA/Pelco-D/Pelco-P; Baud Rate: 115200/38400/9600/4800/2400
Power Interface	HEC380 outlet (DC12V), PoE (IEEE 802.3af)
Supply Adapter	AC110V-AC220V to DC12V/1.5A
Input Voltage	DC12V±10%
Input Current	1A (Max)
Consumption	12W (Max)
PTZ Parameters	
Pan Rotation	270 degrees of pan (+/-135°)
Tilt Rotation	60 degrees of tilt (-30°~+30°)
Pan Control Speed Range	0.1 -60°/sec
Tilt Control Speed Range	0.1-30°/sec
Preset Speed	Pan: 60°/sec, Tilt: 30°/sec
Preset Number	255 presets (10 presets by remote controller)
Other Parameters	
Store Temperature	-10°C ~+60°C
Store Humidity	20% - 95%
Working Temperature	-10°C ~+50°C
Working Humidity	20% - 80%
Dimension	145.4mm x 147mm x 154mm
Weight	2.8 lbs (1.27 Kg)
Use Environment	Indoor
Accessories in Box	Power adapter, IR remote controller, Thank You Card, Warranty Card

2.4 Interface Instruction

2.4.1 External Interface

- 1) External interfaces: Audio Input, 3G- SDI Output, Ethernet, RS232 input, DC12V Power.

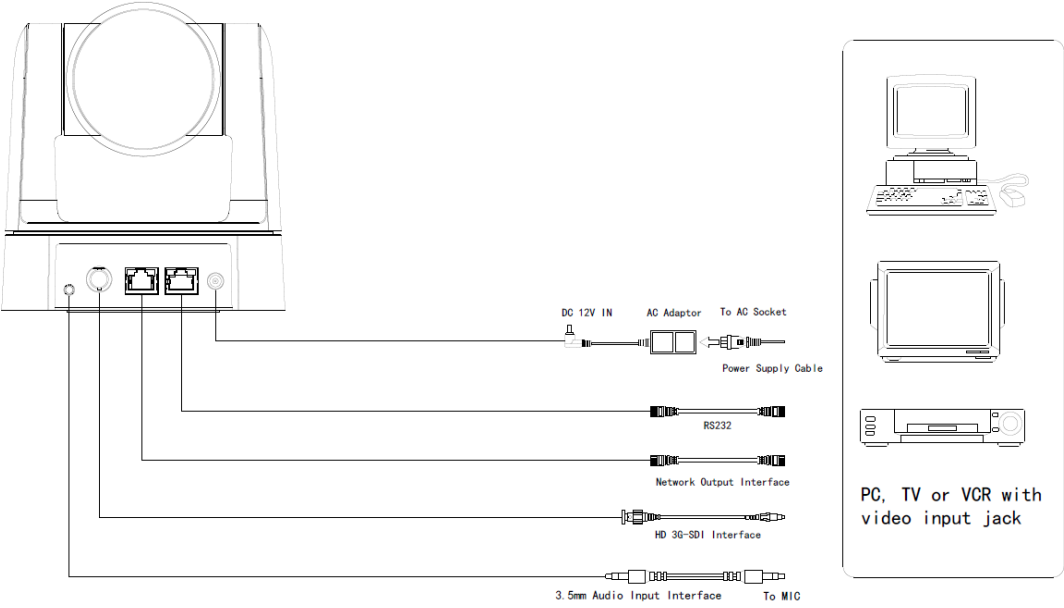

Figure 2.3 external interface diagram

3. Application Instruction

3.1 Remote Controller



3.1.1 Setting Explanation

- 1. Standby Key**
After a 3 second press, the camera will go into standby mode. Long press 3 second press again, camera will self-test again and move to HOME position. (Note: If power-on mode is turned on and Preset 0 is set, and there is no operation within 12s, camera will automatically point to the specified preset position.
- 2. Camera Address Selection**
Select the camera address of which to control
- 3. Number Key**
Set or run 0-9 presets
- 4, *, # Key**
Key combination use
- 5. Focus Control Key**
Auto Focus: Enter Auto focus mode.
Manual Focus: The camera focus mode is manual
Switch the camera focus mode to manual by pressing [focus +] or [focus -] to adjust manually.
- 6. Zoom Control Key**
Zoom + : Lens near or zoom in
Zoom - : Lens far or zoom out
- 7. Set or Clear Preset key:**
Set Preset: Set preset key + 0-9 number key:
Clear Preset key: Clear preset key + 0-9 number key
- 8. Pan/Tilt Control Key**
Press ▲ Key: Up
Press ▼ Key: Down
Press ◀ Key: Left
Press ▶ Key: Right
"HOME" Key: Return to the middle position or enter next level menu
- 9. BLC Control Key**
Back Light ON / OFF: Turn back light on or off
- 10. Menu Setting**
Open or close the OSD menu
Enter / Exit the OSD menu or return to the previous menu.

11. Camera IR Remote Control Address Setting

- 【*】 + 【#】 + 【F1】 :Camera Address No.1
- 【*】 + 【#】 + 【F2】 :Camera Address No. 2
- 【*】 + 【#】 + 【F3】 :Camera Address No. 3
- 【*】 + 【#】 + 【F4】 :Camera Address No. 4

12. Key Combination Functions

- | | |
|--|---|
| 1) 【#】 + 【#】 + 【#】 :Clear all presets | 2) 【*】 + 【#】 + 【6】 :Restore factory defaults |
| 3) 【*】 + 【#】 + 【9】 :Flip switch | 4) 【*】 + 【#】 + Auto: Enter into the aging mode |
| 5) 【*】 + 【#】 + 【3】 :Menu set to Chinese | 6) 【*】 + 【#】 + 【4】 :Menu set to English |
| 7) 【*】 + 【#】 + Manual: Restore the default user name, password, and IP address | 8) 【#】 + 【#】 + 【0】 :Switch the video format to 1080P60 |
| 9) 【#】 + 【#】 + 【1】 : Switch the video format to 1080P50 | 10) 【#】 + 【#】 + 【2】 :Switch the video format to 1080I60 |
| 11) 【#】 + 【#】 + 【3】 :Switch the video format to 1080I50 | 12) 【#】 + 【#】 + 【4】 :Switch the video format to 720P60 |
| 13) 【#】 + 【#】 + 【5】 :Switch the video format to 720P50 | 14) 【#】 + 【#】 + 【6】 :Switch the video format to 1080P30 |
| 15) 【#】 + 【#】 + 【7】 :Switch the video format to 1080P25 | 16) 【#】 + 【#】 + 【8】 :Switch the video format to 720P30 |
| 17) 【#】 + 【#】 + 【9】 :Switch the video format to 720P25 | |

3.1.2 Applications

After camera boot-up (initialize), camera can receive and execute IR commands. Press the remote controller button, the

indicator light will start flashing; release the button, the indicator light will stop flashing. Users can control the pan/tilt/zoom, setting and operate preset positions via the IR remote controller.

Key Instruction:

1. In these instructions, "press the key" means a quick push rather than a long-press, and a special note will be provided if a long-press is required (longer than one second).
2. When a key-combination is required, perform it in sequence. For example, "【*】 + 【#】 + 【F1】" means press "【*】" first and then press "【#】" and then lastly press "【F1】".

1) Camera Selection

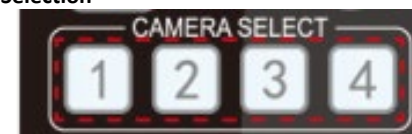

Select the camera address to control.

2) Pan/Tilt Control

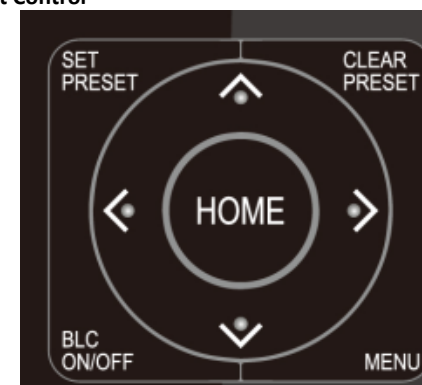

Up: press ▲ Down: press ▼
Left: press ◀ Right: press ▶
Back to middle position: press "【HOME】"
Press and hold the up/down/left/right key, the pan/tilt will keep running, from slow to fast, until it runs to the maximum endpoint; the pan/tilt movement will stop as soon as the key is released.

3) Zoom Control



ZOOM IN: press "ZOOM ▼" key
ZOOM OUT: press "ZOOM ▲" key
Press and hold the key, the camera will keep zooming in or zooming out and stops as soon as the key is released.

4) Focus Control

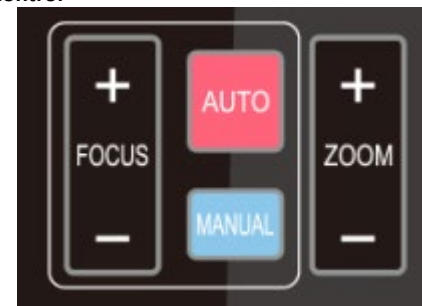

Focus (near): Press "【focus+】" key (Valid only in manual focus mode)
Focus (far): Press "【focus-】" key (Valid only in manual focus mode)
Auto Focus: Support
Manual Focus: Support
Press and hold the key, the action of focus will keep continue and stops as soon as the key is released.

5) BLC Setting



BLC ON / OFF: support

6) Presets Setting, Running, Clearing



1. Preset setting: to set a preset position, user should press the “【SET PRESET】” key first and then press the number key 0-9 to set a relative preset position,

Note: 10 preset positions in total are available on the remote controller, 255 available from joystick or other command sources.

2. **Preset Running:** Press a number key 0-9 directly to move camera to the saved preset position.

Note: need to save a preset first, for each number to be assigned.

3. Preset clearing: to clear a preset position, the user can press the “【CLEAR PRESET】” key first and then press the number key 0-9 to clear the relative camera preset position;

Note : press the“【#】” key three times to cancel all the presets.



7) Camera Remote Controller Address Setting

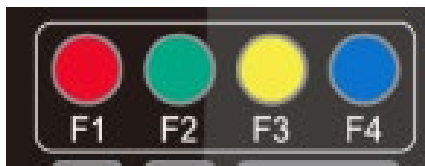

- 【*】+【#】+【F1】:Camera Address No.1
- 【*】+【#】+【F2】:Camera Address No. 2
- 【*】+【#】+【F3】:Camera Address No. 3
- 【*】+【#】+【F4】:Camera Address No. 4

3.2 MENU SETTING

3.2.1 Main Menu

In normal working mode, press 【MENU】 key to display the OSD main menu. Use up/down arrows to select the menu and press 【HOME】 to enter the menu.

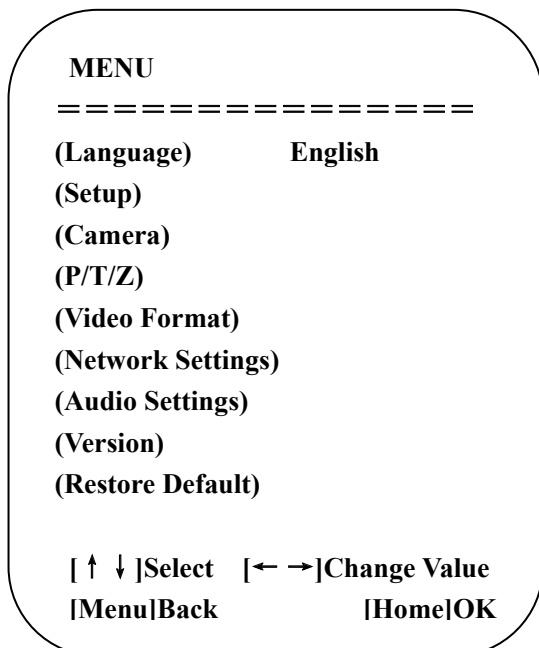

LANGUAGE: Language setting, English / Chinese

SETUP: System settings

CAMERA: Camera settings

PTZ: Pan tilt zoom settings

Video Format: select video output formats

Network Settings: turn DHCP mode on/off and check camera IP address

Audio Settings: turn audio on/off and adjust the volume

VERSION: display camera firmware version

Restore Default: Reset settings

[↑↓] **Select:** for selecting menu

[← →] **Change Value:** for modify parameters

[MENU] **Back:** Press [MENU] to return

[Home] **OK:** Press [Home] to confirm

3.2.2 System Setting

Move the pointer to (Setup) in the Main Menu, click the 【HOME】 key and enter into Setup menu as below.

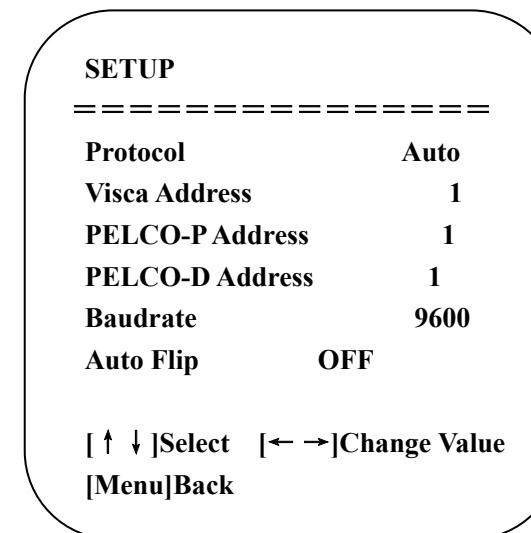

PROTOCOL: VISCA/Pelco-P/Pelco-D/Auto

Visca Address: 1 ~ 7

PELCO-P Address: 1 ~ 255

PELCO-D Address: 1 ~ 255

Baud rate: 2400/4800/9600/38400/115200

Auto Flip: ON/OFF (When it's ON, image will automatically flip if camera is mounted upside down)

3.2.3 Camera Setting

Move the pointer to (Camera) in the Main Menu, click the 【HOME】 key and enter into Camera menu as below.

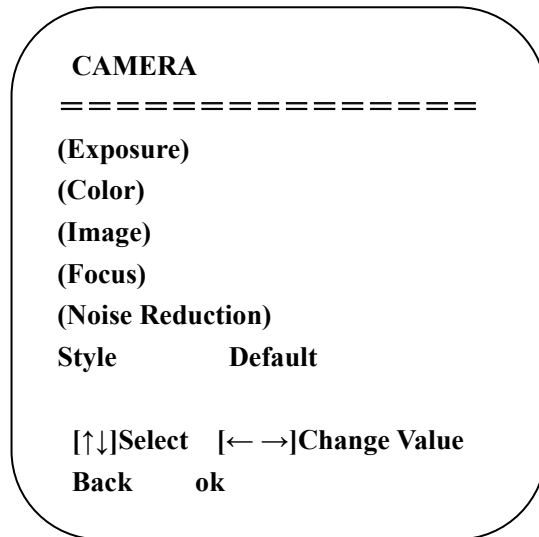

EXPOSURE: Enter into Exposure settings

COLOR: Enter into color settings

Image: Enter into image settings

Focus: Enter into focus settings

Noise Reduction: Enter into noise reduction

Style: choose picture style options (Default/Normal/Clarity/Bright/Soft)

1) EXPOSURE

Move the pointer to the (Exposure) menu, click the **【HOME】** key to enter into Exposure menu as follow,

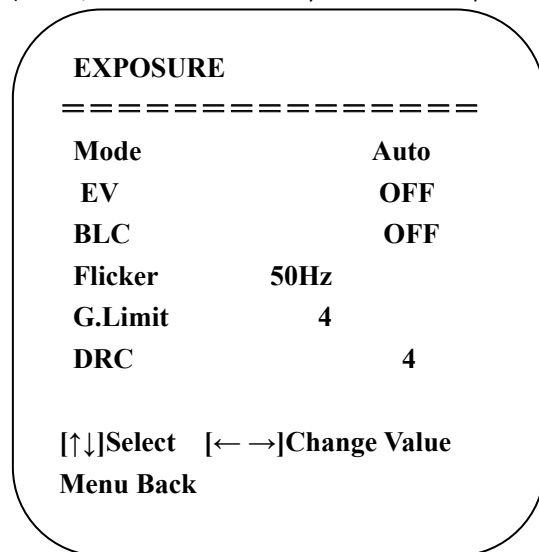

Mode: Auto, Manual, Shutter priority, Iris priority and Bright.

EV: On/Off (only available in Auto mode)

EV Level: -7~7 (only available in Auto mode when EV is ON)

BLC: ON/OFF (only available in Auto mode)

Flicker: OFF/50Hz/60Hz for options (only available in Auto/Iris **priority**/Bright modes)

Gain Limit: 0~15(only available in Auto/ Iris **priority** /Bright modes)

DRC: Close, values 1~8

Shutter Priority:

1/25,1/30,1/50,1/60,1/90,1/100,1/120,1/180,1/250,1/350,1/500,1/1000,1/2000,1/3000,1/4000,1/6000,1/10000 (only

available in Manual and Shutter priority mode)

IRIS Priority: Close, F11, F9.6, F8.0, F6.8, F5.6, F4.8, F4.0, F3.4, F2.8, F2.4, F2.0, F1.8 (only available in Manual Exposure and Iris priority mode)

Bright: 0~23 (only available in Bright **priority** mode)

2) COLOR

Move the pointer to the (Color) menu, click the **【HOME】** key to enter into Color menu as follow,

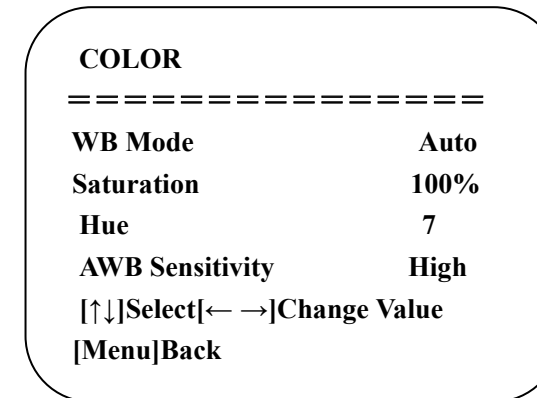

WB Mode: Auto, Manual, One Push, VAR

Color Temp: 2400K ~ 7100K (only available in VAR mode)

Red Gain: 0~255(only available in Manual mode)

Blue Gain: 0~255(only available in Manual mode)

Saturation: 60%,70%,80%,90%,100%,110%,120%,130%,140%,150%,160%,170%,180%,190%,200%

Hue: 0~14

AWB Sensitivity: High/Middle/Low (only available in Auto mode)

3) IMAGE

Move the pointer to the (Image) menu, click the **【HOME】** key to enter into the Image menu as follow,

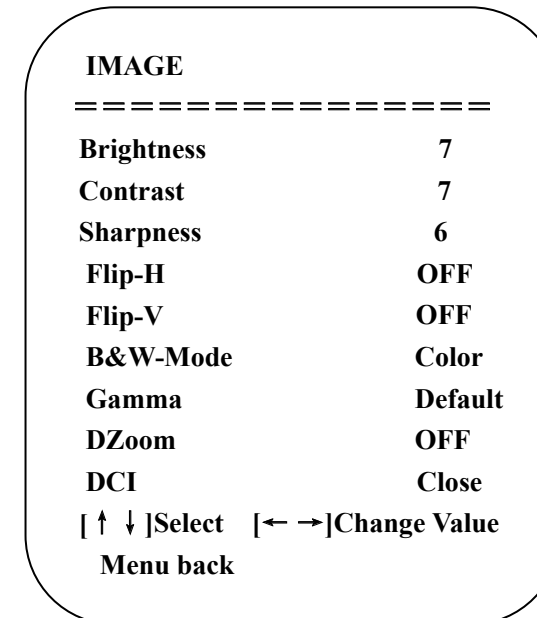

Brightness: 0~14

Contrast: 0~14

Sharpness: 0~15
 Flip-H: On/Off (When Auto Flip is ON, this option will be disabled)
 Flip-V: On/Off (When Auto Flip is ON, this option will be disabled)
 B&W Mode: Color, B&W
 Gamma: Default, 0.45, 0.50, 0.55, 0.63
 DZoom: ON/OFF
 DCI (Dynamic Contrast): Close, 1~8

4) FOCUS

Move the pointer to the (Focus) menu, click the **【HOME】** key to enter into the Focus menu as follow,

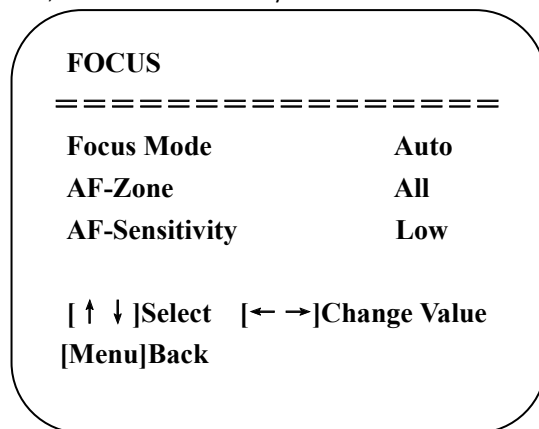

Focus Mode: Auto, Manual, OnePush
 AF-Zone: All, Top, Center, Bottom
 AF-Sensitivity: High, Middle, Low

5) NOISE REDUCTION

Move the pointer to the (Noise Reduction) menu, click the **【HOME】** key to enter into Noise Reduction menu as follow,

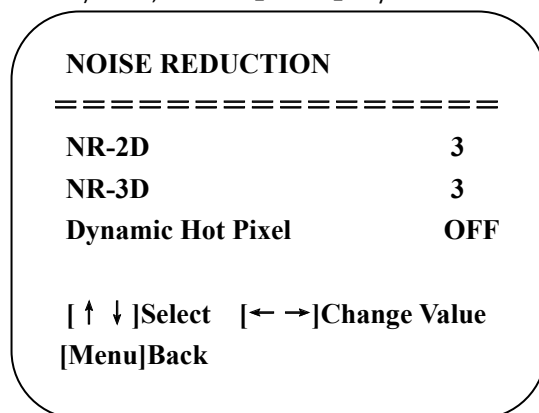

2D Noise Reduction: Auto, OFF, 1~7
 3D Noise Reduction: OFF, 1~8
 Dynamic Hot Pixel: OFF, 1~5

3.2.4 P/T/Z

Move the pointer to the (P/T/Z) in the Main Menu, click the **【HOME】** key to enter into P/T/Z menu as follow,

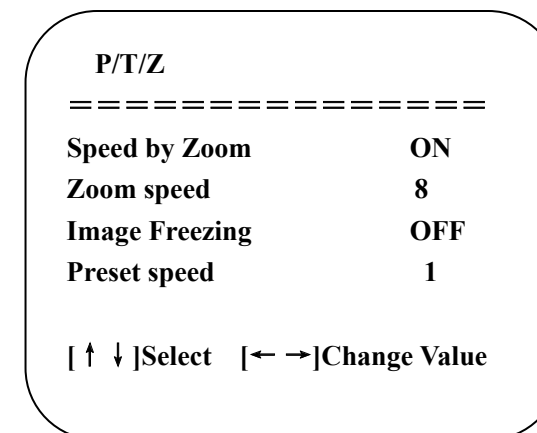

Speed by Zoom: ON/ Off (Only effective for IR remote controller. When this option is ON, the Pan/Tilt moving speed will become slower when the image is zoomed in.)
 Zoom Speed: 1~8 (Only effective for IR remote controller)
 Image Freezing: On/Off
 Preset speed: 1-10

3.2.5 Video Format

Move the pointer to the (Video Format) in the mian Menu, click the **【HOME】** key to enter into video format menu as follow,

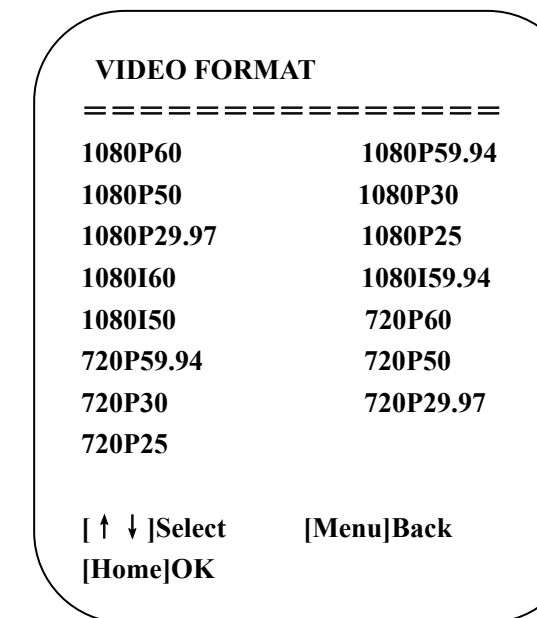

3.2.6 Network settings

Move the pointer to the (Network Settings) in the Main Menu, click the **【HOME】** key to enter into network settings menu as follow,

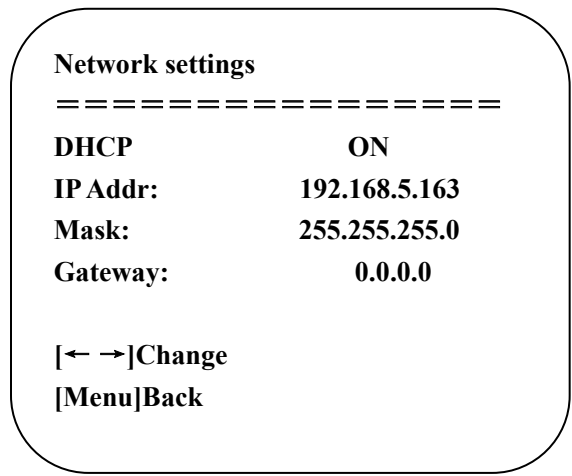

Note: Connect Ethernet cable to camera first. After setting DHCP to ON or OFF, save and exit by pressing Menu key to exit OSD menu completely. Then power cycling the camera for IP address to take effect. The camera actual IP address will be displayed in network settings menu after power cycling.

3.2.7 Audio settings

Move the pointer to the (Audio Settings) in the Main Menu, click the **【HOME】** key to enter into audio settings menu as follow,

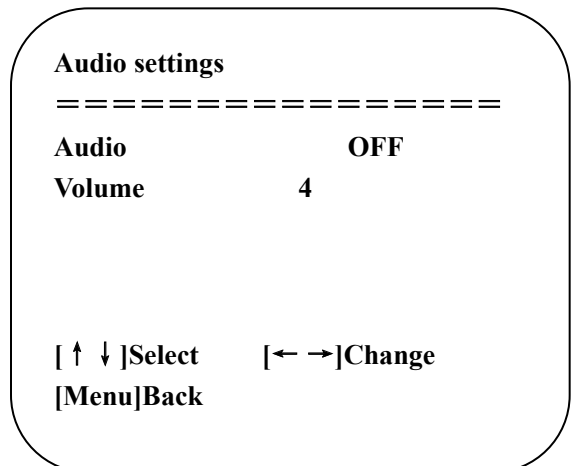

3.2.8 Version

Move the pointer to the (Version) in the Main Menu, click the **【HOME】** key to enter into version menu as follow,

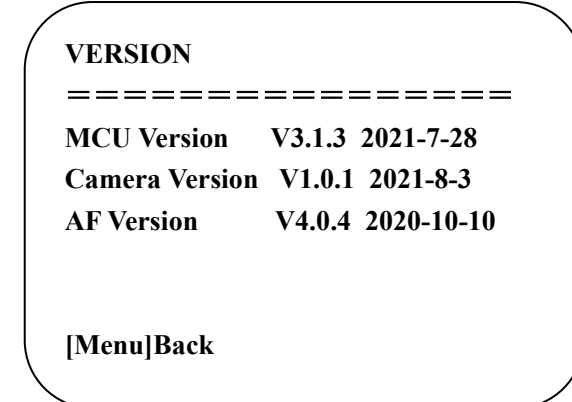

MCU Version: Display MCU version information
Camera Version: Display camera version information

AF Version: Display the focus version information

3.2.9 Restore Default

Move the pointer to the (Restore Default) in the Main Menu, click the **【HOME】** key to enter the restore default menu as follow,

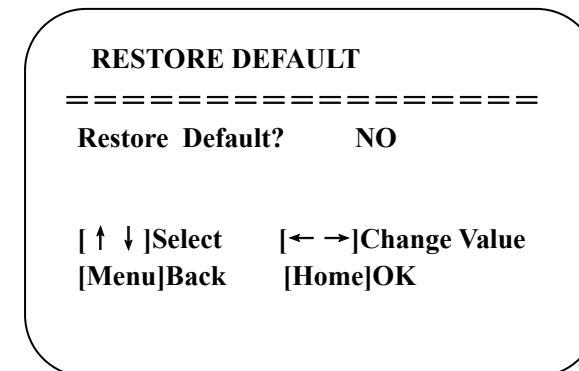

Restore default: options: yes/no; after restoring default, the video format restores to default. The things that are not restored are VISCA address, baud rate and IP address.

4. Network Connection

4.1 Connecting Mode

Direct connection: Connect the camera directly to a computer by Ethernet cable.
Internet connection (DHCP): Connect the camera to Internet by Router or Switch and user can log in the device by browser.

Note: Please do not put the power and network cable in places where can be easily touched to prevent video quality lowered by unstable signal transmission due to poor contact of cables.

Direct connection (Using Default IP):
The computer must have the network segment where the camera IP address belongs to. The device will not be accessible if without the segment. I.E. The camera default IP address is 192.168.5.163, then segment 5 must be added in the computer. Specific steps are as below:

First open Local Area Connection Properties on computer, select the **“Internet Protocol Version 4(TCP/IPv4)”** as shown below. Double click **“Internet Protocol Version 4(TCP/IPv4)”** or click **“Properties”** to enter into the Internet Protocol Version 4(TCP/IPv4) Properties window. Under **“General”** tap, select **“Use the following IP address”**. Enter the static IP **“192.168.5.26”** which has the same network segment as camera default IP address and subnet mask **“255.255.255.0”** as picture below. Click **“OK”** to finish.

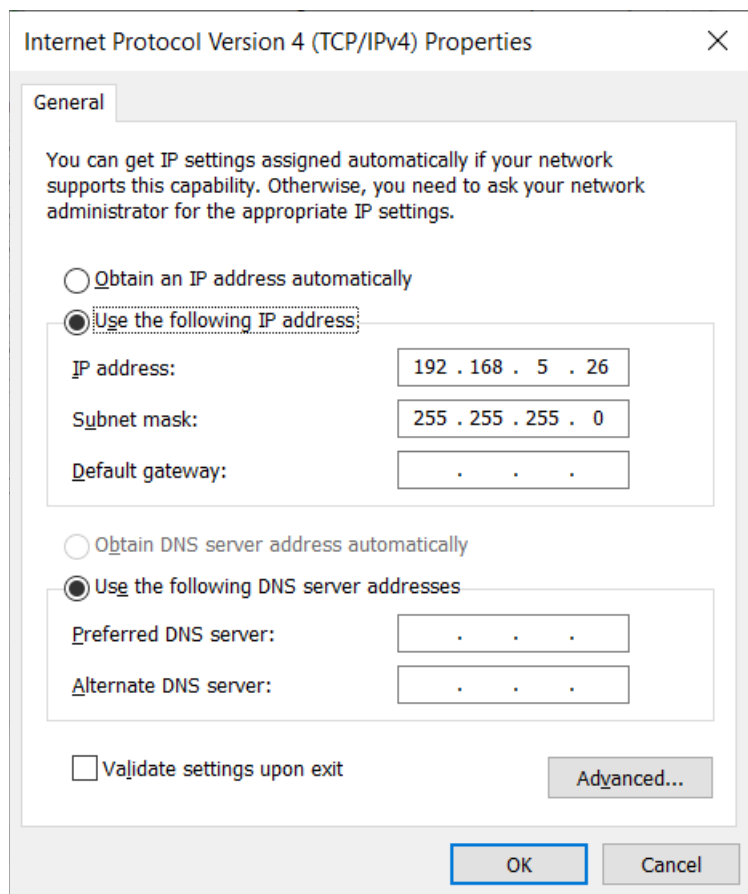
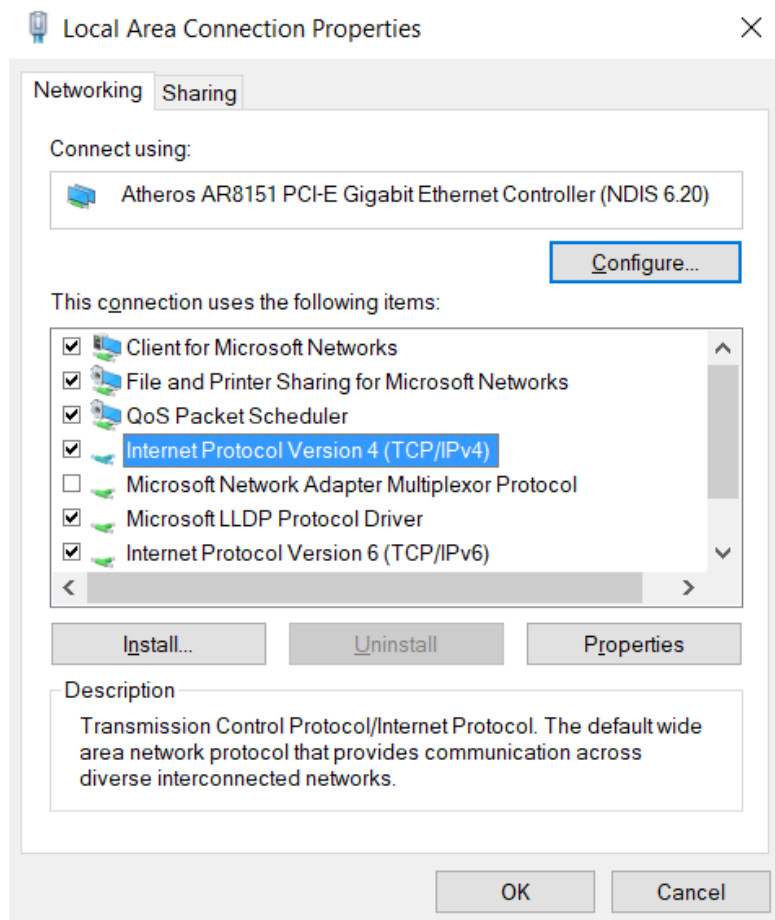

Internet connection (Using DHCP):

To use DHCP, first turn on DHCP in Network Settings OSD menu on camera. Power cycle the camera so the network can assign an IP address to the camera. Check the assigned IP address in Network Setting OSD menu again and use the address to log into camera webpage. Please make sure computer and camera are connected to the same network and “**Obtain an IP address automatically**” needs to be selected in computer’s “Internet Protocol Version 4 (TCP/IPv4) Properties window.

4.2 IE Log In

4.2.1 Web client

1) Web client Log In

Input the IP address 192.168.5.163 of the device in the address filed of browser and click Enter button to enter into Web Client login page as below picture. User can login as administrator and normal user. If login as administrator (Default User name/Password: admin), users can preview, configuration and logout in the Web Client; If login in as normal user (Default User name/Password:user1 or user2), users can only preview, and logout, no option for configuration.

2) Download/Install Plug-in

When first using IE browser to access the web conferencing camera, the login page will appear “Playback plug-in is not installed, please download and install!”. Click on this message, download and install MRWebXinstall.exe, according to information prompts.

After installing the plug-in, enter user name and password, click and Sign (default user name and password is "admin", users can change the user name and password after initial setup) into the Web client management interface.

4.2.2 Preview

After successful login into the management interface, it enters the video preview interface. In the preview screen, users can control PTZ, zoom, focus, video capture, sound, focus, full screen and set the preset position, run, delete and other operations.

1) Login as administrator

Username and password are both admin by default;

Available features: PTZ control, zoom, focus, audio, full screen, set/run/delete preset positions, preview, configure and logout.

2) Login as normal user

Default User name/password: user1 or user2

Available features: PTZ control, zoom, focus, audio, full screen, set/run/delete preset positions, preview and logout.

NOTE: There is no configuration right for normal user login.

4.2.4 Configuration

Click **Configuration** to enter into the device parameters setting page

There are the following options: Audio configure, Video configure, Network Configure, System Configure, please see the following table about detailed description.

Menu	Explanation
Audio configure	Including encode type, sample rate, sample bits, bit rate, channel and input volume
Video configure	Including video encode, stream publish, RTMP multicast, video OSD, OSD font size, video out
Network configure	Including network port, Ethernet, DNS, GB28181 and RTSP
System Configure	Including SysAttr, system, sysuser, update, default and reboot

1) Audio Configuration

Enable: Choose to enable the audio input or choose to not.

Encode Type: Set audio compressing format and the device will reboot automatically after change (default AAC, MP3, AAC optional)

Sampling Rate: Set sampling frequency and the device will reboot automatically after change (default 48000,16000,32000 and 44100 optional)

Sampling Bits: Set sampling precision (default 16bits)

Bit Rate: Set audio compressing code rate (default 64bits,32,48,96,128bits optional)

Channel: Set channel types (Default mono channel, Stereo audio optional)

Input Audio volume: Set the volume of input volume (Default 4, 1~10 optional)

Click "SAVE", it will remind that Success! Needs to Restart the device to enable the audio, then please reboot the camera to make new setting effect.

2) Video configuration

Video Encode

Stream: Different video output mode setting, use different streams. (Main stream, Sub stream)

Compression Format: Set the video compression format, save and reboot to take it effect (primary / secondary stream default: H.264, H.265 optional)

Image Size: Set video image resolution, save and reboot to take it effect (main stream default 1920 * 1080, 1280 * 720 and 640*480 are optional; default Sub stream 320 * 180, 320*240, 640*360, 640*480, 1280*720,1920 * 1080 are optional)

Rate control: Set rate control mode, save and reboot to take it effect (Primary / secondary stream default variable bit rate, fixed rate is for option).

Image Quality: Set the image quality, image quality can be changed only when rate control is variable bit rate, (main stream defaulted is better, secondary stream default is not good, there are best, better, good, bad, worse, worst for options).

Bit Rate (Kb/s): Set the video bit rate (main stream default 4096Kb / s,64-12288Kb / s optional; secondary stream default 1024Kb / s,64-10240Kb / s optional).

Frame Rate (F/S): Set the video frame rate (primary / secondary stream default 25F / S, primary stream 5-60F/S optional, secondary stream 5-30F / S optional).

I frame interval: Set the key frame interval (primary / secondary stream default 75F, primary / stream 1-300F optional, secondary stream 1-150F optional).

I Frame Minimum QP: set key framing minimum QP (default 10,10-51 optional)

Stream Key: When receiving rtsp or rtmp stream, the user can modify the stream name; the main stream (default live / av0), secondary stream (default live / av1)

Note: Usually reserve LIVE, but only modify the latter part.

Click the "Save" button to display the "saved successfully" message, then settings take effect.

Stream Publish:

Enable: To turn on/off the main / secondary stream.

Protocol Type: primary / secondary stream applies RTMP protocol.

Host Port: server port number (default 1935,0-65535 optional)

URL: server IP addresses (default 192.168.5.11)

Stream Key: choose a different stream name (live / av0, live/ av1 optional).

Username: Set the user name.

Password: Set the password.

Click on the "Save" button to display the "Save successful" message, then settings take effect.

Method of obtaining RTSP: rtsp: // device IP address: 554 / live / av0 (av0 main stream; av1 secondary stream)

RTP Multicast:

Main/Sub code stream: can select by ON/OFF

Protocol Type: can choose multicast protocol (default RTP, TS optional)

Multicast Address: can set multicast address, default 224.1.2.3

Multicast Port: can set multicast port (default main code stream port is 4000, default secondary code stream port is 4002,)

Access Method: Fill in or select the information as above to create the visiting address: such as rtp://224.1.2.3:4000; udp://@224.1.2.3:4000;

Video Parameters:

a, Focus: Focus mode, focus range, focus sensitivity can be set.

Focus Mode: set the focus mode (the default auto, manual optional)

Focus range: set the focus range (the default middle, the upper and lower optional)

AF-Sensitivity: Set the focus sensitivity (default is low, high, medium optional)

b, Exposure:

Mode: Set the exposure mode (the default Atuo, manual, SAE, AAT, Bright optional)

EV: Set the exposure compensation value, valid when it is set for auto (default 0,-7 to 7 optional).

BLC: Set back light compensation, valid when it is auto status (default is off).

Anti-flicker: Set up anti-flicker mode, valid when status of automatic, aperture or brightness priority (default 50Hz, closed,60Hz optional).

Gain limit: set the gain limits, auto, active when it is status of aperture or brightness priority(default 3, 0-15 optional).

Dynamic range: set the dynamic range (default 4,1-8 optional).

c, Color: White balance, saturation, color, white balance, sensitivity, color temperature, gain red and blue gain can be set.

White balance modes: Set the white balance mode (the default automatic, manual, One-push, VAR optional).

Saturation: Set the saturation (default 80%,60%,70%,80%,90%,100%,110%,120%,130%, optional).

Auto white balance Sensitivity: Sensitivity Auto white balance settings (default is low, high, medium optional).

Chroma: Set the chrome (default 7,0-14 optional).

Color Temperature: set color temperature (Default setting: High, with low, middle for options)

Red Gain: Set the red gain, effective when it is manual (default 255,0-255 optional).

Blue Gain: Sets the Blue gain, effective when it is manual (default 199,0-255 optional).

d, Image: Brightness, contrast, sharpness, black and white mode, the gamma curve, Horizontal Flip and Vertical Flip can be set.

Brightness: Set the brightness (default 6,0-14 optional).

Contrast: set the contrast (default 8,0-14 optional).

Sharpness: Set the sharpness value (default 7, 0-15 optional).

Black and white mode: Set black and white mode (default color, black/white optional).

Gamma: Gamma value setting (default,0.45,0.50,0.52,0.55 optional).

Flip Horizontal: Set Flip Horizontal (default Off, On optional).

Flip Vertical: Set vertical flip (default Off, On optional).

e. Noise Reduction: 2D noise reduction,3D noise reduction and dynamic dead pixel correction available.

2D Noise Reduction: Set 2D noise reduction level (default Auto,1-7 and Off optional).

3D Noise Reduction: Set 3D noise reduction level (default 5,1-8 and Off optional).

Dynamic dead pixel correction: Set Dynamic dead pixel correction (default Off,1-8 optional).

Note: Click "Refresh" to make revision of any video parameters of a, b, c, d, e effective.

3) Video OSD

Show Time: Set whether to display the time and date (default display).

Show Title: Set whether to display the title (default display).

Font Color of Time: Set font color of time and date (default white, black, yellow, red, blue optional).

Font Color of Title: Set font color of title (default white, black, yellow, red, blue optional).

Moving characters: Set the display position of moving date, time and title, click on the "up, down, left, right" buttons to move the corresponding character position.

Title Content: Set title content (default CAMERA1).

Time Content: Set time content (default 1970/01/10 05:36:00)

Click on the "Save" button and display the "Save successful" message, then valid

4) OSD Font Size

Auto zoom in/out according to the resolution.

Master stream font size: Set the character size of the display, the device will restart automatically after changed and saved (default 48, 28-200 optional)

Slave stream font size: Set the character size of the display, the device will restart automatically after changed and saved (default 48, 28-200 optional)

Click on the "Save" button to display "Parameter saved successfully" message, set to take effect

5) Video Out

Video Output Format: Set the video output format

1080p60, 1080p59.94, 1080p50, 1080p30, 1080p29.97, 1080p25, 1080i60, 1080i59.94, 1080i50, 720p60, 720p59.94, 720p50, 720p30, 720p29.97, 720p25

Click on the "Save" button, a message "Save the parameters successfully" will display at lower right corner.

4.2.6 Network Configure

1) Network port

Port Data: set the data port, the device will restart automatically after changed (default 3000,0-65535 optional).

Port Web: Set Web port, the device will restart automatically after changed (default is 80,0-65535 is optional).

Port Onvif: Set Onvif port, the device will restart automatically after changed (default 2000,0-65535 optional).

Port Soap: Set Soap port (default 1936,0-65535 optional).

Port RTMP: Set RTMP port (default 1935,0-65535 optional).

Port RTSP: Set RTSP port, the device will restart automatically after changed (default 554,0-65535 optional).

Port Visca: Set Visca port, the device will restart automatically after changed (default 3001,0-65535 optional).

Click on the "Save" button, it will be valid when display "Save successful".

Port Hhttps: Set Hhttps port (default 443).

Port WebSocket: Set WebSocket port (default 8088).

RTSP access: RTSP: // equipment IP address: 554/live/av0 (av0 main stream; av1 second stream)

RTMP access: RTMP: // equipment IP address: 1935 / live/av0 (av0 main stream; av1 second stream)

2) Ethernet

DHCP: Enable or disable obtain IP automatically can be set. Save changes and reboot the device to takes effect (Default: OFF)

IP Address: Set the IP address, save changes and reboot the device to takes effect (default 192.168.5.163). Note: This IP address is the same with the one used to login Web page.

Subnet Mask: Set the subnet mask (default 255.255.255.0).

Default Gateway: Set the default gateway (default 0.0.0.0).

Mac Address: Set the physical address (the parameter is read-only but cannot be modified).

Click on the "Save" button, it will be valid when display "Save successful". (Note: To prevent IP conflicts When modify).

3) DNS parameters

Preferred DNS server: set the preferred DNS server. (Default 0.0.0.0).

Alternate DNS server: Alternate DNS server settings. (Default 0.0.0.0).

Click on the "Save" button, it will be valid when display "Save successful".

4) GB28181

Switch: set whether open GB28181, can check

Time Synchronization: whether synchronization time is set, you can check

Stream Type: stream type setting (the default main stream, secondary stream optional)

Sign effective time (in seconds): 3600 Range 5-65535

Heartbeat time (seconds): 60 Range 1-65535

Register ID: 34020000001320000001

Register User name: IPC

Register Password: 12345678

Equipment ownership: Users can add their own

Administrative regions: Users can add their own

Alarm Zone: Users can add their own

Equipment installation address: Users can add their own

Local SIP Port: 5060 Range 0-65535

GB28181 Server Address: IP address of the computer

Server SIP Port: 5060 Range 0-65535

Server ID: 34020000002000000001

Click on the "Save" button, it will be valid when display "Save successful".

4) RTSP

RTSP Authentication: Enable or Disable it and save.

4.2.7 System Configure

1) System Attribute

Device Name: Set the device name (the default Camera1, user can add their own).

Device ID: Set the device ID (default 1, Read-Only).

Language: Set the system language. Need to re-login after modify and save the setting.

Click on the "Save" button, it will be valid when display "Save successful".

2) System Time

Date Format: Set the date format (YYYY-MM-DD default That year - month - day, MM-DD-YYYY namely Month - Day - Year, DD-MM-YYYY date - month - year Optional).

Date separator: set the date separator (default '/', '-', ' ' Optional).

Zone: Set the time zone (default East eight districts, other time zones optional).

Hour Type: Set the time types (default 24 hours, optional 12 hours).

Time setting: Set time mode (to choose the computer time synchronization, NTP server time synchronization, or set manually).

Computer Time: Set the computer synchronization valid.

Update interval: Set the NTP server automatic updated time interval. Valid after setting NTP server synchronization (default one day,2-10 days Optional).

NTP server address or domain name: Set NTP server address or domain name (default time.nits.gov). Valid after setting NTP server synchronization.

NTP Server Port: Sets the NTP server port (default 123). Valid after setting NTP server synchronization.

Set the time manually, Effective when set manually.

Click on the "Save" button, it will be valid when display "Save successful".

3) Sys User

Authority: Set the user type (the default administrator, Common User 1, Common User 2 optional)

User name: set the user name (Select User Administrator default admin; select a common user1 default user1; to select a common user 2 default user2; user can modify their own)

Password: Set a password (Select User Administrator default admin; select a common user1 default user1; to select a common user 2 default user2; user can modify their own).

Confirm Password: Confirm the input passwords are the same or not.

Click on the "Save" button to display the "Save the parameters successfully" message, then the set is to take effect.

Note: Please note the case-sensitivity of the user name and password.

If login page by a common user's name and password, one does not have configuration privileges but can only operate to preview, playback, logoff.

4) Update

MCU version: V3.1.3 2021-7-28

Camera version: V1.0.1 2021-8-3

AF version: V4.0.4 2020-10-10

Users only read the version information above which is consistent with the menu version but cannot modify.

Update file:

Click "Browse ..." installation, to select the upgrade file in the pop-up window.

Click on the "Upgrade" button, the upgrade dialog will appear. the device will reboot automatically after update successfully. (Note: make sure the power and network connected during the process or the upgrade will fail)

Note: After the version upgrade is complete, please restore factory default settings by any one of these 3 methods: a. Using webpage to restore factory defaults; b. Using camera OSD menu to restore factory defaults; c. Using IR remote controller shortcut keys combination * + # + 6 to restore factory defaults;

5) Default

Click on pop-up "Restore Factory Defaults" button and choose "yes" or "no", then the device will restart automatically and restore factory setting.

6) Reboot

Click on the pop-up "Reboot" button and choose "yes" or "no", then the device will restart automatically

4.2.8 Logout

Point "Logout" pop-up "Confirmation" dialog; select "Yes" or "No",choose "Yes" to exit the current page and return to the user login interface again.

the allocation of IP address.

5. Serial Communication Control

CV605 can also be controlled via RS232/RS485 interface (VISCA), RS232C serial parameter are as follows:

Baud rate: 2400/4800/9600/115200 bits / sec; Start bit: 1; data bits: 8; Stop bit: 1; Parity: None.

After power on, the camera first goes left, then back to the middle position. Self-test is finished after the zoom moved to the farthest and then back to the nearest position. If the camera saved 0 preset before, it will be back to that position after initialization. At this point, the user can control the camera by the serial commands.

5.1 VISCA protocol list

5.1.1 Command list

Command Set	Command	Command Packet	Comments
CAM_ID	CAM ID	88 30 0p FF	p: camera ID (1 to 7)
CAM_Power	On	8x 01 04 00 02 FF	Power on/off
	Off	8x 01 04 00 03 FF	
CAM_Zoom	Stop	8x 01 04 07 00 FF	p=0 (Low) to 7 (High)
	Tele(Standard)	8x 01 04 07 02 FF	
	Wide(Standard)	8x 01 04 07 03 FF	
	Tele(Variable)	8x 01 04 07 2p FF	
	Wide(Variable)	8x 01 04 07 3p FF	
CAM_Focus	Stop	8x 01 04 08 00 FF	p=0 (Low) to 7 (High)
	Far (Variable)	8x 01 04 08 2p FF	
	Near (Variable)	8x 01 04 08 3p FF	
	Auto Focus	8x 01 04 38 02 FF	AF on/off
	Manual Focus	8x 01 04 38 03 FF	
	One Push Triggel	8x 01 04 18 01 FF	
CAM_WB	Auto	8x 01 04 35 00 FF	Normal auto
	Indoor	8x 01 04 35 01 FF	Indoor mode
	Outdoor	8x 01 04 35 02 FF	Outdoor mode
	One Push WB	8x 01 04 35 03 FF	One push WB mode
	ATW	8x 01 04 35 04 FF	Auto tracing WB
	Manual	8x 01 04 35 05 FF	Manual control mode
CAM-RGain	Up	8x 01 04 03 02 FF	Manual control of R Gain
	Down	8x 01 04 03 03 FF	
CAM_BGain	Up	8x 01 04 04 02 FF	Manual control of B Gain
	Down	8x 01 04 04 03 FF	
CAM_AE	Full Auto	8x 01 04 39 00 FF	Auto exposure mode
	Manual	8x 01 04 39 03 FF	Manual control mode
	Shutter Priority	8x 01 04 39 0A FF	Shutter priority mode
	Iris Priority	8x 01 04 39 0B FF	Iris priority mode
CAM_Shutter	Up	8x 01 04 0A 02 FF	Shutter setting
	Down	8x 01 04 0A 03 FF	
CAM_Iris	Up	8x 01 04 0B 02 FF	Iris setting
	Down	8x 01 04 0B 03 FF	
CAM_Backlight	On	8x 01 04 33 02 FF	Back light compensation on/off
	Off	8x 01 04 33 03 FF	
CAM_LR_Reverse	On	8x 01 04 61 02 FF	LR reverse on/off
	Off	8x 01 04 61 03 FF	
CAM_Freeze	On	8x 01 04 62 02 FF	Freeze on/off
	Off	8x 01 04 62 03 FF	
CAM_Stabilizer	On	8x 01 04 34 02 FF	stabilizer on/off
	Off	8x 01 04 34 03 FF	
CAM_Preset	Reset	8x 01 04 3F 00 0p FF	p: Preset number

	Set	8x 01 04 3F 01 0p FF	
	Recall	8x 01 04 3F 02 0p FF	
CAM_Display	On/Off	8x 01 06 06 10 FF	Datascreen on/off
Pan-tiltDrive	Up	8x 01 06 01 VV WW 03 01 FF	VV: Pan speed (01 to 18) WW: Tilt speed (01 to 14)
	Down	8x 01 06 01 VV WW 03 02 FF	
	Left	8x 01 06 01 VV WW 01 03 FF	
	Right	8x 01 06 01 VV WW 02 03 FF	
	Upleft	8x 01 06 01 VV WW 01 01 FF	
	Upright	8x 01 06 01 VV WW 02 01 FF	
	Downleft	8x 01 06 01 VV WW 01 02 FF	
	Downright	8x 01 06 01 VV WW 02 02 FF	
	Stop	8x 01 06 01 VV WW 03 03 FF	
	Home	8x 01 06 04 FF	
Reset	8x 01 06 05 FF		

5.1.2 Inquiry command

Inquiry Command	Command Packet	Inquiry Packet	Comments
CAM_PowerInq	8x 09 04 00 FF	y0 50 02 FF	On
		y0 50 03 FF	Off (Standby)
CAM_FocusModelInq	8x 09 04 38 FF	y0 50 02 FF	Auto focus
		y0 50 03 FF	Manual focus
CAM_WBModelInq	8x 09 04 35 FF	y0 50 00 FF	Auto
		y0 50 01 FF	Indoor
		y0 50 02 FF	Outdoor
		y0 50 03 FF	One push WB
		y0 50 04 FF	ATW
		y0 50 05 FF	Manual
CAM_RGainInq	8x 09 04 43 FF	y0 50 00 00 0p 0q FF	pq: R Gain
CAM_BGainInq	8x 09 04 44 FF	y0 50 00 00 0p 0q FF	pq: B Gain
CAM_ShutterPosInq	8x 09 04 4A FF	y0 50 00 00 0p 0q FF	pq: Shutter position
CAM_IrisPosInq	8x 09 04 4B FF	y0 50 00 00 0p 0q FF	pq: Iris position
CAM_BackLightModelInq	8x 09 04 33 FF	y0 50 02 FF	On
		y0 50 03 FF	Off
CAM_LR_ReverseModelInq	8x 09 04 61 FF	y0 50 02 FF	On
		y0 50 03 FF	Off
CAM_FreezeModelInq	8x 09 40 62 FF	y0 50 02 FF	On
		y0 50 03 FF	Off
CAM_PictureFlipModelInq	8x 09 04 15 FF (8x 09 06 06 FF)	y0 50 02 FF	On
		y0 50 03 FF	Off
CAM_StabilizerModelInq	8x 09 04 34 FF	y0 50 02 FF	On
		y0 50 03 FF	Off

Note:[X] in the above table indicates the camera address to be operated, [y] = [x + 8] .

5.2 Pelco-D protocol command list

Function	Byte1	Byte2	Byte3	Byte4	Byte5	Byte6	Byte7
Up	0xFF	Address	0x00	0x08	Pan Speed	Tilt Speed	SUM
Down	0xFF	Address	0x00	0x10	Pan Speed	Tilt Speed	SUM
Left	0xFF	Address	0x00	0x04	Pan Speed	Tilt Speed	SUM
Right	0xFF	Address	0x00	0x02	Pan Speed	Tilt Speed	SUM
Upleft	0xFF	Address	0x00	0x0C	Pan Speed	Tilt Speed	SUM
Upright	0xFF	Address	0x00	0x0A	Pan Speed	Tilt Speed	SUM
DownLeft	0xFF	Address	0x00	0x14	Pan Speed	Tilt Speed	SUM
DownRight	0xFF	Address	0x00	0x12	Pan Speed	Tilt Speed	SUM
Zoom In	0xFF	Address	0x00	0x20	0x00	0x00	SUM
Zoom Out	0xFF	Address	0x00	0x40	0x00	0x00	SUM
Focus Far	0xFF	Address	0x00	0x80	0x00	0x00	SUM
Focus Near	0xFF	Address	0x01	0x00	0x00	0x00	SUM
Set Preset	0xFF	Address	0x00	0x03	0x00	Preset ID	SUM
Clear Preset	0xFF	Address	0x00	0x05	0x00	Preset ID	SUM
Call Preset	0xFF	Address	0x00	0x07	0x00	Preset ID	SUM
Query Pan Position	0xFF	Address	0x00	0x51	0x00	0x00	SUM
Query Pan Position Response	0xFF	Address	0x00	0x59	Value High Byte	Value Low Byte	SUM
Query Tilt Position	0xFF	Address	0x00	0x53	0x00	0x00	SUM
Query Tilt Position Response	0xFF	Address	0x00	0x5B	Value High Byte	Value Low Byte	SUM
Query Zoom Position	0xFF	Address	0x00	0x55	0x00	0x00	SUM
Query Zoom Position Response	0xFF	Address	0x00	0x5D	Value High Byte	Value Low Byte	SUM

5.3 Pelco-P protocol command list

Function	Byte1	Byte2	Byte3	Byte4	Byte5	Byte6	Byte7	Byte8
Up	0xA0	Address	0x00	0x08	Pan Speed	Tilt Speed	0xAF	XOR
Down	0xA0	Address	0x00	0x10	Pan Speed	Tilt Speed	0xAF	XOR
Left	0xA0	Address	0x00	0x04	Pan Speed	Tilt Speed	0xAF	XOR
Right	0xA0	Address	0x00	0x02	Pan Speed	Tilt Speed	0xAF	XOR
Upleft	0xA0	Address	0x00	0x0C	Pan Speed	Tilt Speed	0xAF	XOR
Upright	0xA0	Address	0x00	0x0A	Pan Speed	Tilt Speed	0xAF	XOR
DownLeft	0xA0	Address	0x00	0x14	Pan Speed	Tilt Speed	0xAF	XOR
DownRight	0xA0	Address	0x00	0x12	Pan Speed	Tilt Speed	0xAF	XOR
Zoom In	0xA0	Address	0x00	0x20	0x00	0x00	0xAF	XOR
Zoom Out	0xA0	Address	0x00	0x40	0x00	0x00	0xAF	XOR
Focus Far	0xA0	Address	0x01	0x00	0x00	0x00	0xAF	XOR
Focus Near	0xA0	Address	0x02	0x00	0x00	0x00	0xAF	XOR
Set Preset	0xA0	Address	0x00	0x03	0x00	Preset ID	0xAF	XOR

Clear Preset	0xA0	Address	0x00	0x05	0x00	Preset ID	0xAF	XOR
Call Preset	0xA0	Address	0x00	0x07	0x00	Preset ID	0xAF	XOR
Query Pan Position	0xA0	Address	0x00	0x51	0x00	0x00	0xAF	XOR
Query Pan Position Response	0xA0	Address	0x00	0x59	Value High Byte	Value Low Byte	0xAF	XOR
Query Tilt Position	0xA0	Address	0x00	0x53	0x00	0x00	0xAF	XOR
Query Tilt Position Response	0xA0	Address	0x00	0x5B	Value High Byte	Value Low Byte	0xAF	XOR
Query Zoom Position	0xA0	Address	0x00	0x55	0x00	0x00	0xAF	XOR
Query Zoom Position Response	0xA0	Address	0x00	0x5D	Value High Byte	Value Low Byte	0xAF	XOR

6. Camera Maintenance and Troubleshooting

6.1 Camera Maintenance

- 1) If camera is not used for long periods of time, please turn off power and remove power source.
- 2) Use soft cloth or tissue to clean the camera cover.
- 3) Use soft cloth to clean the lens; Use neuter cleanser if badly smeared. Do not use strong or corrosive cleanser or corrosive cleanser to avoid scratching.

6.2 Troubleshooting

1) No video output

- a, Check to see if camera power supply is connected, the voltage is normal, the power indicator is lit.
- b, Is camera in self-inspection or initiation mode during a restart (power-cycle).
- c, Check whether the DIP switches on bottom of camera are in normal operating mode (see Table 2.2 and Table 2.3)
- d, Check video output cables (cables fail over time) and/or video display settings.

2) Image dithering when zoom-in or zoom-out

- a, Check mount or installation method to ensure camera is stable.
- b, Check whether there is vibration or shaking of the machine or obstacles for operation.

4) Remote controller doesn't work

- a, Check remote control address is set to 1 (if the machine is set back to the factory defaults, remote control addresses need to be set back to 1 also)
- b, Check batteries to ensure they're properly charged.
- c, Check the camera working mode, set to normal operating mode (see Table 2.2 and Table 2.3)
- d, Check the OSD menu whether its open or closed on screen, camera control through remote controller is only available after exiting the menu. If video output from LAN, menu will not be displayed, menu will automatically exist 30s later, then it can be controlled by remote controller.

5) Serial port doesn't work.

- a, Check whether the camera serial device protocol, baud rate, addresses match.
- b, Check whether the control cable is connected properly .
- c, Check whether the camera working mode is the normal operating mode (see Table 2.2 and Table 2.3)

6) Web pages cannot log in

a, Check whether the camera is setup and in normal working modes.

b, Check whether the network cable is connected properly (on Ethernet port the yellow light flashes to indicate normal network cable connection)

c, Check whether your computer settings match camera segment and that the segment is consistent with the IP address of the camera

d, Click "Start" and select "Run" and then type "CMD" in the computer; Click "OK" then turn on a DOS command window to enter ping 192.168.5.163. Press the Enter key to appear message as follows: Description network connection is normal

Warranty

Marshall warrants the VAC-23SHU3 HDMI to 3G/HD/SD-SDI Converter to be free from defects in the material and workmanship for 1 year from the date of purchase from an authorized Marshall dealer. Should this product fail to be in good working order within 1-year warranty period, Marshall will, at its option, repair or replace the unit, provided that the unit has not been subjected to accident, disaster, abuse or any unauthorized modifications including static discharge and power surges.

Unit that fails under conditions other than those specified above will be repaired at the current price of parts and labor in effect at the time of repair. Such repairs are warranted for 90 days from the day of reshipment to the BUYER. If the unit is delivered by mail, customers agree to insure the unit or assume the risk of loss or damage in transit. Under no circumstances will a unit be accepted without a return authorization number.

The warranty is in lieu of all other warranties expressed or implied, including without limitations, any other implied warranty or fitness or merchantability for any particular purpose, all of which are expressly disclaimed.

Proof of sale may be required in order to claim warranty. Cables are limited to a 30-day warranty and cable must be free from any markings or scratches.

The content of this manual has been carefully checked and is believed to be accurate. However, Marshall assumes no responsibility for any inaccuracies that may be contained in this manual. Marshall will NOT be liable for direct, indirect, incidental, special, or consequential damages resulting from any defect or -omission in this manual, even if advised of the possibility of such damages. Also, the technical information contained herein regarding the VAC-23SHU3 features and specifications is subject to change without further notice.

Marshall

20608 Madrona Avenue, Torrance, CA 90503

Tel: (800) 800-6608 / (310) 333-0606 • Fax: 310-333-0688

www.marshall-usa.com

support@marshall-usa.com