



**DTX**  
drums

Drum Trigger Module

# DTX-PRO

Owner's Manual

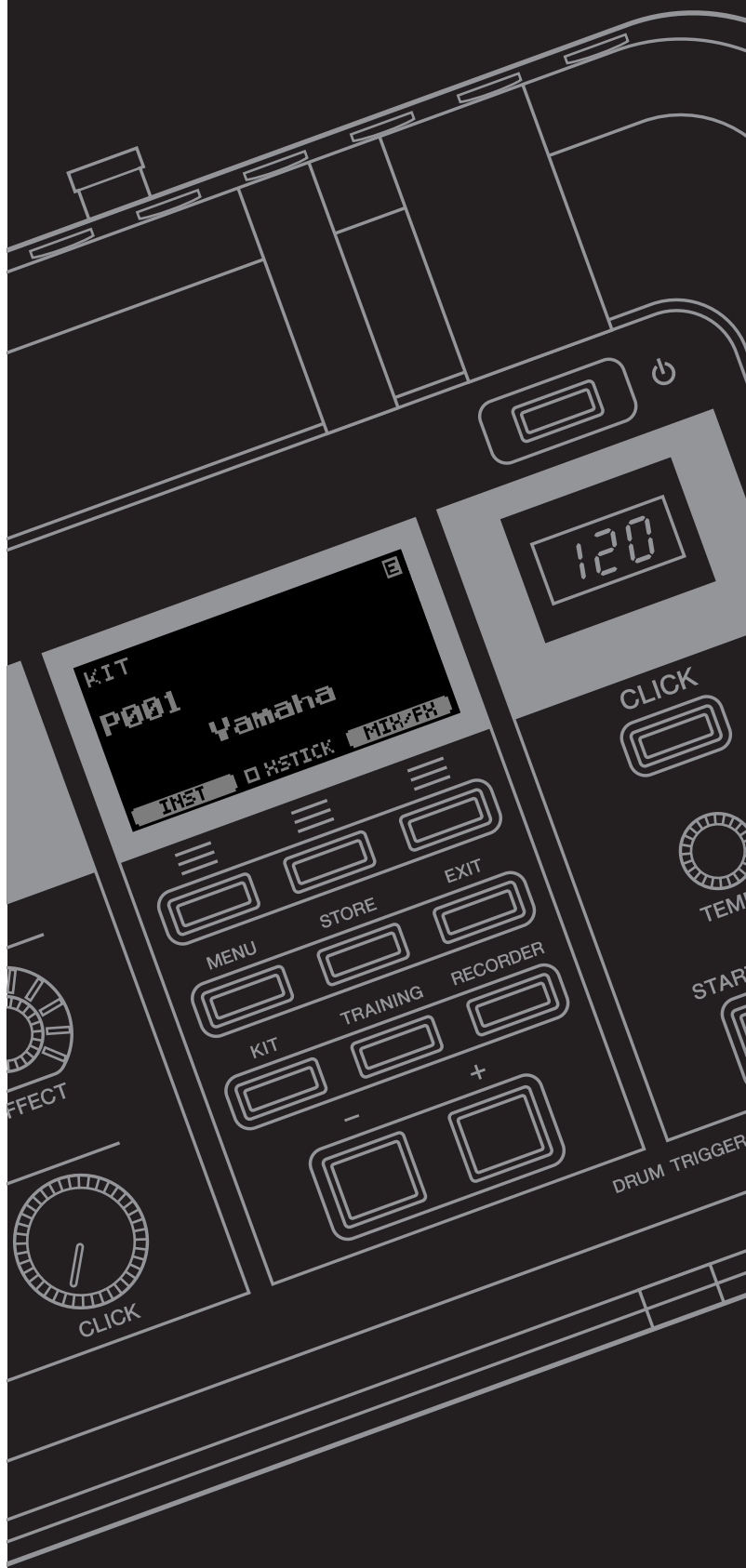

**Features of the  
DTX-PRO**

**page 8**

**Contents**

**page 9**

**Specifications**

**page 66**

## SPECIAL MESSAGE SECTION

This product utilizes batteries or an external power supply (adapter). DO NOT connect this product to any power supply or adapter other than one described in the manual, on the name plate, or specifically recommended by Yamaha.

**WARNING:** Do not place this product in a position where anyone could walk on, trip over, or roll anything over power or connecting cords of any kind. The use of an extension cord is not recommended! If you must use an extension cord, the minimum wire size for a 25' cord (or less) is 18 AWG. NOTE: The smaller the AWG number, the larger the current handling capacity. For longer extension cords, consult a local electrician.

This product should be used only with the components supplied or; a cart, rack, or stand that is recommended by Yamaha. If a cart, etc., is used, please observe all safety markings and instructions that accompany the accessory product.

### **SPECIFICATIONS SUBJECT TO CHANGE:**

The information contained in this manual is believed to be correct at the time of printing. However, Yamaha reserves the right to change or modify any of the specifications without notice or obligation to update existing units.

This product, either alone or in combination with an amplifier and headphones or speaker/s, may be capable of producing sound levels that could cause permanent hearing loss. DO NOT operate for long periods of time at a high volume level or at a level that is uncomfortable. If you experience any hearing loss or ringing in the ears, you should consult an audiologist.

**IMPORTANT:** The louder the sound, the shorter the time period before damage occurs.

### **NOTICE:**

Service charges incurred due to a lack of knowledge relating to how a function or effect works (when the unit is operating as designed) are not covered by the manufacturer's warranty, and are therefore the owners responsibility. Please study this manual carefully and consult your dealer before requesting service.

### **ENVIRONMENTAL ISSUES:**

Yamaha strives to produce products that are both user safe and environmentally friendly. We sincerely believe that our products and the production methods used to produce them, meet these goals. In keeping with both the letter and the spirit of the law, we want you to be aware of the following:

### **Battery Notice:**

This product MAY contain a small non-rechargeable battery which (if applicable) is soldered in place. The average life span of this type of battery is approximately five years. When replacement becomes necessary, contact a qualified service representative to perform the replacement.

This product may also use "household" type batteries. Some of these may be rechargeable. Make sure that the battery being charged is a rechargeable type and that the charger is intended for the battery being charged.

When installing batteries, never mix old batteries with new ones, and never mix different types of batteries. Batteries MUST be installed correctly. Mismatches or incorrect installation may result in overheating and battery case rupture.

### **Warning:**

Do not attempt to disassemble, or incinerate any battery. Keep all batteries away from children. Dispose of used batteries promptly and as regulated by the laws in your area. Note: Check with any retailer of household type batteries in your area for battery disposal information.

### **Disposal Notice:**

Should this product become damaged beyond repair, or for some reason its useful life is considered to be at an end, please observe all local, state, and federal regulations that relate to the disposal of products that contain lead, batteries, plastics, etc. If your dealer is unable to assist you, please contact Yamaha directly.

### **NAME PLATE LOCATION:**

The name plate is located on the bottom of the product. The model number, serial number, power requirements, etc., are located on this plate. You should record the model number, serial number, and the date of purchase in the spaces provided below and retain this manual as a permanent record of your purchase.

Model \_\_\_\_\_

Serial No. \_\_\_\_\_

Purchase Date \_\_\_\_\_

## PLEASE KEEP THIS MANUAL

92-BP (bottom)

### **COMPLIANCE INFORMATION STATEMENT (Supplier's declaration of conformity procedure)**

Responsible Party : Yamaha Corporation of America  
Address : 6600 Orangethorpe Ave., Buena Park, Calif. 90620  
Telephone : 714-522-9011  
Type of Equipment : Drum Trigger Module  
Model Name : DTX-PRO

This device complies with Part 15 of the FCC Rules.

Operation is subject to the following two conditions:

- 1) this device may not cause harmful interference, and
- 2) this device must accept any interference received including interference that may cause undesired operation.

\* This applies only to products distributed by Yamaha Corporation of America.

(FCC SD0C)

**CAN ICES-3 (B)/NMB-3(B)**

(can\_b\_02)

# For AC adapter and DTX-PRO

## FCC INFORMATION (U.S.A.)

**1. IMPORTANT NOTICE: DO NOT MODIFY THIS UNIT!**

This product, when installed as indicated in the instructions contained in this manual, meets FCC requirements. Modifications not expressly approved by Yamaha may void your authority, granted by the FCC, to use the product.

**2. IMPORTANT:** When connecting this product to accessories and/or another product use only high quality shielded cables. Cable/s supplied with this product **MUST** be used. Follow all installation instructions. Failure to follow instructions could void your FCC authorization to use this product in the USA.

**3. NOTE:** This product has been tested and found to comply with the requirements listed in FCC Regulations, Part 15 for Class "B" digital devices. Compliance with these requirements provides a reasonable level of assurance that your use of this product in a residential environment will not result in harmful interference with other electronic devices. This equipment generates/uses radio frequencies and, if not installed and used according to the instructions found in the users manual, may cause interference harmful to the operation of other electronic devices. Compliance with FCC regulations does

not guarantee that interference will not occur in all installations. If this product is found to be the source of interference, which can be determined by turning the unit "OFF" and "ON", please try to eliminate the problem by using one of the following measures:

Relocate either this product or the device that is being affected by the interference.

Utilize power outlets that are on different branch (circuit breaker or fuse) circuits or install AC line filter/s.

In the case of radio or TV interference, relocate/reorient the antenna. If the antenna lead-in is 300 ohm ribbon lead, change the lead-in to co-axial type cable.

If these corrective measures do not produce satisfactory results, please contact the local retailer authorized to distribute this type of product. If you can not locate the appropriate retailer, please contact Yamaha Corporation of America, Electronic Service Division, 6600 Orangethorpe Ave, Buena Park, CA90620

The above statements apply **ONLY** to those products distributed by Yamaha Corporation of America or its subsidiaries.

\* This applies only to products distributed by Yamaha Corporation of America.

(class B)

# For AC adaptor

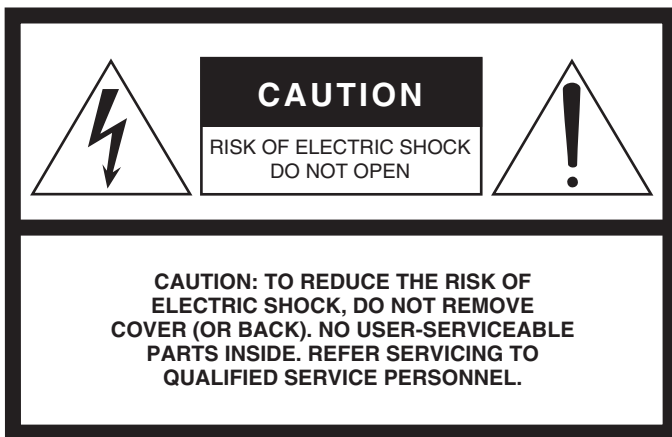

## Explanation of Graphical Symbols

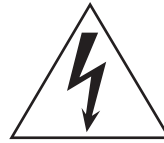

The lightning flash with arrowhead symbol within an equilateral triangle is intended to alert the user to the presence of uninsulated “dangerous voltage” within the product’s enclosure that may be of sufficient magnitude to constitute a risk of electric shock to persons.



The exclamation point within an equilateral triangle is intended to alert the user to the presence of important operating and maintenance (servicing) instructions in the literature accompanying the product.

The above warning is located on the bottom of the unit.

## IMPORTANT SAFETY INSTRUCTIONS

- 1 Read these instructions.
- 2 Keep these instructions.
- 3 Heed all warnings.
- 4 Follow all instructions.
- 5 Do not use this apparatus near water.
- 6 Clean only with dry cloth.
- 7 Do not block any ventilation openings. Install in accordance with the manufacturer’s instructions.
- 8 Do not install near any heat sources such as radiators, heat registers, stoves, or other apparatus (including amplifiers) that produce heat.
- 9 Do not defeat the safety purpose of the polarized or grounding-type plug. A polarized plug has two blades with one wider than the other. A grounding type plug has two blades and a third grounding prong. The wide blade or the third prong are provided for your safety. If the provided plug does not fit into your outlet, consult an electrician for replacement of the obsolete outlet.
- 10 Protect the power cord from being walked on or pinched particularly at plugs, convenience receptacles, and the point where they exit from the apparatus.
- 11 Only use attachments/accessories specified by the manufacturer.
- 12 Use only with the cart, stand, tripod, bracket, or table specified by the manufacturer, or sold with the apparatus. When a cart is used, use caution when moving the cart/apparatus combination to avoid injury from tip-over.
- 13 Unplug this apparatus during lightning storms or when unused for long periods of time.
- 14 Refer all servicing to qualified service personnel. Servicing is required when the apparatus has been damaged in any way, such as power-supply cord or plug is damaged, liquid has been spilled or objects have fallen into the apparatus, the apparatus has been exposed to rain or moisture, does not operate normally, or has been dropped



### WARNING

TO REDUCE THE RISK OF FIRE OR ELECTRIC SHOCK, DO NOT EXPOSE THIS APPARATUS TO RAIN OR MOISTURE.

(UL60065\_03)

The model number, serial number, power requirements, etc., may be found on or near the name plate, which is at the bottom of the unit.  
You should note this serial number in the space provided below and retain this manual as a permanent record of your purchase to aid identification in the event of theft.

**Model No.** \_\_\_\_\_

**Serial No.** \_\_\_\_\_

(bottom\_en\_01)

### **Information for users on collection and disposal of old equipment:**



This symbol on the products, packaging, and/or accompanying documents means that used electrical and electronic products should not be mixed with general household waste.

For proper treatment, recovery and recycling of old products, please take them to applicable collection points, in accordance with your national legislation.

By disposing of these products correctly, you will help to save valuable resources and prevent any potential negative effects on human health and the environment which could otherwise arise from inappropriate waste handling.

For more information about collection and recycling of old products, please contact your local municipality, your waste disposal service or the point of sale where you purchased the items.

#### **For business users in the European Union:**

If you wish to discard electrical and electronic equipment, please contact your dealer or supplier for further information.

#### **Information on Disposal in other Countries outside the European Union:**

This symbol is only valid in the European Union. If you wish to discard these items, please contact your local authorities or dealer and ask for the correct method of disposal.

(weee\_eu\_en\_02)

# PRECAUTIONS

## PLEASE READ CAREFULLY BEFORE PROCEEDING

Please keep this manual in a safe and handy place for future reference.

## For the AC adaptor

### **WARNING**

- This AC adaptor is designed for use with only Yamaha electronic instruments. Do not use for any other purpose.
- Indoor use only. Do not use in any wet environments.

### **CAUTION**

- When setting up, make sure that the AC outlet is easily accessible. If some trouble or malfunction occurs, immediately turn off the power switch of the instrument and disconnect the AC adaptor from the outlet. When the AC adaptor is connected to the AC outlet, keep in mind that electricity is flowing at the minimum level, even if the power switch is turned off. When you are not using the instrument for a long time, make sure to unplug the power cord from the wall AC outlet.

## For DTX-PRO

### **WARNING**

Always follow the basic precautions listed below to avoid the possibility of serious injury or even death from electrical shock, short-circuiting, damages, fire or other hazards. These precautions include, but are not limited to, the following:

#### Power supply/AC adaptor

- Do not place the power cord near heat sources such as heaters or radiators. Also, do not excessively bend or otherwise damage the cord, or place heavy objects on it.
- Only use the voltage specified as correct for the instrument. The required voltage is printed on the name plate of the instrument.
- Use the specified adaptor (page 66) only. Using the wrong adaptor can result in damage to the instrument or overheating.
- Check the electric plug periodically and remove any dirt or dust which may have accumulated on it.

#### Do not open

- This instrument contains no user-serviceable parts. Do not open the instrument or attempt to disassemble or modify the internal components in any way. If it should appear to be malfunctioning, discontinue use immediately and have it inspected by qualified Yamaha service personnel.

#### Water warning

- Do not expose the instrument to rain, use it near water or in damp or wet conditions, or place on it any containers (such as vases, bottles or glasses) containing liquids which might spill into any openings. If any liquid such as water seeps into the instrument, turn off the power immediately and unplug the power cord from the AC outlet. Then have the instrument inspected by qualified Yamaha service personnel.
- Never insert or remove an electric plug with wet hands.

#### Fire warning

- Do not put burning items, such as candles, on the unit. A burning item may fall over and cause a fire.

#### If you notice any abnormality

- When one of the following problems occur, immediately turn off the power switch and disconnect the electric plug from the outlet. Then have the device inspected by Yamaha service personnel.
  - The power cord or plug becomes frayed or damaged.
  - It emits unusual smells or smoke.
  - Some object has been dropped into the instrument.
  - There is a sudden loss of sound during use of the instrument.
  - If any cracks or breakages exist on the instrument.

## **CAUTION**

Always follow the basic precautions listed below to avoid the possibility of physical injury to you or others, or damage to the instrument or other property. These precautions include, but are not limited to, the following:

### **Power supply/AC adaptor**

- Do not connect the instrument to an electrical outlet using a multiple-connector. Doing so can result in lower sound quality, or possibly cause overheating in the outlet.
- When removing the electric plug from the instrument or an outlet, always hold the plug itself and not the cord. Pulling by the cord can damage it.
- Remove the electric plug from the outlet when the instrument is not to be used for extended periods of time, or during electrical storms.

### **Assembly**

- Assemble the instrument in the proper sequence by following the assembly instructions in this manual. Also, make sure to tighten the bolts regularly. Failure to do so might result in damage to the instrument or even injury.

### **Location**

- Do not place the instrument in an unstable position where it might accidentally fall over.
- Before moving the instrument, remove all connected cables, to prevent damage to the cables or injury to anyone who might trip over them.
- When setting up the product, make sure that the AC outlet you are using is easily accessible. If some trouble or malfunction occurs, immediately turn off the power switch and disconnect the plug from the outlet. Even when the power switch is turned off, electricity is still flowing to the product at the minimum level. When you are not using the product for a long time, make sure to unplug the power cord from the wall AC outlet.
- Use the included module holder if you are installing the DTX-PRO on the drum hardware. Also, make sure you use the wing bolts included with the module holder. Failure to do so could cause damage to the internal components or result in the instrument falling over.
- Take care when setting up cables. If anyone were to trip on a cable, the instrument could topple over and cause injury.

### **Connections**

- Before connecting the instrument to other electronic components, turn off the power for all components. Before turning the power on or off for all components, set all volume levels to minimum.
- Be sure to set the volumes of all components at their minimum levels and gradually raise the volume controls while playing the instrument to set the desired listening level.

### **Handling caution**

- Do not insert a finger or hand in any gaps on the instrument.
- Never insert or drop paper, metallic, or other objects into the gaps on the panel. This could cause physical injury to you or others, damage to the instrument or other property, or operational failure.
- Do not rest your weight on, or place heavy objects on the instrument, and do not use excessive force on the buttons, switches or connectors.
- Keep small parts out of the reach of infants. Your children may accidentally swallow them.
- Do not use the instrument/device or headphones for a long period of time at a high or uncomfortable volume level, since this can cause permanent hearing loss. If you experience any hearing loss or ringing in the ears, consult a physician.

Yamaha cannot be held responsible for damage caused by improper use or modifications to the instrument, or data that is lost or destroyed.

Always turn the power off when the instrument is not in use.

Even when the [  ] (Standby/On) switch is in standby status (display is off), electricity is still flowing to the instrument at the minimum level.

When you are not using the instrument for a long time, make sure you unplug the power cord from the wall AC outlet.

## NOTICE

To avoid the possibility of malfunction/ damage to the product, damage to data, or damage to other property, follow the notices below.

### ■ Handling

- Do not use the instrument in the vicinity of a TV, radio, stereo equipment, mobile phone, or other electric devices. Otherwise, the instrument, TV, or radio may generate noise.  
When you use the instrument along with an application on your smart device such as a smartphone or tablet, we recommend that you set Wi-Fi to on after setting "Airplane Mode" to on on that device in order to avoid noise caused by communication.
- Do not expose the instrument to excessive dust or vibrations, or extreme cold or heat (such as in direct sunlight, near a heater, or in a car during the day) to prevent the possibility of panel disfiguration, damage to the internal components or unstable operation.
- Do not place vinyl, plastic or rubber objects on the instrument, since this might discolor the panel.

### ■ Maintenance

- When cleaning the instrument, use a soft and dry/slightly damp cloth. Do not use paint thinners, solvents, alcohol, cleaning fluids, or chemical-impregnated wiping cloths.

### ■ Saving data

- System settings (Reference Manual (PDF)) are retained when the power is turned off. However, the saved data may be lost due to some failure, an operation mistake, etc. Save your important data onto USB flash drive/an external device such as a computer (Reference Manual (PDF)). Before using a USB flash drive, make sure to refer to page 21.
- Edited Kit/Click, etc. are lost when you turn off the power to the instrument. This also occurs when the power is turned off by the Auto Power Off function (page 19). Save the data to the instrument, or to USB flash drive/an external device such as a computer (Reference Manual (PDF)). However, the data saved to the instrument may be lost due to some failure, an operation mistake, etc. Save your important data onto USB flash drive/an external device such as a computer (Reference Manual (PDF)). Before using a USB flash drive, make sure to refer to page 21.
- To protect against data loss through USB flash drive damage, we recommend that you save your important data onto spare USB flash drive or an external device such as a computer as backup data.

## Information

### ■ About copyrights

- Copying of the commercially available musical data including but not limited to MIDI data and/or audio data is strictly prohibited except for your personal use.
- This product incorporates and bundles contents in which Yamaha owns copyrights or with respect to which Yamaha has license to use others' copyrights. Due to copyright laws and other relevant laws, you are NOT allowed to distribute media in which these contents are saved or recorded and remain virtually the same or very similar to those in the product.
  - \* The contents described above include a computer program, Accompaniment Style data, MIDI data, WAVE data, voice recording data, a score, score data, etc.
  - \* You are allowed to distribute medium in which your performance or music production using these contents is recorded, and the permission of Yamaha Corporation is not required in such cases.

### ■ About this manual

- The illustrations and LCD screens as shown in this manual are for instructional purposes only, and may appear somewhat different from those on your instrument.
- Windows is a registered trademark of Microsoft® Corporation in the United States and other countries.
- Apple, Mac, Macintosh, iPhone, iPad, iPod touch are trademarks of Apple Inc., registered in the U.S. and other countries.
- Android is a trademark of Google LLC.
- The company names and product names in this manual are the trademarks or registered trademarks of their respective companies.
- The names of buttons, terminals, and the like from the DTX-PRO's front, rear and top panels are enclosed in [ ] (square brackets).

### ■ Latest Firmware Version

From time to time, Yamaha may update product firmware without prior notice.

We recommend, therefore, that you check our web site (below) for the latest version and keep your DTX-PRO firmware up to date.

<https://download.yamaha.com/>

The content of this Owner's Manual applies to the newest version of the firmware as of printing. Details regarding any functions added to later versions will also be made available via the above web site.

### ■ About the Electronic Drum Pads (Pads)

Within this Owner's Manual, the optional external pads that may be connected to the DTX-PRO are referred to by model name. Please note that these model names were up-to-date as of printing of this manual.

Details regarding any subsequently released models will be made available via the following web site.

<https://download.yamaha.com/>

\* Yamaha Corporation reserves the right to modify this URL at any time without prior notice.



# MEMO

## Welcome

Thank you for purchasing this Yamaha DTX-PRO.

The DTX-PRO is a drum trigger module that you can use for playing electronic drum kits and drum pads at homes, studios or live venues.

To get the most out of your DTX-PRO, be sure to read this Owner's Manual carefully. And after reading through this manual, be sure to store it in a safe place so that you can refer back to it again as needed.

### Included Accessories

Owner's Manual (this book)

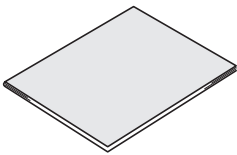

Module holder

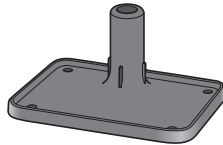

AC adaptor

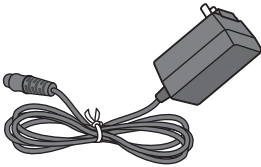

Module holder wing bolts (× 4)

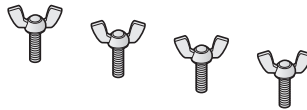

Cubase AI Download Information

### How to Attach the Module Holder

Exploded view

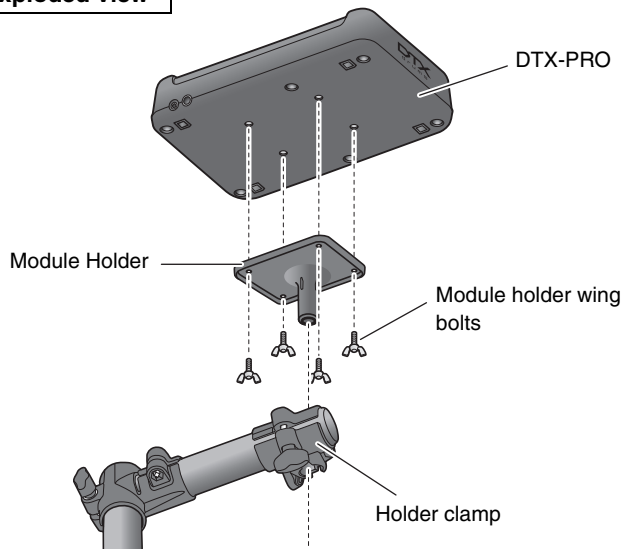

#### NOTE

The module holder is compatible with standard drum hardware (22.2-mm or 7/8-inch diameter).

# About the Manuals

The following manuals are provided for using the DTX-PRO. These manuals are intended for users of the DTX-PRO.

## Printed Manual



### Owner's Manual (this book)

#### Setup Guide

Explains how to attach and setup the DTX-PRO for producing sound.

#### Basic Guide

Describes the fundamentals needed to operate the DTX-PRO.

#### Application Guide

Describes parameter settings and other more advanced uses.

#### Reference

Describes troubleshooting techniques and contains other reference materials.

## Digital Manual (PDF)



### Reference Manual

The Reference Manual provides a description of all the functions that can be accessed by pressing the [MENU] button as well as other advanced settings that can be used with the DTX-PRO.



### Data List

This provides lists of Kit and Effect names in the DTX-PRO, and MIDI related information.



### iPhone/iPad Connection Manual Smart Device Connection Manual for Android™

Describes how to connect smartphones and tablets.

The digital format manuals listed above can be obtained from the Yamaha Downloads web page. To do so, go to the web page using the following URL, enter "DTX-PRO" in the "Model Name" field, and then click "Search."

Yamaha Downloads: <https://download.yamaha.com/>

# Features of the DTX-PRO

## ● Intuitive operation for playing your ideal drum sounds

- ✓ Includes natural drum sounds with real ambience, played by top studio drummers and recorded in renowned studios, including Real World Studios.
- ✓ Includes unique KIT MODIFIERS giving you intuitive control of Ambience, Comp, and Effects—the core elements of the drum sound creation (page 30).
- ✓ Equipped with a high-quality headphone amplifier that delivers high fidelity reproduction of all drum sounds.
- ✓ High-quality tone generator that enables natural expressive control like that of acoustic drums—with high-definition dynamics, high-performance effects processing, position sensing <sup>(\*1)</sup> on snare and ride cymbal pads, low latency and 256 polyphony.

## ● Boost your drumming skills with DTX training menus

- ✓ A sophisticated programmable metronome allows you to adjust the volume of each click beat, change the tone of the click sound, and much more (page 39).
- ✓ Enhanced versions of popular DTX training menus, such as Rhythm Gate, that are sure to take your drumming skills to the next level (page 45).
- ✓ Wide variety of training songs and drum phrases supervised by Yamaha drums master trainers will broaden your range of expression (page 45).
- ✓ You can record or playback your songs using the build-in recorder or a USB flash drive (page 42).

## ● The USB cable connection enables you to create music, make a video of your performance, and share your video over the Internet

- ✓ With iOS or Android apps such as Rec'n'Share, you can play the drums along with your favorite music or make a video of your performance to upload to social networking sites <sup>(\*2)</sup> (page 60).
- ✓ Digitally connect to smart devices for high sound quality recording and playback <sup>(\*2)</sup> (page 60).
- ✓ Includes Steinberg Cubase AI for comprehensive music production tools (page 61).

## ● Freedom to build your own drum set using separately sold drum pads

- ✓ Featuring compatibility with upper model drum pads and providing separate trigger input jacks for individual drum pads, the DTX-PRO lets you combine various drum pads in countless ways to build your perfect drum set. (pages 24 and 57)

\*1 For more information on the list of compatible drum pads, refer to the Pad Module Compatibility Table.

\*2 The DTX-PRO is a class compliant USB device. A separate cable is required for connecting to a computer or to a smartphone.

# Contents

---

<b>PRECAUTIONS</b>	<b>2</b>
--------------------	----------

---

<b>Welcome</b>	<b>6</b>
----------------	----------

---

<b>Included Accessories</b>	<b>6</b>
-----------------------------	----------

---

<b>About the Manuals</b>	<b>7</b>
Printed Manual.....	7
Digital Manual (PDF) .....	7

---

<b>Features of the DTX-PRO</b>	<b>8</b>
--------------------------------	----------

---

<b>Panel Controls and Functions</b>	<b>10</b>
Top Panel .....	10
Front Panel .....	12
Rear Panel.....	13

---

<b>Setup Guide</b>	<b>14</b>
Preparations .....	14
Installing the DTX-PRO .....	14
Turning On or Off.....	17
Changing the Overall Settings .....	19
Using a USB Flash Drive .....	21

---

<b>Basic Guide</b>	<b>23</b>
Structure of the Kit .....	23
Playing the Pads.....	24
Basic Operation of the DTX-PRO .....	29
Changing the Drum Set Sound (Building Your Own Drum Set) .	35
Using the Click (Metronome) .....	39
Creating Your Own Click (Metronome) Settings.....	40
Recording Your Performance .....	42
Practicing with the Training Feature .....	45
Details on Training Types .....	48

---

<b>Application Guide</b>	<b>57</b>
Connecting Separately Sold Add-ons and External Devices.....	57

---

<b>Reference</b>	<b>62</b>
Message List.....	62
Troubleshooting .....	64
Specifications.....	66
Index .....	67

---

# Panel Controls and Functions

## Top Panel

### KIT MODIFIER knobs

Adjust the amount of Ambience (the background sounds of the location), Comp (the punchiness or loudness of the sound), Effect (other effects assigned to the Kit)

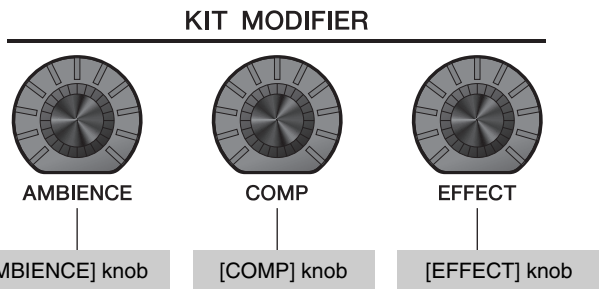

- ⇒ Structure of the Kit (page 23)
- ⇒ Adjusting (Modifying) the Sound Effects (page 30)

### [-][+] knob

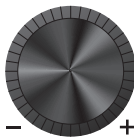

### [-] button [+] button



Increases or decrease the value(s).  
The knob is useful for changing multiple values, while the buttons are useful for changing the value in steps. In this manual, the [-][+] knob, the [-] button and the [+] button are collectively called the “[-][+] controllers” for situations where you can use either the knob or the buttons.

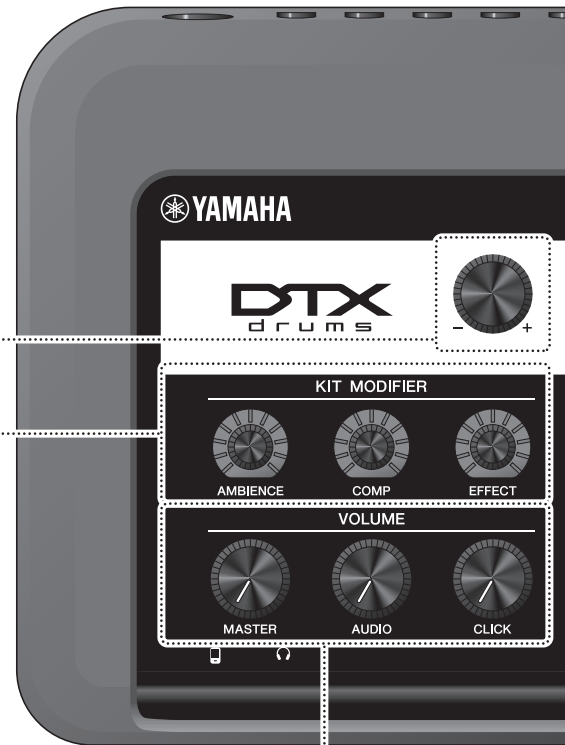

### VOLUME knobs

Adjusts the Master volume (overall sounds), audio volume (other than your performance and the click), and Click volume.

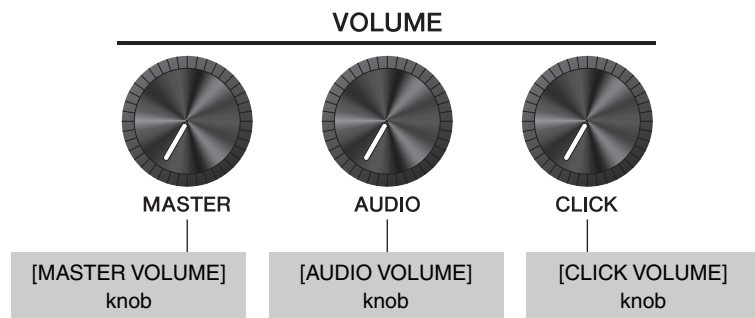

**Display**  
**Function Buttons 1–3 ([F1], [F2], [F3])**  
 Selects the functions that appear at the bottom of each screen.

**NOTICE**

**About the “E” mark:**

The **E** mark appears in the upper right of the screen when the Kit or click settings have been changed. This is to remind you that the settings have changed but have not yet been saved (Store). The mark disappears when you store the settings (page 37). When you select another screen without first storing the settings, the changes will be lost.

**How to read the KIT screen**

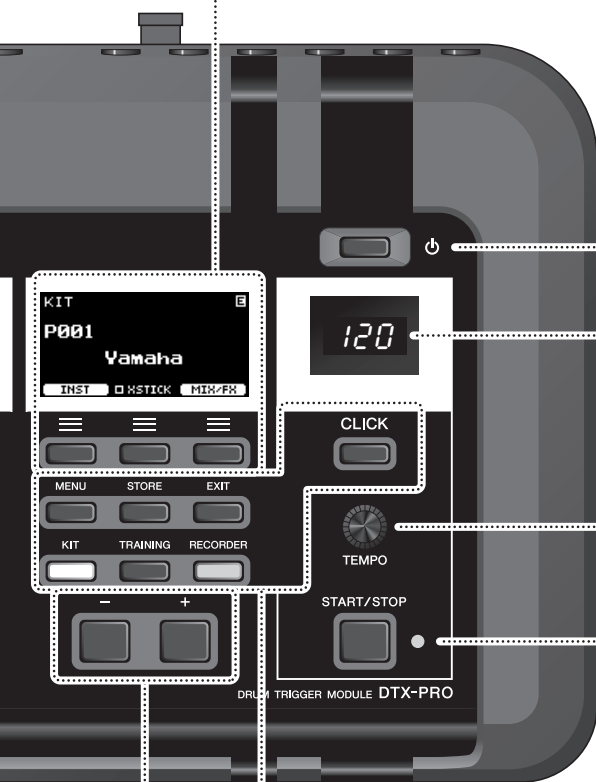
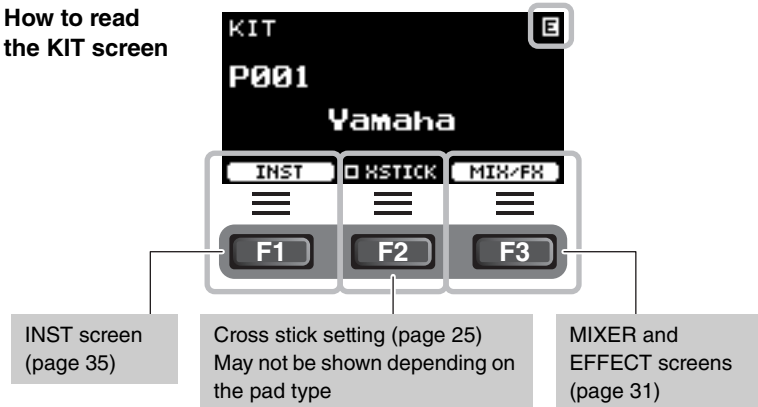

**[⏻] (Standby/On) switch (page 17)**  
 Switches the power between standby (off) and on.

**Click Tempo Display**

**[TEMPO] knob (page 39)**  
 Adjusts the tempo.

**[START/STOP] (Click Start / Stop) button**  
 Starts or stops the click (metronome). The indicator flashes in sync with the click tempo.

**Buttons for showing screens**

**MENU**  
  
**[MENU] button**  
 Accesses the advanced settings screen. For more detailed information, refer to the Reference Manual (PDF).

**KIT**  
  
**[KIT] button**  
 ⇒ KIT screen (page 29)

**TRAINING**  
  
**[TRAINING] button**  
 ⇒ TRAINING screen (page 48)

**CLICK**  
  
**[CLICK] button**  
 ⇒ CLICK (metronome) screen (page 40)

**EXIT**  
  
**[EXIT] button**  
 Cancels the action or returns to the screen one level higher. Press several times to return to the KIT screen.

**NOTE**  
 This button can also be used as a Panic Button to stop the KIT sounds (when the KIT screen is shown).

**STORE**  
  
**[STORE] button**  
 ⇒ STORE screen (page 37)  
 Stores Kit or Click settings that you have created.

**RECORDER**  
  
**[RECORDER] button**  
 ⇒ RECORDER (record and playback) screen (page 42)  
 The button flashes while recording.

# Front Panel

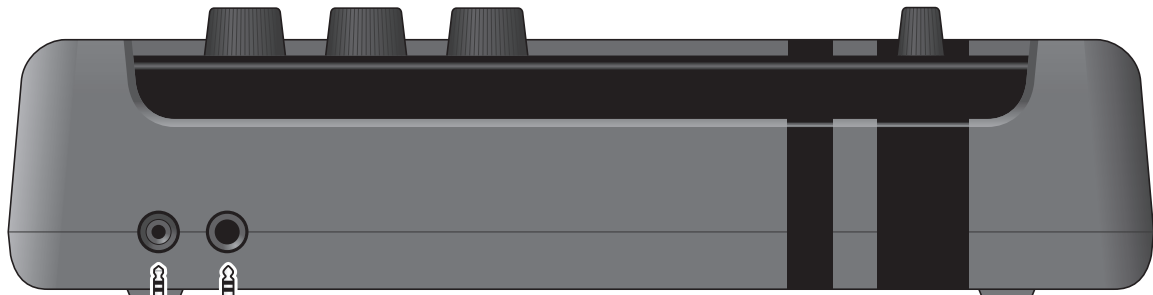

Standard stereo phone plug  
(6.3 mm)

Stereo mini plug  
(3.5 mm)



### [🎧] (Headphone) jack (page 16)

For connecting headphones. This output jack is a standard stereo phone plug (6.3 mm). Use a 3.5 mm stereo mini to (6.3 mm) stereo adaptor to connect headphones or earphones with a stereo mini plug (3.5 mm) to the [🎧] jack.

#### ⚠️ CAUTION

Do not use headphones for a long period of time at high volume. Doing so can cause loss of hearing.

A diagram showing a stereo mini plug (3.5 mm) connected to a smartphone and a portable music player. The smartphone is on the left and the music player is on the right. The plug is shown inserted into the top of the music player.

[📱] (auxiliary input) jack  
Connect to the headphone jack on a smart phone or portable music player.



# Rear Panel

**Trigger Input jacks**  
**[KICK] jack to [SNARE] jack**  
 Connects the DTX series pads.  
 To connect the pads included in your Drum Kit, refer to the Assembly Manual. These trigger input jacks also accept separately sold add-ons. For more information, see "About the Trigger Input Jacks" (page 57).

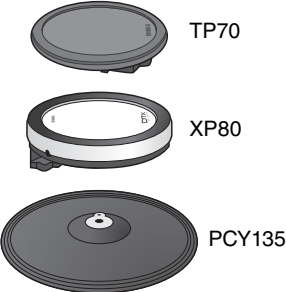

**[MIDI OUT] connector**  
 Connects a MIDI device to send MIDI messages from the DTX-PRO.

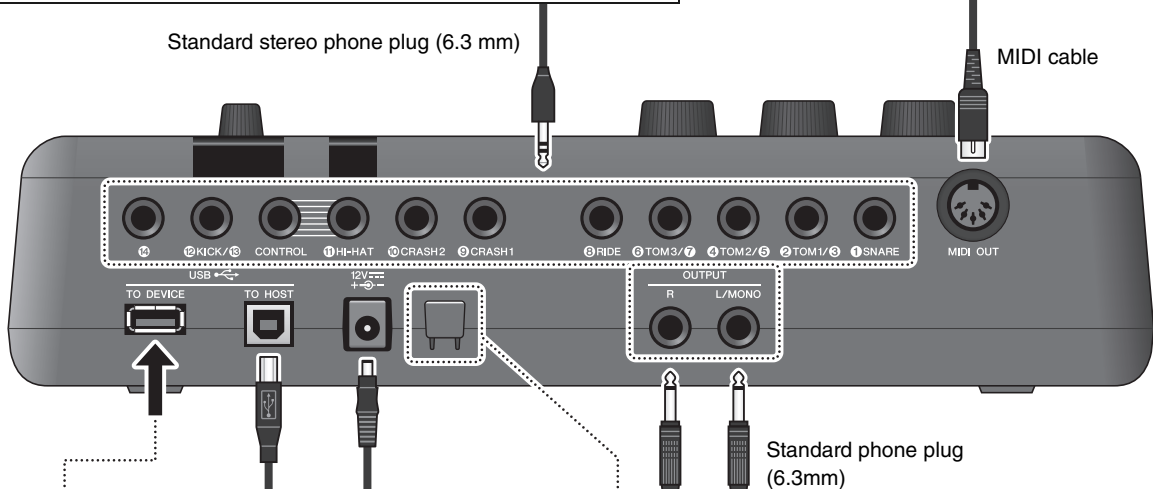
**[USB TO DEVICE] terminal (page 21)**  
 Connects a USB flash drive. Cannot be used with other USB devices.  
 ⇒ "Using a USB Flash Drive" (page 21)



**DC IN jack (page 14)**  
 Use the AC adaptor that came with the DTX-PRO.

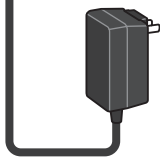

**OUTPUT [R]/[L/MONO] jacks (page 14)**  
 Connect to powered speakers or other such PA system. These jacks are standard phone type output jacks. If mono output is required, use only the [L/MONO] jack.

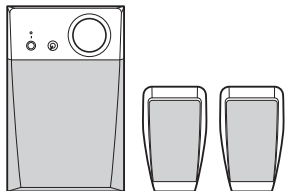

**[USB TO HOST] terminal (page 61)**  
 Connect a computer or smart device such as a smart phone or a tablet to send and receive digital signals (audio and MIDI). Additional parts are required for connecting a smart device. For more information, refer to "iPhone/iPad Connection Manual" or "Smart Device Connection Manual for Android™" (PDF).  
 Computers ⇒ "Connecting a Computer" (page 61) Reference Manual (PDF)  
 Smart devices ⇒ "Using Smart Devices" (page 60)



**Cord hook**  
 Wrap the AC adaptor cord around this hook to prevent accidental unplugging during use.

**CAUTION**  
 Excessive bending can damage the AC adaptor cord and create a fire hazard. For this reason, make sure that the power cord is not bent at an extreme angle when wrapped around the hook.

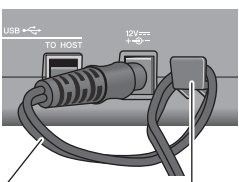

# Setup Guide

## Preparations

This provides information on setup and initial settings in preparation for playing.

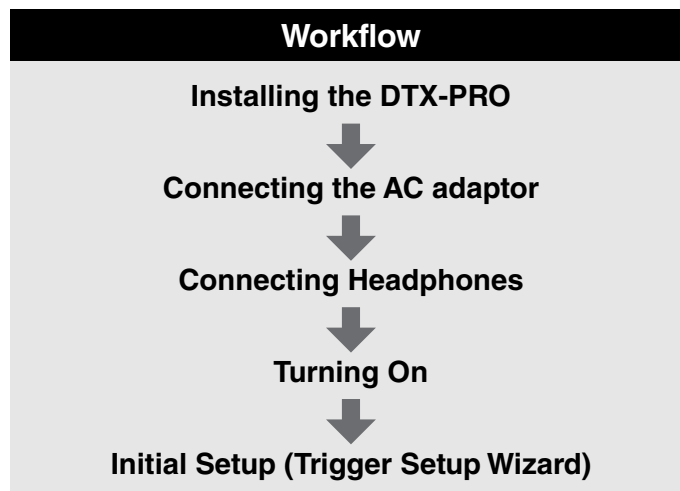

**This completes set up.**

## Installing the DTX-PRO

First, install the DTX-PRO.

There are three different ways of installation as shown below.

- Attach the DTX-PRO onto the rack of your drum kit. (For more information, refer to the Assembly Manual.)
- Use the included module holder (page 6) to attach the standard drum hardware. (See “Integrating Electronic & Acoustic Drums” on page 59.)
- Place on a flat surface

After installing the DTX-PRO, connect cables to the Pads. For more information on the connections, refer to the specific Assembly Manual of your drum kit.

## ■ Connecting the AC adaptor

### ⚠ WARNING

Only use the specified AC adaptor (page 66). Using a different AC adaptor can cause malfunction, overheating, fire, and other problems. This may void the warranty so please take careful note.

### ⚠ CAUTION

Locate the DTX-PRO close to an AC outlet. If you notice any abnormalities during operation, turn the power off immediately and unplug the AC adaptor.

1. Make sure that the power is turned off (all panel lights and the screen backlight are off).

No screen backlight

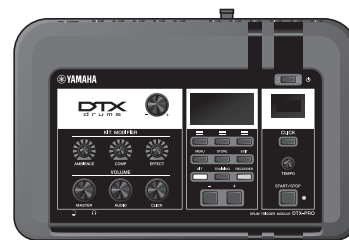

2. For removable plug type AC adaptors only: Make sure that the plug is not disconnected.

### ⚠ WARNING

- For AC adaptors with a removable plug, only use the AC adaptor with the plug attached, and keep the plug. Plugging only the plug into the power outlet can cause electric shock or fire.
- If the removable plug comes off from the AC adaptor, avoid touching the metal parts on the plug and slide the AC adaptor onto the plug until you hear it lock on to the adaptor with a click. Also, make sure you keep any foreign objects out of the plug. This can cause electrical shock, short circuit, or failure.

Slide in the direction indicated with the arrow.

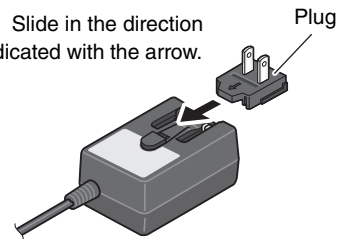

3. Connect the AC adaptor.

### ⚠ WARNING

Make sure to use the specified AC adaptor.

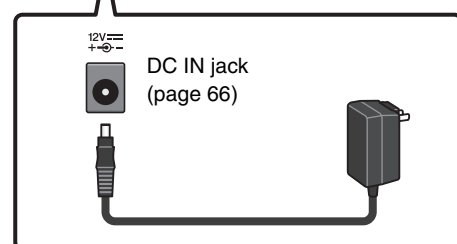
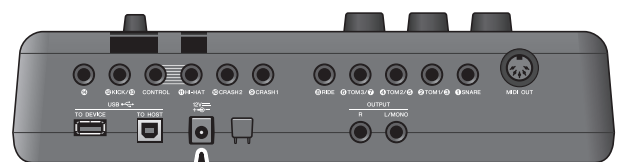

**4. Hook the AC adaptor’s cord around the cord hook to secure it in place.**

**⚠ CAUTION**

Excessive bending can damage the AC adaptor cord and create a fire hazard. Ensure, therefore, that the power cord is not bent at an extreme angle when wrapped around the hook.

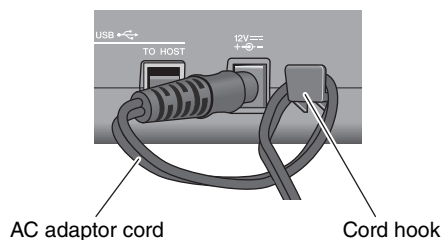

**5. Plug the AC adaptor’s AC plug into a domestic power outlet.**

**⚠ CAUTION**

Even when the [⏻] (Standby/On) switch is in standby status (display is off), electricity is still flowing to the instrument at the minimum level. When you are not using the DTX-PRO for a long period of time, make sure that you unplug the AC adaptor from the wall AC outlet.

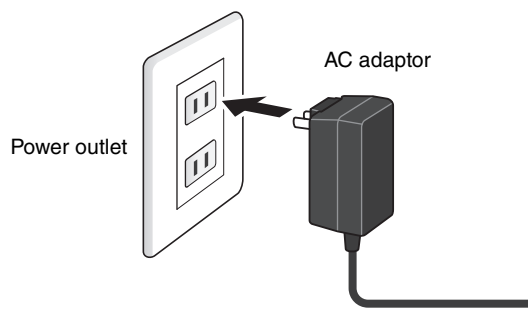

**NOTE**

When disconnecting the AC adaptor, turn the instrument and then carry out this procedure in reverse order.

**■ Connecting Headphones**

Connect the headphones to the [🎧] (headphone) jack.

**⚠ CAUTION**

Do not use headphones at high volume for an extended period of time. Doing so can cause loss of hearing.

To adjust the headphone volume, use the [MASTER VOLUME] knob.

To adjust the headphone EQ, press the [MENU] button and adjust the PhonesEQ parameter. (MENU/PhonesEQ)

For more information, refer to the Reference Manual (PDF).

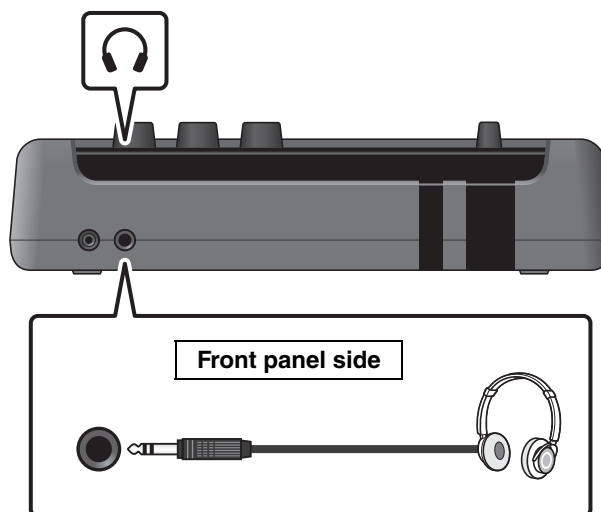

## Turning On or Off

### ■ Turning On

1. Turn the [MASTER VOLUME] knob fully counterclockwise to lower the DTX-PRO volume to its minimum.

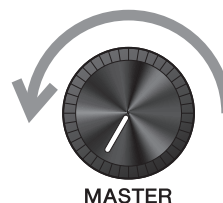

2. Press the [⏻] (Standby/On) switch.



#### Initial Setup (Trigger Setup Wizard)

When you turn on your DTX-PRO for the first time, the Initial Setup page will be displayed. On this page, you will be required to specify the following. When you specify the model number, the DTX-PRO will automatically optimize the trigger output levels for all of your pads.

1. Identify your drum kit using the [-][+] controllers and press the button below “OK” ([F3]).
2. When the confirmation screen appears, press the button below “YES” ([F1]).

When the initial setting is complete, the KIT screen appears.

#### NOTE

- Your drum kit's model number is indicated on the Assembly Manual for your drum kit.
- You can change the specified drum kit at any time after completing Initial Setup. For more information, refer to the Reference Manual (PDF). (MENU/Job/Trigger)

If the initial setup is already complete, the KIT screen appears directly after the startup screen, without showing the Trigger Setup Wizard.



\* XSTICK: May not be shown depending on the pad

3. If you are connected to a PA system:  
Turn the external speakers on.

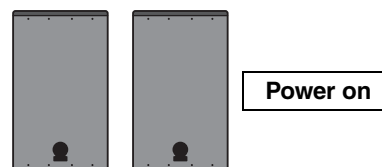

## ■ Turning Off

### NOTICE

- The DTX-PRO automatically stores settings when the power is turned off, so do not unplug the AC adaptor until the LCD screen is turned off completely.
- Unsaved Kit data will be lost, so always save (Store) data before turning the power off.

1. If you are connected to a PA system:  
Turn the external speakers off.

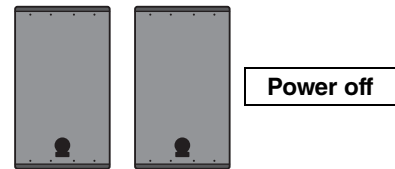

2. Turn the [MASTER VOLUME] knob fully counterclockwise to lower the volume to its minimum.

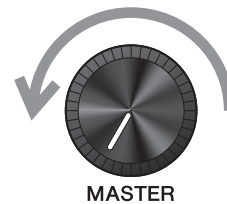

3. Hold down the [⏻] (Standby/On) switch.  
The DTX-PRO is in Standby and the display and lights are off.

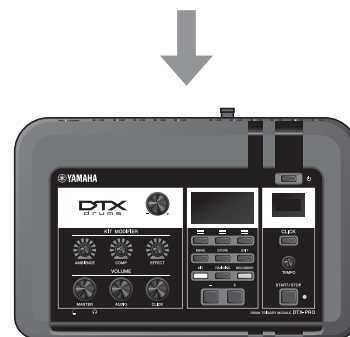

All off

## Changing the Overall Settings

### ■ Auto Power-Off

The Auto Power-Off function automatically turns off the DTX-PRO after a certain period of inactivity. The factory default is set at 30 minutes.

#### NOTICE

- Unsaved data is lost when the DTX-PRO is turned off with the Auto Power-Off function. Always store data before turning the power off.
- In certain modes of operation, the Auto Power-Off function will not turn off the DTX-PRO when the set time has elapsed. So we recommend that you always turn off the DTX-PRO manually when you are finished using it.
- If you expect the DTX-PRO to be inactive for a certain length of time while connected to external audio equipment or a PA, we recommend fully lowering the volume on the external equipment. Alternatively, you can disable the Auto Power-Off function to ensure that the DTX-PRO stays on.

#### NOTE

To set the Auto Power-Off to a time other than 30 minutes, access the setting from the [MENU] button. (MENU/Utility/General)

### ● Auto Power-Off Quick Cancel

First, make sure that the DTX-PRO is turned off. Then, while holding down the [-] button, press the [⏻] (Standby/On) button to cancel the Auto Power-Off function. The function will remain off until you set a new Auto Power-Off time.

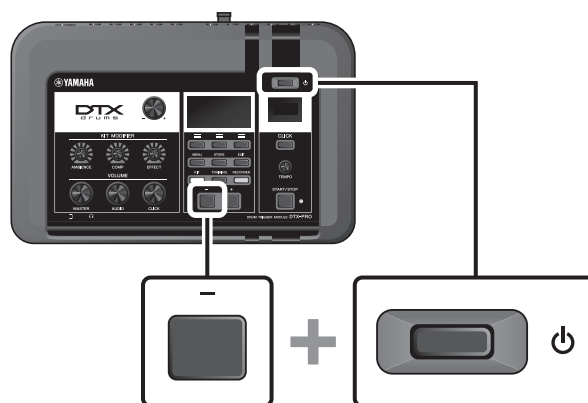

### ■ Restoring DTX-PRO Settings to the Factory Defaults (Factory Reset)

Use the Factory Reset function to restore the DTX-PRO's settings to their factory defaults, even if you have accidentally overwritten them.

#### NOTICE

A factory reset overwrites any settings you have made with the corresponding factory defaults. Save any important user-defined data to a USB flash drive before carrying out a factory reset. For more information, refer to the Reference Manual (PDF). (MENU/File)

#### ● Performing a Factory Reset

First, make sure that the DTX-PRO is turned off. Then, while holding down the [-] and [+] buttons, press the [⏻] (Standby/On) button to perform the Factory Reset function.

#### NOTE

You can also access the factory reset with the [MENU] button. (MENU/Factory Reset)

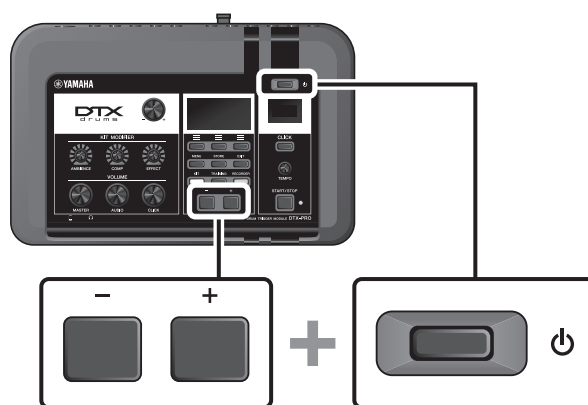



## Using a USB Flash Drive

Connect a USB flash drive to the [USB TO DEVICE] terminal on the rear panel of the DTX-PRO and record your performance directly to the USB flash drive. Also, you can save DTX-PRO settings to and load settings from a USB flash drive.

### ■ Connecting a USB Flash Drive to the DTX-PRO

#### Precautions When Using the [USB TO DEVICE] Terminal

When connecting a USB flash drive to the [USB TO DEVICE] terminal, be sure to follow the important precautions below.

**NOTE**

For more information about the handling of USB flash drives, refer to the owner's manual of your USB flash drive.

### ● Compatible USB Devices

#### USB flash drives only

Please check the URL shown below for a list of compatible USB flash drives.

<https://download.yamaha.com/>

**NOTE**

- Other USB devices such as USB hub, mouse, computer keyboard, cannot be used.
- A USB cable cannot be used to connect a USB device to the [USB TO DEVICE] terminal.

**NOTICE**

The rating of the [USB TO DEVICE] terminal is a maximum of 5 V / 500 mA. Do not connect USB devices having a rating above this, since this can cause damage to the instrument itself.

### ● Connecting a USB Flash Drive

When connecting a USB device to the [USB TO DEVICE] terminal, make sure that the connector on the DTX-PRO is appropriate and that it is connected in the proper direction.

Although USB devices 2.0 to 3.0 can be used on the DTX-PRO, the amount of time for saving to or loading from the USB device may differ depending on the type of data or the status of the instrument.

**NOTICE**

- **Avoid connecting or disconnecting the USB device during playback/recording and file management operations (such as Save, Copy, Delete, and Format), or when accessing the USB device. Failure to observe this may result in "freezing" of the operation of the instrument or corruption of the USB device and the data.**
- **When connecting then disconnecting the USB device (and vice versa), make sure to wait a few seconds between the two operations.**

#### ● Formatting the USB Flash Drive

Some USB flash drives should be formatted with this instrument before they can be used. For information on how to format the USB flash drive, refer to the Reference Manual (PDF). (MENU/File/Format)

**NOTICE**

The format operation erases any previously existing data. Make sure that the USB flash drive you are formatting does not contain any important data.

#### ● To Protect Your Data (Write Protection)

To prevent important data from being inadvertently erased, write-protect the USB flash drive. When you are saving data to the USB flash drive, make sure you disable the write-protect first.

# Basic Guide

## Structure of the Kit

A Kit is a combination of drum set sounds and the sound modifier settings that enhance the sounds, such as Ambience, Comp (Compressor) and Effects. This drum trigger module contains numerous sets of preset kits, and you can change the drum set sounds by selecting another kit or by changing the sound modifier settings.

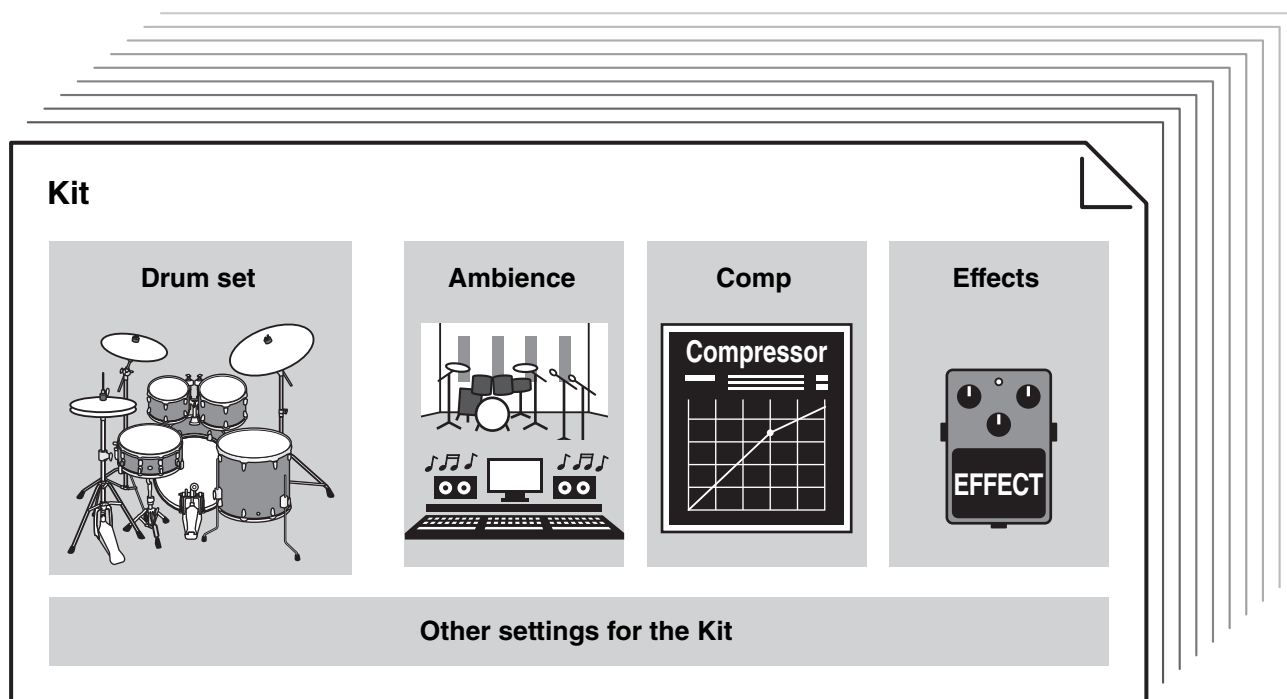

Each drum or percussion instrument in the drum set is called an instrument or “Inst,” and you can play the Inst sounds by striking drum pads.

### Example of the Instruments (Inst):

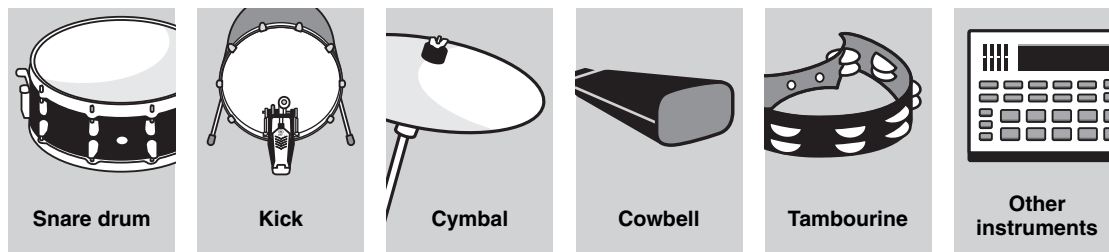

# Playing the Pads

To play the Inst sounds, strike the pads connected to the DTX-PRO.

You can play different sounds by striking different sections (or “Zones”) of the pad, depending on the number of zones available on the pad.

When position sensing is available, you can express a subtle nuance by striking different locations within a Zone.

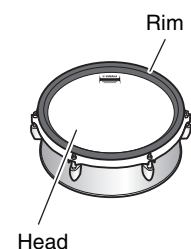
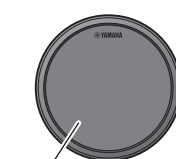
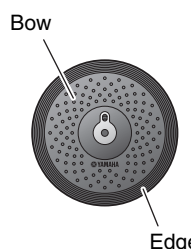
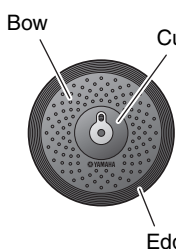
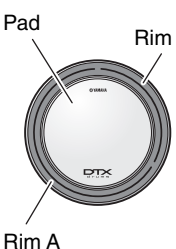
Pad Type	Multi Piezo	Single Piezo			
Number of Zones	2	1	2	3	
	Produces two different sounds (one for each zone)	Produces the same sound regardless of where the pad is struck. Also called the “monaural pads” or “1-zone pads.”	Produces two different sounds (one for each zone)	Produces three different sounds (one for each zone). Also referred to as “3-zone pads.”	
Zone					
Example	XP125SD-X	TP70	RHH135	PCY135	XP80



**NOTE**

For the information on the type of the drum sticks or beaters, refer to the Owner’s Manual for the pad.

## ■ Snare and Tom

Strike different sections of the pad in the same way you would play an acoustic snare drum or tom.

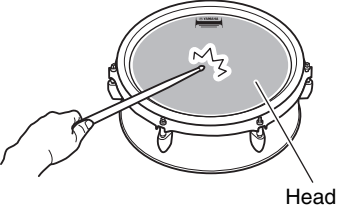
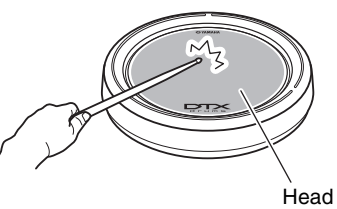
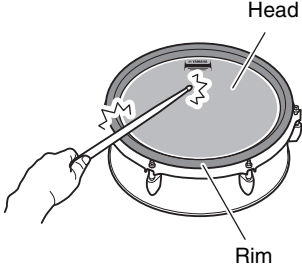
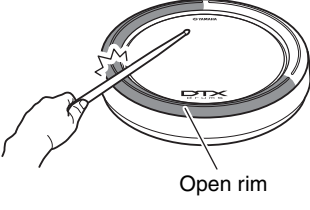
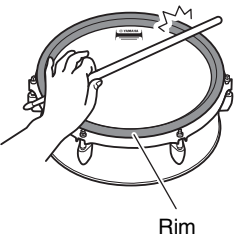
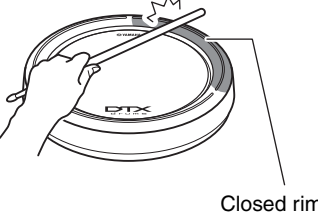
With the snare pad (the pad with position sensor connected to the ❶ SNARE jack), you can create natural tonal changes according to the location within the Zone.

Head shots		
		<p>Strike the main surface of the pad to produce a conventional head hit sound.</p> <p><b>Multi Piezo pad with position sensing:</b> With certain snare sounds, the sound changes depending on how far from the rim you strike.</p>
Open rim shots		
		<p>Strike the head and the rim at once to produce a rim shot sound.</p> <p><b>Multi piezo pads with position sensing:</b> You can use normal rim shots or shallow rim shots. Depending on the distance from the rim, the rim shot sound changes slightly.</p> <p><b>Single piezo 3-zone pads:</b> Strike the open rim.</p>
Closed rim shots, (cross sticking)		
		<p>Strike only the rim. Do not touch the head.</p> <p><b>Multi piezo pads:</b> Press the button below "XSTICK" ([F2]) in the KIT screen to switch between on (for playing the cross-stick sound) or off (for playing the open rim shot sound).</p>  <p><b>Single piezo 3-zone pads:</b> Strike the closed rim.</p>

## ■ Hi-hats

Strike different sections of the pad in the same way you would play an acoustic hi-hat cymbal.

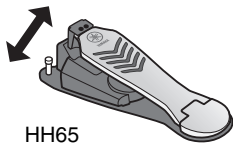
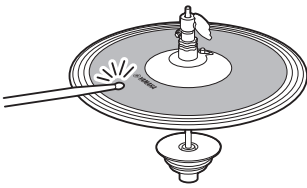
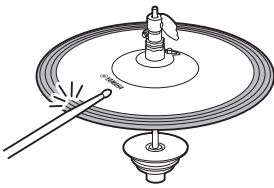
Open/Close	
 <p>HH65</p>	<ul style="list-style-type: none"><li>• You can produce an open hi-hat sound by striking the hi-hat pad with the hi-hat controller's pedal fully open.</li><li>• You can produce a closed hi-hat sound by striking the hi-hat pad with the hi-hat controller's pedal fully pressed.</li><li>• Different hi-hat sound is produced depending on the how much the pedal is opened or pressed.</li></ul>
Bow shots	
	<p>Striking the main surface of the hi-hat pad (i.e., the bow section located between the cup and edge) produces a bow shot sound.</p> <p>*1</p>
Edge shots	
	<p>Striking the front side on the outer edge of the hi-hat pad produces an edge shot sound.</p> <p>*1 *2</p> <p>Make sure that the drumstick is parallel to the pad surface when striking the pad. The edge sensor switch on the cymbal pad may not react properly when the pad is struck completely from the side.</p>
Foot-close sounds	
<p>You can press down the hi-hat controller's pedal to create a foot-close sound without having to strike the hi-hat pad.</p>	
Hi-hat splash sounds	
<p>Pressing down the hi-hat controller's pedal and then immediately releasing it produces a hi-hat splash sound.</p>	

\*1 With the hi-hat pad included in the DTX6K-X kit, the bow shots and the edge shots play the same sound.

\*2 The front side of the pad is indicated by the Yamaha logo.

## ■ Cymbals

Strike different sections of the pad in the same way you would play an acoustic cymbal. With the ride cymbal (the pad with position sensor connected to the **8**RIDE jack), you can create natural tonal changes according to the location within the Zone.

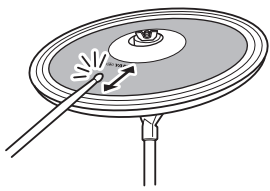
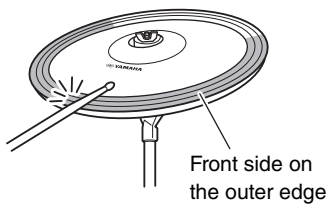
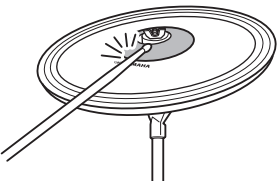
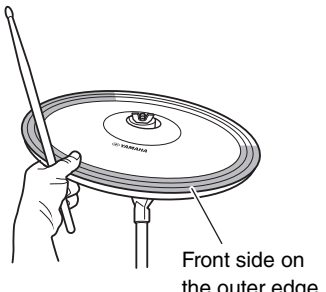
Bow shots	
	<p>Striking the main surface of the cymbal pad (i.e., the bow section located between the cup and edge) produces a bow shot sound.</p> <p>With the ride cymbal, strike the front side of the bow section near the Yamaha logo, you can create natural tonal changes according to the location within the Zone.</p> <p>*2 *3</p>
Edge shots	
	<p>Striking the front side on the outer edge of the cymbal pad produces an edge shot sound.</p> <p>*2 *3</p> <p>Make sure that the drumstick is parallel to the pad surface when striking the pad. The edge sensor switch on the cymbal pad may not react properly when the pad is struck completely from the side.</p>
Bell shots	
	<p>Striking the bell (cup) produces a bell shot sound.</p> <p>*3</p>
Choking	
	<p>Grabbing the front side on the outer edge of a cymbal pad immediately after striking it will mute the sound being produced.</p> <p>*2</p> <p><b>Crash cymbal pad included in the DTX6K-X kit:</b></p> <p>Grasp the sensor area to choke sounds.</p> <p>*4</p>

## Playing the Pads

### Muting

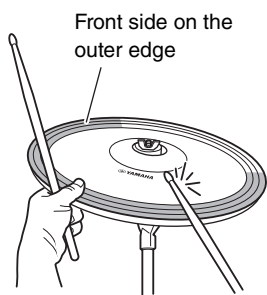

Striking the pad while holding the front side of the outer edge will produce a muted sound.

\*2

**Crash cymbal pad included in the DTX6K-X kit:**

Grasping the sensor area of the cymbal pad immediately after striking it will mute the sound being produced.

\*4

\*2 The front side of the pad is indicated by the Yamaha logo.

\*3 With the crash cymbal pad included in the DTX6K-X kit, the bow shots, the edge shots and the bell shots play the same sound.

\*4 With the crash cymbal pad included in the DTX6K-X kit, grasp the sensor area of the cymbal pad for choking and muting.

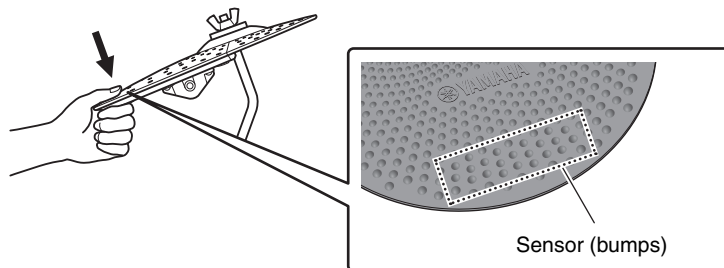



## Basic Operation of the DTX-PRO

### ■ Selecting a Kit

#### 1. Press the [KIT] button.

The KIT screen appears.

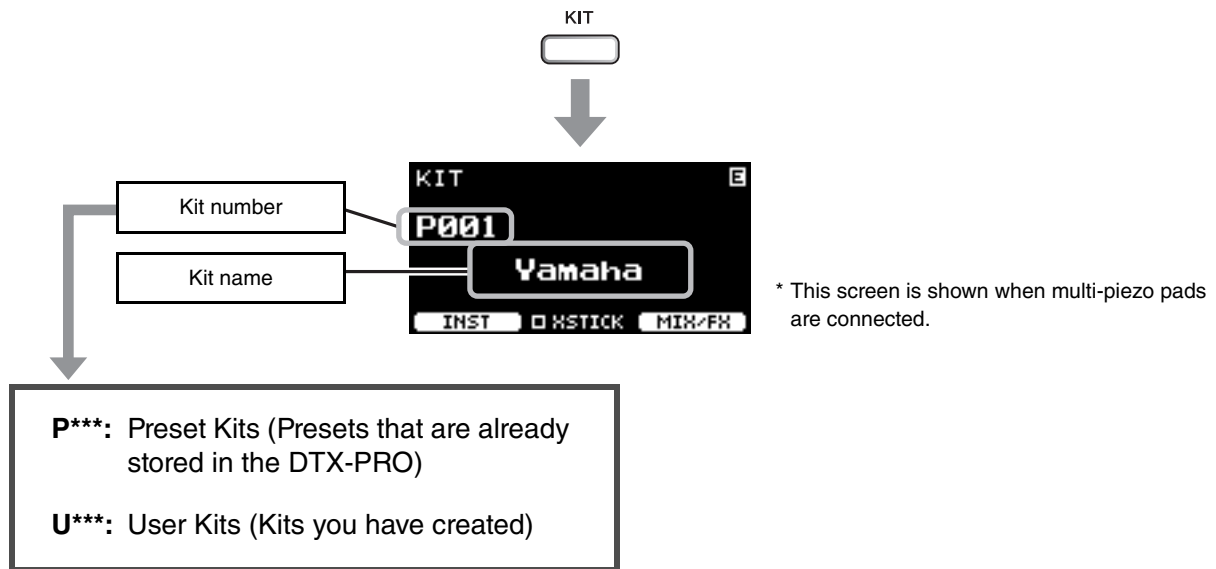

#### 2. Use the [-][+] controllers to select a kit.

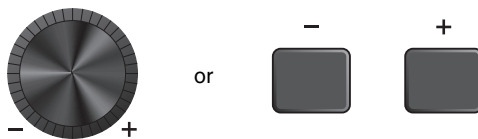

#### NOTE

If you've inadvertently selected another Kit before storing the Kit being edited, you can use the recall function to recall the edited contents. For more information, refer to the Reference Manual (PDF). (MENU/Job/Kit/Recall)

## ■ Adjusting (Modifying) the Sound Effects

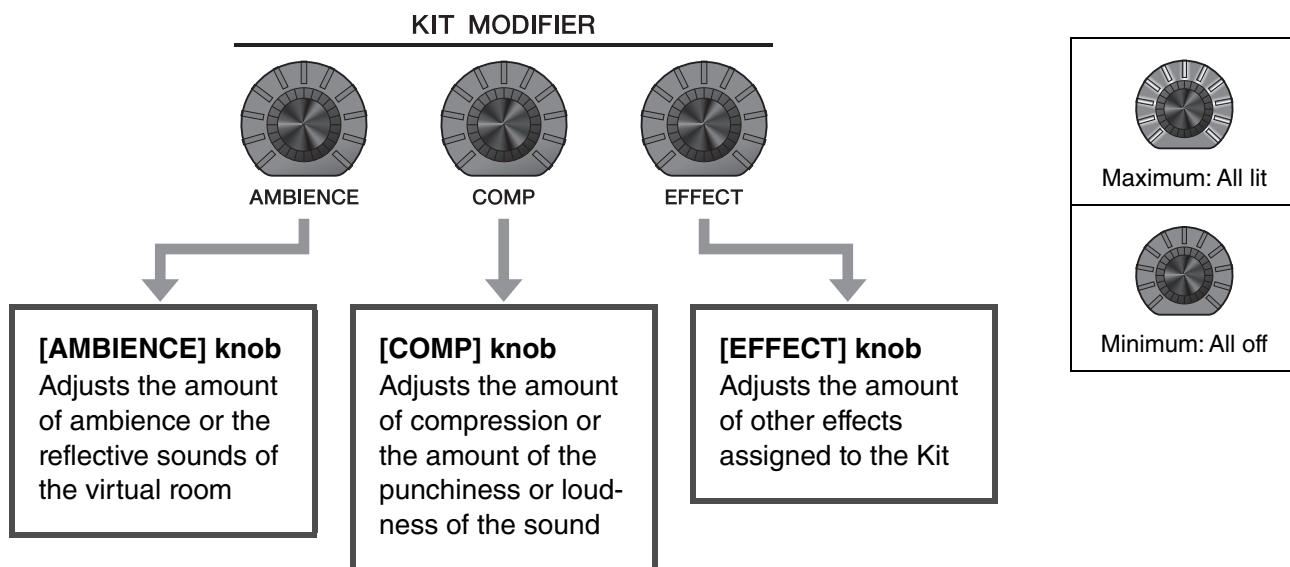

The type of the effect controlled with the [EFFECT] knob can be changed from the button below “MIX/FX” ([F3]).



For more information, see “Changing the Effect Type and Amount of Effect to Apply” (page 32).

## ■ How to Use the Mixer

Use the mixer to adjust the overall volume balance of the pads.

### NOTE

- The mixer setting is retained after switching to another Kit.
- The mixer setting is not saved as a Kit setting.

### 1. Press the button below “MIX/FX” (F3).

The MIXER screen appears.

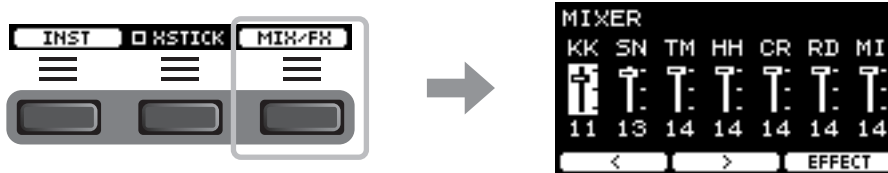

Shown on screen	KK	SN	TM	HH	CR	RD	MI
Pad	Kick	Snare	Tom1 Tom2 Tom3	Hi-Hat	Crash1 Crash2	Ride	Others
Trigger input jack the pad is con- nected to	⑫KICK	①SNARE	②TOM1 ④TOM2 ⑥TOM3	⑩HI-HAT	⑨CRASH1 ⑩CRASH2	⑧RIDE	③, ⑤, ⑦, ⑬, ⑭

To adjust the volume of each pad, press the [MENU] button to change the Inst volume settings.

To adjust the volume of each section of the pad (Zone), press the [MENU] button to change the Voice volume settings.

For more information, refer to the Reference Manual (PDF).

### 2. Use the buttons below “<” and “>” ([F1] and [F2]) to select the desired pad.

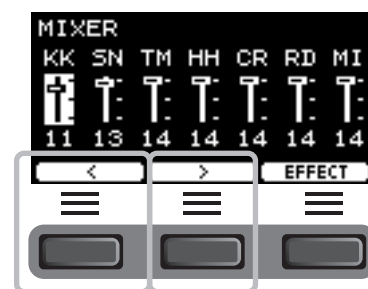

### 3. Use the [-] [+] controllers to adjust the volume.

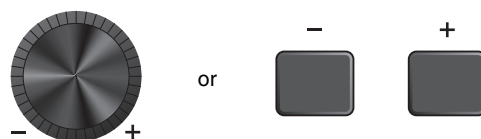

## ■ Changing the Effect Type and Amount of Effect to Apply

You can set a different effect type or change the amount of the effect that you control with the [EFFECT] knob. Master Effect (effect applied to the overall sound), Effect 1 and Effect 2 (effects whose amounts can be set independently for each Inst) are available.

### 1. Press the button below “MIX/FX” ([F3]).

MIXER screen appears.

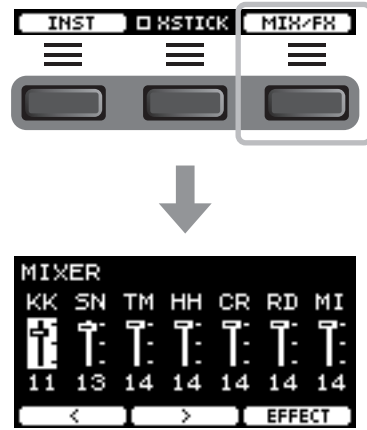

### 2. Press the button below “EFFECT” ([F3]).

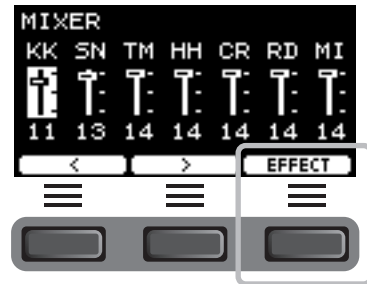

### 3. Press the button below “EFFECT M...” ([F3]) to select the effect you wish to set.

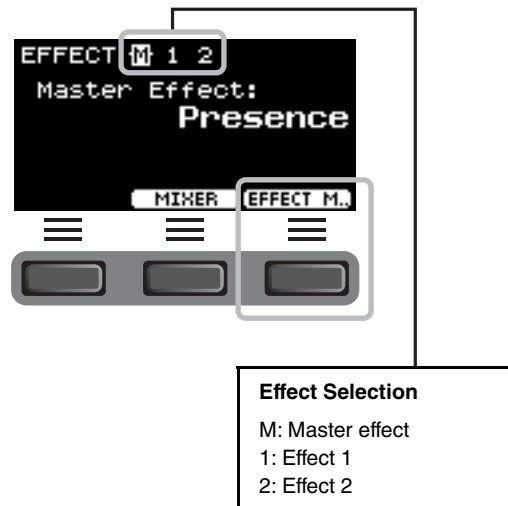

**4. Use the [-] [+] controllers to select the effect type.**

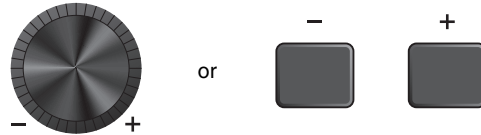

**For Effect 1 and Effect 2:**

Set the amount of effect to apply to each Inst.

- ① Strike the pad whose instrument effect you wish to change.

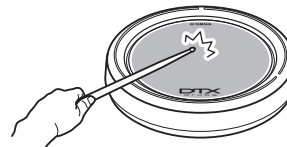

The pad name appears on the upper right corner of the screen.



- ② Press the button below “” ([F1]) to move the cursor to “InstSend.”

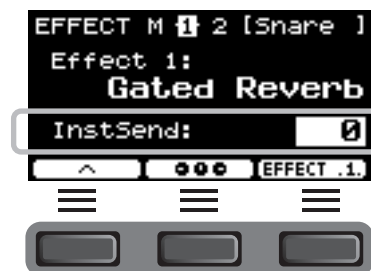

- ③ Use the [-] [+] controllers to set the amount of effect to apply.

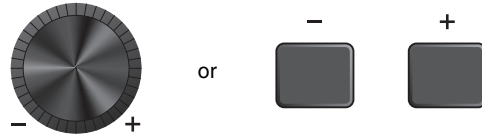

To set Effect 1 and Effect 2, you can use the graphic overview for adjusting the setting of each pad.

1. Press the button below “ ” ([F2]).

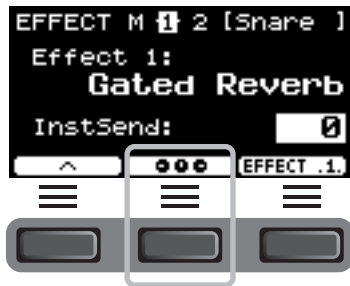

Setting screen appears.



2. Strike a pad or use the buttons below “ ” and “ ” ([F1] and [F3]) to select a pad, and use the [-] [+] controllers to set the amount of effect to apply.
3. To return to the Effect 1 or Effect 2 screens, press the button below “ ” ([F2]).

5. Turn the [EFFECT] knob and try striking the pads to check the amount of effects being applied to the sound.

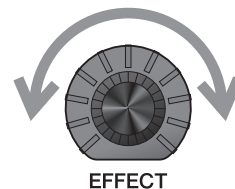

## Changing the Drum Set Sound (Building Your Own Drum Set)

With the DTX-PRO, you can build your own drum set by changing the drum set sound within the Kit.

By changing the Inst settings, you can customize the drum set sound, in the same way as you would with an acoustic drum set.

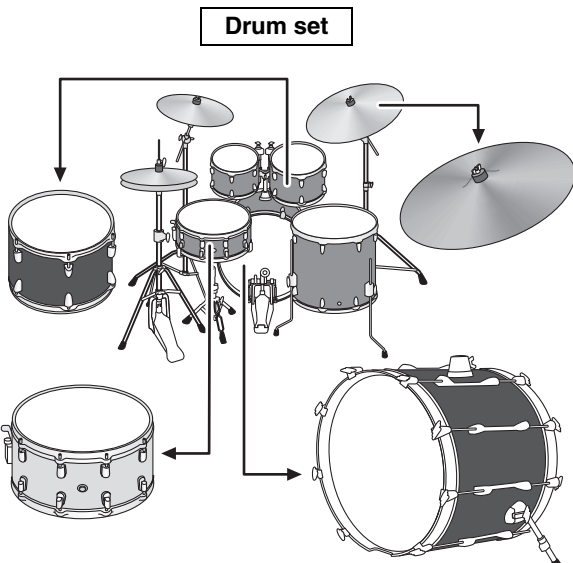
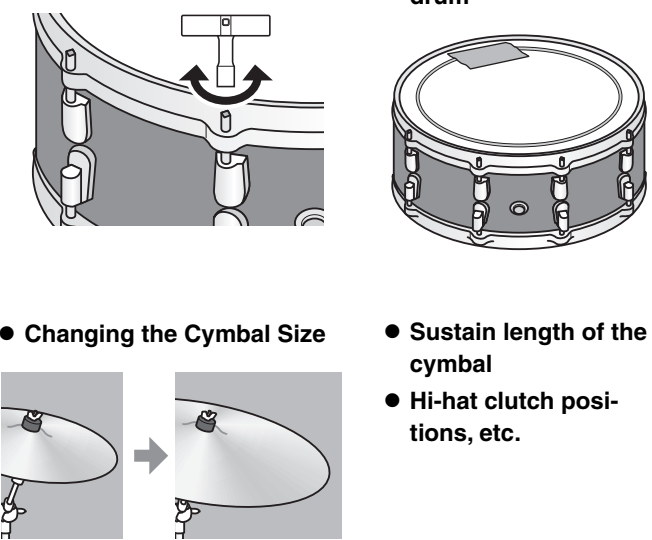
<ul style="list-style-type: none"> <li>● Replacing Instruments</li> </ul>  <p>Drum set</p>	<ul style="list-style-type: none"> <li>● Changing the Tunings</li> <li>● Muffling (muting) the drum</li> <li>● Changing the Cymbal Size</li> <li>● Sustain length of the cymbal</li> <li>● Hi-hat clutch positions, etc.</li> </ul> 
<p>→ First page of the screen (Inst Selection screen)</p>	<p>→ Second page of the screen (Inst Settings screen)</p>

If you want to make more detailed changes to the settings, press the [MENU] button. For more information, refer to the Reference Manual (PDF). (MENU/Kit Edit/Inst or MENU/Kit Edit/Voice)

### 1. Use the button below “INST” ([F1]).

Inst Selection screen appears.

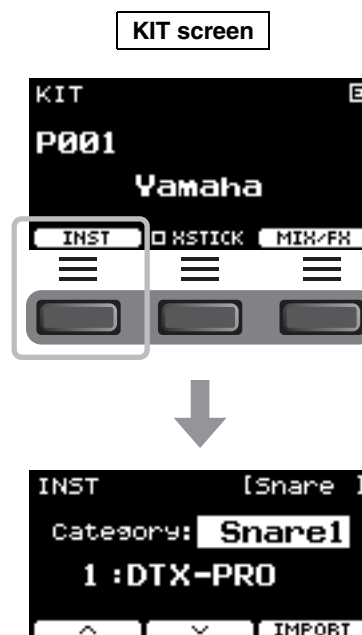

**2. Strike the drum pad for which you wish to change the settings.**

The pad name appears on the upper right corner of the screen.

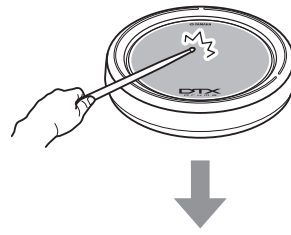

**3. Use the buttons below “▲” and “▼” ([F1] and [F2]) to select the item.**

The first page:  
The Inst Selection screen appears.

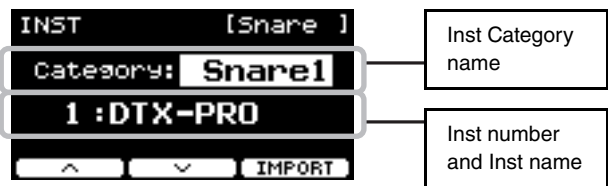

The second page:  
The Inst Setting screen appears.

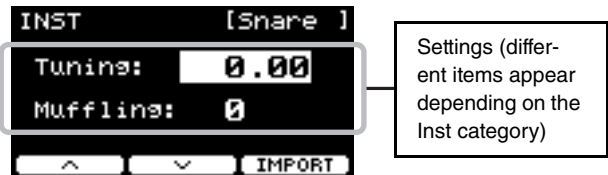

The items shown on the second page or the Inst settings screen depend on the Inst category selected in the first page or the Inst selection screen.

Inst Category	Parameter Value	Adjusting the parameter value to:
Kick1 Kick2 Snare1 Snare2 Tom1 Tom2	Tuning	Determines the tuning (pitch).
	Muffling	Simulates the effect of changing the degree of muffling (or how much the drum head is muted)
Cymbal1 Cymbal2	Size	Simulates the effect of changing the cymbal size.
	Sustain	Determines the cymbal’s sustain time (i.e., how quickly the sound decays to silence).
HiHat1 HiHat2	Size	Simulates the effect of changing the cymbal size.
	Clutch	Simulates the effect of changing the hi-hat’s clutch position. The smaller the setting, the quicker an open hi-hat sound will decay to silence.  <b>NOTE</b> Hi-Hat Clutch setting is applied to all Kits.
Perc (Percussion) Effect User	Tuning	Determines the tuning (pitch).
	Decay	Determines how quickly the sound decays to silence.

**4. Use the [-] [+] controllers to change the parameter value.**

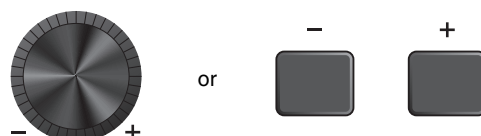



## ■ Using Imported Sounds (.wav)

You can import audio files (.wav) into the DTX-PRO to use as Inst sounds.

For more information on importing audio files and settings, refer to the Reference Manual (PDF).

For more information on using a USB flash drive, see “Using a USB Flash Drive” (page 21).

## ■ Saving a Customized Kit under a New Name

### 1. Press the [STORE] button.

The KIT STORE screen appears.

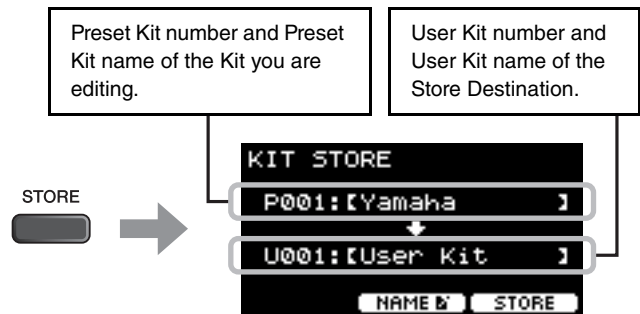

### 2. Press the button below “NAME” ([F2]) to open the NAME screen.

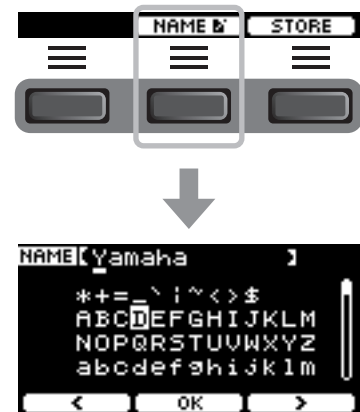

### 3. Use the buttons below “◀” and “▶” ([F1] and [F3]) to select the character position, then use the [-] [+] controllers to select a letter.

A name of up to 12 characters can be set to the Kit.

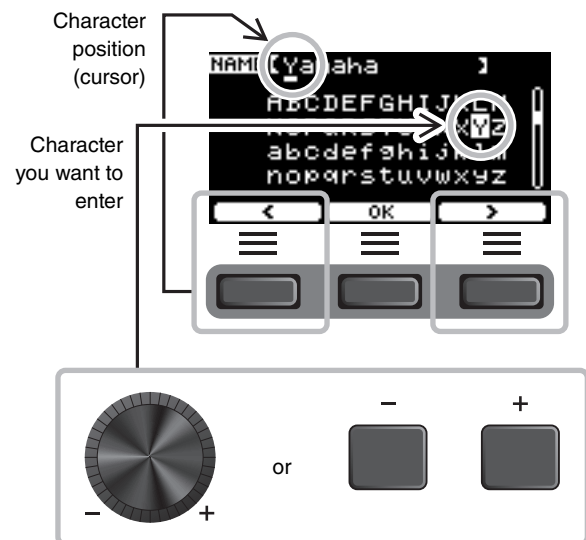

4. After entering all characters, press the button below “OK” ([F2]) and return to the STORE screen.



5. Use the [-] [+] controllers to select a User Kit Number to store your Kit to.

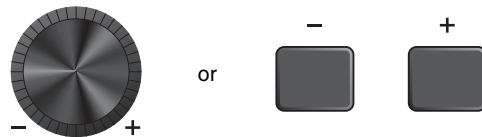

6. After confirming the new Kit Number and Kit Name, press the button below “STORE” ([F3]).

**NOTE**

You cannot save an edited Kit to a Preset Kit.

**NOTICE**

When overwriting a Kit, the current Kit settings are replaced with the new settings. Before overwriting a Kit, ensure that the Kit contains no irreplaceable settings.



“Overwrite?” appears when the selected Kit Number already contains a Kit.  
 If you want to overwrite to save the Kit, press the button below “YES” ([F1]).  
 If you do not want to overwrite, press the button below “NO” ([F3]) and return to the previous screen where you can select another Kit number.

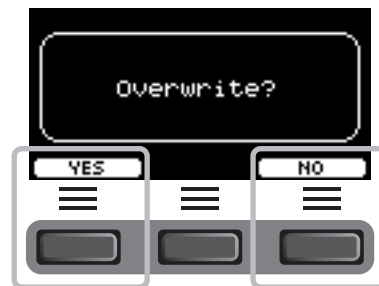

When the Kit operation is complete, the display returns to the Kit screen.

## Using the Click (Metronome)

Practicing your drumming along with the click (metronome) sounds helps you perfect your rhythms.

### ■ Starting and Stopping the Click

#### 1. Press the [START/STOP] button to start the Click.

Click sounds are played at the tempo shown in the Click Tempo display.

The lamp next to the [START/STOP] button flashes in sync with the tempo while the Click sounds.



#### 2. To stop the click, press the [START/STOP] button again.

### ■ Changing the Tempo

#### 1. Turn the [TEMPO] knob.



### ■ Setting the Click Beat Volume

#### 1. Turn the [CLICK VOLUME] knob.

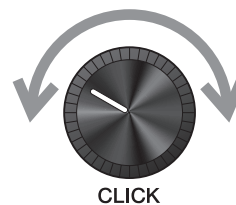

# Creating Your Own Click (Metronome) Settings

Set the Click (metronome) tempo, volume, etc.

## 1. Press the [CLICK] button.

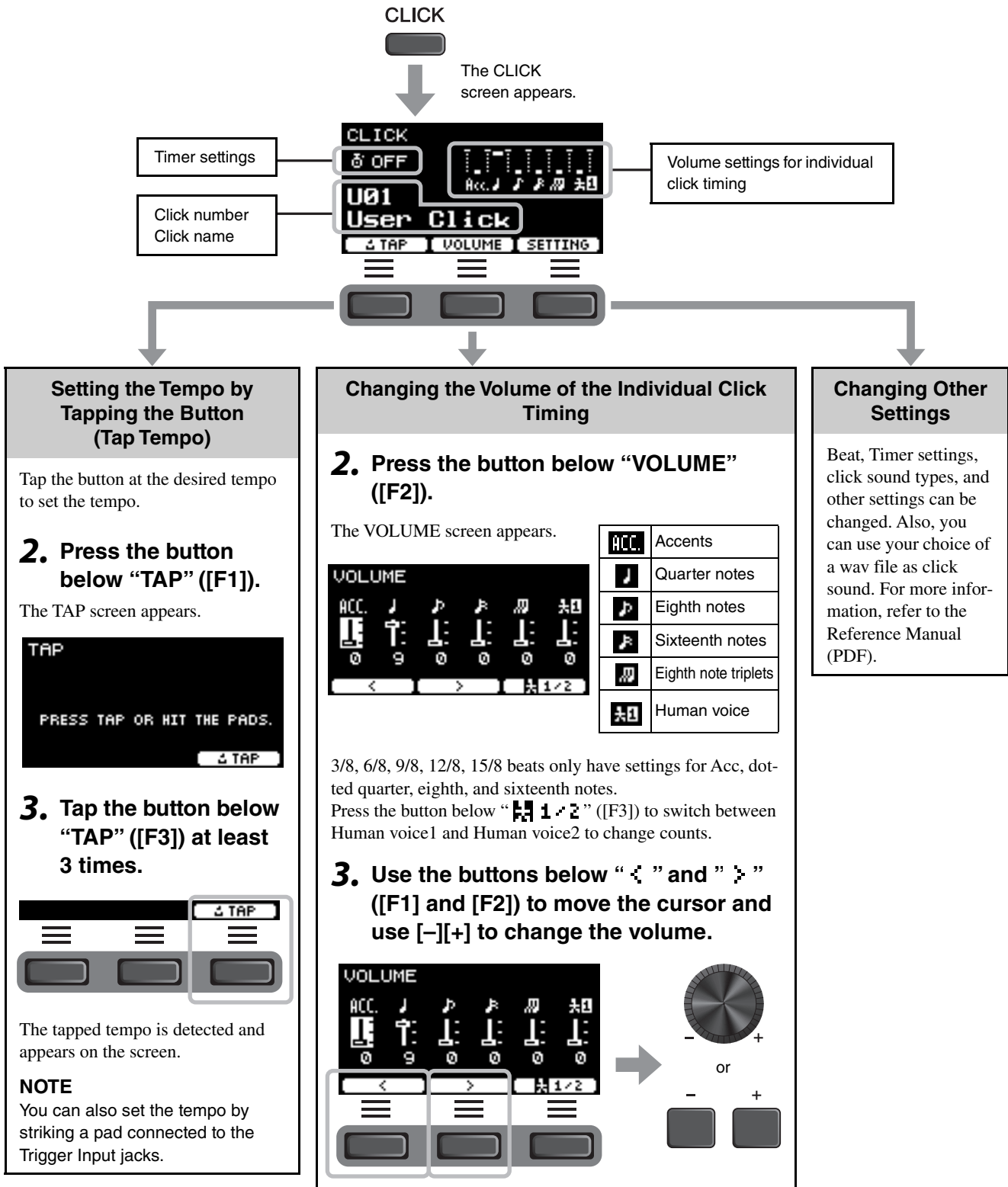

## ■ Saving the Customized Click Setting under a New Name

The Click settings you have customized can be saved in the same way as saving a kit. See “Saving a Customized Kit under a New Name” (page 37).

## ■ Using Saved Click Settings

While the CLICK screen is shown on the display, use the [-][+] controllers to select a user click.

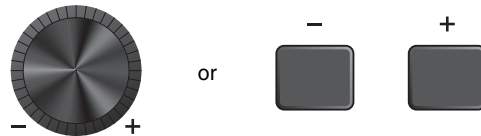

# Recording Your Performance

Use the DTX-PRO to record your performance. When a USB flash drive is connected to the DTX-PRO, audio is recorded to the USB flash drive.

You can overdub your performance onto an accompaniment song (input via the AUX IN jack) and save your performance combined with the accompaniment song as a single audio file.

## ■ Recording to the DTX-PRO (when no USB flash drive is connected to the terminal)

1. Press the [RECORDER] button.

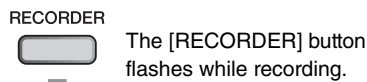

The RECORDER screen opens.



### Recording

Recording time to the DTX-PRO is about 1 minute 30 seconds.

2. Press the button below “●” ([F1]) to start recording.

While recording, the elapsed recording time (min: sec) appears.

3. Play the drums.

4. After you finish playing, press the button below “■” ([F1]) to stop recording.

### Playing Back

**NOTE**  
This is not displayed when there is no recorded song.

2. Press the “▶” button ([F2]) to start playback.

While playing back, the elapsed playback time (min: sec) appears.

3. To stop playback, press the “■” button ([F2]).

### Changing other settings

Other settings such as the playback speed or the recording source can be changed. For more information, refer to the Reference Manual (PDF).

**NOTICE**

- When your performance is already recorded on the DTX-PRO, recording again on the DTX-PRO erases the previous recording.
- Any performance recorded to the DTX-PRO will be lost when the power is turned off. If you wish to save your recordings, export the recorded data as audio files. For more information, refer to the Reference Manual (PDF). (MENU/Job/Recorder/Export Audio)

## ■ Recording to a USB Flash Drive

**1. Connect a USB flash drive to the [USB TO DEVICE] terminal on the rear panel.**

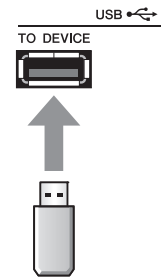

### When a USB flash drive is connected

- You can record up to 90 minutes at a time.
- A new file is created every time you record.
- Simultaneous playback and recording to overdub your performance onto the currently playing song.

**2. Press the [RECORDER] button.**

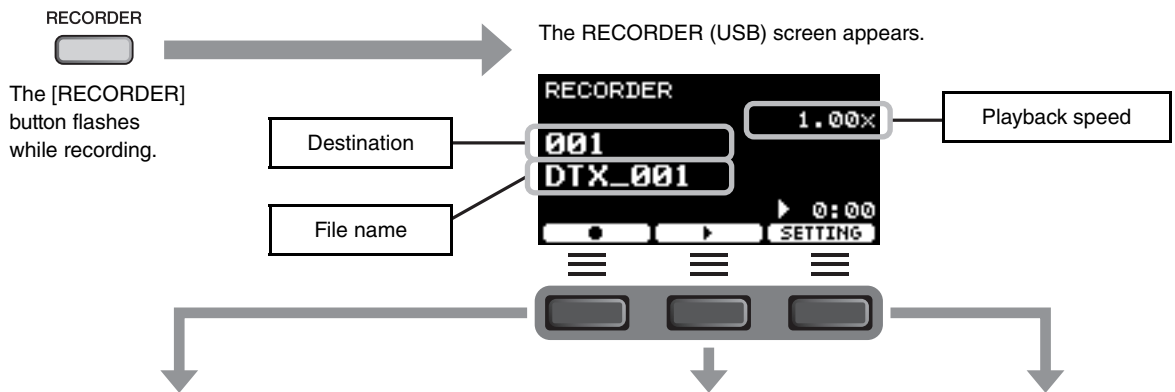

**Recording**

**3. Press the button below “●” ([F1]) to start recording.**

While recording, the elapsed recording time (min: sec) appears.

**4. Play the drums.**

**5. After you finish playing, press the button below “□” ([F1]) to stop recording.**

The RECORDER SAVE screen appears.

**6. Press the button below “SAVE” ([F3]) and save the file.**

Press the button below “CANCEL” ([F2]) if you do not want to save the file.

**NOTE**  
If you want to change the file name, press the button below “NAME” ([F1]) and enter a new name. (page 37)

**Playing Back**

**NOTE**  
This is not displayed when there is no recorded song.

**3. Use the [-][+] controllers to select a song for playback.**

**NOTE**  
Up to 1,000 songs are recognized.

**4. Press the button below “▶” ([F2]) to start playback.**

**5. Press the button below “■” ([F2]) to stop playback.**

**Changing Other Settings**

Other settings such as the playback speed or the recording source can be changed. For more information, refer to the Reference Manual (PDF).

## ■ Overdub Recording Your Performance onto an Accompaniment Song

You can also overdub your performance onto an accompaniment song that you've imported onto a USB flash drive and save your performance combined with the accompaniment song as a single audio file.

### ● Preparing an Accompaniment Song (Audio File)

#### • Importing from a Computer

Save the audio file (.wav file) from the computer to the root directory on a USB flash drive.

**Audio file requirements:** 16-bit, 44.1 kHz, stereo, wav format

**NOTE**

- Some of the audio files may not play back even when the above requirements are met.
- The DTX-PRO does not recognize the audio file if it is in a folder.

### ● Recording Yourself Playing Along with the Accompaniment Song

1. Use the [-] [+] controllers to select the accompaniment you have prepared.

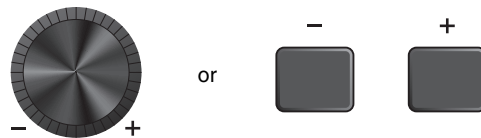

2. Press the button below “●” ([F1]) and the button below “▶” ([F2]) to start recording and playback.

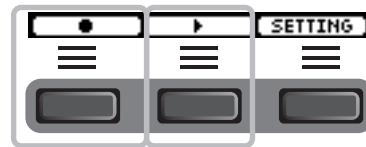

3. Play the drums.

4. After you finish playing, press the button below “□” ([F1]) to stop recording.

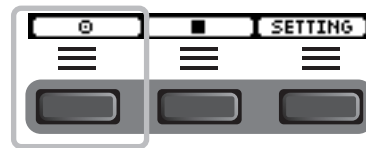

**NOTE**





Pressing the button below “■” ([F2]) stops accompaniment playback, but recording continues.



## Practicing with the Training Feature

Training is a feature you can use for effectively mastering various drumming skills. There are ten training types available on the DTX-PRO. You can use the internal training songs and click for the practice.





### ● Training Types

Learning to Play Various Songs	
 <b>1. TRAINING SONG</b>	Play along with various music categories and phrases.
 <b>2. PART MUTE</b>	Practice phrases with one instrument or one part at a time.
 <b>3. SONG PART GATE</b>	Learn to play specific parts or sections of the training song independently.
 <b>4. SONG SCORE GATE</b>	Check how well you've mastered the performance

\* With SONG PART GATE and SONG SCORE GATE, only training songs 1 to 10 can be used.

Training songs 1 to 10 are the same as the ones included in the DTX402 series. The drum scores (PDF) are available at the following site.

<https://download.yamaha.com/>

Learning to Play Rhythms Precisely	
 <b>5. RHYTHM GATE</b>	Learn to play in perfect time.
 <b>6. RHYTHM GATE TRIPLET</b>	Learn to play in perfect time with triplets.
 <b>7. DYNAMIC GATE</b>	Learn to control the strength of each hit.
 <b>8. MEASURE BREAK</b>	Learn to keep strict tempo during rests and fill-ins.
 <b>9. CHANGE UP</b>	Learn to play various phrases with rhythm changes in mid-song.

Build up Your Stamina Needed for Drumming	
 <b>10. FAST BLAST</b>	

## ■ Starting and Ending Your Training

### 1. Press the [TRAINING] button.

The TRAINING screen appears.



### 2. Use the [-][+] controllers to select a training type.

For more information on the training types, see “Training Types” (page 45).

For other settings, such as training song selection, the duration of the training (timer setting) or the difficulty level, press the button below “SETTING” ([F3]). For more information, refer to the Reference Manual (PDF).

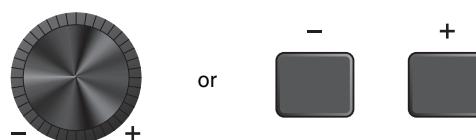

### 3. Press the button below “START” ([F1]) or “STANDBY” ([F1]).

### 4. Play the drums.

Strike the pads according to the instruction given for the selected training type.

For more information on what you can do during training, see “Details on Training Types” (page 48).

To change the tempo of the training song, turn the [TEMPO] knob.

To change the volume of the training song, turn the [AUDIO VOLUME] knob.



## 5. To end the training, press the button below “STOP” ([F1])

SONG SCORE GATE and FAST BLAST stop automatically.

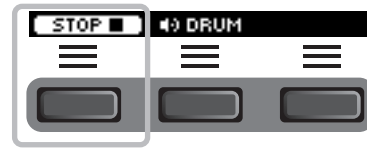

The results or the grades of your training appears after the exercise.

To restart the training, press the button below “RETRY” ([F1]), and to end the training, press the button below “OK” ([F3]).

- Training results are not shown at the end of TRAINING SONG and PART MUTE.
- With SONG PART GATE and MEASURE BREAK, the training result appears at the end before the repeat starts. Training results do not appear at the end of the exercise.

An example of the training result (for 5. RHYTHM GATE):



## 6. To close the TRAINING screen, press the [EXIT] button.

# Details on Training Types

The following ten training types are available on the DTX-PRO.



## 1. TRAINING SONG

You can play along various music categories and phrases.

### What you can do during training:

1. Use the [-][+] controllers to select a training song.
2. Play the drums along with the training song.

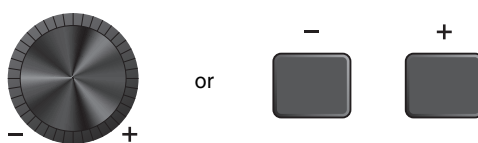

**Drum Mute**  
Mute the drum part of the training song. Press the button to turn the setting on or off.

**DRUM**  
Drum part on

**DRUM**  
Drum part off



## 2. PART MUTE

Part Mute is an exercise which you can mute any or all of the drum parts (such as snare and kick) and the backing parts (non-drum parts) from a training song. Part Mute can be useful in many ways—for example, for practicing only the snare part of the training song, or for tightening up your rhythm section skills by practicing only with a bass guitar sound.

Keep in mind that this exercise is not scored.

### What you can do during training:

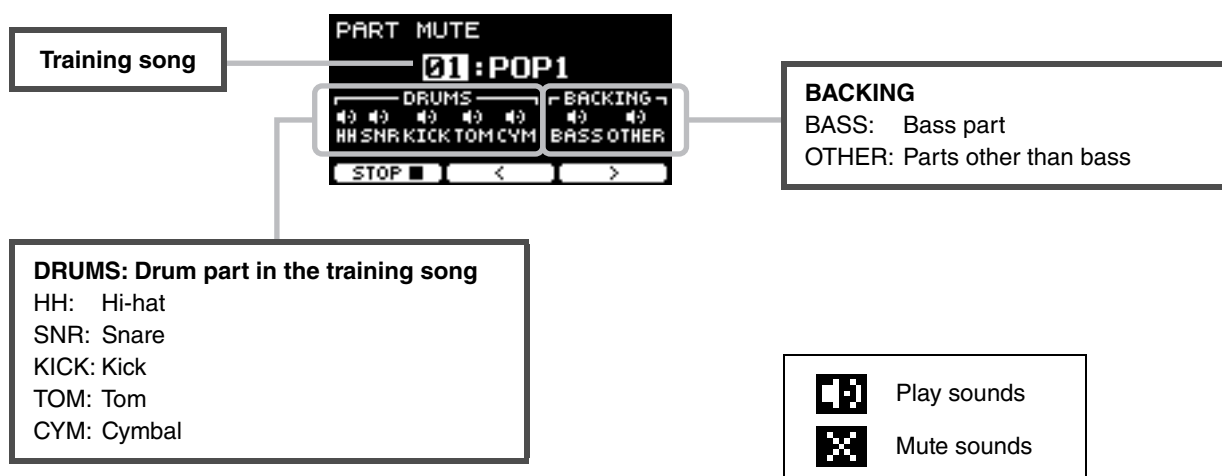

- **To select a part to mute:**

Use the buttons below “◀” and “▶” ([F2] and [F3]) to move the cursor, then use the [-] [+] controllers to select a part.



### 3. SONG PART GATE

Song Part Gate is a practical exercise for practicing one part or one section of the training song at a time. You can select a part for working intensively on a specific phrase or to work on independent hand/foot coordination, for example, in order to learn the essential part of the training song. Practice your drumming skills with other training exercises before trying Song Part Gate. Then try Song Score Gate (page 51) to play through all sections of the training song. The score (PDF) is available at the Yamaha website:

<https://download.yamaha.com/>

After accessing the Support website (and clicking on “Manual Library”), enter the appropriate model name.

#### What you can do during training:



- **To change the training song or the part to practice:**

**Use the buttons below “↶” and “↷” ([F2] and [F3]) to move the cursor, then use the [-] [+] controllers to select a training song or a section.**

Here, you can only use training songs 1 to 10.

The score is shown at the end of the phrase before it repeats.





## 4. SONG SCORE GATE

Song Score Gate is a final exercise for playing through all parts or sections of an entire training song. We recommend that you first master Song Part Gate (page 50) before working on Song Score Gate.

The score (PDF) is available at the Yamaha website:

<https://download.yamaha.com/>

After accessing the Support website (and clicking on “Manual Library”), enter the appropriate model name.

### What you can do during training:

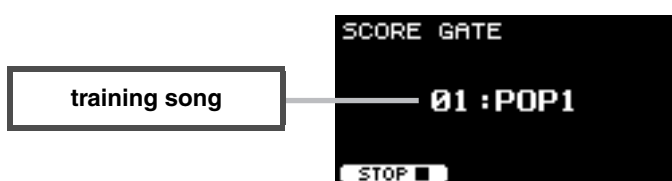

- **To change the training song**

**Use the [-] [+] controllers to select a training song.**

Here, you can only use training songs 1 to 10.

The score is shown when you reach the end of the training song.



## 5. RHYTHM GATE



## 6. RHYTHM GATE TRIPLET

Rhythm Gate is an exercise for striking pads along with the click at proper timing. Rhythm Gate is an exercise for practicing with sixteenth notes, while Rhythm Gate Triplets is for triplet notes. When you strike too early or too late, no sound is produced.

### What you can do during training:

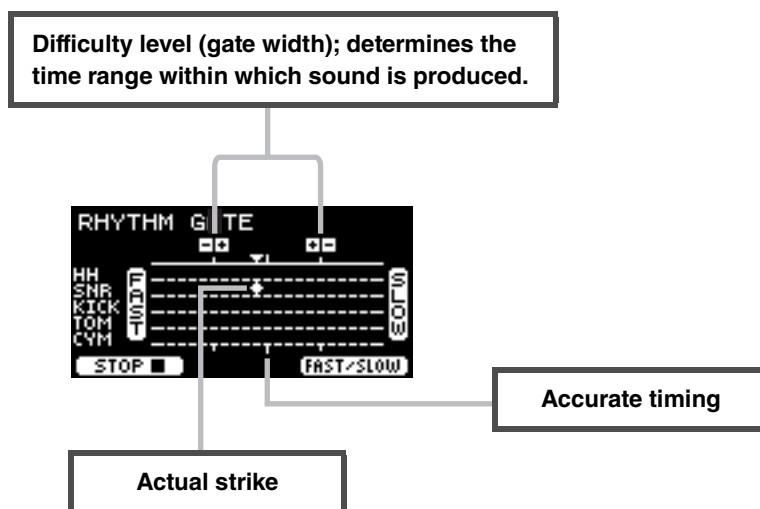

- **To change the difficulty level (gate width)**  
Set a narrower gate width to increase the difficulty level.  
**Use the [-] [+] controllers to adjust the gate width.**
- **To change the direction of the timing indicator**  
The direction of FAST to SLOW can be switched to SLOW to FAST.  
**Press the button below “FAST/SLOW” ([F3]).**





## 7. DYNAMIC GATE

Dynamic Gate is an exercise for playing pads with proper dynamics. Your aim is to control three levels: Weak, Normal and Strong. When you strike with the wrong dynamics, it will not produce any sound. How accurately you strike with the proper dynamics is evaluated at the end of the exercise. Once you master Dynamic Gate, you will be a skillful drummer at controlling dynamics depending on the situation.

### What you can do during training:

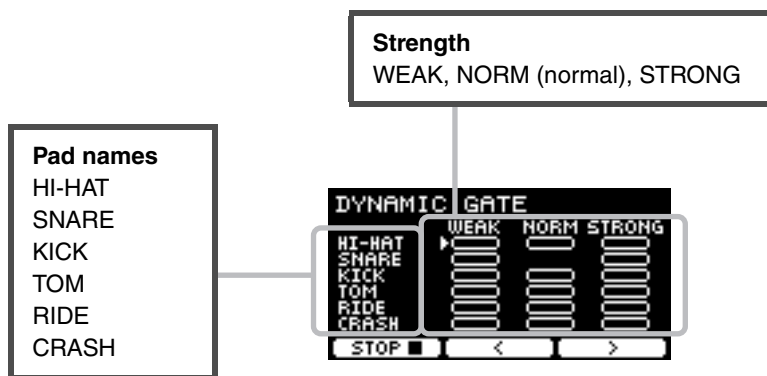

- **To set the pad sounds to be muted for specific dynamics**

For example, you can set the pad sound to be produced only when the pad is struck within the NORM range. In such case, disable WEAK and STRONG.



Use the buttons below “◀” and “▶” ([F2] and [F3]) to move the cursor (  ), then use the [-] [+] controllers to select a square to show (with sounds) or not to show (without sounds).

You can also change the cursor position by striking the pad.



## 8. MEASURE BREAK

Measure Break is an exercise for keeping a steady tempo without the metronome. How accurately you strike the first beat of the measure after the break is evaluated. Once you master Measure Break, you can keep a steady tempo even after breaks or fill ins.

### What you can do during training:

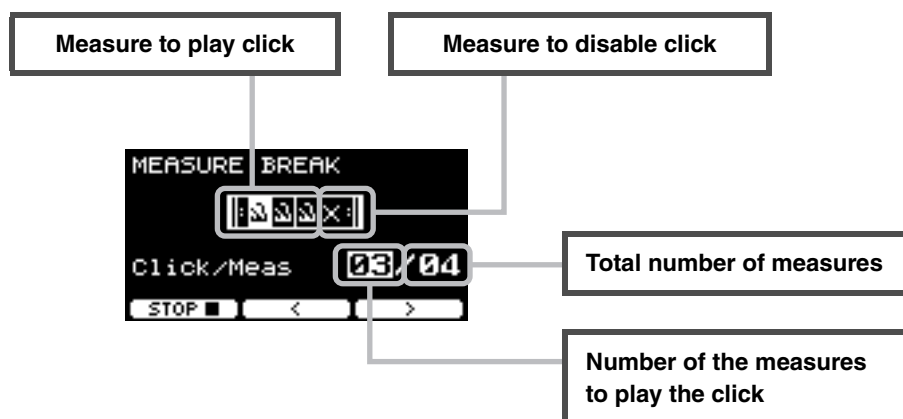

- To set a specific number of measures to play the click or the total number of measures  
Use the buttons below “◀” and “▶” ([F2] and [F3]) to move the cursor, then use [-] [+] to set the number of measures.



## 9. CHANGE UP

Change Up is an exercise for playing seven different rhythms that change every two measures. How well you maintain good timing along with the rhythms is evaluated. Try your best to keep a steady tempo—even when the rhythms change.

\*: The seven practice rhythm patterns:



What you can do during training:

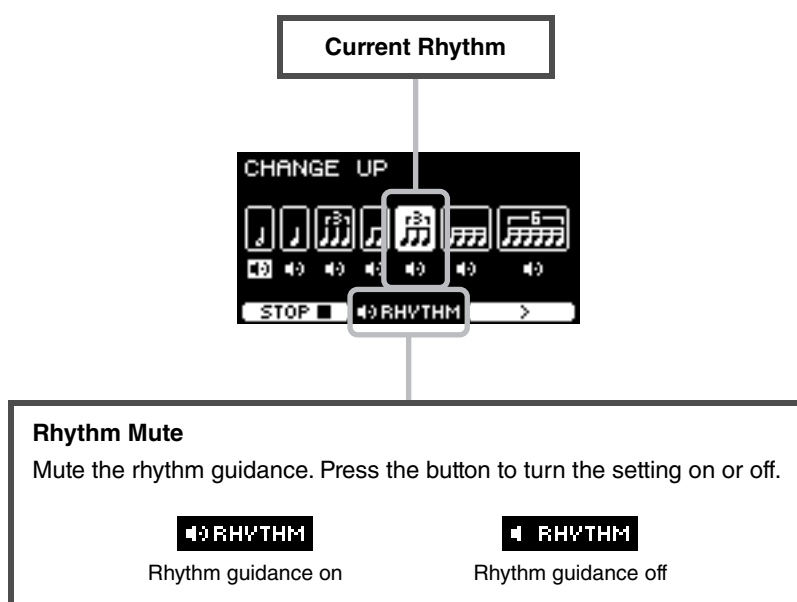

● **To select which rhythm to practice**

Use the button below “” ([F3]) to move the cursor, then use the [-] [+] controllers to change the setting.



Rhythm to practice



Rhythm to skip practicing

The number of measures can be changed from SETTING.

## 10. FAST BLAST

Fast Blast is an exercise for building up the stamina needed for drumming. Strike the pads as many times as possible within a time limit.

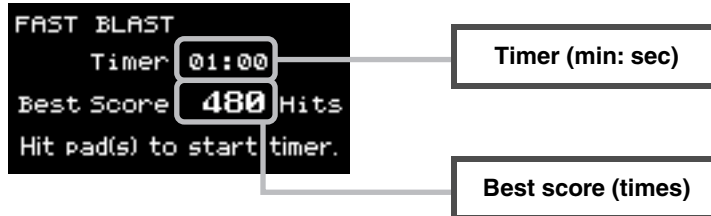

**Strike the pads as many times as possible within the time limit.**

The timer starts counting when you start striking the pads.

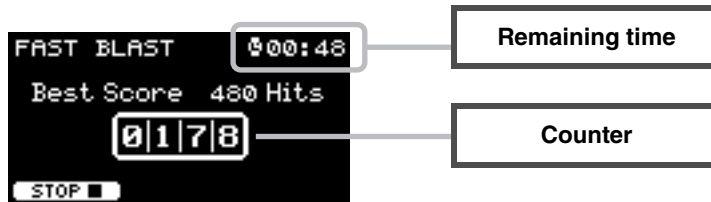

**The result appears on the screen.**

To see the count for each pad, press the button shown below “+” (F2).



# Application Guide

## Connecting Separately Sold Add-ons and External Devices

You can connect add-ons (sold separately) and external devices to the DTX-PRO to access more functions of the DTX-PRO.

### About the Trigger Input Jacks

Trigger Input jacks are used for connecting pads. The [1] SNARE to [14] jacks on the rear panel accept up to 14 pads. For more information on the types of pads you can use, see “Playing the Pads” (page 24).

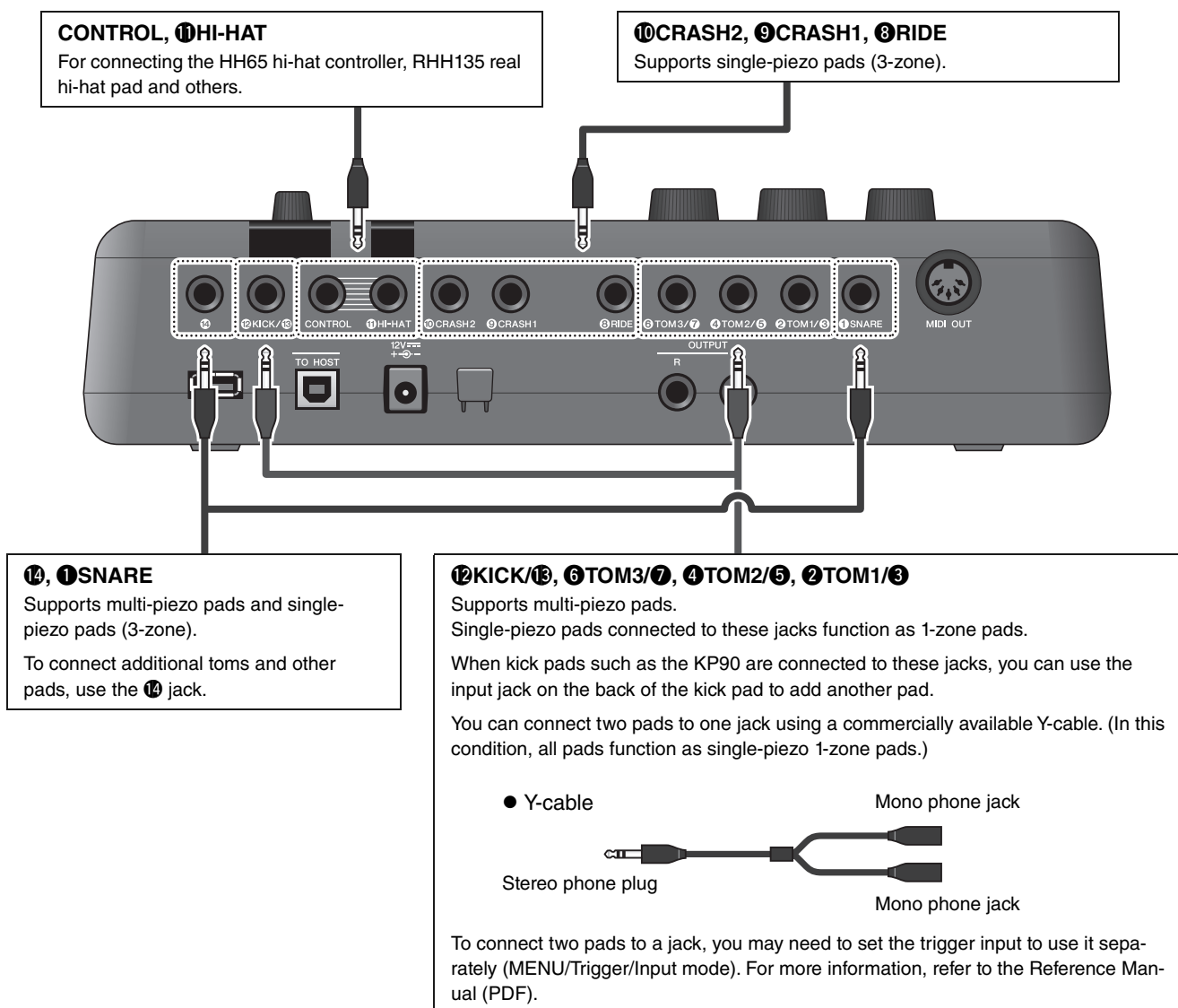

For information on the voice assignment of trigger inputs, refer to the Data List (PDF).

For more information on the separately-sold accessories that can be connected to each trigger input jack, refer to the Pad Module Compatibility table available on the website shown below.

Yamaha Downloads: <https://download.yamaha.com/>

\* Yamaha Corporation reserves the right to modify this URL at any time without prior notice.

## ■ Integrating Separately Sold Accessories

You can expand your electronic drum kit with various accessories\* for an even more enjoyable drumming experience. (\*: sold separately)

The following describes how to connect a XP125SD-M or a RHH135. For the information on the compatibility of other pads, refer to the Pad Module compatibility table (PDF). <https://download.yamaha.com/>

### ● Adding a XP125SD-M (Separately Sold)

Add a separately sold pad to the DTX-PRO to play the drum or percussion sounds or to control functions by striking the pad.

- 1. Turn off the drum trigger module.**
- 2. Attach the XP125SD-M to your drum rack.**  
Using the cable that came with the XP125SD-M, connect it to the ⑭ jack on the DTX-PRO.

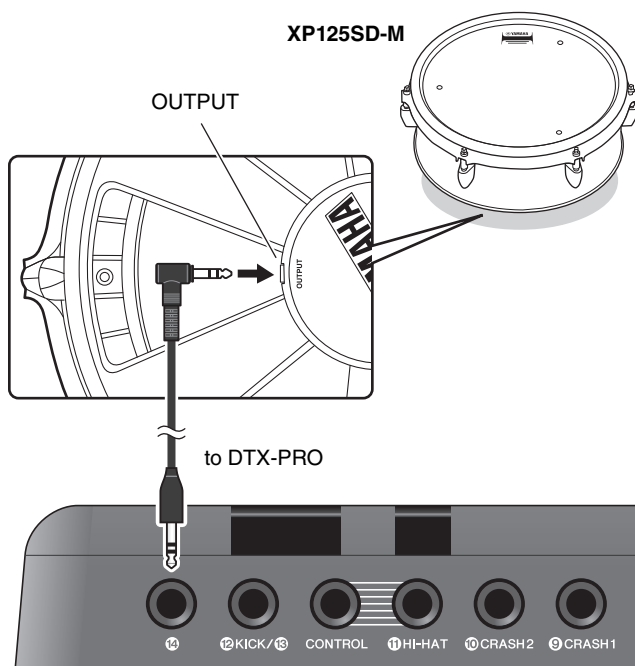

- 3. Turn on the drum trigger module.**
- 4. Choose the correct pad type for the XP125SD-M.**

For more information on how to set the pad type, refer to the Reference Manual (PDF). (MENU/TRIGGER/Pad Type)

### ● Using a RHH135 (Separately Sold) Instead of the Hi-hat Pad Included in the DTX6K-X Kit

You can use a RHH135 (separately sold) instead of the hi-hat pad included in the DTX6K-X Kit. This way, you can play different sounds by striking different sections (or “Zones”) of the pad.

- 1. Turn off the drum trigger module.**
- 2. Connect the cable included with the RHH135 from the PAD jack of the RHH135 to the ⑪ HI-HAT jack on the DTX-PRO, and from the HI-HAT jack on the RHH135 to the CONTROL jack on the DTX-PRO.**

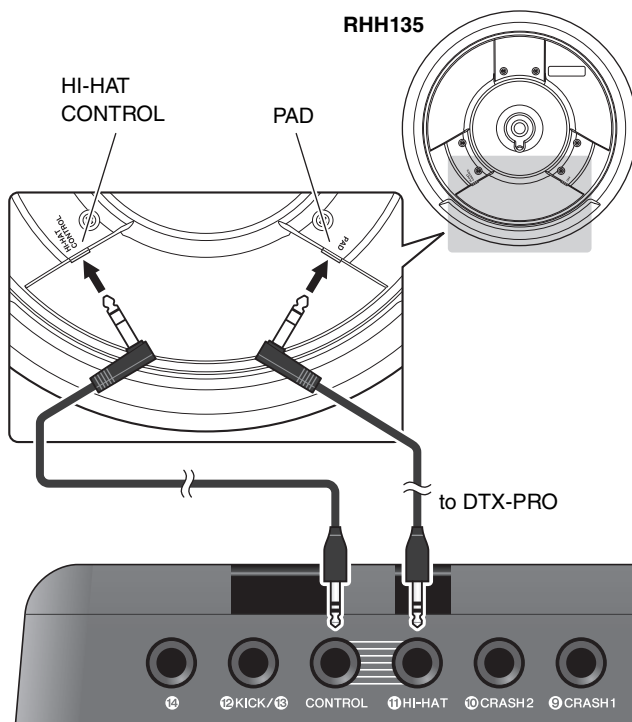

- 3. Turn on the drum trigger module.**
- 4. Choose the correct pad type for the RHH135.**

For more information on how to set the pad type, refer to the Reference Manual (PDF). (MENU/TRIGGER/Pad Type)

## ■ Integrating Electronic & Acoustic Drums

The following describes a couple of examples of how you can integrate electronic and acoustic drums.

### ● Adding Pads to an Acoustic Drum Set

By attaching a CSAT924A Cymbal Stand Attachment and a drum holder to the cymbal stand from an acoustic drum kit, you can easily add a pad such as the XP80, XP70, and TP70 to that kit. The following diagram shows a typical example of how the various components can be set up. When assembled, set the Pad Type parameter. (MENU/TRIGGER/Pad Type)

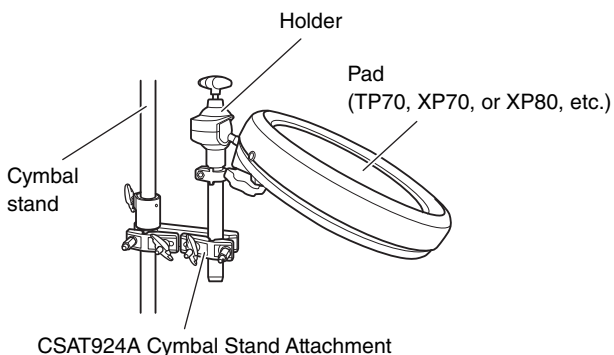

### ● Typical setup

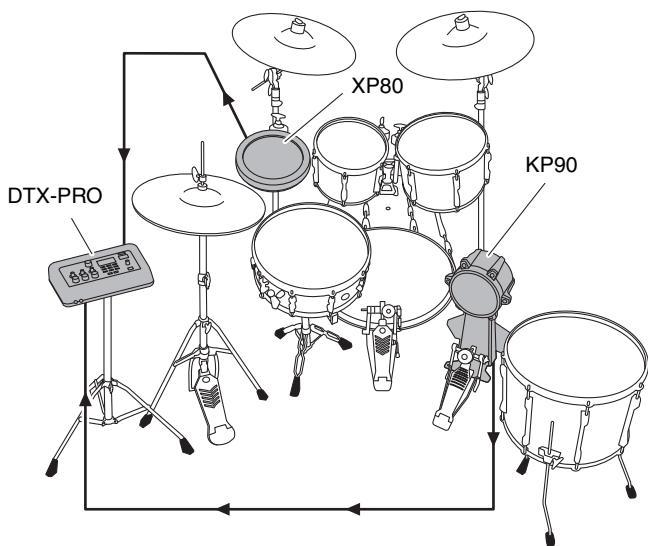

### ● Playing the DTX-PRO Using Acoustic Drums

You can attach a DT50K or DT50S Drum Trigger to the bass drum or the snare drum and connect to the [12 KICK/13] jack or the [1 SNARE] jack on the DTX-PRO to send trigger signals to your drum trigger module whenever the drum is struck. After connecting cables, set the pad type parameter. (MENU/TRIGGER/Pad Type)

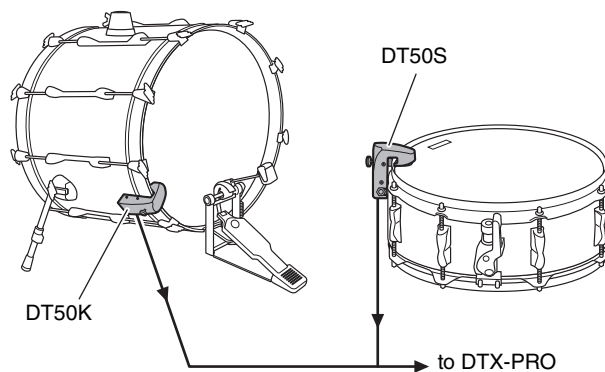

For more information on how to attach the Drum Trigger, refer to the DT50S/DT50K Owner's Manual.

### ● Typical setup (for attaching the Drum Triggers to the snare and the bass drum)

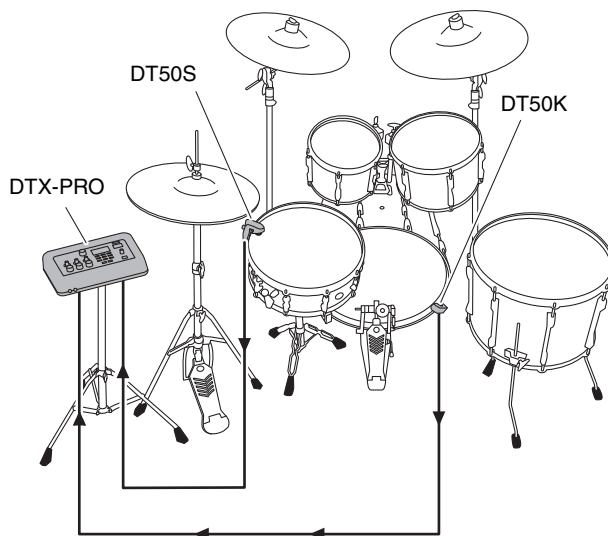

## ■ Using Smart Devices

Connecting a smart device to the [USB TO HOST] jack establishes a digital connection and allows you to:

- Record and play back high-quality audio using apps
- Practice, record (both audio and video), and share your recordings on social networks using Rec'n'Share

#### **NOTICE**

- Before connecting devices, make sure the volume levels on all external devices are set at their minimum.
- Be sure to place your smart device on a stable surface to prevent it from falling over and being damaged.

#### **NOTE**

To eliminate the risk of interference due to noise by your smart device when used in combination with the DTX-PRO, turn on the Airplane Mode and then turn on Wi-Fi.

Additional parts are required for connecting a smart device.

For more information on the connection, refer to the “iPhone/iPad Connection Manual” or “Smart Device Connection Manual for Android™.”

For details on compatible smart devices and smart device applications such as Rec'n'Share, refer to the web page below.

<https://download.yamaha.com/>



## ■ Connecting a Computer

You can connect the DTX-PRO to a computer and use DAW (Digital Audio Workstation) software such as the included Cubase AI to record your performance, edit, or mix audio.

For more information on how to connect a computer, refer to the Reference Manual (PDF). For more information on how to use the DAW software, refer to the Owner's Manual for your DAW software.

### Precautions when using the [USB TO HOST] terminal

When connecting the computer to the [USB TO HOST] terminal, make sure to observe the following points to avoid freezing the computer and corrupting or losing the data.

#### NOTICE

- Use an AB type USB cable of less than 3 meters. USB 3.0 cables cannot be used.
- Execute the following before turning the power to the instrument on/off or plugging/unplugging the USB cable to/from the [USB TO HOST] terminal.
  - Quit any open application software on the computer.
  - Make sure that data is not being transmitted from the instrument.
- While the computer is connected to the instrument, you should wait for six seconds or more between these operations: (1) when turning the power of the instrument off then on again, or (2) when alternately connecting/disconnecting the USB cable.

If the computer or the instrument freezes, restart the application software or the computer OS, or turn the power to the instrument off then on again.

# Reference

## Message List

Message	Description
Are you sure?	Confirms whether or not you want to run the specified operation.
Auto power off disabled.	Appears when the [-] button is held down while turning on the power informing the user that the Auto Power Off function is disabled.
Backup error.	Appears when writing data to the DTX-PRO has failed. If data was not be properly saved when turning off the unit, this message appears the next time the power is turned on. After the error message appears, the Factory Reset is carried out automatically.
Canceled.	Appears when the cancel operation is complete.
Can't process.	The DTX-PRO cannot process a requested operation.
Completed.	Appears when a Kit Store, File Load/Save, Job, or other function is complete.
Connecting USB device...	Appears when connecting to a USB device.
Excessive demand for USB power.	Power consumption of the USB device exceeds the specified value.
Factory Reset initializing...	Appears on startup if you did a factory reset.
File already exists.	A file with the same name already exists.
File not found.	The selected file type was not found.
Illegal file.	Appears when loading a file and the DTX-PRO cannot handle the target file or does not support the audio file.
Incompatible USB device.	Appears when an unsupported USB device is connected to the [USB TO DEVICE] terminal.
Invalid USB device.	The USB device is faulty. Format the USB device again.
Keybank full.	Appears when the total number of keybanks for waveforms have exceeded the maximum capacity.
No data.	Appears when the target data does not exist when using the Recorder or using Wav-related parameters under "Job."
No response from USB device.	There is no response from the USB device.
Now importing...	Appears when importing a .wav file.
Now loading...	Appears when loading a file.
Now processing...	Appears when running a Kit Store or Job operation. Appears during post-processing after canceling the File Load or File Save operation.
Now saving...	Appears when saving a file.
Overwrite?	Appears when saving a file to the USB device and a file with the same name already exists in the USB device. Appears when attempting to rerun the Store User Kit operation for the Kit previously saved.
Please stop recorder.	Appears when performing an operation that exits the Recorder during recorder playback or recording. Stop the Recorder and try again.

Message	Description
Recording time limit exceeded.	Appears when the recorder has reached the time limit. Recording time is about 1 minute 30 seconds with internal memory, and about 90 minutes with a USB flash drive. This message also appears when the USB flash drive has reached its capacity during recording.
Read only file.	Appears when a read-only file is selected during a file operation.
Sample is too long.	Sample is too long and cannot be loaded.
Sample is too short.	Sample is too short and cannot be loaded.
Song is too long.	The song file is too large and cannot be loaded.
USB connection terminated.	Appears if connection with the USB device was interrupted by an abnormal electric current. Disconnect the USB device and press the button below "OK".
USB device's transfer speed too slow.	Appears when the transfer speed to the USB device is insufficient. For information on devices that have been tested and confirmed to work properly with the DTX-PRO, refer to the "Compatible USB Device List" on the Yamaha web site.
USB device full.	Appears when the USB device is full and files cannot be saved on it. Use a new USB device or make space by erasing unnecessary files from the full device.
USB device not ready.	Appears if the USB device is not properly connected to the DTX-PRO.
USB device read/write error.	Appears if an error occurred while reading or writing data to the USB device.
USB device write protected.	Appears if the USB device is write-protected.
USB transmission error.	Appears if an error occurred while communicating with the USB device.
User Voice full.	Appears when the total number of User voices have exceeded the maximum capacity.
Waveform full.	Appears when the total number of waveforms have exceeded the maximum capacity.
Wave memory error.	Appears when loading data to the Wave memory has failed. When the Wave data was not saved properly, this message appears the next time the DTX-PRO is turned ON. After this message appears, the recovery process starts automatically.
Wave memory full.	Appears if the WAVE memory is full and operations such as Import, Job, or Load cannot be carried out.

## Troubleshooting

For more troubleshooting tips, refer to the Reference Manual (PDF).  
See page 7 for details on downloading this manual.

Symptom		Possible cause	Solution	Reference page
No sound Out of balance	No sound	The cable is not properly connected	<ul style="list-style-type: none"> <li>• Ensure that the DTX-PRO is properly connected to headphones or an external audio system, such as an amplifier and/or speakers.</li> <li>• Ensure that the cables you are using are in good condition.</li> </ul>	page 12 page 13 page 16
		The volume or level settings are improper  The headphone volume is not turned up  The metronome volume is not turned up	Check the following: <ul style="list-style-type: none"> <li>• Volume controllers on amplifiers and/or speakers connected to the DTX-PRO.</li> <li>• The [MASTER VOLUME] knob on the DTX-PRO front panel.</li> <li>• The sliders on the MIXER screen.</li> <li>• Volume for the metronome (Click).</li> <li>• The trigger output level of any pads with a dial allowing this to be adjusted.</li> </ul>	page 10 page 13
	Poor volume balance	Poor volume balance between each of the pads	Ensure that the sliders on the MIXER screen have been set appropriately.	page 31
		Poor volume balance between the external audio device and the DTX-PRO	<ul style="list-style-type: none"> <li>• Individually adjust the output volumes of the DTX-PRO and the external audio devices.</li> <li>• Adjust the volume with the [AUDIO VOLUME] knob.</li> </ul>	page 10 page 13
	Pads with position sensing do not produce sounds properly		<ul style="list-style-type: none"> <li>• Ensure that the Pad Type parameter has been set correctly. (For more information, refer to the "Reference Manual" (PDF).)</li> <li>• Check the orientation of the cymbal pad. When this is not set properly, the cymbal pad may not be fully functional.</li> <li>• Make sure to connect the pad to the proper jack that supports position sensing.</li> </ul>	page 24 Assembly Manual
Having difficulties during performance	Cymbal/Hi-hat sounds are too soft  The DTX-PRO produces sound but the sensitivity (i.e., volume) is too low.	Orientation of the cymbal pad is incorrect  Shaft on the Hi-hat pad is loose  The pad type parameter setting is incorrect  Slider is set at the minimum level  The level settings for the pad are improper	<ul style="list-style-type: none"> <li>• Check the orientation of the cymbal pad. When it is improper, the cymbal pad may not be fully functional.</li> <li>• The shaft on the hi-hat stand may come loose during use and cause the hi-hat pad to rotate. If this happens, the pad may not function properly. To avoid the problem, we recommend that you tighten the shaft and check the position of the hi-hat pad on a regular basis.</li> <li>• Ensure that the Pad Type parameter is set correctly. (A suitable cymbal-pad type must be selected for the pad being used. (For more information, refer to the "Reference Manual" (PDF).)</li> <li>• The trigger output level of any pads with a dial allow this to be adjusted.</li> <li>• Ensure that the slider on the MIXER screen for the pad for which a sound is not being produced is set high enough.</li> </ul>	page 24 Assembly Manual

Symptom	Possible cause	Solution	Reference page
Having difficulties during performance	Sound is produced without striking the pad Sound is produced by a pad that was not struck (Crosstalk is occurring)	For more information, refer to the “Reference Manual” (PDF).	Reference Manual (PDF)
	Cannot choke Cannot mute	Check the orientation of the cymbal pad. When the orientation of the pad is improper, the cymbal pad may not function fully.	page 24 Assembly Manual
	Foot closed hi-hat sounds cannot be played It is difficult to produce closed hi-hat sounds	<ul style="list-style-type: none"> <li>Make sure that you are fully and firmly operating the hi-hat controller.</li> <li>Ensure that the foot controller is correctly connected to the [CONTROL] jack.</li> </ul>	Assembly Manual
	Pads with position sensing do not produce sounds properly	<ul style="list-style-type: none"> <li>Ensure that the Pad Type parameter has been set correctly. (For more information, refer to the “Reference Manual” (PDF).)</li> <li>Check the orientation of the cymbal pad. When this is not set properly, the cymbal pad may not be fully functional.</li> <li>Make sure to connect the pad to the proper jack that supports position sensing.</li> </ul>	page 24 Assembly Manual
Settings	The drum module does not store its settings	<p>The drum module automatically stores its system settings whenever you turn it off using the [⏻] (Standby/On) button.</p> <ul style="list-style-type: none"> <li>Do not turn off the drum module by unplugging the AC adaptor. This will prevent it from storing the system settings.</li> <li>User settings for kits, click sets, and triggers must be stored manually.</li> </ul>	page 18 page 15 page 37
	Data cannot be saved on a USB flash drive	<p>USB 1.1 compatible flash drives cannot be used on the DTX-PRO.</p> <ul style="list-style-type: none"> <li>Ensure that the USB flash drive in question has been formatted using the DTX-PRO.</li> <li>Ensure that the USB flash drive in question has not been write-protected.</li> <li>Ensure that there is sufficient free space on the USB flash drive to save the data. (For more information, refer to the “Reference Manual” (PDF).)</li> </ul>	Reference Manual (PDF)
	Cannot send data to or from the smart device	Check the connection. For more information, refer to the iPhone/iPad Connection Manual or Smart Device Connection Manual for Android™.	page 60
	Power turns off unexpectedly	Disable the Auto Power-Off function.	page 19
	The DTX-PRO does not receive any switch or trigger signals at all I want to reset the DTX-PRO to the factory default	Use the Factory Reset to restore the settings to the factory defaults.	page 20

# Specifications

<b>Tone generator</b>	<b>Type</b>	AWM2	
	<b>Maximum polyphony</b>	256 notes	
	<b>Effect units</b>	For each Inst EQ / Comp / Transient / Insertion (*1)  For each Kit Ambience / Effect 1 / Effect 2 Master Comp / Master Effect  For overall Master EQ / Phones EQ  (*1) Insertion effects can be used only for specific Inst.	
<b>Kits</b>	<b>Quantity</b>	Preset: more than 30 kits User: 200 kits	
	<b>Number of voices</b>	Drum/Percussion: more than 400	
<b>Metronome</b>	<b>User click sets</b>	30	
	<b>Tempo</b>	30 to 300 BPM; tap tempo supported	
	<b>Time signatures</b>	1/4 to 16/4, 1/8 to 16/8, and 1/16 to 16/16	
	<b>Subdivisions</b>	Accents, quarter notes, eighth notes, sixteenth notes, and eight-note triplets	
	<b>Others</b>	Individual click volume control, wav import, timer	
<b>Training</b>	<b>Types</b>	10	
	<b>Training Songs</b>	Preset: 37 songs User: 1 song	
<b>Audio files</b>	<b>Import limit</b>	1,000 files	
	<b>Maximum loadable sample time</b>	760 seconds (44.1 kHz, 16 bit, mono) 380 seconds (44.1 kHz, 16 bit, stereo)	
	<b>Sampling format</b>	WAV	
<b>Recorder</b>	<b>Recording time</b>	<b>Internal memory</b>	maximum of 90 seconds
		<b>USB flash drive</b>	maximum of 90 minutes per file
	<b>Format</b>	<b>Record/playback</b>	WAV (44.1 kHz, 16 bit, stereo)
<b>Display</b>			Full Dot LCD (128 × 64 dot)
<b>Connectivity</b>	<b>DC IN</b>		DC IN (+12V)
	<b>Headphones</b>		Headphones (standard stereo phone jack × 1)
	<b>AUX IN</b>		AUX IN (stereo mini jack × 1)
	<b>Output</b>		OUTPUT L/MONO, R (standard phone jack, one for each)
	<b>USB</b>		USB TO DEVICE
			USB TO HOST
	<b>MIDI</b>		MIDI OUT
<b>Trigger Input</b>	<b>Jacks</b>		10 (standard stereo phone jack, not including the HI-HAT CONTROL jack)
	<b>Maximum number of pads to be connected (when Y-cable is used)</b>		14
<b>Power consumption</b>			11 W
<b>Dimensions</b>			303 (W) mm × 196 (D) mm × 66 (H) mm (11-15/16 in × 7-11/16 in × 2-5/8 in)
<b>Weight</b>			1.5 kg (3 lb 5 oz)
<b>Included Accessories</b>			AC adaptor (PA-150 or an equivalent recommended by Yamaha)*2, Owner's Manual (this document), module holder, module holder wing bolts (× 4) Cubase AI Download Information  *2 May not be included depending on your area. Check with your Yamaha dealer.

The contents of this manual apply to the latest specifications as of the publishing date. To obtain the latest manual, access the Yamaha website then download the manual file. Since specifications, equipment or separately sold accessories may not be the same in every locale, please check with your Yamaha dealer.

# Index

## Symbols

[–][+] controllers.....	10
[–][+] knob .....	10
[–] button .....	10
[+] button .....	10

## Numerics

1-zone pads.....	24
3-zone pads .....	24

## A

AC adaptor .....	15
Accompaniment .....	44
Acoustic Drums .....	59
Ambience .....	23
[AMBIENCE] knob .....	10, 30
Audio files (.wav) .....	37
[AUDIO VOLUME] knob .....	10
Auto Power-Off .....	19
[ ] (auxiliary input) jack .....	12

## B

Bell shots .....	27
Bow shots.....	26, 27

## C

Choking.....	27
Click .....	39, 40
[CLICK] button.....	11
Click Tempo Display .....	11
[CLICK VOLUME] knob.....	10
Closed rim shots .....	25
Comp.....	23
[COMP] knob .....	10, 30
Computer .....	61
Cord hook.....	13
Cross stick setting .....	11
Cross sticking.....	25
Cymbal Size .....	35

## D

DAW (Digital Audio Workstation) software .....	61
DC IN jack .....	13
Display .....	11
Drum set .....	23, 35

## E

Edge shots .....	26, 27
[EFFECT] knob .....	10, 30
Effects .....	23, 32
[EXIT] button .....	11

## F

Factory Reset.....	20
Foot-close sounds.....	26
Front Panel.....	12
Function Buttons 1–3 ([F1], [F2], [F3]).....	11

## H

Head shots.....	25
[ ] (Headphone) jack.....	12
Headphones.....	16
Hi-hat clutch positions.....	35
Hi-hat splash sounds .....	26
Hi-hats.....	26

## I

Inst .....	23, 35
INST screen .....	11

## K

Kit.....	23, 29
[KIT] button.....	11
KIT screen.....	29

## M

[MASTER VOLUME] knob .....	10
[MENU] button.....	11
Metronome .....	39, 40
[MIDI OUT] connector .....	13
Mixer .....	31
MIXER and EFFECT screens .....	11
Monaural pads .....	24
Muffling.....	35
Multi Piezo .....	24
Multi-piezo pads.....	57
Muting .....	28, 35

## O

Open rim shorts .....	25
Open/Close .....	26
OUTPUT [R]/[L/MONO] jacks .....	13

## P

Pads.....	24
Position sensing.....	24, 25, 27

## R

Rear Panel .....	13
[RECORDER] button.....	11

## S

Separately Sold Accessories.....	58
Single Piezo .....	24
Single-piezo pads .....	57
Smart Devices.....	60
Snare .....	25
[ ] (Standby/On) switch.....	11
[START/STOP] (Click Start / Stop) button.....	11
[STORE] button .....	11
Sustain length of the cymbal.....	35

## T

Tap Tempo.....	40
Tempo .....	39
[TEMPO] knob .....	11
Tom .....	25
Top Panel .....	10
Training .....	45
[TRAINING] button .....	11
Training songs.....	45
Training types.....	45
Trigger Input jacks.....	13, 57
Trigger Setup Wizard.....	17
Tunings.....	35

## U

[USB TO DEVICE] terminal.....	13, 21
[USB TO HOST] terminal.....	13, 61

## V

VOLUME knobs .....	10
--------------------	----

## W

.wav.....	37
-----------	----

## Y

Y-cable .....	57
---------------	----

## Z

Zones.....	24
------------	----

# Drums Limited Warranty

## LIMITED WARRANTY ON YAMAHA DRUMS, HARDWARE AND ACCESSORY PRODUCTS

Thank you for selecting a YAMAHA product. YAMAHA products are designed and manufactured to provide a high level of defect-free performance. Yamaha Corporation of America ("YAMAHA") is proud of the experience and craftsmanship that goes into each and every YAMAHA product. YAMAHA sells its products through a network of reputable, specially authorized dealers and is pleased to offer you, the Original Owner, the following Limited Warranty, which applies only to products that have been (1) directly purchased from YAMAHA's authorized dealers in the fifty states of the USA and District of Columbia (the "Warranted Area") and (2) used exclusively in the Warranted Area. YAMAHA suggests that you read the Limited Warranty thoroughly, and invites you to contact your authorized YAMAHA dealer or YAMAHA Customer Service if you have any questions.

### THIS WARRANTY COVERS THE LISTED PRODUCTS AGAINST DEFECTS IN MATERIALS OR WORKMANSHIP.

Warranty Term

*Duration of Warranty from Date of  
Purchase by or for the Original Owner*

*Type of Product*

<b>Acoustic Drum Shells, Finish, Drum Hardware, Freestanding Hardware, Pedals, Hardware Accessories</b>	<b>5 Years</b>
<b>Electronic Drums Modules, Pads, Accessories, Hardware, Pedals</b>	<b>1 Year</b>

**Coverage:** YAMAHA will, at its option, repair or replace the product covered by this warranty if it becomes defective, malfunctions or otherwise fails to conform with this warranty under normal use and service during the term of this warranty, without charge for labor or materials. Repairs may be performed using new or refurbished parts that meet or exceed YAMAHA specifications for new parts. If YAMAHA elects to replace the product, the replacement may be a reconditioned unit. You will be responsible for any installation or removal charges and for any initial shipping charges if the product(s) must be shipped for warranty service. However, YAMAHA will pay the return shipping charges to any destination within the USA if the repairs are covered by the warranty. This warranty does not cover (a) damage, deterioration or malfunction resulting from accident, negligence, misuse, abuse, improper installation or operation or failure to follow instructions according to the Owner's Manual for this product; any shipment of the product (claims must be presented to the carrier); repair or attempted repair by anyone other than YAMAHA or an authorized YAMAHA Service Center; (b) any unit which has been altered or on which the serial number has been defaced, modified or removed; (c) normal wear and any periodic maintenance; (d) deterioration due to perspiration, corrosive atmosphere or other external causes such as extremes in temperature or humidity; (e) damages attributable to power line surge or related electrical abnormalities, lightning damage or acts of God; or (f) RFI/EMI (Interference/noise) caused by improper grounding or the improper use of either certified or uncertified equipment, if applicable. Any evidence of alteration, erasing or forgery of proof-of-purchase documents will cause this warranty to be void. This warranty covers only the Original Owner and is not transferable.

**In Order to Obtain Warranty Service:** Warranty service will only be provided for defective products within the Warranted Area. Contact your local authorized YAMAHA dealer who will advise you of the procedures to be followed. If this is not successful, contact YAMAHA at the address, telephone number or website shown below. YAMAHA may request that you send the defective product to a local authorized YAMAHA Servicer or authorize return of the defective product to YAMAHA for repair. If you are uncertain as to whether a dealer has been authorized by YAMAHA, please contact YAMAHA's Service Department at the number shown below, or check Yamaha's website at <http://usa.yamaha.com>. Product(s) shipped for service should be packed securely and must be accompanied by a detailed explanation of the problem(s) requiring service, together with the original or a machine reproduction of the bill of sale or other dated, proof-of-purchase document describing the product, as evidence of warranty coverage. Should any product submitted for warranty service be found ineligible therefore, an estimate of repair cost will be furnished and the repair will be accomplished only if requested by you and upon receipt of payment or acceptable arrangement for payment.

**Limitation of Implied Warranties and Exclusion of Damages:** ANY IMPLIED WARRANTIES, INCLUDING WARRANTIES OF MERCHANTABILITY AND FITNESS FOR A PARTICULAR PURPOSE SHALL BE LIMITED IN DURATION TO THE APPLICABLE PERIOD OF TIME SET FORTH ABOVE. YAMAHA SHALL NOT BE RESPONSIBLE FOR INCIDENTAL OR CONSEQUENTIAL DAMAGES OR FOR DAMAGES BASED UPON INCONVENIENCE, LOSS OF USE, DAMAGE TO ANY OTHER EQUIPMENT OR OTHER ITEMS AT THE SITE OF USE OR INTERRUPTION OF PERFORMANCES OR ANY CONSEQUENCES. YAMAHA'S LIABILITY FOR ANY DEFECTIVE PRODUCT IS LIMITED TO REPAIR OR REPLACEMENT OF THE PRODUCT, AT YAMAHA'S OPTION. SOME STATES DO NOT ALLOW LIMITATIONS ON HOW LONG AN IMPLIED WARRANTY LASTS OR THE EXCLUSION OR LIMITATION OF INCIDENTAL OR CONSEQUENTIAL DAMAGES, SO THE ABOVE LIMITATION OR EXCLUSION MAY NOT APPLY TO YOU. This Warranty gives you specific legal rights, and you may also have other rights which vary from state to state. This is the only express warranty applicable to the product specified herein; Yamaha neither assumes nor authorizes anyone to assume for it any other express warranty.

If you have any questions about service received or if you need assistance in locating an authorized YAMAHA Servicer, please contact:



CUSTOMER SERVICE

Yamaha Corporation of America

6600 Orangethorpe Avenue, Buena Park, California 90620-1373

Telephone: 800-854-1569 • <http://usa.yamaha.com>

**Do not return any product to the above address without a written Return Authorization issued by YAMAHA.**



# Important Notice: Guarantee Information for customers in European Economic Area (EEA) and Switzerland

<p><b>Important Notice: Guarantee Information for customers in EEA* and Switzerland</b></p> <p>For detailed guarantee information about this Yamaha product, and Pan-EEA* and Switzerland warranty service, please either visit the website address below (Printable file is available at our website) or contact the Yamaha representative office for your country. * EEA: European Economic Area</p>	English
<p><b>Wichtiger Hinweis: Garantie-Information für Kunden in der EWR* und der Schweiz</b></p> <p>Für nähere Garantie-Information über dieses Produkt von Yamaha, sowie über den Pan-EWR*- und Schweizer Garantieservice, besuchen Sie bitte entweder die folgend angegebene Internetadresse (eine druckfähige Version befindet sich auch auf unserer Webseite), oder wenden Sie sich an den für Ihr Land zuständigen Yamaha-Vertrieb. *EWR: Europäischer Wirtschaftsraum</p>	Deutsch
<p><b>Remarque importante: informations de garantie pour les clients de l'EEE et la Suisse</b></p> <p>Pour des informations plus détaillées sur la garantie de ce produit Yamaha et sur le service de garantie applicable dans l'ensemble de l'EEE ainsi qu'en Suisse, consultez notre site Web à l'adresse ci-dessous (le fichier imprimable est disponible sur notre site Web) ou contactez directement Yamaha dans votre pays de résidence. * EEE : Espace Economique Européen</p>	Français
<p><b>Belangrijke mededeling: Garantie-informatie voor klanten in de EER* en Zwitserland</b></p> <p>Voor gedetailleerde garantie-informatie over dit Yamaha-product en de garantieservice in heel de EER* en Zwitserland, gaat u naar de onderstaande website (u vindt een afdrukbaar bestand op onze website) of neemt u contact op met de vertegenwoordiging van Yamaha in uw land. * EER: Europese Economische Ruimte</p>	Nederlands
<p><b>Aviso importante: información sobre la garantía para los clientes del EEE* y Suiza</b></p> <p>Para una información detallada sobre este producto Yamaha y sobre el soporte de garantía en la zona EEE* y Suiza, visite la dirección web que se incluye más abajo (la versión del archivo para imprimir esta disponible en nuestro sitio web) o póngase en contacto con el representante de Yamaha en su país. * EEE: Espacio Económico Europeo</p>	Español
<p><b>Avviso importante: informazioni sulla garanzia per i clienti residenti nell'EEA* e in Svizzera</b></p> <p>Per informazioni dettagliate sulla garanzia relativa a questo prodotto Yamaha e l'assistenza in garanzia nei paesi EEA* e in Svizzera, potete consultare il sito Web all'indirizzo riportato di seguito (è disponibile il file in formato stampabile) oppure contattare l'ufficio di rappresentanza locale della Yamaha. * EEA: Area Economica Europea</p>	Italiano
<p><b>Aviso importante: informações sobre as garantias para clientes da AEE* e da Suíça</b></p> <p>Para obter uma informação pormenorizada sobre este produto da Yamaha e sobre o serviço de garantia na AEE* e na Suíça, visite o site a seguir (o arquivo para impressão está disponível no nosso site) ou entre em contato com o escritório de representação da Yamaha no seu país. * AEE: Área Econômica Européia</p>	Português
<p><b>Σημαντική σημείωση: Πληροφορίες εγγύησης για τους πελάτες στον ΕΟΧ* και Ελλάδα</b></p> <p>Για λεπτομερείς πληροφορίες εγγύησης σχετικά με το παρόν προϊόν της Yamaha και την κάλυψη εγγύησης σε όλες τις χώρες του ΕΟΧ και την Ελλάδα, επισκεφτείτε την παρακάτω ιστοσελίδα (Εκτυπώσιμη μορφή είναι διαθέσιμη στην ιστοσελίδα μας) ή απευθυνθείτε στην αντιπροσωπεία της Yamaha στη χώρα σας. * ΕΟΧ: Ευρωπαϊκός Οικονομικός Χώρος</p>	Ελληνικά
<p><b>Viktigt: Garantiinformation för kunder i EES-området* och Schweiz</b></p> <p>För detaljerad information om denna Yamahaprodukt samt garantiservice i hela EES-området* och Schweiz kan du antingen besöka nedanstående webbadress (en utskriftsvänlig fil finns på webbplatsen) eller kontakta Yamahas officiella representant i ditt land. * EES: Europeiska Ekonomiska Samarbetsområdet</p>	Svenska
<p><b>Viktig merknad: Garantiinformasjon for kunder i EØS* og Sveits</b></p> <p>Detaljert garantiinformasjon om dette Yamaha-produktet og garantiservice for hele EØS-området* og Sveits kan fås enten ved å besøke nettstedene nedenfor (utskriftsversjon finnes på våre nettsider) eller kontakte Yamahas kontoret i landet der du bor. *EØS: Det europeiske økonomiske samarbeidsområdet</p>	Norsk
<p><b>Vigtig oplysning: Garantioplysninger til kunder i EØO* og Schweiz</b></p> <p>De kan finde detaljerede garantioplysninger om dette Yamaha-produkt og den fælles garantiserviceordning for EØO* (og Schweiz) ved at besøge det websted, der er angivet nedenfor (der findes en fil, som kan udskrives, på vores websted), eller ved at kontakte Yamahas nationale repræsentationskontor i det land, hvor De bor. * EØO: Det Europæiske Økonomiske Område</p>	Dansk
<p><b>Tärkeä ilmoitus: Takuutiedot Euroopan talousalueen (ETA)* ja Sveitsin asiakkaille</b></p> <p>Tämän Yamaha-tuotteen sekä ETA-alueen ja Sveitsin takuuta koskevat yksityiskohtaiset tiedot saatte alla olevasta nettiosoitteesta. (Tulostettava tiedosto saatavissa sivustollamme.) Voitte myös ottaa yhteyttä paikalliseen Yamaha-edustajaan. *ETA: Euroopan talousalue</p>	Suomi
<p><b>Ważne: Warunki gwarancyjne obowiązujące w EOG* i Szwajcarii</b></p> <p>Aby dowiedzieć się więcej na temat warunków gwarancyjnych tego produktu firmy Yamaha i serwisu gwarancyjnego w całym EOG* i Szwajcarii, należy odwiedzić wskazaną poniżej stronę internetową (Plik gotowy do wydruku znajduje się na naszej stronie internetowej) lub skontaktować się z przedstawicielstwem firmy Yamaha w swoim kraju. * EOG — Europejski Obszar Gospodarczy</p>	Polski
<p><b>Důležité oznámení: Záruční informace pro zákazníky v EHS* a ve Švýcarsku</b></p> <p>Podrobné záruční informace o tomto produktu Yamaha a záručním servisu v celém EHS* a ve Švýcarsku naleznete na níže uvedené webové adrese (soubor k tisku je dostupný na našich webových stránkách) nebo se můžete obrátit na zastoupení firmy Yamaha ve své zemi. * EHS: Evropský hospodářský prostor</p>	Česky
<p><b>Fontos figyelemzetés: Garancia-információk az EGT* területén és Svájcban élő vásárlók számára</b></p> <p>A jelen Yamaha termékre vonatkozó részletes garancia-információk, valamint az EGT*-re és Svájcra kiterjedő garanciális szolgáltatás tekintetében keresse fel webhelyünket az alábbi címen (a webhelyen nyomtatható fájl is található), vagy pedig lépjen kapcsolatba az országában működő Yamaha képviselői irodával. * EGT: Európai Gazdasági Térség</p>	Magyar
<p><b>Oluline märkus: Garantiiteave Euroopa Majanduspiirkonna (EMP)* ja Šveitsi klientidele</b></p> <p>Täpsemat teabe saamiseks selle Yamaha toote garantii ning kogu Euroopa Majanduspiirkonna ja Šveitsi garantiiteeninduse kohta, külastage palun veebisaiti alljärgneval aadressil (meie saidil on saadaval printitav fail) või pöörduge Teie regiooni Yamaha esinduse poole. * EMP: Euroopa Majanduspiirkond</p>	Eesti keel
<p><b>Svarīgs paziņojums: garantijas informācija klientiem EEZ* un Šveicē</b></p> <p>Lai saņemtu detalizētu garantijas informāciju par šo Yamaha produktu, kā arī garantijas apkalpošanu EEZ* un Šveicē, lūdz, apmeklējiet zemāk norādīto tīmekļa vietnes adresi (tīmekļa vietnē ir pieejams drukājams fails) vai sazinieties ar jūsu valsti apkalpojošo Yamaha pārstāvniecību. * EEZ: Eiropas Ekonomikas zona</p>	Latviešu
<p><b>Děmesio: informacija dėl garantijos pirkėjams EEE* ir Šveicarijoje</b></p> <p>Jei reikia išsamios informacijos apie šį „Yamaha“ produktą ir jo techninę priežiūrą visoje EEE* ir Šveicarijoje, apsilankykite mūsų svetainėje toliau nurodytu adresu (svetainėje yra spausdinamas failas) arba kreipkitės į „Yamaha“ atstovybę savo šaliai. *EEE – Europos ekonominė erdvė</p>	Lietuvių kalba
<p><b>Dôležité upozornenie: Informácie o záruke pre zákazníkov v EHP* a Švajčiarsku</b></p> <p>Podrobné informácie o záruke týkajúce sa tohto produktu od spoločnosti Yamaha a garančnom servise v EHP* a Švajčiarsku nájdete na webovej stránke uvedenej nižšie (na našej webovej stránke je k dispozícii súbor na tlač) alebo sa obráťte na zástupcu spoločnosti Yamaha vo svojej krajine. * EHP: Európsky hospodársky priestor</p>	Slovenčina
<p><b>Pomembno obvestilo: Informacije o garanciji za kupce v EGP* in Švici</b></p> <p>Za podrobnejše informacije o tem Yamahinim izdelku ter garancijskem servisu v celotnem EGP in Švici, obiščite spletno mesto, ki je navedeno spodaj (natisljiva datoteka je na voljo na našem spletnem mestu), ali se obrnite na Yamahinega predstavnika v svoji državi. * EGP: Evropski gospodarski prostor</p>	Slovenščina
<p><b>Важно съобщение: Информация за гаранцията за клиенти в ЕИП* и Швейцария</b></p> <p>За подробна информация за гаранцията за този продукт на Yamaha и гаранционното обслужване в паневропейската зона на ЕИП* и Швейцария или посетете посочения по-долу уеб сайт (на нашия уеб сайт има файл за печат), или се свържете с представителния офис на Yamaha във вашата страна. * ЕИП: Европейско икономическо пространство</p>	Български език
<p><b>Notificare importantă: Informații despre garanție pentru clienții din SEE* și Elveția</b></p> <p>Pentru informații detaliate privind acest produs Yamaha și serviciul de garanție Pan-SEE* și Elveția, vizitați site-ul la adresa de mai jos (fișierul imprimabil este disponibil pe site-ul nostru) sau contactați biroul reprezentanței Yamaha din țara dumneavoastră. * SEE: Spațiul Economic European</p>	Limba română
<p><b>Važna obavijest: Informacije o jamstvu za države EGP-a i Švicarske</b></p> <p>Za detaljne informacije o jamstvu za ovaj Yamahin proizvod te jamstvenom servisu za cijeli EGP i Švicarsku, molimo Vas da posjetite web-stranicu navedenu u nastavku ili kontaktirate ovlaštenog Yamahinog dobavljača u svojoj zemlji. * EGP: Evropski gospodarski prostor</p>	Hrvatski

<https://europe.yamaha.com/warranty/>

URL\_5

For details of products, please contact your nearest Yamaha representative or the authorized distributor listed below.

Pour plus de détails sur les produits, veuillez-vous adresser à Yamaha ou au distributeur le plus proche de vous figurant dans la liste suivante.

Die Einzelheiten zu Produkten sind bei Ihrer unten aufgeführten Niederlassung und bei Yamaha Vertragshändlern in den jeweiligen Bestimmungsländern erhältlich.

Para detalles sobre productos, contacte su tienda Yamaha más cercana o el distribuidor autorizado que se lista debajo.

## NORTH AMERICA

### CANADA

**Yamaha Canada Music Ltd.**  
135 Milner Avenue, Toronto, Ontario M1S 3R1,  
Canada  
Tel: +1-416-298-1311

### U.S.A.

**Yamaha Corporation of America**  
6600 Orangethorpe Avenue, Buena Park, CA 90620,  
U.S.A.  
Tel: +1-714-522-9011

## CENTRAL & SOUTH AMERICA

### MEXICO

**Yamaha de México, S.A. de C.V.**  
Av. Insurgentes Sur 1647 Piso 9, Col. San José  
Insurgentes, Delegación Benito Juárez, México, D.F.,  
C.P. 03900, México  
Tel: +52-55-5804-0600

### BRAZIL

**Yamaha Musical do Brasil Ltda.**  
Rua Fidêncio Ramos, 302 – Cj 52 e 54 – Torre B – Vila  
Olimpia – CEP 04551-010 – São Paulo/SP, Brazil  
Tel: +55-11-3704-1377

### ARGENTINA

**Yamaha Music Latin America, S.A.,  
Sucursal Argentina**  
Olga Cossettini 1553, Piso 4 Norte,  
Madero Este-C1107CEK,  
Buenos Aires, Argentina  
Tel: +54-11-4119-7000

### PANAMA AND OTHER LATIN

### AMERICAN COUNTRIES/ CARIBBEAN COUNTRIES

**Yamaha Music Latin America, S.A.**  
Edificio Torre Davivienda, Piso: 20  
Avenida Balboa, Marbella, Corregimiento de Bella  
Vista, Ciudad de Panamá, Rep. de Panamá  
Tel: +507-269-5311

## EUROPE

### THE UNITED KINGDOM/IRELAND

**Yamaha Music Europe GmbH (UK)**  
Sherbourne Drive, Tilbrook, Milton Keynes,  
MK7 8BL, U.K.  
Tel: +44-1908-366700

### GERMANY

**Yamaha Music Europe GmbH**  
Siemensstrasse 22-34, 25462 Rellingen, Germany  
Tel: +49-4101-303-0

### SWITZERLAND/LIECHTENSTEIN

**Yamaha Music Europe GmbH, Branch  
Switzerland in Thalwil**  
Seestrasse 18a, 8800 Thalwil, Switzerland  
Tel: +41-44-3878080

### AUSTRIA/CROATIA/CZECH REPUBLIC/ HUNGARY/ROMANIA/SLOVAKIA/ SLOVENIA

**Yamaha Music Europe GmbH, Branch Austria**  
Schleiergasse 20, 1100 Wien, Austria  
Tel: +43-1-60203900

### POLAND

**Yamaha Music Europe GmbH**  
Sp.z o.o. Oddział w Polsce  
ul. Wielicka 52, 02-657 Warszawa, Poland  
Tel: +48-22-880-08-88

### BULGARIA

**Dinacord Bulgaria LTD.**  
Bul.Iskarsko Schose 7 Targowski Zentar Ewropa  
1528 Sofia, Bulgaria  
Tel: +359-2-978-20-25

### MALTA

**Olimpus Music Ltd.**  
Valletta Road, Mosta MST9010, Malta  
Tel: +356-2133-2093

### NETHERLANDS/BELGIUM/ LUXEMBOURG

**Yamaha Music Europe, Branch Benelux**  
Clarissenhof 5b, 4133 AB Vianen, The Netherlands  
Tel: +31-347-358040

### FRANCE

**Yamaha Music Europe**  
7 rue Ambroise Croizat, Zone d'activités de Pariest,  
77183 Croissy-Beaubourg, France  
Tel: +33-1-6461-4000

### ITALY

**Yamaha Music Europe GmbH, Branch Italy**  
Via Tinelli N.67/69 20855 Gerno di Lesmo (MB), Italy  
Tel: +39-039-9065-1

### SPAIN/PORTUGAL

**Yamaha Music Europe GmbH Ibérica, Sucursal en  
España**  
Ctra. de la Coruña km. 17,200, 28231  
Las Rozas de Madrid, Spain  
Tel: +34-91-639-88-88

### GREECE

**Philippos Nakas S.A. The Music House**  
19th km. Leof. Lavriou 190 02 Peania – Attiki, Greece  
Tel: +30-210-6686260

### SWEDEN

**Yamaha Music Europe GmbH Germany filial  
Scandinavia**  
JA Wettergrensgata 1, 400 43 Göteborg, Sweden  
Tel: +46-31-89-34-00

### DENMARK

**Yamaha Music Denmark,  
Fillial of Yamaha Music Europe GmbH, Tyskland**  
Generatorvej 8C, ST. TH., 2860 Søborg, Denmark  
Tel: +45-44-92-49-00

### FINLAND

**F-Musiikki Oy**  
Antaksentie 4  
FI-01510 Vantaa, Finland  
Tel: +358 (0)96185111

### NORWAY

**Yamaha Music Europe GmbH Germany -  
Norwegian Branch**  
Grini Næringspark 1, 1332 Østerås, Norway  
Tel: +47-6716-7800

### ICELAND

**Hljóðfaerahúsid Ehf.**  
Sidumula 20  
IS-108 Reykjavik, Iceland  
Tel: +354-525-5050

### CYPRUS

**Nakas Music Cyprus Ltd.**  
Nikis Ave 2k  
1086 Nicosia  
Tel: + 357-22-511080  
**Major Music Center**  
21 Ali Riza Ave. Ortakoy  
P.O.Box 475 Lefkoşa, Cyprus  
Tel: (392) 227 9213

### RUSSIA

**Yamaha Music (Russia) LLC.**  
Room 37, entrance 7, bld. 7, Kievskaya street, Moscow,  
121059, Russia  
Tel: +7-495-626-5005

### OTHER EUROPEAN COUNTRIES

**Yamaha Music Europe GmbH**  
Siemensstrasse 22-34, 25462 Rellingen, Germany  
Tel: +49-4101-303-0

## AFRICA

**Yamaha Music Gulf FZE**  
JAFZA-16, Office 512, P.O.Box 17328,  
Jebel Ali FZE, Dubai, UAE  
Tel: +971-4-801-1500

## MIDDLE EAST

### TURKEY

**Yamaha Music Europe GmbH**  
Merkezi Almanya Türkiye İstanbul Şubesi  
Mor Sumbul Sokak Varyap Meridian Business 1.Blok  
No:1 113-114-115  
Bati Atasehir Istanbul, Turkey  
Tel: +90-216-275-7960

### ISRAEL

**RBX International Co., Ltd.**  
P.O Box 10245, Petach-Tikva, 49002  
Tel: (972) 3-925-6900

### OTHER COUNTRIES

**Yamaha Music Gulf FZE**  
JAFZA-16, Office 512, P.O.Box 17328,  
Jebel Ali FZE, Dubai, UAE  
Tel: +971-4-801-1500

## ASIA

### THE PEOPLE'S REPUBLIC OF CHINA

**Yamaha Music & Electronics (China) Co., Ltd.**  
2F, Yunhedasha, 1818 Xinzha-lu, Jingan-qu,  
Shanghai, China  
Tel: +852-400-051-7700

### HONG KONG

**Tom Lee Music Co., Ltd.**  
11/F, Silvercord Tower 1, 30 Canton Road,  
Tsimshatsui, Kowloon, Hong Kong  
Tel: +852-2737-7688

### INDIA

**Yamaha Music India Private Limited**  
P-401, JMD Megapolis, Sector-48, Sohna Road,  
Gurgaon-122018, Haryana, India  
Tel: +91-124-485-3300

### INDONESIA

**PT. Yamaha Musik Indonesia (Distributor)**  
Yamaha Music Center Bldg. Jalan Jend. Gatot Subroto  
Kav. 4, Jakarta 12930, Indonesia  
Tel: +62-21-520-2577

### KOREA

**Yamaha Music Korea Ltd.**  
11F, Prudential Tower, 298, Gangnam-daero,  
Gangnam-gu, Seoul, 06253, Korea  
Tel: +82-2-3467-3300

### MALAYSIA

**Yamaha Music (Malaysia) Sdn. Bhd.**  
No.8, Jalan Perbandaran, Kelana Jaya, 47301  
Petaling Jaya, Selangor, Malaysia  
Tel: +60-3-78030900

### SINGAPORE

**Yamaha Music (Asia) Private Limited**  
Block 202 Hougang Street 21, #02-00,  
Singapore 530202, Singapore  
Tel: +65-6740-9200

### TAIWAN

**Yamaha Music & Electronics Taiwan Co., Ltd.**  
2F., No.1, Yuandong Rd., Banqiao Dist.,  
New Taipei City 22063, Taiwan (R.O.C.)  
Tel: +886-2-7741-8888

### THAILAND

**Siam Music Yamaha Co., Ltd.**  
3, 4, 15, 16th Fl., Siam Motors Building,  
891/1 Rama 1 Road, Wangmai,  
Pathumwan, Bangkok 10330, Thailand  
Tel: +66-2215-2622

### VIETNAM

**Yamaha Music Vietnam Company Limited**  
15th Floor, Nam A Bank Tower, 201-203 Cach Mang  
Thang Tam St., Ward 4, Dist.3,  
Ho Chi Minh City, Vietnam  
Tel: +84-28-3818-1122

### OTHER ASIAN COUNTRIES

<https://asia-latinamerica-mea.yamaha.com/index.html>

## OCEANIA

### AUSTRALIA

**Yamaha Music Australia Pty. Ltd.**  
Level 1, 80 Market Street, South Melbourne,  
VIC 3205 Australia  
Tel: +61-3-9693-5111

### NEW ZEALAND

**Music Works LTD**  
P.O.BOX 6246 Wellesley, Auckland 4680,  
New Zealand  
Tel: +64-9-634-0099

### COUNTRIES AND TRUST

### TERRITORIES IN PACIFIC OCEAN

<https://asia-latinamerica-mea.yamaha.com/index.html>

**MEMO**

**MEMO**

**MEMO**

**MEMO**

**MEMO**

