

PTZ Optics 20x NDI|HX™



User Manual

Model Nos: PT20X-NDI-GY & PT20X-NDI-WH

V1.2

(English)

Please check PTZOPTICS.com for the most up to date version of this document

Rev 1.2 6/18

Preface

Thank you for using the HD Professional Video Conferencing Camera. This manual introduces the function, installation and operation of the HD camera. Prior to installation and usage, please read the manual thoroughly.

Precautions

This product can only be used in the specified conditions in order to avoid any damage to the camera:

- Don't subject the camera to rain or moisture.
- Don't remove the cover. Removal of the cover may result in an electric shock, in addition to voiding the warranty. In case of abnormal operation, contact the manufacturer.
- Never operate outside of the specified operating temperature range, humidity, or with any other power supply than the one originally provided with the camera.
- Please use a soft dry cloth to clean the camera. If the camera is very dirty, clean it with diluted neutral detergent; do not use any type of solvents, which may damage the surface.

Note

This is an FCC Class A Digital device. As such, unintentional electromagnetic radiation may affect the image quality of TV in a home environment.

Table of Contents

1	Supplied Accessories	1
2	Notes	1
3	Quick Start	2
4	Features	4
5	Product Specifications	5
6	Main Unit	7
7	IR Remote Controller	8
8	Using IR Remote Controller	10
9	Dimensional Drawings	13
10	RS-232 Interface	14
11	Serial Communication Control	15
12	Menu Settings	27
13	Network Connection	32
14	NDI HX™ Setup Guide	45
15	Maintenance and Troubleshooting	46

Supplied Accessories

When you unpack your camera, check that all the supplied accessories are included:

- Camera..... 1
- AC Power Adaptor..... 1
- Power Cord..... 1
- RS232 Cable 1
- IR Remote Controller 1
- User Manual 1

Notes

● Electrical Safety

Installation and operation must be in accordance with national and local electric safety standards. Do not use any power supply other than the one originally supplied with this camera.

● Polarity of power supply

The power supply output for this product is 12VDC with a maximum current supply of 2A. Polarity of the power supply plug is critical and is as follows.

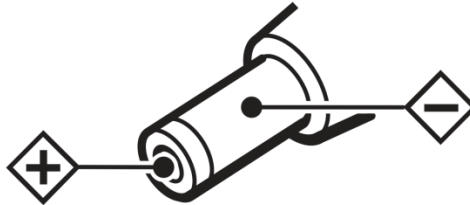

● Handling

- Avoid any stress, vibration, or moisture during transportation, storage, installation and operation.
- Do not lift or move the camera by grasping the camera head. Do not turn the camera head by hand. Doing so may result in mechanical damage.
- Do not expose camera to any corrosive solid, liquid, or gas to avoid damage to the cover which is made of a plastic material.
- Ensure that there are no obstacles in the tilt or pan ranges of the camera lens.
- Never power camera on before installation is complete.
- **DO NOT DISMANTLE THE CAMERA** – The manufacturer is not responsible for any unauthorized modification or dismantling.

Quick Start

Step 1. Please check that all connections are correct before powering on the camera.

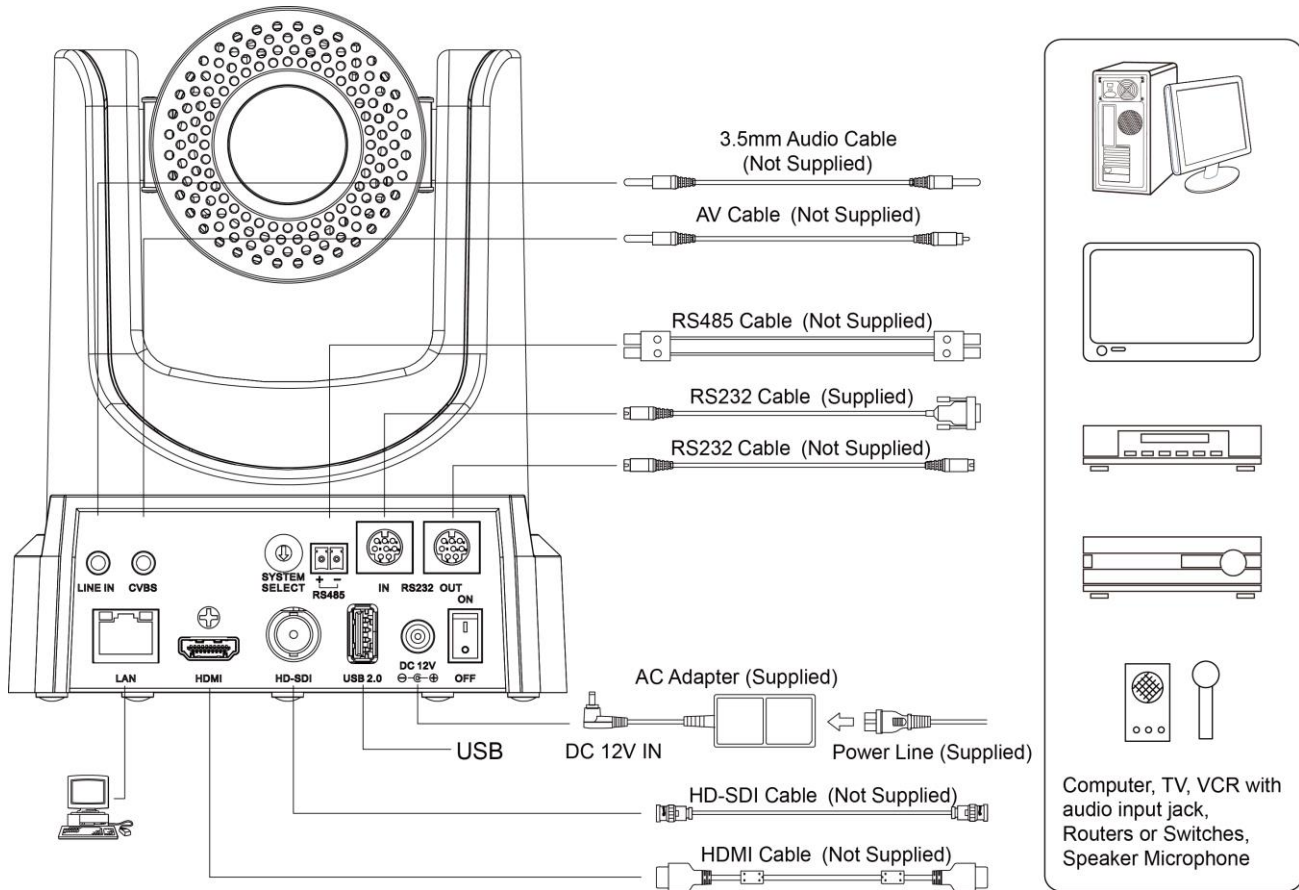

Step2. Set the system select switch for your desired video output resolution and frame rate.

For many applications, setting 0 (1080p-60) will provide the best overall performance.

For highest possible resolution, use setting 0 (1080p-60) or 6 (1080p-30), however your actual realized frame rate may be limited to a lower value than 60 fps by your software and/or network connection.

NOTE: After changing this dial, you need to restart the camera to see the effect. Turn the camera off.

VIDEO SYSTEM			
0	1080p60	8	720p30
1	1080p50	9	720p25
2	1080i60	A	-
3	1080i50	B	-
4	720p60	C	-
5	720p50	D	576i
6	1080p30	E	480i
7	1080p25	F	-

CAUTION: After changing the system (rotary) switch, you need to restart the camera to take effect.

Step3. Press the Switch ON button on the rear of the camera, the power lamp will illuminate.

Step4. The Pan-Tilt mechanism will rotate the lens to the maximum position of top right after the camera starts, then it will return to the “center”. The process of initialization is now complete.

(Note: If the position preset 0 has been stored, the position preset 0 will be called up after initialization in lieu of “home”)

Step5. (Optional) If you want to restore the factory default settings, press [MENU] button to display the OSD menu. Select the item [MENU] -> [RESTORE DEFAULT] -> [Restore].Set the value [Yes], press [HOME] button to restore the factory default settings.

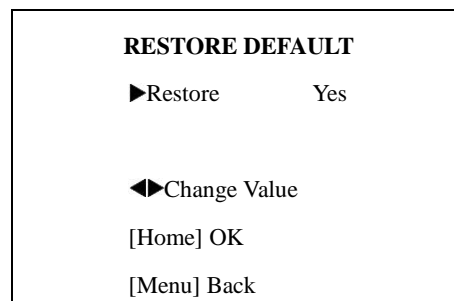

Features

1. Supports simultaneous NDI | HX™, 3G-SDI, HDMI and IP network streaming for up to 1080P@60.
2. Supports non-simultaneous CVBS (composite video) output via RCA connector (480i or 576i).
3. Includes Panasonic's high quality, 1/2.7 inch, 2.07 million effective pixels, HD CMOS sensor, which can produce a maximum 1920 x 1080 image with a high quality, maximum output frame rate of 60 fps (frames per second).
4. Ultra-high frame rate 60fps for HDMI and SDI and up to 720@120fps for IP Streaming / NDI | HX™.
5. Supports IP streaming via RTSP and RTMP and using H.264, H.265 and MJPEG.
6. Microphone & AAC Audio Stream Encoding for NDI™, IP stream & HDMI - Use line-level microphone for audio line in input. Uses AAC audio encoding for better sound quality and smaller bandwidth usage.
7. Includes a Tamron, high-quality, telephoto lens, supporting 20x optical zoom and optional 16x digital zoom with wide angle 60.7 degree horizontal field of view in widest zoom setting.
8. The high SNR (signal to noise ratio) of the CMOS sensor (≥ 55 dB), combined with 2D and 3D noise reduction algorithms, effectively reduces noise, even under low illumination conditions.
9. Includes DRC (dynamic range control), allowing for greater image quality and detail across images that are both well-lit and shadowed in the same frame.
10. Includes RS232 and RS485 interfaces for wired remote control. All of the parameters of the camera can be remotely controlled by high-speed communications for joystick and central control system applications.
11. Includes web-based IP remote control interface.
12. Allows for NDI | HX™ control through NDI® approved platforms that offer control such as the NDI® Studio Monitor
13. Freeze - Allows freezing of video image on all outputs to allow for calling next preset without showing camera motion.
14. Power over Ethernet - Supports PoE 802.3af.

Product Specifications

Model	PT20X-NDI-GY and PT20X-NDI-WH
Type	PTZ Optics NDI HX™ HD 1080p Color Video Camera
Camera	
Video System	HD: 1080p/60, 1080p/50, 1080i/60, 1080i/50, 1080p/30, 1080p/25, 720p/60, 720p/50, 720p30, 720p25 SD: NTSC, PAL
Sensor	1/2.7", CMOS, Effective Pixel: 2.07M
Scanning Mode	Progressive
Lens	20x, f4.42mm ~ 88.5mm, F1.8 ~ F2.8
Digital Zoom	16x
Minimal Illumination	0.05 Lux @ (F1.8, AGC ON)
Shutter	1/30s ~ 1/10000s
White Balance	Auto, Indoor, Outdoor, One Push, Manual, VAR
Backlight Compensation	Support
Digital Noise Reduction	2D&3D Digital Noise Reduction
Video S/N	≥ 55dB
Horizontal Angle of View	3.36° ~ 60.7°
Vertical Angle of View	1.89° ~ 34.1°
Horizontal Rotation Range	±170°
Vertical Rotation Range	-30° ~ +90°
Pan Speed Range	1.7° ~ 100°/s
Tilt Speed Range	1.7° ~ 69.9°/s
H & V flip	Support
Image Freeze	Support
PoE	Support (802.3af)
Face Detection	Not Supported
Local Storage	Not Supported
Number of Preset	255
Preset Accuracy	0.1°
IPC Features	
Video Coding Standard	H.264/H.265/MJPEG
Video Stream	First stream, Second stream
First Stream Resolution	1920x1080, 1280x720, 1024x576, 960x540, 640x480, 640x360
Second Stream Resolution	1280x720, 1024x576, 720x576, 720x408, 640x360, 480x270, 320x240, 320x180

IPC Features	
Bit Rate	128Kbps ~ 8192Kbps
Bit Rate Type	Variable rate, fixed rate
Frame Rate	50Hz: 1fps ~ 50fps, 60Hz: 1fps ~ 60fps, 720p120: 120fps, 640x480p240: 240fps
Audio Standard	AAC
Audio Rate	96K, 128K, 256K
Support Protocols	TCP/IP, HTTP, RTSP, RTMP, Multicast, DHCP, ONVIF etc
Input/Output Interface	
HD Output	1 x HDMI: Version 1.3
	1 x HD-SDI: BNC type, 800mVp-p, 75Ω, Along to SMPTE 424M standard
SD Output	1 x CVBS: RCA jack, 1Vp-p, 75Ω
Network Interface	1 x RJ45: 10/100/1000M Adaptive Ethernet ports
Audio Input	1-ch 3.5mm audio interface, Line In
USB	1 x USB2.0: type A jack
Communication Interface	1 x RS-232 IN: 8pin Min DIN, Max Distance: 30m, Protocol: VISCA/Pelco-D/Pelco-P
	1 x RS-232 OUT: 8pin Min DIN, Max Distance: 30m, Protocol: VISCA network use only
	1 x RS-485: 2pin Phoenix port, Max Distance: 1200m, Protocol: VISCA/Pelco-D/Pelco-P
Power Jack	JEITA type (DC IN 12V)
Generic Specification	
Input Voltage	DC 12V / PoE (802.3af) (optional)
Current Consumption	1.0A (Max)
Operating Temperature	-10°C ~ 40°C (14°F ~ 104°F)
Storage Temperature	-40°C ~ 60°C (-40°F ~ 140°F)
Power Consumption	12W (Max)
MTBF	>30000h
Size	169mm x 142mm x 164mm
Net Weight	1.35 Kg

Main Unit

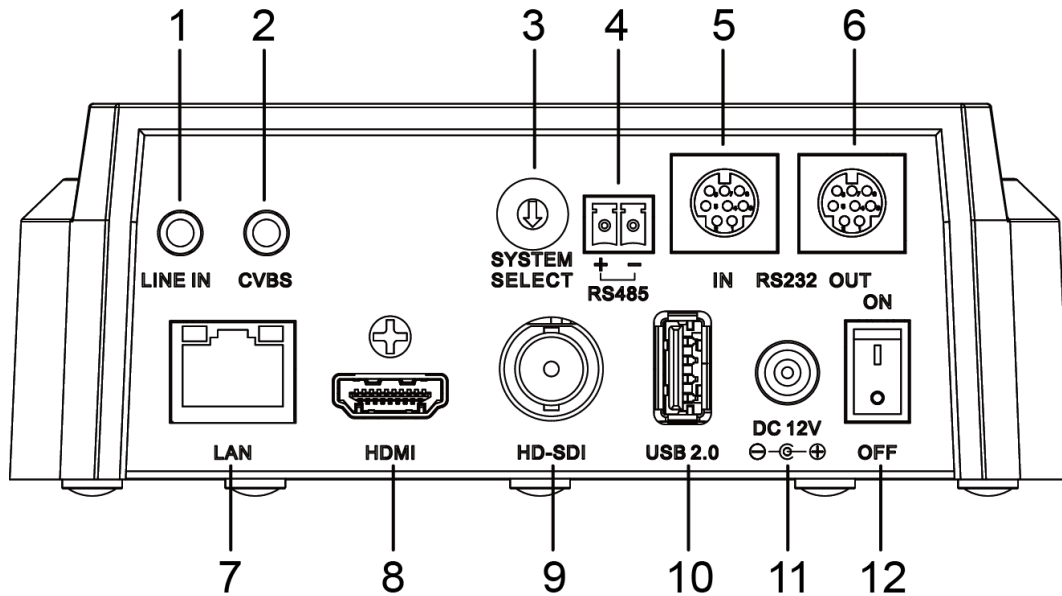

1.Audio LINE IN Interface (NDI|HX™, HDMI, IP)

2.CVBS (composite video SD) Interface

3.System select dial (resolution)

4.RS485 jack

5.RS232 IN jack

6.RS232 OUT jack (pass through for daisy chain)

7.Network (NDI|HX™, IP streaming, and control)

8.HDMI (Digital Video Output)

9.HD-SDI (Serial Digital Video Output)

10.USB 2.0 (USB Storage)

11.DC 12V power jack

12.Power switch

IR Remote Controller

1. Standby Button

Press this button to enter standby mode. Press it again to enter normal mode.

NOTE: Power consumption in standby mode is approximately half of the normal mode.

2. Position Buttons

To set preset or call preset.

3. * Button

For multiple function.

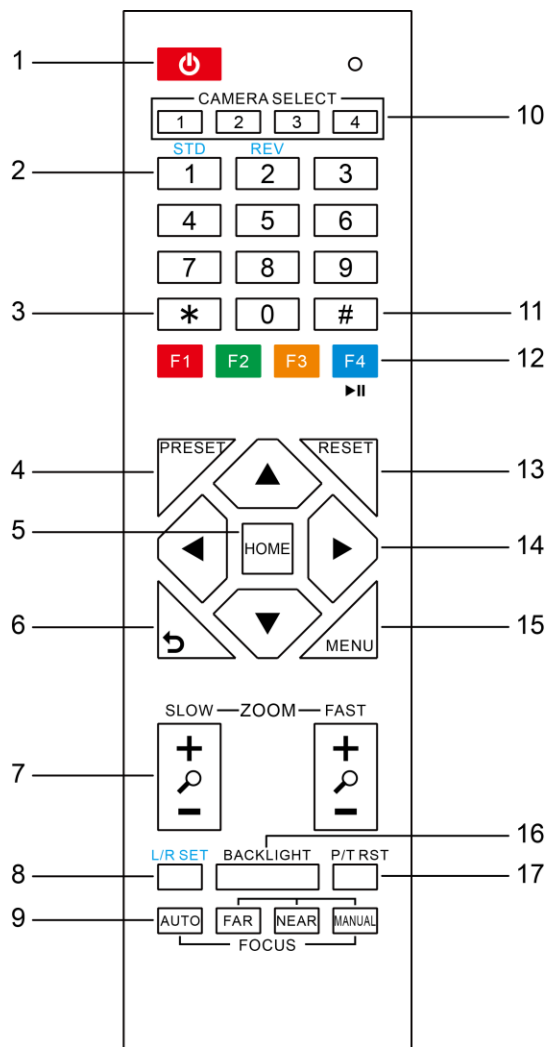

4&13. Set/Clear Preset Buttons

Set preset: Store a preset position

[PRESET] + Numeric button (0-9): Setting a corresponding numeric key preset position

NOTE: Preset 0 - 9 via remote control and the rest from web, keyboard and the serial port.

Clear preset: Erase a preset position [RESET] + Numeric button (0-9), or: [*] + [#] + [RESET]: Erase all presets

5&14. Pan/Tilt Control Buttons

Press the arrow buttons to perform panning and tilting. Press the [HOME] button to face the camera back to front.

6. Return Button

Press the button to back previous menu.

7. Zoom Buttons

Zoom+: Zoom In (Slow and fast speed)

Zoom-: Zoom Out (Slow and fast speed)

8. L/R Set Button

Set the left & right direction of the remote control.

Simultaneously press [L/R Set] + [1]: Normal direction.

Simultaneously press [L/R Set] + [2]: Left and right direction will be reversed.

9. Focus Buttons

Used for focus adjustment.

Press [AUTO] to adjust the focus on the center of the object automatically. To adjust the focus manually, press the [MANUAL] button, and adjust it with [Far] (focus on far object) and [Near] (focus on near object).

10. Camera Address Select Buttons

Press the button corresponding to the camera which you want to operate with the remote controller.

11. # Button

For multiple function.

12. Multiple Function Buttons

Function 1. Set camera IR address

Press 3 keys contiguously can set camera IR address as follow:

[*] + [#] + [F1]: Address 1

[*] + [#] + [F2]: Address 2

[*] + [#] + [F3]: Address 3

[*] + [#] + [F4]: Address 4

Function 2. Image freezing function

Press [F4] to start the freeze function. The word "Freeze" displays on the upper left corner. After five seconds, the display disappears automatically (though the freeze feature continues). To cancel the freeze, press the [F4] key the word "Unfreeze" displays on the upper left corner. After five seconds, the display disappears automatically.

15. Menu Button

Menu button: Press this button to enter or exit the OSD menu.

16. Backlight Button

Backlight button: Press this button to enable the backlight compensation. Press it again to disable the backlight compensation.

NOTE: Effective only in auto exposure mode.

NOTE: If there is a light behind the subject, the subject will appear dark. In this case, press the backlight ON / OFF button. To cancel this function, press the backlight ON / OFF button.

17. P/T RST Button

Press the button to self-calibrate pan and tilt once again.

Shortcuts for some 'Set' Functions

[*] + [#] + [1]: Display OSD menu in English

[*] + [#] + [3]: Display OSD menu in Chinese

[*] + [#] + [4]: Show IP address

[*] + [#] + [6]: Quickly restore the default settings

[*] + [#] + [8]: Show the camera version

[*] + [#] + [9]: Quickly set mount mode (flip / normal) 1. Standby Button

Press this button to enter standby mode. Press it again to enter normal mode.

NOTE: Power consumption in standby mode is approximately half of the normal mode.

Using IR Remote Controller

When the camera is operational, you can use the remote controller to perform panning, tilting, zooming and focusing, as well as store and call back preset positions.

Button Instructions:

1. In these instructions, ‘press the button’ means to press and release. A special note will be given if holding a button down for more than one second is required.

2. When a button-combination is required, do it in sequence (not simultaneously). For example, ‘[*] + [#] + [F1]’ means press [*] first and then press [#] and then press [F1].

1. Pan/Tilt Control

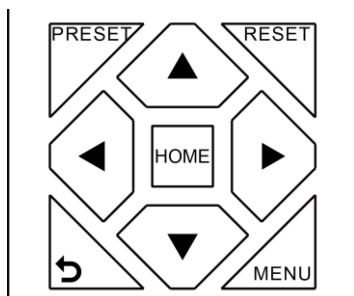

- | | |
|--------------------------------|--------------|
| Tilt up: | Press [▲] |
| Tilt down: | Press [▼] |
| Pan left: | Press [◀] |
| Pan right: | Press [▶] |
| Face the camera back to front: | Press [HOME] |

Press and hold the up/down/left/right buttons, to keep panning or tilting from slow to fast, (until the camera reaches the mechanical limit). The camera stops as soon as the button is released.

2. Zoom Control

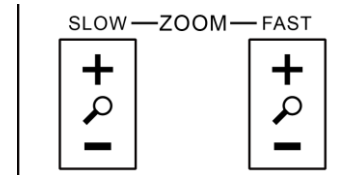

- | | |
|-----------|-------------------------------------|
| Zoom Out: | press [+] button under FAST or SLOW |
| Zoom In: | press [-] button under FAST or SLOW |

Press and hold the button, to keep zooming in or out (until the lens reaches the mechanical limit). The lens stops as soon as the button is released.

3. Focus Control



AUTO: Change focus mode to AF, which allows the camera to adjust the focus automatically on the center of the image.

MANUAL: Change focus mode to MF, which allows the user to adjust the focus manually (see FOCUS FAR & FOCUSNEAR).

FOCUS FAR: Press [FAR] button(NOTE: Effective only in MANUAL focus mode)

FOCUS NEAR: Press [NEAR] button(NOTE: Effective only in MANUAL focus mode)

Press and hold the FOCUS [FAR] or FOCUS [NEAR] button, allows for continuous adjustment, stopping as soon as the button is released.

4. BACKLIGHT, L/R SET and P/T RST Controls

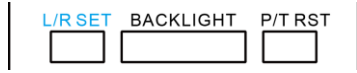

Reverse Pan controls direction: Press and hold [L/R SET] button while pressing [1] aka [STD] button for normal pan controls. Press and hold [L/R SET] button while pressing [2] aka [REV] button for reversed pan controls.

Backlight Compensation Control: Press [BACKLIGHT] button to enable backlight compensation. Press it again to disable backlight compensation. (Note: Backlight is only effective in full auto exposure mode)

Pan Tilt Control Self Calibration: Press [P/T RST] button to recalibrate the Pan and Tilt limits.

5. Standby Control



Press [Power] button to put camera in 'standby' mode. In standby mode the camera will provide no image, respond to no commands and use less than half its normal power. Press [Power] button again to put camera in normal mode.

6. Presets - Setting and Clearing

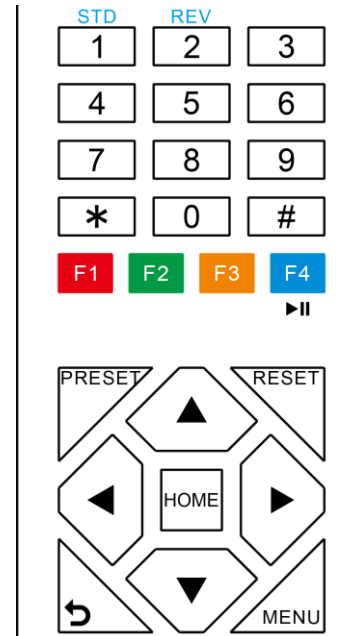

1. To store a preset position: The user should manually setup the desired shot using the Pan Tilt and Zoom controls. Press the [PRESET] button first and then press the numeric button [0-9] to which you want to assign the shot. Ten total preset positions (0-9) are available from the IR remote control (255 available via RS232/RS485/IP Interfaces).

2. To erase the memory content of a preset position: The user should press the [RESET] button first and then press the numeric button 0-9 associated with that preset.

Note:

Pressing [*]+[#]+[RESET] in sequence will erase all presets in the memory.

7. Recalling Presets

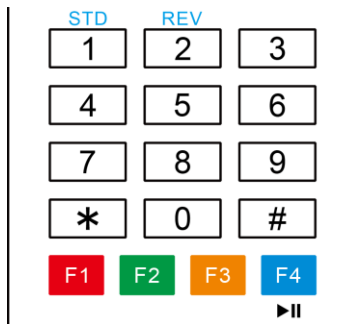

Pressing any of the numeric buttons [0-9] directly will recall a stored preset position and settings.

Note:

No action will be executed if a specific numeric preset position has not yet been saved.

Note:

Presets assigned via the IP interface do not correlate to presets set via the IR remote control.

8. Camera Selection

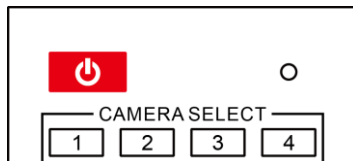

Press the [1-4] button corresponding to the camera with the IR address that you want to operate. This allows for up to 4 cameras to be operated via the same IR remote in the same room.

9. Camera IR Address Set



Press 3 buttons in the sequence shown below to set/change the camera's IR address. This allows up to 4 cameras to be controlled from the same IR remote control. Be sure that only one camera is picking up the IR signal when you perform this function. If multiple cameras receive the command, they will all change to the new address.

Address 1: [*]+[#]+[F1]

Address 2: [*]+[#]+[F2]

Address 3: [*]+[#]+[F3]

Address 4: [*]+[#]+[F4]

10. Image Freeze



Press the [▶||] button to freeze or unfreeze the video image. This can be useful while recalling presets to hide camera motion from your viewers.

Dimensional Drawings (mm)

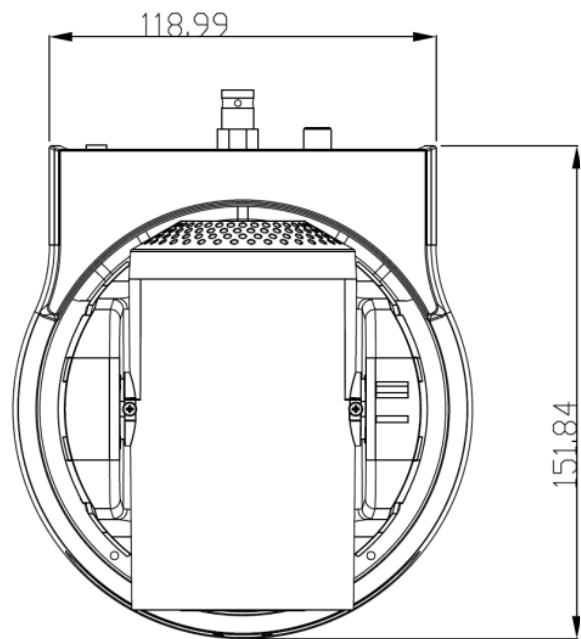
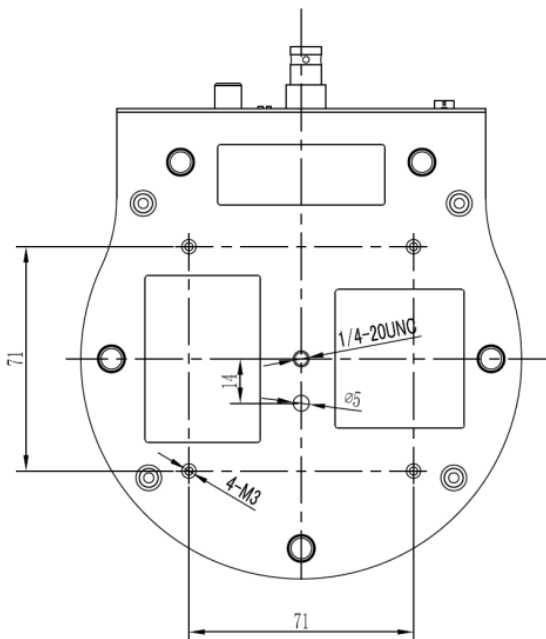
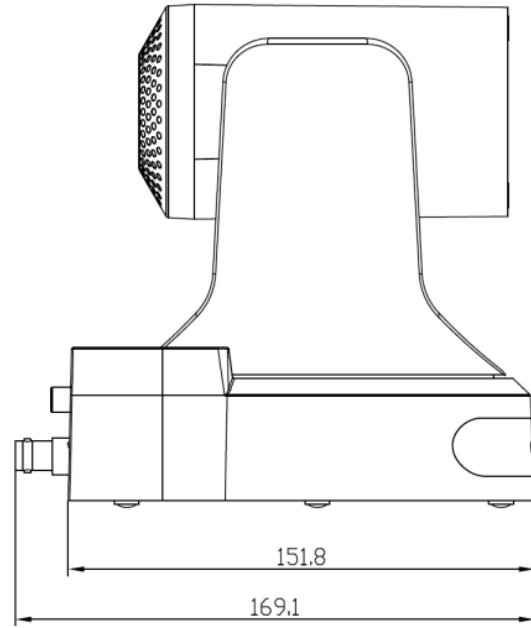
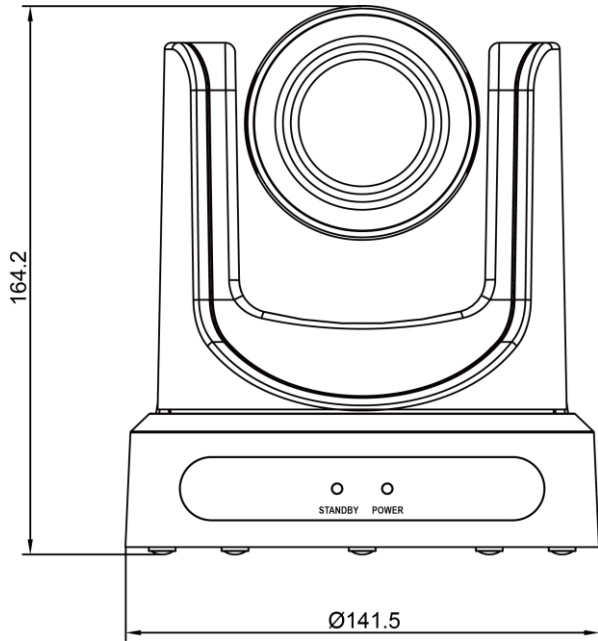

RS-232 Interface

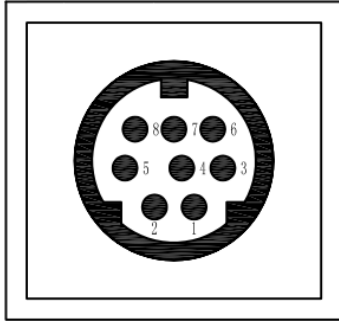

No.	Function
1	DTR
2	DSR
3	TXD
4	GND
5	RXD
6	GND
7	IR OUT
8	NC

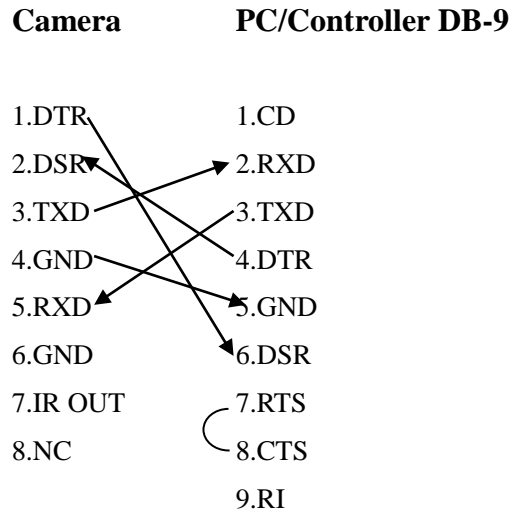

For Control Daisy Chain

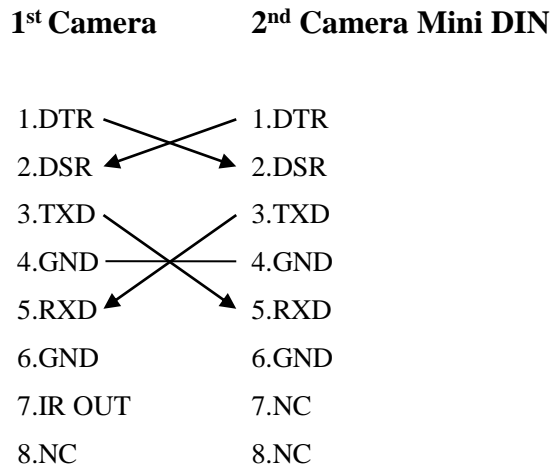

Serial Communication Control

In default working mode, the camera is able to connect to a VISCA controller with an RS232C serial interface.

➤ RS232 Communication Control

The camera can be controlled via RS232. The parameters of RS232C are as follows:

Baud rate: 2400, 4800, 9600 or 38400 bps.

Start bit: 1 bit.

Data bit: 8 bits.

Stop bit: 1 bit.

Parity bit: none.

➤ RS485 Communication Control

The camera can be controlled via RS485, Half-duplex mode, with support for VISCA, Pelco-D or Pelco-P protocol.

The parameters of RS485 are as follows:

Baud rate: 2400, 4800, 9600 or 38400 bps.

Start bit: 1 bit.

Data bit: 8 bits.

Stop bit: 1 bit.

Parity bit: none.

When powered on, Pan and Tilt will rotate to the maximum position of top right after the camera powered up. Then it will return to the “center”. The process of initialization is now complete. (Note: If the position preset 0 has been stored, the position preset 0 will be called up after initialization, in lieu of “center”). After initialization is complete, then the user can control the camera with commands in the command list.

VISCA Command List

Part 1: Camera-Issued Messages

ACK/Completion Message			
Command	Function	Command Packet	Comments
ACK/Completion Messages	ACK	z0 4y FF (y: Socket No.)	Returned when the command is accepted.
	Completion	z0 5y FF (y: Socket No.)	Returned when the command has been executed.

z = Camera Address + 8

Error Messages			
Command	Function	Command Packet	Comments
Error Messages	Syntax Error	z0 60 02 FF	Returned when the command format is different or when a command with illegal command parameters is accepted.
	Command Buffer Full	z0 60 03 FF	Indicates that two sockets are already being used (executing two commands) and the command could not be accepted when received.
	Command Canceled	z0 6y 04 FF (y: Socket No.)	Returned when a command which is being executed in a socket specified by the cancel command is canceled. The completion message for the command is not returned.
	No Socket	z0 6y 05 FF (y: Socket No.)	Returned when no command is executed in a socket specified by the cancel command, or when an invalid socket number is specified.
	Command Not Executable	z0 6y 41 FF (y: Execution command Socket No. Inquiry command: 0)	Returned when a command cannot be executed due to current conditions. For example, when commands controlling the focus manually are received during auto focus.

Part 2: Camera Control Commands

Command	Function	Command Packet	Comments
AddressSet	Broadcast	88 30 01 FF	Address setting
IF_Clear	Broadcast	88 01 00 01 FF	I/F Clear
CAM_Power	On	8x 01 04 00 02 FF	Power ON/OFF
	Off	8x 01 04 00 03 FF	
CAM_Zoom	Stop	8x 01 04 07 00 FF	
	Tele(Standard)	8x 01 04 07 02 FF	
	Wide(Standard)	8x 01 04 07 03 FF	
	Tele(Variable)	8x 01 04 07 2p FF	p = 0(low) - 7(high)
	Wide(Variable)	8x 01 04 07 3p FF	
	Direct	8x 01 04 47 0p 0q 0r 0s FF	pqrs: Zoom Position
CAM_Focus	Stop	8x 01 04 08 00 FF	
	Far(Standard)	8x 01 04 08 02 FF	
	Near(Standard)	8x 01 04 08 03 FF	
	Far(Variable)	8x 01 04 08 2p FF	p = 0(low) - 7(high)
	Near(Variable)	8x 01 04 08 3p FF	
	Direct	8x 01 04 48 0p 0q 0r 0s FF	pqrs: Focus Position
	Auto Focus	8x 01 04 38 02 FF	AF On/Off
	Manual Focus	8x 01 04 38 03 FF	
Auto/Manual	8x 01 04 38 10 FF		
CAM_ZoomFocus	Direct	8x 01 04 47 0p 0q 0r 0s 0t 0u 0v 0w FF	pqrs: Zoom Position tuvw: Focus Position
CAM_WB	Auto	8x 01 04 35 00 FF	Normal Auto
	Indoor mode	8x 01 04 35 01 FF	Indoor mode
	Outdoor mode	8x 01 04 35 02 FF	Outdoor mode
	OnePush mode	8x 01 04 35 03 FF	One Push WB mode
	Manual	8x 01 04 35 05 FF	Manual Control mode
	OnePush trigger	8x 01 04 10 05 FF	One Push WB Trigger
CAM_RGain	Reset	8x 01 04 03 00 FF	Manual Control of R Gain
	Up	8x 01 04 03 02 FF	
	Down	8x 01 04 03 03 FF	
	Direct	8x 01 04 43 00 00 0p 0q FF	pq: R Gain
CAM_Bgain	Reset	8x 01 04 04 00 FF	Manual Control of B Gain
	Up	8x 01 04 04 02 FF	
	Down	8x 01 04 04 03 FF	
	Direct	8x 01 04 44 00 00 0p 0q FF	pq: B Gain

CAM_AE	Full Auto	8x 01 04 39 00 FF	Automatic Exposure mode
	Manual	8x 01 04 39 03 FF	Manual Control mode
	Shutter priority	8x 01 04 39 0A FF	Shutter Priority Automatic Exposure mode
	Iris priority	8x 01 04 39 0B FF	Iris Priority Automatic Exposure mode
	Bright	8x 01 04 39 0D FF	Bright Mode(Manual control)
CAM_SlowShutter	AutoSlowShutterLimit	8x 01 04 2A 0p 00 FF	
CAM_Iris	Reset	8x 01 04 0B 00 FF	Iris Setting
	Up	8x 01 04 0B 02 FF	
	Down	8x 01 04 0B 03 FF	
	Direct	8x 01 04 4B 00 00 0p 0q FF	pq: Iris Position
CAM_Gain	Reset	8x 01 04 0C 00 FF	Gain Setting
	Up	8x 01 04 0C 02 FF	
	Down	8x 01 04 0C 03 FF	
	Direct	8x 01 04 0C 00 00 0p 0q FF	pq: Gain Position
	Gain Limit	8x 01 04 2C 0p FF	p: Gain Position
CAM_Bright	Reset	8x 01 04 0D 00 FF	Bright Setting
	Up	8x 01 04 0D 02 FF	
	Down	8x 01 04 0D 03 FF	
	Direct	8x 01 04 0D 00 00 0p 0q FF	pq: Bright Position
CAM_ExpComp	On	8x 01 04 3E 02 FF	Exposure Compensation On/Off
	Off	8x 01 04 3E 03 FF	
	Reset	8x 01 04 0E 00 FF	Exposure Compensation Amount Setting
	Up	8x 01 04 0E 02 FF	
	Down	8x 01 04 0E 03 FF	
	Direct	8x 01 04 4E 00 00 0p 0q FF	pq: ExpComp Position
CAM_BackLight	On	8x 01 04 33 02 FF	Back Light Compensation On/Off
	Off	8x 01 04 33 03 FF	
CAM_NR(2D)Mode	Auto	8x 01 04 50 02 FF	ND2D Auto/Manual
	Manual	8x 01 04 50 03 FF	
CAM_NR(2D)Level	-	8x 01 04 53 0p FF	p: NR Setting (0: Off, level 1 to 5)
CAM_NR(3D)Level	-	8x 01 04 54 0p FF	p: NR Setting (0: Off, level 1 to 8)
CAM_Flicker	-	8x 01 04 23 0p FF	p: Flicker Settings (0: Off, 1: 50Hz, 2: 60Hz)
CAM_DHotPixel	-	8x 01 04 56 0p FF	p: Dynamic Hot Pixel Setting (0: Off, level 1 to 6)
CAM_ApertureMode(sharpness)	Auto	8x 01 04 05 02 FF	Sharpness Auto
	Manual	8x 01 04 05 02 FF	Sharpness Manual

CAM_Aperture(sharpness)	Reset	8x 01 04 02 00 FF	Aperture Control
	Up	8x 01 04 02 02 FF	
	Down	8x 01 04 02 03 FF	
	Direct	8x 01 04 42 00 00 0p 0q FF	pq: Aperture Gain
CAM_PictureEffect	Off	8x 01 04 63 00 FF	Picture Effect Setting
	B&W	8x 01 04 63 04 FF	
CAM_Memory	Reset	8x 01 04 3F 00 pp FF	pp: Memory Number(=0 to 127)
	Set	8x 01 04 3F 01 pp FF	
	Recall	8x 01 04 3F 02 pp FF	
CAM_LR_Reverse	On	8x 01 04 61 02 FF	Image Flip Horizontal On/Off
	Off	8x 01 04 61 03 FF	
CAM_PictureFlip	On	8x 01 04 66 02 FF	Image Flip Vertical On/Off
	Off	8x 01 04 66 03 FF	
CAM_RegisterValue	-	8x 01 04 24 mn 0p 0q FF	mm: Register No. (=00-7F) pp: Register Value (=00-7F)
CAM_ColorGain	Diret	8x 01 04 49 00 00 00 0p FF	p: Color Gain setting 0h (60%) to Eh (200%)
SYS_Menu	Off	8x 01 06 06 03 FF	Turns off the menu screen
Pan_tiltDrive	Up	8x 01 06 01 VV WW 03 01 FF	VV: Pan speed 0x01 (low speed) to 0x18 (high speed) WW: Tilt speed 0x01 (low speed) to 0x14 (high speed) YYYY: Pan Position ZZZZ: Tilt Position
	Down	8x 01 06 01 VV WW 03 02 FF	
	Left	8x 01 06 01 VV WW 01 03 FF	
	Right	8x 01 06 01 VV WW 02 03 FF	
	Upleft	8x 01 06 01 VV WW 01 01 FF	
	Upright	8x 01 06 01 VV WW 02 01 FF	
	DownLeft	8x 01 06 01 VV WW 01 02 FF	
	DownRight	8x 01 06 01 VV WW 02 02 FF	
	Stop	8x 01 06 01 VV WW 03 03 FF	
	AbsolutePosition	8x 01 06 02 VV WW 0Y 0Y 0Y 0Y 0Z 0Z 0Z 0Z FF	
	RelativePosition	8x 01 06 03 VV WW 0Y 0Y 0Y 0Y 0Z 0Z 0Z 0Z FF	
	Home	8x 01 06 04 FF	
	Reset	8x 01 06 05 FF	
Pan_tiltLimitSet	LimitSet	8x 01 06 07 00 0W 0Y 0Y 0Y 0Y 0Z 0Z 0Z 0Z FF	W: 1 UpRight 0: DownLeft YYYY: Pan Limit Position ZZZZ: Tilt Position
	LimitClear	8x 01 06 07 01 0W 07 0F 0F 0F 07 0F 0F 0F FF	
CAM_AFSensitivity	High	8x 01 04 58 01 FF	AF Sensitivity High/Normal/Low
	Normal	8x 01 04 58 02 FF	

	Low	8x 01 04 58 03 FF	
CAM_SettingReset	Reset	8x 01 04 A0 10 FF	Reset Factory Setting
CAM_Brightness	Direct	8x 01 04 A1 00 00 0p 0q FF	pq: Brightness Position
CAM_Contrast	Direct	8x 01 04 A2 00 00 0p 0q FF	pq: Contrast Position
CAM_Flip	Off	8x 01 04 A4 00 FF	Single Command For Video Flip
	Flip-H	8x 01 04 A4 01 FF	
	Flip-V	8x 01 04 A4 02 FF	
	Flip-HV	8x 01 04 A4 03 FF	
CAM_SettingSave	Save	8x 01 04 A5 10 FF	Save Current Setting
CAM_Iridix	Direct	8x 01 04 A7 00 00 0p 0q FF	pq: Iridix Position
CAM_AWBSensitivity	High	8x 01 04 A9 00 FF	High
	Normal	8x 01 04 A9 01 FF	Normal
	Low	8x 01 04 A9 02 FF	Low
CAM_AFZone	Top	8x 01 04 AA 00 FF	AF Zone weight select
	Center	8x 01 04 AA 01 FF	
	Bottom	8x 01 04 AA 02 FF	
CAM_ColorHue	Direct	8x 01 04 4F 00 00 00 0p FF	p: Color Hue setting 0h (- 14 degrees) to Eh (+14 degrees)

Part 3: Query Commands

Inquiry Command List			
Command	Command packed	Inquiry Packet	Comments
CAM_PowerInq	8x 09 04 00 FF	y0 50 02 FF	On
		y0 50 03 FF	Off(Standby)
		y0 50 04 FF	Internal power circuit error
CAM_ZoomPosInq	8x 09 04 47 FF	y0 50 0p 0q 0r 0s FF	pqrs: Zoom Position
CAM_FocusAFMode Inq	8x 09 04 38 FF	y0 50 02 FF	Auto Focus
		y0 50 03 FF	Manual Focus
CAM_FocusPosInq	8x 09 04 48 FF	y0 50 0p 0q 0r 0s FF	pqrs: Focus Position
CAM_WBModeInq	8x 09 04 35 FF	y0 50 00 FF	Auto
		y0 50 01 FF	Indoor mode
		y0 50 02 FF	Outdoor mode
		y0 50 03 FF	OnePush mode
		y0 50 05 FF	Manual
CAM_RGainInq	8x 09 04 43 FF	y0 50 00 00 0p 0q FF	pq: R Gain
CAM_BGainInq	8x 09 04 44 FF	y0 50 00 00 0p 0q FF	pq: B Gain
CAM_AEModeInq	8x 09 04 39 FF	y0 50 00 FF	Full Auto
		y0 50 03 FF	Manual
		y0 50 0A FF	Shutter priority
		y0 50 0B FF	Iris priority
		y0 50 0D FF	Bright
CAM_ShutterPosInq	8x 09 04 4A FF	y0 50 00 00 0p 0q FF	pq: Shutter Position
CAM_IrisPosInq	8x 09 04 4B FF	y0 50 00 00 0p 0q FF	pq: Iris Position
CAM_BrightPosInq	8x 09 04 4D FF	y0 50 00 00 0p 0q FF	pq: Bright Position
CAM_ExpCompModeInq	8x 09 04 3E FF	y0 50 02 FF	On
		y0 50 03 FF	Off
CAM_ExpCompPosInq	8x 09 04 4E FF	y0 50 00 00 0p 0q FF	pq: ExpComp Position
CAM_BacklightMode Inq	8x 09 04 33 FF	y0 50 02 FF	On
		y0 50 03 FF	Off
CAM_Nosise2DMode Inq	8x 09 04 50 FF	y0 50 02 FF	Auto Noise 2D
		y0 50 03 FF	Manual Noise 3D
CAM_Nosise2DLevel	8x 09 04 53 FF	y0 50 0p FF	Noise Reduction (2D) p: 0 to 5
CAM_Noise3DLevel	8x 09 04 54 FF	y0 50 0p FF	Noise Reduction (3D) p: 0 to 8
CAM_FlickerModeInq	8x 09 04 55 FF	y0 50 0p FF	p: Flicker Settings(0: OFF, 1: 50Hz, 2: 60Hz)
		y0 50 02 FF	Auto Sharpness



broadcast quality made affordable

CAM_ApertureModelInq(Sharpness)	8x 09 04 05 FF	y0 50 03 FF	Manual Sharpness
CAM_ApertureInq(Sharpness)	8x 09 04 42 FF	y0 50 00 00 0p 0q FF	pq: Aperture Gain
CAM_PictureEffectModeInq	8x 09 04 63 FF	y0 50 02 FF	Off
		y0 50 04 FF	B&W
CAM_MemoryInq	8x 09 04 3F FF	y0 50 0p FF	p: Memory number last operated.
SYS_MenuModeInq	8x 09 06 06 FF	y0 50 02 FF	On
		y0 50 03 FF	Off
CAM_LR_ReverseInq	8x 09 04 61 FF	y0 50 02 FF	On
		y0 50 03 FF	Off
CAM_PictureFlipInq	8x 09 04 66 FF	y0 50 02 FF	On
		y0 50 03 FF	Off
CAM_RegisterValueInq	8x 09 04 24 mm FF	y0 50 0p 0p ff	mm: Register No. (00 to FF) pp: Register Value (00 to FF)
CAM_ColorGainInq	8x 09 04 49 FF	y0 50 00 00 00 0p FF	p: Color Gain setting 0h (60%) to Eh (200%)
CAM_IDInq	8x 09 04 22 FF	y0 50 0p 0q 0r 0s FF	pqrs: Camera ID
CAM_VersionInq	8x 09 00 02 FF	y0 50 ab cd mn pq rs tu vw FF	ab: Factory Code(00: VHD, 01:MR, 08:T) cd: Hardware Version mnpq: ARM Version rstu: FPGA Version vw: Camera model 01: C Type 02: M Type 03: S Type
VideoSystemInq	8x 09 06 23 FF	y0 50 00 FF	1920x1080i60
		y0 50 01 FF	1920x1080p30
		y0 50 02 FF	1280x720p60
		y0 50 04 FF	NTSC
		y0 50 05 FF	NTSC
		y0 50 06 FF	NTSC
		y0 50 07 FF	1920x1080p60
		y0 50 08 FF	1920x1080i50
		y0 50 09 FF	1920x1080p25
		y0 50 0A FF	1280x720p50
		y0 50 0C FF	PAL
		y0 50 0D FF	PAL

		y0 50 0E FF	PAL
IR_Receive	8x 09 06 08 FF	y0 50 02 FF	On
		y0 50 03 FF	Off
Pan-tiltMaxSpeedInq	8x 09 06 11 FF	y0 50 ww zz FF	ww: Pan Max Speed zz: Tilt Max Speed
Pan-tiltPosInq	8x 09 06 12 FF	y0 50 0w 0w 0w 0w 0z 0z 0z 0z FF	www: Pan Position zzz: Tilt Position
CAM_TypeInq	8x 09 00 03 FF	y0 50 01 FF	C Type
		y0 50 02 FF	M Type
		y0 50 03 FF	S Type
CAM_DateInq	8x 09 00 04 FF	y0 50 0r ss uu vv ww 0D FF	Version dater: Big Version Numbers: Little Version Numberuuuu: Yearvv: Monthww: Day
CAM_ModeInq	8x 09 04 A6 FF	y0 50 00 FF	Mode0
		y0 50 02 FF	Mode2
CAM_GainLimitInq	8x 09 04 2C FF	y0 50 0q FF	p: Gain Limit
CAM_DHotPixelInq	8x 09 04 56 FF	y0 50 0q FF	p: Dynamic Hot Pixel Setting (0: Off, level 1 to 6)
CAM_AFSensitivityInq	8x 09 04 58 FF	y0 50 01 FF	High
		y0 50 02 FF	Normal
		y0 50 03 FF	Low
CAM_BrightnessInq	8x 09 04 A1 FF	y0 50 00 00 0p 0q FF	pq: Brightness Position
CAM_ContrastInq	8x 09 04 A2 FF	y0 50 00 00 0p 0q FF	pq: Contrast Position
CAM_FlipInq	8x 09 04 A4 FF	y0 50 00 FF	Off
		y0 50 01 FF	Flip-H
		y0 50 02 FF	Flip-V
		y0 50 03 FF	Flip-HV
CAM_IridixInq	8x 09 04 A7 FF	y0 50 00 00 0p 0q FF	pq: Iridix Position
CAM_AFZone	8x 09 04 AA FF	y0 50 00 FF	Top
		y0 50 01 FF	Center
		y0 50 02 FF	Bottom
CAM_ColorHueInq	8x 09 04 4F FF	y0 50 00 00 00 0p FF	p: Color Hue setting 0h (- 14 degrees) to Eh (+14 degrees)
CAM_AWBSensitivityInq	8x 09 04 A9 FF	y0 50 00 FF	High
		y0 50 01 FF	Normal
		y0 50 02 FF	Low

Block Inquiry Command List			
Command	Command packed	Inquiry Packet	Comments
CAM_LensBlockInq	8x 09 7E 7E 00 FF	y0 50 0u 0u 0u 0u 00 00 0v 0v 0v 0v 00 0w 00 FF	uuuu: Zoom Position vvvv: Focus Position w.bit0: Focus Mode 1: Auto 0: Manual
CAM_CameraBlockInq	8x 09 7E 7E 01 FF	y0 50 0p 0p 0q 0q 0r 0s tt 0u vv ww 00 xx 0z FF	pp: R_Gain qq: B_Gain r: WB Mode s: Aperture tt: AE Mode u.bit2: Back Light u.bit1: Exposure Comp. vv: Shutter Position ww: Iris Position xx: Bright Position z: Exposure Comp. Position
CAM_OtherBlockInq	8x 09 7E 7E 02 FF	y0 50 0p 0q 00 0r 00 00 00 00 00 00 00 00 00 FF	p.bit0: Power 1:On, 0:Off q.bit2: LR Reverse 1:On, 0:Off r.bit3~0: Picture Effect Mode
CAM_EnlargementBlockInq	8x 09 7E 7E 03 FF	y0 50 00 00 00 00 00 00 0p 0q rr 0s 0t 0u FF	p: AF sensitivity q.bit0: Picture flip(1:On, 0:Off) rr.bit6~3: Color Gain(0h(60%) to Eh(200%)) s: Flip(0: Off, 1:Flip-H, 2:Flip-V, 3:Flip-HV) t.bit2~0: NR2D Level u: Gain Limit

Note:

The [x] in the above table is the camera address, [y] = [x + 8].

Pelco-D Protocol Command List

Function	Byte1	Byte2	Byte3	Byte4	Byte5	Byte6	Byte7
Up	0xFF	Address	0x00	0x08	Pan Speed	Tilt Speed	SUM
Down	0xFF	Address	0x00	0x10	Pan Speed	Tilt Speed	SUM
Left	0xFF	Address	0x00	0x04	Pan Speed	Tilt Speed	SUM
Right	0xFF	Address	0x00	0x02	Pan Speed	Tilt Speed	SUM
Zoom In	0xFF	Address	0x00	0x20	0x00	0x00	SUM
Zoom Out	0xFF	Address	0x00	0x40	0x00	0x00	SUM
Focus Far	0xFF	Address	0x00	0x80	0x00	0x00	SUM
Focus Near	0xFF	Address	0x01	0x00	0x00	0x00	SUM
Set Preset	0xFF	Address	0x00	0x03	0x00	Preset ID	SUM
Clear Preset	0xFF	Address	0x00	0x05	0x00	Preset ID	SUM
Call Preset	0xFF	Address	0x00	0x07	0x00	Preset ID	SUM
Auto Focus	0xFF	Address	0x00	0x2B	0x00	0x01	SUM
Manual Focus	0xFF	Address	0x00	0x2B	0x00	0x02	SUM
Query Pan Position	0xFF	Address	0x00	0x51	0x00	0x00	SUM
Query Pan Position Response	0xFF	Address	0x00	0x59	Value High Byte	Value Low Byte	SUM
Query Tilt Position	0xFF	Address	0x00	0x53	0x00	0x00	SUM
Query Tilt Position Response	0xFF	Address	0x00	0x5B	Value High Byte	Value Low Byte	SUM
Query Zoom Position	0xFF	Address	0x00	0x55	0x00	0x00	SUM
Query Zoom Position Response	0xFF	Address	0x00	0x5D	Value High Byte	Value Low Byte	SUM

Pelco-P Protocol Command List

Function	Byte1	Byte2	Byte3	Byte4	Byte5	Byte6	Byte7	Byte8
Up	0xA0	Address	0x00	0x08	Pan Speed	Tilt Speed	0xAF	XOR
Down	0xA0	Address	0x00	0x10	Pan Speed	Tilt Speed	0xAF	XOR
Left	0xA0	Address	0x00	0x04	Pan Speed	Tilt Speed	0xAF	XOR
Right	0xA0	Address	0x00	0x02	Pan Speed	Tilt Speed	0xAF	XOR
Zoom In	0xA0	Address	0x00	0x20	0x00	0x00	0xAF	XOR
Zoom Out	0xA0	Address	0x00	0x40	0x00	0x00	0xAF	XOR
Focus Far	0xA0	Address	0x00	0x80	0x00	0x00	0xAF	XOR
Focus Near	0xA0	Address	0x01	0x00	0x00	0x00	0xAF	XOR
Set Preset	0xA0	Address	0x00	0x03	0x00	Preset ID	0xAF	XOR
Clear Preset	0xA0	Address	0x00	0x05	0x00	Preset ID	0xAF	XOR
Call Preset	0xA0	Address	0x00	0x07	0x00	Preset ID	0xAF	XOR
Auto Focus	0xA0	Address	0x00	0x2B	0x00	0x01	0xAF	XOR
Manual Focus	0xA0	Address	0x00	0x2B	0x00	0x02	0xAF	XOR
Query Pan Position	0xA0	Address	0x00	0x51	0x00	0x00	0xAF	XOR
Query Pan Position Response	0xA0	Address	0x00	0x59	Value High Byte	Value Low Byte	0xAF	XOR
Query Tilt Position	0xA0	Address	0x00	0x53	0x00	0x00	0xAF	XOR
Query Tilt Position Response	0xA0	Address	0x00	0x5B	Value High Byte	Value Low Byte	0xAF	XOR
Query Zoom Position	0xA0	Address	0x00	0x55	0x00	0x00	0xAF	XOR
Query Zoom Position Response	0xA0	Address	0x00	0x5D	Value High Byte	Value Low Byte	0xAF	XOR

Menu Settings

1. MENU

Press [MENU] button to display the main menu on the normal screen, using arrow button to move the cursor to the item to be set. Press the [HOME] button to enter the corresponding sub-menu.

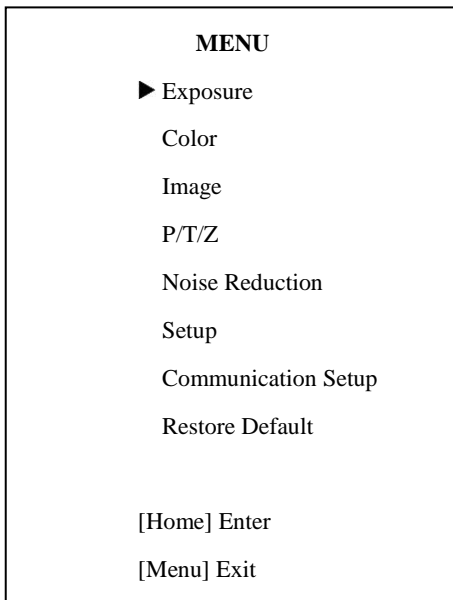

2. EXPOSURE

Move the main menu cursor to [EXPOSURE], and press [HOME] key enter the exposure page, as shown in the following figure.

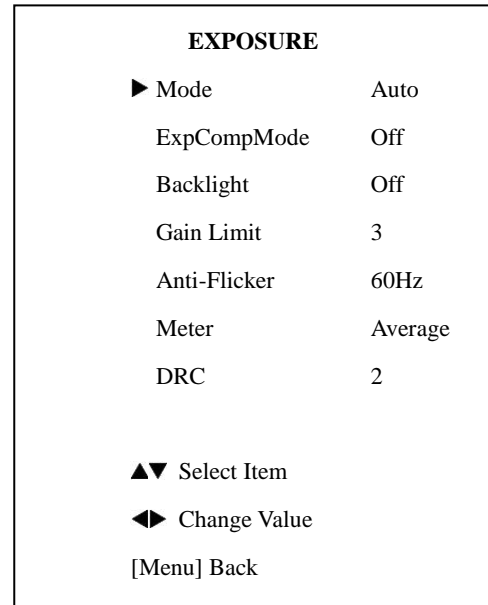

Mode: Exposure mode, optional items: Auto, Manual, SAE, AAE, Bright.

ExpCompMode: Exposure compensation mode, optional items: On, Off (Effective only in Auto mode).

ExpComp: Exposure compensation value, optional items: -7~7 (Effective only in ExpCompMode item to On).

Backlight: Set the backlight compensation, optional items: On, Off (Effective only in Auto mode).

Bright: Intensity control, optional items: 00~17 (Effective only in Bright mode).

Gain Limit: Maximum gain limit, optional items: 0 ~ 15 (Effective only in Auto, AAE, Bright mode).

Anti-Flicker: Anti-flicker, optional items: Off, 50Hz, 60Hz (Effective only in Auto, Bright mode).

Meter: optional items: Average, Center, Bottom, Top.

Iris: Aperture value, optional items: F1.8, F2.0, F2.4, F2.8, F3.4, F4.0, F4.8, F5.6, F6.8, F8.0, F9.6, F11.0, Close (Effective only in Manual, AAE mode).

Shutt: Shutter value, optional items: 1/30, 1/60, 1/90, 1/100, 1/125, 1/180, 1/250, 1/350, 1/500, 1/725, 1/1000, 1/1500, 1/2000, 1/3000, 1/4000, 1/6000, 1/10000 (Effective only in Manual, SAE mode).

DRC: DRC strength, optional items: 0 ~ 8.

3. COLOR

Move the main menu cursor to [COLOR], and press [HOME] key enter the color page, as shown in the following figure.

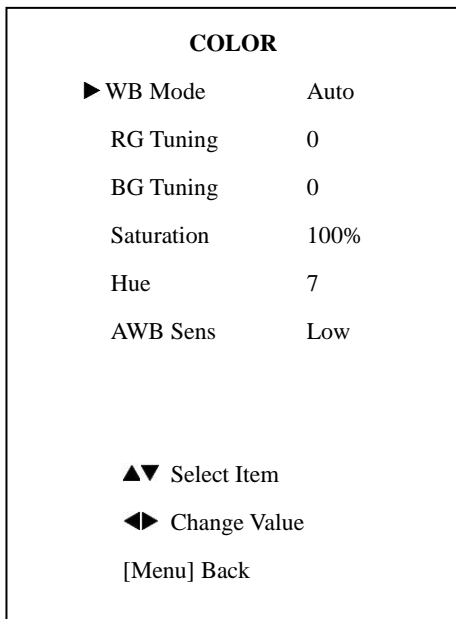

WB-Mode: White balance mode. optional items: Auto, Indoor, Outdoor, One Push, Manual, VAR.

RG: Red gain, optional items: 0~255 (Effective only in Manual mode).

BG: Blue gain, optional items: 0~255 (Effective only in Manual mode).

colortemp: Optional items: 2500K ~ 8000K (Effective only in VAR mode).

RG Tuning: Red gain fine-tuning, optional items: -10 ~ +10 (Effective only in AWB sens is Low).

BG Tuning: Blue gain fine-tuning, optional items: -10 ~ +10 (Effective only in AWB sens is Low).

Saturation: optional items: 60% ~ 200%.

Hue: Chroma adjustment, optional items: 0 ~ 14.

AWB Sens: The white balance sensitivity, optional items: Low, Normal, High.

4. IMAGE

Move the cursor to the Image item in the main menu and press [HOME] button, IMAGE menu appears, as shown in the following figure.

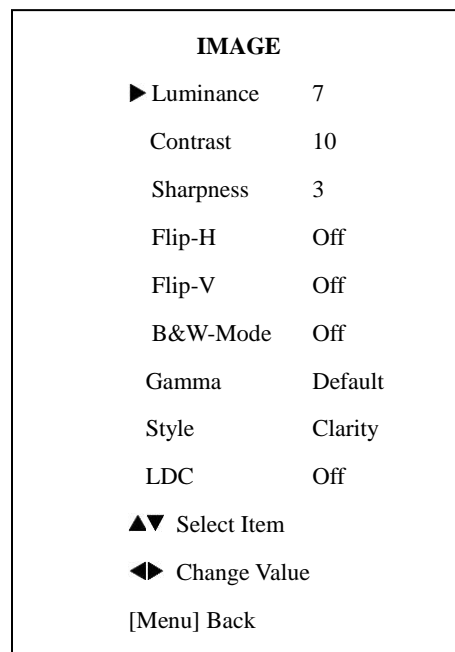

Luminance: Brightness adjustment, optional items: 0 ~ 14.

Contrast: Contrast adjustment, optional items: 0 ~ 14.

Sharpness: Sharpness adjustment, optional items: Auto, 0 ~ 15.

Flip-H: Image flipped horizontally, optional items: On, Off.

Flip-V: Image Flip Vertical, optional items: On, Off.

B&W Mode: Optional items: On, Off.

Gamma: Optional items: Default, 0.45, 0.5, 0.56, 0.63.

Style: Optional items: Norm, Clarity, Clarity (LED), Bright, Soft, 5S.

LDC: Optional items: Off, On.

5. P/T/Z

Move the main menu cursor to [P/T/Z], and press [HOME] key enter the P/T/Z page, as shown in the following figure.

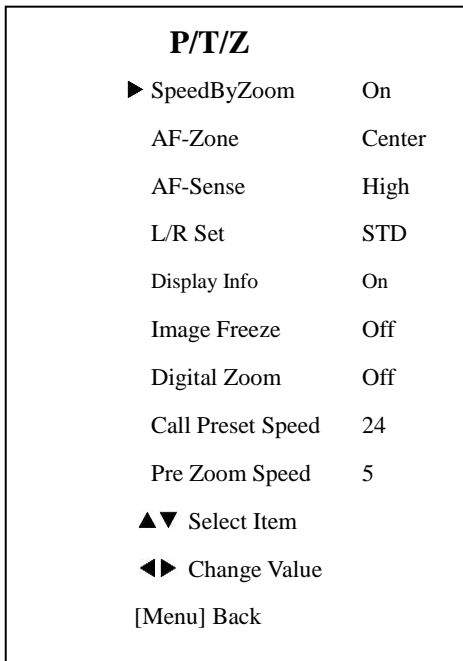

SpeedByZoom: The depth of field scale switch, optional items: On, Off.

AF-Zone: Interested in focusing area, optional items: Top, Center, Bottom.

AF-Sense: Automatic focusing sensitivity options, optional items: Low, Normal, High.

L/R Set: Optional items: STD, REV.

Display Info: Optional items: On, Off.

Image Freeze: Optional items: On, Off.

Digital Zoom: Optional items: Off, 2x, 4x, 8x, 16x.

Call Preset Speed: Optional items: 1 ~ 24.

Pre Zoom Speed: Optional items: 0 ~ 7.

6. NOISE REDUCTION

Move the main menu cursor to [NOISE REDUCTION], and press [HOME] key enter the noise reduction page, as shown in the following figure.

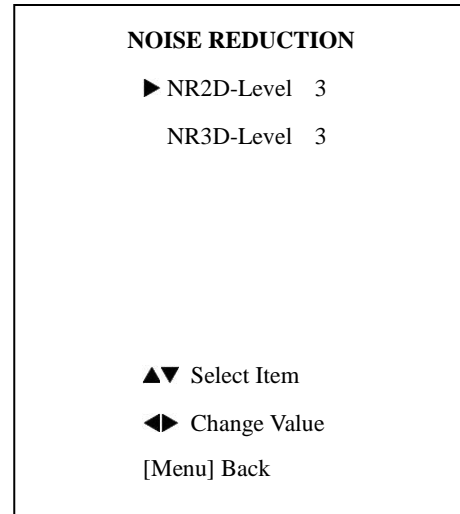

NR2D Level: 2D noise reduction, optional items: Off, Auto, 1 ~ 5.

NR3D Level: 3D noise reduction, optional items: Off, 1 ~ 8.

7. SETUP

Move the main menu cursor to [SETUP], and press [HOME] key enter the setup page, as shown in the following figure.

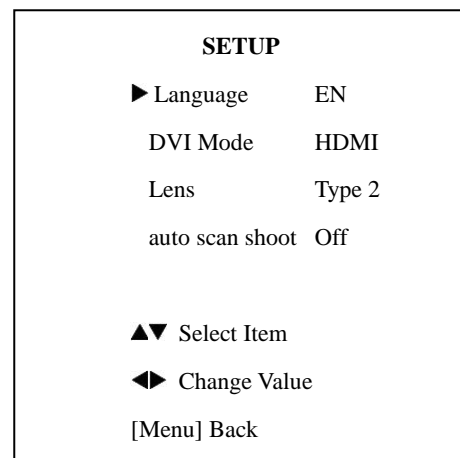

Language: Optional items: EN, Chinese, Russian.

DVI Mode: Optional items: DVI, HDMI.

Lens: Optional items: Type1, Type2.

auto scan shoot: Optional items: On, Off.

8. COMMUNICATION SETUP

Move the main menu cursor to [COMMUNICATION SETUP], and press [HOME] key enter the communication setup page, as shown in the following figure.

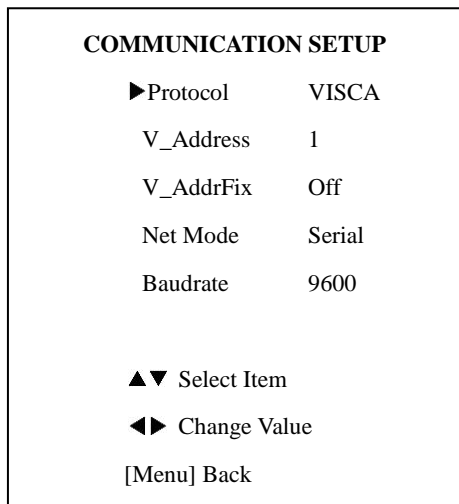

Protocol: Control protocol type, optional items: AUTO, VISCA, PELCO-D, PELCO-P.

V_Address: Optional items: 1 ~ 7.

P_D_Address: Optional items: 0 ~ 254. (Effective only in PELCO-D protocol).

P_P_Address: Optional items: 0 ~ 31. (Effective only in PELCO-P protocol).

V_AddrFix: If you can change through the serial port of infrared switch, optional items: On, Off (When set to On, useless in 88 30 01 FF Command).

Net Mode: Set the serial port control networking, optional items: Serial, Paral.

Baudrate: Serial port baud rate, optional items: 2400, 4800, 9600, 38400.

9. RESTORE DEFAULT

Move the main menu cursor to [RESTORE DEFAULT], and press [HOME] key enter the restore default page, as shown in the following figure.

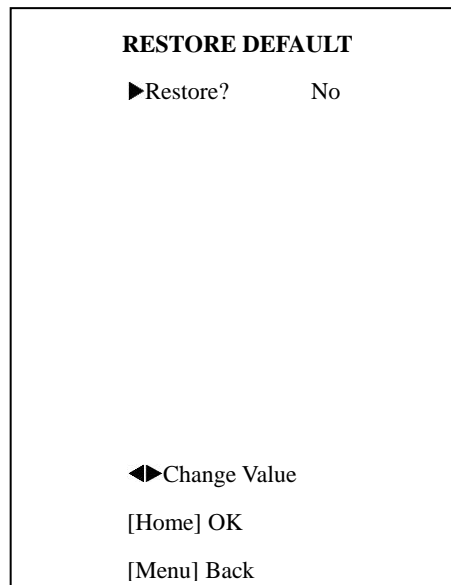

Restore: Confirm restore factory settings, optional items: Yes, No.

Note: Press [HOME] button to confirm, all parameter restore default, include IR Remote address and VISICA address.

Network Connection

1. Operating Environment

Operating System: Windows 2000/2003/XP/Vista/7/8.1/10

Network Protocol: TCP/IP

Client PC: P4/128M RAM/40GHD/ support for scaled graphics card, support for DirectX8.0 or more advanced version.

2. Equipment Installation

- 1) Connect camera to your network via a CAT5 or CAT6 patch cable or directly to your PC via a CAT5 or CAT6 cross over cable.
- 2) Turn on camera power.
- 3) If successful, the orange network light will illuminate and the green light will start flashing. If unsuccessful, the patch cable is bad, you are using the wrong cable (patch aka “straight-thru” cable for connection through a LAN; crossover for a direct PC connection) or you have connected to an inactive network jack.

3. Network Connection

Connection method between network camera and computer, as in pictures 1.1 and 1.2, below:

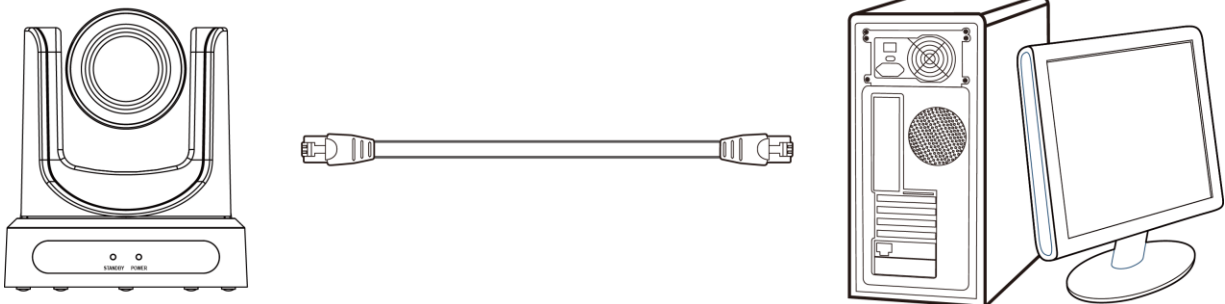

Picture 1.1 Direct connections via “cross-over” network cable

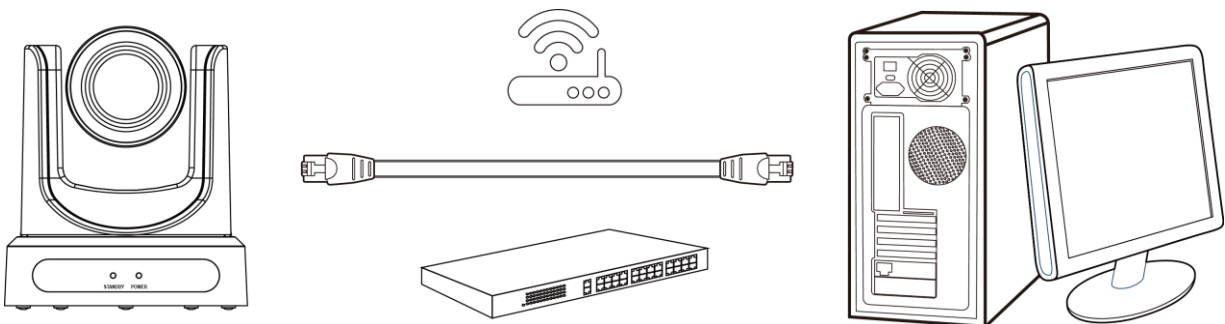

Picture 1.2 Connections to LAN via patch cable to LAN wall jack or LAN switch

Setting up a Network Video Stream with the PTZ Optics Camera

(Also see information on “Camera Web Interface” in the following section)

1. The first thing you are going to want to do to get your camera up and streaming on your network is to connect your camera to power, to an active network port on your network and finally to power the camera on.
2. Next, go online and download the IP address setting tool, for Windows Operating Systems, from the [PTZOptics Download Page](#).
3. Once you complete the installation and launch the tool “UPGRADE v2.6C” you should be able to click the “Search” button to locate all of the available PTZ Optics cameras on your network.

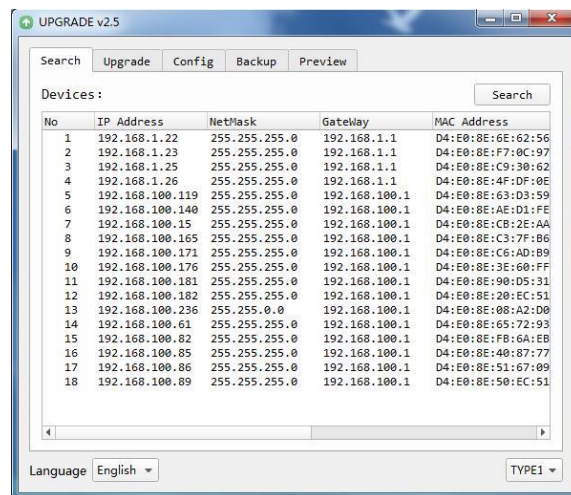

4. The next thing you would want to do is change your cameras IP address to be in the same range as your network. The camera comes with a default static IP address of 192.168.100.88. You will need to update that to be in the same range as your network. If you look at my example above, you can see, from other cameras on my network, that my network is set up to be in the range of 192.168.111.XXX. *Please see the “Extras” information at the end of this section for further information on identifying your network IP scheme*
5. Once you know your IP range you can right click on the camera you wish to change the IP address for and select “config” to enter the appropriate network information. *NOTE: if you need to find the IP range of your network, you can do so by following the guide in the “Extras” information at the end of this section.*

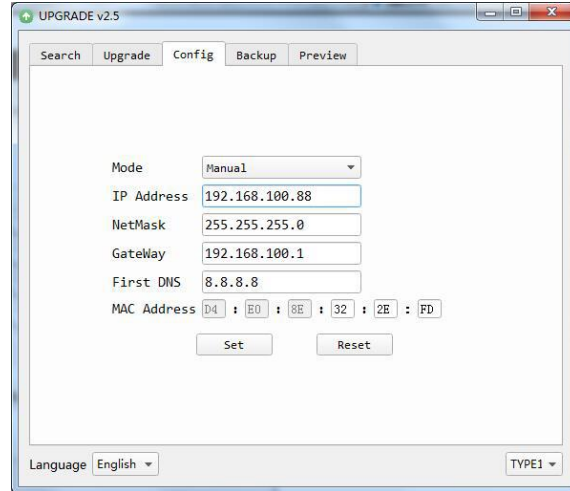

(Note that in more complex network environments you may have to request a “Static IP” from the IT department to prevent any possible network complications in addition to the “Static IP” you will likely need an appropriate Network Mask, Default Gateway and First DNS)

6. Now that you have set the Static IP address of your PTZ Optics camera, you should be able to pull up the video feed in a web browser. *We recommend using Mozilla Firefox ESR. You can view our [knowledge base article](#) for detailed setup instructions.*
7. If you follow the steps in the knowledge base article above and type in the Static IP address you assigned to your camera, in step 4, you will be prompted for a Username and Password, by default both are “admin”.
8. You may be prompted to download the VLC Player Plugin; be sure to allow for both the Mozilla plugin and the ActiveX plugin if on a PC. If you are on a MAC, you need to move the VLC plugin, once downloaded, into the internet plugins folder. See the images below, or refer to our [knowledge base article](#), for further clarification.

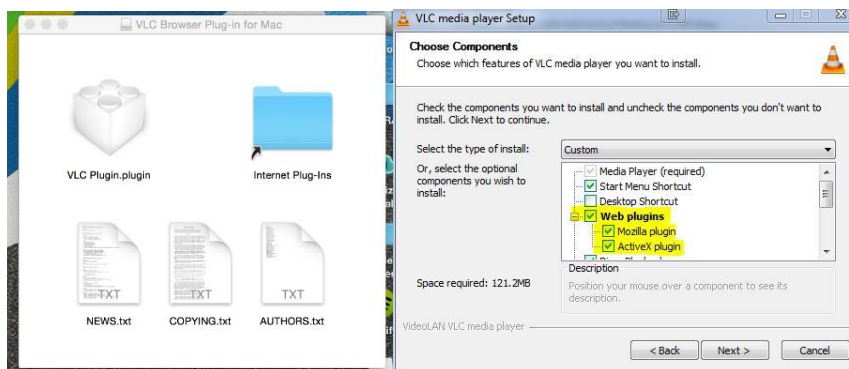

9. You should now be able to see the IP interface in the browser of your live camera feed. You should have full P/T/Z control over your camera using the P/T/Z controls on the left side. You can adjust many of your cameras settings via this IP interface.

The main thing to note about the IP interface is that all presets set in the IP interface will not be the same as the IR remote presets and vice-versa.

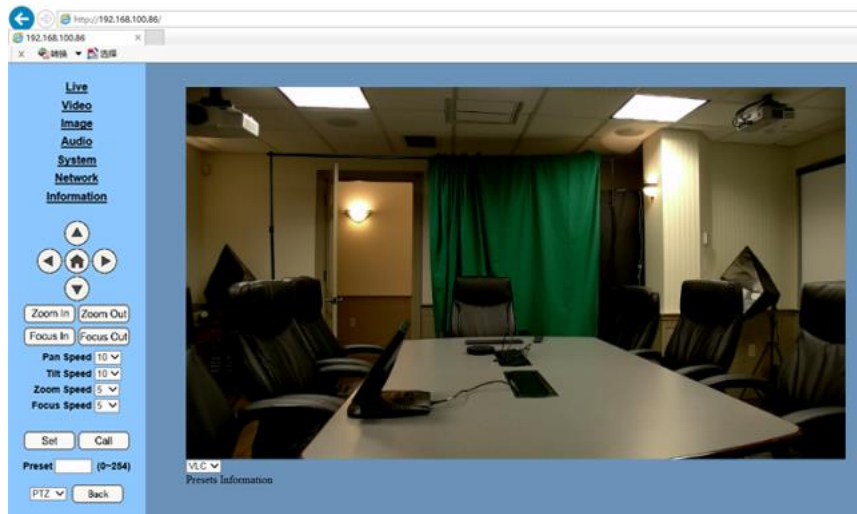

10. You should now be able to receive an RTSP stream from your camera. The following video, <https://www.youtube.com/watch?v=hmql0hjTOUI&feature=youtu.be>, shows how to setup an RTSP stream in Wirecast as an example. You'll see how to use ONVIF to easily set up two (2) PTZ Optics cameras with Wirecast, note that the ONVIF feature must be enabled in the "Network" settings for ONVIF discovery to work properly.
11. You can test the RTSP stream in VLC media player. Once you install VLC and launch the program you should be able to go to the "Media" drop down menu and then select "Open Network Stream". In the network URL, you should enter "rtsp://<camera-ip-address>:554/1". In the example below, for a PTZ Optics camera with the static IP address of 192.168.111.84, the RTSP stream would accessed by entering rtsp://192.168.111.84:554/1. The "554" part is the port number used by the cameras, and the "1" is the stream number. (There are two RTSP network streams available; one for HD content "1" and one for SD content "2").

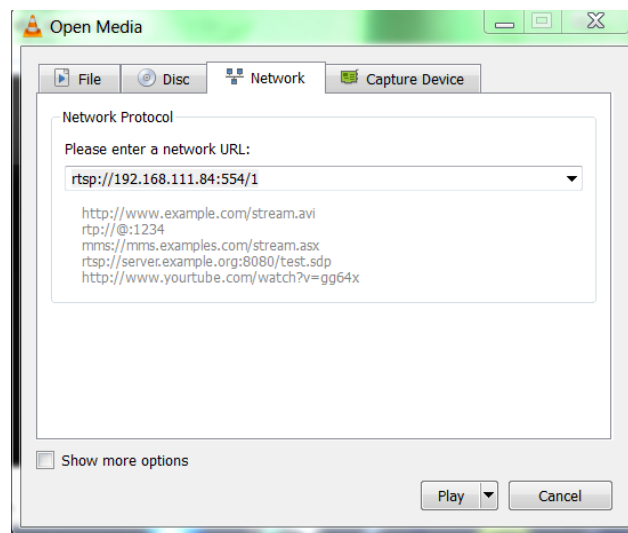

EXTRAS

Discovering your Network IP range. *NOTE: Changing your IP address without talking to your network admin could lead to conflicts with your network. If you change your address to one that is already in use it will cause communication problems.*

If you need to discover the IP address range of your network you can do so by using command prompt for Windows or Terminal for Macs.

To do this on a PC, you would type “CMD” into your search bar in the Windows menu. You should see a black box pop up with the ability to type in the box.

If you type “ipconfig” and hit “Enter” on your keyboard you will see a bunch of information pop up in your command prompt.

When you see “IPV4 Address” that is your computers IP address on your current network. So you would use the first 3 sets of numbers from this as your IP range.

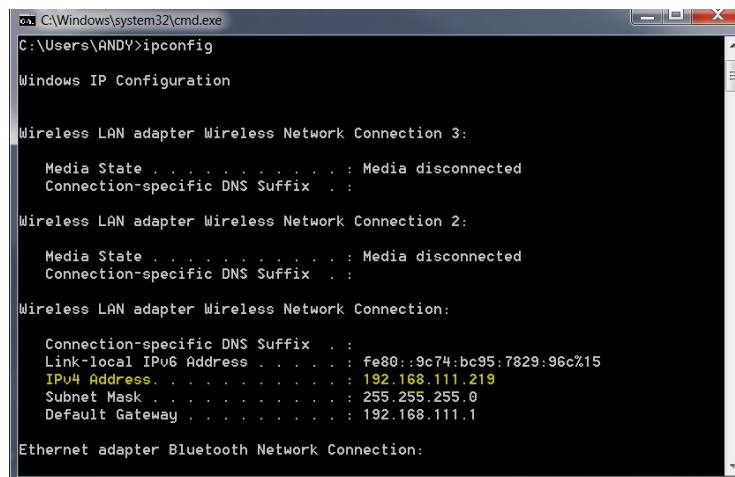

If you need to find the IP range of your MAC computer, you would first open a new finder window and then go to Applications, and then Utilities. You should see the program “Terminal” in that menu, select that program.

Now, you would type in “IP config get if addr en0” Once you type this string and click “Enter” on your keyboard you will receive back an IP address.

So the IP range of my network, according to my MAC is 192.168.111.xxx, you can use this to figure out the IP range in which your camera needs to be set.

```
Blackmagic EPSON WF-7520 S
stephaniepeters -- -bash -- 80x24
Last login: Tue Oct 27 08:24:05 on console
Stephanies-MacBook-Pro:~ stephaniepeters$ ipconfig
usage: ipconfig <command> <args>
where <command> is one of waitall, getifaddr, ifcount, getoption, getpacket, get
v6packet, set, setverbose
Stephanies-MacBook-Pro:~ stephaniepeters$ ipconfig getifaddr en0
192.168.111.112
Stephanies-MacBook-Pro:~ stephaniepeters$
```

Camera Web Interface

1 Homepage introduction

1.1 Home Page

All pages include two (2) areas:

On the left is the menu and camera control

On the right is real time monitoring - displaying a live video image and the available settings

1.2 Live Video viewing window

Click “**Live**” in the menu area. The video viewing window will be resized based upon video resolution, the higher the resolution is, the bigger the playing area is. Double click the viewing window and it will show in full-screen.

Double click again, and it will return to the initial size.

The Status bar in the viewing window is as shown below:

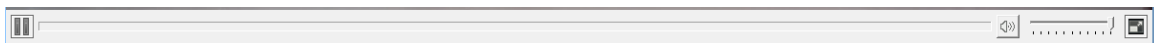

- 1) Video playback/pause button: controls real-time video. Pause to freeze the image, play to return to live video.
- 2) Audio control buttons: Mute and Volume controls for audio input on camera, if being used.
- 3) Full screen button will switch between Full Screen and Windowed view.

1.3 PTZ Control

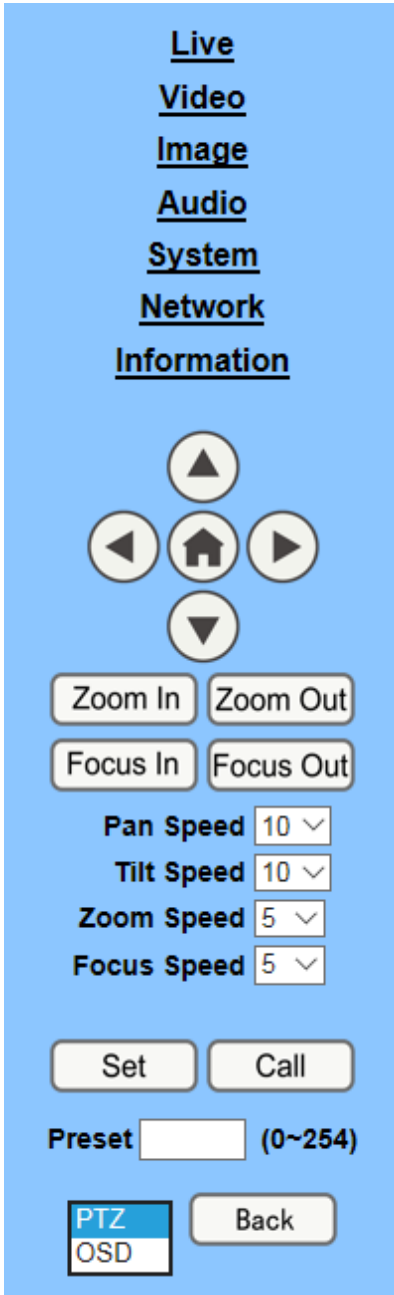

- 1) Pan and Tilt control: Up, Down, Left and Right arrows and the home button allow you to manually drive the camera to the desired position.
- 2) Zoom: Zoom In and Zoom Out buttons allow for wide or narrow (tele) view of the space.
- 3) Focus: Focus In and Focus Out buttons allow for fine manual focus adjustment if the camera has any problems auto focusing on a difficult object.
- 4) PTZ Speeds: Pan speed can be set at any rate between 1 - 24, Tilt speed can be set at any rate between 1 - 20. Zoom and Focus speeds can be set at any rate between 0 – 7.
- 5) PTZ Presets: After manually setting up a shot that you would like to return to later, you can save presets for quick recall of these positions. Type a number between 0 and 254 into the Preset box. Click the "Set" button to save the current location with that preset number. Click the "Call" button to cause the camera to return to that position. This enables smooth, quick and convenient control without the need to manually drive the camera.
- 6) PTZ/OSD dropdown: From the dropdown menu, clicking the OSD option will open the on-screen display menu of the camera giving you control from within the IP interface.

1.4 Language selection

Language English ▾

Click either “Russian”, “Chinese” or “English” to change the language of the menu.

1 Media

1.1 Video Setup

Click "Video". The streaming parameters may now be set in the right side area. The camera can send two (2) simultaneous streams. For example, you can send one stream in HD and one in SD so that both PCs and phones may have their own compatible stream resolution.

Video Settings

720p120: On Off

Video Format: Dial Priority ▾

Encode Level: mainprofile ▾

NDI Mode: Off ▾

First stream

Encode Protocol: H264 ▾

Resolution: 1920x1080 ▾

Bit Rate: 4096 (32~20480) kbps

Frame Rate: 30 ▾ fps

I Key Frame Interval: 30 (2~150)

Bit Rate Control: CBR VBR

Fluctuate Level: 1 ▾

Slice Split Enable: On Off

Split Mode: Fixed blocks Fixed bytes

Slice Size: 68 blocks/bytes

Second stream

Encode Protocol: H264 ▾

Resolution: 320x240 ▾

Bit Rate: 1024 (32~6144) kbps

Frame Rate: 30 ▾ fps

I Key Frame Interval: 30 (2~150)

Bit Rate Control: CBR VBR

Fluctuate Level: 1 ▾

Slice Split Enable: On Off

Split Mode: Fixed blocks Fixed bytes

Slice Size: 15 blocks/bytes

Apply Cancel

1) 720p120

Turn On/Off 720p120 function.

2) Video Format

Support 50HZ (PAL) and 60HZ (NTSC), and Dial Priority three formats.

3) Encode Level

Support baseline, mainprofile, highprofile and svc-t four levels.

4) NDI Mode

Support Off, High, Medium and Low four mode.

5) Encode Protocol

Support H.264, H.265 and MJPEG three formats.

6) Resolution

First stream support 1920x1080, 1280x720, 1024x576, 960x540, 640x480, 640x360, second stream support 1280x720, 1024x576, 720x576, 720x408, 640x360, 480x270, 320x240, 320x180, the bigger resolution is, the clearer the image will be, more network bandwidth will be taken.

7) Bit Rate

User can assign bit flow/stream, normally speaking, the bigger bit flow is, the clearer the image will be. The bit allocation must combine with network bandwidth, when the network bandwidth is too narrow and the allocated bit flow is too big, will cause video signal flow not to be transmitted normally, the video effect will be worse.

8) Frame Rate

User can specify the size of the frame rate, generally, the frame rate greater, the image more smooth; Frame rate is smaller, the more sense of beating.

9) I Key Frame Interval

Set interval between 2 I frame, the bigger interval is the response will be lower from viewing window.

10) Bit Rate Control

Code stream control way:

Constant bit rate: video coder will be coding according to preset speed.

Variable bit rate: video coder will adjust the speed based on preset speed to gain the best image quality.

11) Fluctuate Level

Restrain the fluctuation magnitude of variable rate, grade 1 ~ 6.

12) Slice Split Enable

Enable or disable slice split function.

13) Split Mode

Select split mode, optional items: Fixed blocks, Fixed bytes.

14) Slice Size

Set the size of slice.

1.2 Image Setup *(Note that changes here will impact your OSD settings)*

Click “Image”. The image parameters may now be set in the right-side area.



1) Brightness

Image bright 0~14, slider control, on the right shows the corresponding numerical. Default value is 7.

2) Saturation

Saturation 0~14, slider control, on the right shows the corresponding numerical. Default value is 4.

3) Contrast

Contrast 0~14, slider control, on the right shows the corresponding numerical. Default value is 9.

4) Sharpness

Sharpness 0~15, slider control, on the right shows the corresponding numerical. Default value is 2.

5) Hue

Hue 0~14, slider control, on the right shows the corresponding numerical. Default value is 7.

6) Flip & Mirror

Tick Flip to realize image upside down, tick mirror to realize image around the mirror.

Default value is not tick.

1.3 Audio Setup

Click “Audio”. The audio parameters may now be set in the right-side area.

Audio Settings

Audio Switch: On ▾

Audio Type: AAC ▾

Sample Rate: 48K ▾

Bit Rate: 96K ▾

Input Type: Line in ▾

Input Vol L : 8 (-97~30) db

Input Vol R : 8 (-97~30) db

ADTS Options: Off ▾

Apply Cancel

1) Audio Switch

Turn On/Off audio switch.

2) Audio Type

Audio type AAC.

3) Sample Rate

Sample rate 44.1 K and 48 K selectable.

4) Bit Rate

Bit rate 96k, 128k, 256k selectable.

5) Input Type

Input type line in.

6) Input VolL

The volume of the left channel.

7) Input VolR

The volume of the right channel.

8) ADTS Options

Optional items: On, Off.

1.4 System Settings

Click “System”. The system parameters may now be set in the right-side area.

The screenshot shows a system settings window with a blue background. It is divided into two sections: 'Initialize' and 'User'.
Under 'Initialize':
- 'Work Mode:' is a dropdown menu set to 'RTSP'.
- 'Reboot:' is a button labeled 'Reboot'.
Under 'User':
- 'UserName:' is a text input field containing 'admin'.
- 'Passwd:' is a password input field with five dots.
- 'Guest:' is a text input field containing 'guest'.
- 'Passwd:' is a password input field with five dots.
At the bottom right, there are two buttons: 'Apply' and 'Cancel'.

1) Work Mode

Work Mode is RTSP.

2) Reboot

Click the “Reboot” button, system restart.

3) Username and password

The user can modify the password (letters and numbers only).

1.5 Network Settings

Click “Network”. The network parameters may now be set in the right side area.

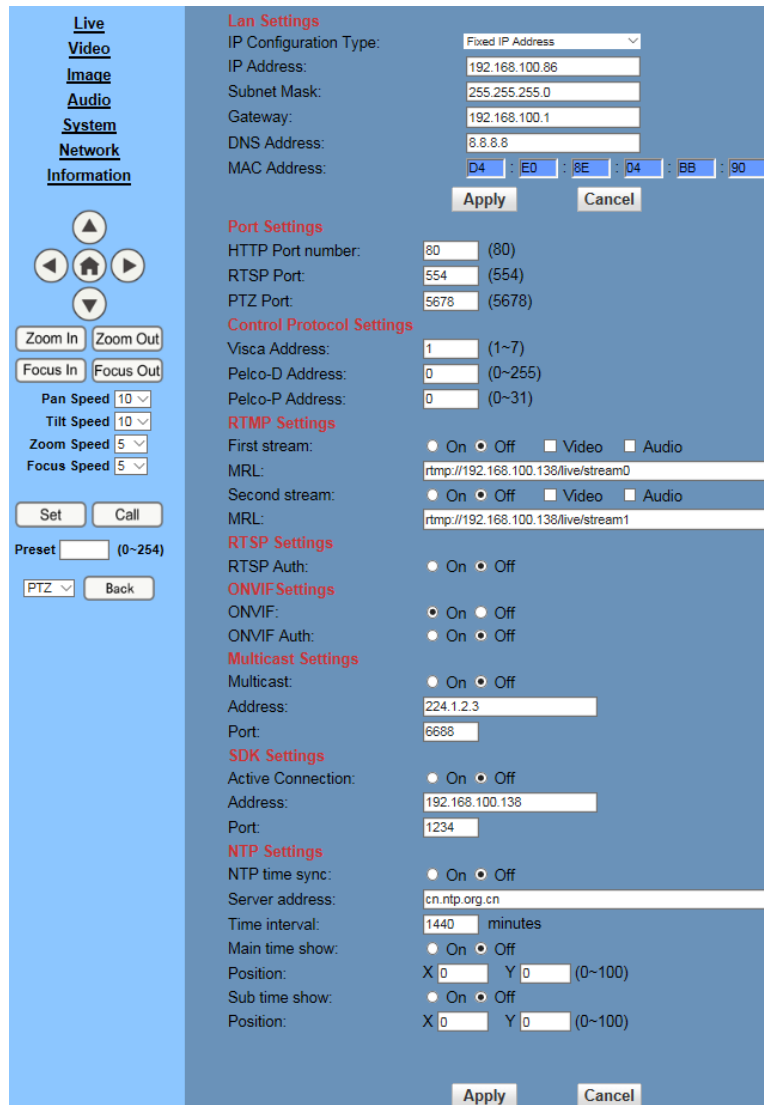

The screenshot shows the PTZ OPTICS web interface with the following sections:

- Navigation:** Live, Video, Image, Audio, System, Network, Information.
- Control Panel:** Home, Up, Down, Left, Right buttons; Zoom In/Out, Focus In/Out, Pan Speed (10), Tilt Speed (10), Zoom Speed (5), Focus Speed (5), Set, Call, Preset (0-254), PTZ, Back.
- Lan Settings:** IP Configuration Type (Fixed IP Address), IP Address (192.168.100.86), Subnet Mask (255.255.255.0), Gateway (192.168.100.1), DNS Address (8.8.8.8), MAC Address (D4 : E0 : 8E : 04 : BB : 90).
- Port Settings:** HTTP Port number (80), RTSP Port (554), PTZ Port (5678).
- Control Protocol Settings:** Visca Address (1), Pelco-D Address (0), Pelco-P Address (0).
- RTMP Settings:** First stream (On), Second stream (On).
- RTSP Settings:** RTSP Auth (On).
- ONVIF Settings:** ONVIF (On), ONVIF Auth (On).
- Multicast Settings:** Multicast (On), Address (224.1.2.3), Port (6688).
- SDK Settings:** Active Connection (On), Address (192.168.100.138), Port (1234).
- NTP Settings:** NTP time sync (On), Server address (cn.ntp.org.cn), Time interval (1440 minutes), Main time show (On), Sub time show (On).

1) Lan Settings

Default the IP address is 192.168.100.88. The MAC address can not be modified.

2) Port Settings

While the IP address identifies the device, the camera uses multiple ports for different functions.

HTTP Port: This is the port for the web application (the default http port: 80)

RTSP Port: The camera supports the RTSP streaming protocol. The default port: 554.

PTZ Port: Supports camera control via the TCP protocol. The default port: 5678.

3) Control Protocol Settings

Setting camera control communication protocol, include Visca address, Pelco-D address and Pelco-P address.

4) RTMP Settings

Setting the camera stream, can set up two stream, in the two stream selection control code stream of “On”, “Off”, “Video”, “Audio”, etc.

5) RTSP Settings

Turn On/Off RTSP auth.

6) ONVIF Settings

Turn On/Off ONVIF and ONVIF auth.

7) Multicast Settings

Turn On/Off multicast. Setting multicast address (default value is 224.1.2.3) and port (default value is 6688).

8) SDK Settings

Turn On/Off active connection. Setting SDK address (default value is 192.168.100.138) and port (default value is 1234).

9) NTP Settings

Turn On/Off NTP time sync, main time show and sub time show. Setting NTP server address, time interval, main stream position and sub stream position.

1.6 Device Information

Click “Information”

Shows the current device information, as shown below. You may change the device ID as required for your application. Note that the Device ID is the friendly name used by NDI™ to identify your camera.

The screenshot shows a blue dialog box titled "Information" with the following fields and values:

Device ID:	PTZOpticsCamera
Software Version:	SOC v6.2.40 - ARM v6.3.09SHI
Device Type:	F5.HI
Webware Version:	v1.5.4

At the bottom of the dialog box are two buttons: "Apply" and "Cancel".

NDI | HX™ Setup Guide

This process will walk you through setting up your PTZ Optics G2 PTZ camera as an NDI | HX™ source. *Please read all instructions prior to attempting your NDI | HX™ camera upgrade. If you have purchased a NDI™ model, not an NDI-Ready model, please note that it will not require the licensing portion of this section. Please note that a Windows PC is required to complete the upgrade process.*

Three Easy Steps:

1. Install the latest NDI | HX™ driver
2. Update camera firmware
3. Enter your NDI | HX™ license

Step 1:

- Download and install the NDI | HX™ driver <http://new.tk/NDIHX-Driver-Win>
Please note this will also install the NewTek™ NDI Studio Monitor

Step 2:

Download camera firmware & update

- Ensure both your Windows PC and camera are connected to the same local network.
- Obtain camera firmware from <https://ptzoptics.com/ndi-firmware/>
- Update camera firmware through Upgrade software available at <https://ptzoptics.com/downloads/>

Step 3:

- From your Windows PC, open NewTek™ NDI Studio Monitor and from upper-left menu select a corresponding camera, then click “Register” from bottom-right corner.
- Enter your NDI | HX™ license key & click “Enable NDI | HX™”
- Enjoy your low-latency high-quality NDI | HX™ camera

If you have additional cameras to upgrade, please repeat the steps in this installation guide as required to enable NDI | HX™. A separate NDI | HX™ license key is required for each camera.

NewTek™, NDI™, & NDI/HX™, are all registered trademarks by NewTek™

Please note that your license key is non-transferrable.

Maintenance and Troubleshooting

Camera Maintenance

- If the camera will not be used for a long time, please turn off the power switch.
- Use a soft cloth or lotion-free tissue to clean the camera body.
- Use a soft dry lint-free cloth to clean the lens. If the camera is very dirty, clean it with a diluted neutral detergent. Do not use any type of solvent or harsh detergent, which may damage the surface.

Unqualified Applications

- Do not shoot extremely bright objects for a long period of time, such as sunlight, ultra-bright light sources, etc...
- Do not operate in unstable lighting conditions, otherwise the image may flicker.
- Do not operate close to powerful electromagnetic radiation, such as TV or radio transmitters, etc...

Troubleshooting

- No image
 1. Check whether the power cord is connected, voltage is OK, POWER lamp is lit.
 2. Check whether the camera can “self-test” after startup (camera will do a brief pan-tilt tour and return to the home position, or if preset 0 is set, the camera will return to the preset 0 position).
 3. Check the BOTTOM dip switch and make sure the two dip switches are both set OFF. These switches are not used in operating mode.
 4. Check that the HDMI cable is connected correctly.
 1. If HDMI, make sure that the destination device is accessing the HDMI port that you plugged into.
 2. If SDI, make sure that the destination device is accessing the SDI port that you plugged into.
- Abnormal display of image
 1. Check setting of rotary dial on rear of camera. Be sure to use a resolution and refresh rate that is supported by your software.
- Image is shaky or vibrating.
 1. Check whether camera is mounted solidly or sitting on a steady horizontal and level surface.
 2. Check the building and any supporting furniture for vibration. Ceiling mounts are often affected by building vibration more than wall mounts.
 3. Any external vibration that is affecting the camera will be more apparent when in tele zoom (zoomed in) settings.

Control

- IR remote controller does not control the camera
 1. Does one of the 4 “Camera Select” buttons (top row of remote) light up when you press any button on the remote?
If not, change the batteries in the remote.
 2. Are the camera and remote set to the same IR address? You can use press [*] + [#] + [1] (3 buttons in sequence) on the remote to set the camera to address 1. Press “Camera Select” 1 on the remote to control the camera.
 3. Try removing other sources of IR interference (e.g. sunlight, fluorescent lighting).
- Serial communication does not control the camera
 1. Make sure the camera is on and functioning with the IR remote control.
 2. Verify that the RS232 cable is connected correctly and using the proper pinout.
 3. Verify the communication settings of the control software or device (e.g. joystick).
 4. Verify that the communication port on the controlling device is activated (e.g. Com port on PC).
 5. Verify that all communication settings in the OSD Setup Menu correlate to the commands being used (e.g. VISCA address).

Copyright Notice

The entire contents of this manual, whose copyright belongs to PTZ Optics, may not be cloned, copied or translated in any way without the explicit permission of the company. Product specifications and information referred to in this document are for reference only and as such are subject to updating at any time without prior notice.