



USER MANUAL

VERSION: V1.0.5

PR01-0808

Precis 8x8 HDMI 4K60 with 4 HDBaseT



IMPORTANT SAFETY INSTRUCTIONS

1. READ these instructions.
2. KEEP these instructions.
3. HEED all warnings.
4. FOLLOW all instructions.
5. DO NOT use this apparatus near water.
6. CLEAN ONLY with dry cloth.
7. DO NOT block any ventilation openings. Install in accordance with the manufacturer's instructions.
8. DO NOT install near any heat sources such as radiators, heat registers, stoves, or other apparatus (including amplifiers) that produce heat.
9. DO NOT defeat the safety purpose of the polarized or grounding type plug. A polarized plug has two blades with one wider than the other. A grounding type plug has two blades and a third grounding prong. The wider blade or the third prong are provided for your safety. If the provided plug does not fit into your outlet, consult an electrician for replacement of the obsolete outlet.
10. PROTECT the power cord from being walked on or pinched, particularly at plugs, convenience receptacles, and the point where they exit from the apparatus.
11. ONLY USE attachments/accessories specified by the manufacturer.
12. USE ONLY with a cart, stand, tripod, bracket, or table specified by the manufacturer, or sold with the apparatus. When a cart is used, use caution when moving the cart/apparatus combination to avoid injury from tip-over.
13. UNPLUG this apparatus during lightning storms or when unused for long periods of time.
14. REFER all servicing to qualified service personnel. Servicing is required when the apparatus has been damaged in any way, such as power-supply cord or plug is damaged, liquid has been spilled or objects have fallen into the apparatus, the apparatus has been exposed to rain or moisture, does not operate normally, or has been dropped.
15. DO NOT expose this apparatus to dripping or splashing and ensure that no objects filled with liquids, such as vases, are placed on the apparatus.
16. To completely disconnect this apparatus from the AC Mains, disconnect the power supply cord plug from the AC receptacle.
17. Where the mains plug or an appliance coupler is used as the disconnect device, the disconnect device shall remain readily operable.
18. DO NOT overload wall outlets or extension cords beyond their rated capacity as this can cause electric shock or fire.



The exclamation point, within an equilateral triangle, is intended to alert the user to the presence of important operating and maintenance (servicing) instructions in the literature accompanying the product.



The lightning flash with arrowhead symbol within an equilateral triangle is intended to alert the user to the presence of uninsulated "dangerous voltage" within the product's enclosure that may be of sufficient magnitude to constitute a risk of electrical shock to persons.



ESD Warning: The icon to the left indicates text regarding potential danger associated with the discharge of static electricity from an outside source (such as human hands) into an integrated circuit, often resulting in damage to the circuit.

WARNING: To reduce the risk of fire or electrical shock, do not expose this apparatus to rain or moisture.

WARNING: No naked flame sources - such as candles - should be placed on the product.

WARNING: Equipment shall be connected to a MAINS socket outlet with a protective earthing connection.

WARNING: To reduce the risk of electric shock, grounding of the center pin of this plug must be maintained.

COPYRIGHT NOTICE

AMX© 2018, all rights reserved. No part of this publication may be reproduced, stored in a retrieval system, or transmitted, in any form or by any means, electronic, mechanical, photocopying, recording, or otherwise, without the prior written permission of AMX. Copyright protection claimed extends to AMX hardware and software and includes all forms and matters copyrightable material and information now allowed by statutory or judicial law or herein after granted, including without limitation, material generated from the software programs which are displayed on the screen such as icons, screen display looks, etc. Reproduction or disassembly of embodied computer programs or algorithms is expressly prohibited.

LIABILITY NOTICE

No patent liability is assumed with respect to the use of information contained herein. While every precaution has been taken in the preparation of this publication, AMX assumes no responsibility for error or omissions. No liability is assumed for damages resulting from the use of the information contained herein. Further, this publication and features described herein are subject to change without notice.

AMX WARRANTY AND RETURN POLICY

The AMX Warranty and Return Policy and related documents can be viewed/downloaded at www.amx.com.

ESD WARNING



To avoid ESD (Electrostatic Discharge) damage to sensitive components, make sure you are properly grounded before touching any internal materials.

When working with any equipment manufactured with electronic devices, proper ESD grounding procedures must be followed to make sure people, products, and tools are as free of static charges as possible. Grounding straps, conductive smocks, and conductive work mats are specifically designed for this purpose. These items should not be manufactured locally, since they are generally composed of highly resistive conductive materials to safely drain static discharges, with-out increasing an electrocution risk in the event of an accident.

Anyone performing field maintenance on AMX equipment should use an appropriate ESD field service kit complete with at least a dissipative work mat with a ground cord and a UL listed adjustable wrist strap with another ground cord.



CAUTION

RISK OF ELECTRIC SHOCK
DO NOT OPEN



WARNING: Do Not Open! Risk of Electrical Shock. Voltages in this equipment are hazardous to life. No user-serviceable parts inside. Refer all servicing to qualified service personnel.

Place the equipment near a main power supply outlet and make sure that you can easily access the power breaker switch.

WARNING: This product is intended to be operated ONLY from the voltages listed on the back panel or the recommended, or included, power supply of the product. Operation from other voltages other than those indicated may cause irreversible damage to the product and void the products warranty. The use of AC Plug Adapters is cautioned because it can allow the product to be plugged into voltages in which the product was not designed to operate. If the product is equipped with a detachable power cord, use only the type provided with your product or by your local distributor and/or retailer. If you are unsure of the correct operational voltage, please contact your local distributor and/or retailer.

FCC AND CANADA EMC COMPLIANCE INFORMATION:

This device complies with part 15 of the FCC Rules.

Operation is subject to the following two conditions:

(1) This device may not cause harmful interference, and (2) this device must accept any interference received, including interference that may cause undesired operation.

NOTE: This equipment has been tested and found to comply with the limits for a Class A digital device, pursuant to part 15 of the FCC Rules. These limits are designed to provide reasonable protection against harmful interference in a commercial environment. This equipment generates, uses and can radiate radio frequency energy and, if not installed and used in accordance with the instructions, may cause harmful interference to radio communications. However, there is no guarantee that interference will not occur in a particular installation. If this equipment does cause harmful interference to radio or television reception, which can be determined by turning the equipment off and on, the user is encouraged to try to correct the interference by one or more of the following measures:

- Reorient or relocate the receiving antenna.
- Increase the separation between the equipment and receiver.
- Connect the equipment into an outlet on a circuit different from that to which the receiver is connected.
- Consult the dealer or an experienced radio/TV technician for help.

Approved under the verification provision of FCC Part 15 as a Class A Digital Device. Caution

Changes or modifications not expressly approved by the manufacturer could void the user's authority to operate this device. CAN ICES-3 (B)/NMB-3(B)

EU COMPLIANCE INFORMATION:

Eligible to bear the CE mark; Conforms to European Union Low Voltage Directive 2006/95/EC; European Union EMC Directive 2004/108/EC; European Union Restriction of Hazardous Substances Recast (RoHS2) Directive 2011/65/EU; European Union WEEE (recast) Directive 2012/19/EU; European Union Radio and Telecommunications Terminal Equipment (R&TTE) Directive 1999/5/EC

WEEE NOTICE:



This appliance is labeled in accordance with European Directive 2012/19/EU concerning waste of electrical and electronic equipment (WEEE). This label indicates that this product should not be disposed of with household waste. It should be deposited at an appropriate facility to enable recovery and recycling.

Table of Contents

IMPORTANT SAFETY INSTRUCTIONS	2
Overview	6
Features	6
Package Contents.....	6
Specifications	7
Front Panel Description	10
Rear Panel Description	11
Installation and Wiring	12
Brackets Installation	12
Wiring.....	12
Front Panel Control.....	14
Remote Control	15
System Code Switch.....	16
EDID Management	17
Instruction to Smart EDID Function	17
Copy EDID of the Output Port	18
RS232 Operation	19
RS232 Pass Through.....	19
RS232 Control	20
NetLinx Programming	21
Device Number and Ports.....	21
Telnet Control via NetLinx Studio	23
Web UI Control via NetLinx Studio	24
Web UI Control.....	25
Identify the IP address of the PR01-0808	25
Access the Web Interface	25
Web Interface Introduction	26
Firmware Upgrade	33
Before Starting	33
Transferring KIT Files.....	33
Troubleshooting.....	34
Appendix: API Command List Instructions.....	35
NetLinx Control Commands	35
Telnet/SSH Control Commands.....	40

Overview

The PR01-0808 is an 8x8 HDMI Matrix with HDMI 2.0 and HDCP 2.2 compatibility. There are 8 HDMI inputs and 8 HDMI outputs. 4 of the HDMI outputs have mirrored HDBaseT outputs.

The PR01-0808 features 8 analog L/R outputs of de-embedded audio from the 8 HDMI outputs.

The PR01-0808 can be controlled from panel buttons, as well as IR, RS232, Web GUI and NetLinx. DIP switches are provided for manual EDID adjustment.

As a compact 1U stand-alone 8x8 HDMI matrix, the PR01-0808 offers the convenience of a future-ready Ultra HD A/V switching and distribution solution.

Features

- HDMI Inputs and Outputs support up to 4K@60Hz 4:4:4 8bit
- HDBT Outputs support up to 4K@60Hz 4:2:0 8bit
- HDBT transmits 4K@30 4:4:4 signals up to 80m/262 ft, 1080P signal up to 100m/328ft via Shielded Cat 6a/7 cable
- Fully compliant with HDMI2.0
- HDCP 2.2 compliant
- Supports 4K HDR
- Supports audio de-embedding for each HDMI output
- HDBT mirror HDMI OUT 1~4
- Independent DIP switch for advanced EDID management.
- Supports PoE (PSE) function for HDBT.
- Supports fast switching when working with SCL-1 and PR01-RX

Package Contents

- 1 x PR01-0808
- 1 x US AC Power Cord
- 1 x UK AC Power Cord
- 1 x EU AC Power Cord
- 1 x IR Remote
- 4 x Broadband IR Receiver Cable (30 – 50 KHz)
- 1 x IR Receiver Cable
- 12 x Phoenix Male Connectors (3.5mm, 3 Pins)
- 2 x Mounting Bracket (with screws)

Specifications

Technical	
Input	8 x HDMI IN
Input Resolution Supported	<p>1280 x 1024 @ 75 Hz 1152 x 870 @ 75 Hz 1024 x 768 @ 60 Hz, 70 Hz, 75 Hz, 87 Hz 832 x 624 @ 75 Hz 800 x 600 @ 56 Hz, 60 Hz, 72 Hz, 75 Hz 720 x 400 @ 70 Hz, 88 Hz 640 x 480 @ 60 Hz, 67 Hz, 72 Hz, 75 Hz</p> <p>CEA Video Information Code (VIC) Formats: VIC = 1, 640 x 480p 59.94/60 Hz 4:3 VIC = 2, 720 x 480p 59.94/60 Hz 4:3 VIC = 3, 720 x 480p 59.94/60 Hz 16:9 VIC = 4, 1280 x 720p 59.94/60 Hz 16:9 VIC = 5, 1920 x 1080i 59.94/60 Hz 16:9 VIC = 6, 720(1440) x 480i 59.94/60 Hz 4:3 VIC = 7, 720(1440) x 480i 59.94/60 Hz 16:9 VIC = 14, 1440 x 480p 59.94/60 Hz 4:3 VIC = 15, 1440 x 480p 59.94/60 Hz 16:9 VIC = 16, Native 1920 x 1080p 59.94/60 Hz 16:9 VIC = 17, 720 x 576p 50 Hz 4:3 VIC = 18, 720 x 576p 50 Hz 16:9 VIC = 19, 1280 x 720p 50 Hz 16:9 VIC = 20, 1920 x 1080i 50 Hz 16:9 VIC = 21, 720(1440) x 576i 50 Hz 4:3 VIC = 22, 720(1440) x 576i 50 Hz 16:9 VIC = 29, 1440 x 576p 50 Hz 4:3 VIC = 30, 1440 x 576p 50 Hz 16:9 VIC = 31, 1920 x 1080p 50 Hz 16:9 VIC = 32, 1920 x 1080p 23.97/24 Hz 16:9 VIC = 33, 1920 x 1080p 25 Hz 16:9 VIC = 34, 1920 x 1080p 29.97/30 Hz 16:9 VIC = 39, 1920 x 1080i 50 Hz 16:9 VIC = 41, 1280 x 720p 100 Hz 16:9 VIC = 42, 720 x 576p 100 Hz 4:3 VIC = 43, 720 x 576p 100 Hz 16:9 VIC = 44, 720(1440) x 576i 100 Hz 4:3 VIC = 45, 720(1440) x 576i 100 Hz 16:9 VIC = 47, 1280 x 720p 119.88/120 Hz 16:9 VIC = 48, 720 x 480p 119.88/120 Hz 4:3 VIC = 49, 720 x 480p 119.88/120 Hz 16:9</p> <p>720x480@60Hz (480p), 720x576@50Hz (576p), 800x600@60Hz, 848x480@60Hz, 1024x768@60Hz, 1280x720@50Hz (720p50), 1280x720@60Hz (720p60), 1280x768@60Hz, 1280x800@60Hz, 1280x960@60Hz, 1280x1024@60Hz, 1360x768@60Hz, 1366x768@60Hz, 1440x900@60Hz, 1600x900@60Hz, 1600x1200@60Hz, 1680x1050@60Hz, 1920x1080@50Hz (1080p50), 1920x1080@60Hz (1080p60), 1920x1200@60Hz, 2048x1152@60Hz, 3840x2160@24Hz, 3840x2160@25Hz, 3840x2160@30Hz</p>
Input Audio Supported	PCM 2.0
Output	8 x HDMI Out 4 x HDBT Out 8 x Audio Out

Specifications

Technical	
Output Resolutions Supported	<p>1280 x 1024 @ 75 Hz 1152 x 870 @ 75 Hz 1024 x 768 @ 60 Hz, 70 Hz, 75 Hz, 87 Hz 832 x 624 @ 75 Hz 800 x 600 @ 56 Hz, 60 Hz, 72 Hz, 75 Hz 720 x 400 @ 70 Hz, 88 Hz 640 x 480 @ 60 Hz, 67 Hz, 72 Hz, 75 Hz</p> <p>CEA Video Information Code (VIC) Formats:</p> <p>VIC = 1, 640 x 480p 59.94/60 Hz 4:3 VIC = 2, 720 x 480p 59.94/60 Hz 4:3 VIC = 3, 720 x 480p 59.94/60 Hz 16:9 VIC = 4, 1280 x 720p 59.94/60 Hz 16:9 VIC = 5, 1920 x 1080i 59.94/60 Hz 16:9 VIC = 6, 720(1440) x 480i 59.94/60 Hz 4:3 VIC = 7, 720(1440) x 480i 59.94/60 Hz 16:9 VIC = 14, 1440 x 480p 59.94/60 Hz 4:3 VIC = 15, 1440 x 480p 59.94/60 Hz 16:9 VIC = 16, Native 1920 x 1080p 59.94/60 Hz 16:9 VIC = 17, 720 x 576p 50 Hz 4:3 VIC = 18, 720 x 576p 50 Hz 16:9 VIC = 19, 1280 x 720p 50 Hz 16:9 VIC = 20, 1920 x 1080i 50 Hz 16:9 VIC = 21, 720(1440) x 576i 50 Hz 4:3 VIC = 22, 720(1440) x 576i 50 Hz 16:9 VIC = 29, 1440 x 576p 50 Hz 4:3 VIC = 30, 1440 x 576p 50 Hz 16:9 VIC = 31, 1920 x 1080p 50 Hz 16:9 VIC = 32, 1920 x 1080p 23.97/24 Hz 16:9 VIC = 33, 1920 x 1080p 25 Hz 16:9 VIC = 34, 1920 x 1080p 29.97/30 Hz 16:9 VIC = 39, 1920 x 1080i 50 Hz 16:9 VIC = 41, 1280 x 720p 100 Hz 16:9 VIC = 42, 720 x 576p 100 Hz 4:3 VIC = 43, 720 x 576p 100 Hz 16:9 VIC = 44, 720(1440) x 576i 100 Hz 4:3 VIC = 45, 720(1440) x 576i 100 Hz 16:9 VIC = 47, 1280 x 720p 119.88/120 Hz 16:9 VIC = 48, 720 x 480p 119.88/120 Hz 4:3 VIC = 49, 720 x 480p 119.88/120 Hz 16:9</p> <p>720x480@60Hz (480p), 720x576@50Hz (576p), 800x600@60Hz, 848x480@60Hz, 1024x768@60Hz, 1280x720@50Hz(720p50), 1280x720@60Hz(720p60), 1280x768@60Hz, 1280x800@60Hz, 1280x960@60Hz, 1280x1024@60Hz, 1360x768@60Hz, 1366x768@60Hz, 1440x900@60Hz, 1600x900@60Hz, 1600x1200@60Hz, 1680x1050@60Hz, 1920x1080@50Hz (1080p50), 1920x1080@60Hz (1080p60), 1920x1200@60Hz, 2048x1152@60Hz, 3840x2160@24Hz, 3840x2160@25Hz, 3840x2160@30Hz</p>
Output Audio Supported	<p>HDMI: PCM 2.0/5.1/7.1, Dolby True HD, DTS HD Master Audio Phoenix audio out: PCM 2.0</p>
Maximum Data Rate	18Gbps
Control Method	Front panel, IR, RS232, Web GUI and NetLinx

Specifications

General	
Operating Temperature	0°C to 50°C (32°F to 125.6°F)
Storage Temperature	-10°C to 60°C (14°F to 140°F)
Humidity	5% to 85%, non-condensing
Power Supply	AC 100-240V 50/60Hz
Power Consumption (Max)	97W
ESD Protection	Human-body Model: ±10kV(Air-gap discharge)/±5kV(Contact discharge)
Device Dimension (W x H x D)	440mm x 43.5mm x 320mm/ 17.32" x 1.71" x 12.60"
Product Weight	0.9kg/1.98lb
Certification	CE/FCC/ETL/PSE/RCM

Transmission Distance

Cable Type	Range	Supported Video
Shielded Cat 6a/7	100m / 328 ft	1080P@60Hz
	80m / 262 ft	4K@30 4:4:4
HDMI Output	15m/49ft	1080P@60Hz
	10m/33ft	4K@60Hz 4:2:0
	5m/16ft	4K@60Hz 4:4:4

Note: Straight-through Ethernet cable of T568B is recommended.

Front Panel Description

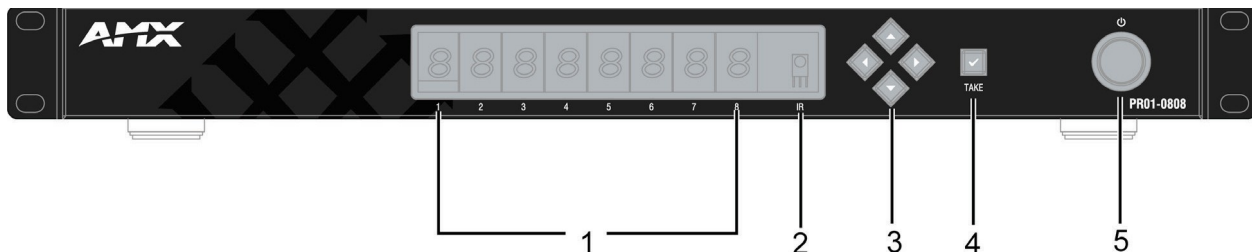

No.	Name	Description
1	Output Channel Indicator	Indicates input for output port 1~8.
2	IR	IR receive window.
3	Select buttons with LED (White)	Selects the input and output channels. Left/Right buttons are used to select outputs; UP/Down buttons are used to select inputs.
4	Enter button with LED (White)	Press Enter to initiate switching after selecting the desired inputs and outputs
5	Power Button	Turns the matrix On/Off.

Rear Panel Description

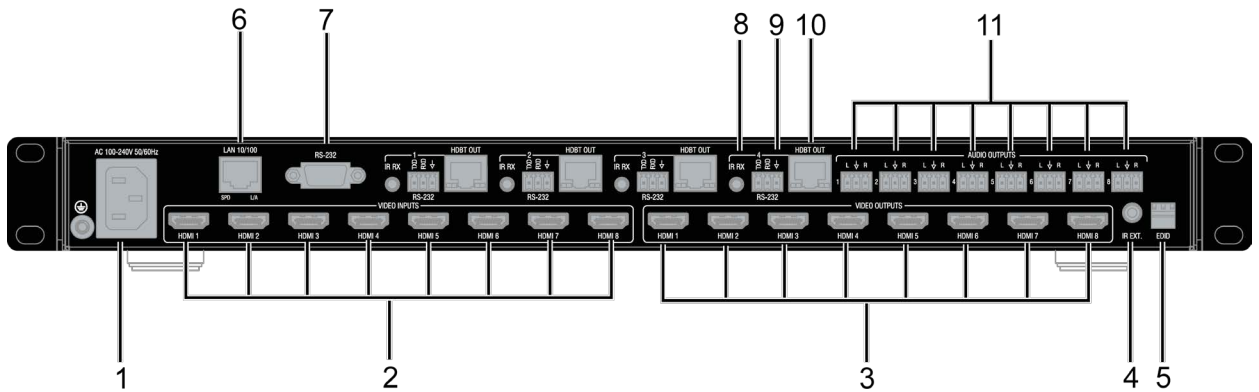

No.	Name	Description
1	AC 100~240V 50/60Hz	AC 100~240V 50/60Hz power supply input.
2	VIDEO INPUTS (HDMI 1-8)	Connect to HDMI sources.
3	VIDEO OUTPUTS (HDMI 1-8)	Connect to HDMI display devices.
4	IR EXT	IR extension port: for IR Receiver Cable.
5	EDID	DIP Switch: for EDID management.
6	LAN 10/100	Connect to network, used for Web UI, Telnet control, native NetLinX control.
7	RS232	DB9 port, connect to control system for RS232 control.
8	IR IN	Connect to IR receiver cable.
9	RS232	Connect a RS232 device for pass through.
10	HDBT OUT	Connect to Receiver device via Cat X cable.
11	AUDIO OUTPUTS	Audio de-embedded outputs: 3 Pins Phoenix female port: L/R analog audio output.

Installation and Wiring

Brackets Installation

Warning: Before installation, ensure the device is disconnected from the power source.

The PR01-0808 occupies 1U space and can be placed on a solid and stable surface or installed in a standard rack mount.

Steps to install the device in a suitable location:

1. Attach the installation bracket to the enclosure using the screws provided.
2. The bracket is attached to the enclosure as shown.

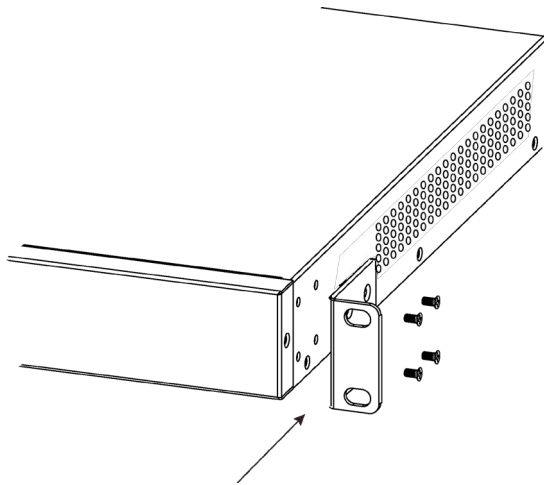

3. Repeat steps 1-2 for the other side of the unit.
4. Attach the brackets to a surface or suitable location with user supplied screws.

Wiring

Warning:

Before wiring, disconnect the power from all devices. Connecting or disconnecting cables while powered, may cause damage to circuitry or possible injury. Connect and disconnect the cables with care.

1. Using high quality HDMI cable, firmly connect 4K or HD source devices (such as: Blu-Ray, computer, games console, satellite/ cable, music streaming device, CCTV etc.) to the HDMI input ports 1-8 of the matrix.
2. Securely connect HDMI OUT 1-8 of the matrix to HDMI IN of 4K or HD display devices, make sure all sources and displays are compatible and correctly configured.
3. Securely connect AUDIO OUT 1-8 of the matrix to audio devices such as amplifier.
4. Connect an HDBT Receiver to the HDBT port via Shielded Cat 6a/7 cable.
5. Insert the matrix AC power cord and power ON the matrix by pressing the front panel power button. The front panel LEDs will show the matrix model name to indicate that the matrix is ready for operation.

Warning: Always power off the matrix before unplugging any HDMI cables following Last On, First Off protocol.

6. Switch between sources and displays using the matrix front panel buttons, via IR remote control, through serial RS232 or LAN.
7. If IR extension is required, connect the IR Receiver Cable to the matrix IR EXT port. Make sure the IR receiver eye is placed in clear view of the remote control.

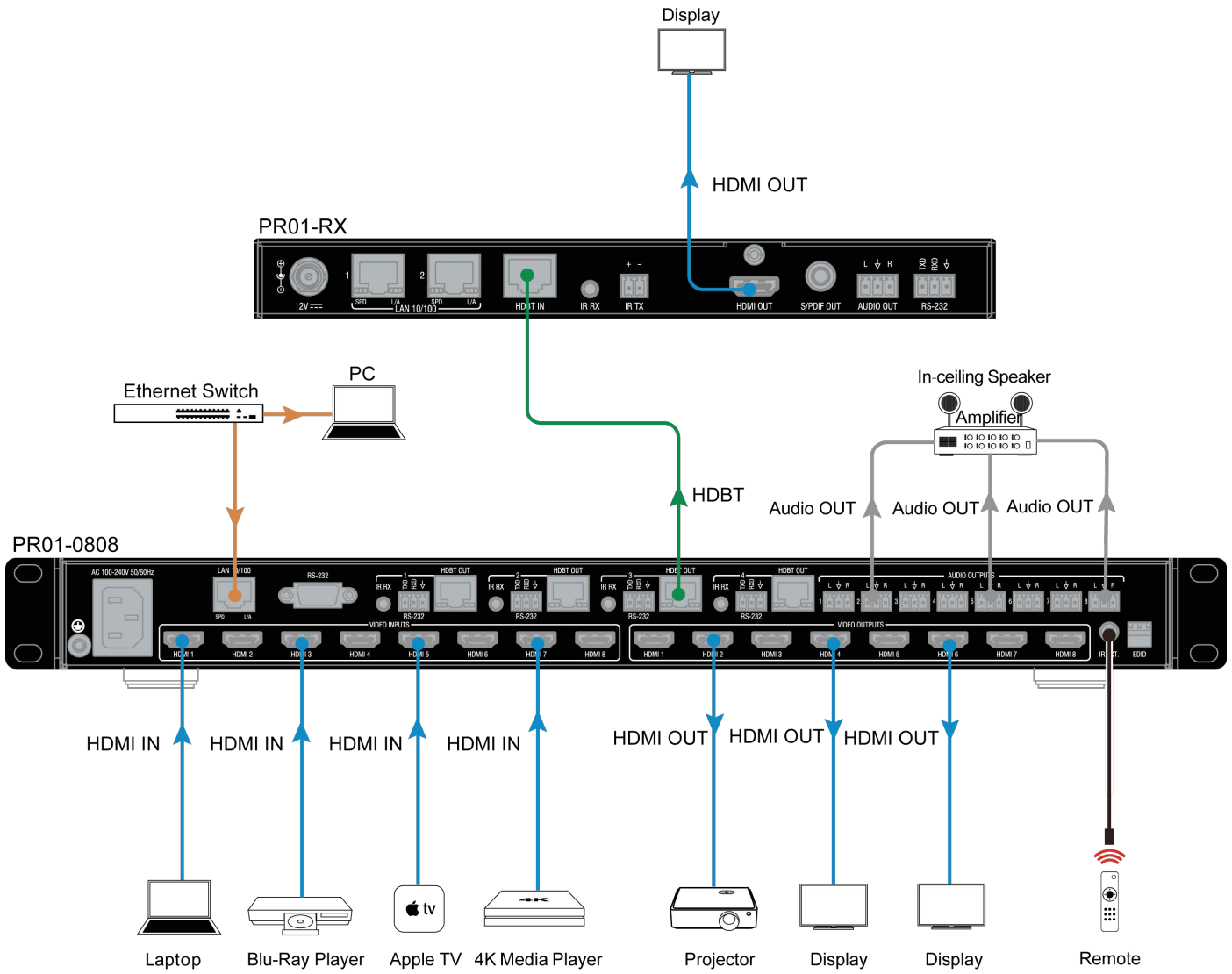

Front Panel Control

The PR01-0808 HDMI matrix is designed with ease of connection and control in mind. Basic switching of input sources to output displays can be achieved by pressing the front panel buttons with the front panel LEDs indicating the current input and output status of the matrix.

After power up, the front panel LEDs will show the matrix model name indicating the matrix is ready for operation.

Step 1. Press the **Left** or **Right** button to select output channel - the corresponding LED of the output channel will blink slowly.

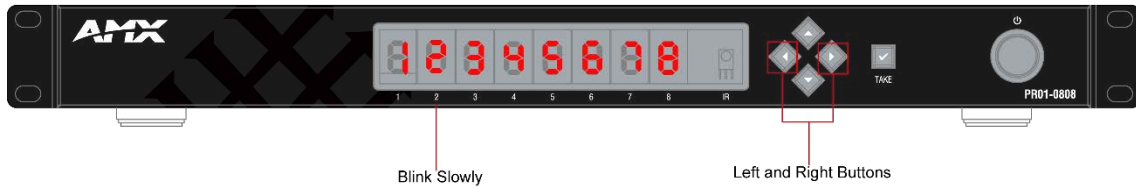

Step 2. Press the **Up** or **Down** button to select the desired input channel. When an output is turned Off, the corresponding LED will display "--".

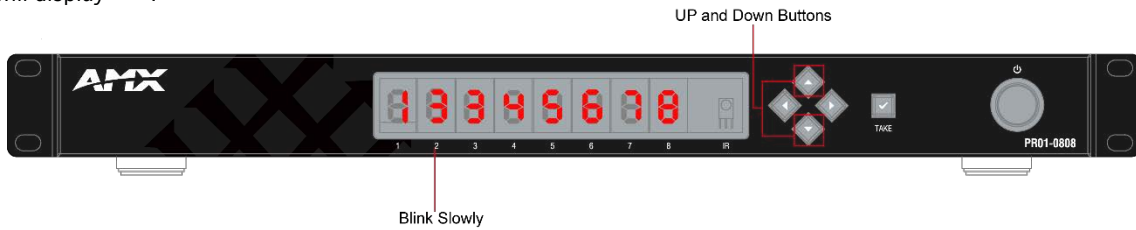

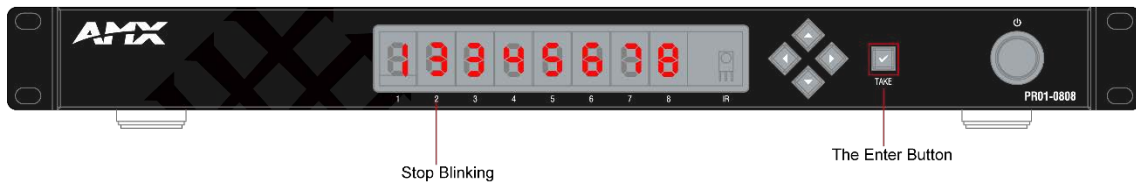

Step 3. Press the Enter button to confirm the desired selection, - the corresponding will LED stop blinking.

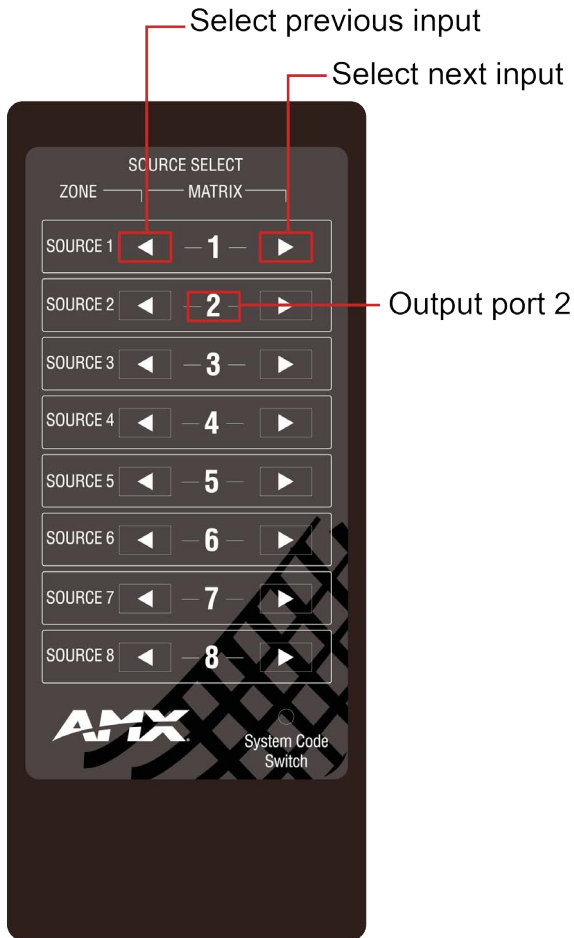

Remote Control

The HDMI matrix can also be controlled with a remote control.







Previous and Next buttons ( ):

Scrolls between the input sources.

Previous button = previous input;

Next button = next input.

When using the matrix remote, point it directly at the matrix IR receiver,   are used to scroll between the input sources for each individual output display. For example, to select output display 1 to be set to input source 2, find row 1 on the matrix control and scroll   to input source 2.

System Code Switch

In the event that the matrix remote's IR signals interfere with or are interfered with by other IR devices, such as a TV, DVD or another matrix, the matrix is capable of switching between two distinct IR system codes to isolate the matrix from interference.

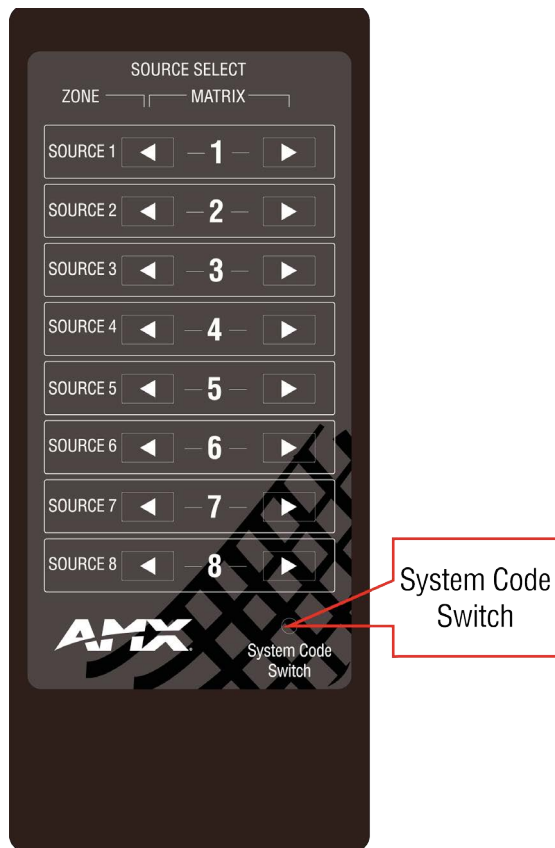

If the system codes of the matrix and remote are different, the remote cannot control the matrix. Press the **System Code Switch** button once rapidly to change the system code of the remote. This will change the remote from the default system code 00 to the alternate system code 4E.

EDID Management

EDID (Extended Display Identification Data) is a data structure provided by a digital display to describe its capabilities to a video source. The matrix features an EDID management that can be used when the EDID's do not meet the installation requirements.

Note: DIP position is default by 0 0 0, means up up up, as shown in the following picture:

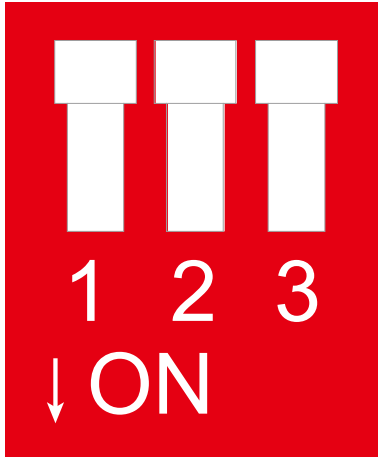

Please refer to the following schematics to set EDID:

DIP			Function
0	0	0	EDID controlled by Front Panel, Web UI and API (Default)
0	0	1	4K@30Hz/8bit only 2.0ch audio Without HDR (Smart EDID OFF)
0	1	0	4K@60Hz 2.0ch audio With HDR (Smart EDID OFF)
0	1	1	4K@30Hz 7.1ch audio With HDR (Smart EDID OFF)
1	0	0	4K@30Hz 5.1ch audio With HDR (Smart EDID OFF)
1	0	1	4K@30Hz 2.0ch audio With HDR (Smart EDID OFF)
1	1	0	1080P@60Hz 2.0ch audio (Smart EDID OFF)
1	1	1	Smart EDID ON

Instruction to Smart EDID Function

EDID management is a common feature on HDMI matrix switchers, customers can use this feature to choose the resolution they want the HDMI source to output. But some problems remain unsolved even with EDID management.

Normally, there will be 4K sources, 1080p sources, 4K displays and 1080p displays connected to the matrix, and customers will need to change the EDID frequently to adapt different selection combinations of sources and displays.

For instance, two 4K displays select one 4K source, the input EDID of the matrix should be set to 4K to make the 4K source output 4K signal to 4K displays.

Then a 1080p display is added and selects the same 4K source, the input EDID must be changed to 1080p to make the 4K source output 1080p signal, otherwise the 1080p display will show no image.

A while later, the 1080p display is removed, two 4K displays will still showing 1080p images until the input EDID change back to 4K.

To save this trouble, we add Smart EDID feature to our matrix switcher.

As we all know, the highest-resolution a display can support is written in its EDID.

- When several displays choose a same source, Smart EDID will analyze EDIDs of all displays to get the lowest highest-resolution.
- Then Smart EDID will compare this lowest highest-resolution to 5 fixed EDIDs and use the most suitable fixed EDIDs as input EDID, so the source will output video at a resolution that all displays can support.
- 5 fixed EDIDs are 4K@60Hz 4:4:4 8bit with HDR, 4K@60Hz 4:2:0 8bit with HDR, 4K@30Hz 4:4:4 8bit without HDR, 1080p and 720p

Copy EDID of the Output Port

To copy the EDID of an HDMI sink connected to the matrix's output port 1 to the input port 2, do as follows:

1. Toggle the EDID DIP switch to 000.
2. Reboot the matrix.
3. On the front panel, press the selection buttons to select the input port 2 for output port 1, then the indicator blinks.
4. Press and hold the √ (Take) button for about five seconds. When the message “CPY OK” is displayed in the LED display, it means the EDID copying is successful, otherwise, it will display “CPY FAIL”.

Note: When using web UI or front panel button to copy EDID. If copy failed, the Inputs' EDID will be replaced by [4k@30Hz/8bit only without 4:2:0 2.0ch audio without HDR] EDID.

RS232 Operation

RS232 Pass Through

RS232 Phoenix Connector Pinout

The following figure shows the RS232 female Phoenix Connector pinout. Connect with the Phoenix Male Connectors provided.

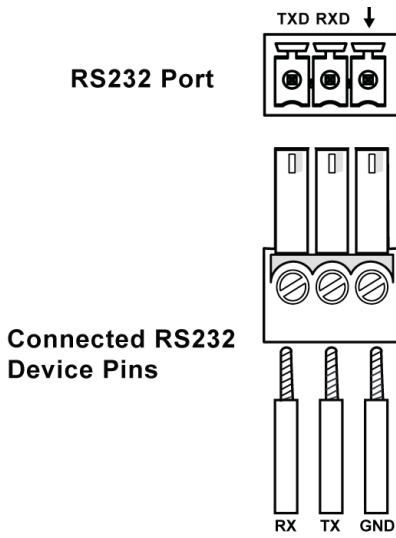

RS232 Pass Through

The RS232 phoenix female ports next to the HDBT OUT ports are used for **RS232** pass through.

To start RS232 pass-through between the PR01-0808 and a Receiver (e.g. PR01-RX):

1. Connect an RS232 Device (RS232 Device 1) to the RS232 port of the PR01-0808 using an **RS232** cable;
2. Connect another RS232 Device (RS232 Device 2) to the RS232 port of a receiver (e.g. PR01-RX) using an RS232 cable;
3. Connect **HDBT OUT** of the PR01-0808 and **HDBT IN** of the Receiver using a Shielded Cat 6a/7 cable.
4. When the connections are complete, the RS232 Device 2 can be controlled from the RS232 Device 1 and vice versa.

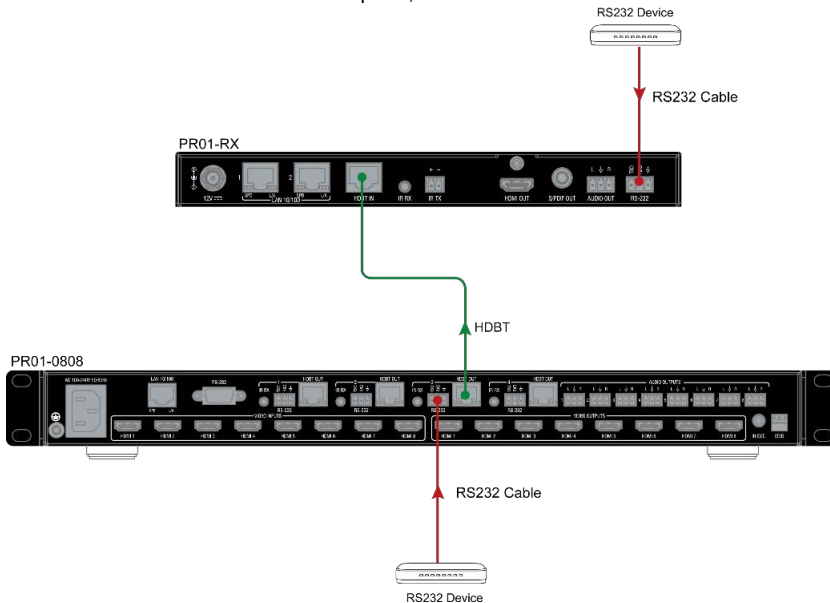

RS232 Control

RS232 DB9 Port Pinout

Pin No.	Pin name	Definition
1	-	no connection
2	TXD	data transferring
3	RXD	data receiving
4	-	no connection
5	GND	Ground
6	-	no connection
7	-	no definition
8	-	no definition
9	-	no definition

RS232 Control

RS232 DB9 port is used to control the matrix through RS232 serial communication.

Advanced users may also choose to control the matrix through RS232 serial communication. API commands for RS232 control are available in [RS232 Control Commands](#) section.

Parameters	Value
Baud Rate	9600 bps
Data Bits	8 bits
Parity	None
Stop Bits	1 bit
Flow Control	None

Command String Response Examples:

Command	Response	Explanation of Response
CI305T	CI305T	The command was successfully executed.
CI3T	CI3?	The command was not executed because the output number was not included.
CI309T	CI309X	The command was not executed because the system does not have an Output 9.

NetLinX Programming

Controlling the PR01-0808 through NetLinX studio via Ethernet port.

Before launching the NetLinX Studio, connect the PR01-0808 to RX, PC, and control system (e.g. NX-3200) to the same network.

Device Number and Ports

Each Module has its own Device Number (which is assigned when the unit is bound to a Control System) and the following ports.

- Port 1: HDMI In 1, HDMI/HDBT Out 1, Audio Out 1
- Port 2: HDMI In 2, HDMI/HDBT Out 2, Audio Out 2
- Port 3: HDMI In 3, HDMI/HDBT Out 3, Audio Out 3
- Port 4: HDMI In 4, HDMI/HDBT Out 4, Audio Out 4
- Port 5: HDMI In 5, HDMI Out 5, Audio Out 5
- Port 6: HDMI In 6, HDMI Out 6, Audio Out 6
- Port 7: HDMI In 7, HDMI Out 7, Audio Out 7
- Port 8: HDMI In 8, HDMI Out 8, Audio Out 8
- Port 10: unused
- Port 11: unused

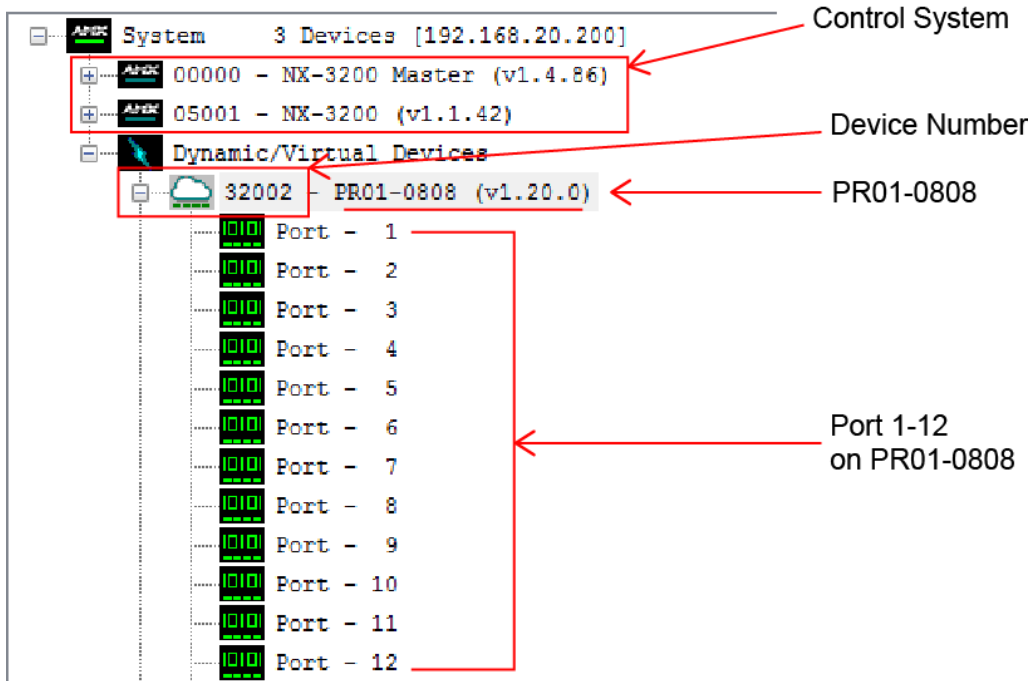

After configuring each port respectively, control commands can be sent to the chosen device. Click **"Diagnostics"** on the menu bar, choose **"Control a Device"**.

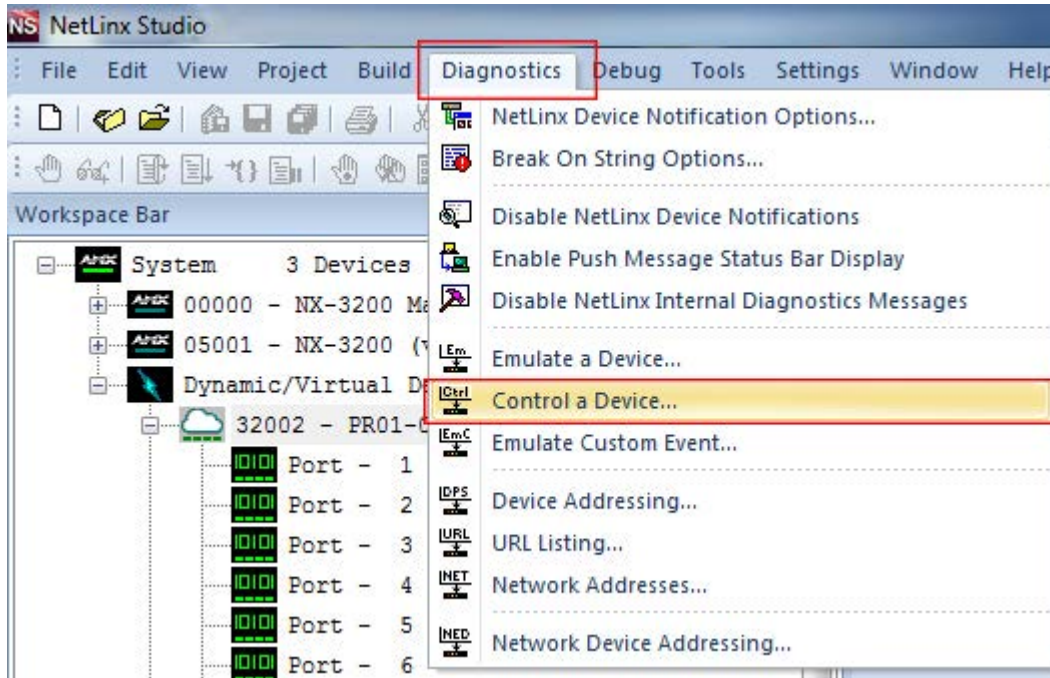

A window will display as follows, enter a command in the textbox, and click "Send To Device". (For commands, see the Section [NetLinX Control Commands](#).)

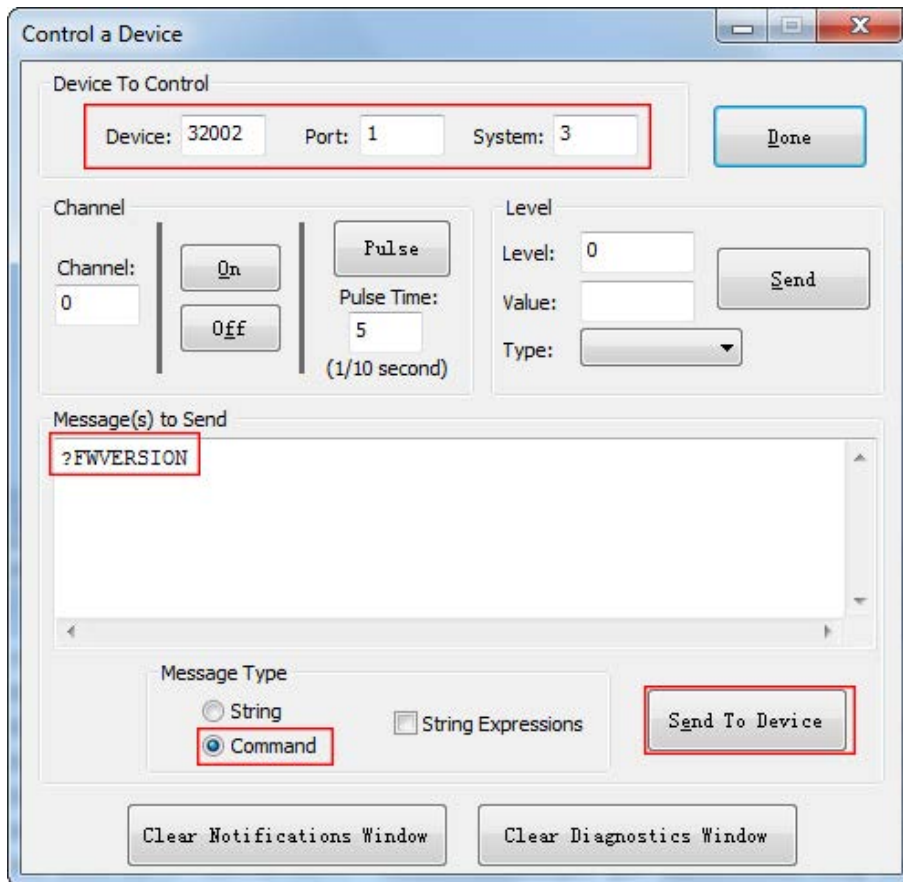

Telnet Control via NetLinx Studio

To launch Telnet Window,

1. Right click the Device Number in NetLinx Studio's Online Tree, select **"TELNET Window"** – **"Launch TELNET Window via NetLinx Studio"** (or **"Launch TELNET Window via User Defined Program"**).*
2. **Note:** For commands, see the Section [Telnet/SSH Control Commands](#).

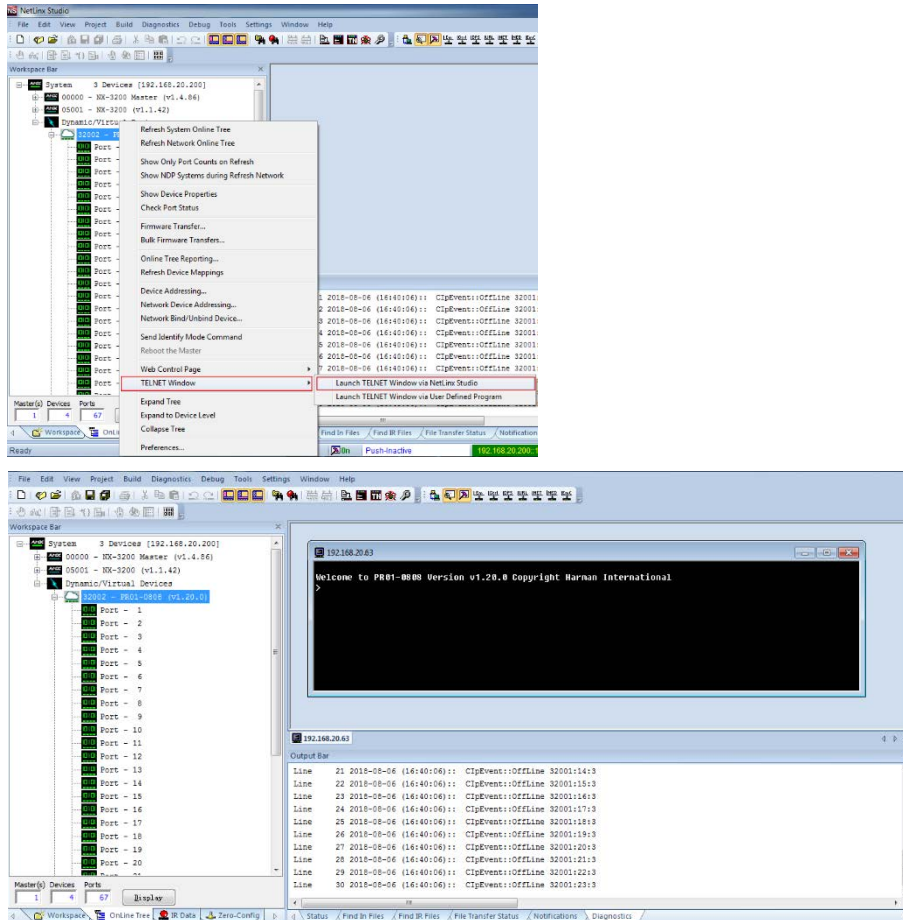

Note: To select **"Launch TELNET Window via User Defined Program"** may require additional telnet commands. Refer to the Section [Telnet/SSH Control Commands](#).

3. At the prompt (>), type the Telnet command and press Enter.

Selecting **"Launch TELNET Window via User Defined Program"**, may require enabling Telnet by completing the following:

- (1) Go to Start/Control Panel/Programs and Features;
- (2) On the left, select **"Turn Windows features on or off"**;
- (3) Select the check-boxes **Telnet Client** and **Telnet Server**, and click OK.

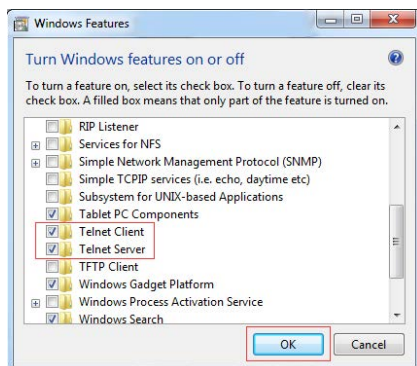

Web UI Control via NetLinx Studio

The PR01-0808 provides a web interface for changing settings and controlling the matrix. Enter the Web UI Control Page via NetLinx Studio. Choose the device you want to control, right click, then choose **Web Control Page->Launch Web Control Page via Default Browser**, add "s" after "http", enter the Web UI Control Page.

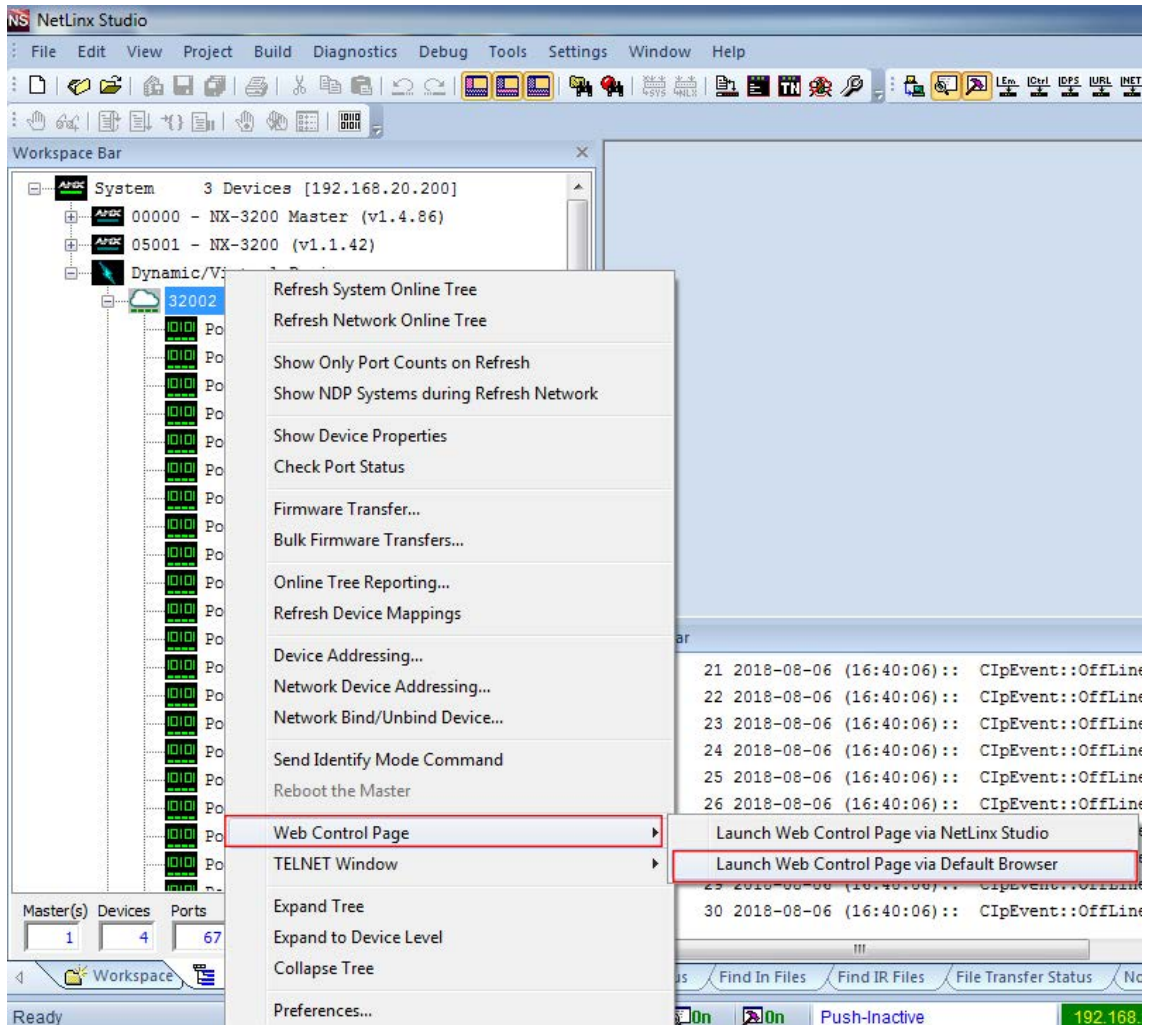

Web UI Control

The Web UI designed for the PR01-0808 allows basic controls and advanced settings of the device. The Web UI page can be accessed through NetLinxStudio.

Identify the IP address of the PR01-0808

On the PR01-0808, press and hold the select button UP and DOWN for 3 seconds. The current IP address of the device will be presented on the device LED display.

Access the Web Interface

To access the Web UI:

1. Connect your PC and the LAN port of the VPX-1701 to the same local area network.
2. In NetLinx Studio's Online Tree, select **"Web Control Page"** – **"Launch Web Control Page via Default Browser"** (or select **"Launch Web Control Page via NetLinx Studio"**).

The following page will pop up. Enter the default password **"admin"** and click **"Login"**.

After logging in, the main screen appears. It contains two submenus:

PR01-0808 Matrix control

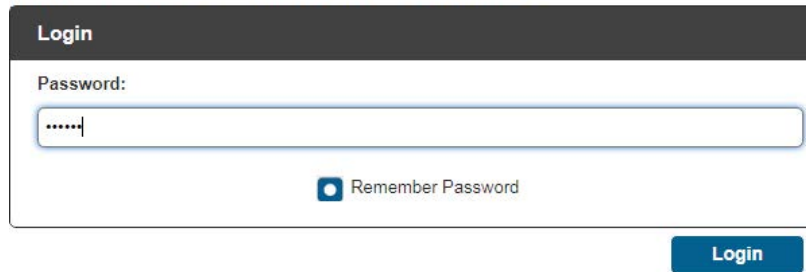

- Matrix Control
- Admin Setting
- Logout

Note: Select Launch Web UI Control Page via Default Browser or type the IP address into a web browser. Chrome, Safari, Firefox, Opera and IE10+ browsers are supported. Make sure the web browser is the latest version.

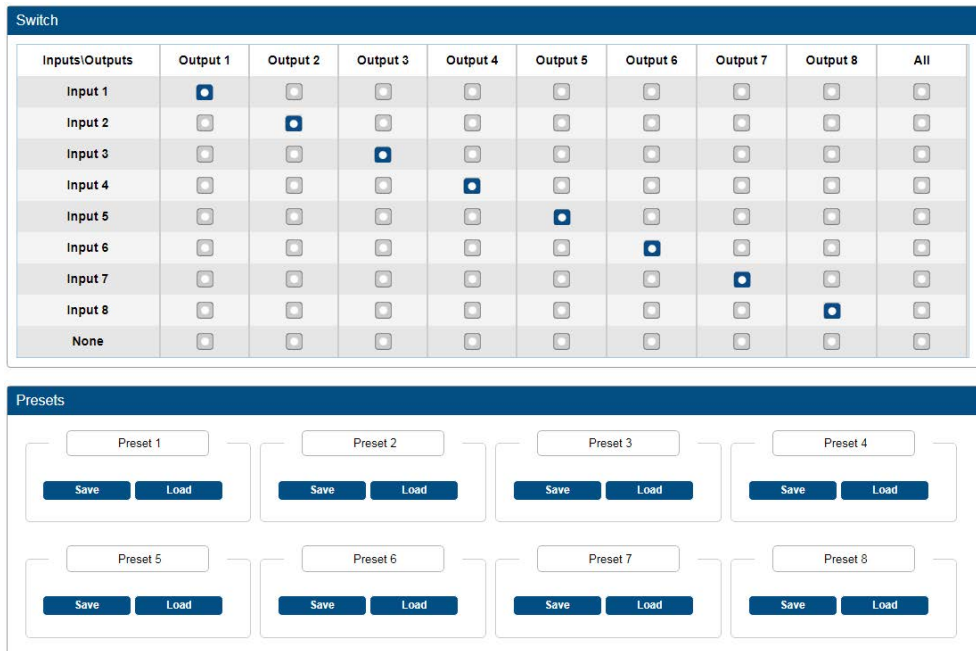

Inputs/Outputs	Output 1	Output 2	Output 3	Output 4	Output 5	Output 6	Output 7	Output 8	All
Input 1	<input checked="" type="checkbox"/>	<input type="checkbox"/>	<input type="checkbox"/>	<input type="checkbox"/>	<input type="checkbox"/>	<input type="checkbox"/>	<input type="checkbox"/>	<input type="checkbox"/>	<input type="checkbox"/>
Input 2	<input type="checkbox"/>	<input checked="" type="checkbox"/>	<input type="checkbox"/>	<input type="checkbox"/>	<input type="checkbox"/>	<input type="checkbox"/>	<input type="checkbox"/>	<input type="checkbox"/>	<input type="checkbox"/>
Input 3	<input type="checkbox"/>	<input type="checkbox"/>	<input checked="" type="checkbox"/>	<input type="checkbox"/>	<input type="checkbox"/>	<input type="checkbox"/>	<input type="checkbox"/>	<input type="checkbox"/>	<input type="checkbox"/>
Input 4	<input type="checkbox"/>	<input type="checkbox"/>	<input type="checkbox"/>	<input checked="" type="checkbox"/>	<input type="checkbox"/>	<input type="checkbox"/>	<input type="checkbox"/>	<input type="checkbox"/>	<input type="checkbox"/>
Input 5	<input type="checkbox"/>	<input type="checkbox"/>	<input type="checkbox"/>	<input type="checkbox"/>	<input checked="" type="checkbox"/>	<input type="checkbox"/>	<input type="checkbox"/>	<input type="checkbox"/>	<input type="checkbox"/>
Input 6	<input type="checkbox"/>	<input type="checkbox"/>	<input type="checkbox"/>	<input type="checkbox"/>	<input type="checkbox"/>	<input checked="" type="checkbox"/>	<input type="checkbox"/>	<input type="checkbox"/>	<input type="checkbox"/>
Input 7	<input type="checkbox"/>	<input type="checkbox"/>	<input type="checkbox"/>	<input type="checkbox"/>	<input type="checkbox"/>	<input type="checkbox"/>	<input checked="" type="checkbox"/>	<input type="checkbox"/>	<input type="checkbox"/>
Input 8	<input type="checkbox"/>	<input type="checkbox"/>	<input type="checkbox"/>	<input type="checkbox"/>	<input type="checkbox"/>	<input type="checkbox"/>	<input type="checkbox"/>	<input checked="" type="checkbox"/>	<input type="checkbox"/>
None	<input type="checkbox"/>	<input type="checkbox"/>	<input type="checkbox"/>	<input type="checkbox"/>	<input type="checkbox"/>	<input type="checkbox"/>	<input type="checkbox"/>	<input type="checkbox"/>	<input type="checkbox"/>

Web Interface Introduction

Matrix Control

The Matrix Control submenu is used to perform the following tasks:

- Switch
- Preset

Switch

The Switch manages the connection configurations of displays and sources.

Switch									
Inputs\Outputs	Output 1	Output 2	Output 3	Output 4	Output 5	Output 6	Output 7	Output 8	All
Input 1	<input checked="" type="checkbox"/>	<input type="checkbox"/>	<input type="checkbox"/>	<input type="checkbox"/>	<input type="checkbox"/>	<input type="checkbox"/>	<input type="checkbox"/>	<input type="checkbox"/>	<input type="checkbox"/>
Input 2	<input type="checkbox"/>	<input checked="" type="checkbox"/>	<input type="checkbox"/>	<input type="checkbox"/>	<input type="checkbox"/>	<input type="checkbox"/>	<input type="checkbox"/>	<input type="checkbox"/>	<input type="checkbox"/>
Input 3	<input type="checkbox"/>	<input type="checkbox"/>	<input checked="" type="checkbox"/>	<input type="checkbox"/>	<input type="checkbox"/>	<input type="checkbox"/>	<input type="checkbox"/>	<input type="checkbox"/>	<input type="checkbox"/>
Input 4	<input type="checkbox"/>	<input type="checkbox"/>	<input type="checkbox"/>	<input checked="" type="checkbox"/>	<input type="checkbox"/>	<input type="checkbox"/>	<input type="checkbox"/>	<input type="checkbox"/>	<input type="checkbox"/>
Input 5	<input type="checkbox"/>	<input type="checkbox"/>	<input type="checkbox"/>	<input type="checkbox"/>	<input checked="" type="checkbox"/>	<input type="checkbox"/>	<input type="checkbox"/>	<input type="checkbox"/>	<input type="checkbox"/>
Input 6	<input type="checkbox"/>	<input type="checkbox"/>	<input type="checkbox"/>	<input type="checkbox"/>	<input type="checkbox"/>	<input checked="" type="checkbox"/>	<input type="checkbox"/>	<input type="checkbox"/>	<input type="checkbox"/>
Input 7	<input type="checkbox"/>	<input type="checkbox"/>	<input type="checkbox"/>	<input type="checkbox"/>	<input type="checkbox"/>	<input type="checkbox"/>	<input checked="" type="checkbox"/>	<input type="checkbox"/>	<input type="checkbox"/>
Input 8	<input type="checkbox"/>	<input type="checkbox"/>	<input type="checkbox"/>	<input type="checkbox"/>	<input type="checkbox"/>	<input type="checkbox"/>	<input type="checkbox"/>	<input checked="" type="checkbox"/>	<input type="checkbox"/>
None	<input type="checkbox"/>	<input type="checkbox"/>	<input type="checkbox"/>	<input type="checkbox"/>	<input type="checkbox"/>	<input type="checkbox"/>	<input type="checkbox"/>	<input type="checkbox"/>	<input type="checkbox"/>

The input/output switch allows selection of output port (display) and input port (source) for specific combinations of displays and sources within the matrix.

Click the white button, it will become blue, which represents that the input and output are routed.

All: Route all outputs to one input.

None: Route output to none (turn off output)

Preset

Presets			
<div>Presets</div> <div>Presets</div> <div>Presets</div> <div>Presets</div> <div>Presets</div> <div>Presets</div> <div>Presets</div> <div>Presets</div>	<div>Presets</div> <div>Presets</div> <div>Presets</div> <div>Presets</div> <div>Presets</div> <div>Presets</div> <div>Presets</div> <div>Presets</div>	<div>Presets</div> <div>Presets</div> <div>Presets</div> <div>Presets</div> <div>Presets</div> <div>Presets</div> <div>Presets</div> <div>Presets</div>	<div>Presets</div> <div>Presets</div> <div>Presets</div> <div>Presets</div> <div>Presets</div> <div>Presets</div> <div>Presets</div> <div>Presets</div>

Only matrix inputs/outputs selection states can be saved as presets for loading to the matrix. **Save:** Save the selection states in the Switch submenu.

Load: Load the preset which has been saved.

Advanced Setting

The Advanced Setting submenu is used to perform the following tasks:

- CEC Setting
- EDID Setting
- HDCP Support
- Port Naming
- PresetName
- Network
- Change Password
- Telnet/SSH Account
- Telnet Service
- SSH Service
- ICSP Parameter
- System
- Save andLoad Setting
- Update Status
- Update WebUI
- Log
- Firmware

CEC Setting

Output: HDMI 1/HDBT 1

CEC Control	<input checked="" type="checkbox"/> Display On <input type="checkbox"/> Display Off
Auto Control (1-30 Minute)	<input type="checkbox"/> OFF

EDID Setting

HDCP Support

Input 1	<input checked="" type="checkbox"/> ON <input type="checkbox"/> OFF
Input 2	<input checked="" type="checkbox"/> ON <input type="checkbox"/> OFF
Input 3	<input checked="" type="checkbox"/> ON <input type="checkbox"/> OFF
Input 4	<input checked="" type="checkbox"/> ON <input type="checkbox"/> OFF
Input 5	<input checked="" type="checkbox"/> ON <input type="checkbox"/> OFF
Input 6	<input checked="" type="checkbox"/> ON <input type="checkbox"/> OFF
Input 7	<input checked="" type="checkbox"/> ON <input type="checkbox"/> OFF
Input 8	<input checked="" type="checkbox"/> ON <input type="checkbox"/> OFF

Port Name

Input 1	<input type="text" value="Input 1"/>	Output 1	<input type="text" value="Output 1"/>
Input 2	<input type="text" value="Input 2"/>	Output 2	<input type="text" value="Output 2"/>
Input 3	<input type="text" value="Input 3"/>	Output 3	<input type="text" value="Output 3"/>
Input 4	<input type="text" value="Input 4"/>	Output 4	<input type="text" value="Output 4"/>
Input 5	<input type="text" value="Input 5"/>	Output 5	<input type="text" value="Output 5"/>
Input 6	<input type="text" value="Input 6"/>	Output 6	<input type="text" value="Output 6"/>
Input 7	<input type="text" value="Input 7"/>	Output 7	<input type="text" value="Output 7"/>
Input 8	<input type="text" value="Input 8"/>	Output 8	<input type="text" value="Output 8"/>

Note: The length of name is limited to 15 characters (only letters, numbers or space , can't included punctuation) each.

Preset Name

Preset 1	<input type="button" value="Save"/> <input type="button" value="Reset"/>
Preset 2	<input type="button" value="Save"/> <input type="button" value="Reset"/>
Preset 3	<input type="button" value="Save"/> <input type="button" value="Reset"/>
Preset 4	<input type="button" value="Save"/> <input type="button" value="Reset"/>
Preset 5	<input type="button" value="Save"/> <input type="button" value="Reset"/>
Preset 6	<input type="button" value="Save"/> <input type="button" value="Reset"/>
Preset 7	<input type="button" value="Save"/> <input type="button" value="Reset"/>
Preset 8	<input type="button" value="Save"/> <input type="button" value="Reset"/>

Note: The length of name is limited to 15 characters (only letters, numbers or space , can't included punctuation) each.

Network

DHCP

Static

Static IP

IP Hostname:

IP Address:

Subnet Mask:

Gateway:

DNS Address

DNS IP 1:

DNS IP 2:

Note: Matrix LAN Module will automatically reboot after changing Network setting.

Change Password

Login Password

Old Password

New Password

Confirm New Password

Note: Password may only contain 4 to 20 alphanumeric characters.

Telnet/SSH Account

Telnet

Username

Password

SSH

Username

Password

Note: Username and Password may only contain 4 to 20 alphanumeric characters.

Telnet Service

Enable

Disable

Note: Device must be rebooted for the setting to take effect.

SSH Service

Enable

Disable

Note: Device must be rebooted for the setting to take effect.

ICSP Parameter

Connection Mode :

Master URL :

System Number :

Device Number :

System

Save And Load Setting

Update Status

Note: Only when you upgrade the device through Netlinx will you be able to view the upgrade status.

Update Web UI

Note: LAN Module will update and reboot automatically. Please wait about 3 minutes, then refresh and login again. Do not power off the matrix when updating.

Log

Show

Hide

Firmware

Web UI	V1.26
MCU	V1.6

CEC Setting

Click on the Output drop-down menu to select the output to be set.

Click **Display On** to send the CEC command to power on the display connected to the output.

Click **Display Off** to send the CEC command to power off the display connected to the output.

Choose Auto Control time to set display auto power off time. Example: With the time set to 2 minutes, the output display will be powered off automatically when there is no signal input for 2 minutes.

If you click the button “**Off**”, this function is free.

CEC Setting	
Output	HDMI 1/HDBT 1
CEC Control	Display On Display Off
Auto Control (1-30 Minute)	2 <input type="checkbox"/> OFF

Note: This function is valid only if the display supports CEC control and the time range for Auto Control is 0-30 minutes.

EDID Setting

The EDID Setting allows users to access and configure EDID of every input port. Click **Enter** to access **EDID Setting**.

EDID Setting	
Output	HDMI 1
Read	
HDMI Input 1	Fix 4K@60Hz 2.0CH Audio With HDR Apply
HDMI Input 2	Fix 4K@60Hz 2.0CH Audio With HDR Apply
HDMI Input 3	Fix 4K@60Hz 2.0CH Audio With HDR Apply
HDMI Input 4	Fix 4K@60Hz 2.0CH Audio With HDR Apply
HDMI Input 5	Fix 4K@60Hz 2.0CH Audio With HDR Apply
HDMI Input 6	Fix 4K@60Hz 2.0CH Audio With HDR Apply
HDMI Input 7	Fix 4K@60Hz 2.0CH Audio With HDR Apply
HDMI Input 8	Fix 4K@60Hz 2.0CH Audio With HDR Apply

Click **Read** to read EDID.

EDID Setting	
Output	HDMI 1
Read	

Change EDID settings through the input drop-down menu, and click **Apply** to make the change effective.

The screenshot shows eight individual configuration boxes for HDMI inputs, arranged in two columns. Each box is titled 'HDMI Input' followed by a number from 1 to 8. Inside each box, there is a dropdown menu currently displaying 'Fix 4K@60Hz 2.0CH Audio With HDR' and a blue 'Apply' button to its right.

HDCP Support

In the HDCP Support column, HDCP support of HDMI Input 1-8 ports can be enabled/disabled.

ON: Input port supports HDCP.

OFF: Input port does not support HDCP.

The screenshot shows a section titled 'HDCP Support' with a dark blue header. Below the header, there are eight input boxes, each labeled 'Input' followed by a number from 1 to 8. Each box contains two radio buttons: 'ON' (which is selected) and 'OFF'.

Port Naming

In the Port Naming column, User defined names can be assigned and modified for each port

The screenshot shows a section titled 'Port Name' with a dark blue header. Below the header, there are two columns of input fields. The left column is labeled 'Input' and contains eight fields, each with 'Input' followed by a number from 1 to 8. The right column is labeled 'Output' and contains eight fields, each with 'Output' followed by a number from 1 to 8. At the bottom of the section, there is a red note: 'Note: The length of name is limited to 15 characters (only letters, numbers or space . can't included punctuation) each.' and two blue buttons: 'Save' and 'Reset'.

Click **Save** to save the changes.

Click **Reset**, to return all the port names to the default settings.

Note: The length of each name is limited to 15 characters (letters, numbers or spaces).

Preset Name

In the Preset Name column, User defined names can be assigned and modified for each preset in this column.

The screenshot shows a configuration page titled "Preset Name". It contains eight preset cards arranged in two rows of four. Each card has a text input field for the preset name and two buttons: "Save" and "Reset". Below the cards, a red note states: "Note: The length of name is limited to 15 characters (only letters, numbers or space can't included punctuation) each."

Click **Save** to save the changes.

Click **Reset**, to return all the preset names to the default settings.

Note: The length of each name is limited to 15 characters (letters, numbers or spaces).

Network

In the Network Column, the device IP mode can be set:

DHCP: When enabled, the IP address of the PR01-0808 will be assigned automatically by the connected DHCP server.

Static: When the PR01-0808 fails to obtain or detect an IP address from the network to which it is connected, select "**Static**" to set up the IP address manually.

Apply: Click Apply to initiate the network setting.

The screenshot shows the "Network" configuration page. On the left, there are two radio buttons: "DHCP" (selected) and "Static". The "Static IP" section contains four input fields: "IP Hostname" (AMX-PR01-0808-807195), "IP Address" (192.168.20.108), "Subnet Mask" (255.255.255.0), and "Gateway" (192.168.20.1). The "DNS Address" section contains two input fields: "DNS IP 1" (192.168.20.1) and "DNS IP 2" (192.168.1.1). A red note at the bottom states: "Note: Matrix LAN Module will automatically reboot after changing Network setting." An "Apply" button is located at the bottom right.

The screenshot shows the "Network" configuration page. On the left, there are two radio buttons: "DHCP" and "Static" (selected). The "Static IP" section contains four input fields: "IP Hostname" (AMX-PR01-0808-807195), "IP Address" (192.168.1.3), "Subnet Mask" (255.255.255.0), and "Gateway" (192.168.1.1). The "DNS Address" section contains two input fields: "DNS IP 1" (192.168.20.1) and "DNS IP 2" (192.168.1.1). A red note at the bottom states: "Note: Matrix LAN Module will automatically reboot after changing Network setting." An "Apply" button is located at the bottom right.

Change Password

In the Change Password column, modification can be made for the Login Password.

The Login Password default is **admin**.

Click the “**Save**” button to save the changes

Note: Passwords must be 4 to 16 characters in length (alphanumeric only).

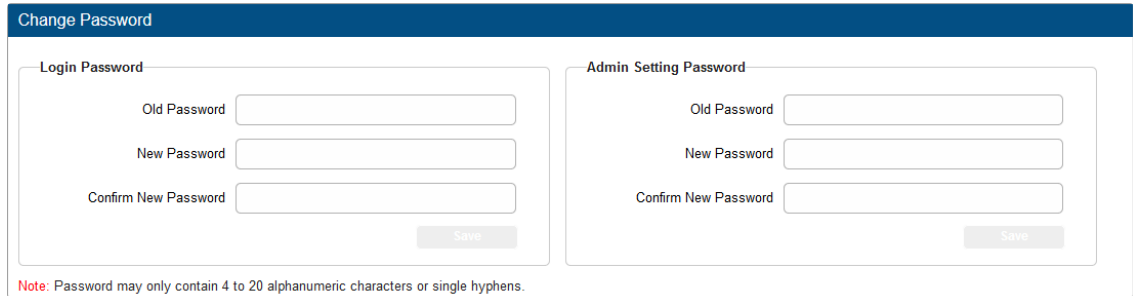

The screenshot shows a 'Change Password' form with two main sections: 'Login Password' and 'Admin Setting Password'. Each section contains three input fields: 'Old Password', 'New Password', and 'Confirm New Password'. A 'Save' button is located at the bottom right of each section. A red note at the bottom states: 'Note: Password may only contain 4 to 20 alphanumeric characters or single hyphens.'

Telnet/SSH Account

Telnet/SSH Account is used to configure the user name and password of the account.

For Telnet Account, the default user name and password are null.

For SSH Account, the default user name is **admin**, the default password is **password**.

Note: Reboot the device for the SSH changes to take effect.

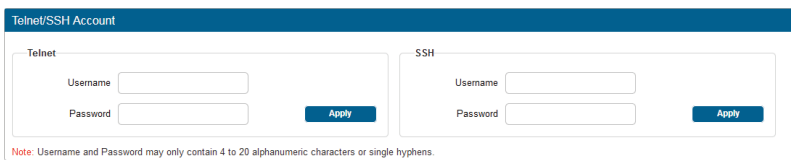

The screenshot shows a 'Telnet/SSH Account' form with two columns: 'Telnet' and 'SSH'. Each column has 'Username' and 'Password' input fields and an 'Apply' button. A red note at the bottom states: 'Note: Username and Password may only contain 4 to 20 alphanumeric characters or single hyphens.'

Telnet Service

In the Telnet Service column, telnet Service can be **Disabled** or **Enabled**. “**Enable**” is default.

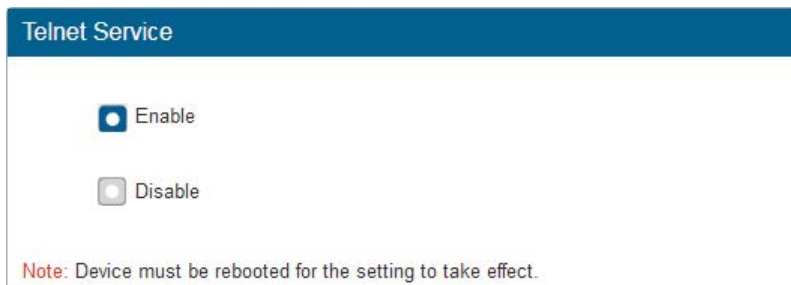

The screenshot shows a 'Telnet Service' form with two radio button options: 'Enable' (which is selected) and 'Disable'. A red note at the bottom states: 'Note: Device must be rebooted for the setting to take effect.'

SSH Service

In the SSH Service column, selection of SSH Service can be **Disabled** or **Enabled**. “**Enable**” is default.

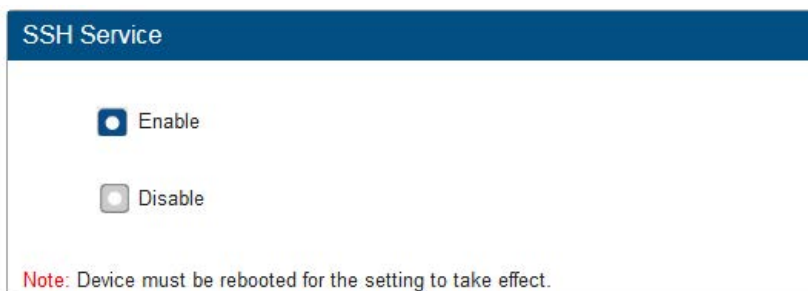

The screenshot shows an 'SSH Service' form with two radio button options: 'Enable' (which is selected) and 'Disable'. A red note at the bottom states: 'Note: Device must be rebooted for the setting to take effect.'

ICSP PARAMETER

In the ICSP Parameter column, the ICSP parameter can be set.

Connection Mode: includes four options of NDP, Auto IP, URL/TCP, URL/UDP.

Master URL: Input the connected master's URL.

System Number: Use the Online Tree to determine it. By default, it is disabled to configure.

Device Number: Use the Online Tree to determine it. By default, it is disabled to configure.

Click "**APPLY**" to initiate the change.

ICSP Parameter

Connection Mode :

Master URL :

System Number : (0-65535)

Device Number :

Apply

System

In the System column, device reboot or reset to defaults can be initiated.

System

Reboot **Reset to Defaults...**

Reboot: Click "reboot". Select "OK" of the popup box up to reboot the device.

Confirm



Are you sure you want to reboot the device?

(After setting, you need to wait 3 minutes to reaccess Web UI by refreshing the browser)

OK **Cancel**

Reset to Defaults: Click “Reset to Defaults...”, select “OK” in the popup box to reset the device to factory defaults.

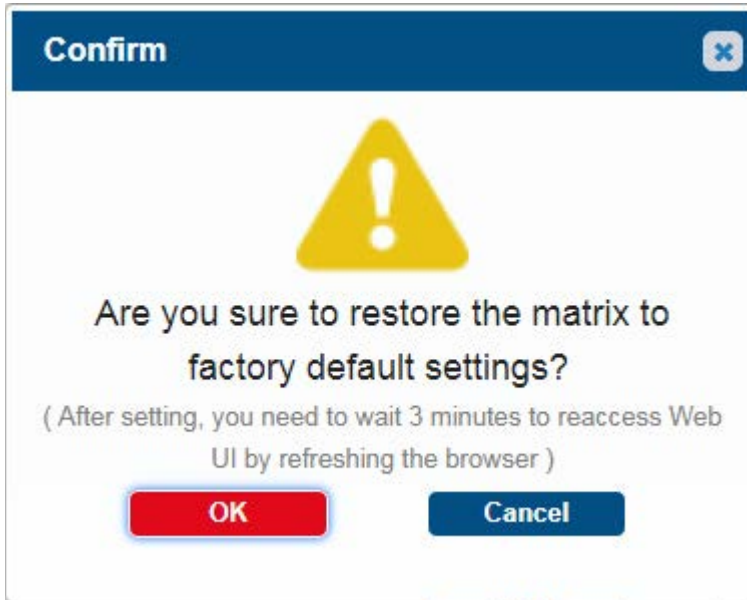

Save and Load Setting

In the Save and Load Setting column, settings can be saved and user saved settings can be loaded.

Save Settings: Save current settings as a setting file to be saved to a PC.

Load Settings: Click to load a setting file from PC to Matrix.



Update Status

In the Update Status column, the upgrade status is displayed when upgrading the device firmware.

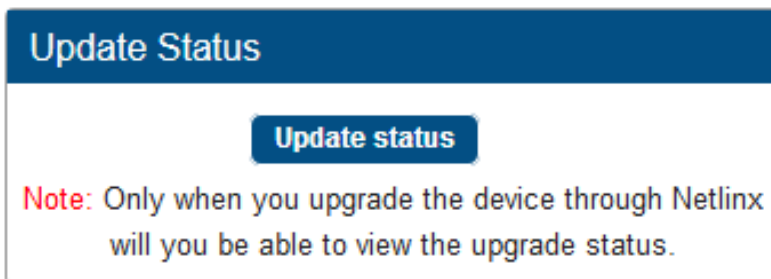

Update Web UI

In the Update Web UI column, the Web UI can be updated.

Update Web UI

Note: LAN Module will update and reboot automatically. Please wait about 3 minutes, then refresh and login again.
Do not power off the matrix when updating.

Step 1. Browse for the bin file.

Step 2. Click the **Update** button.

Note: The module will update and reboot automatically. Allow time for the reboot to complete, then refresh and login again. Do not power off the matrix while updating.

LOG

In the Log column, choose to hide or show the log in at the bottom of the page.

Log

 Show
 Hide

Firmware

In the Firmware column, the firmware version can be checked.

Firmware	
Web UI	V1.26
MCU	V1.6

Firmware Upgrade

The PR01-0808 uses KIT files for firmware upgrade.

Before Starting

1. Verify that you have the latest version of NetLinx Studio on your PC.
2. Download the latest firmware (KIT) file to your PC. (Place KIT files on a local drive for the fastest throughput.)
3. Verify the following:
 - a) Verify that an Ethernet/RJ-45 cable is connected from the PR01-0808 to the same network as the control system.
 - b) Verify the PR01-0808 unit is powered ON.
4. Launch NetLinx Studio and open the Online Tree.
5. Launch Web UI page before you upgrade firmware to know the status of upgrading. More information, please refer to **UPGRADE STATUS** part in **Web UI Control** section.

Transferring KIT Files

Important Upgrade Information:

Upgrading the firmware is a serious action in that if the upgrade fails, it can leave the system completely non-operational. Ensure interruption of power and no power-off during the upgrade process.

The system will be non-operational during the upgrade procedure below.

1. In NetLinx Studio from the **Tools** menu, select "**Firmware Transfers > Send to NetLinx Device**", select "**Stop Communications**" in the following box, and then enter the **Send to NetLinx Device** dialog box.



2. Click  to navigate to the target directory. The selected directory path is displayed in the Location text box. KIT files in the target directory display under File Names.
3. Select the appropriate KIT file from the list.
4. Enter the Device and System numbers (see **Device Number and Ports** in the **NetLinx Programming** section) for the target module in the Device and System text boxes.
 - The number of NetLinx Master is 3.
 - The Device number assigned to the integrated control ports is 32002. (Use the Online Tree to determine the Device Number.).

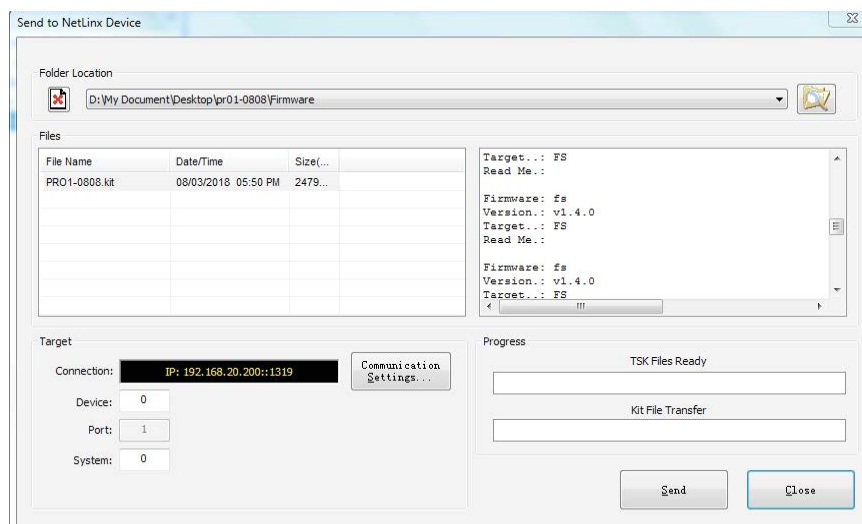

5. Click **Send** to send the file to NetLinx Master and initiate the firmware upgrade on the PR01-0808.
6. Click **Update Status** in the **Update Status** column of Web UI to check status of the firmware upgrade.

NOTE: Do not power off the Device until it has been successfully upgraded.

The Device will restart two times to resume normal operation.

Troubleshooting

1. **Power:** Ensure all devices are powered on (sources, transmitter, receiver and display).
2. **Indicator:** Please make sure all LED indicators of the receiver is normal according to the user manual.
3. **Devices:** Ensure picture can be shown normally when directly connecting a source to a display device.
4. **Cable:** Plug in and out HDMI/Cat X cable or try another HDMI/Cat X cable.
 - Ensure the cable length being used is within available transmission range according to the **Specification** Section.
 - Cat 5e/6/6a/7 cable is recommended. Do not use Cat 5 cable.
 - Ensure both connectors of each Cat X cable are the same standard (EIA/TIA 568B).
5. **Compatibility:** Test other source and display devices to determine correct compatibility.

Appendix: API Command List Instructions

NetLinx Control Commands

Device Port Name and Port Number:

Model name	Port name	Port No.
PR01-0808	HDMI In 1 HDMI/HDBT Out 1 Audio Out 1	1
	HDMI In 2 HDMI/HDBT Out 2 Audio Out 2	2
	HDMI In 3 HDMI/HDBT Out 3 Audio Out 3	3
	HDMI In 4 HDMI/HDBT Out 4 Audio Out 4	4
	HDMI In 5 HDMI Out 5 Audio Out 5	5
	HDMI In 6 HDMI Out 6 Audio Out 6	6
	HDMI In 7 HDMI Out 7 Audio Out 7	7
	HDMI In 8 HDMI Out 8 Audio Out 8	8

NetLinx Control Command List Instructions (cont.)

No.	Function Description	Syntax	Example
1	Switches both the audio and video input port to the output port	<p>Command SEND_COMMAND <DEV>, "CI<input>O<output>"</p> <p>Or:</p> <p>Command SEND_COMMAND <DEV>, "CL<Switch Level>I<Input>O<Outputs>"</p> <p>Or:</p> <p>Command SEND_COMMAND <DEV>, "VI<input>O<output>"</p> <p>Return: SWITCH-VIDEOI(input)O(output)</p> <p>Description: input={1~8}, output={1-8} input 1~8: HDMI in1~8 output 1~4: HDMI out1~4/HDBT out1~4 output 5~8: HDMI out 5~8</p>	<p>Command: SEND_COMMAND 5002:1:0, "CI201" SEND_COMMAND 5002:1:0, "VI201"</p> <p>Return: SWITCH-VIDEOI(2)O(1)</p> <p>Description: Switches input 2 to output 1.</p>
2	Requests the output(s) connected to an input.	<p>Command: SEND_COMMAND <DEV>, "?OUTPUT-<Switch Level>,<Input>"</p> <p>Variables: Switch Level = VIDEO or ALL (both Audio and Video). Input = The source input port number.</p> <p>Return: SWITCH-L<VIDEO>I<Input>O<Output></p>	<p>Command: SEND_COMMAND 5002:1:0, "?OUTPUT-VIDEO,1"</p> <p>Return: SWITCH-VIDEOI10(1)</p>
3	Requests the input connected to an output.	<p>Command: SEND_COMMAND <DEV>, "?INPUT-<Switch Level>,<Output>"</p> <p>Variables: Switch Level = VIDEO. Output = The output port number.</p> <p>Return: SWITCH-L<VIDEO>I<Input>O<Output></p> <p>Description: Requests the input connected to an output</p>	<p>Command: SEND_COMMAND 5002:1:0, "?INPUT-VIDEO,1"</p> <p>Return: SWITCH-VIDEOI10(1 6 7)</p> <p>Description: Output Scale is Auto</p>
4	To Set Input HDCP support ON/OFF	<p>Command: SEND_COMMAND <DEV>,"VIDIN_HDCP-<option>"</p> <p>Return: VIDIN_HDCP-<option></p> <p>Variables: option = ENABLE, DISABLE (default = ENABLE)</p>	<p>Command: SEND_COMMAND VIDEO_INPUT_1,"VIDIN_HDCP-ENABLE"</p> <p>Return: VIDIN_HDCP-ENABLE'</p> <p>Description: Enables the HDCP compliance of video input port #1</p>
5	Requests the video input HDCP compliance setting of the specified video input port.	<p>Command: SEND_COMMAND <DEV>, "?VIDIN_HDCP"</p> <p>Return: VIDIN_STATUS-<ENABLE DISABLE></p>	<p>Command: SEND_COMMAND VIDEO_INPUT_1,"?VIDIN_HDCP"</p> <p>Return: VIDIN_STATUS-<ENABLE DISABLE></p>

NetLinx Control Command List Instructions (cont.)

No.	Function Description	Syntax	Example
System Info			
10	To cause a warm reboot	Command: SEND_COMMAND <DEV>,"REBOOT" Return: reboot	Command: SEND_COMMAND DEVICE_1,"REBOOT" Return: reboot Description: Cause a warm reboot
11	Requests the firmware version	Command: SEND_COMMAND <DEV>,"?FWVERSION" Return: version- <model:version>	Command: SEND_COMMAND dvRX,"?FWVERSION" Return: version-WebUI: v1.28.0 ST:V1.7 EPI1:v1.0 EPI2:v1.0 EPI4:v1.0 EPI5:v1.0 EPI6:v1.0 EPI7:v1.0 EPI8:v1.0 EPO1:v1.0 EPO2:v1.0 EPO4:v1.0 EPO5:v1.0 EPO6:v1.0 EPO7:v1.0 EPO8:v1.0
12	To execute a display control on/off	Command: SEND_COMMAND <DEV>,"CEC_DISP_POWER-<ON OFF>" Return: CEC_DISP_POWER-<ON OFF>	Command: SEND_COMMAND <DEV>,"CEC_DISP_POWER-OFF" Return: CEC_DISP_POWER-OFF Description: Execute a display control off
13	To define the display control automatically	Command: SEND_COMMAND <DEV>,"CEC_DISP_AUTO-<ON OFF>" Return: CEC_DISP_AUTO-<ON OFF>	Command: SEND_COMMAND <DEV>,"CEC_DISP_AUTO-OFF" Return: CEC_DISP_AUTO-OFF Description: Define the display control automatically off
14	To verify the display control Status	Command: SEND_COMMAND <DEV>,"?CEC_DISP_AUTO" Return: CEC_DISP_AUTO-<ON OFF>	Command: SEND_COMMAND SWITCHER,"?CEC_DISP_AUTO" Return: CEC_DISP_AUTO-ON Description: Get the display control Status. The display control Status is on.
15	To define a Delay Time to control the display off when on active signal	Command: SEND_COMMAND <DEV>,"CEC_SLEEP_TIMEOUT-<time>" Return: NULL Description: time#: #={1 ~ 30}	Command: SEND_COMMAND <DEV>,"CEC_SLEEP_TIMEOUT-5" Return: CEC_SLEEP_TIMEOUT-5 Description: Set Delay Time is 5 Minutes
16	To verify Delay Time to control the display off when on active signal	Command: SEND_COMMAND <DEV>,"?CEC_SLEEP_TIMEOUT" Return: CEC_SLEEP_TIMEOUT-<time> Description: time#: #={1 ~ 30}	Command: SEND_COMMAND SWITCHER,"?CEC_SLEEP_TIMEOUT" Return: CEC_SLEEP_TIMEOUT-5 Description: Get Delay Time to control the display off when on active signal. The Delay Time is 5 Minutes.

NetLinx Control Command List Instructions (cont.)

No.	Function Description	Syntax	Example
17	To verify Input signal status	<p>Command: SEND_COMMAND <DEV>,""?VIDIN_STATUS-<input>"</p> <p>Return: VIDIN_STATUS-<status string></p> <p>Description: Input port = The source input port number. I#: #={1 ~ 8} status string // { 0: NO SIGNAL; 1: VALID SIGNAL; }</p>	<p>Command: SEND_COMMAND VIDEO_INPUT_1,""?VIDIN_STATUS"</p> <p>Return: VIDIN_STATUS-NO SIGNAL</p> <p>Description: VGA IN Input no signal.</p>

Telnet/SSH Control Commands

No.	Command	Description	Example
1	help	Displays all of the supported commands	<pre>>help cpu usage Displays the total CPU usage date Display the current date. get ip Show the IP configuration of this device.</pre>
2	cpu usage	Display the total CPU usage usage: cpu usage	<pre>>cpu usage CPU usage is 25%</pre>
3	date	Display the current date. Usage: date	<pre>>date The current date is: Thursday, January 1, 1970</pre>
4	get ip	Show the IP configuration of this device.	<pre>>get ip --- Current IP Settings-- - Hostname: XXX IP Address: 192.168.2.201 Netmask: 255.255.240.0 Gateway: 192.168.2.1 DHCP: false</pre>
5	ping	Ping an address. Address may be an IP or URL.	<pre>>ping 192.16.2.203 PING 192.16.2.203 (192.16.2.203): 56 data bytes</pre>
6	reset factory	Reset configuration back to factory defaults.	<pre>>reset factory</pre>
7	set date	Set the current date.	<pre>>set date Usage: set date [day] [month] [year] Arguments: day integer of day of the week between 1 and 31 month integer of month between 1 and 12 year integer value of year later than 1900 Example: set date 01 11 2016</pre>

Telnet/SSH Control Commands

No.	Command	Description	Example
8	set ip	Setup the IP configuration of this device.	<pre> >set ip --- Enter New Values or just hit Enter to keep current settings - -- Enter Hostname AMX-PR01-0808-faaf37 aaa Enter IP type. Type D for DHCP or S for Static IP and then Enter: DHCP S Enter IP Address 192.168.3.21 192.168.3.21 Enter Netmask 255.255.240.0 255.255.240.0 Enter Gateway 192.168.2.1 --- New settings--- Hostname aaa IP type STATIC IP Address 192.168.3.21 Netmask 255.255.240.0 Gateway 192.168.2.1 Would you like to save the new settings? Y/N -> N Exiting set IP. Settingsunchanged. >set ip --- Enter New Values or just hit Enter to keep current settings -- - Enter Hostname AMX-PR01-0808-faaf37 aaa Enter IP type. Type D for DHCP or S for Static IP and then Enter: DHCP D --- New settings--- Hostname aaa IP type DHCP Would you like to save the new settings? Y/N -> N Exiting set IP. Settingsunchanged. </pre>

Telnet/SSH Control Commands

No.	Command	Description	Example
9	set time	Set the current time.	<p>>set time</p> <p>Usage: set time [hours] [minutes] [seconds]</p> <p>Arguments:</p> <p>hours integer value of hours between 0 and 23</p> <p>minutes integer value of minutes between 0 and 59</p> <p>seconds integer value of seconds between 0 and 59</p> <p>Example:</p> <p>set time 13 30 00</p>
10	show mem	Displays the memory usage for all memory types.	<p>>show mem</p> <p>RAM available: 349634560 bytes</p> <p>RAM total: 406167552 bytes</p>
11	time	Display the current time.	<p>>time</p> <p>The current time is: 11:57:09 PM</p>
13	echo	Enables/disables echo of typed characters.	<p>>echo</p> <p>Usage: echo [argument]</p> <p>Arguments:</p> <p>on Enable echo of typed characters</p> <p>off Disable echo of typed characters</p> <p>Example:</p> <p>echo on</p>
14	exit	Close this terminal session.	<p>>exit</p>
15	msg	Enables/Disables extended diagnostic messages.	<p>>msg</p> <p>Usage: msg [argument]</p> <p>This command allows system logs to be redirected to the terminal session.</p> <p>There are multiple log levels, which are described below.</p> <p>Arguments:</p> <p>on Enable default [warning] system log level</p> <p>debug Enable all system debug messages</p> <p>info Enable info system log level</p> <p>warning Enable warning system log level</p> <p>error Enable error system log level</p> <p>off Disable system log output to terminal session</p> <p>Example:</p> <p>msg on</p>
16	reboot	Reboots the device.	<p>>reboot</p>
17	set telnet username	set telnet service login username	<p>>set telnet username</p> <p>Enter Telnetnew username admin aaa</p> <p>Would you like to set this username (y/n) n</p> <p>Cancel this setting</p> <p>>set telnet username</p> <p>Enter Telnetnew username admin aaa</p> <p>Would you like to set this username (y/n) y</p> <p>(please set telnet password)</p> <p>Changed && Saved</p>

Telnet/SSH Control Commands

No.	Command	Description	Example
18	set telnet password	set telnet service login password	<p>>set telnet password</p> <p>Enter Telnetnew password admin password Would you like to set this password (y/n) n Cancel this setting</p> <p>>set telnet password</p> <p>Enter Telnetnew password admin password Would you like to set this password (y/n) y Changed && Saved</p>
19	set ssh username	set ssh service login username	<p>>set ssh username</p> <p>Enter ssh new username admin aaa Would you like to set this username (y/n) n Cancel this setting</p> <p>>set ssh username</p> <p>Enter ssh new username admin aaa Would you like to set this username (y/n) y Changed && Saved (you should reboot this device that make your setting active)</p>
20	set ssh password	set ssh service login password	<p>>set ssh password</p> <p>Enter sshnew password password test Would you like to set this password (y/n) n Cancel this setting</p> <p>>set ssh password</p> <p>Enter sshnew password password test Would you like to set this password (y/n) y Changed && Saved (you should reboot this device that make your setting active)</p>
21	set connection	set the master connection settings.	<p>>set connection</p> <p>--- Enter New Values or just hit Enter to keep current settings ---</p> <p>Enter Mode Type T for TCP/URL, U for UDP/URL, N for NDP or A for Auto and then Enter: Icsp_URL</p> <p>...(Refer to multimode connection instruction)</p>
22	reboot	Reboots the device.	>reboot
23	set friendlyname	set friendlyname	<p>>set friendlyname</p> <p>Please input friendlyname:</p> <p>Old friendlyname: user New friendlyname: admin Would you like to save this setting(Y/N) N Cancel this setting</p> <p>>set friendlyname</p> <p>Please input friendlyname:</p> <p>Old friendlyname: user New friendlyname: admin Would you like to save this setting(Y/N) Y Setting is ok , you should reboot that make it effective</p>

Telnet/SSH Control Commands

No.	Command	Description	Example
24	set location	set location	<pre> >set location Please input location: Old location: there New location: here Would you like to save this setting(Y/N) N Cancel this setting >set location Please input location: Old location: there New location: here Would you like to save this setting(Y/N) Y Setting is ok, you should reboot that make it effective </pre>
25	get connection	get connection	<pre> >get connection Connection Mode: Icsp_NDP System Number: 1 Master Ip/URL 192.168.2.203 Master Port: 1319 </pre>
26	set dns	set dns	<pre> >set dns --- Enter new values or keep current settings at the prompts --- -- Current DNS #1 192.168.2.1 Change the current value? Y/N -> Y Enter DNS #1 192.168.3.1 -- Current DNS #2 192.168.3.1 Change the current value? Y/N -> Y Enter DNS #2 192.168.4.1 --- New settings --- DNS #1 192.168.3.1 DNS #2 192.168.4.1 Would you like to set the new settings? Y/N -> Y New settings weresaved... </pre>
27	dns list	Show the DNS configuration of this device.	<pre> >dns list Domain Name: amx.com DNS List: DNS #1: 192.168.2.1 DNS #2: 192.168.3.1 </pre>

RS232 Control Commands

No.	Function Description	Syntax	Example	Action
1	To execute a switch	CL#O#I#T I#: #={0 ~8 } O#: #={1~8, ALL}	Command: C08I2T Return: C08I2T	Switches Input 2 to Output 8 on Level 0
			Command: C02 4 8I2T Return: C02 4 8I2T	Switches input 2 to Output 2,4,8 on Level 0
		CL#O#I#T I#: #={0 ~8} O#: #={1~8, ALL}	Command: C08I2T Return: C08I2T	Switches Input 2 to Output 8 on the default level (normally Level 0)
			Command: C04:8I2T Return: C04:8I2T	Switches Input 2 to Outputs 4,5,6,7,8 on Level 0
			Command: C01:3 5 7:8I2T Return: C01:3 5 7:8I2T	Switches Input 2 to Outputs 1,2,3,5,7,8 on Level 0
			Command: COALLI2T Return: COALLI2T	Switches Input 2 to All Outputs
			Command: C08I0T Return: C08I0T	Disconnects output 8 (Switches none input to Output 8)
2	To verify signal status	SL#O#T O#: #={1~8}	Command: S04T Return: S04T(6)	Output 4 is connected to input 6 on Level 0
			Command: S08T Return: S08T()	Output 8 is not connected to an input on Level 0
		SL#I#T I#: #={1~8}	Command: SI4T Return: SI4T(1 2 6)	Input 4 is routed to outputs 1,2, and 6 on Level 0
			Command: SI8T Return: SI8T()	Input 8 is not routed to an output on Level 0
3	To define a global preset	RR#T #: 1-8	Command: RR1T Return: RR1T	Define the current system state as Global Preset 1

RS232 Control Commands

No.	Function Description	Syntax	Example	Action
4	To execute a global preset	R#T	Command: R1T Return: S01T(6)S02T(6)S03T(6)S04T(6)S05T(6)S06T(6)S07T(6)S08T(6)	Executes Global Preset 1
5	To execute a sink power by CEC	CL#O#SP#T O#: #={1~12, ALL}; // 1~8 hdmi1-hdmi8 outputs; // 9~12 hdbt1-hdbt4 outputs SP#: #={0, 1}	Command: C03SP1T Return: C03SP1T	Executes the sink connected to output 3 power on
			Command: C03SP0T Return: C03SP0T	Executes the sink connected to output 3 power off
6	To define a sink power by CEC automatically	CL#O#SPA#T O#: #={1~12, ALL}; // 1~8 hdmi1-hdmi8 outputs; // 9~12 hdbt1-hdbt4 outputs SPA#: #={0, 1}	Command: C03SPA1T Return: C03SPA1T	Enable control the sink that connected to output 3 power by CEC automatically on Level 0
			Command: C03SPA0T Return: C03SPA0T	Disable control the sink that connected to output 3 power by CEC automatically on Level 0
7	To verify a sink power controlled Status	SL#O#SPAT O#: #={1~12}; // 1~8 hdmi1-hdmi8 outputs; // 9~12 hdbt1-hdbt4 outputs SPA#: #={0, 1}	Command: S03SPAT Return: S03SPAT(1)	Output 3 is able to control power by CEC automatically
			Command: S03SPAT Return: S03SPAT(0)	Output 3 is disable to control power by CEC automatically
8	To define a Delay Time to execute a sink power off when no active signal	CL#O#D#SPT O#: #={1~12, ALL}; // 1~8 hdmi1-hdmi8 outputs; // 9~12 hdbt1-hdbt4 outputs D#: #={0~30MIN}	Command: C03D5SPT Return: C03D5SPT	Define Delay 3 minutes to control the sink that connected to output 3 power off when no active signal

RS232 Control Commands

No.	Function Description	Syntax	Example	Action
9	To verify Delay Time to execute a sink power off when no active signal	SL#O#DSPT O#: #{1~12}; // 1~8 hdmi1-hdmi8 outputs; // 9~12 hdbt1-hdbt4	Command: S03DSPT Return: S03DSPT(5)	
10	To Set Input HDCP support ON/OFF	CL#I#DCP#T I#: {1~8, ALL}; DCP#: {0,1} // 0: OFF; 1:ON	Command: CI5DCP1T Return: CI5DCP1T	Set Input 5 HDCP support ON
11	To Verify Input HDCP support Status	SL#I#DCPT I#: {1~8}; DCP#: {0,1} // 0: OFF; 1:ON	Command: SI5DCPT Return: SI5DCPT(1)	Set Input 5 HDCP support ON
12	To Verify EDID Dip Status	SDIPT DIP#: {0-7} // 0 ---> Smart, // 1 ---> 1080P60Hz_2Ch, // 2 ---> 4K30Hz_2Ch_Without420_HDR, // 3 ---> 4K30Hz_2Ch_HDR, // 4 ---> 4K30Hz_6Ch_HDR, // 5 ---> 4K30Hz_8Ch_HDR, // 6 ---> 4K60Hz_2Ch_HDR, // 7 ---> Customize,	Command: SDIPT Return: SDIPT(2)	

RS232 Control Commands

No.	Function Description	Syntax	Example	Action
13	To Set input EDID	CL#I#E#T I#: #={1~8,ALL}; E#: {1~20} 1: Copy form hdmi output 1 2: Copy form hdmi output 2 ... 8: Copy form hdmi output 8 9: Copy form hdbt output 1 10: Copy form hdbt output 2 11: Copy form hdbt output 3 12: Copy form hdbt output 4 13: Fix 4K@60Hz 2.0ch audio With HDR 14: Fix 4K@30Hz 7.1ch audio With HDR 15: Fix 4K@30Hz 5.1ch audio With HDR 16: Fix 4K@30Hz 2.0ch audio With HDR 17: Fix 4K@30Hz/8bit only 2.0ch audio Without HDR 18: 1080P@60Hz 2.0ch audio 19: Smart EDID 20: EDID Write	Command: CI5E1T Return: CI5E1T Specially: Command: CI5E20T00FFFFFFF... Return: CI5E20T --- ok or CI5E20X --- err	Copy EDID form HDMI output 1 to input 5

RS232 Control Commands

No.	Function Description	Syntax	Example	Action
14	To Verify input EDID	SL#I#ET I#: {1~8}; E#: {1~20} 1: Copy form hdmi output 1 2: Copy form hdmi output 2 ... 8: Copy form hdmi output 8 9: Copy form hdbt output 1 10: Copy form hdbt output 2 11: Copy form hdbt output 3 12: Copy form hdbt output 4 13: Fix 4K@60Hz 2.0ch audio With HDR 14: Fix 4K@30Hz 7.1ch audio With HDR 15: Fix 4K@30Hz 5.1ch audio With HDR 16: Fix 4K@30Hz 2.0ch audio With HDR 17: Fix 4K@30Hz/8bit only 2.0ch audio Without HDR 18: 1080P@60Hz 2.0ch audio 19: Smart EDID 20: EDID Write	Command: SI5ET Return: SI5ET(1)	The EDID of the Input 5 is copied from HDMI output 1
15	To get Output EDID	RL#O#ET O#: {1~12}; // 1~8 hdmi1-hdmi8 outputs; // 9~12 hdbt1-hdbt4 outputs	Command: RO2ET Return: Success: RO2ET(XX...XX) //Return 512 characters consecutive Failure: RO2EX	
16	To define IR System Code	CIR#T IR#: {1, 2, 3} 1: supports 0x00 and 0x4E 2: supports 0x00; 3: supports 0x4E;	Command: CIR2T Return: CIR2T	
17	To Verify IR System Code	SIRT IR#: {1, 2, 3} 1: supports 0x00 and 0x4E 2: supports 0x00; 3: supports 0x4E;	Command: SIRT Return: SIRT(2)	

RS232 Control Commands

No.	Function Description	Syntax	Example	Action
18	To Verify Commands list	~HELP!	<p>Command: ~HELP!</p> <p>Return: ~HELP![01] CL#I#O#T (To execute a switch) [02] CL#O#I#T (To execute a switch) [03] SL#O#T (To verify signal status) [04] SL#I#T (To verify signal status) [05] RR#T (To define a global preset) [06] R#T (To execute a global preset) [07] CL#O#SP#T (To execute a sink power by cec) [08] CL#O#SPA#T (To define a sink power by cec automatically) [09] SL#O#SPA#T (To verify a sink power controlled Status) [10] CL#O#D#SPT (To define a Delay Time to execute a sink power off when on active signal) [11] SL#O#DSPT (To verify Delay Time to execute a sink power off when on active signal) [12] CL#I#DCP#T (To set Input HDCP support ON or OFF) [13] SL#I#DCPT (To verify Input HDCP support Status) [14] SDIPT (To verify EDID Dip Status) [15] CL#I#E#T (To set input EDID) [16] SL#I#ET (To verify input EDID) [17] RL#O#ET (To get Output EDID) [18] CIR#T (To define IR System Code) [19] SIRT (To verify IR System Code) [20] ~HELP! (To verify Commands list) [21] ~VER! (To determine the system's Application Code version) [22] ~APP! (To cause a warm reboot) [23] ~SYSR! (To reset system setting)</p>	

RS232 Control Commands

No.	Function Description	Syntax	Example	Action
19	To determine the system's Application Code version	~VER!	Command: ~VER! Return: ~VER!(AMX DUX-8D #.#) e.g.: ~VER!(AMX DUX-8D 1.0)	
20	To cause a warm reboot	~APP!	Command: ~APP! Return: ~APP!	
21	To reset system setting	~SYSR!	Command: ~SYSR! Return: ~SYSR!	



LAST REVISED: 2021-02-24

About AMX by HARMAN

Founded in 1982 and acquired by HARMAN in 2014, AMX® is dedicated to providing AV solutions for an IT World. AMX solves the complexity of managing technology with reliable, consistent and scalable systems comprising control, video switching and distribution, digital signage and technology management. AMX systems are deployed worldwide in conference rooms, classrooms, network operation/command centers, homes, hotels, entertainment venues and broadcast facilities, among others. AMX is part of the HARMAN Professional Group, the only total audio, video, lighting, and control vendor in the professional AV market. HARMAN designs, manufactures and markets premier audio, video, infotainment and integrated control solutions for the automotive, consumer and professional markets.

©2021 Harman. All rights reserved. Specifications subject to change.

www.amx.com | +1.469.624.7400 | 800.222.0193