

# Panasonic®

## LUMIX

# S5

Owner's Manual

<Basic>

Digital Camera

DC-S5

**U.S. customers only**

**Register online at <http://shop.panasonic.com/support/register>**

**to receive these benefits:**

- Safety Notification
- Owner Verification
- Efficient Warranty Service
- Special Offers and Promotions from Panasonic



If you have any questions, visit:  
USA : <http://shop.panasonic.com/support>



Please read these instructions carefully before using this product, and save this manual for future use.

**More detailed operating instructions are available in “Owner’s Manual” (PDF format). To read it, download it from the website. (→ 4)**

---

**Dear Customer,**

***Thank you for choosing Panasonic!***

You have purchased one of the most sophisticated and reliable products on the market today. Used properly, we’re sure it will bring you and your family years of enjoyment. Please take time to fill in the information below. The serial number is on the tag located on the underside of your camera. Be sure to **retain this manual** as your convenient camera information source.

Date of Purchase

Dealer Phone No.

Dealer Purchased From

Model No.

Dealer Address

Serial No.

Please note that the actual controls and components, menu items, etc. of your Digital Camera may look somewhat different from those shown in the illustrations in this Owner’s Manual.

**Carefully observe copyright laws.**

Recording of pre-recorded tapes or discs or other published or broadcast material for purposes other than your own private use may infringe copyright laws. Even for the purpose of private use, recording of certain material may be restricted.

# About Owner's Manual

This document is a collection of the basic operating instructions for the camera. Refer to the "Owner's Manual" (PDF format) for detailed descriptions.

- The functions of the camera have been collected in "Contents by Function" (→ 14) and "List of Menu" (→ 151).  
Items indicated with  are described in the "Owner's Manual" (PDF format).

## ❖ Reading the "Owner's Manual" (PDF Format)



To download the "Owner's Manual" (PDF format) from a website, either enter the URL below directly, or scan the QR code.

<https://panasonic.jp/support/dsc/oi/index.html?model=DC-S5&dest=P>

- Click the desired language.



The URL and QR code above can also be accessed from the [Setup] menu, [Online Manual].

 ⇒ [  ] ⇒ [  ] ⇒ Select [Online Manual]

Settings: [URL display]/[QR Code display]

- You will need Adobe Reader to browse or print the "Owner's Manual" (PDF format).  
Download and install Adobe Reader from the following site (As of September 2020):  
<http://www.adobe.com/products/acrobat/readstep2.html>

## ❖ Symbols Used in This Document

### Symbols for recording modes, pictures, and videos that can be used













In this document, symbols are placed at the start of functional explanations (recording modes, pictures, and videos) showing conditions in which these functions can be used.

Black icons show conditions in which these can be used, and gray icons show conditions in which these cannot be used.



Example:        /  

## Operating symbols

In this document, camera operation is explained using the following symbols:





		<b>Front dial</b>
		<b>Rear dial</b>
		<b>Cursor button up/down/left/right</b> or <b>Joystick up/down/left/right</b>
		<b>Press the center of the joystick</b>
		<b>[MENU/SET] button</b>
		<b>Control dial</b>

- Other symbols, such as icons shown on the camera screen, are also used in explanations.
- This document describes the procedure for selecting menu items as follows:  
Example) Set [Picture Quality] of the [Photo] ([Image Quality]) menu to [STD.]

 →  →  → [Picture Quality] → Select [STD.]

## Notification classification symbols

In this document, notifications are classified and described using the following symbols:

	To confirm prior to using the function
	Hints for better use of the camera and tips for recording
	Notifications and supplementary items regarding specifications
	Related information and page number

- Images and illustrations used in this document are for explaining the functions.
- Description in this document is based on the interchangeable lens (S-R2060).

# Information for Your Safety

## **WARNING:**

To reduce the risk of fire, electric shock or product damage,

- Do not expose this unit to rain, moisture, dripping or splashing.
- Use the recommended accessories.
- Do not remove covers.
- Do not repair this unit by yourself. Refer servicing to qualified service personnel.

The socket outlet shall be installed near the equipment and shall be easily accessible.

## ■ Product identification marking

Product	Location
Digital camera	Bottom
Battery charger	Bottom

**THE FOLLOWING APPLIES ONLY IN THE U.S.A.****FCC Note:**

This equipment has been tested and found to comply with the limits for a Class B digital device, pursuant to Part 15 of the FCC Rules.

These limits are designed to provide reasonable protection against harmful interference in a residential installation. This equipment generates, uses, and can radiate radio frequency energy and, if not installed and used in accordance with the instructions, may cause harmful interference to radio communications. However, there is no guarantee that interference will not occur in a particular installation. If this equipment does cause harmful interference to radio or television reception, which can be determined by turning the equipment off and on, the user is encouraged to try to correct the interference by one or more of the following measures:

- Reorient or relocate the receiving antenna.
- Increase the separation between the equipment and receiver.
- Connect the equipment into an outlet on a circuit different from that to which the receiver is connected.
- Consult the dealer or an experienced radio/TV technician for help.

**FCC Caution:**

- Any unauthorized changes or modifications to this equipment would void the user's authority to operate this device.
- To assure continued compliance, follow the attached installation instructions and use only shielded interface cables with ferrite core when connecting to computer or peripheral devices.

This device complies with Part 15 of the FCC Rules. Operation is subject to the following two conditions: (1) This device may not cause harmful interference, and (2) this device must accept any interference received, including interference that may cause undesired operation.

**Supplier's Declaration of Conformity**

Trade Name: Panasonic

Model No.: DC-S5

Responsible Party: Panasonic Corporation of North America



Two Riverfront Plaza, Newark, NJ 07102-5490

Support Contact: <http://shop.panasonic.com/support>

## THE FOLLOWING APPLIES ONLY IN THE U.S.A.

### How to Display Certification and Compliance Information

Certification and compliance information for this camera can be viewed on the menu screen.

- 1 Select the  [Others] tab of the  [Setup] menu.
- 2 Select [Approved Regulations] and confirm your selection.

Contains FCC ID: VPYLB1JS955

This transmitter must not be co-located or operated in conjunction with any other antenna or transmitter.

This equipment complies with FCC radiation exposure limits set forth for an uncontrolled environment and meets the FCC radio frequency (RF) Exposure Guidelines as this equipment has very low levels of RF energy.

Compliance with FCC requirement 15.407(c)

Data transmission is always initiated by software, which is then passed down through the MAC, through the digital and analog baseband, and finally to the RF chip. Several special packets are initiated by the MAC. These are the only ways the digital baseband portion will turn on the RF transmitter, which it then turns off at the end of the packet. Therefore, the transmitter will be on only while one of the aforementioned packets is being transmitted. In other words, this device automatically discontinues transmission in case of either absence of information to transmit or operational failure.

Frequency Tolerance:  $\pm 20\text{ppm}$

## ■ About the battery pack

### CAUTION

Battery pack (Lithium ion battery pack)

- Use the specified unit to recharge the battery pack.
- Do not use the battery pack with equipment other than the specified unit.
- Do not get dirt, sand, liquids, or other foreign matter on the terminals.
- Do not touch the plug terminals (+ and -) with metal objects.
- Do not disassemble, remodel, heat or throw into fire.

If any electrolyte should come into contact with your hands or clothes, wash it off thoroughly with water.

If any electrolyte should come into contact with your eyes, never rub the eyes. Rinse eyes thoroughly with water, and then consult a doctor.



**CAUTION**

- Danger of explosion if battery is incorrectly replaced. Replace only with the type recommended by the manufacturer.
  - When disposing of the batteries, please contact your local authorities or dealer and ask for the correct method of disposal.
- 
- Do not heat or expose to flame.
  - Do not leave the battery(ies) in a car exposed to direct sunlight for a long period of time with doors and windows closed.
  - Do not expose to low air pressure at high altitudes.
  - Do not expose to extremely low air pressure, as this may result in explosions or leakage of flammable liquids and gases.

**Warning**

Risk of fire, explosion and burns. Do not disassemble, heat above 60 °C (140 °F) or incinerate.

**■ About the AC adaptor (supplied)****CAUTION!**

**To reduce the risk of fire, electric shock or product damage,**

- **Do not install or place this unit in a bookcase, built-in cabinet or in another confined space. Ensure this unit is well ventilated.**

**AC adaptor**

This AC adaptor operates on AC between 110 V and 240 V.

But

- In the U.S.A. and Canada, the AC adaptor must be connected to a 120 V AC power supply only.
- When connecting to an AC supply outside of the U.S.A. or Canada, use a plug adaptor to suit the AC outlet configuration.

## Cautions for Use

---

---

- Do not use any other USB connection cables except the supplied one.
- Always use a genuine Panasonic Shutter Remote Control (DMW-RS2: optional).
- Always use a genuine Panasonic Tripod Grip (DMW-SHGR1: optional).
- Use a "High Speed HDMI micro cable" with the HDMI logo.  
Cables that do not comply with the HDMI standards will not work.  
"High Speed HDMI micro cable" (Type D–Type A plug, up to 2 m (6.6 feet) long)
- Do not use the headphone cables with the length of 3 m (9.8 feet) or more.
- Do not use the stereo microphone cables with the length of 3 m (9.8 feet) or more.

### **Keep this unit as far away as possible from electromagnetic equipment (such as microwave ovens, TVs, video games etc.).**

- If you use this unit on top of or near a TV, the pictures and/or sound on this unit may be disrupted by electromagnetic wave radiation.
- Do not use this unit near cell phones because doing so may result in noise adversely affecting the pictures and/or sound.
- Recorded data may be damaged, or pictures may be distorted, by strong magnetic fields created by speakers or large motors.
- Electromagnetic wave radiation may adversely affect this unit, disturbing the pictures and/or sound.
- If this unit is adversely affected by electromagnetic equipment and stops functioning properly, turn this unit off and remove the battery or disconnect AC adaptor. Then reinsert the battery or reconnect AC adaptor and turn this unit on.

### **Do not use this unit near radio transmitters or high-voltage lines.**

- If you record near radio transmitters or high-voltage lines, the recorded pictures and/or sound may be adversely affected.

- 
- **Before cleaning the camera, remove the battery or the DC Coupler (DMW-DCC17: optional), or disconnect the power plug from the electrical outlet.**
  - **Do not press the monitor with excessive force.**

- Do not press the lens with excessive force.
- Do not spray the camera with insecticides or volatile chemicals.
- Do not keep products made of rubber, PVC or similar materials in contact with the camera for a long period of time.
- Do not use solvents such as benzine, thinner, alcohol, kitchen detergents, etc., to clean the camera, since it may deteriorate the external case or the coating may peel off.
- Do not leave the camera with the lens facing the sun, as rays of light from the sun may cause it to malfunction.
- Always use the supplied cords and cables.
- Do not extend the cords or the cables.
- The data on the card may be damaged or lost due to electromagnetic waves, static electricity or breakdown of the camera or the card. We recommend storing important data on another device, such as a PC.
- Do not format the card on your PC or other equipment. Format it on the camera only to ensure proper operation.

- **The battery is a rechargeable lithium ion battery. If the temperature is too high or too low, the operating time of the battery will become shorter.**
- Store the battery in a cool and dry place with a relatively stable temperature. (Recommended temperature: 15 °C to 25 °C (59 °F to 77 °F); recommended humidity: 40 %RH to 60 %RH)
- **Do not store the battery for a long time while fully charged.** When storing the battery for a long period of time, we recommend charging it once a year. Remove the battery from the camera and store it again after it has completely discharged.

## For the U.S.A. and Canada only



A lithium ion battery that is recyclable powers the product you have purchased. Please call 1-800-8-BATTERY for information on how to recycle this battery.

# Contents

About Owner's Manual.....	4
Information for Your Safety .....	6
Contents by Function .....	14

## 1. Introduction

Before Use .....	18
Standard Accessories .....	20
Names of Parts .....	22

## 2. Getting Started

Attaching a Shoulder Strap .....	27
Charging the Battery .....	28
Inserting Cards (Optional).....	31
Attaching a Lens .....	32
Adjusting the Monitor Direction and Angle .....	34
Setting the Clock (When Turning On for the First Time).....	34

## 3. Basic Operations

Monitor/Viewfinder Display Settings .....	35
Quick Menu .....	37
Control Panel .....	37
Menu Operation Methods .....	38
Selecting the Recording Mode.....	39
Intelligent Auto Mode .....	39

## 4. Image Recording

[Aspect Ratio]/[Picture Size]/ [Picture Quality].....	41
[Double Card Slot Function].....	42
[Folder / File Settings] .....	43

## 5. Focus/Zoom

Selecting the Focus Mode .....	44
Using AF.....	45
Selecting the AF Mode .....	47
AF Area Movement Operation.....	51
Record Using MF .....	52
Recording with Zoom .....	54

## 6. Drive/Image Stabilizer

Selecting the Drive Mode .....	55
Taking Burst Pictures .....	55
6K/4K Photo Recording.....	57
Selecting Pictures from a 6K/4K Burst File.....	60
Recording with Time Lapse Shot .....	61
Time Lapse Shot/Stop Motion Animation Videos .....	62
Recording Using the Self-timer .....	63
Bracket Recording.....	64
[Live View Composite].....	65
Image Stabilizer.....	67

## 7. Metering/Exposure/ ISO Sensitivity

[Metering Mode] .....	71
Program AE Mode.....	71
Aperture-Priority AE Mode .....	72
Shutter-Priority AE Mode.....	73
Manual Exposure Mode .....	74
Exposure Compensation .....	75
Locking Focus and Exposure (AF/AE Lock).....	76
ISO Sensitivity .....	77

<b>8. White Balance/ Image Quality</b>	
White Balance (WB) .....	79
[Photo Style] .....	81
[Filter Settings].....	84
[High Resolution Mode] .....	86
[HLG Photo].....	89
<b>9. Flash</b>	
Using an External Flash (Optional).....	91
<b>10. Recording Videos</b>	
Recording Videos .....	93
Recording Modes Specifically for Video (Creative Video/S&Q).....	96
Video Recording Settings .....	99
Time Code .....	104
Using AF (Video) .....	106
Video Brightness and Coloring .....	108
Audio Settings .....	112
Main Assist Functions.....	113
Slow & Quick Video .....	118
[Live Cropping] .....	120
Log Recording .....	123
HLG Videos .....	126
Anamorphic Recording.....	129
List of Recording Qualities That Enable Special Videos to be Recorded .....	133
<b>11. Connections with External Devices (Video)</b>	
HDMI Devices (HDMI Output) .....	135
[HDMI Rec Output] .....	138
External Microphones (Optional) .....	139
XLR Microphone Adaptor (Optional).....	141
Headphones .....	142
<b>12. Playing Back and Editing of Images</b>	
Playing Back Images .....	144
Switching the Display Mode.....	145
Deleting Images.....	146
<b>13. Camera Customization</b>	
Fn Buttons .....	147
Custom Mode .....	148
[Save/Restore Camera Setting] .....	150
<b>14. List of Menu</b>	
List of Menu .....	151
<b>15. Wi-Fi/Bluetooth</b>	
Connecting to a Smartphone .....	156
Operating the Camera with a Smartphone .....	160
<b>16. Connecting to Other Devices</b>	
Importing Images to a PC .....	164
Installing Software .....	165
<b>17. Materials</b>	
Digital Camera Accessory System.....	168
Monitor/Viewfinder Displays.....	169
Message Displays.....	175
Troubleshooting .....	176
Specifications.....	178
Index .....	184
Trademarks and Licenses .....	189
Limited Warranty (ONLY FOR U.S.A.).....	192

# Contents by Function

[PDF]: Described in the "Owner's Manual" (PDF format). (→ 4)

## Power Source

Charging	→ 28
Charging error	→ 29
	→ 30
Battery indication	→ 31
Power supply	→ 31
Power save function	→ [PDF]
Number of pictures that can be taken, available recording time	→ [PDF]

## Card

Cards that can be used	→ 31
[Card Format]	→ 32
[Double Card Slot Function]	→ 42
[Destination Card Slot]	→ 42
Switching the playback card	→ 145
Folder structure	→ 164
[Folder / File Settings]	→ 43
[File Number Reset]	→ [PDF]
Entering characters	→ [PDF]
Number of pictures, length of recording time	→ [PDF]

## Lens

Attaching	→ 32
[Focal Length Set]	→ 70

## Basic Settings

[Language]	→ [PDF]
[Clock Set]	→ 34
[Time Zone]	→ 34
[Beep]	→ [PDF]
[Copyright Information]	→ [PDF]

[Reset]	→ 38
---------	------

## Viewfinder

Dioptr adjustment	→ 35
Eye sensor	→ 35
[Eye Sensor AF]	→ [PDF]

## Display

Recording screen	→ 169
Playback screen	→ [PDF]
Viewfinder	→ [PDF]
Control panel	→ 37
	→ 173
Switching display	→ 35
Monitor/viewfinder adjustment	→ [PDF]
Monitor/viewfinder luminance	→ [PDF]
Display speed	→ [PDF]
Level gauge	→ [PDF]
Grid lines	→ [PDF]
[Histogram]	→ [PDF]
[Sheer Overlay]	→ [PDF]
Checking overexposure	→ [PDF]
[V-Log View Assist]	→ 125
[HLG View Assist]	→ 128

## AF/MF

Focus mode	→ 44
[Continuous AF]	→ 106
Selecting the AF mode	→ 47
Face/eye/human detection	→ 48
Animal detection	→ 48
Movement tracking	→ 49

[AF ON]	→ 45
Moving the AF area	→ 51
Enlarged display	→ 45 → 53
Setting the AF sensitivity	→ 46 → 107
AF/AE Lock	→ 76
Touch AF	→ <a href="#">PDF</a>
[Touch Pad AF]	→ <a href="#">PDF</a>
[AF Assist Light]	→ <a href="#">PDF</a>
MF	→ 52
[MF Guide]	→ <a href="#">PDF</a>
[MF Assist]	→ <a href="#">PDF</a>
[Focus Peaking]	→ <a href="#">PDF</a>

### Image Stabilizer

[Image Stabilizer]	→ 67
[Operation Mode]	→ 69
[E-Stabilization (Video)]	→ 68
[Boost I.S. (Video)]	→ 69
[Anamorphic (Video)]	→ 70
[Focal Length Set]	→ 70

### Drive

Drive mode	→ 55
Burst	→ 55
[6K/4K PHOTO]	→ 57
[Time Lapse Shot]	→ 61
Recording with Stop Motion Animation	→ <a href="#">PDF</a>
[Self Timer]	→ 63
[Post-Focus]	→ <a href="#">PDF</a>

### Image Quality

[Picture Size]	→ 41
[Picture Quality]	→ 41
RAW	→ 41
JPEG	→ 41
Aspect ratio	→ 41
[White Balance]	→ 79
[Photo Style]	→ 81
[Filter Settings]	→ 84
[Color Space]	→ <a href="#">PDF</a>
[Reduce Rolling Shutter]	→ <a href="#">PDF</a>
[6K/4K PHOTO Noise Reduction]	→ <a href="#">PDF</a>
[Long Exposure NR]	→ <a href="#">PDF</a>
[i.Dynamic Range]	→ <a href="#">PDF</a>
[Vignetting Comp.]	→ <a href="#">PDF</a>
[Diffraction Compensation]	→ <a href="#">PDF</a>

### Taking Pictures

Recording mode	→ 39
Quick menu	→ 37
Zoom	→ 54
[Ex. Tele Conv.]	→ <a href="#">PDF</a>
Bracket recording	→ 64
[Live View Composite]	→ 65
Bulb recording	→ 74
[High Resolution Mode]	→ 86
[Multiple Exposure]	→ <a href="#">PDF</a>
[HLG Photo]	→ 89
[Shutter Type]	→ <a href="#">PDF</a>
[Silent Mode]	→ <a href="#">PDF</a>
Remote control recording	→ <a href="#">PDF</a>
Screen display	→ 169

Exposure	
[Exposure Comp.]	→ 75
Program Shift	→ 72
Preview mode	→ <a href="#">PDF</a>
[Metering Mode]	→ 71
AE Lock	→ 76
[One Push AE]	→ <a href="#">PDF</a>
[Touch AE]	→ <a href="#">PDF</a>
[Sensitivity]	→ 77
[Extended ISO]	→ <a href="#">PDF</a>

Flash	
External flash	→ 91
[Firing Mode]	→ <a href="#">PDF</a>
[Flash Mode]	→ 92
[Flash Adjust.]	→ <a href="#">PDF</a>
[Flash Synchro]	→ <a href="#">PDF</a>
[Wireless Flash Setup]	→ <a href="#">PDF</a>

Video Recording	
Video recording	→ 93
[Switch NTSC/PAL]	→ 99
[Image Area of Video]	→ 100
Creative Video mode	→ 96
Slow & Quick mode	→ 96
	→ 118
[Live Cropping]	→ 120
Log recording (V-Log)	→ 123
HLG video	→ 126
Anamorphic Recording	→ 129
[Time Code]	→ 104
Remote control recording	→ <a href="#">PDF</a>

Display (Video)	
[Waveform Monitor]	→ 113
[Luminance Spot Meter]	→ 115
[Zebra Pattern]	→ 116
[Frame Marker]	→ 117

Image Quality (Video)	
[Rec. File Format]	→ 100
[Rec Quality]	→ 101
Resolution	→ 101
Recording frame rate	→ 101
Bit rate	→ 101
[Flicker Decrease (Video)]	→ <a href="#">PDF</a>

Exposure (Video)	
Exposure settings	→ 94
	→ 98
Luminance level	→ 108
Knee	→ 109

Audio	
External microphone	→ 139
XLR Microphone Adaptor	→ 141
Headphones	→ 142
[Sound Output]	→ 142
[Sound Rec Level Disp.]	→ 112
[Sound Rec Level Adj.]	→ 112
Wind noise reduction	→ 112
Attenuator	→ 112



**Playback**

[Auto Review]	→ PDF
Playing back pictures	→ 144
Playing back videos	→ 144
Thumbnail display	→ 145
Calendar display	→ 145
Enlarged display	→ 145
Group images	→ PDF
Saving 6K/4K photos	→ 60
Viewing on a TV	→ 162
Deleting	→ 146
Screen display	→ PDF
[Slide Show]	→ PDF

**Editing of Images**

[RAW Processing]	→ PDF
[Protect]	→ PDF
[Rating]	→ PDF
[Resize]	→ PDF
[Rotate]	→ PDF
[Video Divide]	→ PDF
[Copy]	→ PDF

**Customization**

[Custom] menu	→ PDF
Function button	→ 147
Custom recording mode	→ 148
[My Menu]	→ PDF
Quick menu	→ PDF
Dial operation	→ PDF
Saving camera settings	→ 150

**Connecting with Other Devices**

Sending images (PC)	→ 163
Printing	→ PDF
Viewing on a TV	→ 162
HDMI output	→ 135
Tethered recording	→ PDF

**Wi-Fi/Bluetooth**

Bluetooth connection	→ 157
[Wi-Fi connection]	→ PDF
[Wi-Fi Setup]	→ PDF
Smartphone app "LUMIX Sync"	→ 156
[Remote shooting]	→ 160
Location information	→ PDF
Sending images ([Smartphone])	→ 161
Sending images ([PC])	→ PDF
Sending images ([Printer])	→ PDF
Sending images ([Web service])	→ PDF
Sending images ([Cloud Sync. Service])	→ PDF
Saving camera settings	→ PDF
"LUMIX CLUB"	→ PDF

**Software**

"PHOTOfunSTUDIO"	→ 165
"SILKYPIX"	→ 166
"LUMIX Tether"	→ 167

**Maintenance**

[Sensor Cleaning]	→ PDF
[Pixel Refresh]	→ PDF

# 1. Introduction

## Before Use

### ❖ Firmware of Your Camera/Lens

Firmware updates may be provided in order to improve camera capabilities or to add functionality. For smoother recording, we recommend updating the firmware of the camera/lens to the latest version.

- **For the latest information on the firmware or to download/update the firmware, visit the following support site:**

**<https://panasonic.jp/support/global/cs/dsc/>**

(English only)

- To check the firmware version of the camera/lens, attach the lens to the camera and select [Firmware Version] in the [Setup] ([Others]) menu. You can also update the firmware in [Firmware Version].
- You can also update the firmware from a smartphone. For details, refer to [Help] in "LUMIX Sync". (→ 156)
- This document provides explanations for camera firmware version 1.0. Changes after firmware update are detailed in the "Owner's Manual" (PDF format). Refer to this by downloading from the website. (→ 4)



### ❖ Handling of the Camera

**When using the camera, take care not to drop it, bump it, or apply undue force. These may cause malfunction or damage to the camera and lens.**

**If sand, dust, or liquid gets on the monitor, wipe it off with a dry soft cloth.**

– Touch operations may be incorrectly recognized.

**Do not place a hand inside the camera mount.**

**This may cause a failure or damage because the sensor is a precision device.**

**The sensor can move, making a rattling noise, when the camera is shaken while it is off. This is caused by the image stabilizer mechanism in the body. It is not a malfunction.**

## ❖ **Splash Resistant**

**Splash Resistant is a term used to describe an extra level of protection this camera offers against exposure to a minimal amount of moisture, water or dust. Splash Resistant does not guarantee that damage will not occur if this camera is subjected to direct contact with water.**

**In order to minimize the possibility of damage please be sure the following precautions are taken:**

- Splash Resistant works in conjunction with the lenses that were specifically designed to support this feature.
- Securely close the doors, contact points cover, etc.
- When the lens or cap is removed or a door is open, do not allow sand, dust, and moisture to enter inside.
- If liquid gets on the camera, wipe it off with a dry soft cloth.

## ❖ **Condensation (When the Lens, the Viewfinder or Monitor is Fogged Up)**

- Condensation occurs when there are temperature or humidity differences. Take care as this may lead to soiling, mold, and malfunctions in the lens, viewfinder, and monitor.
- If condensation occurs, turn off the camera and leave it for approx. 2 hours. The fog will disappear naturally when the temperature of the camera becomes close to the ambient temperature.

## ❖ **Be Sure to Perform Trial Recording in Advance**

Perform trial recording in advance of an important event (wedding, etc.) to check that recording can be performed normally.

## ❖ **No Compensation Regarding Recording**

Please note that compensation cannot be provided in the event that recording could not be performed due to a problem with the camera or a card.

## ❖ **Be Careful with Regard to Copyrights**

Under copyright law, you may not use the images and audio you have recorded for other than personal enjoyment without the permission of the copyright holder. Be careful because there are cases where restrictions apply to recording even for the purpose of personal enjoyment.

## ❖ **Also Refer to the Cautions for Use in the “Owner’s Manual” (PDF Format)**

## Standard Accessories

### Digital camera body

(This is referred to as **camera** in this document.)



### USB connection cable



K1HY24YY0021

Check that all the accessories are supplied before using the camera.

(Product numbers correct as of September 2020.)

### Shoulder strap



DVPW1023Z

### Battery pack

(This is referred to as **battery pack** or **battery** in this document.)

- Charge the battery before use.



DMW-BLK22

### Body cap\*<sup>1</sup>



1HE1MC891Z

### Battery charger

(This is referred to as **battery charger** or **charger** in this document.)

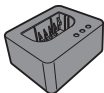

DVLC1005Z

### Hot shoe cover\*<sup>1</sup>



DVYE1121Z

### AC adaptor

- This is used for charging and power supply.



VSK0815F

### Cover for the battery grip connector\*<sup>1</sup>



SKF0145K

\*<sup>1</sup> This is attached to the camera at the time of purchase.

**Items Supplied with DC-S5K (Lens Kit Product)****35 mm full-frame interchangeable lens**

- This lens is dust and splash resistant.

**Lens cap\*2****Lens hood****Lens rear cap\*2**

\*2 This is attached to the lens at the time of purchase.

- **The memory card is optional.**
- If accessories are lost, customers can visit us at <http://shop.panasonic.com/support> for further information about obtaining replacement parts.

# Names of Parts

## Camera

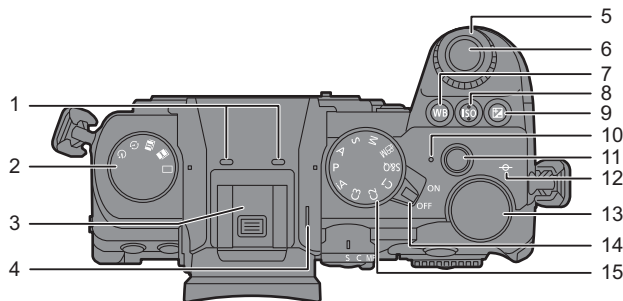

1	<p>Stereo microphone (→ 112)</p> <ul style="list-style-type: none"> <li>Do not block the microphone with a finger. Audio will be difficult to record.</li> </ul>
2	Drive mode dial (→ 55)
3	<p>Hot shoe (hot shoe cover) (→ 91)</p> <ul style="list-style-type: none"> <li>Keep the hot shoe cover out of reach of children to prevent swallowing.</li> </ul>
4	Speaker
5	Front dial (→ 5)
6	Shutter button (→ 40)
7	[WB] (White balance) button (→ 79)

8	[ISO] (ISO sensitivity) button (→ 77)
9	[] (Exposure compensation) button (→ 75)
10	Charging light (→ 30)/ Wireless connection light (→ 156)
11	Video rec. button (→ 93)
12	[] (Recording distance reference mark)
13	Rear dial (→ 5)
14	Camera on/off switch (→ 34)
15	Mode dial (→ 39)

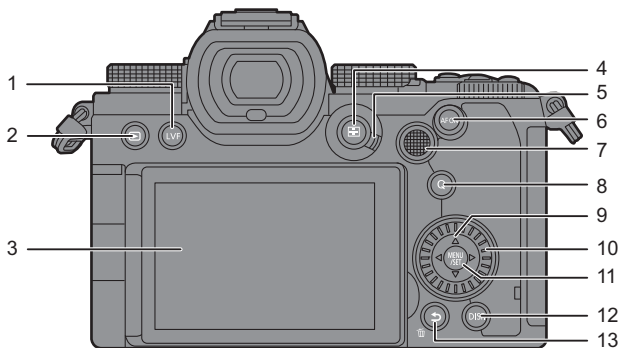

1	[LVF] button (→ 35)	8	[Q] (Quick menu) button (→ 37)
2	[▶] (Playback) button (→ 144)		Cursor buttons/ Fn buttons (→ 147)
3	Monitor (→ 169)/ Touch screen	9	▲: Fn13, ►: Fn14, ▼: Fn15, ◄: Fn16
4	[AF-ON] (AF mode) button (→ 45)	10	Control dial (→ 5)
5	Focus mode lever (→ 44, 45, 52)	11	[MENU/SET] button (→ 38)
6	[AF ON] button (→ 45)	12	[DISP.] button (→ 35)
7	Joystick/ Fn buttons (→ 147) Center: Fn8, ▲: Fn9, ►: Fn10, ▼: Fn11, ◄: Fn12	13	[↵] (Cancel) button (→ 36)/ [🗑️] (Delete) button (→ 146)/ Fn button (Fn1) (→ 147)

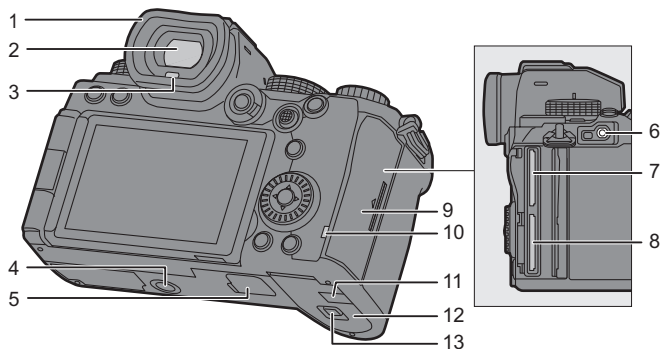

1	Eye cup
2	Viewfinder (→ 35, 169)
3	Eye sensor (→ 35)
4	<p>Tripod mount</p> <ul style="list-style-type: none"> <li>If you attempt to attach a tripod with a screw length of 5.5 mm (0.22 inches) or more, you may not be able to securely fix it in place or it may damage the camera.</li> </ul>
5	<p>Battery grip connector (cover for the battery grip connector)</p> <ul style="list-style-type: none"> <li>Keep the cover for the battery grip connector out of reach of children to prevent swallowing.</li> </ul>
6	[REMOTE] socket
7	Card slot 1 (→ 32)
8	Card slot 2 (→ 32)

9	Card door (→ 31)
10	Card access light (→ 32)
11	<p>DC coupler cover</p> <ul style="list-style-type: none"> <li>When using an AC adaptor, ensure that the Panasonic DC Coupler (DMW-DCC17: optional) and AC Adaptor (DMW-AC10PP: optional) are used.</li> <li>Always use a genuine Panasonic AC Adaptor (DMW-AC10PP: optional).</li> <li>When using an AC Adaptor (optional), use the AC cable supplied with the AC Adaptor (optional).</li> </ul>
12	Battery door (→ 29)
13	Battery door release lever (→ 29)



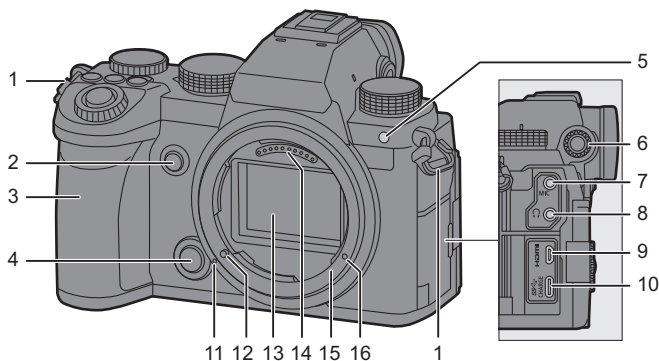

<b>1</b>	Shoulder strap eyelet (→ 27)	<b>9</b>	[HDMI] socket (→ 135, 162)
<b>2</b>	Preview button/ Fn button (Fn2) (→ 147)	<b>10</b>	USB port (→ 30, 163)
<b>3</b>	Grip	<b>11</b>	Lens fitting mark (→ 33)
<b>4</b>	Lens release button (→ 33)	<b>12</b>	Lens lock pin
<b>5</b>	Self-timer light (→ 63)/ AF assist light	<b>13</b>	Sensor
<b>6</b>	Diopter adjustment dial (→ 35)	<b>14</b>	Contact points
<b>7</b>	[MIC] socket (→ 139)	<b>15</b>	Mount
<b>8</b>	Headphone socket (→ 142) • Excessive sound pressure from earphones and headphones can cause hearing loss.	<b>16</b>	Screw hole for function expansion

## Supplied Lens

### S-R2060

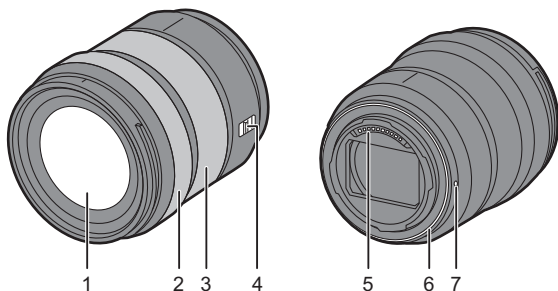

1	Lens surface
---	--------------

2	Focus ring (→ 53)
---	-------------------

3	Zoom ring (→ 54)
---	------------------

4	[AF/MF] switch (→ 45, 52)
---	---------------------------

- You can switch between AF and MF.
- If [MF] is set on either the lens or camera, operation will be with MF.

5	Contact points
---	----------------

6	Lens mount rubber
---	-------------------

7	Lens fitting mark (→ 33)
---	--------------------------



- Recording at or near the closest focusing distance at wide angle will degrade image quality around the edges of the image. We recommend checking each picture after you have taken it when recording.

## 2. Getting Started

- When preparing, make sure the camera on/off switch is [OFF].

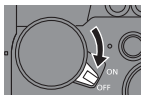

### Attaching a Shoulder Strap

Attach a shoulder strap to the camera with the following procedure to prevent it from dropping.

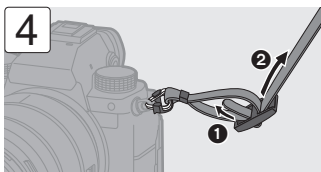
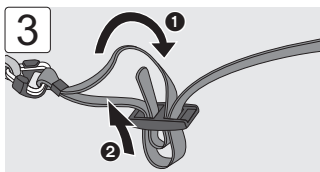
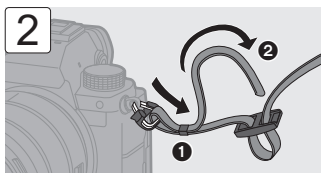
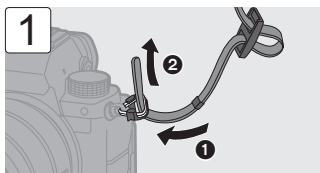

- Pull the shoulder strap and check that it will not come out.
- Attach the opposite end of the shoulder strap with the same procedure.
- Use the shoulder strap around your shoulder.
  - Do not wrap the strap around your neck.  
It may result in injury or accident.
- Do not leave the shoulder strap where an infant can reach it.
  - It may result in an accident by mistakenly wrapping around the neck.

## Charging the Battery

You can charge the battery either using the supplied charger, or in the camera body.

- The battery that can be used with the camera is DMW-BLK22. (As of September 2020)



- The battery is not charged at the time of purchase. Charge the battery before use.
- **Use the products supplied with the camera for charging.**
- Do not use any other USB connection cables except the supplied one.
- Do not use any other AC adaptors except the supplied one.

### ❖ Charging with the Charger

Charging time	Approx. 230 min
---------------	-----------------

- Use the supplied charger and AC adaptor.

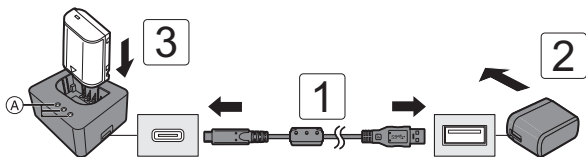

#### 1 Connect the charger and the AC adaptor with the USB connection cable.

- Check the direction of the terminals and plug in/out straight holding onto the plug.  
(Inserting these at an angle may cause deformation or malfunction)

#### 2 Connect the AC adaptor to an electrical outlet.

#### 3 Insert the battery.

- The charging lights ([CHARGE]) (A) blink and charging begins.

## Charging Lights Indications

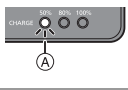
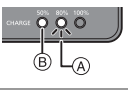
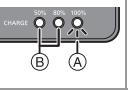
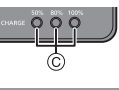
Charging status	0 % to 49 %	50 % to 79 %	80 % to 99 %	100 %
Charging lights				
	(A) Blinking	(B) On	(C) Off	

- If the [50%] light is blinking quickly, then charging is not occurring.
- When the battery is inserted while the charger is not connected to the power source, the charging lights turn on for a certain period to allow you to confirm the battery level.

## ❖ Battery Insertion

- Always use genuine Panasonic batteries (DMW-BLK22).
- If you use other batteries, we cannot guarantee the quality of this product.

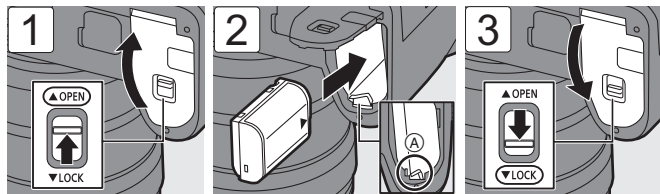

- Check that the lever (A) is holding the battery in place.
- When removing the battery, press down on lever (A).

## ❖ Inserting a Battery into the Camera for Charging

Charging time	Approx. 240 min
---------------	-----------------

- Using the camera body and the supplied AC adaptor.

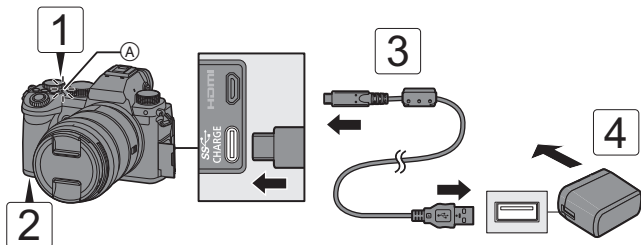

- 1 Set the camera on/off switch to [OFF].**
- 2 Insert the battery into the camera.**
- 3 Connect the camera USB port and the AC adaptor using the USB connection cable.**
  - Check the direction of the terminals and plug in/out straight holding onto the plug.  
(Inserting these at an angle may cause deformation or malfunction)
- 4 Connect the AC adaptor to an electrical outlet.**
  - The charging light (A) turns red and charging begins.

### Charging Light Indications

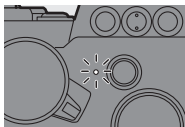

#### Charging light (red)

- On: Charging.
- Off: Charging has completed.
- Blinking: Charging error.



- Even when the camera on/off switch is set to [OFF] thus turning the camera off, it consumes power.  
When the camera will not be used for a long time, remove the power plug from the electrical outlet in order to save power.

## ❖ Power Supply







When the battery is inserted into the camera for charging and the camera is turned on, you can record while the camera is being supplied with power.

-  is displayed in the screen while power is being supplied.



- The battery cannot be charged while power is being supplied.
- Turn off the camera before connecting or disconnecting the AC adaptor.

## ❖ Battery Indication Display

Battery indication	80 % or higher	60 % to 79 %	40 % to 59 %	20 % to 39 %	19 % or below	Low battery
Indication on monitor						 Blinking

- You can use the sleep function to reduce battery consumption.

 ⇒  ⇒  ⇒ Select [Power Save Mode]

## Inserting Cards (Optional)

### ❖ Memory Cards That Can Be Used

You can use the following memory cards with this camera.

<b>SD memory card</b> (512 MB to 2 GB)	The SDHC/SDXC cards supported by card slot 1 and 2 on this camera are different.	
<b>SDHC memory card</b> (4 GB to 32 GB)	<ul style="list-style-type: none"> <li>• Card slot 1               <ul style="list-style-type: none"> <li>– UHS Speed Class 3 of the UHS-I/UHS-II standard</li> <li>– Video Speed Class 90 of the UHS-II standard</li> </ul> </li> <li>• Card slot 2               <ul style="list-style-type: none"> <li>– UHS Speed Class 3 of the UHS-I standard</li> </ul> </li> </ul>	
<b>SDXC memory card</b> (48 GB to 128 GB)	<ul style="list-style-type: none"> <li>• Operation with the Panasonic cards on the left has been verified.</li> </ul>	

- When recording **72 Mbps video**, use cards compatible with SD Speed Class 10, UHS Speed Class 1 or higher, or Video Speed Class 10 or higher.
- When recording **100 Mbps to 200 Mbps video**, **[6K/4K PHOTO]**, or **[Post-Focus]**, use cards compatible with UHS Speed Class 3 or Video Speed Class 30 or higher.

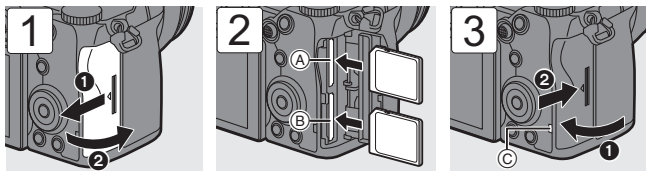

(A) Card slot 1 (compatible with UHS-I/UHS-II)

(B) Card slot 2 (compatible with UHS-I)

- Match the orientation of the cards as shown in the figure and then insert them firmly until they click.
- To remove the card, push the card until it clicks, then pull the card out straight.
- Do not turn off the camera or remove the battery or card until the card access light (C) turns off.
- Format the cards with the camera before use.

 ⇒ [  ] ⇒ [  ] ⇒ Select [Card Format]



- Keep the memory card out of reach of children to prevent swallowing.

## Attaching a Lens

### ❖ Lenses That Can Be Used

The lens mount of this camera is compliant with the L-Mount standard of Leica Camera AG.

It can be used with 35 mm full-frame interchangeable lenses and APS-C size interchangeable lenses of this standard.

- Refer to catalogs/websites for most current information regarding supported lenses.

<https://panasonic.jp/support/global/cs/dsc/>

(English only)





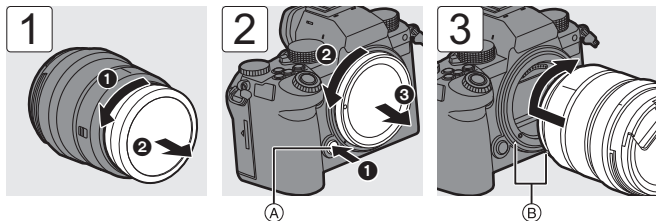

- When removing the lens or body cap, rotate while pressing the lens release button (A).
- (B) Lens fitting marks

### ❖ Attaching a Lens Hood

When attaching the lens hood (flower shape) supplied with the interchangeable lens (S-R2060)

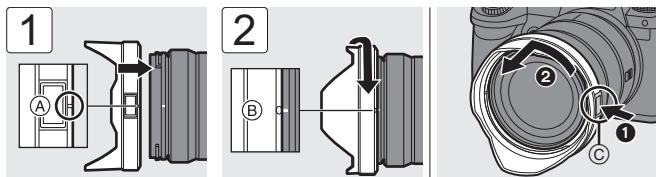

- 1 Align mark (A) (□) on the lens hood with the mark on the tip of the lens.
  - 2 Rotate the lens hood in the direction of the arrow to align mark (B) (○) on the lens hood with the mark on the tip of the lens.
- When removing the lens hood, rotate while pressing the lens hood button (C).

## Adjusting the Monitor Direction and Angle

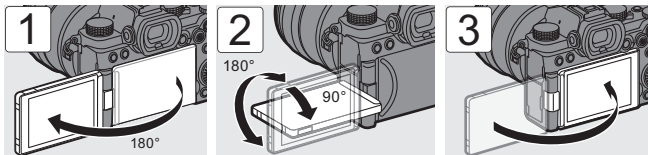

## Setting the Clock (When Turning On for the First Time)

When you turn the camera on for the first time, a screen to set the time zone and clock appears. Follow the message to make the settings.

**1**

**2**

- Press ▲▼ to select the language if a language selection screen is displayed.

Time zone selection

Year, month, day, hour, minute, and second selection

Daylight Savings setting

Value selection

Check or confirm and move to the next screen

# 3. Basic Operations

## Monitor/Viewfinder Display Settings

### Setting the Viewfinder

- Adjust the diopter until you can clearly see the text in the viewfinder.

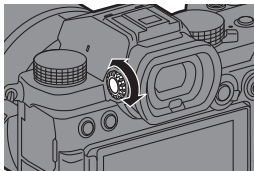

### Switching Between the Monitor and Viewfinder

When you press [LVF] (A), you switch between automatic viewfinder/monitor switching, viewfinder display, and monitor display.

- When automatic viewfinder/monitor switching is on, the eye sensor (B) works when you look into the viewfinder and the display automatically switches to the viewfinder.

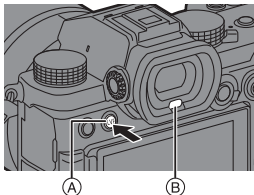

### Switching the Display Information

Press [DISP.].

- The display information is switched.

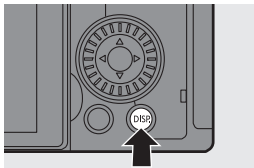

## ❖ Recording Screen

### Monitor

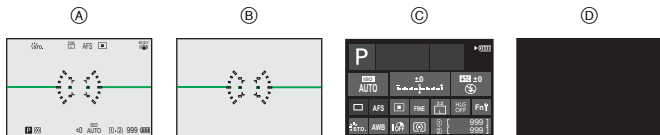

### Viewfinder

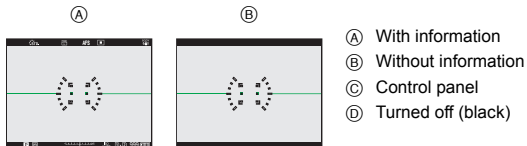

- (A) With information
- (B) Without information
- (C) Control panel
- (D) Turned off (black)



• Press [↔] to switch between display/hide of the level gauge.

## ❖ Playback Screen

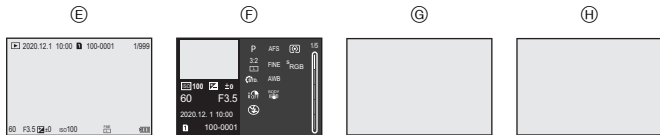

- (E) With information
- (F) Detailed information display
- (G) Without information
- (H) Without blinking highlights\*

\* This is a screen without blinking highlights display that is shown when [Blinking Highlights] of the [Custom] ([Monitor / Display (Photo)]) menu is set to [ON].  
In other than this screen, overexposed parts of the screen will blink.

## Quick Menu

This menu enables you to quickly set functions that are frequently used during recording without calling up the menu screen.

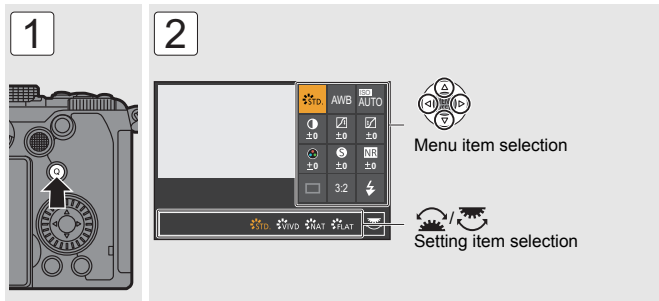

- Press the shutter button halfway to close.



- The Quick menu can be customized:

[ ] → [ ] → [Q.MENU Settings] (→ 153)

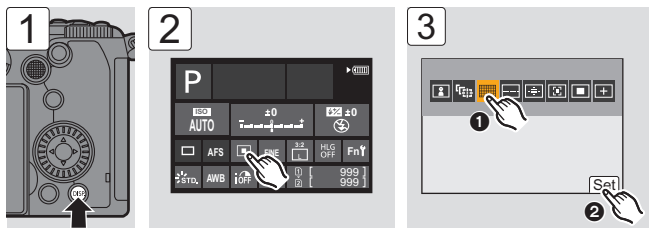

## Control Panel

This screen allows you to view the current recording settings on the monitor. You can also touch the screen to change the settings.

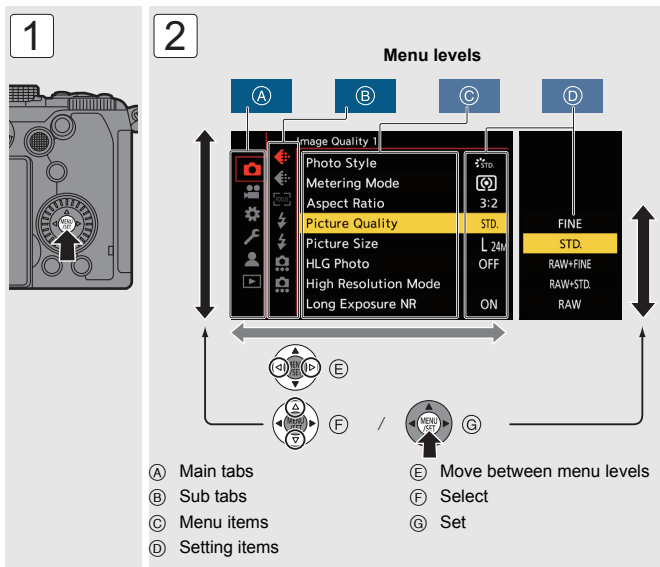

# Menu Operation Methods



- If you press [DISP.] while a menu item or setting item is selected, a description about the item is displayed on the screen.
- Menu items that cannot be set are displayed grayed out.  
If you press  or  while a grayed out menu item is selected, the reason why it cannot be set is displayed.
- Press the shutter button halfway to close.
- The menu settings can be returned to the default settings.

 ⇒  ⇒  ⇒ Select [Reset]



- Refer to "List of Menu" (→ 151) or the "Owner's Manual" (PDF format) for details about menu items.
- Refer to the "Owner's Manual" (PDF format) for a list of default settings and reset targets.

## Selecting the Recording Mode

Rotate the mode dial to select the recording mode.

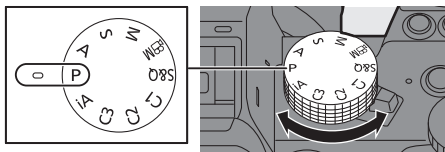

[iA]	Intelligent Auto mode (→ 39)
[P]	Program AE mode (→ 71)
[A]	Aperture-Priority AE mode (→ 72)
[S]	Shutter-Priority AE mode (→ 73)
[M]	Manual Exposure mode (→ 74)
[M]	Creative Video mode (→ 96)
[S&Q]	Slow & Quick mode (→ 118)
[C1]/[C2]/[C3]	Custom mode (→ 148)

## Intelligent Auto Mode

iA P A S M  S&Q



The [iA] mode (Intelligent Auto mode) can record images using settings automatically selected by the camera.

The camera detects the scene to set the optimal recording settings automatically to match the subject and recording conditions.

### 1 Set the mode dial to [iA].

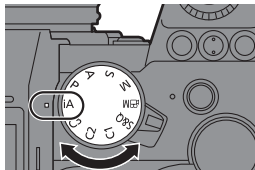

## 2 Aim the camera at the subject.

- When the camera detects the scene, the recording mode icon changes.  
(Automatic Scene Detection)



## 3 Adjust the focus.

- Press the shutter button halfway (press it gently).
- The aperture value (A) and shutter speed (B) are displayed.  
(When the correct exposure cannot be obtained, the indications blink in red.)
- Once the subject is in focus, the focus icon (C) lights.  
(When the subject is not in focus, the icon blinks.)
- [ ] of the AF mode works and the AF area is displayed aligned to any humans.

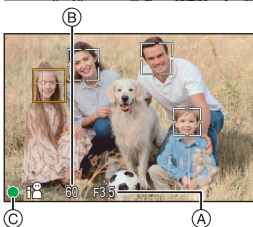
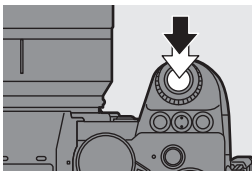

## 4 Start recording.

- Press the shutter button fully (press it further).

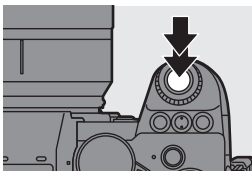

- Each press of [ ] changes the AF mode ([ ]/[ ]) ([Face/Eye/Body/Animal Detect.])/[ ] ([Tracking]).  
For information about AF modes, refer to page 48 and 49.
- When recording using a flash, the camera switches to the appropriate flash mode for the recording conditions.



# 4. Image Recording



## [Aspect Ratio]/[Picture Size]/[Picture Quality]

iA P A S M  S&Q





### [Aspect Ratio]

You can select the image aspect ratio.

 → [  ] → [  ] → Select [Aspect Ratio]  
Settings: [4:3]/[3:2]/[16:9]/[1:1]/[65:24]/[2:1]

### [Picture Size]

Sets the picture's image size.

 → [  ] → [  ] → Select [Picture Size]  
Settings: [L]/[M]/[S]

### [Picture Quality]

Set the compression rate used for storing pictures.

 → [  ] → [  ] → Select [Picture Quality]



Setting	File format
[FINE]	JPEG
[STD.]	

Setting	File format
[RAW+FINE]	RAW+JPEG
[RAW+STD.]	
[RAW]	RAW

➔ • Refer to the "Owner's Manual" (PDF format) for details about [Aspect Ratio], [Picture Size], and [Picture Quality].

## [Double Card Slot Function]

This sets the way recording to the card slots 1 and 2 is performed.

 ⇒  ⇒  ⇒ Select [Double Card Slot Function]

[Recording Method]	 [Relay Rec]	Selects the priority of card slots for recording. <b>[Destination Card Slot]: [1→2]/[2→1]</b> Relays recording to the card in the other card slot after the first card runs out of free space.
	 [Backup Rec]	Records the same images to both cards simultaneously.
	 [Allocation Rec]	Allows you to specify the card slot to be used for recording for different image formats. <b>[JPEG/HLG Photo Destn.]/[RAW Destination]/[6K/4K Photo Destination]/[Video Destination]</b>



### Notes about Backup Recording

- We recommend using cards with the same Speed Class rating and capacity. If the card Speed Class or capacity is insufficient when video recording, recording to both cards stops.
- When using the following combinations of cards, backup recording for videos, 6K/4K photos, and [Post-Focus] are not available:
  - SD/SDHC memory card, and SDXC memory card

# [Folder / File Settings]

Set the folder and file name where to save the images.

Folder name		File name	
100ABCDE 		PABC0001.JPG 	
<b>1</b>	Folder number (3 digits, 100 to 999)	<b>3</b>	Color space ([P]: sRGB, [_]: AdobeRGB)
<b>2</b>	5-character user-defined segment	<b>4</b>	3-character user-defined segment
		<b>5</b>	File number (4 digits, 0001 to 9999)
		<b>6</b>	Extension



⇒ [ ] ⇒ [ [ ^ ] ] ⇒ Select [Folder / File Settings]

<b>[Select Folder]*</b>	Selects a folder for storing images.	
<b>[Create a New Folder]</b>	Creates a new folder with an incremented folder number. • If there are no recordable folders in the card, a screen for resetting the folder number is displayed.	
	<b>[OK]</b>	Increments the folder number without changing the 5-character user-defined segment ( <b>2</b> above).
	<b>[Change]</b>	Changes the 5-character user-defined segment ( <b>2</b> above). This will also increment the folder number.
<b>[File Name Setting]</b>	<b>[Folder Number Link]</b>	Uses the 3-character user-defined segment ( <b>4</b> above) to set the folder number ( <b>1</b> above).
	<b>[User Setting]</b>	Changes the 3-character user-defined segment ( <b>4</b> above).

\* When [Double Card Slot Function] is set to [Allocation Rec], [Select Folder (Slot 1)] and [Select Folder (Slot 2)] will be displayed.

• Available characters: alphabetic characters (upper-case), numerals, [ \_ ]



- Each folder can store up to 1000 files.
- [Select Folder] is not available when [Backup Rec] in [Double Card Slot Function] is being used.

# 5. Focus/Zoom

## Selecting the Focus Mode

iA P A S M  S&Q



Select the focusing method (focus mode) to match subject movement.

**Set the focus mode lever.**

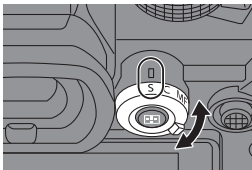

<b>[S]</b> ([AFS])	This is suitable for recording still subjects. When the shutter button is pressed halfway, the camera focuses once. The focus stays locked while the shutter button is pressed halfway.
<b>[C]</b> ([AFC])	This is suitable for recording moving subjects. While the shutter button is pressed halfway, the focus is constantly adjusted according to the movement of the subject. <ul style="list-style-type: none"><li>• This predicts the movement of the subject, maintaining focusing. (Movement prediction)</li></ul>
<b>[MF]</b>	Manual focusing. Use this when you want to fix the focus or avoid activating AF. (→ 52)

# Using AF

iA P A S M  S&Q





AF (Auto Focus) refers to automatic focusing.

Select the focus mode and the AF mode appropriate for the subject and scene.

## 1 Set the focus mode to [S] or [C].

- Set the focus mode lever. (→ 44)

## 2 Select the AF mode.

- Press [  ] to display the AF mode selection screen, and set using  or . (→ 47)

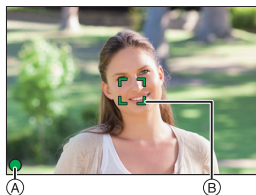

## 3 Press the shutter button halfway.

- The AF operates.
- You can also activate AF by pressing [AF ON].



	Focus: In focus	Focus: Not in focus
Focus icon (A)	Lights	Blinking
AF area (B)	Green	Red
AF beep	Two beeps	—

- In dark environments, low illumination AF automatically operates, and the focus icon is indicated as [LOW].
- If the camera detects stars in the night sky after determining low illumination AF, then Starlight AF will be activated.  
When focus is achieved, the focus icon will display [STAR].
- **[AF-Point Scope]**

This magnifies the focus point when the AF mode is [  ], [  ], or [  ].

Use the Fn button registered with [AF-Point Scope] to operate.

For information about the Fn button, refer to page 147.

## [AF Custom Setting(Photo)]



Select features of AF operation when recording using [AFC] that are appropriate for the subject and scene.

Each of these features can be further customized.

### 1 Set the focus mode to [AFC]. (→ 44)

### 2 Set [AF Custom Setting(Photo)].

- → [ ] → [ ] → [AF Custom Setting(Photo)]

[Set 1]	Basic general-purpose setting.
[Set 2]	Suggested for situations where the subject moves at a constant speed in one direction.
[Set 3]	Suggested when the subject moves randomly, and other objects may be in the scene.
[Set 4]	Suggested for situations where the speed of the subject changes significantly.

## ❖ Adjusting AF Custom Settings

- 1 Press ◀▶ to select the AF Custom setting type.
- 2 Press ▲▼ to select items and press ◀▶ to adjust.
  - To reset settings to the default, press [DISP].
- 3 Press or .

[AF Sensitivity]	Sets the tracking sensitivity for the movement of subjects.
[AF Area Switching Sensitivity]	Sets the sensitivity for switching the AF area to match subject movement. (When in an AF mode where the AF area uses 225-area focusing)
[Moving Subject Prediction]	Sets the level of movement prediction for changes in the speed of subject movement. <ul style="list-style-type: none"> <li>• At larger setting values, the camera tries to maintain focus by responding even to sudden movements of the subject. However, the camera becomes more sensitive to slight movements of the subject, so focusing may become unstable.</li> </ul>

# Selecting the AF Mode

iA P A S M  S&Q





Select the focusing method to match the position and number of subjects. This document gives an overview of AF mode. Refer to the “Owner’s Manual” (PDF format) for details about AF mode.









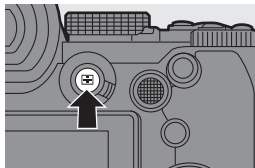



## 1 Press [ ].

- The AF mode selection screen appears.

## 2 Select the AF mode.

- Press ◀▶ to select an item and then press  or .
- Selection is also possible by pressing [  ].



	[Face/Eye/Body/ Animal Detect.]	→ 48
	[Tracking]	→ 49
	[225-Area]	→ 49
	[Zone (Vert./ Horz.)]	→ 49
	[Zone (Square)]*	→ 49
	[Zone (Oval)]	→ 50
	[1-Area+]	→ 50
	[1-Area]	→ 50
	[Pinpoint]	→ 50
	[Custom1]*,	
	[Custom2]*,	→ 50
	[Custom3]*	

\* This is not displayed with the default settings. From [Show/Hide AF Mode] in the [Custom] ([Focus/Shutter]) menu, you can set the items to display on the selection screen.

## [Face/Eye/Body/Animal Detect.]

The camera detects a person's face, eyes, and body (entire body or upper half of the body) and adjusts the focus.

When animal detection is enabled, animals, such as birds, canines (including wolves), and felines (including lions) will also be detected.

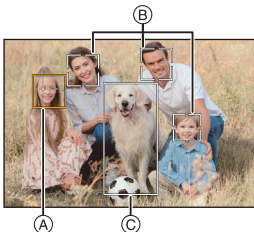

When the camera detects a person's face (A)/(B) or body or an animal's body (C), an AF area is displayed.

<b>Yellow</b>	AF area to be brought into focus. The camera selects this automatically.
<b>White</b>	Displayed when multiple subjects are detected.







- Eye detection works only for the eyes inside the yellow frame (A).

### Enable/Disable Animal Detection

- 1 Press [  ] to display the AF mode selection screen.
- 2 Select [  ] and then press .

### Specify the Person, Animal, or Eye to Bring into Focus

Touch the person, animal or eye indicated with the white AF area.

- The AF area will change to yellow.
- Touching outside the AF area displays the AF area setting screen. Touch [Set] to set the [  ] AF area at the position touched.
- To cancel the setting, touch [  ].
- Each press of  switches the person, animal or eye to be brought into focus.
- To cancel the settings specified, press .

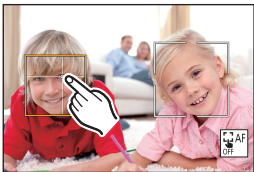



## [Tracking]

When the focus mode is set to [AFC], the AF area follows the movement of the subject, maintaining focusing.

### Start tracking.

Aim the AF area over the subject, and press the shutter button halfway.

The camera will track the subject while the shutter button is pressed halfway or pressed fully.

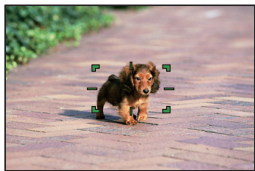

- If tracking fails, the AF area blinks red.
- When set to [AFS], the focus will be on the AF area position. Tracking will not work.

## [225-Area]

The camera selects the most optimal AF area to focus from 225 areas.

When multiple AF areas are selected, all selected AF areas will be brought into focus.

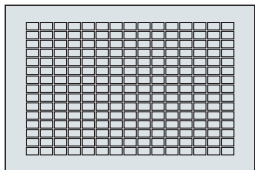

### Specify the [AFC] Start Point

When the focus mode is set to [AFC], you can specify at which area to start [AFC].

 →  →  → [AFC Start Point (225-Area)] → [ON]

- Refer to page 51 for details about AF area movement.

 [Zone (Vert./ Horz.)]/  [Zone (Square)]/  [Zone (Oval)]

### [Zone (Vert./ Horz.)]

Within the 225 AF areas, vertical and horizontal zones can be focused.

### [Zone (Square)]

Within the 225 AF areas, a central square zone can be focused.

## [Zone (Oval)]

Within the 225 AF areas, a central oval zone can be focused.

## [1-Area+]/ [1-Area]

### [1-Area+]

Emphasis within a single AF area can be focused.

Even when the subject moves out of the single AF area, the subject remains focused in a supplementary AF area (A).

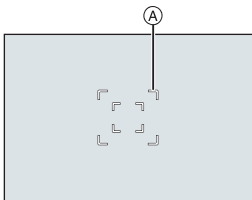

### [1-Area]















Specify the point to be brought into focus.

## [Pinpoint]

You can achieve a more precise focus on a small point.

If you press the shutter button halfway, the screen that lets you check the focus will be enlarged.

### Move the Position of the AF Area

- 1 Press  to display the AF mode selection screen.
- 2 Select  and then press .
- 3 Press    to set the position of  and then press  or .
  - The selected position on the screen will be enlarged.
- 4 Press    to fine-adjust the position of .
- 5 Press  or .

## [Custom1] to [Custom3]





The shape of the AF area can be set freely in the 225 AF areas.

The set AF area can be registered using  to .

The AF area can also be moved while maintaining the set shape.

- This is not displayed with default settings. In [Show/Hide AF Mode] in the [Custom] ([Focus/Shutter]) menu, set [Custom1] to [Custom3] to [ON]. (→ 153)

## Register the AF Area Shape

- 1 Press [  ] to display the AF mode selection screen.
- 2 Select one of [  ] to [  ] and then press .
- 3 Select the AF area.
  - Touch the area to make the AF area.
  - To select consecutive points, drag the screen.
  - To cancel selection of the selected AF area, touch it again.
- 4 Press [  ].

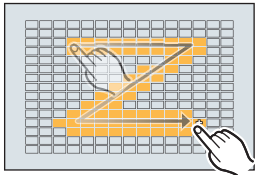

## AF Area Movement Operation

iA P A S M  S&Q





In default settings, you can use the joystick to directly move and change the size of the AF area when recording.

- Refer to the “Owner’s Manual” (PDF format) for details about AF area movement operations using other than the joystick.

### 1 Move the position of the AF area.



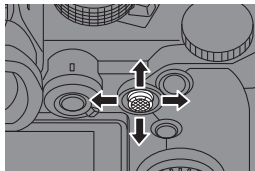

- On the recording screen, tilt the joystick.
- Pressing  enables switching between the default and set AF area positions.
 

In [  ]/[  ], this operation switches the person, animal or eye to be brought into focus.

In [  ], this operation displays the enlarged screen.



## 2 Change the size of the AF area.

- Rotate ,  or .
- Use  for more detailed adjustments.
- The first press of [DISP.] returns the AF area position to the center. The second press returns the size of the AF area to the default.

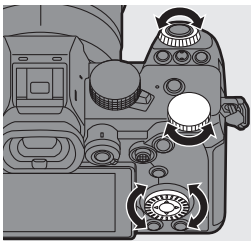

## 3 Confirm your selection.

- Press the shutter button halfway.
- This will return you to the recording screen.

# Record Using MF

iA P A S M  M S&Q



MF (Manual Focus) refers to manual focusing.

Use this function when you want to fix the focus or when the distance between the lens and the subject is determined and you do not want to activate AF.

## 1 Set the focus mode lever to [MF].

## 2 Select the focus point.

- Tilt the joystick to select the focus point.
- To return the point to be brought into focus to the center, press [DISP.].

## 3 Confirm your selection.

- Press .
- This switches to the MF Assist screen, and shows an enlarged display.

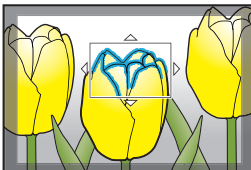
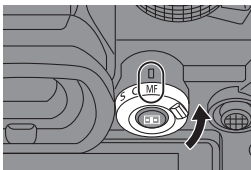

## 4 Adjust the focus.

- Rotate the focus ring.
- (A) MF Assist (enlarged screen)
  - This will display the in-focus portion highlighted with color. (Focus Peaking (B))
  - A recording distance guideline is displayed. (MF Guide (C))
- (D) Indicator for  $\infty$  (infinity)

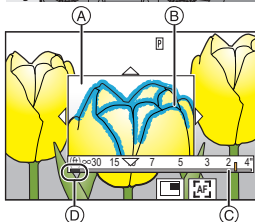
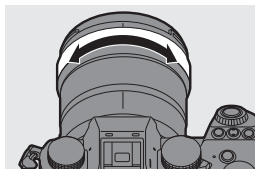







## 5 Close the MF Assist screen.

- Press the shutter button halfway.
- This operation can also be performed by pressing .

## 6 Start recording.

- Press the shutter button fully.

### ❖ Operations on the MF Assist Screen

Button operation	Touch operation	Description of operation
	Drag	Moves the enlarged display position.
	Pinch out/ pinch in	Enlarges/reduces the screen in small steps.
	—	Enlarges/reduces the screen.
		Switches magnification window (windowed mode/full screen mode).
[DISP.]	[Reset]	First time: Returns the MF Assist position to the center. Second time: Returns the MF Assist magnification to the default setting.
[AF ON]		The AF operates.

## Recording with Zoom

iA P A S M  S&Q



Use the optical zoom of the lens to zoom to telephoto or wide-angle.

When taking pictures, use [Ex. Tele Conv.] to increase a telescopic effect without image deterioration.

When recording videos, use [Image Area of Video] to obtain the same telescopic effect as [Ex. Tele Conv.].

- Refer to the "Owner's Manual" (PDF format) for details about [Ex. Tele Conv.].
- For details about [Image Area of Video], refer to page 100.

### Rotate the zoom ring.

**T**: Telephoto

**W**: Wide-angle

- Rotating the zoom ring displays the focal length on the recording screen.

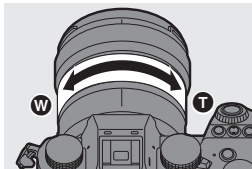

# 6. Drive/Image Stabilizer

## Selecting the Drive Mode

iA P A S M S&Q



You can switch the drive mode to Single, Burst, etc. to match the recording conditions.

### Rotating the drive mode dial.

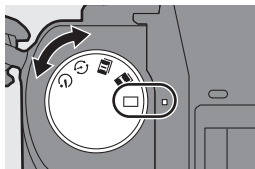





	<b>Single</b>	Takes one picture each time the shutter button is pressed.
	<b>Burst</b> (→ 55, 57)	Takes pictures continuously while the shutter button is pressed and held. 6K/4K photo recording is also possible.
	<b>Time Lapse Shot/ Stop Motion Animation</b> (→ 61)	Takes pictures with Time Lapse Shot or Stop Motion Animation.
	<b>Self-timer</b> (→ 63)	Takes pictures when the set time elapses after the shutter button is pressed.

## Taking Burst Pictures

iA P A S M S&Q



Takes pictures continuously while the shutter button is pressed and held. You can choose a burst setting which enables burst recording in high image quality, [H], [M] or [L], or one which enables high-speed burst recording, [] (6K/4K photo), to suit the recording conditions.

- 1 Set the drive mode dial to [**I**] (Burst Shot 1) or [**II**] (Burst Shot 2). (→ 55)
- 2 Select the burst rate.
  -  → [] → [] → [Burst Shot 1 Setting]/[Burst Shot 2 Setting]
  - With the default settings, [H] is set for [**I**] and [] is set for [**II**].
- 3 Close the menu.
  - Press the shutter button halfway.
- 4 Start recording.
  - Takes burst pictures while the shutter button is pressed fully.

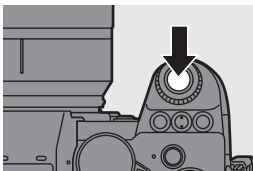

## ❖ Burst Rate

	Mechanical shutter, electronic front curtain	Electronic shutter	Live View when taking burst pictures
[H] (High speed)	7 frames/second ([AFS]/[MF]) 5 frames/second ([AFC])	7 frames/second ([AFS]/[MF]) 5 frames/second ([AFC])	None ([AFS]/[MF]) Available ([AFC])
[M] (Medium speed)	5 frames/second	5 frames/second	Available
[L] (Low speed)	2 frames/second	2 frames/second	Available



## ❖ Maximum Number of Frames Recordable

	[Picture Quality]	
	[FINE]/[STD.]	[RAW+FINE]/[RAW+STD.]/[RAW]
[H] (High speed)	999 frames or more	24 frames or more
[M] (Medium speed)		
[L] (Low speed)		

- When recording under the test conditions specified by Panasonic. (Using a card in card slot 1 compatible with UHS-II)  
Recording conditions may reduce the maximum number of frames recordable.
- The burst rate will become lower during recording but pictures can continue to be taken until the card becomes full.

## 6K/4K Photo Recording

iA P A S M  S&Q



With 6K Photo, you can take high-speed burst pictures at 30 frames/second and save the desired pictures, each made up of approx. 18 million pixels, extracted from their burst file.

With 4K photo, you can take high-speed burst pictures at 60 frames/second and save the desired pictures, each made up of approx. 8 million pixels.



- Use a UHS Speed Class 3 or higher card when recording.
- The angle of view becomes narrower (when using a full-frame lens).

# 1 Set the drive mode dial to [I] (Burst Shot 1) or [II] (Burst Shot 2). (→ 55)

## 2 Select [6K/4K PHOTO].

- **MIENU/SET** → [CAMERA] → [BURST] → [Burst Shot 1 Setting]/[Burst Shot 2 Setting] → [6K]

- With the default settings, [6K] is set for [I].

## 3 Select [Picture Size / Burst Speed].

- **MIENU/SET** → [CAMERA] → [BURST] → [6K/4K PHOTO] → [Picture Size / Burst Speed]

Settings:

[6K 18M]/[4K H 8M]/[4K 8M]



## 4 Select [Rec Method].

Settings:

[6K/4K Burst]/[6K/4K Burst(S/S)]/[6K/4K Pre-Burst]

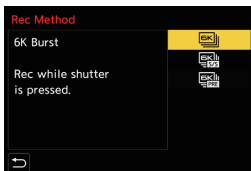

## 5 Close the menu.

- Press the shutter button halfway.

## 6 Start recording.

- [Continuous AF] works and the focus is adjusted continuously during recording with AF.

### [6K/4K Burst]

- 1 Press the shutter button halfway.
- 2 Press the shutter button fully and keep it pressed during recording.

- (A) Press and hold
- (B) Recording is performed

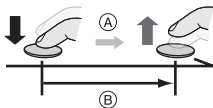

**[6K/4K Burst(S/S)]**

- 1 Press the shutter button fully to start recording.
- 2 Press the shutter button fully again to stop recording.

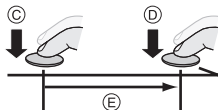

- Ⓒ Start (First)
- Ⓓ Stop (Second)
- Ⓔ Recording is performed

- You can add markers by pressing [Q] during recording. (Up to 40 markers per recording)

**[6K/4K Pre-Burst]**

Press the shutter button fully.

- Ⓕ Approx. 1 second
- Ⓖ Recording is performed

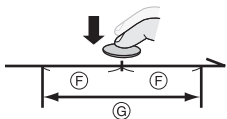

- While the recording screen is displayed, the AF will operate constantly to continue focusing.

The exposure is also adjusted continuously, except in [M] mode.

- In default settings, Auto Review operates, and a screen that lets you select pictures from a burst file will be displayed.  
To continue recording, press the shutter button halfway to return to the recording screen.

**❖ [Pre-Burst Recording] ([6K/4K Burst]/[6K/4K Burst(S/S)])**

The camera starts recording approx. 1 second before the shutter button is pressed fully, so you will not miss a photo opportunity.



**MENU/SET** → [📷] → [📷] → [6K/4K PHOTO] → [Pre-Burst Recording] → Select [ON]

- When [Pre-Burst Recording] is being used, [PRE] is displayed on the recording screen.

## Selecting Pictures from a 6K/4K Burst File

- When continuing to select pictures from the Auto Review after recording 6K/4K photos, start the operation from either Step **2** or **3**.

### 1 Select a 6K/4K burst file on the playback screen. (→ 144)

- Select an image with the  or  icon and then press .
- If the images were recorded with [6K/4K Pre-Burst], proceed to Step **3**.



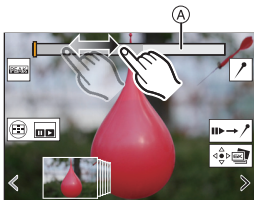

### 2 Roughly select the scene.

- Drag the slide bar .





Picture selection slide view screen

### 3 Select the frame to save.

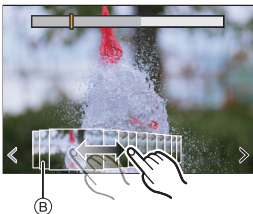
- Drag the picture selection slide view .
- To change the frames displayed in the picture selection slide view, select the frame at the left/right end and then touch [] or [].



### 4 Save the picture.

- Touch [] or [].
- A confirmation screen appears.
- The picture is saved in JPEG format ([FINE] picture quality).

# Recording with Time Lapse Shot

iA P A S M  S&Q





Pictures are taken automatically at a set recording interval.

- Check that the clock is set correctly. (→ 34)
- For long recording intervals, we recommend setting [Lens Focus Resume] to [ON] in the [Custom] ([Lens / Others]) menu.

## 1 Set the drive mode dial to [ ]. (→ 55)

## 2 Set [Mode] to [Time Lapse Shot].

-  → [  ] → [  ] → [Time Lapse/Animation] → [Mode] → [Time Lapse Shot]

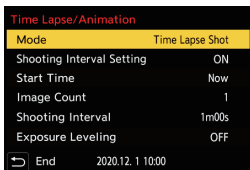

## 3 Set the recording settings.

[Mode]	Switches between Time Lapse Shot and Stop Motion Animation.	
[Shooting Interval Setting]	[ON]	Sets the interval before the next recording takes place.
	[OFF]	Takes pictures without leaving recording intervals.
[Start Time]	[Now]	Starts recording when the shutter button is pressed fully.
	[Start Time Set]	Starts recording at the set time.
[Image Count]/ [Shooting Interval]	Sets the number of pictures and the recording interval to be taken.	
[Exposure Leveling]	Adjusts the exposure automatically to prevent large changes in brightness between adjacent frames.	

## 4 Close the menu.

- Press the shutter button halfway.

## 5 Start recording.

- Press the shutter button fully.
- When [Start Time Set] is set, the camera will enter into sleep status until the start time is reached.
- During recording standby, the camera enters into sleep status when no operation is performed for a certain period of time.
- The recording will stop automatically.

## 6 Create a video. (→ 62)

- After the recording has stopped, select [Yes] on the confirmation screen to proceed to create a video.

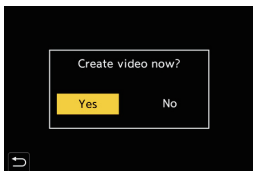

# Time Lapse Shot/Stop Motion Animation Videos

After performing Time Lapse Shot or stop motion recording, you can proceed to create a video.

- Refer to the "Owner's Manual" (PDF format) for information about [Stop Motion Animation] recording.
- You can also create videos with [Time Lapse Video] (→ 155) or [Stop Motion Video] (→ 155) in the [Playback] menu.

## 1 Select [Yes] on the confirmation screen that appears after recording.

## 2 Set the options for creating a video.

## 3 Select [OK].

- A video will be created in the [MP4] recording file format.



[OK]	Creates a video.	
[Rec Quality]	Sets the video image quality.	
[Frame Rate]	Sets the number of frames per second. The larger the number is, the smoother the video will be.	
[Sequence]	[NORMAL]	Splices pictures together in recording order.
	[REVERSE]	Splices pictures together in reverse recording order.



- Videos cannot be created if the recording time exceeds 29 minutes and 59 seconds.
- In the following cases, videos cannot be created if the file size exceeds 4 GB:
  - When an SDHC memory card is being used and a 4K [Rec Quality] is set
  - When an FHD [Rec Quality] is set

## Recording Using the Self-timer

iA P A S M S&Q



- 1 Set the drive mode dial to [Ⓢ]. (→ 55)**
- 2 Decide on the composition and then adjust the focus.**
  - Press the shutter button halfway.
  - The focus and exposure are fixed when the shutter button is pressed halfway.
- 3 Start recording.**
  - Press the shutter button fully.
  - The self-timer light blinks and then the shutter is released.



### ❖ Setting the Self-timer Time

→ [📷] → [Ⓢ] → Select [Self Timer]  
Settings: [Ⓢ<sub>10</sub>] / [Ⓢ<sub>10</sub>] / [Ⓢ<sub>2</sub>]

- [Ⓢ<sub>10</sub>] takes 3 pictures at approx. 2 second intervals after 10 seconds.

# Bracket Recording

iA P A S M  S&Q



When the shutter button is pressed, the camera can record multiple images while automatically changing the setting value for exposure, aperture, focus or white balance (adjustment value or color temperature).

## 1 Set [Bracketing Type].

-  → [  ] → [  ] → [Bracketing] → [Bracketing Type]

## 2 Set [More Settings].

- Refer to the "Owner's Manual" (PDF format) for information about [More Settings].

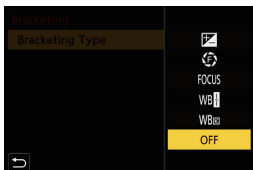





## 3 Close the menu.

- Press the shutter button halfway.

## 4 Focus on the subject and then take pictures.

### ❖ Setting Items ([Bracketing Type])

[  ] <b>Exposure Bracket</b>	When the shutter button is pressed, the camera records while changing the exposure.
[  ] <b>Aperture Bracket</b>	When the shutter button is pressed, the camera records while changing the aperture value.
[ FOCUS ] <b>Focus Bracket</b>	When the shutter button is pressed, the camera records while changing the focus point.
[  ] <b>White Balance Bracket</b>	When the shutter button is pressed once, the camera automatically records three images with the different white balance adjustment values.
[  ] <b>White Balance Bracket (Color Temperature)</b>	When the shutter button is pressed once, the camera automatically records three images with the different white balance color temperatures.
[OFF]	—



# [Live View Composite]



Images are recorded over several times and only the parts that change to become brighter form part of the composition.

The images composed by recording at a set exposure time (shutter speed) are displayed, allowing the images to be confirmed as recording proceeds.

- Use a tripod to minimize camera shake.

**1 Set the mode dial to [M].**

**2 Set [Live View Composite].**

- → [ ] → [ ] → [Live View Composite]

**3 Start Live View Composite recording.**

- Select [Start] and then press or .

**4 Decide on the composition and then fix the camera in place.**



**5 Set the shutter speed and ISO sensitivity.**

- Rotate to set the shutter speed.
- Press [ISO], then rotate , , or to set the ISO sensitivity.
  - The shutter speed can be set in the range between 60 seconds and 1/1.6 of a second.
  - The ISO sensitivity can be set in the range between [100] and [3200] ([50] and [3200] when [Extended ISO] is set).

**6 Get the image to use for noise reduction.**

- Press the shutter button fully.

## 7 Start recording.

- Press the shutter button fully.
- Recording is done according to the settings in Step 5, and images processed with noise reduction are merged a frame at a time.

- Ⓐ Histogram display
- Ⓑ Shutter speed × Number of images merged
- Ⓒ Elapsed time

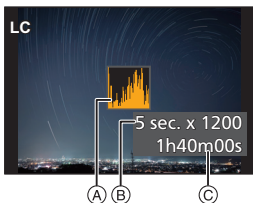

## 8 Stop recording.

- Press the shutter button fully.
- A maximum of 3 hours can be recorded with one Live View Composite recording.  
(Recording automatically ends when the time exceeds 3 hours.)

## 9 End [Live View Composite].

- Press [Q].

### ❖ Setting Items ([Live View Composite])

<b>[Start]</b>	Starts Live View Composite recording.
<b>[Shutter Delay]</b>	Sets the delay time from when the shutter button is pressed until the shutter is released. [8 SEC]/[4 SEC]/[2 SEC]/[1 SEC]/[OFF]

# Image Stabilizer

iA P A S M  S&Q







This camera can use both the in-body image stabilizer and the in-lens image stabilizer.

It is compatible with the Dual I.S.2 system that is an effective combination of the 2 image stabilizers.

Furthermore, during video recording, you can use the 5-Axis Hybrid Image Stabilizer that incorporates electronic stabilization.

## Combinations of lenses and image stabilizers (As of September 2020)

Attached lens	Available image stabilizer	Example of icon
Panasonic lenses with image stabilization function	<b>Body+Lens</b> (Dual I.S.2)	DUAL2 
Other manufacturers' lenses with image stabilization function	<b>Body or Lens</b>	BODY / LENS 
Lenses without image stabilizer	<b>Body</b>	BODY 
Lenses without communication function	<b>Body</b>	BODY 

- The 5-Axis Hybrid Image Stabilizer (→ 68) can be used with any lenses.

### ❖ Using the Image Stabilizer

- When using a lens with an O.I.S. switch, set the switch on the lens to [ON].
- When using lenses without a function for communicating with this camera, a message asking you to check the focal length setting is displayed after you turn on the camera.

Correctly operating the image stabilization function requires that the focal length be set to match the attached lens.

Set the focal length in accordance as prompted by the message.

This can also be set using the menu. (→ 70)



- When the shutter button is pressed halfway, the camera shake alert icon [ ] may be displayed on the recording screen. If this is displayed, we recommend using a tripod, the self timer or the Shutter Remote Control (DMW-RS2: optional).
- We recommend turning off the image stabilizer function when using a tripod.

## Image Stabilizer Settings

Set the image stabilizer operation to match the recording situation.







⇒ [ ] ⇒ [ ] ⇒ Select [Image Stabilizer]

<b>[Operation Mode]</b>	Sets the stabilization movement (blur) to match the recording method (normal, panning). (→ 69)	
<b>[Body(B.I.S.) / Lens(O.I.S.)]</b>	[ <sup>BODY</sup> ] ([Body])	The in-body image stabilizer corrects for vertical, horizontal, and rotational shake.
	[ <sup>LENS</sup> ] ([Lens + Body (Roll)])	The in-lens image stabilizer corrects for vertical and horizontal shake, while the in-body image stabilizer corrects for rotational shake.  • This can be set when using other manufacturers' lenses with an image stabilization function.
<b>[When to Activate]</b>	<b>[ALWAYS]</b>	The image stabilizer is always operating.
	<b>[HALF-SHUTTER]</b>	The image stabilizer operates when the shutter button is pressed halfway.
<b>[E-Stabilization (Video)]</b>	Camera shake during video recording is corrected along the vertical, horizontal, roll, pitch, and yaw axes through the combined use of the in-lens, in-body, and electronic image stabilizers. (5-Axis Hybrid Image Stabilizer)  • The [  ] on the recording screen changes to [  ] while [E-Stabilization (Video)] is functioning. • The angle of view may become narrower if set to [ON].	

<b>[Boost I.S. (Video)]</b>	Increases the effectiveness of the image stabilizer during video recording. This effect can help provide a stable composition when you want to perform recording from a fixed perspective. (→ 69)
<b>[Anamorphic (Video)]</b>	You can switch to an image stabilizer that suits anamorphic recording. (→ 70)
<b>[Focal Length Set]</b>	When using lenses without a function for communicating with this camera, manually set the focal length. (→ 70)

## ❖ [Operation Mode]

Set the stabilization movement (blur) to match the recording method (normal, panning).

 <b>[Normal]</b>	Corrects vertical, horizontal, and rotational camera shake. This function is suitable for normal recording.
 <b>[Panning (Auto)]</b>	Automatically detects the panning direction, and corrects vertical and horizontal camera shake. This function is suitable for panning.
 <b>[Panning (Left/Right)]</b>	Corrects vertical camera shake. This is suitable for horizontal panning.
 <b>[Panning (Up/Down)]</b>	Corrects horizontal camera shake. This is suitable for vertical panning.
<b>[OFF]</b>	Turns the image stabilization function OFF.

- Operation modes that can be used will differ depending on the used lenses and on [Body(B.I.S.) / Lens(O.I.S.)] settings.
- When using lenses with an O.I.S. switch, the camera's operation mode cannot be set to [OFF]. Set the switch on the lens to [OFF].

## ❖ [Boost I.S. (Video)]

Increase the effectiveness of the image stabilizer during video recording. This effect can help provide a stable composition when you want to perform recording from a fixed perspective.

Settings: [ON]/[OFF]

- When [Boost I.S. (Video)] is operating, [ ] is displayed on the recording screen.
- To change composition while recording, first set this to [OFF] before moving the camera.

To set this to [OFF] during recording, use the Fn button. (→ 147)

### ❖ [Anamorphic (Video)]

You can switch to an image stabilizer that suits anamorphic recording.

Settings: [ <sup>A2.0</sup> ]([2.0×])/[ <sup>A1.8</sup> ]([1.8×])/[ <sup>A1.5</sup> ]([1.5×])/[ <sup>A1.33</sup> ]([1.33×])/[ <sup>A1.30</sup> ]([1.30×])/[OFF]

- Make settings to suit the magnification of the anamorphic lens you are using.
- While [Anamorphic (Video)] is functioning, the set magnification appears on the image stabilizer icons on the recording screen, as shown by [ <sup>A2.0</sup> ] and [ <sup>A2.0</sup> ].



- When [Boost I.S. (Video)] is set, [Boost I.S. (Video)] is prioritized.

### ❖ [Focal Length Set]

When using lenses without a function for communicating with this camera, manually set the focal length inscribed on the lens.

Up to three focal length settings can be registered.

Registered focal length settings can be called.

<p><b>Entering focal length input</b> (A)</p>	<p>Enter the focal length.</p> <p>◀▶: Select</p> <p>▲▼: Select a numeric value.</p> <p>⌂ or ⌂: Confirm</p> <p>• 0.1 mm to 1000.0 mm can be set.</p>
<p><b>Registration and calling</b> (B)</p>	<p>Register the entered focal length.</p> <p>Call the registered focal length.</p> <p>◀▶: Select</p> <p>[DISP.]: Register the entered focal length.</p> <p>⌂ or ⌂: Call the registered focal length.</p>

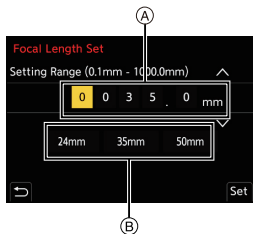

# 7. Metering/Exposure/ISO Sensitivity

## [Metering Mode]

iA P A S M S&Q



Type of optical measurement to measure brightness can be changed.

→ [ ] → [ ] → Select [Metering Mode]

(Multi-metering)	Method in which the most suitable exposure is measured by judging the allocation of brightness on the whole screen.
(Center-weighted)	Method used to perform measuring which focuses on the center of the screen.
(Spot)	Method used to measure the extremely small part around the spot-metering target.
(Highlight-weighted)	Method used to perform measuring which focuses on the highlighted parts of the screen to prevent overexposure. This is suitable for theatre photography, etc.

## Program AE Mode

iA P A S M S&Q



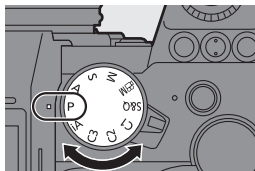

In [P] mode (Program AE mode), the camera automatically sets the shutter speed and aperture value for the brightness of the subject.

**1** Set the mode dial to [P].



## 2 Press the shutter button halfway.

- This displays the aperture value (A) and shutter speed value (B) on the recording screen.
- If the correct exposure is not achieved, the aperture value and shutter speed blink red.
- When you rotate  or  while the values are displayed, you can change the combination of aperture value and shutter speed while maintaining the same exposure. (Program Shift)

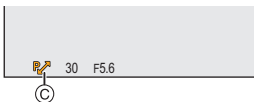
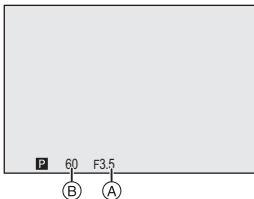

© Program Shift icon

## 3 Start recording.

# Aperture-Priority AE Mode

iA P **A** S M  S&Q



In [A] mode (Aperture-Priority AE mode), you can set the aperture value before recording.

The shutter speed will be automatically set by the camera.

## 1 Set the mode dial to [A].

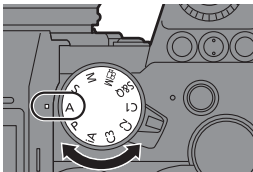



**2 Set the aperture value.**

- Rotate  or .

**3 Start recording.**

- If the correct exposure is not achieved when the shutter button is pressed halfway, the aperture value and the shutter speed blink red.

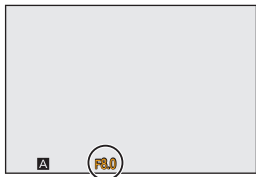

## Shutter-Priority AE Mode



In [S] mode (Shutter-Priority AE mode), you can set the shutter speed before recording.

The aperture value will be automatically set by the camera.

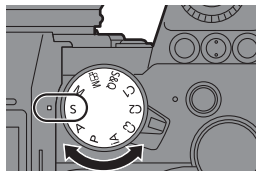
**1 Set the mode dial to [S].****2 Set the shutter speed.**

- Rotate  or .

**3 Start recording.**

- If the correct exposure is not achieved when the shutter button is pressed halfway, the aperture value and the shutter speed blink red.

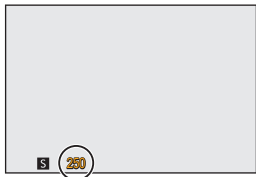

# Manual Exposure Mode

iA P A S **M**  S&Q



In [M] mode (Manual Exposure mode), you can take pictures by manually setting the aperture value and shutter speed.

In default settings, the ISO sensitivity is set to [AUTO].



As a result, the ISO sensitivity will be adjusted according to the aperture value and shutter speed.

Exposure compensation can also be used when ISO sensitivity is set to [AUTO].

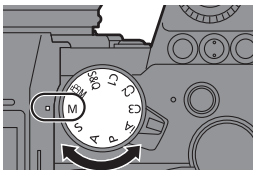
## 1 Set the mode dial to [M].



## 2 Set the aperture value and shutter speed.

- Rotate  to set the aperture value (A), and  to set the shutter speed (B).

## 3 Start recording.

- If the correct exposure is not achieved when the shutter button is pressed halfway, the aperture value and the shutter speed blink red.

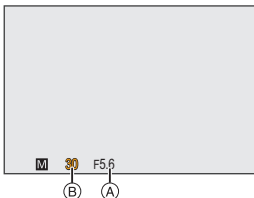

## ❖ Available Shutter Speeds (Sec.)

[MECH.]	[B] (Bulb, max. approx. 30 minutes), 60 to 1/8000
[EFC]	[B] (Bulb, max. approx. 30 minutes), 60 to 1/2000
[ELEC.]	[B] (Bulb, max. approx. 60 seconds), 60 to 1/8000

# Exposure Compensation

iA P A S M  S&Q



You can compensate the exposure when the standard exposure determined by the camera is too bright or too dark.

You can adjust the exposure in 1/3 EV steps in a range of  $\pm 5$  EV.

When recording videos or recording with 6K/4K photo or Post-Focus, the range changes to  $\pm 3$  EV.

**1** Press [].

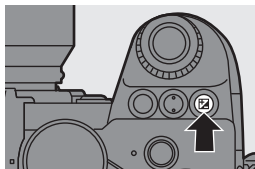

**2** Compensate the exposure.

- Rotate , , or .

**3** Confirm your selection.

- Press the shutter button halfway.

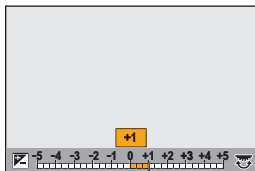

- In [M] mode, you can compensate the exposure by setting the ISO sensitivity to [AUTO].

# Locking Focus and Exposure (AF/AE Lock)

iA P A S M S&Q



Lock the focus and exposure in advance to take pictures with the same focus and exposure settings while changing the composition.

This is useful when you want to bring an edge of the screen into focus or there is a backlight, for example.

## 1 Register [AE LOCK], [AF LOCK], or [AF/AE LOCK] to the Fn button. (→ 147)

- These cannot be registered to [Fn3] to [Fn7].

[AE LOCK]	The exposure is locked.
[AF LOCK]	The focus is locked.
[AF/AE LOCK]	Both focus and exposure are locked.

## 2 Lock focus and exposure.

- Press and hold the Fn button.
- If focus is locked, then the AF lock icon (A) will be displayed.
- If exposure is locked, then the AE lock icon (B) will be displayed.

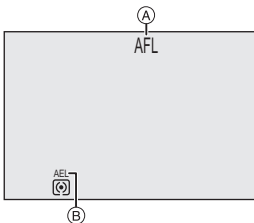

## 3 Hold the Fn button to decide on the composition and then perform recording.

- Press the shutter button fully.

# ISO Sensitivity

iA P A S M  S&Q



You can set light sensitivity (ISO sensitivity).

With the default settings, you can set 100 to 51200 in 1/3 EV increments.



This camera supports Dual Native ISO which enables recording at high sensitivity and with reduced noise by switching the base sensitivity.

The base sensitivity is automatically switched according to the brightness.

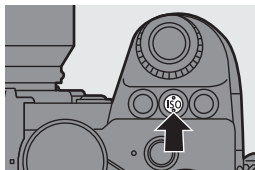
## 1 Press [ISO].



## 2 Select ISO sensitivity.

- Rotate , , or .
- Selection is also possible by pressing [ISO].

## 3 Confirm your selection.

- Press the shutter button halfway.

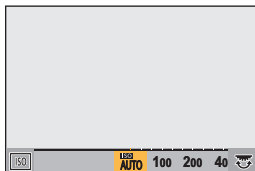

## ❖ Setting Items (ISO Sensitivity)

<b>[AUTO]</b>	<p>The ISO sensitivity is automatically adjusted according to the brightness.</p> <ul style="list-style-type: none"> <li>• Taking picture: Maximum [6400]<sup>*1</sup></li> <li>• Video recording: Maximum [6400]<sup>*2</sup></li> </ul>
<b>[100] to [51200]</b>	<p>The ISO sensitivity is fixed at the selected value.</p> <ul style="list-style-type: none"> <li>• You can extend the ISO sensitivity range in between a lower limit of [50] and an upper limit of [204800] by setting [Extended ISO] to [ON] in the [Custom] ([Image Quality]) menu.</li> </ul>

\*1 Default setting. The upper limit can be changed with [ISO Sensitivity (photo)].

\*2 Default setting. The upper limit can be changed with [ISO Sensitivity (video)].

- When the following functions are being used, the ISO sensitivity that can be set is restricted.
  - [High Resolution Mode]: Up to an upper limit of [3200]
  - [High Dynamic] ([Filter Settings]): Down to a lower limit of [400], up to an upper limit of [6400]
  - Other than [High Dynamic] ([Filter Settings]): Up to an upper limit of [6400]
  - [Live View Composite]: [100] to [3200] (when [Extended ISO] is set: [50] to [3200])
  - [Multiple Exposure]: Down to a lower limit of [100], up to an upper limit of [6400]
  - [Cinelike D2]/[Cinelike V2] ([Photo Style]): Down to a lower limit of [200] (The lower limit changes to [100] when [Extended ISO] is set.)
  - [Like709] ([Photo Style]): Down to a lower limit of [100]
  - [V-Log] ([Photo Style]): Down to a lower limit of [640], up to an upper limit of [51200] (The lower limit changes to [320] when [Extended ISO] is set.)
  - [Like2100(HLG)]/[Standard(HLG)]/[Monochrome(HLG)] ([Photo Style]): Down to a lower limit of [400]

# 8. White Balance/Image Quality

## White Balance (WB)

iA P A S M  S&Q







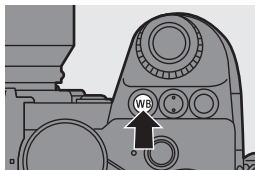

White balance (WB) is a function that corrects the color cast produced by the light illuminating the subject.

It corrects the colors so that white objects appear in white to make the overall color closer to what is seen by the eye.

### 1 Press [WB].



### 2 Select the white balance.

- Rotate ,  or .
- Selection is also possible by pressing [WB].
- When you press , the adjustment screen for the currently selected white balance is displayed. Press    to adjust the coloring.

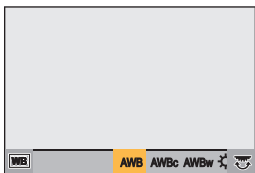

### 3 Confirm your selection.

- Press the shutter button halfway.



## ❖ Setting Items (White Balance)

[AWB]	Auto
[AWBc]	Auto (Reduces the reddish hue under an incandescent light source)
[AWBw]	Auto (Leaves the reddish hue under an incandescent light source)
[☀]	Clear sky
[☁]	Cloudy sky
[🏠]	Shade under a clear sky
[☀]	Incandescent light
[WB]	Flash
[1] to [4]	Set mode 1 to 4 (→ 80)
[K1] to [K4]	Color temperatures 1 to 4 (→ 81)

\* It operates as [AWB] during video recording or when recording with [6K/4K PHOTO] or [Post-Focus].

## ❖ Registering the White Set ([1] to [4])











Take pictures of a white object under the light source of the recording location to adjust the white balance until it appears white.

- 1 Press [WB] and then select any value from [1] to [4].
- 2 Press ▲.
- 3 Aim the camera at a white object so that it appears inside the frame at the center of the screen and then press  or .
  - This will set the white balance and return you to the recording screen.



## ❖ Color Temperature Setting ([ ] to [ ])

Set the numeric value for the white balance color temperature.

- 1 Press [WB] and then select any value from [  ] to [  ].
- 2 Press  .
  - The color temperature setting screen is displayed.
- 3 Press   to select the color temperature and then press  or  .
  - You can set the White Balance Bracket (Color Temperature) by rotating  ,  or  .

## [Photo Style]









iA P A S M  S&Q









You can select the finishing settings of images to suit your subjects and expression styles.

The image quality can be adjusted for each Photo Style.

 → [  ] → [  ] → Select [Photo Style]



 <b>STD.</b> [Standard]	The standard setting.
 <b>VIVID</b> [Vivid]	A setting that produces a more vivid quality with higher saturation and contrast.
 <b>NAT</b> [Natural]	A setting that produces a softer quality with lower contrast.
 <b>FLAT</b> [Flat]	A setting that produces a flatter image quality with lower saturation and contrast.
 <b>LAND</b> [Landscape]	A setting suited for sceneries with vivid blue skies and greens.
 <b>PORT</b> [Portrait]	A setting suited for portraits with a healthy and beautiful skin tone.
 <b>MONO</b> [Monochrome]	A monochrome setting with no color shades.
 <b>L.MONO</b> [L.Monochrome]	A black-and-white setting with rich gradation and crisp black accents.

 <b>[L.Monochrome D]</b>	<p>A monochrome setting that creates a dynamic impression with enhanced highlights and shadows.</p>
 <b>[Cinelike D2]</b>	<p>A setting that creates a film-like finishing touch using a gamma curve and gives priority to the dynamic range.</p> <ul style="list-style-type: none"> <li>• This function is suitable for video editing processes.</li> </ul>
 <b>[Cinelike V2]</b>	<p>A setting that creates a film-like finishing touch using a gamma curve that gives priority to the contrast.</p>
 <b>[Like709]</b>	<p>A setting that minimizes overexposure by applying a gamma curve correction equivalent to Rec.709 to perform compression (knee adjustment) of high-luminance areas.</p> <ul style="list-style-type: none"> <li>• Rec.709 is an abbreviation of "ITU-R Recommendation BT.709", a standard for high-definition broadcasting.</li> </ul>
 <b>[V-Log]</b>	<p>Gamma curve setting intended for post-production processing.</p> <ul style="list-style-type: none"> <li>• It allows you to add rich gradation to images during post-production editing.</li> </ul>
 <b>[Like2100(HLG)]*1</b>	<p>A setting used to record HLG format video.</p>
 <b>[MY PHOTO STYLE 1]*2 to [MY PHOTO STYLE 10]*2</b>	<p>Adjusts the image quality of Photo Style items to your preferred settings and registers these as My Photo Style items.</p> <ul style="list-style-type: none"> <li>• Refer to the "Owner's Manual" (PDF format) for details.</li> </ul>

\*1 Can only be selected when in the [P/M] mode and set to a 10-bit [Rec Quality]. (→ 101)

\*2 Effects up to [MY PHOTO STYLE 4] are displayed with the default settings. You can set the items to display in the menu with [Show/Hide Photo Style] in [Photo Style Settings].



- When [HLG Photo] is set, the items will be as follows.

 <b>[Standard(HLG)]</b>	Standard [HLG Photo] setting.
 <b>[Monochrome(HLG)]</b>	Black and white setting for [HLG Photo].



- In [iA] mode, operation differs from that in other recording modes.
  - [Standard] or [Monochrome] can be set.
  - The setting will be reset to [Standard] when the camera is switched to another recording mode or it is turned off.
  - Image quality cannot be adjusted.

## ❖ Adjusting Image Quality

- Press ◀▶ to select the type of Photo Style.
- Press ▲▼ to select an item and then press ◀▶ to adjust.
  - Adjusted items are indicated with [\*].
- Press  or .
  - When the image quality is adjusted, the Photo Style icon on the recording screen is indicated with [\*].

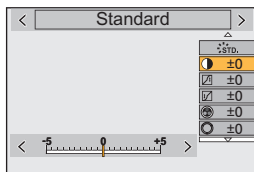

- Refer to the "Owner's Manual" (PDF format) for details about setting items.

# [Filter Settings]

iA P A S M  S&Q



This mode records with additional image effects (filters).

You can adjust the effect for each filter.

## 1 Set the [Filter Effect].

-  → [  ] → [  ] → [Filter Settings] → [Filter Effect] → [SET]

## 2 Select the filter.

- Press   to select, and then press

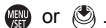



- Press [DISP.] to switch the screen in the order of normal display, guide display, and list display.

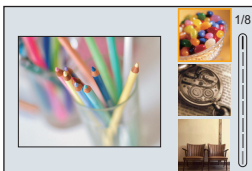

The guide display shows the description of each filter.



## ❖ Adjusting the Filter Effect

- 1 Select the filter.
- 2 On the recording screen, press [WB].
- 3 Rotate ,  or  to set.
  - To return to the recording screen, press [WB] again.
  - When the filter effect is adjusted, the filter icon on the recording screen is indicated with [\*].



Filter	Items that can be adjusted
[Expressive]	Vividness
[Retro]	Coloring
[Old Days]	Contrast
[High Key]	Coloring
[Low Key]	Coloring
[Sepia]	Contrast
[Monochrome]	Coloring
[Dynamic Monochrome]	Contrast
[Rough Monochrome]	Grittiness
[Silky Monochrome]	Defocus level
[Impressive Art]	Vividness
[High Dynamic]	Vividness
[Cross Process]	Coloring
[Toy Effect]	Coloring
[Toy Pop]	Area with reduced peripheral brightness
[Bleach Bypass]	Contrast
[Miniature Effect]	Vividness
[Soft Focus]	Defocus level
[Fantasy]	Vividness
[Star Filter]	 : Short rays/Long rays
	 : Few rays/Many rays
	 : Rotate to left/Rotate to right
[One Point Color]	Amount of color left
[Sunshine]	Coloring

## [High Resolution Mode]

iA P A S M M S&Q



This merges pictures with a high resolution from multiple recorded images. This function is suitable for recording subjects that do not move. The picture after merging can be saved in RAW or JPEG format.



- Use a tripod to minimize camera shake.
- The image stabilization function is automatically turned off.

### 1 Set [High Resolution Mode].



- → [ ] → [ ] → [High Resolution Mode]

### 2 Set the recording settings.

[Start]	Starts High Resolution mode.
[Picture Size]	<p>Sets the image size after merging.</p> <p><b>When the [Aspect Ratio] is [4:3].</b></p> <p>[XL] (85 M): 10656×8000</p> <p>[LL] (42.5 M): 7552×5664</p> <p><b>When the [Aspect Ratio] is [3:2].</b></p> <p>[XL] (96 M): 12000×8000</p> <p>[LL] (48 M): 8496×5664</p> <p><b>When the [Aspect Ratio] is [16:9].</b></p> <p>[XL] (81 M): 12000×6736</p> <p>[LL] (40.5 M): 8496×4784</p> <p><b>When the [Aspect Ratio] is [1:1].</b></p> <p>[XL] (64 M): 8000×8000</p> <p>[LL] (32 M): 5664×5664</p> <ul style="list-style-type: none"> <li>• RAW images are always recorded in the [3:2] (12000×8000) aspect ratio.</li> </ul>

<b>[Picture Quality]</b>	<p>Set the compression rate at which the pictures are to be stored.</p> <p><b>[COMBINED]/[FINE]/[RAW+FINE]/[RAW]</b></p> <ul style="list-style-type: none"> <li>When set to [COMBINED], recording is with the same settings as [Picture Quality] in the [Photo] ([Image Quality]) menu. (However, [STD.] changes to [FINE].)</li> </ul>
<b>[Simul Record Normal Shot]</b>	<p>Simultaneously takes pictures that are not merged when [ON] is set. The first picture will be saved with [Picture Size] set to [L].</p>
<b>[Shutter Delay]</b>	<p>Sets the delay time from when the shutter button is pressed until the shutter is released.</p> <p><b>[30 SEC]/[15 SEC]/[8 SEC]/[4 SEC]/[2 SEC]/[1 SEC]/[1/2 SEC]/[1/4 SEC]/[1/8 SEC]/[Off]</b></p>
<b>[Motion Blur Processing]</b>	<p>Sets the correction method to use when the subject moved.</p> <p><b>[MODE1]:</b> This gives priority to High Resolution mode, therefore subject blur appears as an afterimage in the picture.</p> <p><b>[MODE2]:</b> This reduces afterimage from subject blur, but cannot obtain the same High Resolution mode effect in the corrected range.</p>

### 3 Start High Resolution mode.

- Select [Start] and then press  or .

### 4 Decide on the composition and then fix the camera in place.

- If blurring is detected, the High Resolution mode icon  blinks.



## 5 Start recording.

- Press the shutter button fully.
- With the default settings, [Shutter Delay] is activated, so there will be a gap in time from when the shutter button is pressed until the shutter is released.
- The screen goes dark during recording.
- The recording state indication (red) blinks.  
Do not move the camera while it is blinking.
- You can continue recording when the merging process ends.

## 6 End [High Resolution Mode].

- Press [Q].



- In [High Resolution Mode], recording will be performed using the following settings:
  - [Shutter Type]: [ELEC.] (When [Long Exposure NR] is set to [OFF])/ [ELEC.+NR] (When [Long Exposure NR] is set to [ON])
  - Minimum aperture value: F16
  - Shutter speed: 8 seconds to 1/8000 of a second
  - ISO sensitivity: Upper limit to [3200]
  - Focus mode: [AFS]/[MF]



# [HLG Photo]

iA P A S M  S&Q





Records an HLG format picture with a wide dynamic range. Bright lights that are easily overexposed, and dark areas that are easily underexposed can be recorded showing fine quality and rich colors just as seen with the human eyes.

Recorded pictures can be output over HDMI to devices (TV, etc.) that support HLG format pictures for viewing.

Additionally, devices that support the HSP format can directly play back images.

- “HLG (Hybrid Log Gamma)” is an international standard (ITU-R BT.2100) HDR format.
- “HSP” is an HDR picture format using HLG format video technology. These images are saved with a “.HSP” file extension.

 → [  ] → [  ] → Select [HLG Photo]

Setting items	[Aspect Ratio]					
	[4:3]	[3:2]	[16:9]	[1:1]	[65:24]	[2:1]
[Full-Res.]	5312×3984	5984×4000	5888×3312	4000×4000	—	—
[4K-Res.]	2880×2160	3232×2160	3840×2160	2144×2144	—	—
[OFF]	—					

- [Photo Style] can be selected from [Standard(HLG)] or [Monochrome(HLG)]. (→ 81)
- JPEG images and RAW images are recorded simultaneously in accordance with [Picture Quality] (→ 41) and [Picture Size] (→ 41).  
RAW images recorded with [HLG Photo] can be saved in the HLG format by using [RAW Processing].

## ❖ ISO Sensitivity When [HLG Photo] Is Set

The lower limit of available ISO sensitivities will become [400].



- The monitor and viewfinder on this camera do not support display of HLG format images.

In the [Custom] ([Monitor / Display (Video)]) menu, you can display the images converted for monitoring on the monitor/viewfinder of this camera with [Monitor] in [HLG View Assist]. (→ 128)



- HLG images appear darker on devices that do not support the HLG format.

With [HDMI] in [HLG View Assist] in the [Custom] ([Monitor / Display (Video)]) menu, you can set the conversion method for images displayed for monitoring. (→ 128)

# 9. Flash

## Using an External Flash (Optional)

This document gives an overview of recording with a flash. Refer to the “Owner’s Manual” (PDF format) for details about recording using a flash and recording with a wireless flash.

- ✎ • Flash recording is not possible when the following functions are being used:
  - [6K/4K PHOTO]/[Post-Focus]
  - [ELEC.]/[Silent Mode]/[High Resolution Mode]
  - [Filter Settings]

## Removing the Hot Shoe Cover

Before attaching the Flash (optional), remove the hot shoe cover. Refer to the operating instructions for the Flash for details about how to attach it.

**Remove the hot shoe cover by pulling it in the direction indicated by arrow ② while pressing it in the direction indicated by arrow ①.**

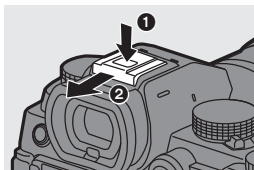

## [Flash Mode]

iA P A S M S&Q



Sets the flash mode.

→ → → **Select [Flash Mode]**



	<b>(Forced Flash On)</b>	The flash fires every time regardless of the recording conditions.
	<b>(Forced On/Red-Eye)</b>	This is suitable for recording when there is backlighting or under lighting such as fluorescent lighting.
	<b>(Slow Sync.)</b>	When recording images against a nightscape, this will slow the shutter speed when the flash fires to make not only the subject but also the nightscape appear brighter.
	<b>(Slow Sync./Red-Eye)</b>	<ul style="list-style-type: none"> <li>Slower shutter speeds may result in blurry images. To avoid this, we recommend using a tripod.</li> </ul>
	<b>(Forced Flash Off)</b>	The flash does not fire.

# 10. Recording Videos

## Recording Videos

iA P A S M  S&Q



It is possible with this camera to record video in 2 recording file formats, MP4 and MOV, to a maximum resolution of 4K.

It is also compatible with both the NTSC and PAL TV broadcast systems. [M] mode (Creative Video mode) and [S&Q] mode (Slow & Quick mode) are recording modes specifically for video.

In the [S&Q] mode, you can record smooth slow motion video and quick motion video by changing the frame rate.

### 1 Start recording.

- Press the video rec. button.
- Release the video rec. button right after you press it.

### 2 Stop recording.

- Press the video rec. button again.

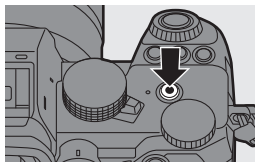

### ❖ Screen Displays While Video Recording

The live view angle of view changes to the angle of view for video recording, and video recording time (A) and elapsed recording time (B) are displayed.

- “h” is an abbreviation for hour, “m” for minute and “s” for second.
- The recording state indication (C) and card access indication (D) turn red while videos are being recorded.

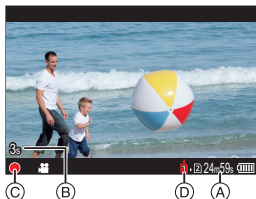

- If maintaining focus on the subject is difficult during video recording with AF, press the shutter button halfway to re-adjust the focus.

## ❖ Exposure Control While Video Recording

Videos will be recorded using the aperture, shutter speed, and ISO sensitivity settings below.

Recording mode	Aperture value/shutter speed/ISO sensitivity
[iA]	The camera automatically makes the settings to suit the scene.
[P]/[A]/[S]/[M]	The settings vary depending on the [Auto Exposure in P/A/S/M] in the [Custom] ([Image Quality]) menu. The default setting is [ON]. [ON]: Records with values set automatically by the camera. [OFF]: Records with manually set values.
[M]/[S&Q]	Records with manually set values.

## ❖ Size Interval for Dividing Files

[Rec. File Format]	[Rec Quality]	Size interval for dividing files
[MP4]	[FHD]	A new file will be created to continue recording if the continuous recording time exceeds 30 minutes or the file size exceeds 4 GB.
	[4K]	<b>When using an SDHC memory card:</b> A new file will be created to continue recording if the continuous recording time exceeds 30 minutes or the file size exceeds 4 GB.
[MOV]	All	<b>When using an SDXC memory card:</b> A new file will be created to continue recording if the continuous recording time exceeds 3 hours and 4 minutes or the file size exceeds 96 GB.



- If an operation such as a zoom or button operation is performed during video recording, that operation sound may be recorded.
- The lens operation sound (AF and image stabilizer) may be recorded to video.
- If the operation sound of pressing the video rec. button to end recording bothers you, try the following:
  - Record the video about 3 seconds longer, and then divide the last part of the video using [Video Divide] in the [Playback] ([Edit Image]) menu.
  - Use the Shutter Remote Control (DMW-RS2: optional) for recording.
- Depending on the type of card, the card access indication may appear for a while after video recording. This is not a malfunction.
- Even when playback is performed on a supported device, situations may occur where image or sound quality is poor, recording information is not displayed correctly, or playback is not possible, for example. If you experience any of these, play them back on the camera.
- If the temperature of the camera rises, [] may be displayed, recording may stop, and some functions may become unavailable temporarily. Wait until the camera cools down.
- Video recording is not possible while you are using the following functions:
  - [Time Lapse Shot]
  - [Stop Motion Animation]
  - [Rough Monochrome]/[Silky Monochrome]/[Soft Focus]/[Star Filter]/[Sunshine] ([Filter Settings])
  - [HLG Photo]
  - [Post-Focus]



- The available recording time can be displayed during recording standby:
  - [] ⇒ [] ⇒ [Photos/Videos Remaining] (→ 154)
- You can switch the live view angle of view to the angle of view for video recording:
  - [] ⇒ [] ⇒ [Photo/Video Preview] (→ 153)
- You can display a red frame on the recording screen that indicates that video is being recorded:
  - [] ⇒ [] ⇒ [Red REC Frame Indicator] (→ 154)

## Recording Modes Specifically for Video (Creative Video/S&Q)



[M] mode (Creative Video mode) and [S&Q] mode (Slow & Quick mode) are recording modes specifically for video.

In the [S&Q] mode, you can record smooth slow motion video and quick motion video by changing the frame rate.

In the recording modes specifically for video, you can start and stop video recording with the shutter button.

Change the exposure and audio settings with touch operation to prevent operation sounds from being recorded.

Settings such as exposure and white balance can be changed independent of picture taking settings.

### Setting the Exposure for Recording Videos

- 1 Set the mode dial to [M] or [S&Q].

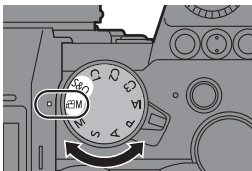

- 2 Set the exposure mode.

- → [] → [] → [Exposure Mode] → [P]/[A]/[S]/[M]
- You can perform the same exposure operations as the [P]/[A]/[S]/[M] modes.



- 3 Close the menu.

- Press the shutter button halfway.



#### 4 Start recording.

- Press the shutter button (A) or video rec. button (B).

#### 5 Stop recording.

- Press the shutter button or video rec. button again.

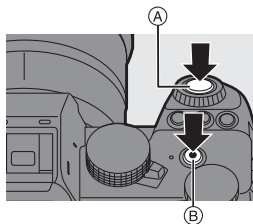

- ➔ • Refer to “Slow & Quick Video” on page 118 for information about slow motion video and quick motion video recording.

### ❖ Operations During Video Recording

You can change the exposure and other settings with touch operations to prevent operation sounds from being recorded.

- 🔍 • With the default settings, the Touch Tab is not displayed.  
Set [Touch Tab] to [ON] in [Touch Settings] in the [Custom] ([Operation]) menu. (→ 153)

- 1 Touch [👤] or [S&Q].
- 2 Touch an icon.

F	Aperture value	ISO	ISO sensitivity
SS	Shutter speed	🔊 *1	Sound recording level adjustment
⊕/⊖	Exposure compensation	S&Q *2	Slow & Quick setting

\*1 This setting is available only in [pCM] mode.

\*2 This setting is available only in [S&Q] mode. (The setting cannot be changed during recording)

### 3 Drag the slide bar to set the item.

[▼]/[▲]: Changes the setting slowly.

[▼]/[▲]: Changes the setting quickly.

- If you touch icon , the screen of Step 2 is redisplayed.

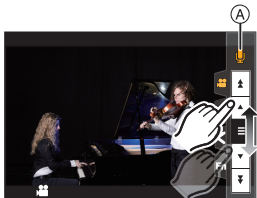



## Separating Settings for Recording Video and Pictures



iA P A S M  S&Q



In default settings, settings such as exposure and white balance changed in [P]/[S&Q] mode are also reflected in picture recording in [P]/[A]/[S]/[M] modes.

From the [CreativeVideo Combined Set.] menu, you can separate settings for video recording and for picture recording.

 → [⚙️] → [] → Select [CreativeVideo Combined Set.]

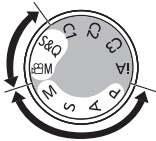
[F/SS/ISO/Exposure Comp.]	 : The recording settings are linked across recording modes.	
[White Balance]		
[Photo Style]	 : Recording settings can be separated by the [P]/[S&Q] mode and the [P]/[A]/[S]/[M] mode.	
[Metering Mode]		
[AF Mode]		

- The [iA] mode uses the optimum recording settings for the camera automatically, so the recording settings will be independent, irrespective of the settings made with this function.

## Video Recording Settings

This section describes the settings used when video recording.

- ➔ In "4. Image Recording", the functions described work with both pictures and video.

Please also refer to that section.



- [Double Card Slot Function]: ➔ 42
- [Folder / File Settings]: ➔ 43
- [File Number Reset]: ➔ 

### [Switch NTSC/PAL]



The image qualities you can select in [Rec Quality] are switched to the image qualities with the frame rate to suit the NTSC/PAL TV broadcast system.

The default setting is for the frame rate to be set to suit the TV broadcast system for the region where the camera was purchased.

-  ➔  ➔  ➔ Select [Switch NTSC/PAL]

<b>[NTSC]</b>	The image qualities for NTSC can be selected in [Rec Quality].
<b>[PAL]</b>	The image qualities for PAL can be selected in [Rec Quality].

-  • If you record using the setting that differs from the broadcasting system of your region, it may not be possible for you to properly play back videos on your TV.  
We recommend using the setting as it was at the time of purchase if you are unsure about broadcasting systems.

## [Rec. File Format]



Sets the recording file format of videos to be recorded.

→ → → Select [Rec. File Format]

<b>[MP4]</b>	This file format is suitable for playback on PCs.
<b>[MOV]</b>	This file format is suitable for image editing.

## [Image Area of Video]



Set the image area during video recording. The angle of view differs depending on the image area. Narrowing the image area allows you to achieve a telescopic effect without image deterioration.

→ → → Select [Image Area of Video]

Item	Settings details	Angle of view	Telescopic effect
<b>[FULL]</b>	Recording is within the area suited to the image circle of a full-frame lens.	 Wide  Narrow	 None  High
<b>[APS-C]</b>	Records using a range corresponding to the APS-C lens image circle.		
<b>[PIXEL/PIXEL]</b>	Records with one pixel on the sensor, which is equal to one pixel of the video. Records a range corresponding to the resolution range in [Rec Quality]. (→ 101)		

- To check the image area in recording modes other than [M] [S&Q] mode, set [Photo/Video Preview] to [ ]. (→ 153)
- It is not possible to set to [FULL] in the following cases.
  - When a 4K/60p or 4K/50p [Rec Quality] is set
  - When set to [Anamorphic(4:3)]
  - When using APS-C lenses
- When set to [Live Cropping], the setting is fixed to [FULL]. However, the setting is fixed to [APS-C] in the following case:
  - When a 60p or 50p [Rec Quality] is set

### Image area (Ex.: FHD video)

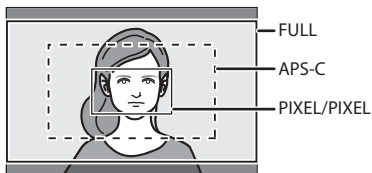

## [Rec Quality]

iA P A S M M S&Q



Sets the image quality of videos to be recorded.

The image qualities you can select depend on the [Switch NTSC/PAL] and [Rec. File Format] settings.

MENU/SET → [ ] → [ ] → Select [Rec Quality]

- To record video with a bit rate of 72 Mbps or more, you require a card with the corresponding Speed Class.  
For information about the cards that can be used, refer to page 32.
- You can set the recording quality for anamorphic recordings made with an aspect ratio of 4:3 in the [Anamorphic(4:3)] menu. (→ 130)

## ❖ [Rec. File Format]: [MP4]

• Audio format: AAC (2ch)

(A) Recording frame rate

(B) Bit rate (Mbps)

(C) Video compression format (**HEVC**: H.265/HEVC, **AVC**: H.264/MPEG-4 AVC)

[Switch NTSC/PAL]: [NTSC]					
[Rec Quality]	Resolution	YUV/bit	(A)	(B)	(C)
[4K/10bit/100M/60p]*	3840×2160	4:2:0/10 bit	59.94p	100	HEVC
[4K/8bit/100M/30p]	3840×2160	4:2:0/8 bit	29.97p	100	AVC
[4K/10bit/72M/30p]*	3840×2160	4:2:0/10 bit	29.97p	72	HEVC
[4K/8bit/100M/24p]	3840×2160	4:2:0/8 bit	23.98p	100	AVC
[4K/10bit/72M/24p]*	3840×2160	4:2:0/10 bit	23.98p	72	HEVC
[FHD/8bit/28M/60p]	1920×1080	4:2:0/8 bit	59.94p	28	AVC
[FHD/8bit/20M/30p]	1920×1080	4:2:0/8 bit	29.97p	20	AVC
[FHD/8bit/24M/24p]	1920×1080	4:2:0/8 bit	23.98p	24	AVC

[Switch NTSC/PAL]: [PAL]					
[Rec Quality]	Resolution	YUV/bit	(A)	(B)	(C)
[4K/10bit/100M/50p]*	3840×2160	4:2:0/10 bit	50.00p	100	HEVC
[4K/8bit/100M/25p]	3840×2160	4:2:0/8 bit	25.00p	100	AVC
[4K/10bit/72M/25p]*	3840×2160	4:2:0/10 bit	25.00p	72	HEVC
[FHD/8bit/28M/50p]	1920×1080	4:2:0/8 bit	50.00p	28	AVC
[FHD/8bit/20M/25p]	1920×1080	4:2:0/8 bit	25.00p	20	AVC

\* Recording stops when the continuous recording time exceeds 30 minutes.

## ❖ [Rec. File Format]: [MOV]

- Audio format: LPCM (2ch)
- Ⓐ Recording frame rate
- Ⓑ Bit rate (Mbps)
- Ⓒ Video compression format (**HEVC**: H.265/HEVC, **AVC**: H.264/MPEG-4 AVC)

[Switch NTSC/PAL]: [NTSC]					
[Rec Quality]	Resolution	YUV/bit	Ⓐ	Ⓑ	Ⓒ
[4K/60p/420/10-L]*	3840×2160	4:2:0/10 bit	59.94p	200	HEVC
[4K/60p/420/8-L]*	3840×2160	4:2:0/8 bit	59.94p	150	AVC
[4K/30p/422/10-L]*	3840×2160	4:2:2/10 bit	29.97p	150	AVC
[4K/30p/420/8-L]	3840×2160	4:2:0/8 bit	29.97p	100	AVC
[4K/24p/422/10-L]*	3840×2160	4:2:2/10 bit	23.98p	150	AVC
[4K/24p/420/8-L]	3840×2160	4:2:0/8 bit	23.98p	100	AVC
[FHD/60p/422/10-L]	1920×1080	4:2:2/10 bit	59.94p	100	AVC
[FHD/60p/420/8-L]	1920×1080	4:2:0/8 bit	59.94p	100	AVC
[FHD/30p/422/10-L]	1920×1080	4:2:2/10 bit	29.97p	100	AVC
[FHD/30p/420/8-L]	1920×1080	4:2:0/8 bit	29.97p	100	AVC
[FHD/24p/422/10-L]	1920×1080	4:2:2/10 bit	23.98p	100	AVC
[FHD/24p/420/8-L]	1920×1080	4:2:0/8 bit	23.98p	100	AVC

[Switch NTSC/PAL]: [PAL]					
[Rec Quality]	Resolution	YUV/bit	Ⓐ	Ⓑ	Ⓒ
[4K/50p/420/10-L]*	3840×2160	4:2:0/10 bit	50.00p	200	HEVC
[4K/50p/420/8-L]*	3840×2160	4:2:0/8 bit	50.00p	150	AVC
[4K/25p/422/10-L]*	3840×2160	4:2:2/10 bit	25.00p	150	AVC
[4K/25p/420/8-L]	3840×2160	4:2:0/8 bit	25.00p	100	AVC
[FHD/50p/422/10-L]	1920×1080	4:2:2/10 bit	50.00p	100	AVC
[FHD/50p/420/8-L]	1920×1080	4:2:0/8 bit	50.00p	100	AVC
[FHD/25p/422/10-L]	1920×1080	4:2:2/10 bit	25.00p	100	AVC
[FHD/25p/420/8-L]	1920×1080	4:2:0/8 bit	25.00p	100	AVC

\* Recording stops when the continuous recording time exceeds 30 minutes.

- In this document, videos are indicated as follows according to their resolution:
  - 4K (3840×2160) video: **4K video**
  - Full High Definition (1920×1080) video: **FHD video**



- All videos will be recorded using Long GOP to compress the images.
- Since the camera employs the VBR recording format, the bit rate is changed automatically depending on the subject to record. As a result, video recording time is shortened when a fast-moving subject is recorded.
- When using the following function, you can only select 8-bit FHD video:
  - [Miniature Effect] ([Filter Settings])

## Time Code



When video is recorded in the MOV format, the hour, minute, seconds, and number of frames information (time code) is recorded automatically.

The time code is used to synchronize multiple image and audio sources.

- The time code is not recorded with video in the MP4 format.

## Setting the Time Code

Sets the recording, display, and output of the time code.

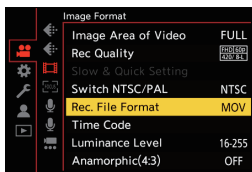

### 1 Set [Rec. File Format] to [MOV].

- → → → [Rec. File Format] → [MOV]





## 2 Select [Time Code].

-  →  →  → [Time Code]

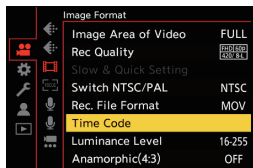

[Time Code Display]	Displays the time code on the recording screen/playback screen.	
[Count Up]	[REC RUN]	Counts the time code only when recording videos.
	[FREE RUN]	Counts the time code also when video recording is stopped and when the camera is turned off.
[Time Code Value]	[Reset]	Sets to 00:00:00:00 (hour: minute: second: frame)
	[Manual Input]	Manually input hour, minute, second and frame.
	[Current Time]	Sets hour, minute and second to current time and sets frame to 00.
[Time Code Mode]	[DF]	Drop Frame. The camera modifies the difference between recorded time and time code. <ul style="list-style-type: none"> <li>• Seconds and frames are separated by “.”. (Example: 00:00:00.00)</li> </ul>
	[NDF]	Non-Drop Frame. Records the time code without drop frame. <ul style="list-style-type: none"> <li>• Seconds and frames are separated by “.”. (Example: 00:00:00.00)</li> </ul>
	<ul style="list-style-type: none"> <li>• When the following functions are being used, [Time Code Mode] is fixed to [NDF]:               <ul style="list-style-type: none"> <li>– [PAL] ([Switch NTSC/PAL])</li> <li>– 24p [Rec Quality]</li> </ul> </li> </ul>	
[HDMI Time Code Output]	<p>Time code information is added to images output via HDMI when recording with the [M] mode.</p> <ul style="list-style-type: none"> <li>• The time code can also be output via HDMI by setting the mode dial to [M] during playback. In the [Setup] ([IN/OUT]) menu, set [HDMI Mode (Playback)] in [TV Connection] to [AUTO].</li> <li>• The device screen may go dark depending on the connected device.</li> </ul>	

## Using AF (Video)

This section describes the use of AF when video recording.

- ➔ • In "5. Focus/Zoom", the functions described work with both pictures and video. Please also refer to that section.
- Selecting the Focus Mode: ➔ 44
  - Selecting the AF Mode: ➔ 47
  - AF Area Movement Operation: ➔ 51
  - Record Using MF: ➔ 52
  - Recording with Zoom: ➔ 54

### [Continuous AF]



You can select how to set the focus in AF when recording videos.

➔ [] ➔ [] ➔ Select [Continuous AF]

<b>[MODE1]</b>	The camera continues to automatically focus only during recording.
<b>[MODE2]</b>	<p>The camera automatically keeps focusing on subjects during recording standby and during recording.</p> <ul style="list-style-type: none"> <li>• The camera can keep focusing during recording standby when any of the following are set:               <ul style="list-style-type: none"> <li>– [] mode</li> <li>– [S&amp;Q] mode</li> <li>– [Photo/Video Preview] in the [Custom] ([Monitor / Display]) menu is set to []</li> </ul> </li> </ul>
<b>[OFF]</b>	The camera maintains the focus point at the start of recording.



- In the [iA] mode, the camera automatically keeps focusing during recording standby, irrespective of the [Continuous AF] setting.
- Depending on the recording conditions or lens used, the AF operation sound may be recorded during video recording.  
If the operation sound bothers you, we recommend recording with [Continuous AF] set to [OFF].
- If the zoom is operated while recording videos, the subject may take a while to come into focus.
- When the following function is being used, [MODE1] switches to [MODE2]:
  - HDMI output
- [MODE2] does not work during recording standby in the following cases:
  - In preview mode
  - In low light situations

## [AF Custom Setting(Video)]



You can fine-adjust the focusing method for video recording using [Continuous AF].



⇒ [ ] ⇒ [ ] ⇒ Select [AF Custom Setting(Video)]

[ON]	Enables the following settings.	
[OFF]	Disables the following settings.	
[SET]	[AF Speed]	<p>[+] <b>side</b>: Focus moves at a faster speed.</p> <p>[-] <b>side</b>: Focus moves at a slower speed.</p>
	[AF Sensitivity]	<p>[+] <b>side</b>: When the distance to the subject changes significantly, the camera immediately readjusts the focus.</p> <p>[-] <b>side</b>: When the distance to the subject changes significantly, the camera waits for a little before readjusting the focus.</p>

## Video Brightness and Coloring

This section describes the brightness and coloring settings used during video recording.



- In “7. Metering/Exposure/ISO Sensitivity” and “8. White Balance/Image Quality”, the functions described work with both pictures and video.

Please also refer to those sections.

- [Metering Mode]: → 71
- Exposure Compensation: → 75
- Locking Focus and Exposure (AF/AE Lock): → 76
- ISO Sensitivity: → 77
- White Balance (WB): → 79
- [Photo Style]: → 81
- [Filter Settings]: → 84

### [Luminance Level]



You can set the luminance range to suit the purpose of video recording. You can set to [16-235] or [16-255], the standard for video, or to [0-255], which covers the entire range of luminance, the same as pictures.



⇒ [ ] ⇒ [ ] ⇒ Select [Luminance Level]

Settings: [0-255]/[16-235]/[16-255]



- When set to a 10-bit [Rec Quality], the setting items change to [0-1023], [64-940], and [64-1023].
- When [Photo Style] is set to [V-Log], this is fixed to [0-255] ([0-1023]).
- When [Photo Style] is set to [Like2100(HLG)], this is fixed to [64-940].

## Recording While Controlling Overexposure (Knee)



When [Photo Style] is set to [Like709], you can adjust the knee so that recording can be performed with minimal overexposure.

### 1 Set [Photo Style] to [Like709].

- → → → [Photo Style] → [Like709]

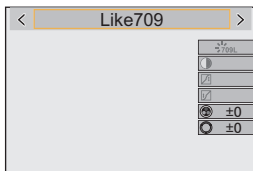

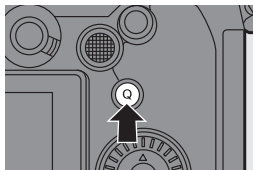

### 2 Press [Q].

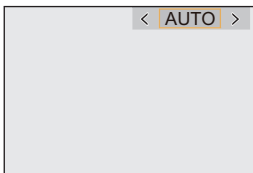

### 3 Select a knee setting.

- Press ◀▶ to select a setting item.



[AUTO]	Adjusts the compression levels of high-luminance areas automatically.
[MANUAL]	<p>You can set the luminance where compression starts (knee master point) and the intensity of compression (knee master slope).</p> <p><b>Press ▲▼ to select an item and then press ◀▶ to adjust.</b></p> <p><b>[POINT]:</b> Knee master point  <b>[SLOPE]:</b> Knee master slope</p> <ul style="list-style-type: none"> <li>• Rotate  to adjust the knee master point, and  to adjust the knee master slope.</li> <li>• Values within the following ranges can be set:           <ul style="list-style-type: none"> <li>– Knee master point: 80.0 to 107.0</li> <li>– Knee master slope: 0 to 99</li> </ul> </li> </ul>
[Off]	—

### 4 Confirm your selection.

- Press  or .

## [ISO Sensitivity (video)]

iA P A S M  S&Q



Sets the lower and upper limits for ISO sensitivity when ISO sensitivity is set to [AUTO].

- 1 Set the mode dial to [] or [S&Q].

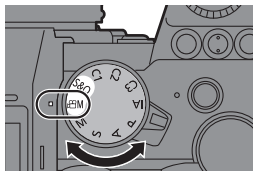

- 2 Set [ISO Sensitivity (video)].

 → [] → [] →  
 [ISO Sensitivity (video)]

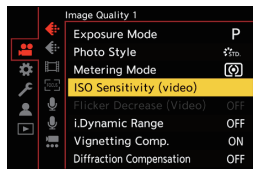

### ❖ Setting Items ([ISO Sensitivity (video)])

[ISO Auto Lower Limit Setting]	Sets the lower limit for ISO sensitivity when ISO sensitivity is [AUTO]. <ul style="list-style-type: none"> <li>• Set in the range between [100] and [25600].</li> </ul>
[ISO Auto Upper Limit Setting]	Sets the upper limit for ISO sensitivity when ISO sensitivity is [AUTO]. <ul style="list-style-type: none"> <li>• Set to [AUTO] or in the range between [200] and [51200].</li> </ul>

# Audio Settings



This section describes the audio settings used when video recording.

## Displaying the [Audio] menu.

- → [ ] [Video] menu → [ ] [Audio]

<b>[Sound Rec Level Disp.]</b>	<p>The sound recording level is displayed on the recording screen.</p> <ul style="list-style-type: none"> <li>• When [Sound Rec Level Limiter] is set to [OFF], [Sound Rec Level Disp.] is fixed to [ON].</li> </ul>
<b>[Sound Rec Level Adj.]</b>	<p>Manually adjust the sound recording level. Press ◀▶ to adjust the sound recording level and then press  or .</p> <p><b>[MUTE]/[-12dB] to [+6dB]</b></p> <ul style="list-style-type: none"> <li>• You can adjust by 1 dB increments.</li> <li>• Displayed dB values are approximate.</li> <li>• When set to [MUTE], [] is displayed in the recording screen.</li> </ul>
<b>[Sound Rec Level Limiter]</b>	<p>The sound recording level is adjusted automatically to minimize sound distortion (crackling noise).</p>
<b>[Wind Noise Canceller]</b>	<p>This reduces the wind noise coming into the built-in microphone while maintaining sound quality.</p> <p><b>[HIGH]:</b> This effectively reduces the wind noise by reducing the low-pitched sound when a strong wind is detected.</p> <p><b>[STANDARD]:</b> This reduces wind noise without loss of sound quality by filtering out only wind noise.</p> <p><b>[OFF]:</b> Turns the function off.</p> <ul style="list-style-type: none"> <li>• You may not see the full effect depending on the recording conditions.</li> <li>• This function works only with the built-in microphone. When an external microphone is connected, [Wind Cut] is displayed. (→ 141)</li> </ul>



# Main Assist Functions

This section describes the main assist functions that are convenient when recording.

- ➔ The [Custom] ([Monitor / Display (Video)]) menu has display assist functions such as the center marker.  
Refer to the "Owner's Manual" (PDF format) for details.

## [Waveform Monitor]

iA P A S M  S&Q





You can display in the recording screen a waveform.

You can check detailed information about the brightness.

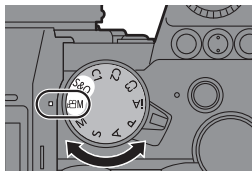
- 1 Set the mode dial to [] or [S&Q].



- 2 Set [Waveform Monitor].

-  ➔  ➔  ➔ [Waveform Monitor] ➔ [ON]

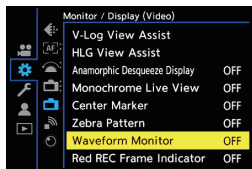

### 3 Select the position to display.

- Press ▲▼◀▶ to select and then press **MENU/SET** or  .
- You can also move using touch operations.
- To return the waveform or vector scope position back to the center, press [DISP.].

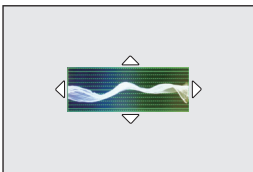

### ❖ Screen Displays

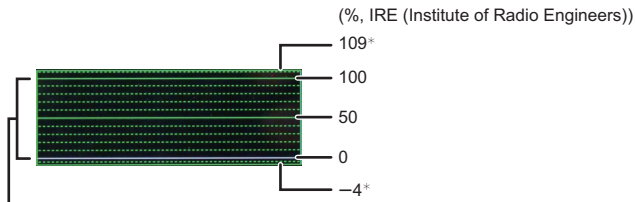

The range between 0 and 100 shows dotted lines at intervals of 10.

\* Dotted line

Display example)

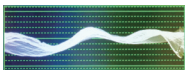

- The waveform displayed on the camera indicates the luminance as values based on the conversions below:

0 % (IRE): Luminance value 16 (8-bit)

100 % (IRE): Luminance value 235 (8-bit)



- You can also change the position by dragging on the recording screen.
- Waveforms cannot be output over HDMI.

## [Luminance Spot Meter]



Specify any spot on the subject to measure the luminance over a small area.

### 1 Set [Luminance Spot Meter].

- Press **MENU/SET** → **[Settings]** → **[Camera]** → [Luminance Spot Meter] → **[ON]**



### 2 Select the position where you want to measure the luminance.

- Press **▲▼◀▶** to select and then press **MENU/SET** or **DISP.**

(A) Luminance value

- You can also change the position by dragging the frame on the recording screen.
- To return the position back to the center, press **[DISP.]**.

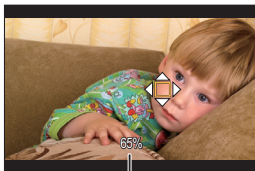

### ❖ Measurement Range

Measuring is possible in the range  $-7\%$  to  $109\%$  (IRE).

- When [Photo Style] is set to [V-Log], this can be measured with "Stop" units. (Calculated as "0 Stop"= $42\%$  (IRE))

## [Zebra Pattern]

iA P A S M  S&Q



Parts that are brighter than the base value are displayed with stripes. You can also set the base value and the breadth of the range so that the stripes are displayed on parts that are within the range of brightness you specify.



[ZEBRA1]



[ZEBRA2]



[ZEBRA1+2]

 →  →  → Select [Zebra Pattern]

[ZEBRA1]	Parts that are brighter than the base value are displayed with [ZEBRA1] stripes.	
[ZEBRA2]	Parts that are brighter than the base value are displayed with [ZEBRA2] stripes.	
[ZEBRA1+2]	Both [ZEBRA1] and [ZEBRA2] are displayed.	
[OFF]	—	
[SET]	[Zebra 1]	[50%] to [105%]/ [BASE/RANGE]
	[Zebra 2]	[50%] to [105%]/ [BASE/RANGE]
	Sets the base brightness.	

## ❖ When [BASE/RANGE] Was Selected with [SET]

Centered on the brightness set with [Base Level], parts with the brightness in the range set in [Range] are displayed with the stripes.

- [Base Level] can be set in the range between 0 % and 109 % (IRE).
- [Range] can be set in the range between  $\pm 1$  % and  $\pm 10$  % (IRE).
- When [Photo Style] is set to [V-Log], these are set at “Stop” units.  
(Calculated as “0 Stop”=42 % (IRE))



- [ZEBRA1+2] cannot be selected while you are setting [BASE/RANGE].

## [Frame Marker]



A frame with the set aspect ratio is displayed on the recording screen. This allows you to see during recording the angle of view that will be achieved with trimming (cropping) in post-processing.



→ [  ] → [  ] → Select [Frame Marker]

	[ON]	Displays the Frame Marker on the recording screen.
	[OFF]	—
[SET]	[Frame Aspect]	Sets the aspect ratio of the Frame Marker. [2.39:1]/[2.35:1]/[2.00:1]/[1.85:1]/[16:9]/[4:3]/ [5:4]/[1:1]/[4:5]/[9:16]
	[Frame Color]	Sets the color of the Frame Marker.
	[Frame Mask]	Sets the opacity of the outside of the Frame Marker. [100%]/[75%]/[50%]/[25%]/[OFF]

# Slow & Quick Video

iA P A S M S&Q



In the [S&Q] mode, the camera records at a different frame rate to the recording frame rate, enabling the creation of slow motion video and quick motion video in the MP4 format.

<p><b>Slow Motion Video (Overcrank Recording)</b></p>	<p>Set a number of frames that is higher than the recording frame rate of the [Rec Quality]. For example: When recording at 60 fps when set to a 30p [Rec Quality], the speed is halved.</p>
<p><b>Quick Motion Video (Undercrank Recording)</b></p>	<p>Set a number of frames that is lower than the recording frame rate of the [Rec Quality]. For example: When recording at 15 fps when set to a 30p [Rec Quality], the speed is doubled.</p>

## 1 Set the mode dial to [S&Q].

- [Rec. File Format] changes to [MP4].

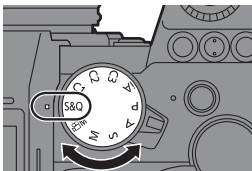



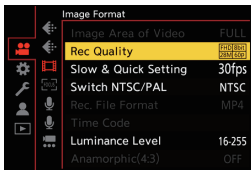

## 2 Select a recording quality with which you can record Slow & Quick video.

- → → → [Rec Quality]

- Items available for recording with Slow & Quick video are indicated as [S&Q available].
- Recording qualities with which you can record Slow & Quick video: → 133



### 3 Set the frame rate.

- Press **MENU/SET** → [ ] → [ ] → [Slow & Quick Setting]
- Rotate ,  or  to select a numeric value, then press **MENU/SET** or .

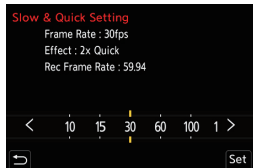

- You can set a frame rate in the following ranges:
  - 4K video: 1 fps to 60 fps
  - FHD video: 1 fps to 180 fps
- Refer to the “Owner’s Manual” (PDF format) for information about the effects (playback speeds) for the different frame rates.



- Audio will not be recorded during Slow & Quick recording.
- When [Rec Quality] is set to [4K], [Image Area of Video] is fixed to [APS-C].
- When [Rec Quality] is set to [FHD], [Image Area of Video] is fixed to [FULL].
- The mode switches to MF when you set to a frame rate of 150 fps or more.
- The angle of view is reduced when you set the frame rate to 180 fps.
- Recording stops when the continuous recording time exceeds 30 minutes.

# [Live Cropping]

iA P A S M  S&Q



By cropping a part of the image from the image displayed in the live view, it is possible to record FHD video that incorporates panning and zooming with the camera staying in a fixed position.

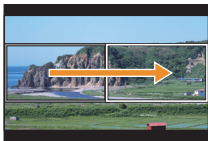

**Pan**

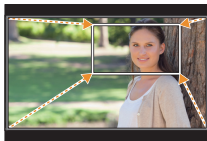



**Zoom in**

-  • Use a tripod to minimize camera shake.

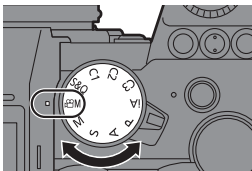
**1** Set the mode dial to .



**2** Set [Rec. File Format] to [MP4] or [MOV].

-  →  →  → [Rec. File Format] → [MP4]/[MOV]

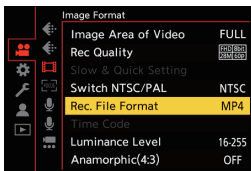



### 3 Select a recording quality with which you can record [Live Cropping] video.

- **MENU/SET** → [ ] → [ ] → [Rec Quality]
- A recording quality with which you can record [Live Cropping] video: → 133

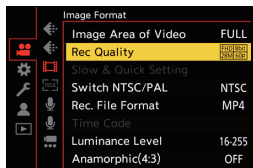

### 4 Set the time for panning or zooming.

- **MENU/SET** → [ ] → [ ] → [Live Cropping] → [40SEC]/[20SEC]
- If you have selected a recording quality where Live Cropping recording is not available, the camera switches to an FHD video recording quality where recording is possible. (→ 133)



### 5 Set the cropping start frame

- Ⓐ.
- Select the range to be cropped and press **MENU/SET** or **DISP.**

### 6 Set the cropping end frame

- Select the range to be cropped and press **MENU/SET** or **DISP.**
- To redo the settings for the position and size of the start frame and the end frame, press **◀**.

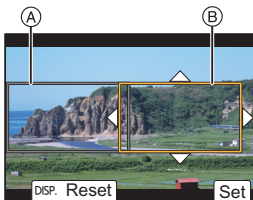

## 7 Start Live Cropping recording.

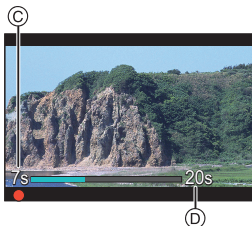
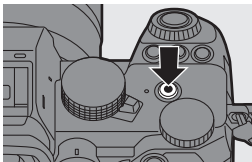

- Press the video rec. button.
- Ⓒ Elapsed recording time
- Ⓓ Set operating time
- When the set operating time has elapsed, recording automatically ends.  
To end recording midway, press the video rec. button again.



### ❖ Operations for Setting the Cropping Frame

Button operation	Touch operation	Description of operation
▲▼◀▶	Touch	Moves the frame.
☀ / ⚙	Pinch out/ pinch in	Enlarges/reduces the frame in small steps.
☀	—	Enlarges/reduces the frame.
[DISP.]	[Reset]	Start frame: Returns the frame position and size to the default settings. End frame: Cancels the settings for the position and size of the frame.
Ⓜ / Ⓜ	[Set]	Confirms the frame position and size.



- AF mode switches to [  ] (face detection). (Human bodies cannot be detected. It is not possible to specify the person to bring into focus.)
- Brightness measurements and focusing are performed within the cropping frame. To lock the focus point, set [Continuous AF] to [OFF], or set the focus mode to [MF].
- [Metering Mode] will be [  ] (multi-metering).

## Log Recording

iA P A S M  S&Q



Setting [Photo Style] to [V-Log] enables Log recording.

Images finished with rich gradation can be created through post-production processing.



→ [  ] → [  ] → [Photo Style] → Select [V-Log]



- Post-production processing is enabled by utilizing LUT (Look-Up Table). You can download LUT data from the following support site:  
<https://panasonic.jp/support/global/cs/dsc/download/index3.html>  
(English only)

### ❖ ISO Sensitivity When [V-Log] Is Set

The lower limit of available ISO sensitivity is [640] (when [Extended ISO] is set: [320]), and the upper limit is [51200].

## ❖ Exposure When [V-Log] Is Set

The [V-Log] curve characteristics comply with “V-Log/V-Gamut REFERENCE MANUAL Rev.1.0”. When set to [V-Log], the standard exposure when gray with a reflectance ratio of 18 % is imaged is IRE 42 %.

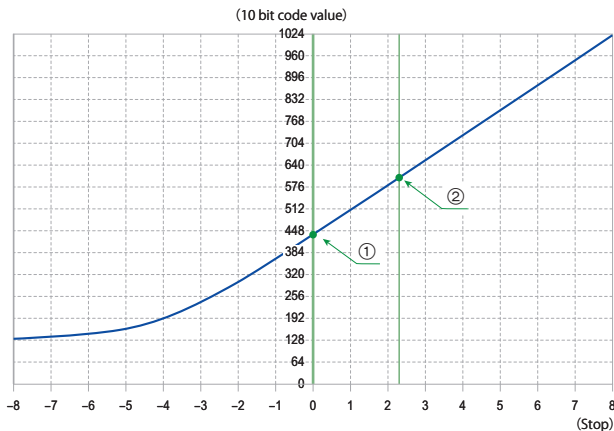

When [Photo Style] is set to [V-Log]

Reflectance ratio (%)	IRE (%)	Stop	10 bit code value	12 bit code value
0	7.3	—	128	512
① 18	42	0.0	433	1732
② 90	61	2.3	602	2408

- When luminance is to be displayed by “Stop” units, this camera calculates IRE 42 % to “0 Stop”.





- Luminance can be checked by “Stop” units:

[⚙️] ⇒ [📷] ⇒ [Luminance Spot Meter] (→ 115)

[⚙️] ⇒ [📷] ⇒ [Zebra Pattern] (→ 116)

## [V-Log View Assist]

When [Photo Style] is set to [V-Log], the recording screen and images output via HDMI will darken. Using [V-Log View Assist] means you can show images with LUT data applied on the monitor/viewfinder and output them via HDMI.

 →  →  → Select [V-Log View Assist]

[Read LUT File]	Reads LUT data from the card.
[LUT Select]	Selects the LUT data to be applied from among the preset ([Vlog_709]) and registered LUT data.
[LUT View Assist (Monitor)]	Displays the images with LUT data applied on the monitor/viewfinder of the camera.
[LUT View Assist (HDMI)]	Applies LUT data to images output over HDMI.









- When applying the LUT data, [LUT] is displayed on the recording screen.
- Up to 4 LUT data files can be registered.

## ❖ Reading LUT Files



- The following LUT data can be used:
  - The “.vlt” format, which meets the requirements specified in the “VARICAM 3DLUT REFERENCE MANUAL Rev.1.0”
  - File names consisting of up to 8 alphanumeric characters (excluding extension)
- Save the LUT data with a file extension of “.vlt” in the root directory of the card (the folder opened when the card is opened on a PC).

- 1 Insert a card on which LUT data is saved into the camera.
- 2 Select [Read LUT File].
  -  →  →  → [V-Log View Assist] → [Read LUT File] → [Card Slot 1]/[Card Slot 2]
- 3 Press ▲▼ to select the LUT data to read and then press  or .
- 4 Press ▲▼ to select the location to register the data, and then press  or .
  - When registered items are selected, they will be overwritten.

# HLG Videos

iA P A S M  S&Q



Record videos with the wide dynamic range of the HLG format. You can record in very bright light where overexposure can occur or in dark areas where underexposure can occur, maintaining the rich yet subtle colors you can see with your naked eye.



You can view the video that you record by outputting via HDMI to devices (TVs, etc.) that support the HLG format, or playing back directly on supporting devices.

- “HLG (Hybrid Log Gamma)” is an international standard (ITU-R BT.2100) HDR format.

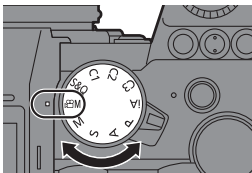
## 1 Set the mode dial to .



## 2 Set [Rec. File Format] to [MP4] or [MOV].

-  →  →  → [Rec. File Format] → [MP4]/[MOV]

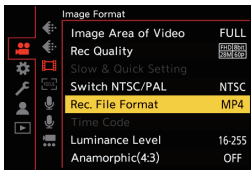

### 3 Select a recording quality with which you can record HLG video.

-  →  →  → [Rec Quality]

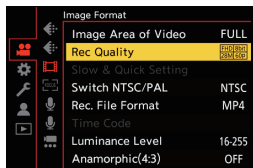

- Items available for recording with HLG video are indicated as [HLG available].
- Recording qualities with which you can record HLG video: → 133

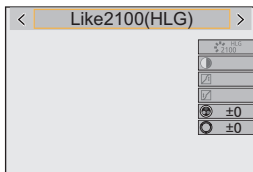

### 4 Set [Photo Style] to [Like2100(HLG)].

-  →  →  → [Photo Style] → [Like2100(HLG)]



-  The monitor and viewfinder on this camera do not support display of HLG format images.  
With [Monitor] in [HLG View Assist] in the [Custom] ([Monitor / Display (Video)]) menu, you can display the images converted for monitoring on the monitor/viewfinder of this camera. (→ 128)
-  HLG images are shown dark on devices that do not support the HLG format.  
With [HDMI] in [HLG View Assist] in the [Custom] ([Monitor / Display (Video)]) menu, you can set the conversion method for images displayed for monitoring. (→ 128)

### ❖ ISO Sensitivity When [Like2100(HLG)] Is Set

The lower limit of available ISO sensitivities will become [400].

## [HLG View Assist]

At recording or playback of [HLG Photo] and HLG video, this displays images with converted color gamut and brightness on the camera monitor/viewfinder, or outputs these over HDMI.

 ⇒ [  ] ⇒ [  ] ⇒ [HLG View Assist] ⇒ [Monitor] or [HDMI]

<b>[AUTO]*</b>	Converts images before outputting them via HDMI while applying the effect of [MODE2]. This conversion setting works only when the camera is connected to a device that does not support HDR (HLG format).
<b>[MODE1]</b>	Converts with an emphasis on bright areas such as sky. • [MODE1] is displayed on the recording screen.
<b>[MODE2]</b>	Converts with an emphasis on the brightness of a main subject. • [MODE2] is displayed on the recording screen.
<b>[OFF]</b>	Displays without converting color gamut and brightness. • HLG images appear darker on devices that do not support the HLG format.

\* Can only be set while [HDMI] is selected.



# Anamorphic Recording

iA P A S M  S&Q



This camera can record video with a resolution of 4K-A (anamorphic (4:3) video) that is compatible with anamorphic recording with an aspect ratio of 4:3.

Along with the normal 16:9 video aspect ratio, you can select the recording quality suited to anamorphic recording.

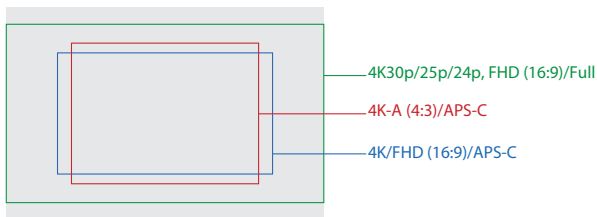

- The above shows some of the recording qualities available when a full-frame lens is attached.

Refer to page 101 for details about 16:9 recording quality.

During anamorphic recording, it is also possible to display desqueezed images and the angle of view when cropping after desqueeze editing. It is also possible to switch to an image stabilizer that suits anamorphic recording.



- This camera is not compatible with desqueeze editing of video recorded with anamorphic recording. Use compatible software.



- Refer to page 70 for information about image stabilizers suited to anamorphic recording.

## [Anamorphic(4:3)]

iA P A S M  S&Q



You can record video with an aspect ratio of 4:3 and 4K-A resolution compatible with anamorphic recording.

### 1 Set the mode dial to [M].

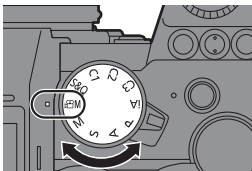

### 2 Set the image quality for [Anamorphic(4:3)].

-  →  →  → [Anamorphic(4:3)]

- [Rec. File Format] changes to [MOV].

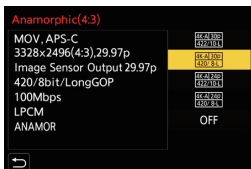

## ❖ Setting Items ([Anamorphic(4:3)])

- Audio format: LPCM (2ch)
- (A) Recording frame rate
- (B) Bit rate (Mbps)
- (C) Video compression format (**HEVC**: H.265/HEVC, **AVC**: H.264/MPEG-4 AVC)

[Switch NTSC/PAL]: [NTSC]					
[Rec Quality]	Resolution	YUV/bit	(A)	(B)	(C)
[4K-A/30p/422/10-L]*	3328×2496	4:2:2/10 bit	29.97p	150	AVC
[4K-A/30p/420/8-L]	3328×2496	4:2:0/8 bit	29.97p	100	AVC
[4K-A/24p/422/10-L]*	3328×2496	4:2:2/10 bit	23.98p	150	AVC
[4K-A/24p/420/8-L]	3328×2496	4:2:0/8 bit	23.98p	100	AVC
[OFF]	—				

[Switch NTSC/PAL]: [PAL]					
[Rec Quality]	Resolution	YUV/bit	(A)	(B)	(C)
[4K-A/50p/420/10-L]*	3328×2496	4:2:0/10 bit	50.00p	200	HEVC
[4K-A/50p/420/8-L]*	3328×2496	4:2:0/8 bit	50.00p	150	AVC
[4K-A/25p/422/10-L]*	3328×2496	4:2:2/10 bit	25.00p	150	AVC
[4K-A/25p/420/8-L]	3328×2496	4:2:0/8 bit	25.00p	100	AVC
[OFF]	—				

\* Recording stops when the continuous recording time exceeds 30 minutes.



- All videos will be recorded using Long GOP to compress the images.
- Use a UHS Speed Class 3 or higher card when recording.

## [Anamorphic Desqueeze Display]

iA P A S M  S&Q



Display the desqueezed images suited to the magnification of the anamorphic lens on this camera.

Using the [Frame Marker], it is also possible to superimpose on display the frame of the angle of view when cropping after desqueeze editing.

### 1 Set the mode dial to [M] or [S&Q].

### 2 Set [Anamorphic Desqueeze Display].

 → [] → [] →  
[Anamorphic Desqueeze Display]

Settings: []([2.0×])/

[]([1.8×])/



[]([1.5×])/

[]([1.33×])/

[]([1.30×])/[OFF]

- Make settings to suit the magnification of the anamorphic lens you are using.

### 3 Set [Frame Marker].

 → [] → [] → [Frame Marker]

- For details, refer to page 117.

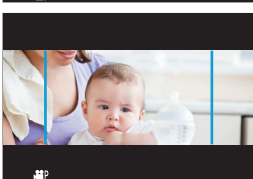
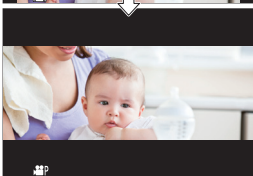

- Images output via HDMI are not desqueezed.

## List of Recording Qualities That Enable Special Videos to be Recorded

**S&Q** : Recording qualities with which you can record Slow & Quick video

**Live Crop** : Recording qualities that enable use of [Live Cropping]

**HLG** : Recording qualities with which you can record HLG video

### ❖ [Rec. File Format]: [MP4]

[Switch NTSC/PAL]	[Rec Quality]	S&Q	Live Crop	HLG
[NTSC]	[4K/10bit/100M/60p]			✓
	[4K/8bit/100M/30p]	✓		
	[4K/10bit/72M/30p]			✓
	[4K/8bit/100M/24p]	✓		
	[4K/10bit/72M/24p]			✓
	[FHD/8bit/28M/60p]	✓	✓	
	[FHD/8bit/20M/30p]	✓	✓	
	[FHD/8bit/24M/24p]	✓		
[PAL]	[4K/10bit/100M/50p]			✓
	[4K/8bit/100M/25p]	✓		
	[4K/10bit/72M/25p]			✓
	[FHD/8bit/28M/50p]	✓	✓	
	[FHD/8bit/20M/25p]	✓	✓	

## ❖ [Rec. File Format]: [MOV]

[Switch NTSC/PAL]	[Rec Quality]	S&Q	Live Crop	HLG
[NTSC]	[4K/60p/420/10-L]			✓
	[4K/60p/420/8-L]			
	[4K/30p/422/10-L]			✓
	[4K/30p/420/8-L]			
	[4K/24p/422/10-L]			✓
	[4K/24p/420/8-L]			
	[FHD/60p/422/10-L]		✓	✓
	[FHD/60p/420/8-L]		✓	
	[FHD/30p/422/10-L]		✓	✓
	[FHD/30p/420/8-L]		✓	
	[FHD/24p/422/10-L]			✓
	[FHD/24p/420/8-L]			
[PAL]	[4K/50p/420/10-L]			✓
	[4K/50p/420/8-L]			
	[4K/25p/422/10-L]			✓
	[4K/25p/420/8-L]			
	[FHD/50p/422/10-L]		✓	✓
	[FHD/50p/420/8-L]		✓	
	[FHD/25p/422/10-L]		✓	✓
[FHD/25p/420/8-L]		✓		

# 11. Connections with External Devices (Video)

## HDMI Devices (HDMI Output)

iA P A S M  S&Q



You can record while outputting the camera images to an external monitor or external recorder connected with an HDMI micro cable.

- HDMI output control differs between during recording and during playback. Refer to the “Owner’s Manual” (PDF format) for information about the settings for HDMI output during playback.

Getting started:

- Turn off the camera and the external monitor/external recorder.

**Connect the camera and an external monitor or external recorder with a commercially available HDMI micro cable.**

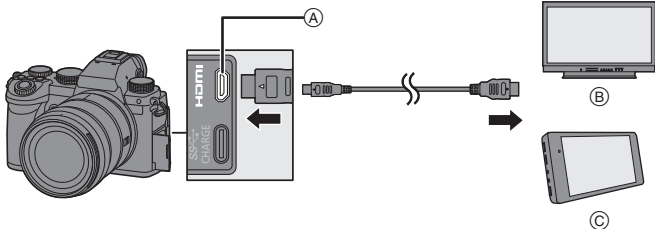

(A) [HDMI] socket (Type D)

(C) External recorder

(B) External monitor

- Check the direction of the terminals and plug in/out straight holding onto the plug. (Inserting at an angle can deform the terminal and cause malfunction.)
- Do not connect the cable to the wrong terminals. This may cause a malfunction.



- Use a “High Speed HDMI micro cable” with the HDMI logo. Cables that do not comply with the HDMI standards will not work. “High Speed HDMI micro cable” (Type D–Type A plug, up to 2 m (6.6 feet) long)

## Images Output via HDMI

The images output via HDMI differ depending on the recording mode.

### ❖ [M]/[S&Q] Mode

Resolution and frame rate output is according to the [Rec Quality] settings in the [Video] ([Image Format]) menu.

The YUV and bit value are output with YUV changed to 4:2:2 as shown at right.

If the connected device is not compatible with the output system, output changes to match the connected device.



Recording to card	HDMI output
4:2:2 10-bit	4:2:2 10-bit
4:2:0 10-bit	4:2:2 10-bit
4:2:0 8-bit	4:2:2 8-bit



- Anamorphic (4:3) video is output with a 16:9 aspect ratio with bands added to the images.



### ❖ [iA]/[P]/[A]/[S]/[M] Mode

While recording video or when [Photo/Video Preview] is set to [  ], output is the same as [  ]/[S&Q] mode.

Output is with a 16:9 aspect ratio during recording standby. Resolution, frame rate, YUV, and bit value output matches the connected device.



- When set to any [Aspect Ratio] other than 16:9, bands are added to the images and they are output with a 16:9 aspect ratio.

### ❖ Notice Regarding HDMI Output



- It may take some time for the output method to change.
- When you use the HDMI output during recording, the image may be displayed with a time lag.
- Beep sounds, AF beep, and electronic shutter sounds are muted during HDMI output.
- When you check the image and audio from the TV connected to the camera, the microphone of the camera may pick up the sound from the speakers of the TV, producing an abnormal sound (audio feedback).  
If this occurs, move the camera away from the TV or lower the volume on the TV.
- Certain setting screens are not output via HDMI.
- There is no output via HDMI while you are recording with the following functions:
  - [6K/4K PHOTO]/[Post-Focus]
- If the temperature of the camera rises, [  ] may be displayed, recording may stop, and some functions may become unavailable temporarily. Wait until the camera cools down.

# [HDMI Rec Output]

iA P A S M  S&Q



Sets HDMI output during recording.

 ⇒ [  ] ⇒ [  ] ⇒ Select [HDMI Rec Output]

<b>[Info Display]</b>	Output the camera information display to an external device connected by HDMI.
<b>[HDMI Recording Control]</b>	<p>Recording start and stop control information is output to an external recorder connected by HDMI.</p> <ul style="list-style-type: none"> <li>• [HDMI Recording Control] can be set when [HDMI Time Code Output] is set to [ON] in [P/M] mode.</li> <li>• Control information is output when pressing the video rec. button or shutter button, even if the video cannot be recorded (such as when there is no card inserted into the camera).</li> <li>• Only compatible external devices can be controlled.</li> </ul>
<b>[4K/60p Bit Mode]/ [4K/50p Bit Mode]</b>	<p>In the [P/M] mode, setting of output bit value for images output over HDMI is possible for 4K/60p or 4K/50p video.</p> <p><b>[4:2:2 10bit]/[4:2:0 8bit]</b></p> <ul style="list-style-type: none"> <li>• The menu name changes according to the [Switch NTSC/PAL] setting.</li> <li>• This works in the [P/M] mode, when set to [Rec Quality] of 4K/60p or 4K/50p, and outputting over HDMI.</li> <li>• When using HDMI output for 4K/60p/4:2:2 10-bit or 4K/50p/4:2:2 10-bit images, video cannot be recorded to a card.</li> <li>• When using HDMI output for HLG video, during HDMI output of 4K/60p/4:2:2 10-bit or 4K/50p/4:2:2 10-bit images, from the [Video] ([Image Quality]) menu, set [Photo Style] to [Like2100(HLG)].</li> </ul>
<b>[Sound Output (HDMI)]</b>	Output audio to an external device connected by HDMI.

## External Microphones (Optional)

iA P A S M  S&Q





With a Stereo Shotgun Microphone (DMW-MS2: optional) or Stereo Microphone (VW-VMS10: optional), you can record higher-quality audio compared to the built-in microphone.

### 1 Set the [Mic Socket] that suits the device to be connected.

-  →  →  → [Mic Socket]

<b>MIC</b> 	<b>[Mic Input (Plug-in Power)]</b>	When connecting an external microphone that requires a power supply from the camera [MIC] socket.
<b>MIC</b>	<b>[Mic Input]</b>	When connecting an external microphone that does not require a power supply from the camera [MIC] socket.
<b>LINE</b>	<b>[Line Input]</b>	When connecting an external audio device for line output.

- The setting will be fixed to [MIC- When using [MIC

### 2 Set the camera on/off switch to [OFF].

### 3 Connect the camera and external microphone.

- If mounting the external microphone on the camera hot shoe (A), remove the hot shoe cover. (→ 91)

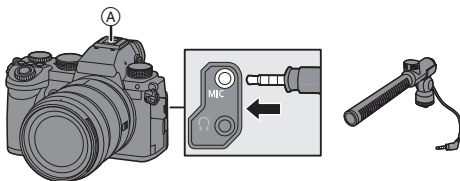

- Do not use the stereo microphone cables with the length of 3 m (9.8 feet) or more.

### ❖ Setting the Sound Pickup Range (DMW-MS2: Optional)

When using the Stereo Shotgun Microphone (DMW-MS2: optional), you can set the microphone sound pickup range.

#### 1 Select [Special Mic.].

- → → → [Special Mic.]



[STEREO]	Picks up sound over a wide area.
[LENS AUTO]	Picks up sound from a range automatically set by the lens angle of view.
[SHOTGUN]	Helps prevent picking up background noise, and records sound from a specific direction.
[S.SHOTGUN]	Narrows the sound pickup range more than with [SHOTGUN].
[MANUAL]	Sets the range manually for sound pickup.

#### 2 (When [MANUAL] is selected)

- Press ◀▶ to adjust the sound pickup range and then press or .

## ❖ Reduction of Wind Noise

This reduces wind noise when an external microphone is connected.

 → [  ] → [  ] → Select [Wind Cut]

Settings: [HIGH]/[STANDARD]/[LOW]/[OFF]



- While the external microphone is connected, [EXT] is displayed on the screen.
- When an external microphone is connected, [Sound Rec Level Disp.] automatically turns [ON], and the recording level is displayed on the screen.
- When the external microphone is attached, do not carry the camera by holding the external microphone. It may become detached.
- If noises are recorded when using the AC adaptor, use the battery.
- Setting [Wind Cut] may alter the usual sound quality.
- For details, refer to the operating instructions for the external microphone.

## XLR Microphone Adaptor (Optional)

iA P A S M  S&Q



By attaching an XLR Microphone Adaptor (DMW-XLR1: optional) to the camera, you can use a commercially available XLR microphone to enable the recording of superior-quality stereo audio.

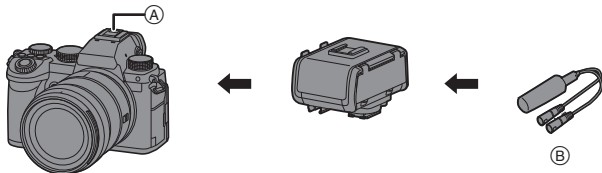

(A) Hot shoe

(B) Commercially available XLR microphone

Getting started:

- Turn off the camera, and remove the hot shoe cover. (→ 91)

Attach the XLR Microphone Adaptor to the hot shoe, and then turn on the camera.

- When the XLR Microphone Adaptor is attached, [XLR Mic Adaptor Setting] automatically turns [ON].

<b>[ON]</b>	Records audio using the XLR microphone.
<b>[OFF]</b>	Records audio using the built-in microphone of the camera.



- While an XLR Microphone Adaptor is attached, [XLR] is displayed on the screen.
- When [XLR Mic Adaptor Setting] is set to [ON], the following settings are fixed:
  - [Sound Rec Level Limiter]: [OFF]
  - [Wind Noise Canceller]: [OFF]
  - [Sound Output]: [REC SOUND]
- [Sound Rec Level Adj.] cannot be used when [XLR Mic Adaptor Setting] is set to [ON].
- When the XLR Microphone Adaptor is attached, [Sound Rec Level Disp.] automatically turns [ON], and the recording level is displayed on the screen.
- When the XLR Microphone Adaptor is attached, do not carry the camera by holding the XLR Microphone Adaptor. It may become detached.
- If noises are recorded when using the AC adaptor, use the battery.
- For details, refer to the operating instructions for the XLR Microphone Adaptor.

## Headphones

iA P A S M S&Q



You can record videos while monitoring their sound by connecting commercially available headphones to the camera.

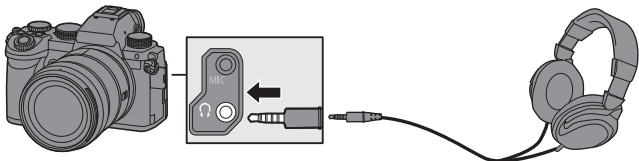

- Do not use the headphone cables with the length of 3 m (9.8 feet) or more.
- When headphones are connected, beep sounds, AF beep, and electronic shutter sounds are muted.

### ❖ Switching the Sound Output Method

→ [ ] → [ ] → Select [Sound Output]

[REALTIME]	Audio without time lag. It may differ from the sound recorded in videos.
[REC SOUND]	Audio to be recorded in videos. Output sound may be delayed from actual sound.



- The setting is fixed to [REC SOUND] in the following cases:
  - During output of audio via HDMI
  - When [Special Mic.] is set to [LENS AUTO], [SHOTGUN], [S.SHOTGUN], or [MANUAL]
  - When using an XLR Microphone Adaptor (DMW-XLR1: optional)

### ❖ Adjusting the Headphone Volume

Connect the headphones and rotate .

: Reduces the volume.

: Increases the volume.

- You can also adjust the volume by touching []/[] on the playback screen.

#### To adjust the volume using the menu:

❶ Select [Headphone Volume].

- → [ ] → [ ] → [Headphone Volume]

❷ Press / to adjust the headphone volume and then press or .

- It can be adjusted in a range of [0] to [LEVEL15].

# 12. Playing Back and Editing of Images

This document gives an overview of recorded image playback and deletion.

Refer to the “Owner’s Manual” (PDF format) for details about recorded image playback and editing.

## Playing Back Images

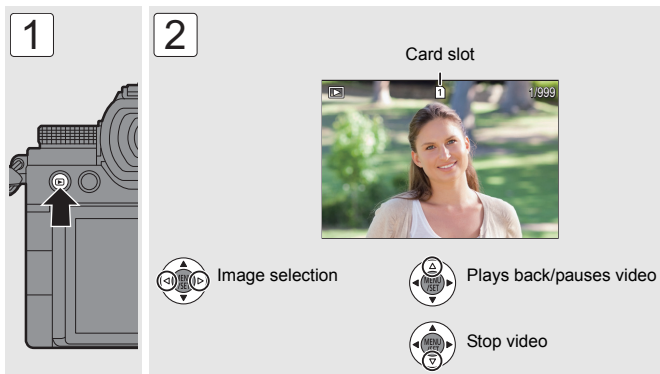

- You can move continuously through images by pressing and holding ◀▶.
- The [👤] video icon is displayed for a video.
- You can create a picture from the video by pressing or while the video is paused.
- Press the shutter button halfway to close.



## ❖ Switching the Card to Display

You can switch the card displayed just by pressing [  ] during playback.

- You can also perform the same operation by pressing the Fn button assigned with [Card Slot Change].

For information about the Fn button, refer to page 147.

## Switching the Display Mode

**Enlarged Display**  
(2×/4×/8×/16×)

**Thumbnail Screen**  
(12-image screen/  
30-image screen)

**Calendar Playback**

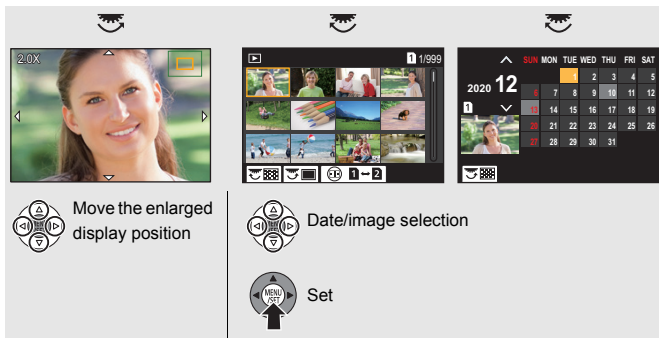



The diagram shows three display modes and their navigation controls:

- Enlarged Display:** Shows a large image of a woman's face with a 2.0X magnification indicator. Navigation is controlled by a directional pad.
- Thumbnail Screen:** Shows a grid of 12 small image thumbnails. Navigation is controlled by a directional pad.
- Calendar Playback:** Shows a calendar for the month of December 2020. Navigation is controlled by a directional pad.





Navigation controls are detailed below:

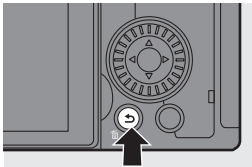

- Move the enlarged display position:** Indicated by a directional pad icon.
- Date/image selection:** Indicated by a directional pad icon.
- Set:** Indicated by a circular button labeled 'MENU/SET' with an upward-pointing arrow.

## Deleting Images

- 1 Press [  ] in playback state.
- 2 Press **▲▼** to select the deletion method and then press  or .



<b>[Delete Single]</b>	Deletes the selected image.
<b>[Delete Multi]</b>	<p>Selecting and deleting multiple images.</p> <ol style="list-style-type: none"> <li>1 Press <b>▲▼◀▶</b> to select the image to delete and then press  or . <ul style="list-style-type: none"> <li>• [  ] is displayed for the selected image.</li> <li>• If you press  or  again, the selection is canceled.</li> </ul> </li> <li>2 Press [DISP.] to delete the selected image.</li> </ol>

-  • All images on the card can be deleted:  
[  ] ⇒ [  ] ⇒ [Delete All Images] (→ 155)

# 13. Camera Customization

This chapter gives an overview of the customization functions for the camera. Refer to the “Owner’s Manual” (PDF format) for details about dial and menu customization.

## Fn Buttons

You can register functions to the Fn (Function) buttons. Additionally, you can register other functions to specialized buttons such as [WB] button, in the same way as with the Fn buttons.

Different functions can be set for both during recording and playback.

- With default settings, [Fn8] to [Fn12] on the joystick cannot be used. When using functions, set the [Joystick Setting] in the [Custom] ([Operation]) menu to [Fn]. (→ 153)

### 1 Select [Fn Button Set].



- Press **MENU/SET** → **[Settings]** → **[Joystick Setting]** → [Fn Button Set] → [Setting in REC mode]/[Setting in PLAY mode]

### 2 Select the button.

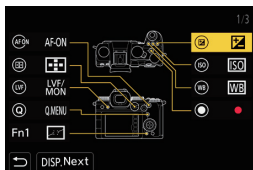
- Press **▲▼** to select the button and then press **MENU/SET** or **[Joystick]**.
- Press [DISP.] to change the page.



### 3 Find the function to register.

- Rotate  to select the sub tab where the function to register is categorized and then press  or .
- Switch the [1] to [3] tabs by pressing [Q].



### 4 Register the function.

- Press  to select a function and then press  or .

 • Refer to the “Owner’s Manual” (PDF format) for functions you can register.

## Custom Mode

C1 C2 C3



You can register the currently set information of the camera.



At the time of purchase, the default settings of the [P] mode menus are registered with all Custom modes.

### 1 Set to recording mode and menu settings of the state you wish to save.

### 2 Select [Save to Custom Mode].

-  → [  ] → [  ] → [Save to Custom Mode]

### 3 Register.

- Select the save-to number and then press  or .
- A confirmation screen will be displayed. Press [DISP.] to change the Custom mode name.



- You cannot register [iA] mode in Custom mode.



- Refer to the "Owner's Manual" (PDF format) for the list of settings that can be registered in Custom mode.



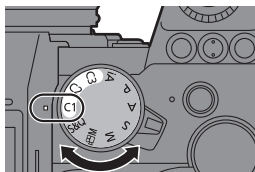

## Using Custom Mode

Set the mode dial to one of [C1] to [C3].

- If [C3], the last-used Custom mode will be called up.





### ❖ [C3] Custom Mode Selection

- Set the mode dial to [C3].
- Press .
  - The Custom mode selection menu appears.
- Press   to select the Custom mode and then press  or .

## [Save/Restore Camera Setting]

Saves the camera's settings information to the card.

Saved settings information can be loaded to the camera, letting you set the same settings on multiple cameras.

 ⇒ [  ] ⇒ [  ] ⇒ Select [Save/Restore Camera Setting]

<b>[Save]</b>	Saves the camera's settings information to the card. <ul style="list-style-type: none"> <li>• If saving new data, then select [New File], and if overwriting an existing file, select that existing file.</li> <li>• When [New File] is selected, a screen to select the file name to save as is displayed.</li> </ul>	
	<b>[OK]</b>	Saves using the file name on the screen.
	<b>[Change the file name]</b>	Changes the file name and saves the file. <ul style="list-style-type: none"> <li>• Available characters: alphabetic characters (upper-case), numerals, up to 8 characters</li> </ul>
<b>[Load]</b>	Loads the settings information on the card and copies it to the camera.	
<b>[Delete]</b>	Deletes settings information on the card.	
<b>[Keep Settings While Format]</b>	When formatting the card, formats the card while keeping camera settings information stored on the card.	



- Only settings information from the same model can be loaded.
- Up to 10 instances of settings information can be saved on one card.



- Refer to the "Owner's Manual" (PDF format) for the list of functions for which saving of settings information is possible.

# 14. List of Menu

This chapter introduces the menu list.













- For information about menu operation methods, refer to page 38.

## List of Menu

: Menu items common to the [Photo] menu and [Video] menu. Their settings are synchronized.

: Described in the "Owner's Manual" (PDF format). (→ 4)











### [Photo] menu

 [Image Quality]	
[Photo Style]	 → 81
[Metering Mode]	 → 71
[Aspect Ratio]	→ 41
[Picture Quality]	→ 41
[Picture Size]	→ 41
[HLG Photo]	→ 89
[High Resolution Mode]	→ 86
[Long Exposure NR]	→ 
[ISO Sensitivity (photo)]	→ 
[Min. Shutter Speed]	→ 
[i.Dynamic Range]	 → 
[Vignetting Comp.]	 → 
[Diffraction Compensation]	 → 
[Filter Settings]	 → 84







### [Focus]

[AF Custom Setting(Photo)]	→ 46
[AF Assist Light]	 → 
[Focus Peaking]	 → 
[1-Area AF Moving Speed]	 → 











### [Flash]

[Flash Mode]	→ 92
[Firing Mode]	→ 
[Flash Adjust.]	→ 
[Flash Synchro]	→ 
[Manual Flash Adjust.]	→ 
[Auto Exposure Comp.]	→ 
[Red-Eye Removal]	→ 
[Wireless]	→ 
[Wireless Channel]	→ 
[Wireless FP]	→ 
[Communication Light]	→ 
[Wireless Setup]	→ 



 **[Photo] menu (Continued)**







 <b>[Others (Photo)]</b>	
[Bracketing]	→ 64
[Silent Mode]	 → 
[Image Stabilizer]	 → 67
[Burst Shot 1 Setting]	→ 55
[Burst Shot 2 Setting]	→ 57
[Shutter Type]	→ 
[Shutter Delay]	→ 

 **[Video] menu**

 <b>[Image Quality]</b>	
[Exposure Mode]	→ 96
[Photo Style]	 → 81
[Metering Mode]	 → 71
[ISO Sensitivity (video)]	→ 111
[Flicker Decrease (Video)]	→ 
[i.Dynamic Range]	 → 
[Vignetting Comp.]	 → 
[Diffraction Compensation]	 → 
[Filter Settings]	 → 84

 <b>[Image Format]</b>	
[Image Area of Video]	→ 100
[Rec Quality]	→ 101
[Slow & Quick Setting]	→ 119
[Switch NTSC/PAL]	→ 99
[Rec. File Format]	→ 100
[Time Code]	→ 104
[Luminance Level]	→ 108
[Anamorphic(4:3)]	→ 130

[Ex. Tele Conv.]	→ 
[Time Lapse/Animation]	→ 61
[Live View Composite]	→ 65
[Self Timer]	→ 63
[6K/4K PHOTO]	→ 57
[Post-Focus]	→ 
[Multiple Exposure]	→ 

 <b>[Focus]</b>	
[AF Custom Setting(Video)]	→ 107
[Continuous AF]	→ 106
[AF Assist Light]	 → 
[Focus Peaking]	 → 
[1-Area AF Moving Speed]	 → 

 <b>[Audio]</b>	
[Sound Rec Level Disp.]	→ 112
[Sound Rec Level Adj.]	→ 112
[Sound Rec Level Limiter]	→ 112
[Wind Noise Canceller/]	→ 112
[Wind Cut]	→ 141
[Mic Socket]	→ 139
[Special Mic.]	→ 140
[XLR Mic Adaptor Setting]	→ 141
[Sound Output]	→ 142
[Headphone Volume]	→ 143



 [Video] menu (Continued)

 [Others (Video)]

[Silent Mode]	 → <a href="#">PDF</a>
---------------	---

[Image Stabilizer]	 → 67
--------------------	--

[Live Cropping]	→ 120
-----------------	-------

 [Custom] menu

 [Image Quality]

[Photo Style Settings]	→ <a href="#">PDF</a>
------------------------	-----------------------

[ISO Increments]	→ <a href="#">PDF</a>
------------------	-----------------------

[Extended ISO]	→ <a href="#">PDF</a>
----------------	-----------------------

[Exposure Offset Adjust.]	→ <a href="#">PDF</a>
---------------------------	-----------------------

[Color Space]	→ <a href="#">PDF</a>
---------------	-----------------------

[Exposure Comp. Reset]	→ <a href="#">PDF</a>
------------------------	-----------------------

[Auto Exposure in P/A/S/M]	→ 94
----------------------------	------

[CreativeVideo Combined Set.]	→ 98
-------------------------------	------

 [Focus/Shutter]

[Focus/Shutter Priority]	→ <a href="#">PDF</a>
--------------------------	-----------------------

[Focus Switching for Vert / Hor]	→ <a href="#">PDF</a>
----------------------------------	-----------------------

[AF/AE Lock Hold]	→ <a href="#">PDF</a>
-------------------	-----------------------

[AF+MF]	→ <a href="#">PDF</a>
---------	-----------------------

[MF Assist]	→ <a href="#">PDF</a>
-------------	-----------------------

[MF Guide]	→ <a href="#">PDF</a>
------------	-----------------------

[Focus Ring Lock]	→ <a href="#">PDF</a>
-------------------	-----------------------

[Show/Hide AF Mode]	→ <a href="#">PDF</a>
---------------------	-----------------------

[Pinpoint AF Setting]	→ <a href="#">PDF</a>
-----------------------	-----------------------

[AF-Point Scope Setting]	→ <a href="#">PDF</a>
--------------------------	-----------------------

[Shutter AF]	→ <a href="#">PDF</a>
--------------	-----------------------

[Half-Press Shutter]	→ <a href="#">PDF</a>
----------------------	-----------------------

[Quick AF]	→ <a href="#">PDF</a>
------------	-----------------------

[Eye Sensor AF]	→ <a href="#">PDF</a>
-----------------	-----------------------

[Looped Focus Frame]	→ <a href="#">PDF</a>
----------------------	-----------------------

[AFC Start Point (225-Area)]	→ 49
------------------------------	------

 [Operation]

[Q.MENU Settings]	→ <a href="#">PDF</a>
-------------------	-----------------------

[Touch Settings]	→ <a href="#">PDF</a>
------------------	-----------------------

[Operation Lock Setup]	→ <a href="#">PDF</a>
------------------------	-----------------------

[Fn Button Set]	→ 147
-----------------	-------

[WB/ISO/Expo. Button]	→ <a href="#">PDF</a>
-----------------------	-----------------------

[ISO Displayed Setting]	→ <a href="#">PDF</a>
-------------------------	-----------------------

[Exposure Comp. Disp. Setting]	→ <a href="#">PDF</a>
--------------------------------	-----------------------

[Dial Set.]	→ <a href="#">PDF</a>
-------------	-----------------------

[Joystick Setting]	→ <a href="#">PDF</a>
--------------------	-----------------------

[Video Rec. Button (Remote)]	→ <a href="#">PDF</a>
------------------------------	-----------------------

 [Monitor / Display (Photo)]

[Auto Review]	→ <a href="#">PDF</a>
---------------	-----------------------

[Constant Preview]	→ <a href="#">PDF</a>
--------------------	-----------------------

[Histogram]	→ <a href="#">PDF</a>
-------------	-----------------------

[Photo Grid Line]	→ <a href="#">PDF</a>
-------------------	-----------------------

[Frame Marker]	→ 117
----------------	-------

[AF Area Display]	→ <a href="#">PDF</a>
-------------------	-----------------------

[Live View Boost]	→ <a href="#">PDF</a>
-------------------	-----------------------

[Night Mode]	→ <a href="#">PDF</a>
--------------	-----------------------

[LVF/Monitor Disp. Set]	→ <a href="#">PDF</a>
-------------------------	-----------------------

[Expo.Meter]	→ <a href="#">PDF</a>
--------------	-----------------------



[Focal Length]	→ <a href="#">PDF</a>
----------------	-----------------------



[Photo/Video Preview]	→ <a href="#">PDF</a>
-----------------------	-----------------------



### [Custom] menu (Continued)

[Photos/Videos Remaining]	→ <a href="#">PDF</a>
[Blinking Highlights]	→ <a href="#">PDF</a>
[Sheer Overlay]	→ <a href="#">PDF</a>
[I.S. Status Scope]	→ <a href="#">PDF</a>
[Level Gauge]	→ <a href="#">PDF</a>
[Luminance Spot Meter]	→ 115
[Framing Outline]	→ <a href="#">PDF</a>
[Show/Hide Monitor Layout]	→ 36
 <b>[Monitor / Display (Video)]</b>	
[V-Log View Assist]	→ 125
[HLG View Assist]	→ 128
[Anamorphic Desqueeze Display]	→ 132



### [Setup] menu

 <b>[Card/File]</b>	
[Card Format]	→ 32
[Double Card Slot Function]	→ 42
[Folder / File Settings]	→ 43
[File Number Reset]	→ <a href="#">PDF</a>
[Copyright Information]	→ <a href="#">PDF</a>
 <b>[Monitor / Display]</b>	
[Power Save Mode]	→ <a href="#">PDF</a>
[Monitor Frame Rate]	→ <a href="#">PDF</a>
[LVF Frame Rate]	→ <a href="#">PDF</a>
[Monitor Settings]/[Viewfinder]	→ <a href="#">PDF</a>
[Monitor Backlight]/ [LVF Luminance]	→ <a href="#">PDF</a>
[Eye Sensor]	→ <a href="#">PDF</a>
[Level Gauge Adjust.]	→ <a href="#">PDF</a>



[Monochrome Live View]	→ <a href="#">PDF</a>
[Center Marker]	→ <a href="#">PDF</a>
[Zebra Pattern]	→ 116
[Waveform Monitor]	→ 113
[Red REC Frame Indicator]	→ <a href="#">PDF</a>
 <b>[IN/OUT]</b>	
[HDMI Rec Output]	→ 138
 <b>[Lens / Others]</b>	
[Lens Focus Resume]	→ <a href="#">PDF</a>
[Lens Fn Button Setting]	→ <a href="#">PDF</a>
[Focus Ring Control]	→ <a href="#">PDF</a>

 <b>[IN/OUT]</b>	
[Beep]	→ <a href="#">PDF</a>
[Headphone Volume]	→ 143
[Wi-Fi]	→ <a href="#">PDF</a>
[Bluetooth]	→ 157
[USB]	→ <a href="#">PDF</a>
[Battery Use Priority]	→ <a href="#">PDF</a>
[TV Connection]	→ <a href="#">PDF</a>
[Wireless Connection Light]	→ <a href="#">PDF</a>
 <b>[Setting]</b>	
[Save to Custom Mode]	→ 148
[Load Custom Mode]	→ <a href="#">PDF</a>
[Custom Mode Settings]	→ <a href="#">PDF</a>
[Save/Restore Camera Setting]	→ 150
[Reset]	→ 38













 [Setup] menu (Continued)





 [Others]	
[Clock Set]	→ 34
[Time Zone]	→ 34
[Pixel Refresh]	→ 

 [My Menu]



 [Page 1]
 [Page 2]
 [Page 3]

 [Playback] menu

 [Playback Mode]	
[Playback Mode]	→ 
[Slide Show]	→ 
[Rotate Disp.]	→ 
[Picture Sort]	→ 
[Magnify from AF Point]	→ 
[LUT View Assist (Monitor)]	→ 125
[HLG View Assist (Monitor)]	→ 128
[Anamorphic Desqueeze Display]	→ 132
 [Process Image]	
[RAW Processing]	→ 
[6K/4K PHOTO Bulk Saving]	→ 
[6K/4K PHOTO Noise Reduction]	→ 
[Time Lapse Video]	→ 
[Stop Motion Video]	→ 

[Sensor Cleaning]	→ 
[Language]	→ 
[Firmware Version]	→ 
[Online Manual]	→ 4
[Approved Regulations]	→ 





 [Edit My Menu]

[Add]	→ 
[Sorting]	→ 
[Delete]	→ 
[Display from My Menu]	→ 



 [Add/Delete Info.]

[Protect]	→ 
[Rating]	→ 

 [Edit Image]

[Resize]	→ 
[Rotate]	→ 
[Video Divide]	→ 
[Copy]	→ 

 [Others]

[Delete Confirmation]	→ 
[Delete All Images]	→ 



# 15. Wi-Fi/Bluetooth

This document gives an overview of remote operations from a smartphone. Refer to the “Owner’s Manual” (PDF format) for details about camera Wi-Fi®/Bluetooth® functions.

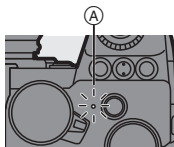
## ❖ Checking Operation of the Wi-Fi and Bluetooth Functions



(A) Wireless connection light

Light (blue)	Monitor	Operation
Lit		The Wi-Fi function is set to on, or there is a connection.
		The Bluetooth function is set to on, or there is a connection.
Blinking		When image data is sent using a camera operation.

## Connecting to a Smartphone

### Installing “LUMIX Sync”

“LUMIX Sync” is an application for smartphones provided by Panasonic.

#### Supported OS

Android™: Android 5 or higher

iOS: iOS 11 or higher

- 1 **Connect the smartphone to a network.**
- 2 **(Android) Select “Google Play™ Store”.**  
**(iOS) Select “App Store”.**

**3 Enter “LUMIX” or “panasonic lumix sync” into the search box.**

**4 Select and install the “Panasonic LUMIX Sync”** .



- Use the latest version.
- Supported OSs are current as of September 2020 and are subject to change.
- Read the [Help] in the “LUMIX Sync” menu for further details on how to operate.
- The app may not operate correctly depending on your smartphone.

For information on the “LUMIX Sync”, refer to the following support site:

<https://panasonic.jp/support/global/cs/dsc/>  
(English only)



## Connecting to a Smartphone (Bluetooth Connection)

Follow a simple connection setup procedure (pairing) to connect to a smartphone that supports Bluetooth Low Energy.

When pairing is set up, the camera also automatically connects to the smartphone via Wi-Fi.

- For the first-time connection, pairing settings are required.

For information about connecting for the second and subsequent times, refer to page 159.



### • Supported smartphones

Android™: Android 5 or higher with Bluetooth 4.0 or higher  
(excluding those that do not support Bluetooth Low Energy)

iOS: iOS 11 or higher

- Turn on the Bluetooth function on the smartphone beforehand.

## 1 On the smartphone, start up “LUMIX Sync”.

- A message regarding device (camera) registration is displayed. Select [Next].
- If you have closed the message, select [?], then register the camera using [Camera registration (pairing)].



## 2 Check the content in the displayed guide and select [Next] until the screen to register the camera is displayed.



Operating the camera in accordance with the smartphone guide.

## 3 Set the camera to Bluetooth pairing standby state.

- [MENU/SET] ⇒ [Wrench] ⇒ [Bluetooth] ⇒ [Bluetooth] ⇒ [SET] ⇒ [Pairing]
- The camera enters pairing standby state and the device name (A) is displayed.



## 4 On the smartphone, select the camera's device name.

- (iOS devices) When a message to confirm the change of destination is displayed, select [Join].

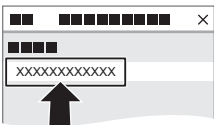

## 5 When a message indicating that device registration is complete, select [OK].

- A Bluetooth connection between the camera and the smartphone will be made.

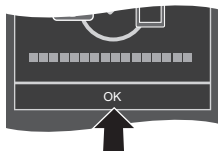

## ❖ End Bluetooth Connection

**MENU/SET** → [ ] → [ ] → [Bluetooth] → [Bluetooth] → Select [OFF]

## ❖ Connecting to a Paired Smartphone

- 1 Enable the Bluetooth function of the camera.
  - **MENU/SET** → [ ] → [ ] → [Bluetooth] → [Bluetooth] → [ON]
- 2 On the smartphone, start up "LUMIX Sync".
  - If a message is displayed indicating that the smartphone is searching for cameras, close the message.
- 3 Select [ ].
- 4 Select [Bluetooth Setup].
- 5 Turn Bluetooth ON.
- 6 From [Camera registered] items, select the camera's device name.

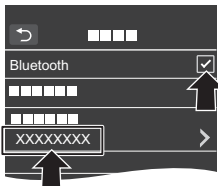
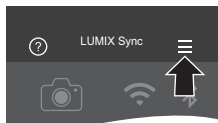

# Operating the Camera with a Smartphone

When you start up “LUMIX Sync”, the home screen is displayed.

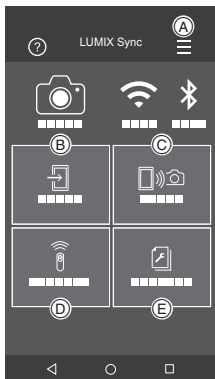

	<b>App settings (→ 159)</b> This allows connection settings, camera power operations, and displays Help.
	<b>[Import images] (→ 161)</b>
	<b>[Remote shooting] (→ 160)</b>
	<b>[Shutter Remote Control] (→ 161)</b>
	<b>[Camera settings copy]</b> This saves the camera's settings information to the smartphone. Saved settings information can be loaded to the camera, letting you set the same settings on multiple cameras.

## [Remote shooting]

You can use the smartphone to record from a remote location while viewing the live view images from the camera.

### 1 Select ([Remote shooting]) in the home screen.

- (iOS devices) When a message to confirm the change of destination is displayed, select [Join].

### 2 Start recording.

	Takes a picture
	Starts/ends the video recording

- The recorded image is saved on the camera.

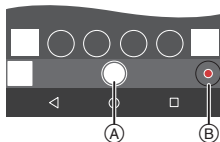





## [Shutter Remote Control]

You can use the smartphone as a remote control for the shutter.

- 1 Select [  ] ([Shutter Remote Control]) in the home screen.
- 2 Start recording.

	Starts/ends the video recording
	Takes a picture



- Slide [  ] in the direction of [LOCK] to record with the shutter button locked in a fully-pressed state.

## [Import images]

Transfer an image stored on the card to the smartphone connected via Wi-Fi.

- 1 Select [  ] ([Import images]) in the home screen.



- (iOS devices) When a message to confirm the change of destination is displayed, select [Join].

- 2 Select the image to transfer.

- You can switch the card displayed by touching .



- 3 Transfer the image.

- Select [  ].
- If the image is a video, you can play it back by touching [  ] at the center of the screen.



# 16. Connecting to Other Devices

You can connect the camera to a TV or PC to play back or copy images. Connect using either the [HDMI] socket or the USB port on the camera.

- Check the direction of the terminals and plug in/out straight holding onto the plug.  
(Inserting these at an angle may cause deformation or malfunction)
- Do not connect the cable to the wrong terminals. This may cause a malfunction.

## [HDMI] socket

Getting started:

- Turn off the camera and TV.

Connect the camera and TV with a commercially available HDMI micro cable.

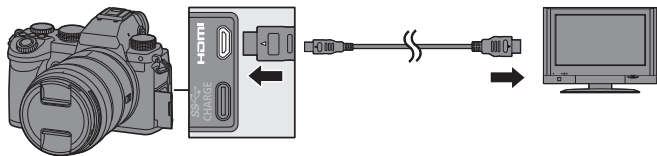

- Use a "High Speed HDMI micro cable" with the HDMI logo.  
Cables that do not comply with the HDMI standards will not work.  
"High Speed HDMI micro cable" (Type D–Type A plug, up to 2 m (6.6 feet) long)

## USB port

Getting started:

- Turn on the camera and the device to be connected.

Use a USB connection cable to connect the camera to a PC, recorder, or printer.

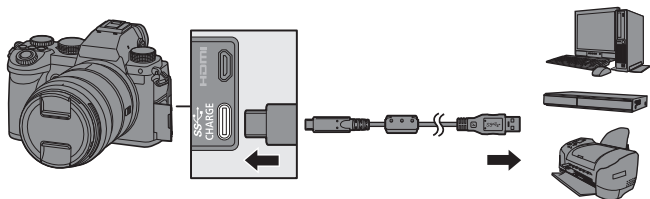

- Do not use any other USB connection cables except the supplied one.
- When the confirmation screen appears, select the connection destination.

<b>[PC(Storage)]</b>	Select this setting to import images to a connected PC (→ 164) or to store on a recorder.
<b>[PC(Tether)]</b>	Select this setting to control the camera from a PC installed with "LUMIX Tether".
<b>[PictBridge(PTP)]</b>	Select this setting when connecting to a printer that supports PictBridge.

## Importing Images to a PC

After connecting to the PC, you can copy the recorded images by dragging files and folders on this camera to the PC.

- Windows: A drive ("LUMIX") is displayed in [This PC].
- Mac: A drive ("LUMIX") is displayed on the desktop.



- Windows: When importing using "PHOTOfunSTUDIO", refer to page 165.
- Mac: Supported by "Final Cut Pro X".  
For details on "Final Cut Pro X", please contact Apple Inc.
- The camera can be connected to a PC running any of the following OSs which can detect mass storage devices.

### Supported OS

Windows: Windows 10/Windows 8.1/Windows 8

Mac: OS X v10.5 to v10.11, macOS 10.12 to macOS 10.15

## ❖ Folder Structure Inside Card

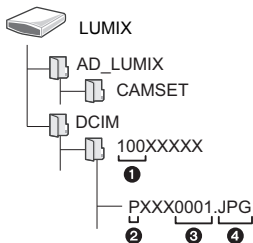

CAMSET: The camera's setup information  
Images

DCIM:

❶ Folder number

❷ Color space

❸ File number

❹ JPG:

RW2:

HSP:

MP4:

MOV:

P: sRGB

\_ : AdobeRGB

JPEG format pictures

RAW format pictures

HLG format pictures

MP4 videos,  
6K/4K burst files

MOV videos

# Installing Software



- To download the software, your PC needs to be able to connect to the internet.
- Supported OSs are current as of September 2020 and are subject to change.

## ❖ PHOTOfunSTUDIO 10.1 PE

This software allows you to manage your images. For example, it allows you to import pictures and videos to your PC and then sort them by recording date, model name.

You can also perform operations such as writing images to a DVD, correcting images, and editing videos.

Check the following site and then download and install the software:

[https://panasonic.jp/support/global/cs/soft/download/d\\_pfs101pe.html](https://panasonic.jp/support/global/cs/soft/download/d_pfs101pe.html)  
(English only)

Download expiration: September 2025

### Operating environment

Supported OS	Windows 10 (32-bit/64-bit) Windows 8.1 (32-bit/64-bit) • For 4K videos, videos in 10-bit format, and 6K/4K photos, a 64-bit version of the Windows 10/Windows 8.1 OS is required.
CPU	Pentium® 4 (2.8 GHz or higher)
Display	1024×768 or higher (1920×1080 or higher is recommended)
Installed memory	1 GB or more for 32-bit, 2 GB or more for 64-bit
Free hard disk space	450 MB or more for installing the software

- A high-performance PC environment is required to use the playback and editing functions for 4K videos and videos in 10-bit format or the picture cropping function for 6K/4K photos.  
For details, refer to the operating instructions for “PHOTOfunSTUDIO”.
- “PHOTOfunSTUDIO” is not available for Mac.

## ❖ SILKYPIX Developer Studio SE

This software processes and edits RAW images.

Edited images can be saved in a format (JPEG, TIFF, etc.) that can be displayed on a PC.

Check the following site and then download and install the software:

<http://www.isl.co.jp/SILKYPIX/english/p/>

### Operating environment

Supported OS	Windows	Windows 10, Windows 8.1 (64-bit recommended)
	Mac	OS X v10.10 to v10.11 macOS 10.12 to macOS 10.15

- For more information such as how to use “SILKYPIX Developer Studio”, refer to the Help or the Ichikawa Soft Laboratory’s support site.

## ❖ 30-Day Full Trial Version of “LoiLoScope”

This software allows you to easily edit videos.

Check the following site and then download and install the software:

<http://loilo.tv/product/20>

### Operating environment

Supported OS	Windows	Windows 10, Windows 8.1, Windows 8
--------------	---------	------------------------------------

- You can download a trial version that can be used for free for 30 days.
- For more information on how to use “LoiLoScope”, refer to the “LoiLoScope” manual available for download at the site.
- “LoiLoScope” is not available for Mac.

## ❖ “LUMIX Tether”

If you install the “LUMIX Tether” camera control software on your PC, you can connect the camera to the PC via USB and then control the camera from the PC and record while checking the live view on the PC screen (tethered recording).

Check the following site and then download and install the software:

**[https://panasonic.jp/support/global/cs/soft/download/d\\_lumixtether.html](https://panasonic.jp/support/global/cs/soft/download/d_lumixtether.html)**  
(English only)

### Operating environment

Supported OS	Windows	Windows 10 (64-bit)
	Mac	OS X v10.11, macOS 10.12 to macOS 10.15
Interface	USB port (SuperSpeed USB (USB 3.0))	

# 17. Materials

## Digital Camera Accessory System

(Product numbers correct as of September 2020.)

Product name	Model number
Battery Pack	DMW-BLK22
Battery Charger <sup>*1</sup>	DMW-BTC15
AC Adaptor <sup>*2</sup>	DMW-AC10
DC Coupler <sup>*2</sup>	DMW-DCC17
Flash	DMW-FL580L, DMW-FL360L, DMW-FL200L
LED Video Light	VW-LED1
Stereo Shotgun Microphone	DMW-MS2
Stereo Microphone	VW-VMS10
XLR Microphone Adaptor	DMW-XLR1
Shutter Remote Control	DMW-RS2
Tripod Grip	DMW-SHGR1
Battery Grip	DMW-BGS5
Shoulder Strap	DMW-SSTG9

\*1 Supplied with an AC adaptor, an AC cable and a USB connection cable.  
(Charging time: approx. 175 min)

\*2 The AC Adaptor (optional) can only be used with the designated Panasonic DC Coupler (optional). The AC Adaptor (optional) cannot be used by itself.

- Some optional accessories may not be available in some countries.
- For lens-related optional accessories such as compatible lenses and filters, refer to our catalogs/web pages, etc.
- Refer to the "Owner's Manual" (PDF format) for details about using this camera when using optional accessories.
- To order optional accessories please visit <http://shop.panasonic.com> or your local Photo Specialty Dealer.



# Monitor/Viewfinder Displays



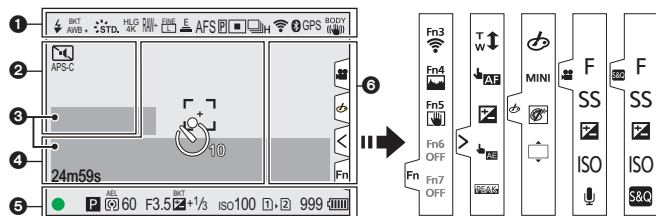

- The screen is an monitor display example of when [LVF/Monitor Disp. Set] is set to .

## Recording Screen

- Refer to the “Owner’s Manual” (PDF format) for details on indications during playback.



1

	Flash mode (→ 92)
	Flash Synchro (→ 151)/ Wireless (→ 151)
AWBc AWBw	
	White balance (→ 79)
BKT AWB	White Balance Bracket, White Balance Bracket (Color Temperature) (→ 64)
AWB + AWB -	Adjusting the white balance
	Photo Style (→ 81)

*EXPS	Filter setting (→ 84)/ Filter effect adjustment (→ 84)
HLG 4K	HLG photo (→ 89)
RAW+ FINE L	Picture quality (→ 41)/ Picture size (→ 41)
STD M	Extended Tele Conversion (→ 152)
EXM	Recording file format (→ 100)/ Recording quality (→ 101)
MP4 8bit LHD 60P	Slow & Quick setting (→ 119)
30fps	
E	Electronic shutter

AFS AFC MF	Focus mode (→ 44, 52)
BKT AFS	Focus Bracket (→ 64)
AFL	AF Lock (→ 76)
P	Focus Peaking (→ 151)
	AF mode (→ 47)
	Drive mode (→ 55)
	Post-Focus (→ 152)
	Connected to Wi-Fi (→ 156)
	Connected to Bluetooth (→ 156)
GPS	Location logging
BODY 	Image stabilizer (→ 67)
	Camera shake alert (→ 68)





## ②

PRE	Pre-Burst recording (→ 59)
	Multiple exposures (→ 152)
	Silent mode (→ 152)
APS-C PIXEL PIXEL	Image area of video (→ 100)
2.0x 	Anamorphic Desqueeze Display (→ 132)
	High Resolution mode (→ 86)
LC	Live View Composite recording (→ 65)
	Overlay indication (→ 154)
MON LUT HDMI PLG	LUT View Assist (→ 125)
MON MODE HDMI HLG	HLG View Assist (→ 128)







## ③











TC 00:00:00:00	Time code (→ 104)
INT. EXT. XLR	Built-in microphone, External microphone (→ 112, 139)/ XLR microphone adaptor setting (→ 141)
LMT ON LMT OFF	Sound recording level limiter (→ 112)
	Mute (→ 112)
	Sound recording level (→ 112)
	Exposure meter (→ 153)

4

	Histogram (→ 153)
	AF area (→ 51)
+	Spot metering target (→ 71)
+	Center marker (→ 154)
	Self-timer (→ 63)
	Operation lock
24m59s	Elapsed recording time (→ 93)
	Image being sent

5

	Focus (turns green) (→ 40)/ Recording state (turns red) (→ 93)
	Focus (in low light AF situations) (→ 45)
	Focus (Starlight AF) (→ 45)
	Flash adjustment (→ 151)
	Recording mode (→ 39)
	Program Shift (→ 72)
	Metering mode (→ 71)
AEL	AE Lock (→ 76)
60	Shutter speed (→ 40)
F3.5	Aperture value (→ 40)















	Aperture Bracket (→ 64)
	Exposure compensation value (→ 75)
	Exposure Bracket (→ 64)
	Manual Exposure Assist
ISO100	ISO sensitivity (→ 77)
	Card access indication (turns red) (→ 93)
	Card slot (→ 32)/Double card slot function (→ 42)
	No card
	Card full
999	Number of still images that can be taken
r20	Number of pictures that can be taken continuously
24m59s	Video recording time
	Battery indication (→ 31)
	Power supply (→ 31)
	Battery Grip



6

	Temperature rise warning icon (→ 176)
---	---------------------------------------

## Touch Tab

- Set [Touch Tab] to [ON] in [Touch Settings]. (→ 153)

Fn	
	Fn button (→ 147)
◀	
	Touch Zoom
	Touch AF, Touch Shutter
	Exposure compensation (→ 75)
	Touch AE
	Focus Peaking (→ 151)
 /  /  (→ 97)	
	Type of defocus ([Miniature Effect])
	One Point Color
	Light source position ([Sunshine])
	Filter effect adjustment (→ 84)
	Filter on/off
MINI	Filter setting (→ 84)
F	Aperture value (→ 97)
SS	Shutter speed (→ 97)

	Exposure compensation (→ 97)
ISO	ISO sensitivity (→ 97)
	Sound recording level adjustment (→ 97)
	Slow & Quick setting (→ 97)

## ❖ Control Panel



1

	Recording mode (→ 39)
1/60	Shutter speed (→ 40)
F3.5	Aperture value (→ 40)
	Battery indication (→ 31)
	Power supply (→ 31)
	Battery indication (battery grip)
	Wi-Fi/Bluetooth connection state (→ 156)









2

	ISO sensitivity (→ 77)
	Exposure compensation value (→ 75)/ Manual Exposure Assist
	Flash setting/ Flash mode (→ 92)

3

	Drive mode (→ 55)/ Post-Focus (→ 152)/ High Resolution mode (→ 86)
AFS	Focus mode (→ 44, 52)
	AF mode (→ 47)
FINE	Picture quality (→ 41)
APS-C 	Image area of video (→ 100)/Recording file format (→ 100)/Recording quality (→ 101)
3:2 	Picture size/Aspect ratio (→ 41)
30fps	Slow & Quick setting (→ 119)
HLG OFF	HLG photo (→ 89)
	Fn button settings (→ 147)

4

 STD.	Photo Style (→ 81)
AWB	White balance (→ 79)
 OFF	i.Dynamic Range (→ 151)
	Metering mode (→ 71)
 	Card slot (→ 32)/Double card slot function (→ 42)
 	No card
 	Card full
999	Number of still images that can be taken
r20	Number of pictures that can be taken continuously
R24m59s	Video recording time
----	No card

## Message Displays

Meanings of main messages displayed on the camera screen, and response methods.



- Please also refer to the "Owner's Manual" (PDF format), which describes more detailed information.

### **[Memory Card Error]/[Format this card?]**

- It is a format that cannot be used with the camera.  
Either insert another card, or back up any necessary data before formatting. (→ 32)

### **[Memory Card Error]/[This memory card cannot be used]**

- Use a card compatible with the camera. (→ 31)

### **[Read Error]/[Write Error]/[Please check the card]**

- Failure to read or write data.  
Turn off the camera, reinsert the card, and then turn it on again.
- The card may be broken.
- Insert a different card.

### **[The lens is not attached properly. Do not push lens release button while lens is attached.]**

- Remove the lens once, and then attach it again without pressing the lens release button. (→ 32)  
Turn on the camera again, and if it is still displaying, contact the dealer.

### **[This battery cannot be used]**

- Use a genuine Panasonic battery.  
If this message is displayed even when a genuine Panasonic battery is used, contact the dealer.
- If the terminal of the battery is dirty, remove the dirt and dust from the terminal.

### **[Please turn camera off and then on again]/[System Error]**

- Turn off and on the camera.  
If the message is displayed even when doing this several times, contact the dealer.

## Troubleshooting

First, try out the following procedures (→ 176 to 177).

**If the problem is not resolved, it may be improved by selecting [Reset] (→ 38) on the [Setup] ([Setting]) menu.**



- Please also refer to the “Owner’s Manual” (PDF format), which describes more detailed information.

### The battery becomes flat too quickly.

- When [6K/4K Pre-Burst] or [Pre-Burst Recording] is set, the battery drains faster. Set these settings only when recording.
- When connected to Wi-Fi, the battery drains quickly. Turn the camera off frequently such as by using [Power Save Mode] (→ 154).

### Recording stops before finishing.

#### Cannot record.

#### Cannot use some functions.

- In high ambient temperatures or if the camera is used for continuous recording, the temperature of the camera will rise. To protect the camera against a rise in temperature, after [  ] is displayed, recording will be stopped, and the following functions will not be available for a time. Wait until the camera cools down.
  - [6K/4K PHOTO]
  - [Post-Focus]
  - Video recording
  - [AF-Point Scope]
  - HDMI output
  - Power supply

### The subject is not focused properly.

- Confirm the following details:
  - Is the subject outside of the focus range?
  - Is [Shutter AF] set to [OFF]?
  - Is [Focus/Shutter Priority] set to [RELEASE]?
  - Is AF Lock set where it is not appropriate?



### **Striping or flicker may appear under lighting such as fluorescent or LED lighting.**

- This is characteristic of CMOS sensors which serve as the camera's pickup sensors. This is not a malfunction.
- When using the electronic shutter, lowering the shutter speed may reduce the effect of the horizontal stripes.
- If flicker or horizontal stripes are noticeable when recording video, this can be mitigated by fixing the shutter speed.  
Either set [Flicker Decrease (Video)], or fix the shutter speed with the [M]/[S&Q] mode (→ 96).

### **The brightness or coloring of the recorded image is different from the actual scene.**

- When recording under lighting such as fluorescent or LED lighting, increasing the shutter speed may introduce slight changes to brightness or coloring. These are a result of the characteristics of the light source and do not indicate a malfunction.
- When recording subjects in extremely bright locations or recording under lighting such as fluorescent, LED, mercury, or sodium lighting, the coloring or screen brightness may change or horizontal striping may appear on the screen.

### **The flash does not fire.**

- The flash does not fire when using the following functions:
  - Video recording/[6K/4K PHOTO]/[Post-Focus]
  - [ELEC.]/[Silent Mode]/[High Resolution Mode]
  - [Filter Settings]

### **When the camera is shaken, a rattling sound is heard from the camera.**

- The sound is caused by the in-body stabilizer. This is not a malfunction.

### **There is rattling noise from the lens when the camera is turned on or off, or when the camera is swung. There is a sound from the lens when recording.**

- This is the sound of the lens moving and aperture operation. It is not a malfunction.

## Specifications



- Please also refer to the “Owner’s Manual” (PDF format), which lists more items.

The specifications are subject to change for performance enhancement.

### Digital camera body (DC-S5):

Information for your safety

<b>Power source:</b>	8.4 V===
<b>Power consumption:</b>	4.3 W (when recording with the monitor), 3.2 W (when playing back with the monitor) [When using the interchangeable lens (S-R2060)]

Type	
<b>Type</b>	Digital Single Lens Mirrorless camera
<b>Recording media</b>	SD memory card / SDHC memory card / SDXC memory card
<b>Lens mount</b>	Leica Camera AG L-Mount
Image sensor	
<b>Image sensor</b>	35 mm full-frame (35.6 mm×23.8 mm) CMOS sensor, a total of 25,280,000 pixels, primary color filter
<b>Effective number of pixels of the camera</b>	24,200,000 pixels
Recording format for still images	
<b>File format for still images</b>	JPEG (DCF compliant, Exif 2.31 compliant) / RAW / HLG photo (CTA-2072 compliant)
<b>Picture size (pixels)</b>	<b>When the aspect ratio setting is [3:2]</b> [L]: 6000×4000 (3984×2656)* [M]: 4272×2848 (2880×1920)* [S]: 3024×2016 (2064×1376)* * Figures in parentheses are for APS-C lenses

Recording format for video	
<b>Video format</b>	MP4 (H.264/MPEG-4 AVC, H.265/HEVC) / MOV (H.264/MPEG-4 AVC, H.265/HEVC)
<b>Audio format</b>	MP4      AAC (2ch)
	MOV      LPCM (2ch, 48 kHz/16-bit)
<b>Image quality for video</b>	Refer to page 101 and 131 in this document for information about resolution, recording frame rate, and other elements of recording quality.
Viewfinder	
<b>System</b>	Aspect ratio 4:3, 0.39 inches, approx. 2,360,000 dots, organic EL (OLED) live view viewfinder
<b>Field of view ratio</b>	Approx. 100 %
<b>Magnification</b>	Approx. $0.74\times$ ( $-1.0\text{ m}^{-1}$ 50 mm at infinity, with aspect ratio set to [3:2])
Monitor	
<b>System</b>	Aspect ratio 3:2, 3.0 inches, approx. 1,840,000 dots monitor, capacitive touch screen
<b>Field of view ratio</b>	Approx. 100 %
Focus	
<b>AF type</b>	TTL type based on image detection (Contrast AF)
Exposure control	
<b>Light metering system, Light metering mode</b>	1728-zone metering, multi-metering / center-weighted metering / spot metering / highlight-weighted metering
<b>Metering range</b>	EV 0 to EV 18 (F2.0 lens, ISO100 conversion)
<b>ISO sensitivity (standard output sensitivity)</b>	AUTO / 100 to 51200, When [Extended ISO] is set: AUTO / 50 to 204800, 1/3 EV steps
Image stabilizer	
<b>Image stabilizer type</b>	Compliant with Image sensor shift type, 5-axis stabilizer, Dual I.S.2

Shutter	
<b>Format</b>	Focal-plane shutter
<b>Shutter speed</b>	<p>Pictures:</p> <p>Mechanical shutter: Bulb (max. approx. 30 minutes), 60 seconds to 1/8000 of a second</p> <p>Electronic front curtain: Bulb (max. approx. 30 minutes), 60 seconds to 1/2000 of a second</p> <p>Electronic shutter: Bulb (max. approx. 60 seconds), 60 seconds to 1/8000 of a second</p> <p>Videos:</p> <p>1/25* of a second to 1/16000 of a second</p> <p>* When [Exposure Mode] is set to [M] in Creative Video mode and focus mode is set to [MF], this can be set up to 1/2</p>
<b>Flash synchronization speed</b>	<p>Equal to or smaller than 1/250 of a second*</p> <p>* The guide number decreases at 1/250 of a second, only during [S]/[M] modes</p>
Zoom	
<b>Extended Tele Conversion (Picture)</b>	<p>Max. 2×* (when a picture size of [S] is selected.)</p> <p>* Max. 1.9× when using APS-C lenses</p>
Interface	
<b>USB</b>	USB Type-C™, SuperSpeed USB3.1 GEN1
<b>[HDMI]</b>	micro HDMI Type D
<b>[REMOTE]</b>	∅ 2.5 mm jack
<b>[MIC]</b>	∅ 3.5 mm stereo mini jack
<b>Headphones</b>	∅ 3.5 mm stereo mini jack

External dimensions / Mass	
<b>External dimensions</b>	Approx. 132.6 mm (W)×97.1 mm (H)×81.9 mm (D) (5.22" (W)×3.82" (H)×3.22" (D)) (excluding the projecting parts)
<b>Mass (Weight)</b>	Approx. 714 g/1.58 lb (camera body, with battery and one card) Approx. 630 g/1.39 lb (only camera body)
Operating environment	
<b>Recommended operating temperature</b>	0 °C to 40 °C (32 °F to 104 °F)
<b>Permissible relative humidity</b>	10 %RH to 80 %RH
Wi-Fi	
<b>Compliance standard</b>	IEEE 802.11a/b/g/n/ac (standard wireless LAN protocol)
<b>Frequency range used (central frequency)</b>	2412 MHz to 2462 MHz (1 to 11ch) 5180 MHz to 5320 MHz (36/40/44/48/52/56/60/64ch) 5500 MHz to 5720 MHz (100/104/108/112/116/120/124/128/132/136/140/144ch) 5745 MHz to 5825 MHz (149/153/157/161/165ch)
<b>Encryption method</b>	Wi-Fi compliant WPA™ / WPA2™
<b>Access method</b>	Infrastructure mode
Bluetooth	
<b>Compliance standard</b>	Bluetooth v4.2, Bluetooth Low Energy (BLE)
<b>Frequency range used (central frequency)</b>	2402 MHz to 2480 MHz

**Battery charger (Panasonic DVLC1005Z):**

Information for your safety

<b>Input:</b>	9.0 V $\text{---}$	3.0 A	5.0 V $\text{---}$	1.8 A
<b>Output:</b>	8.4 V $\text{---}$	1.2 A	8.4 V $\text{---}$	0.85 A
<b>Operating temperature:</b>	0 °C to 40 °C (32 °F to 104 °F)			

**AC adaptor (Panasonic VSK0815F):**

Information for your safety

<b>Input:</b>	110 V–240 V $\sim$	50/60 Hz	0.25 A
<b>Output:</b>	5.0 V $\text{---}$	1.8 A	
<b>Operating temperature:</b>	0 °C to 40 °C (32 °F to 104 °F)		

**Battery pack (lithium-ion) (Panasonic DMW-BLK22):**

Information for your safety

<b>Voltage/capacity:</b>	7.2 V / 2200 mAh
--------------------------	------------------

The symbols on this product (including the accessories) represent the following:

$\sim$	AC
$\text{---}$	DC
	Class II equipment (The construction of the product is double-insulated.)

**35 mm full-frame interchangeable lens:  
S-R2060 “LUMIX S 20-60 mm F3.5-5.6”**

<b>Mount</b>	Leica Camera AG L-Mount
<b>Focal length</b>	f=20 mm to 60 mm
<b>Lens construction</b>	11 elements in 9 groups (2 aspherical lenses, 3 ED lenses, 1 UHR lens)
<b>Aperture type</b>	9 diaphragm blades/Circular aperture diaphragm
<b>Maximum aperture</b>	F3.5 (Wide) to F5.6 (Tele)
<b>Minimum aperture value</b>	F22
<b>Angle of view</b>	94° (Wide) to 40° (Tele)
<b>In focus distance</b>	0.15 m (0.49 feet) to ∞ (Wide to focal length 26 mm)/ 0.4 m (1.31 feet) to ∞ (Tele) (from the focus distance reference line)
<b>Maximum image magnification</b>	0.43× (focal length 26 mm)
<b>Optical Image Stabilizer</b>	No
<b>Filter diameter</b>	67 mm
<b>Maximum diameter</b>	∅77.4 mm (3.0")
<b>Overall length</b>	Approx. 87.2 mm (3.4") (from the tip of the lens to the base side of the lens mount)
<b>Mass (Weight)</b>	Approx. 350 g (0.77 lb)
<b>Dust and splash resistant</b>	Yes
<b>Recommended operating temperature</b>	-10 °C to 40 °C (14 °F to 104 °F)
<b>Permissible relative humidity</b>	10 %RH to 80 %RH

# Index

## Numerics

1-Area (AF) .....	50
1-Area AF Moving Speed .....	151
1-Area+ (AF) .....	50
225-Area (AF) .....	49
4K/50p Bit Mode .....	138
4K/60p Bit Mode .....	138
6K/4K Burst .....	58
6K/4K Burst (S/S) .....	59
6K/4K burst file .....	60
6K/4K PHOTO .....	58, 152
6K/4K PHOTO Bulk Saving .....	155
6K/4K PHOTO Noise Reduction .....	155
6K/4K Pre-Burst .....	59

## A

AF .....	45
AF Area Display .....	153
AF Assist Light .....	151
AF Custom Setting (Photo) .....	46, 151
AF Custom Setting (Video) .....	107, 152
AF mode .....	47
AF ON .....	45, 53
AF/AE Lock .....	76
AF/AE Lock Hold .....	153
AF+MF .....	153
AFC .....	44
AFC Start Point (225-Area) .....	49, 153
AF-Point Scope .....	45
AF-Point Scope Setting .....	153
AFS .....	44
Anamorphic (4:3) .....	130, 152
Anamorphic (Video) .....	70
Anamorphic Desqueeze Display .....	132, 154, 155
Anamorphic recording .....	129
Android .....	156

Animal detection .....	48
Aperture Bracket .....	64
Aperture-Priority AE mode .....	72
Approved Regulations .....	155
Aspect Ratio .....	41, 151
Auto Exposure Comp. .....	151
Auto Exposure in P/A/S/M .....	94, 153
Auto focus .....	45
Auto Review .....	153
Auto White Balance .....	80

## B

Battery .....	28, 29
Battery Use Priority .....	154
Beep .....	154
Blinking Highlights .....	154
Bluetooth .....	154, 157
Boost I.S. (Video) .....	69
Bracketing .....	64, 152
Bulb .....	74
Burst rate .....	56
Burst Shot .....	55
Burst Shot 1 Setting .....	56, 58, 152
Burst Shot 2 Setting .....	56, 58, 152

## C

Calendar screen .....	145
Card .....	31, 42
Card Access Light .....	32
Card Format .....	32, 154
Card Slot Change .....	145
Center Marker .....	154
Center-weighted metering .....	71
Charge .....	28
Clock Set .....	34, 155
Color Space .....	153, 164
Communication Light .....	151
Compression rate .....	41



- 
- Condensation ..... 19
- Constant Preview ..... 153
- Continuous AF ..... 106, 152
- Control panel ..... 36, 37, 173
- Copy ..... 155
- Copyright Information ..... 154
- Creative Video Combined Set. .... 98, 153
- Creative Video mode ..... 96
- Custom (AF) ..... 50
- Custom menu ..... 153
- Custom mode ..... 148
- Custom Mode Settings ..... 154
- D**
- 
- Delete ..... 146
- Delete All Images ..... 155
- Delete Confirmation ..... 155
- Delete Single ..... 146
- Destination Card Slot ..... 42
- Dial Setting ..... 153
- Diffraction Compensation ..... 151
- Diopter adjustment ..... 35
- Double Card Slot Function ..... 42, 154
- Drive mode ..... 55
- E**
- 
- Enlarged display ..... 145
- E-Stabilization (Video) ..... 68
- Exposure Bracket ..... 64
- Exposure compensation ..... 75
- Exposure Compensation Display Setting  
..... 153
- Exposure Compensation Reset ..... 153
- Exposure Meter ..... 153
- Exposure Mode ..... 96, 152
- Exposure Offset Adjustment ..... 153
- Extended ISO ..... 153
- Extended Tele Conversion ..... 152
- External microphone ..... 139
- External monitor/external recorder ..... 135
- Eye Sensor ..... 35, 154
- Eye Sensor AF ..... 153
- F**
- 
- Face/Eye/Body/Animal Detect. .... 48
- File number ..... 43, 164
- File Number Reset ..... 154
- Filter Effect ..... 84
- Filter Settings ..... 84, 151
- Firing Mode ..... 151
- Firmware update ..... 18
- Firmware Version ..... 155
- Flash ..... 91
- Flash Adjust. .... 151
- Flash Mode ..... 92, 151
- Flash Synchro ..... 151
- Flicker Decrease (Video) ..... 152
- Fn button ..... 147
- Fn Button Set ..... 147, 153
- Focal Length ..... 153
- Focal Length Set ..... 70
- Focus ..... 45, 106
- Focus Bracket ..... 64
- Focus mode ..... 44
- Focus Peaking ..... 151
- Focus Ring Control ..... 154
- Focus Ring Lock ..... 153
- Focus Switching for Vert/Hor ..... 153
- Focus/Shutter Priority ..... 153
- Folder number ..... 43, 164
- Folder/File Settings ..... 43, 154
- Forced Flash Off ..... 92
- Frame Marker ..... 117, 153
- Framing Outline ..... 154
- G**
- 
- Gamma setting (Photo Style) ..... 82

<b>H</b>		<b>L</b>	
Half-Press Shutter.....	153	Language .....	155
HDMI micro cable .....	135, 162	Lens.....	32
HDMI output.....	135	Lens Fn Button Setting.....	154
HDMI Rec Output.....	138, 154	Lens Focus Resume .....	154
HDMI Recording Control.....	138	Lens hood.....	33
HDMI socket .....	135, 162	Level Gauge.....	154
Headphone socket.....	142	Level Gauge Adjustment.....	154
Headphone Volume .....	143, 152, 154	Live Cropping .....	120, 153
High Resolution Mode.....	86, 151	Live View Boost.....	153
Highlight-weighted metering .....	71	Live View Composite.....	65, 152
Histogram.....	153	Load Custom Mode .....	154
HLG Photo .....	89, 151	Log recording .....	123
HLG video .....	126	Long Exposure NR.....	151
HLG View Assist .....	128, 154	Looped Focus Frame .....	153
HLG View Assist (Monitor).....	155	Low illumination AF .....	45
Hot shoe cover.....	91	Luminance Level .....	108, 152
<b>I</b>		Luminance Spot Meter .....	115, 154
i.Dynamic Range.....	151	LUMIX Sync .....	156
I.S. Status Scope .....	154	LUMIX Tether .....	167
Image Area of Video .....	100, 152	LUT View Assist .....	125
Image Quality .....	83	LUT View Assist (Monitor).....	155
Image Stabilizer .....	67, 152	LVF Frame Rate.....	154
Info Display (During HDMI Output) ....	138	LVF Luminance .....	154
Intelligent Auto mode .....	39	LVF/Monitor Display Set.....	153
iOS .....	156	<b>M</b>	
ISO Displayed Setting .....	153	Magnify from AF Point.....	155
ISO Increments .....	153	Manual Exposure mode .....	74
ISO sensitivity .....	77	Manual Flash Adjust.....	151
ISO Sensitivity (photo) .....	151	Manual focus.....	52
ISO Sensitivity (video).....	111, 152	Metering Mode .....	71, 151
<b>J</b>		MF .....	52
Joystick Setting .....	153	MF Assist.....	153
<b>K</b>		MF Guide.....	153
Knee.....	109	Mic Socket.....	139, 152
		Minimum Shutter Speed.....	151
		Monitor .....	34, 169
		Monitor Backlight.....	154

Monitor Frame Rate.....	154	Power supply .....	31
Monitor Settings.....	154	Pre-Burst Recording .....	59
Monochrome Live View .....	154	Program AE mode .....	71
MOV .....	100	Program Shift.....	72
MP4 .....	100	Protect .....	155
Multi-metering .....	71	<b>Q</b>	
Multiple Exposure .....	152	Q.Menu Settings .....	153
My Menu .....	155	Quick AF .....	153
<b>N</b>		Quick menu.....	37
Night Mode .....	153	<b>R</b>	
<b>O</b>		Rating .....	155
Online Manual .....	4, 155	RAW .....	41
Operation Lock Setup .....	153	RAW Processing.....	155
Optical zoom.....	54	Rec Quality .....	101, 152
<b>P</b>		Rec. File Format .....	100, 152
PC connection .....	163	Recording mode .....	39
Photo Grid Line.....	153	Recording videos .....	93
Photo menu .....	151	Red REC Frame Indicator .....	154
Photo Style .....	81, 151	Red-Eye Removal.....	151
Photo Style Settings .....	153	Remote shooting.....	160
Photo/video preview .....	153	Reset .....	38, 154
PHOTOfunSTUDIO .....	165	Resize.....	155
Photos/videos remaining .....	154	Rotate .....	155
Picture Quality .....	41, 151	Rotate Display .....	155
Picture Size .....	41, 151	<b>S</b>	
Picture Sort.....	155	Save to Custom Mode .....	148, 154
Pinpoint (AF).....	50	Save/Restore Camera Setting	
Pinpoint AF Setting .....	153	.....	150, 154
Pixel Refresh .....	155	SD Speed Class .....	32
Play back picture .....	144	Self-timer .....	63, 152
Play back video .....	144	Sensor Cleaning .....	155
Playback .....	144	Setup menu .....	154
Playback menu .....	155	Sheer Overlay.....	154
Playback Mode .....	155	Shoulder strap .....	27
Post-Focus .....	152	Show/Hide AF Mode.....	153
Power Save Mode .....	154	Show/Hide Monitor Layout.....	154

Shutter AF .....	153
Shutter Delay .....	152
Shutter Remote Control .....	161
Shutter Type .....	152
Shutter-Priority AE mode .....	73
Silent Mode .....	152
Slide show .....	155
Slow & Quick mode .....	96, 118
Slow & Quick Setting .....	119, 152
Sound Output .....	143, 152
Sound Output (HDMI) .....	138
Sound Rec Level Adj. ....	112, 152
Sound Rec Level Disp. ....	112, 152
Sound Rec Level Limiter .....	112, 152
Special Mic .....	140, 152
Spot metering .....	71
Starlight AF .....	45
Stereo Shotgun Microphone .....	139
Stop Motion Animation .....	152
Stop Motion Video .....	155
Switch NTSC/PAL .....	99, 152

**T**

Tethered Recording .....	167
Thumbnail screen .....	145
Time Code .....	104, 105, 152
Time Lapse Shot .....	61, 152
Time Lapse Video .....	155
Time Zone .....	34, 155
Touch Settings .....	153
Tracking (AF) .....	49
TV Connection .....	154

**U**

UHS Speed Class .....	32
USB .....	154
USB connection cable .....	28, 30, 163
USB port .....	30, 163

**V**

Video Divide .....	155
Video menu .....	152
Video rec. button .....	93
Video Rec. Button (Remote) .....	153
Video Speed Class .....	32
Viewfinder .....	35, 154, 169
Vignetting Compensation .....	151
V-Log .....	123
V-Log View Assist .....	125, 154

**W**

Waveform Monitor .....	113, 154
WB/ISO/Exposure Button .....	153
White balance .....	79
White Balance Bracket .....	64
White Balance Bracket (Color Temperature) .....	64
Wi-Fi .....	154
Wind Cut .....	141, 152
Wind Noise Canceller .....	112, 152
Wireless .....	151
Wireless Channel .....	151
Wireless Connection Light .....	154, 156
Wireless FP .....	151
Wireless Setup .....	151

**X**

XLR Mic Adaptor Setting .....	142, 152
XLR Microphone Adaptor .....	141

**Z**

Zebra Pattern .....	116, 154
Zone (AF) .....	49
Zoom .....	54

# Trademarks and Licenses



- L-Mount is a trademark or registered trademark of Leica Camera AG.
- SDXC Logo is a trademark of SD-3C, LLC.
- The terms HDMI and HDMI High-Definition Multimedia Interface, and the HDMI Logo are trademarks or registered trademarks of HDMI Licensing Administrator, Inc. in the United States and other countries.
- USB Type-C™ and USB-C™ are trademarks of USB Implementers Forum.
- The SuperSpeed USB Trident Logo is a registered trademark of USB Implementers Forum, Inc.
- QuickTime and the QuickTime logo are trademarks or registered trademarks of Apple Inc., used under license therefrom.
- HDAVI Control™ is a trademark of Panasonic Corporation.
- Adobe is a trademark or registered trademark of Adobe Systems Incorporated in the United States and/or other countries.
- Pentium is a trademark of Intel Corporation in the U.S. and/or other countries.
- Windows is a registered trademark or trademark of Microsoft Corporation in the United States and/or other countries.



- Final Cut Pro, Mac, OS X and macOS are trademarks of Apple Inc., registered in the U.S. and other countries.
- App Store is a service mark of Apple Inc.
- Google, Android and Google Play are trademarks of Google LLC.
- The Bluetooth® word mark and logos are registered trademarks owned by Bluetooth SIG, Inc. and any use of such marks by Panasonic Corporation is under license. Other trademarks and trade names are those of their respective owners.
- The Wi-Fi CERTIFIED™ Logo is a certification mark of Wi-Fi Alliance®.
- The Wi-Fi Protected Setup™ Logo is a certification mark of Wi-Fi Alliance®.
- “Wi-Fi®” is a registered trademarks of Wi-Fi Alliance®.
- “Wi-Fi Protected Setup™”, “WPA™”, and “WPA2™” are trademarks of Wi-Fi Alliance®.
- This product uses “DynaFont” from DynaComware Corporation. DynaFont is a registered trademark of DynaComware Taiwan Inc.
- QR Code is a registered trademark of DENSO WAVE INCORPORATED.
- Other names, company names, product names mentioned in this document are trademarks or registered trademarks of the companies concerned.

This product incorporates the following software:

- (1) the software developed independently by or for Panasonic Corporation,
- (2) the software owned by third party and licensed to Panasonic Corporation,
- (3) the software licensed under the GNU General Public License, Version 2.0 (GPL V2.0),
- (4) the software licensed under the GNU LESSER General Public License, Version 2.1 (LGPL V2.1), and/or
- (5) open source software other than the software licensed under the GPL V2.0 and/or LGPL V2.1.

The software categorized as (3) - (5) are distributed in the hope that it will be useful, but WITHOUT ANY WARRANTY, without even the implied warranty of MERCHANTABILITY or FITNESS FOR A PARTICULAR PURPOSE. Please refer to the detailed terms and conditions thereof displayed by selecting [MENU/SET] → [Setup] → [Others] → [Firmware Version] → [Software info].

At least three (3) years from delivery of this product, Panasonic will give to any third party who contacts us at the contact information provided below, for a charge no more than our cost of physically performing source code distribution, a complete machine-readable copy of the corresponding source code covered under GPL V2.0 or LGPL V2.1, as well as the respective copyright notice thereof.

Contact Information: [oss-cd-request@gg.jp.panasonic.com](mailto:oss-cd-request@gg.jp.panasonic.com)

The source code and the copyright notice are also available for free in our website below.

<https://panasonic.net/cns/oss/index.html>

---

This product is licensed under the AVC Patent Portfolio License for the personal use of a consumer or other uses in which it does not receive remuneration to (i) encode video in compliance with the AVC Standard ("AVC Video") and/or (ii) decode AVC Video that was encoded by a consumer engaged in a personal activity and/or was obtained from a video provider licensed to provide AVC Video. No license is granted or shall be implied for any other use. Additional information may be obtained from MPEG LA, L.L.C.

See <http://www.mpegla.com>

# Limited Warranty (ONLY FOR U.S.A.)

## Panasonic Products Limited Warranty

### Limited Warranty Coverage (For USA Only)

If your product does not work properly because of a defect in materials or workmanship, Panasonic Corporation of North America (referred to as "the warrantor") will, for the length of the period indicated on the chart below, which starts with the date of original purchase ("warranty period"), at its option either (a) repair your product with new or refurbished parts, (b) replace it with a new or a refurbished equivalent value product, or (c) refund your purchase price. The decision to repair, replace or refund will be made by the warrantor.

Product or Part Name	Parts	Labor
Digital Camera	1 Year	1 Year
All included Accessories (Except Non-Rechargeable Batteries)	90 Days	Not Applicable
Only Non-Rechargeable Batteries	10 Days	Not Applicable

During the "Labor" warranty period there will be no charge for labor. During the "Parts" warranty period, there will be no charge for parts. This Limited Warranty excludes both parts and labor for non-rechargeable batteries, antennas, and cosmetic parts (cabinet). This warranty only applies to products purchased and serviced in the United States. This warranty is extended only to the original purchaser of a new product which was not sold "as is".

### Mail-In Service--Online Repair Request

#### Online Repair Request

To submit a new repair request and for quick repair status visit our Web Site at <http://shop.panasonic.com/support>.

When shipping the unit, carefully pack, include all supplied accessories listed in the Owner's Manual, and send it prepaid, adequately insured and packed well in a carton box. When shipping Lithium Ion batteries please visit our Web Site at <http://shop.panasonic.com/support> as Panasonic is committed to providing the most up to date information. Include a letter detailing the complaint, a return address and provide a daytime phone number where you can be reached. A valid registered receipt is required under the Limited Warranty.



**IF REPAIR IS NEEDED DURING THE WARRANTY PERIOD, THE PURCHASER WILL BE REQUIRED TO FURNISH A SALES RECEIPT/PROOF OF PURCHASE INDICATING DATE OF PURCHASE, AMOUNT PAID AND PLACE OF PURCHASE. CUSTOMER WILL BE CHARGED FOR THE REPAIR OF ANY UNIT RECEIVED WITHOUT SUCH PROOF OF PURCHASE.**

**Limited Warranty Limits and Exclusions**

This warranty ONLY COVERS failures due to defects in materials or workmanship, and DOES NOT COVER normal wear and tear or cosmetic damage. The warranty ALSO DOES NOT COVER damages which occurred in shipment, or failures which are caused by products not supplied by the warrantor, or failures which result from accidents, misuse, abuse, neglect, mishandling, misapplication, alteration, faulty installation, set-up adjustments, misadjustment of consumer controls, improper maintenance, power line surge, lightning damage, modification, introduction of sand, humidity or liquids, commercial use such as hotel, office, restaurant, or other business or rental use of the product, or service by anyone other than a Factory Service Center or other Authorized Servicer, or damage that is attributable to acts of God.

**THERE ARE NO EXPRESS WARRANTIES EXCEPT AS LISTED UNDER “LIMITED WARRANTY COVERAGE”.**

**THE WARRANTOR IS NOT LIABLE FOR INCIDENTAL OR CONSEQUENTIAL DAMAGES RESULTING FROM THE USE OF THIS PRODUCT, OR ARISING OUT OF ANY BREACH OF THIS WARRANTY.**

(As examples, this excludes damages for lost time, travel to and from the servicer, loss of or damage to media or images, data or other memory or recorded content. The items listed are not exclusive, but for illustration only.)

**ALL EXPRESS AND IMPLIED WARRANTIES, INCLUDING THE WARRANTY OF MERCHANTABILITY, ARE LIMITED TO THE PERIOD OF THE LIMITED WARRANTY.**

Some states do not allow the exclusion or limitation of incidental or consequential damages, or limitations on how long an implied warranty lasts, so the exclusions may not apply to you.

This warranty gives you specific legal rights and you may also have other rights which vary from state to state. If a problem with this product develops during or after the warranty period, you may contact your dealer or Service Center. If the problem is not handled to your satisfaction, then write to:

Panasonic Corporation of North America  
Consumer Affairs Department 8th Fl.  
Two Riverfront Plaza  
Newark NJ 07102-5490

**PARTS AND SERVICE, WHICH ARE NOT COVERED BY THIS LIMITED WARRANTY, ARE YOUR RESPONSIBILITY.**

**Shop**  
**Accessories!**

for all your Panasonic gear

Go to

<http://shop.panasonic.com/support>

Get everything you need to get the most out of your Panasonic products  
Accessories & Parts for your Camera, Phone, A/V products, TV, Computers & Networking, Personal Care, Home Appliances, Headphones, Batteries, Backup Chargers & more...

**Customer Services Directory**

For Product Information, Operating Assistance, Parts, Owner's Manuals, Dealer and Service info  
go to <http://shop.panasonic.com/support>

For the hearing or speech impaired TTY: 1- 877-833-8855

**As of December 2019**



## Panasonic Corporation of North America

Two Riverfront Plaza, Newark, NJ 07102-5490

<http://shop.panasonic.com>

© Panasonic Corporation 2020



DVQX2063ZA

F0720MR0

Printed in China