

T-TAP Pro

Thunderbolt 3 to 12G-SDI/HDMI



Installation and Operation Guide

Version 16.0r1
Published March 24, 2021



Notices

Trademarks

AJA® and Because it matters.® are registered trademarks of AJA Video Systems, Inc. for use with most AJA products. AJA™ is a trademark of AJA Video Systems, Inc. for use with recorder, router, software and camera products. Because it matters.™ is a trademark of AJA Video Systems, Inc. for use with camera products.

Corvid Ultra®, Io®, Ki Pro®, KONA®, KUMO®, ROI® and T-Tap® are registered trademarks of AJA Video Systems, Inc.

AJA Control Room™, KiStor™, Science of the Beautiful™, TruScale™, V2Analog™ and V2Digital™ are trademarks of AJA Video Systems, Inc.

All other trademarks are the property of their respective owners.

Copyright

Copyright © 2021 AJA Video Systems, Inc. All rights reserved. All information in this manual is subject to change without notice. No part of the document may be reproduced or transmitted in any form, or by any means, electronic or mechanical, including photocopying or recording, without the express written permission of AJA Video Systems, Inc.

Contacting AJA Support

When calling for support, have all information at hand prior to calling. To contact AJA for sales or support, use any of the following methods:

Telephone	+1.530.271.3190
FAX	+1.530.271.3140
Web	https://www.aja.com
Support Email	support@aja.com
Sales Email	sales@aja.com

Contents

Notices	2
Trademarks	2
Copyright	2
Contacting AJA Support	2
Chapter 1 – Introduction	4
Overview	4
Features	4
Video Signal Formats	5
AJA Software & Utilities	5
System Requirements	6
Cable Connections, Controls, and Indicators	6
Audio Output Connector	6
Audio Level Meter	7
Audio Gain Control Knob	7
Power Connection Status LED	7
Thunderbolt 3 Port	8
SDI Output	8
HDMI Output	8
Power Status LED	8
Bitfile Status LED	8
Power Connector	9
Chapter 2 – Installation	10
Unpacking T-TAP Pro	10
Installation Procedure	10
Power Requirements	11
Heat Dissipation	11
Installing T-TAP Pro Software	11
macOS Installations	11
Updating T-TAP Pro Firmware	11
Chapter 3 – Operation	13
Using T-TAP Pro with Professional Video /Audio Software	13
AJA Control Panel Overview	13
AJA Control Panel, Block Diagram	14
Presets	16
Default Preferences	16
T-TAP Pro Audio Monitoring	17
Control Screen	18
Format Screen	20
SDI Output Screen	21
HDMI Screen	22
HDR Screen	23
Video Setup Screen	25
Audio Setup Screen	26
Audio Mixer Screen	26
Presets Screen	29
Firmware Screen	30
Info Screen	31
Appendix A – Specifications	32
T-TAP Pro Pro Tech Specs	32
Appendix B – Safety and Compliance	34
Warranty and Liability Information	40
Index	42

Chapter 1 – Introduction



Overview

T-TAP Pro is a simple, high-quality device to output video from Thunderbolt™ enabled computers, with AJA's broad, bullet-proof application compatibility. It is a mobile device that can easily output pristine 4K, UltraHD or HD signals from a wide selection of editorial, graphics, color and audio software packages. It taps the flexibility of the widely available Thunderbolt 3 port, which is common on modern Apple and PC workstations and laptops.

T-TAP Pro features the latest 12G-SDI and HDMI v2.0 connectivity for working with 4K or UltraHD over a single cable, allowing you to easily output deep color, high frame rate, and HDR imagery to a wide range of pro and consumer monitors and devices, all at the highest 10- and 12-bit uncompressed quality.

Audio support is extensive, with up to 16 channels of SDI embedded audio and 8 channels on HDMI. The integrated headphone jack provides easy monitoring of any two audio tracks, and the front panel VU meters give you a quick visual guide of your audio levels.

Because T-TAP Pro's internal 12G signal processing requires more power than the Thunderbolt bus can provide, an external power supply is required and provided.

Like all AJA Desktop products, T-TAP Pro is compatible with a huge range of creative applications for editorial, audio production, graphics, and much more. All of this is powered by AJA's highly respected Desktop software, with field proven drivers and application plug-ins.

Features

- One Thunderbolt 3 port
- One 12G SDI output
- One HDMI v2.0 output
- 16-Channel SDI embedded audio output
- 8-Channel HDMI embedded audio output
- One stereo audio output 1/8" TRS
- Front panel audio meters
- Assignable function front panel volume knob, able to control audio monitoring or embedded audio output levels
- External power supply provided

Video Signal Formats

The Video Signal Formats supported by T-TAP Pro are listed in ("[Appendix A Specifications](#)" on page 32).

AJA Software & Utilities

AJA's T-TAP Pro software and hardware were developed for powerful integrated video/audio monitoring, editing, and production with a variety of 3rd-party software. With T-TAP Pro and a qualified computer, you have the ultimate system for standard and high definition production, post-production, broadcast, and streaming work. AJA software is distributed as a unified package which includes all the software, firmware, plugins, and utility programs for AJA's Io, KONA, and T-TAP Pro products.

Two retail packages are available, one for Mac and one for Windows.

Mac and Windows Packages

These packages include:

Firmware

Firmware, otherwise referred to as a bit file or the card's 'personality', refers to very low level code that defines the capabilities of the hardware. It is important to always update to the firmware recommended following install of new, or older versions of software.

Drivers

AJA device drivers for the host system OS provide tightly integrated hardware/software operation.

AJA Control Panel

The Control Panel provides:

- Source selection and control of your AJA hardware.

NOTE: For T-TAP Pro, AJA Control Panel functions are centered around output settings.

- A block diagram to show visually what routing and processing is being performed.

AJA Control Room

Control Room is a cross-platform software application for ingest, playback and output with AJA products.

NOTE: For T-TAP Pro, capture is not supported via AJA Control Room.

AJA System Test

AJA System Test provides accurate and detailed evaluations of drive and system performance statistics, allowing you to measure the capabilities of your system for recording and playing back various resolutions and codecs. The application includes:

- System Disk Test
- AJA Device Test
- Disk + Device Test
- System Report

The application tests Read and Write, Capture and Playback speeds in both Megabytes per second and Frames per second. The disk speed tests differ from standard disk I/O performance applications in that they specifically test the system under conditions typically encountered with video capture, playback, and editing.

NOTE: Theoretically the best test (or simulation) is to fill your storage disk to 80% and then test capture at the highest data rate you will use.

3rd-Party Plug-ins

Plug-ins for popular 3rd-party Professional Video Applications from Adobe, Avid, Apple, Telestream, and others.

System Requirements

AJA Video recommends that your system meet minimum hardware and software requirements to achieve a satisfactory level of performance. Updates to system requirements are subject to change.

See the Release Notes for you AJA Card or Device, available on the AJA website and also installed with the software package, for minimum and recommended system requirements including OS, CPU, RAM, and GPU.

NOTE: Also see Software Vendor system requirements for GPU recommendations and additional hardware requirements and recommendations.

NOTE: For large scale installations with shared storage, IP, or for very high performance requirements, AJA recommends consultation with an experienced system integrator. A consultant will be able to assist with many important variables.

Cable Connections, Controls, and Indicators

Figure 1. T-TAP Pro Front View

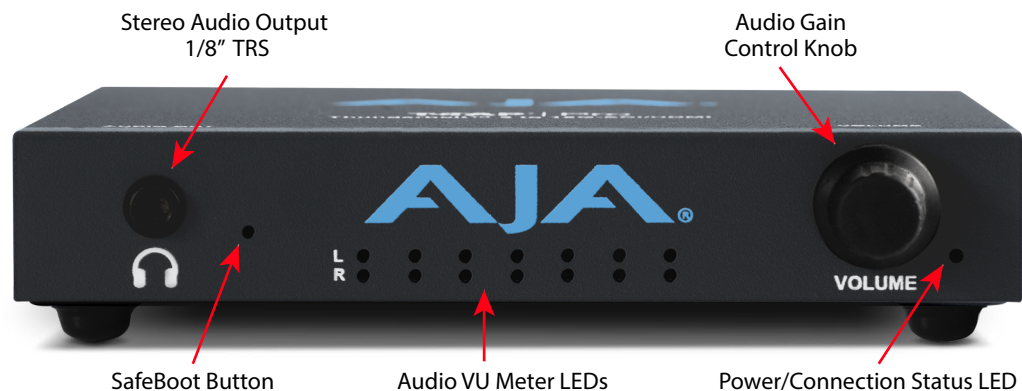

Audio Output Connector

A 1/8 inch TRS connector is available for monitoring two channels of audio, selectable in channel pairs using the Control Panel application. Typically used with a pair of headphones.

Audio Level Meter

The Audio Level Meter in the center of the front panel indicates the sum of whatever sources are being played out to the HDMI and SDI embedded audio video output; i.e. NLE timeline and mix of host system audio output (if applicable).

The meter's LEDs are colored to indicate the amount below 0dBfs when averaged over a one millisecond time interval.

dBfs	LED Color and Location
-2 db	Red LED 1 (top)
-12 db	Yellow LED 2
-20 db	Yellow LED 1
-30 db	Green LED 4
-40 db	Green LED 3
-50 db	Green LED 2
-60 db	Green LED 1 (bottom)

NOTE: These audio level meters are for guidance only. Third-party audio metering should be employed when doing critical audio editing and mixing.

Audio Gain Control Knob

The front panel volume knob can be assigned one of two different functions, via the AJA Control Room application. This encoder spins freely, without max/min limits. The gain increases to max, and then returns to zero after a complete rotation.

- The knob's default function is to simply adjust the audio level being sent to the T-TAP Pro's front panel audio output connector (headphone jack). The embedded audio being output by T-TAP Pro is always indicated on its front panel VU meters, which in this situation will not be changed by your knob adjustment.
- Alternatively, the knob can be assigned to adjust the level of the embedded audio being sent out the T-TAP Pro's rear SDI and HDMI connectors. In this situation the front panel VU meters will report your level changes. An example of using this feature would be to trim the level of the embedded audio output because it was increased after mixing in a computer originated audio source.

NOTE: Since the headphone output is derived from the master level, adjusting the embedded audio levels will also affect the levels driven to the front panel analog audio output.

Power Connection Status LED

This LED indicates the current connection status of your T-TAP Pro.

- OFF: No power detected
- AMBER SOLID: Power is on but Thunderbolt is not live (e.g. Thunderbolt ports disabled in host, BIOS settings)
- AMBER BLINKING: Thunderbolt is awake but no PCIe connection to host (e.g. device hasn't been whitelisted by the Thunderbolt software running on host)
- GREEN BLINKING: Thunderbolt is awake, PCIe is connected, but device doesn't see the NTV2 Driver (This shows up on Windows where the AJA driver has been restricted from talking to peripherals – security setting error, or because the AJA software is not installed on the host)
- GREEN SOLID: Thunderbolt is communicating properly.

Figure 2. T-TAP Pro Rear View

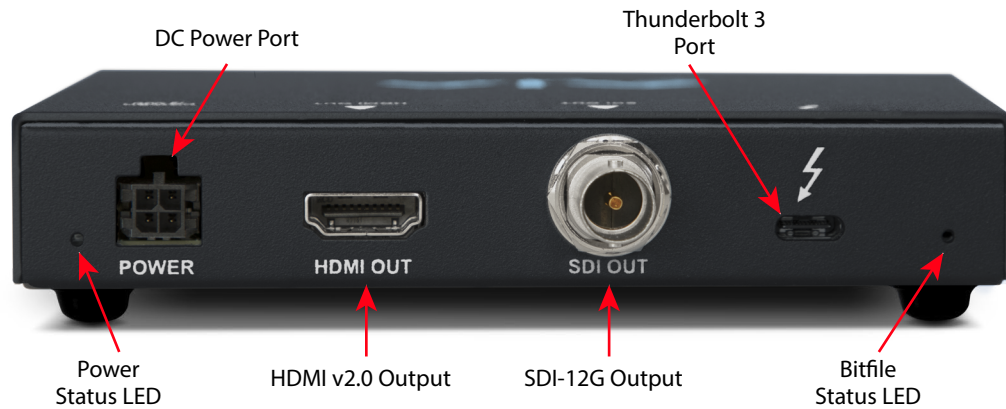

Thunderbolt 3 Port

The high speed of Thunderbolt allows connection to peripheral devices while achieving PCI Express performance.

NOTE: T-TAP Pro cannot be powered through its Thunderbolt port (insufficient power).

AJA's T-TAP Pro is designed to utilize the full bandwidth provided by Thunderbolt 3. Use a certified, high-quality Thunderbolt 3 cable to connect your AJA device to the host computer. The cable should have a Thunderbolt logo and the number 3 on it. Passive cables can be up to 1.6 feet (0.5m) maximum length. Active cables up to 6.5 feet (2m) can also be used.

If you choose to attach T-TAP Pro to a Thunderbolt 2 host machine, there are adapters available on the market, with perhaps Apple's being the most commonly used. That said, you may find situations where the lack of a Thunderbolt 3 host system will limit what workflows you are able to support with T-TAP Pro.

SDI Output

A BNC connector is provided on T-TAP Pro for one 12G-SDI output. This output also supports up to 16 channels of embedded 24-bit digital audio.

HDMI Output

An HDMI v2.0 connector on the T-TAP Pro provides output of HDMI compatible video and up to 8-channels of embedded audio. If you have a source with 16 audio channels, you can select to output channels 1-8 or 9-16 via HDMI.

HDCP is not supported on the output. The HDMI output supports standard HDMI cables only.

Power Status LED

- OFF: No power detected
- GREEN: The unit is receiving power

Bitfile Status LED

This indicates whether T-TAP Pro is running the main bitfile, or the safeboot failsafe recovery bitfile.

- GREEN: FPGA is loaded and running the main bitfile (normal operation)
- RED: FPGA loaded and running failsafe bitfile

Power Connector

Power to the T-TAP Pro provided by an external power supply module (provided) that accepts a 110-240VAC, 50/60Hz power input and supplies +12 VDC.

IMPORTANT: The T-TAP Pro power connector has a latch, similar to an Ethernet connector. Depress the latch (facing the top of the device) before disconnecting the power cable from the unit.

Chapter 2 – Installation

Unpacking T-TAP Pro

As you unpack T-TAP Pro, carefully examine the unit to ensure that nothing was damaged during shipment. If you find any damage, immediately notify the shipping service and supply them with a complete description of the damage. AJA will repair or replace damaged units. If you find shipping damage, contact your AJA dealer or distributor for details on how to have your T-TAP Pro repaired or replaced. Save packing materials and the shipping box. If you ever require service or move your system, use the packaging materials and box for safe shipment.

Installation Procedure

1. Unpack the T-TAP Pro shipping box (see above).
2. Ensure that your editing or streaming application software has been installed on your computer.
3. Install the latest AJA T-TAP Pro software on your computer.
4. Connect your T-TAP Pro to its power supply unit, and connect the power cord to mains AC, using the provided cables.

NOTE: T-TAP Pro cannot be powered by its Thunderbolt connection (insufficient bus power).

Figure 3. Typical T-TAP Pro Laptop System Connections

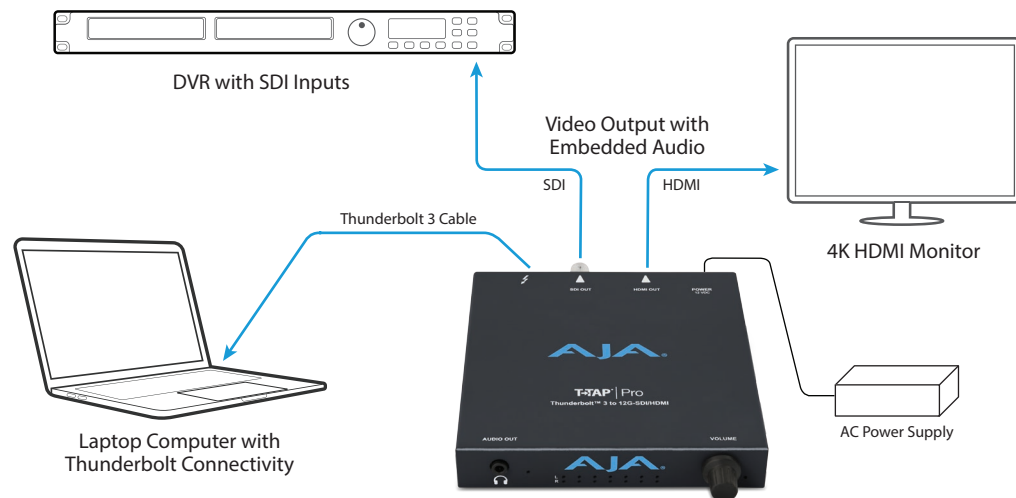

5. Connect your T-TAP Pro's Thunderbolt 3 port to your computer via a Thunderbolt 3 cable (not included). Thunderbolt 2 to 3 adaptors can be used, with reduced throughput.
6. Connect T-TAP Pro's SDI and/or HDMI outputs to your downstream equipment, as required for your workflow.
7. If desired, connect a pair of headphones or other audio monitoring device to the T-TAP Pro's front panel Audio Out connector.
8. Power cycle your computer while your T-TAP Pro remains powered up with its Thunderbolt cable connected to your computer.

9. Launch the AJA Control Panel application. It should recognize the connected T-TAP Pro and it should be fully functional as long as it is properly cabled and powered.

NOTE: *If after installation the T-TAP Pro's right front panel LED is blinking green, you can try disconnecting and reconnecting the Thunderbolt cable, or with the Thunderbolt cable connected power cycle your computer.*

Power Requirements

- Input Voltage: 110-240VAC, 50/60Hz
- Power supply and cables provided.

Heat Dissipation

To provide silent operation, T-TAP Pro uses its metal case to pass internal heat to the outside air. The case will get hot to the touch, but not in excess of UL spec (140 F). The rubber feet on the bottom are designed for increased air flow.

CAUTION: *T-TAP Pro should not be stacked with other equipment, be covered or installed in a way that inhibits air flow, or be exposed to additional heat.*

Installing T-TAP Pro Software

Go to the AJA website and download the latest AJA software installer, which includes a package of all the current software for AJA's KONA, Io, and T-TAP Pro products, including the AJA Control Panel and AJA Control Room applications.

<https://www.aja.com/en/support/downloads/>

System software updates may occasionally become available on our website (www.aja.com). We recommend checking occasionally for both software updates and additional product information.

NOTE: *If your computer has previously had another video capture or multimedia device installed, ensure you uninstall any related software before installing the AJA software package. This will prevent any hardware or software conflicts.*

Before installing the AJA software installer package, ensure that your editing application is installed as detailed in its user documentation. You cannot use T-TAP Pro with a third-party application until the application has been installed and run at least once on your workstation. Next, install the AJA software package.

macOS Installations

macOS High Sierra (10.13), macOS Mojave (10.14), macOS Catalina (10.15) and macOS Big Sur (11.x) all have security requirements that may present dialogs during installation. Please refer to the Release Notes for guidance.

Updating T-TAP Pro Firmware

When you update your T-TAP Pro software by downloading new versions from the AJA website, it is possible that some versions may also require a firmware update to update the software stored in non-volatile memory. Always carefully read the release notes that accompany each version to be installed. The release notes will spell out all required software and hardware necessary to ensure a successful update of your T-TAP Pro.

Follow these instructions when a firmware update is required:

1. Connect T-TAP Pro to a computer that has the AJA Software package installed.

NOTE: Only connect one AJA device to your computer when updating firmware.

2. Open the AJA Control Panel application, then go to the Firmware screen.
3. Select the desired firmware version and click Install.
4. After the install completes, power cycle your T-TAP Pro (for example, by unplugging and reconnecting the power supply).

Chapter 3 – Operation

Using T-TAP Pro with Professional Video /Audio Software

Once you've installed all the AJA software as detailed in Chapter 2, you'll find the AJA Control Panel application in your Applications folder.

AJA Control Panel Overview

The AJA Control Panel is a software application that provides a simple visual window showing how the T-TAP Pro interface is currently configured, and that allows you to make changes. Current settings—both those you changed and those you didn't—can be saved as a snapshot for recall at anytime. This lets you save settings associated with all your frequent tasks; then as you switch tasks you don't have to spend extra time resetting interface configurations—just load the previously saved settings for each task.

One thing you'll notice instantly about the Control Panel is that it represents a block diagram of how the unit is configured. The current status, output settings, and many other details can be viewed as a color-coded block diagram in the Control Panel.

To ensure you make the most of the software, launch the AJA Control Panel application and look at its display. Then refer to the "Basics" described here to fully understand what you're seeing and learn how to view and change the T-TAP Pro system configuration.

Following are some basic definitions you should know.

Block Diagram Area

The top area of the Control Panel shows a visual picture representing the processing (if any) that's currently occurring, including outputs, and system status. Lines between the framebuffer, and outputs show a video path. Where there are no lines, it shows there is no connection; this can be because an appropriate output isn't selected (such as PsF for HDMI).

Icon objects on the block diagram screen (output icons, frame buffer, etc.—also called "widgets"—indicate their status by color (explained later) and can be clicked for context-sensitive information and choices. (These same choices can also be made from the Control Panel screens.)

Figure 4. Block Diagram Area

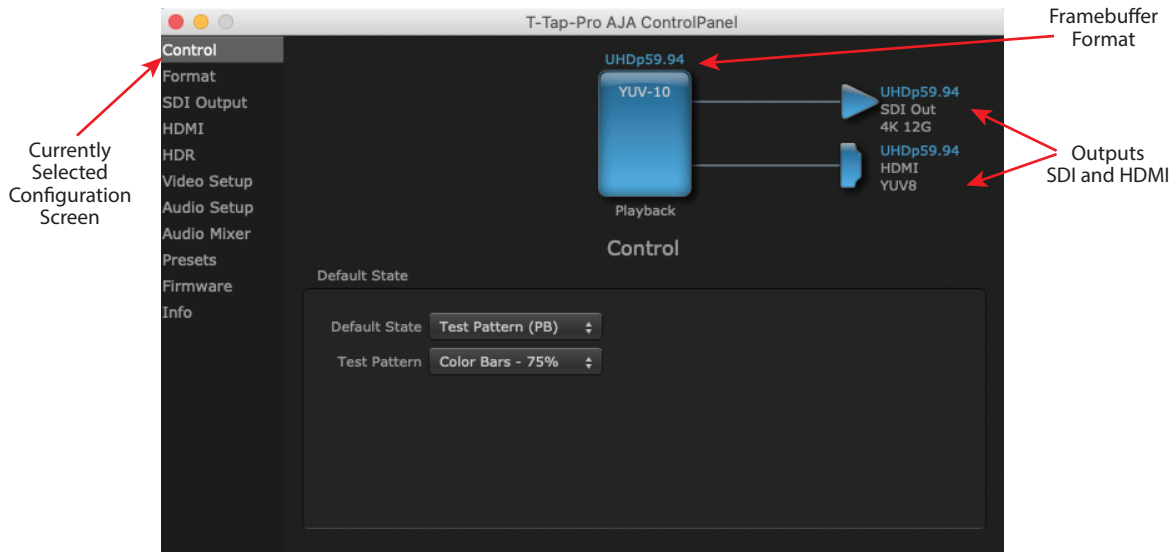

Right-Clicking an Icon produces a context-sensitive menu.

Figure 5. Context-Sensitive Menu

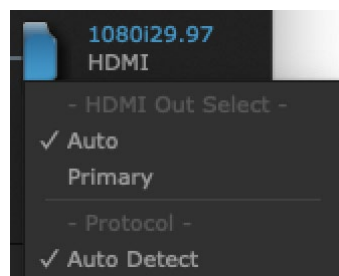

AJA Control Panel, Block Diagram

Framebuffer

The framebuffer is the “engine” in T-TAP Pro where active video operations take place using your 3rd-party applications, or even T-TAP Pro itself. The framebuffer has a format (called the “Primary Format” and color space that it follows, as defined in the Configuration Screens or via external application software. It is important to realize that inside the host computer, many applications can use the T-TAP Pro (as you switch from window to window) and it may not always be obvious which application currently controls it.

The upper-right corner of the Control Panel displays the name of the application controlling the T-TAP Pro. In some cases, applications may not always properly “let go” of the Output interface as another takes over—you’ll be able to tell by looking at the Control Panel.

Figure 6. Controlling Application

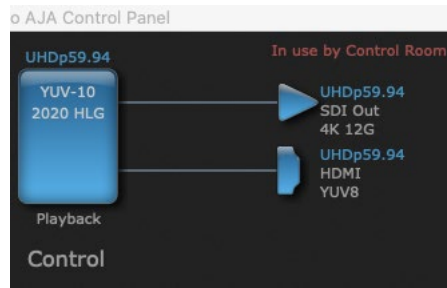

Primary Format

The video format currently assigned to T-TAP Pro. This is the format that the framebuffer will use and is shown in the Control Panel using the color blue. All icons in blue are the same as the Primary Format used by the framebuffer. Also any text descriptions in the block diagram that appear in blue also indicate that something is in the primary format.

Output Icons

The output icons are triangles that together with their color show the outputs and their status (selected, not selected, signal present or not, format, etc.). A complete video path is shown when outputs are connected with lines going from the framebuffer.

Figure 7. Output Icon Example



Color Meanings

All items in the T-TAP Pro Control Panel block diagram are color-coded to show what is happening in realtime. This applies to both icons and text. These colors have the following corresponding meanings:

- Blue: video is same format as the Primary Format (framebuffer)
- Red: the selected operation cannot be performed

Control Panel Configuration Screen links

The left side area of the T-TAP Pro Control Panel provides navigation links to the various Screens categorized by topics. Clicking on a topic—or alternatively, a block diagram element—displays an information screen corresponding to that topic. Screens that can be selected are:

- Control - Configures T-TAP Pro operation and output timing.
- Format - Select the framebuffer primary video format of outputs.
- SDI Output - Select SDI output format.
- HDMI - Configure the HDMI Output.
- HDR - Configure High Dynamic Range settings.
- Video Setup - Configure Video such as progressive format, colorspace, and gamma.
- Audio Setup - Configures Audio options such as audio delay.
- Audio Mixer - Select and mix audio sources for monitoring and adjust embedded audio output level.
- Presets - Add or delete saved preset configurations (handy for setting up the T-TAP Pro for commonly used workflows)

- Firmware - Enables installation of AJA device firmware.
- Info - Displays status information and firmware version # of the T-TAP Pro and how it is installed in the host computer. This information is generally intended for troubleshooting/support.

NOTE: You can use the Up/Down arrows on your keyboard to navigate link selections.

Presets

Setups can be named and saved as a snapshot (Preset) for recall at any time. You can save various AJA device Control Panel configurations associated with your frequent tasks. You don't have to spend time resetting interface configurations, just load the previously saved Preset for each task. See "[Saving, Loading and Deleting Presets](#)" on page 29 for more information.

If you work on multiple systems and want to carry your saved setups to another location, you can copy your saved Preset files on to movable storage and load them into any computer running the AJA Control Panel application.

Mac OS Preset Files Storage Location

- From the Finder, hold down the Option key (to display the Library directory) and click on Go/Library/Application Support/AJA/<device name>/Presets/

Windows Preset Files Storage Location

- c:\Users\<username>\AppData\Local\AJA\Control Panel\<device name>\Presets\

Default Preferences

When an AJA device starts up, a preference can determine what settings it will have it when it begins to operate. The AJA Control Panel offers two default preference settings:

- Local Preference - A preference stored from the last AJA device's Control Panel settings to be used on next startup of AJA Control Panel. This occurs on next restoration of the default state (triggered by start up of host CPU, startup of the AJA device, or when a third-party application releases the AJA device).
- Global Preference - A preference saved for use as a global default start state for an AJA device that can be shared by multiple users, applied on first startup, or by pressing the Control Panel **Reset Device...** button.

Local Preference

The Local Preference file (com.aja.devicesettings) exists to immediately and automatically store all parameter changes made by a user on a particular AJA device. When any control is changed in the Control Panel, that change is recorded in the Local Preference file stored in a unique location on that computer that is dedicated to that particular device, serial number, and logged-in user. Then, when AJA Control Panel is restarted for any reason, the AJA device being controlled restores the settings being used when Control Panel was last closed.

The Local Preference file can be accessed at the following locations.

On Mac:

- From the Finder, hold down the Option key (to display the Library directory) and click on Go/Library/Preferences/com.aja.devicesettings.

On Windows:

- C:\Users\<USER_NAME>\AppData\Local\aja\com.aja.devicesettings

NOTE: Clicking on the AJA Control Panel "Erase All Prefs" button deletes the existing Local Preference file from this location. This file will be recreated as soon as any Control Panel setting is changed.

NOTE: Clicking on the AJA Control Panel "Reset Device..." button will delete the existing Local Preference file. If a Global Preference file is found, these settings are reloaded. If a Global Preference file is not found, "factory defaults" are loaded and the device is set to that state

Global Preference

An administrator can establish a house standard for an AJA device by copying a preference file to a shared computer location. Once placed at that location, it becomes a Global Preference file where it will establish a standard default startup state for all users of that AJA device using that computer system. These settings preempt the initial AJA factory default settings, and are applied when an AJA device is first powered up, or when the Control Panel **Reset Device** button is pressed.

To establish a Global Preference, the administrator first configures the AJA device (which automatically creates a "com.aja.devicesettings" Local Preference file in the location identified above) and then copy or move that file to the correct computer locations (manually or by pushing it out across the network) on all the computers that use the AJA device.

NOTE: If the user makes changes to an AJA Device's Control Panel settings, those changes are saved to the Local Preference file, which will take priority over the Global Preference file.

The shared computer locations for a Global Preference file are:

On Mac:

- From the Finder, click on Go/Computer/<System HD>/Users/Shared/AJA/ and copy or move the "com.aja.devicesettings file" described above to this location.

NOTE: The "AJA" folder needs to be created manually at this location before moving the preference file into it.

On Windows there are three possible shared locations depending on your system:

- C:\Users\Public\Aja\
- C:\Users\All Users\Aja\
- C:\ProgramData\Aja\

Copy or move the "com.aja.devicesettings file" described above to one of these locations.

NOTE: The AJA Control Panel Info screen displays the path to the Global Preference file on that computer.

NOTE: Clicking on the AJA Control Panel Erase All Prefs button does NOT delete an existing Global Preference file from this location.

T-TAP Pro Audio Monitoring

T-TAP Pro can be used as your single audio monitoring solution whether you are auditioning music in a web browser, playing a movie file on the desktop, creating music, or playing a YouTube clip. As long as the output of your work or application is normally output via the host system audio, your T-TAP Pro can route this audio for monitoring. This cuts down on unnecessary cabling, and means you can take advantage of a consistent audio monitoring environment whatever you are currently doing with your host system.

NOTE: On first use, you will need to tell your operating system to use AJA hardware as the default output hardware.

T-TAP Pro lets you listen to Host System audio concurrently with your NLE audio. This is useful if you need to audition music tracks against playback of your NLE timeline, or if you need to Skype with a remote producer during an edit session, or for a myriad of other reasons.

T-TAP Pro audio monitoring is routed and mixed using the Control Panel application's Audio Mixer screen. You can select sources, and can adjust their monitoring levels.

The mixed audio monitor signal is also routed to:

- SDI Embedded Audio out
- HDMI Embedded Audio Out

IMPORTANT: Even though you can hear changes in the signals and levels adjusted with the Audio Mixer screen, these changes are NOT recorded to disk during NLE Capture or Audio Punch In / Voice Over to Timeline. The Audio Mixer screen is dedicated for monitoring only, not program mixing.

Figure 8. T-TAP Pro Audio Monitoring Routing Diagram

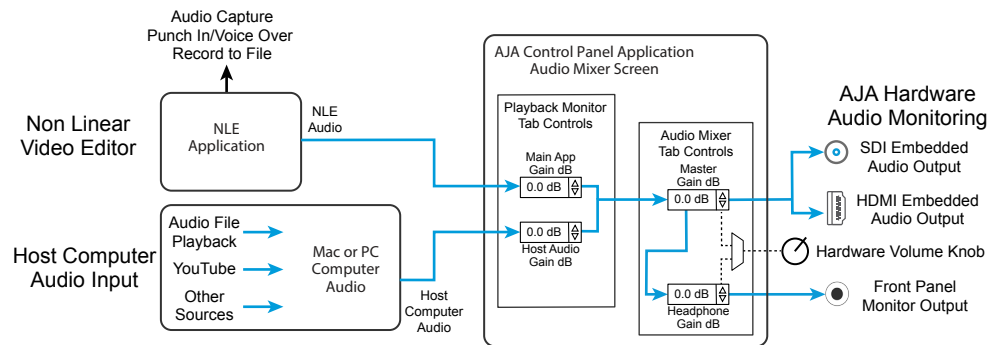

Control Screen

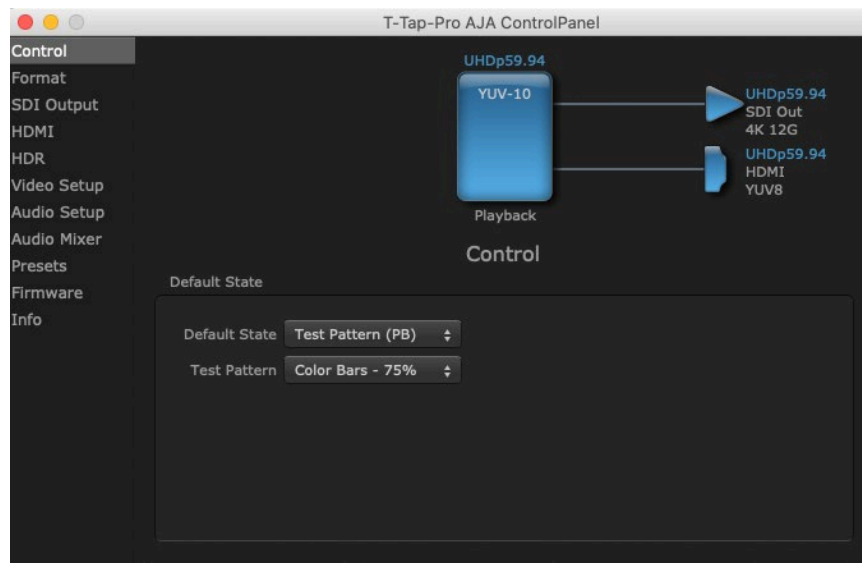

The T-TAP Pro can be controlled by various software applications running on a host computer. The Control Screen is where you select how the T-TAP Pro directs video and is used by application software. At the right-top of the block diagram it will show the current Default Output and the application currently controlling the T-TAP Pro.

Default State

This is where you select what T-TAP Pro will output as a default when no application has control of the board, such as when the Finder is active. Since T-TAP Pro can be controlled by multiple software applications and its own control panel, the output can change dynamically. When you select many video applications, they will grab control of the T-TAP Pro outputs. These settings determine what happens when an application that doesn't grab the T-TAP Pro outputs is active.

Test Pattern

With Test Pattern selected above, you can choose the pattern type. Select from:

- Black, Color bars (75% or 100%), Ramp, Multiburst, Line Sweep, Multi Pattern, or Flat Field, Check Field, White, Border, Linear Ramp, Slant Ramp, Zone Plate, Color Quadrant, or Color Quad Border.

For HD and UltraHD with RGB-12 Pixel Formats the following HDR test patterns are available:

- HDR Zone Plate, HDR Linear Ramp, HDR HLG Narrow, HDR PQ Narrow, or HDR PQ Wide.

Graphic File Display

In addition to the test patterns above, a "Load File..." selection at the bottom of the Test Pattern dropdown menu allows you to load a standard RGB/RGBA graphics file (.tif,.psd, etc.) into the frame buffer for display (including alpha channel). Some graphics formats and bit depths may not be supported. Files that have been loaded are listed for quick reuse. Loaded graphic files are retained for redisplay if another test pattern is selected, and even if T-TAP Pro is power cycled.

NOTE: A loaded graphics file will not be scaled to fit. If it's smaller than the current frame buffer format, T-TAP Pro will center it in the frame. If larger than the current frame buffer format it will be cropped.

- Clear Files - This selection on the pulldown clears all the Graphic Display files.

Hold Last App

Directs T-TAP Pro to hold and output the last frame of video from the last application to control T-TAP Pro. This can be helpful when operating in an environment where you're switching back and forth between multiple application windows.

Format Screen

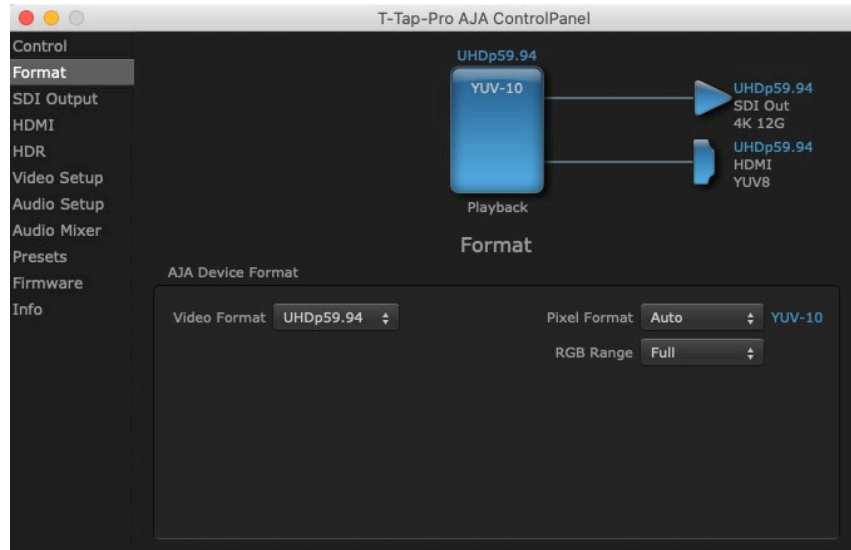

The Format screen shows the video format currently in use by the T-TAP Pro framebuffer (called the Primary Format) and allows you to change it. Throughout the Control Panel, choices are always presented based on what T-TAP Pro can do with the signals available and the outputs selected.

Video Format (Primary)

These pull-down menus show the currently selected formats. If you select an alternate value in the Primary Format using the pull-down, it will change the format used by T-TAP Pro's framebuffer. When a change is made via the Video Format pull-down or by clicking an icon (widget) and selecting a new format via a contextual menu, the block diagram will change to reflect the new format.

Pixel Format

Use this pulldown menu to choose from: YUV-10, YUV-8, ARGB-8, RGB-10, and RGB-12.

RGB Range

The RGB Range pulldown menu allows you to select either Full range (0-1023) or SMPTE range (typically 64-940) for RGB color output.

NOTE: *The AJA Control Panel software uses the abbreviation "sf" instead of "PsF" when referring to "progressive segmented frame" formats. In the manual and in other literature you may see either of these acronyms used interchangeably. Visually it is easier to discern at a glance if you are working with progressively segmented frame formats (sf in the AJA Control Panel) as compared to progressive frame formats which will show only "p."*

SDI Output Screen

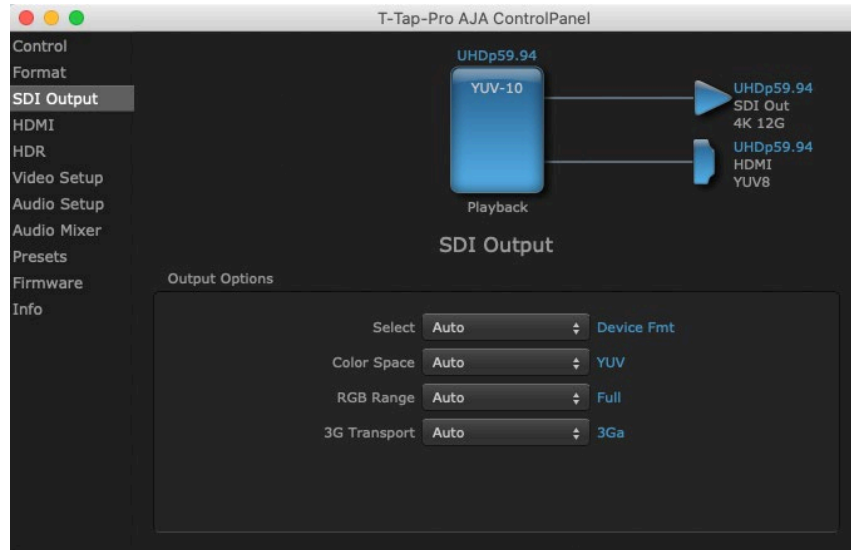

The SDI Out screen shows the current settings for the SDI output.

Output Options

Select

- Auto - Automatically selects the output format, based on the input or selected format.
- Device Format - Selects the framebuffer format for output.

Color Space

Sets the color space. Select from Auto, YUV, or RGB.

RGB Range

Sets the RGB range. Select from Auto, SMPTE, or Full.

3G Transport

Sets the output transport. Select from:

- Auto - Auto selection based on input or selected format
- 3Gb - Single link HD output using one BNC. The Level B-DS format is the dual-stream carriage of two independent HD-SDI/SMPTE 292M signals (720p up to 60 fps or 1080i/1080p up to 30 fps) in a single serial digital interface at the nominal 3 Gbit/s.
- 3Ga - Single link HD output using one BNC. The Level A format is the direct mapping of uncompressed 1080p (up to 60 fps) video into a serial digital interface at the nominal 3 Gbit/s.

HDMI Screen

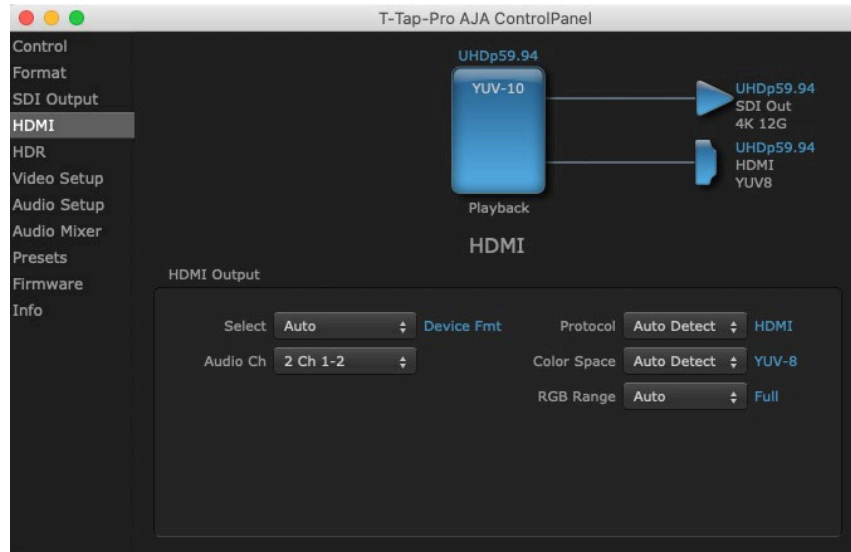

The T-TAP Pro's HDMI output is shown and configured in this screen.

Select

- Auto - Automatically selects the output format, based on the input or selected format.
- Device Format - Selects the framebuffer format for output.

Audio Ch

An Audio Channel pulldown allows you to select which audio channels will be embedded into T-TAP Pro's HDMI output. You can select a pair of channels, or eight audio channels.

Protocol

The Protocol pulldown allows you to choose either "HDMI" or "DVI" protocol. Use DVI if you are outputting to a DVI monitor using an HDMI to DVI adapter.

Color Space

Selects the HDMI output color space and depth. Select from:

- Auto Detect – (most reliable) AJA device attempt to reconfigure the HDMI output to match the current color space setting of the output monitor EDID. This option will be the most reliable in creating an output image. However, the output may result in an inferior image due to color space conversion and loss of bit depth.
- Auto Set – (best quality) The AJA device will attempt to automatically set the output monitor into the best color space and bit depth that matches the user's application needs regardless of EDID of the output monitor. This may result in loss of image if the output monitor does not support a specific color space mode.
- RGBA-8 – Forces the use of RGBA-8 regardless of the attached device's EDID or user application needs.
- RGB-10 – Forces the use of RGB-10 regardless of the attached device's EDID or user application needs.
- RGB-12 – Forces the use of RGB-12 regardless of the attached device's EDID or user application needs.

- YUV-8 – Forces the use of YUV-8 regardless of the attached device’s EDID or user application needs.
- YUV-10 – Forces the use of YUV-10 regardless of the attached device’s EDID or user application needs

RGB Range

(SMPTE or Full levels) The RGB Range pulldown menu allows you to select either Full range (0-1023) or SMPTE range (typically 64-940) for RGB color output.

HDR Screen

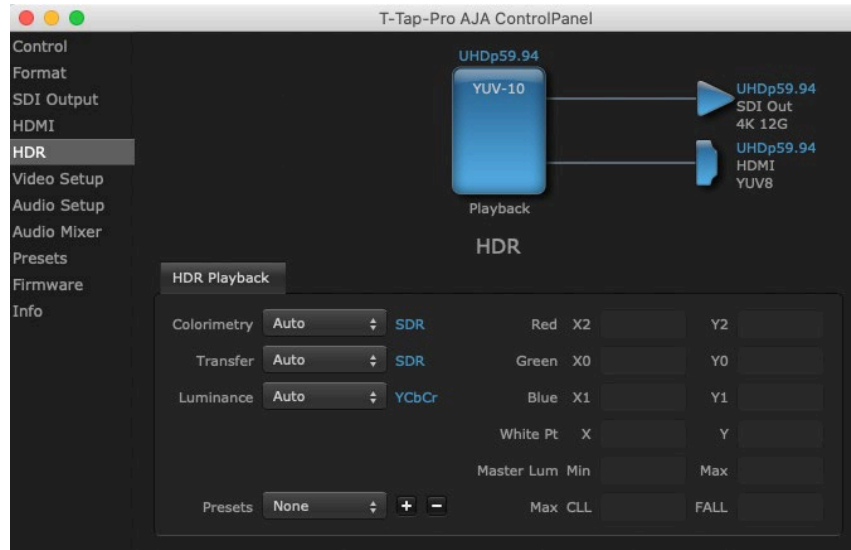

The HDR screen provides a sub tab setup for HDR playback simultaneously via both SDI and HDMI.

For SDI destinations, the HDR data is delivered in-band using VPID signaling for SDR/HDR Transfer Characteristics, Colorimetry and Luminance.

For HDMI destinations, side-band information is used to inform an HDMI sink device (such as a TV or monitor) that the video content is HDR. This includes generation of the Dynamic Range and Mastering Infoframe and the static metadata descriptors as defined in CTA-861.3 and HDMI v2.0a.

Included are preset primaries values for BT.2020 and DCI P3 color gamuts.

The HDR Playback tab settings affect what HDR metadata is included the T-TAP Pro’s HDMI and SDI outputs.

HDR Playback Settings

Colorimetry

- Auto - (default)
- SDR - Standard Dynamic Range
- P3 - P3 colorspace
- 2020 - BT.2020, typically used with HDR
- Custom - Allows custom values for the Digital Primaries.

Transfer

The Electrical Optical Transfer Function metadata bit tells the HDMI display which EOTF to use.

- Auto - (default)
- SDR - Standard Dynamic Range
- PQ - Perceptual Quantization
- HLG (Hybrid Log Gamma) - No meta-data for Digital Primaries.

Luminance

- Auto - (default)
- YCbCr - YCbCr color space
- ICtCp - IPT color space

Digital Primaries

Selecting Custom HDR Mode allows the editing of digital primaries information that is passed as metadata accompanying the video signal. However, when HLG selected as the EOTF digital primaries information cannot be edited, because HLG does not use metadata.

Display Mastering Luminance

Represents the minimum and maximum Display Mastering Luminance.

- Minimum: Defines the floor of the SMPTE ST 2086 color volume (in the case of HDR) and is determined by the mastering environment.
 - Range: 0.0000 cd/m² to 1.0000 cd/m².
 - Step size: 0.0002 cd/m².
- Maximum: Defines the ceiling of the SMPTE ST 2086 color volume (in the case of HDR) and is determined by the mastering environment.
 - Range: 1 cd/m² to 65535 cd/m².
 - Step size: 1 cd/m².

Maximum Content Light Level (CLL)

Represents the highest-value pixel component in an entire scene. It is determined by analyzing each frame of video, and can be determined in the post environment.

- Range: 1 cd/m² to 65535 cd/m².
- Step size: 1 cd/m².

Maximum Frame Average Light Level (FALL)

Represents the maximum of frame-based average light levels taken over an entire scene, and can be determined in the post environment.

- Range: 1 cd/m² to 65535 cd/m².
- Step size: 1 cd/m².

Video Setup Screen

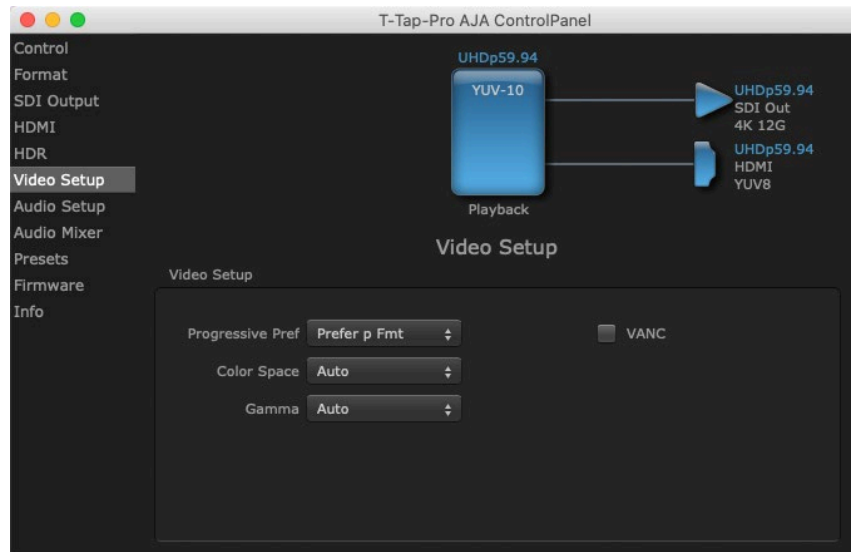

T-TAP Pro provides a high-quality digital video output in interlaced (i), progressive (p), or progressive segmented frame (PsF) formats. This screen shows the current settings for frame formatting of the digital video output, and allows you to re-configure it when desired.

Progressive Format

Choose between progressive (p) and progressive segmented frame (PsF) format for your digital output.

Color Space

Sets the video color space. Select from:

- Auto
- Rec 601
- Rec 709

Gamma

Sets the video gamma. Intended for use with legacy Apple displays. Select from:

- Auto
- Gamma 1.8

VANC Checkbox

When checked ON, the VANC checkbox tells T-TAP Pro to capture and process any ancillary data in the SDI stream. This can include Closed Captioning data, and other types of metadata. Applications such as Premiere Pro and Final Cut Pro will not capture or output this data through the KONA, if this box is not checked on.

Audio Setup Screen

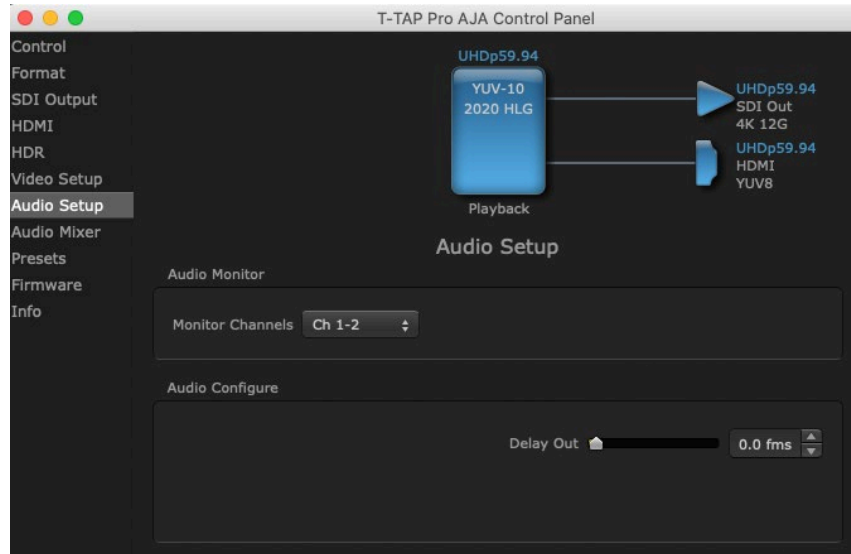

Audio Monitor

This control selects which pair of channels will be monitored through the audio out jack on the front of the T-TAP Pro. Select from:

- Ch 1-2 through Ch 15-16

Delay Out

Here you can set up to 6 frames (in tenths of a frame) of delay for the AJA device's audio output. The AJA Control Panel delays all audio outputs—SDI, HDMI, and audio monitoring. This feature is useful in compensating for the processing delay of a video monitor when audio is being monitored directly from the T-TAP Pro.

IMPORTANT: If you use this Control Panel delay, do not use other delay settings in your applications, as they can conflict with one another.

Audio Mixer Screen

The Audio Mixer screen has two tabs; Playback Monitor and Output Control. These tabs display what sources are available for monitoring and mixing via the T-TAP Pro's hardware.

The Playback Monitor tab lets you select audio sources available to your T-TAP Pro and mix them together. For example, you may have an audio output from your main application (e.g. NLE) and the audio from your host computer (USB Mic, Web Browser, MSTeams etc.). The Output Control tab lets you route that audio to the T-TAP Pro's SDI and HDMI embedded audio outputs, adjust that audio level, and also control the monitoring level of the T-TAP Pro's front panel Audio Out port.

The mixed audio output from the Playback Monitor tab screen is routed to the Mixer In item on the Output Control tab screen.

The selection check boxes and screen slider controls on these screens can affect the following T-TAP Pro audio outputs:

- Front Panel Audio Out (headphone jack)
- SDI Embedded Audio Out
- HDMI Embedded Audio Out

The branching arrow on the lower right of each screen indicates which sources are being routed and mixed. Arrow line segments are colored blue when active, and gray when muted.

Clicking an **On** checkbox selects the audio for that item for monitoring and/or embedded audio output. Multiple sources can be selected simultaneously.

Each level slider allows a simple plus or minus adjustment for that audio level. When activated, the source gain controls can be used to adjust the monitoring output gain of that source, from +6dB to - infinity (mute). Adjustment methods include:

- Sliders - The sliders on the right can be used to change the values for each color.
- Numeric Entry - You also enter a numeric value by clicking on the displayed number, and can increase or decrease the values clicking on the up/down arrow boxes.
- Cut and Paste - Right clicking on a displayed number opens a Cut, Copy, Paste dropdown menu for convenient numeric entry.

These controls change the audio being passed to the Output Control Tab. However, the levels in these meters do not follow the adjustments made; i.e. reducing the level to zero will still show levels in the interface.

Playback Monitor Tab

Figure 9. Audio Mixer Screen, Playback Monitor

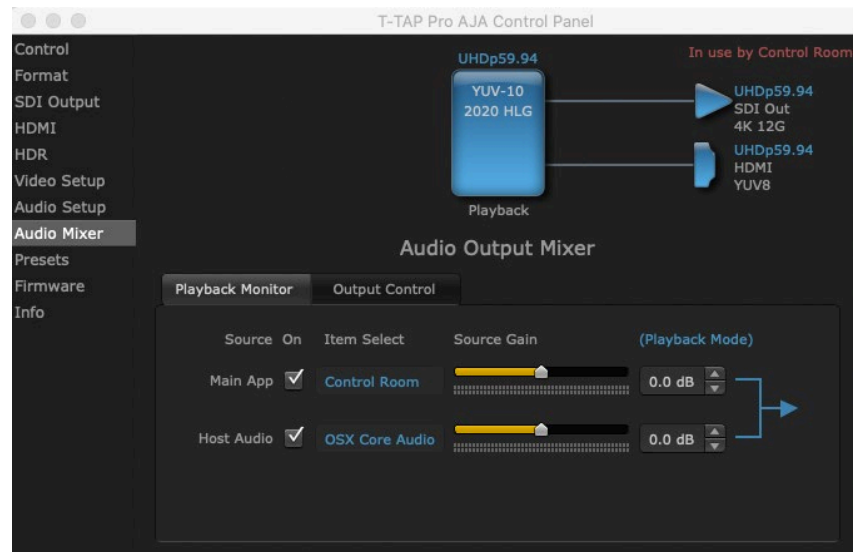

On Checkboxes

Clicking an **On** checkbox selects the audio for that item for monitoring and/or embedded audio output.

Source Gain and Confidence Meters

Meters display the input audio levels of the source, and are colored green when that source is On, and gray when Off. The levels shown on this screen tab do not change when the gain is adjusted, because the input level is being monitored, not the output. This enables you to tell immediately if you have source audio arriving at the AJA hardware (without having to launch any other software).

Main App

If an external application is controlling the T-TAP Pro, it will be displayed in the **Item Select** column and its audio can be selected for monitoring and/or embedded audio output level adjustment.

Host Audio

Audio from the host computer is selected here, enabling T-TAP Pro to monitor anything that would normally be presented via the host computer. For example, an editor could sample music from an online library, while concurrently playing back their NLE timeline. Or, a producer and editor could be communicating live during an editing session, using Skype or some other video calling tool.

Output Control Tab

Figure 10. Audio Mixer Screen, Output Control

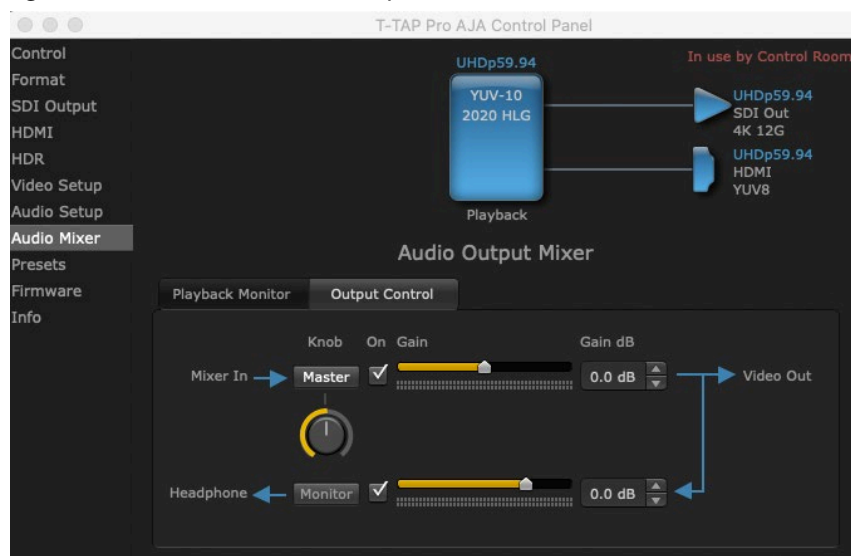

The controls on the Output Control screen tab are similar to those on the Playback Monitor screen tab, except these audio meters report the output of that selection, not the input, and so will change when these sliders are adjusted.

The arrows on the lower right shows the Mixer In audio routed to the Audio Out (headphone) jack on the T-TAP Pro is downstream of the Mixer In controls above, and so the audio level routed to that Audio Out jack is affected by both the Mixer in slider above and the Headphone slider below. And because the Mixer In signal comes from the Playback Monitor tab screen, level adjustments made on that screen tab can also affect the levels shown here.

NOTE: The Mixer In On checkbox, when unchecked, mutes the embedded (HDMI or SDI) audio output, but does not mute the Audio Out (Headphone) signal, to maintain headphone monitoring.

The Video Out audio signal is routed as embedded audio to the SDI and HDMI video outputs. This output level is always reported on the T-TAP Pro's front panel.

This screen tab also includes a software Knob control that is linked to the T-TAP Pro's front panel hardware knob.

Knob Control

The Master and Monitor buttons above and below the software knob delegates that knob to adjust either the audio level output coming from the Playback Monitor screen tab (Master), or to adjust only the audio level being sent to the T-TAP Pro's front panel Audio Out port (Monitor). These adjustments can be made using either the software knob on this screen, or the T-TAP Pro's front panel hardware Volume knob. The default for T-TAP Pro is for this control to be enabled for monitor (headphone) output only. So when you first install your device, you will be in no danger of unintentionally affecting your baseband output (only the headphone output will change).

Presets Screen

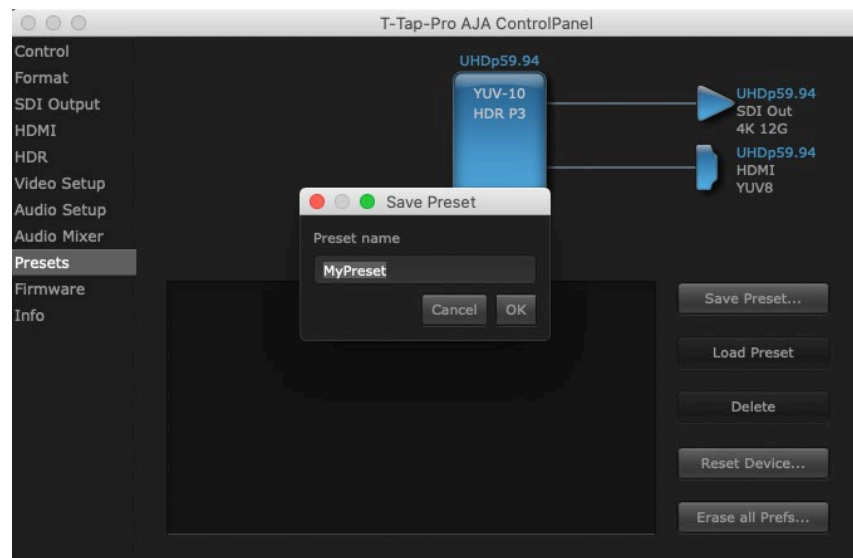

After configuring the AJA Control Panel screens, you can then save all your settings as a snapshot for later recall, called a preset. In this way, you can organize presets for all your typical tasks, eliminating manual reconfiguration.

Saving, Loading and Deleting Presets

To save a preset, simply go to the Presets screen and click "Save Preset". A dialog will be presented asking you for a file name. Enter a meaningful name and click "OK". Thereafter the preset will be available under the Control Panel "Presets" list.

From the Presets screen you can manage your collection of presets easily. To Load or Delete a stored preset, just select it with your mouse and then click the "Load Preset" or "Delete" button respectively .

Transferring Saved Presets

If you want to use a saved Preset on another workstation, you can simply copy the file on removable storage and install it at the new location. The Preset files are stored at:

Mac OS Preset Files Storage Location

- From the Finder, hold down the Option key (to display the Library directory) and click on Go/Library/Application Support/AJA/<device name>/Presets/

Windows Preset Files Storage Location

- c:\Users\

Reset to Default

When you click the "Reset Device" button the Default User Preference file will be deleted and AJA Control Panel will do one of the following:

- If a Default Global Preference is found, it is loaded and the device is set to this state.
- If a Default Global Preference file is not found, "factory defaults" are loaded and the device is set to this state.

NOTE: See "Default Preferences" on page 16 for more information.

Erase all Prefs

For technical support purposes you may be required to remove the current Preference settings. Clicking on the "Erase all Prefs" button deletes the current Default User Preference file without accessing a Default Global Preference file, if one exists. Current AJA device settings are not altered, but changing any setting will immediately regenerate a Default User Preference file with the changed settings.

NOTE: Clicking on the AJA Control Panel Erase All Prefs button does NOT delete an existing Global Preference file from that shared location.

Firmware Screen

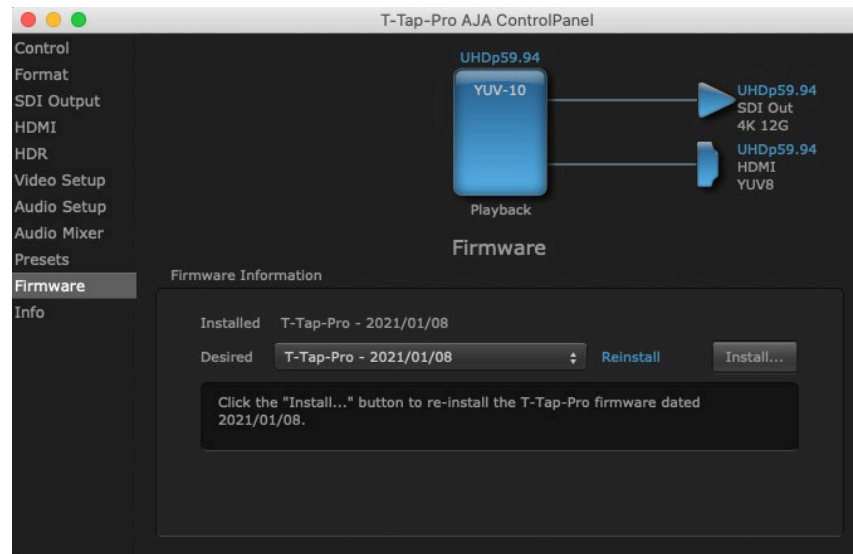

Use the Firmware Screen to access the firmware install screen. Click install to erase current firmware and load the firmware version contained in your current driver installation. Note the Installation message shown below.

You will be required to power-cycle your computer and T-TAP Pro to finish the update.

Figure 11. Update Completed



Info Screen

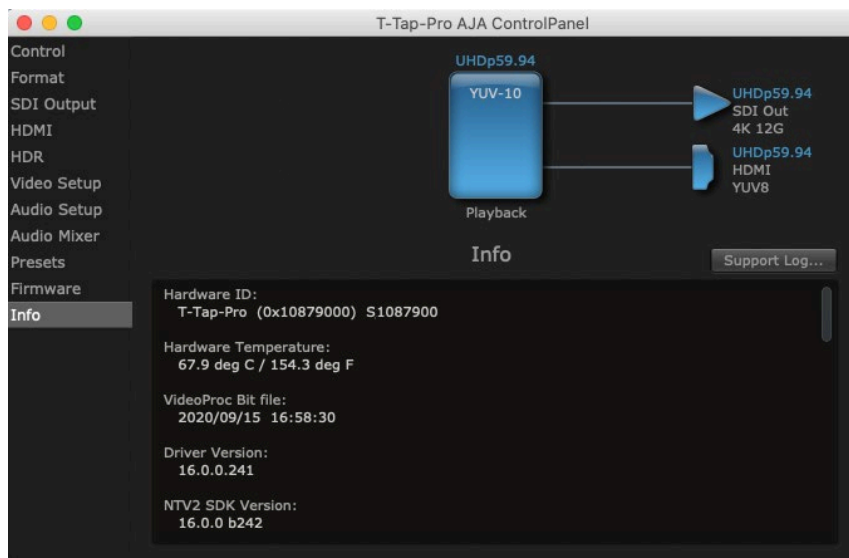

This screen shows the T-TAP Pro software files that have been installed on your system. This information may be needed if you talk to an AJA Customer Service representative to determine if files are missing or need updating

Appendix A – Specifications

T-TAP Pro Pro Tech Specs

Video Formats

- (4K) 4096 x 2160p 23.98, 24, 25, 29.97, 30, 47.95, 48, 50, 59.94, 60
- (UltraHD) 3840 x 2160p 23.98, 24, 25, 29.97, 30, 50, 59.94, 60
- (2K) 2048 x 1080p 23.98, 24, 25, 29.97, 30, 47.95, 48, 50, 59.94, 60
- (2K) 2048 x 1080PsF 23.98, 24, 25
- (HD) 1080p 23.98, 24, 25, 29.97, 30, 50, 59.94, 60
- (HD) 1080PsF 23.98, 24, 25, 29.97, 30
- (HD) 1080i 50, 59.94, 60
- (HD) 720p 50, 59.94, 60
- (SD) 625i 50
- (SD) 525i 59.94

Note: High Frame Rate and 4K/UltraHD capabilities are dependent on host system attributes. Not all systems and configurations will support all frame rates and raster sizes.

Video Outputs Digital

- 12G-SDI*, SMPTE-2082, 12-bit*, 10-bit
- 6G-SDI*, SMPTE-2081, 10-bit
- 3G-SDI, SMPTE 425
 - RGB 4:4:4 12-bit*, YCbCr 4:2:2 10-bit (Level A, Level B-DL)
- 1.5G-SDI, SMPTE 292M
 - Single Link HD-SDI YCbCr 4:2:2 10-bit
- 270 Mbps SDI, SMPTE 259M-C
 - YCbCr 4:2:2 10-bit, 8-bit
- HDMI v2.0
 - 30/36-bits/pixel, RGB or YUV, 6 Gbps per color component
 - 4K, UltraHD, 2K, HD and SD with HFR support up to 60p (4:2:2), 10-bit and 8-bit

*Bit depth support is application dependent. Check with your software manufacturer for compatibility.

HDR

- SDI: VPID signaling for SDR/HDR Transfer Characteristics, Colorimetry and Luminance
- HDMI: HDR10 Support - HDR Infotone metadata, compatible with HDMI 2.0a/CTA-861.3
- HDMI: HLG Support - compatible with HDMI 2.0b/CTA-861-G

Note: HDR support is application dependent. Check with your software manufacturer for compatibility.

Audio Outputs Digital

- 16-channel, 24-bit SDI embedded audio, 48 kHz sample rate, synchronous
- 8-channel, 24-bit HDMI embedded audio, 48 kHz sample rate, synchronous

Audio Outputs Analog

- 2-channel, 18-bit D/A analog audio, 48 kHz sample rate, unbalanced, using standard 3.5mm jack
- 1.2V RMS full scale digital output level (0 dBFS)

Size (w x d x h)

- 5.0" x 1.0" x 5.0" (127.0 x 25.4 x 127.0 mm)

Weight

- .06 lb (0.23 kg)

Power

- 18W Max

Environment

- Safe Operating Temperature: 0 to 35 C (32 to 95 F)
- Safe Storage Temperature (Power OFF): -40 to 60 C (-40 to 140 F)
- Operating Relative Humidity: 10-90% noncondensing
- Operating Altitude: <3,000 meters (<10,000 feet)

Appendix B – Safety and Compliance

Federal Communications Commission (FCC) Compliance Notices

Class A Interference Statement

This equipment has been tested and found to comply with the limits for a Class A digital device, pursuant to Part 15, Subpart B of the FCC Rules. These limits are designed to provide reasonable protection against harmful interference in a residential installation. This equipment generates, uses, and can radiate radio frequency energy and, if not installed and used in accordance with the instructions, may cause harmful interference to radio communications. However, there is no guarantee that interference will not occur in a particular installation. If this equipment does cause harmful interference to radio or television reception, which can be determined by turning the equipment off and on, the user is encouraged to try to correct the interference by one or more of the following measures:

- Reorient or relocate the receiving antenna.
- Increase the separation between the equipment and receiver.
- Connect the equipment into an outlet on a circuit different from that to which the receiver is connected.
- Consult the dealer or an experienced radio/TV technician for help.

Canadian ICES Statement

Canadian Department of Communications Radio Interference Regulations

This digital apparatus does not exceed the Class A limits for radio-noise emissions from a digital apparatus as set out in the Radio Interference Regulations of the Canadian Department of Communications. This Class A digital apparatus complies with Canadian ICES-003.

Règlement sur le brouillage radioélectrique du ministère des Communications

Cet appareil numérique respecte les limites de bruits radioélectriques visant les appareils numériques de classe A prescrites dans le Règlement sur le brouillage radioélectrique du ministère des Communications du Canada. Cet appareil numérique de la Classe A est conforme à la norme NMB-003 du Canada.

European Union and European Free Trade Association (EFTA) Regulatory Compliance

This equipment may be operated in the countries that comprise the member countries of the European Union and the European Free Trade Association. These countries, listed in the following paragraph, are referred to as The European Community throughout this document:

AUSTRIA, BELGIUM, BULGARIA, CYPRUS, CZECH REPUBLIC, DENMARK, ESTONIA, FINLAND, FRANCE, GERMANY, GREECE, HUNGARY, IRELAND, ITALY, LATVIA, LITHUANIA, LUXEMBOURG, MALTA, NETHERLANDS, POLAND, PORTUGAL, ROMANIA, SLOVAKIA, SLOVENIA, SPAIN, SWEDEN, UNITED KINGDOM, ICELAND, LICHTENSTEIN, NORWAY, SWITZERLAND

Declaration of Conformity

Marking by this symbol indicates compliance with the Essential Requirements of the EMC Directive of the European Union 2014/30/EU.



This equipment meets the following conformance standards:

Safety:

IEC 62368-1: 2014 + A11, EN 60065: 2014 + A11 (T-Mark Licenses),
EN 62368-1: 2014, IEC 60065: 2014 (CB Scheme Report/Certificates)
Additional licenses issued for specific countries available on request.

Emissions:

EN 55032: 2015, CISPR 32: 2015
EN 61000-3-2: 2014, EN 61000-3-3: 2013

Immunity:

EN 55103-2: 2009
EN 61000-4-2: 2009, EN 61000-4-3: 2006+A1: 2008+A2: 2010, EN 61000-4-4: 2012,
EN 61000-4-5: 2014 + A1: 2017, EN 61000-4-6: 2013, EN 61000-4-11: 2020

Environments: E2, E3 and E4

The product is also licensed for additional country specific standards as required for the International Marketplace.



Warning! This is a Class A product. In a domestic environment, this product may cause radio interference, in which case, the user may be required to take appropriate measures.

Achtung! Dieses ist ein Gerät der Funkstörgrenzwertklasse A. In Wohnbereichen können bei Betrieb dieses Gerätes Rundfunkstörungen auftreten, in welchen Fällen der Benutzer für entsprechende Gegenmaßnahmen verantwortlich ist.

Attention! Ceci est un produit de Classe A. Dans un environnement domestique, ce produit risque de créer des interférences radioélectriques, il appartiendra alors à l'utilisateur de prendre les mesures spécifiques appropriées..

Recycling Notice



This symbol on the product or its packaging indicates that this product must not be disposed of with your other household waste. Instead, it is your responsibility to dispose of your waste equipment by handing it over to a designated collection point for the recycling of waste electrical and electronic equipment. The separate collection and recycling of your waste equipment at the time of disposal will help conserve natural resources and ensure that it is recycled in a manner that protects human health and the environment. For more information about where you can drop off your waste for recycling, please contact your local authority, or where you purchased your product.

Korea KCC Compliance Statement

사용자 안내문

이 기기는 업무용 환경에서 사용할 목적으로 적합성평가를 받은 기기로서 가정용 환경에서 사용하는 경우 전파간섭의 우려가 있습니다.

Taiwan Compliance Statement

警告使用者：
這是甲類的資訊產品，在居住的環境中使用時，可能會造成射頻干擾，在這種情況下，使用者會被要求採取某些適當的對策。

This is a Class A product based on the standard of the Bureau of Standards, Metrology and Inspection (BSMI) CNS 13438, Class A. In a domestic environment this product may cause radio interference in which case the user may be required to take adequate measures.

Japan Compliance Statement

この装置は、クラスA情報技術装置です。この装置を家庭環境で使用すると電波妨害を引き起こすことがあります。この場合には使用者が適切な対策を講ずるよう要求されることがあります。 VCCI-A

This is a Class A product based on the standard of the VCCI Council (VCCI 32: 2016). If this equipment is used in a domestic environment, radio interference may occur, in which case, the user may be required to take corrective actions.

Translated Warning and Caution Messages

The following caution statements, warning conventions, and warning messages apply to this product and manual.



Warning Symbol



Caution Symbol

Before Operation Please Read These Instructions



Warning! Read and follow all warning notices and instructions marked on the product or included in the documentation.

Avertissement! Lisez et conformez-vous à tous les avis et instructions d'avertissement indiqués sur le produit ou dans la documentation.

Warnung! Lesen und befolgen Sie die Warnhinweise und Anweisungen, die auf dem Produkt angebracht oder in der Dokumentation enthalten sind.

¡Advertencia! Lea y siga todas las instrucciones y advertencias marcadas en el producto o incluidas en la documentación.

Aviso! Leia e siga todos os avisos e instruções assinalados no produto ou incluídos na documentação.

Avviso! Leggere e seguire tutti gli avvisi e le istruzioni presenti sul prodotto o inclusi nella documentazione.



Warning! Do not use this device near water and clean only with a dry cloth.

Avertissement! N'utilisez pas cet appareil près de l'eau et nettoyez-le seulement avec un tissu sec.

Warnung! Das Gerät nicht in der Nähe von Wasser verwenden und nur mit einem trockenen Tuch säubern.

¡Advertencia! No utilice este dispositivo cerca del agua y límpielo solamente con un paño seco.

Aviso! Não utilize este dispositivo perto da água e limpe-o somente com um pano seco.

Avviso! Non utilizzare questo dispositivo vicino all'acqua e pulirlo soltanto con un panno asciutto.



Warning! Do not block any ventilation openings. Install in accordance with the manufacturer's instructions.

Avertissement! Ne bloquez aucune ouverture de ventilation. Suivez les instructions du fabricant lors de l'installation.

Warnung! Die Lüftungsöffnungen dürfen nicht blockiert werden. Nur gemäß den Anweisungen des Herstellers installieren.

¡Advertencia! No bloquee ninguna de las aberturas de la ventilación. Instale de acuerdo con las instrucciones del fabricante.

Aviso! Não obstrua nenhuma das aberturas de ventilação. Instale de acordo com as instruções do fabricante.

Avviso! Non ostruire le aperture di ventilazione. Installare in conformità con le istruzioni del fornitore.



Warning! Do not install near any heat sources such as radiators, heat registers, stoves, or other apparatus (including amplifiers) that produce heat.

Avertissement! N'installez pas l'appareil près d'une source de chaleur telle que des radiateurs, des bouches d'air de chauffage, des fourneaux ou d'autres appareils (amplificateurs compris) qui produisent de la chaleur.

Warnung! Nicht in der Nähe von Wärmequellen wie Heizkörpern, Heizregistern, Öfen oder anderen Wärme erzeugenden Geräten (einschließlich Verstärkern) aufstellen.

¡Advertencia! No instale cerca de fuentes de calor tales como radiadores, registros de calor, estufas u otros aparatos (incluidos amplificadores) que generan calor.

Aviso! Não instale perto de nenhuma fonte de calor tal como radiadores, saídas de calor, fogões ou outros aparelhos (incluindo amplificadores) que produzam calor.

Avviso! Non installare vicino a fonti di calore come termosifoni, diffusori di aria calda, stufe o altri apparecchi (amplificatori compresi) che emettono calore



Warning! Since the Mains plug is used as the disconnection for the device, it must remain readily accessible and operable.

Avertissement! Puisque la prise principale est utilisée pour débrancher l'appareil, elle doit rester aisément accessible et fonctionnelle.

Warnung! Da der Netzstecker als Trennvorrichtung dient, muss er stets zugänglich und funktionsfähig sein.

¡Advertencia! Puesto que el enchufe de la red eléctrica se utiliza como dispositivo de desconexión, debe seguir siendo fácilmente accesible y operable.

Aviso! Dado que a ficha principal é utilizada como a desconexão para o dispositivo, esta deve manter-se prontamente acessível e funcional.

Avviso! Poiché il cavo di alimentazione viene usato come dispositivo di sconnessione, deve rimanere prontamente accessibile e operabile.



Warning! Protect the power cord from being walked on or pinched particularly at plugs, convenience receptacles, and the point where they exit from the device.

Avertissement! Protégez le cordon d'alimentation pour que l'on ne marche pas dessus ou qu'on le pince, en particulier au niveau des prises mâles, des réceptacles de convenance, et à l'endroit où il sort de l'appareil.

Warnung! Vermeiden Sie, dass auf das Netzkabel getreten oder das Kabel geknickt wird, insbesondere an den Steckern, den Steckdosen und am Kabelausgang am Gerät.

¡Advertencia! Proteja el cable de energía para que no se le pise ni apriete, en especial cerca del enchufe, los receptáculos de conveniencia y el punto del que salen del equipo.

Aviso! Proteja o cabo de alimentação de ser pisado ou de ser comprimido particularmente nas fichas, em tomadas de parede de conveniência e no ponto de onde sai do dispositivo.

Avviso! Proteggere il cavo di alimentazione in modo che nessuno ci cammini sopra e che non venga schiacciato soprattutto in corrispondenza delle spine e del punto in cui esce dal dispositivo.



Warning! Unplug this device during lightning storms or when unused for long periods of time.

Avertissement! Débranchez cet appareil pendant les orages avec éclairsoù s'il est inutilisé pendant de longues périodes.

Warnung! Das Gerät ist bei Gewitterstürmen oder wenn es über lange Zeiträume ungenutzt bleibt vom Netz zu trennen.

¡Advertencia! Desenchufe este dispositivo durante tormentas eléctricas o cuando no se lo utilice por largos periodos del tiempo.

Aviso! Desconecte este dispositivo da tomada durante trovoadas ou quando não é utilizado durante longos períodos de tempo.

Avviso! Utilizzare soltanto i collegamenti e gli accessori specificati e/o venduti dal produttore, quali il treppiedi e l'esoscheletro.



Warning! Do not open the chassis. There are no user-serviceable parts inside. Opening the chassis will void the warranty unless performed by an AJA service center or licensed facility.

Avertissement! Ne pas ouvrir le châssis. Aucun élément à l'intérieur du châssis ne peut être réparé par l'utilisateur. La garantie sera annulée si le châssis est ouvert par toute autre personne qu'un technicien d'un centre de service ou d'un établissement agréé AJA.

Warnung! Öffnen Sie das Gehäuse nicht. Keine der Geräteteile können vom Benutzer gewartet werden. Durch das Öffnen des Gehäuses wird die Garantie hinfällig, es sei denn, solche Wartungsarbeiten werden in einem AJA-Service-Center oder einem lizenzierten Betrieb vorgenommen.

¡Advertencia! No abra el chasis. El interior no contiene piezas reparables por el usuario. El abrir el chasis anulará la garantía a menos que se lo haga en un centro de servicio AJA o en un local autorizado.

Advertência! Não abra o chassi. Não há internamente nenhuma peça que permita manutenção pelo usuário. Abrir o chassi anula a garantia, a menos que a abertura seja realizada por uma central de serviços da AJA ou por um local autorizado.

Avvertenza! Non aprire lo chassis. All'interno non ci sono parti riparabili dall'utente. L'apertura dello chassis invaliderà la garanzia se non viene effettuata da un centro ufficiale o autorizzato AJA.



Warning! Disconnect the external AC power supply line cord(s) from the mains power before moving the unit.

Avertissement! Retirez le ou les cordons d'alimentation en CA de la source d'alimentation principale lorsque vous déplacez l'appareil.

Warnung! Trennen Sie die Wechselstrom-Versorgungskabel vom Netzstrom, bevor Sie das Gerät verschieben.

¡Advertencia! Cuando mueva la unidad desenchufe de la red eléctrica el/los cable(s) de la fuente de alimentación CA tipo brick.

Advertência! Remova os cabos CA de alimentação brick da rede elétrica ao mover a unidade.

Avvertenza! Scollegare il cavo dell'alimentatore quando si sposta l'unità.



Warning! Only use attachments and accessories specified and/or sold by the manufacturer.

Avertissement! Utilisez seulement les attaches et accessoires spécifiés et/ou vendus par le fabricant.

Warnung! Verwenden Sie nur Zusatzgeräte und Zubehör angegeben und / oder verkauft wurde durch den Hersteller.

¡Advertencia! Utilice solamente los accesorios y conexiones especificados y/o vendidos por el fabricante.

Aviso! Utilize apenas equipamentos/acessórios especificados e/ou vendidos pelo fabricante.

Avviso! Utilizzare soltanto i collegamenti e gli accessori specificati e/o venduti dal produttore.



Warning! Refer all servicing to qualified service personnel. Servicing is required when the device has been damaged in any way, such as power-supply cord or plug is damaged, liquid has been spilled or objects have fallen into the device, the device has been exposed to rain or moisture, does not operate normally, or has been dropped.

Avertissement! Référez-vous au personnel de service qualifié pour tout entretien. L'entretien est exigé quand l'appareil a été endommagé de quelque manière que ce soit, par exemple lorsque le cordon d'alimentation ou la prise sont endommagés, que du liquide a été versé ou des objets sont tombés dans l'appareil, que l'appareil a été exposé à la pluie ou à l'humidité, ne fonctionne pas normalement ou est tombé.

Warnung! Das Gerät sollte nur von qualifizierten Fachkräften gewartet werden. Eine Wartung ist fällig, wenn das Gerät in irgendeiner Weise beschädigt wurde, wie bei beschädigtem Netzkabel oder Netzstecker, falls Flüssigkeiten oder Objekte in das Gerät gelangen, das Gerät Regen oder Feuchtigkeit ausgesetzt wurde, nicht ordnungsgemäß funktioniert oder fallen gelassen wurde.

¡Advertencia! Consulte al personal calificado por cuestiones de reparación. El servicio de reparación se requiere cuando el dispositivo ha recibido cualquier tipo de daño, por ejemplo cable o espigas dañadas, se ha derramado líquido o se han caído objetos dentro del dispositivo, el dispositivo ha sido expuesto a la lluvia o humedad, o no funciona de modo normal, o se ha caído.

Aviso! Remeta todos os serviços de manutenção para o pessoal de assistência qualificado. A prestação de serviços de manutenção é exigida quando o dispositivo foi danificado mediante qualquer forma, como um cabo de alimentação ou ficha que se encontra danificado/a, quando foi derramado líquido ou caíram objectos sobre o dispositivo, quando o dispositivo foi exposto à chuva ou à humidade, quando não funciona normalmente ou quando foi deixado cair.

Avviso! Fare riferimento al personale qualificato per tutti gli interventi di assistenza. L'assistenza è necessaria quando il dispositivo è stato danneggiato in qualche modo, ad esempio se il cavo di alimentazione o la spina sono danneggiati, è stato rovesciato del liquido è stato rovesciato o qualche oggetto è caduto nel dispositivo, il dispositivo è stato esposto a pioggia o umidità, non funziona correttamente o è caduto

Warranty and Liability Information

Limited Warranty on Hardware

AJA Video Systems, Inc. (AJA Video) warrants that the hardware product, not including storage modules or software components, will be free from defects in materials and workmanship for a period of three years from the date of purchase. AJA Video warrants that the storage modules provided as part of the hardware product will be free from defects in materials and workmanship for a period of one year from the date of purchase. AJA Video provides a separate software warranty as part of the license agreement applicable to software components.

If the Customer brings a valid claim under this limited warranty for a hardware product or storage module (hereafter, a "product") during the applicable warranty period, AJA Video will, at its sole option and as the Customer's sole remedy for breach of the above warranty, provide one of the following remedies:

- Repair or facilitate the repair the product within a reasonable period of time, free of charge for parts and labor.
- Replace the product with a direct replacement or with a product that performs substantially the same function as the original product.
- Issue a refund of the original purchase price less depreciation to be determined based on the age of the product at the time remedy is sought under this limited warranty.

To obtain service under this warranty, the Customer must notify AJA Video of the defect before expiration of the warranty period and make suitable arrangements for the performance of service by contacting AJA Video support through the channels set forth on the support contacts web page at <https://www.aja.com/support>.

Except as stated, the Customer shall bear all shipping, packing, insurance and other costs, excluding parts and labor, to effectuate repair. Customer shall pack and ship the defective product to a service center designated by AJA Video, with shipping charges prepaid. AJA Video shall pay to return the product to Customer, but only if to a location within the country in which the AJA Video service center is located. SOME JURISDICTIONS DO NOT ALLOW THE EXCLUSION OF IMPLIED WARRANTIES OR LIMITATIONS ON APPLICABLE STATUTORY RIGHTS OF A CONSUMER, SO SOME OR ALL OF THE TERMS OF THIS PARAGRAPH MAY NOT APPLY TO YOU.

Limitation of Liability

Under no circumstances shall AJA video BE LIABLE IN ANY WAY FOR ANY LOST, CORRUPTED OR DESTROYED DATA, FOOTAGE OR WORK, OR FOR ANY OTHER INDIRECT, SPECIAL, INCIDENTAL OR CONSEQUENTIAL DAMAGES OR LOST PROFITS, OR FOR ANY THIRD PARTY CLAIM, IN CONNECTION WITH THE PRODUCT, WHETHER RESULTING FROM DEFECTS IN THE PRODUCT, SOFTWARE OR HARDWARE FAILURE, OR ANY OTHER CAUSE WHATSOEVER, EVEN IF AJA VIDEO HAS BEEN ADVISED OF THE POSSIBILITY OF SUCH DAMAGES. AJA VIDEO'S LIABILITY IN CONNECTION WITH THE PRODUCT SHALL UNDER NO CIRCUMSTANCES EXCEED THE PURCHASE PRICE PAID FOR THE PRODUCT. The foregoing limitations apply even if any remedy set forth in this LIMITED WARRANTY fails of its essential purpose. SOME JURISDICTIONS DO NOT ALLOW THE LIMITATION OF LIABILITY FOR PERSONAL INJURY, OR OF INCIDENTAL OR CONSEQUENTIAL DAMAGES, SO SOME OR ALL OF THE TERMS OF THIS PARAGRAPH MAY NOT APPLY TO YOU.

Governing Law and Language; Your Rights

This limited warranty is the only warranty provided by AJA Video on the hardware product. It supersedes all prior or contemporaneous understandings regarding such subject matter. No amendment to or modification of this warranty will be binding unless in writing and signed by AJA Video. The laws of the State of California, USA will govern this warranty and any dispute arising from it. Any translation of this Agreement is intended for convenience and to meet local requirements and in the event of a dispute between the English and any non-English versions, the English version of this warranty will govern. This limited warranty gives you specific legal rights and you may have other rights that vary from jurisdiction to jurisdiction, some of which are noted above.

Index

Symbols

- 3G Transport 21
- 3rd-Party Plugins 6

A

- AJA Control Panel 5
 - Block Diagram 14
 - Overview 13
- AJA Control Room 5
- AJA Software 5
- AJA Support 2
- AJA System Test 6
- AJA Utilities 5
- Audio Channels 22
- Audio Gain Control Knob 7
- Audio Level Meter 7
- Audio Mixer Screen 26
- Audio Monitor 26
- Audio Monitoring 17
- Audio Monitoring Routing Diagram 18
- Audio Output Connector 7
- Audio Setup Screen 26

B

- Block Diagram
 - AJA Control Panel 14
- Block Diagram Area 13

C

- Cable Connections 7
- Colorimetry 23
- Color Meanings 15
- Color Space 21, 22, 25
- Control Panel 5
 - Block Diagram Area 13
- Control Room 5
- Control Screen 18

D

- Default Preferences 16
- Default State 19
- Delay Out 26
- Delete Preset 29
- Digital Primaries 24
- Display Mastering Luminance 24

E

- Erase all Prefs 30

F

- Features 4
- Firmware Screen 31
- Firmware Update 12
- Format Screen 20
- Framebuffer 14

G

- Gamma 25
- Global Preference 17
- Global Preference File Location 17
- Graphic File Display 19

H

- HDMI Output 9
- HDMI Screen 22
- HDR Playback Settings 23
- HDR Screen 23
- Heat Dissipation 11
- Hold Last App 19
- Host Audio 28

I

- Info Screen 32
- Installation Overview 10

K

- Knob Control 29

L

- Load Preset 29
- Local Preference 16
- Local Preference File 16
- Luminance 24

M

- Main App 28
- Maximum Content Light Level (CLL) 24
- Maximum Frame Average Light Level (FALL) 24

O

- On Checkbox 27
- Output Control Tab 28
- Output Icons 15
- Overview 4

P

- Pixel Format 20
- Playback Monitor Tab 27
- Power Connection Status LED 8
- Power Requirements 11
- Power Supply
 - External 9
- Power Supply Module 9
- Preference 16
- Preference File Location
 - Default Global 17
- Preset
 - Delete 29
 - Load 29
 - Save 29

- Preset Files Storage Location 16, 30
- Presets 16
- Presets Screen 29
- Primary Format 15, 20
- Progressive Format 25
- Protocol 22

R

- Reset to Default 30
- RGB Range 20, 21, 23

S

- Save Preset 29
- SDI Output Screen 21
- Snapshot 29
- Software 5
- Software Installation 11
- Source Gain 28
- System Requirements 6
- System Test 6

T

- Technical Support 2
- Test Pattern 19
- Thunderbolt 8
- Transfer 24
- Transferring Saved Presets 30

U

- Unpacking T-TAP 10
- Updating T-TAP Firmware 12
- Utilities 5

V

- VANC Checkbox 25
- Video Format (Primary) 20
- Video Setup Screen 25
- Video Signal Formats 5