

# MIPRO®

## User Guide

MA-303DB / MA-303SB  
Personal Wireless PA System

MA-303DG / MA-303SG  
5.8 GHz Personal Wireless PA System





# ! IMPORTANT SAFETY INSTRUCTIONS !

1. Read these instructions.
2. Keep these instructions.
3. Heed all warnings.
4. Follow all instructions.
5. Do not use this apparatus near water.
6. Clean only with a dry cloth.
7. Do not block any ventilation openings. Install in accordance with the manufacturer's instructions.
8. Do not install near any heat sources such as radiators, heat registers, stoves, or other apparatus (including amplifiers) that produce heat.
9. Do not defeat the safety purpose of the polarised or ground plug: A polarised plug has two blades with one wider than the other. The wide blade is provided for your safety. When the provided plug does not fit into your outlet, consult an electrician for replacement of the obsolete outlet.
10. Protect the power cord from being walked on or pinched particularly at plug, convenience receptacles, and the point where they exit from the apparatus.
11. Only use attachments/accessories specified by the manufacturer.
12. Use only with a cart, stand, tripod, bracket, or table specified by the manufacturer, or sold with the apparatus. When a cart is used, use caution when moving the cart/apparatus combination to avoid injury from tip-over.
13. Unplug this apparatus during lightning storms or when unused for long periods of time.
14. Refer all servicing to qualified service personnel. Servicing is required when the apparatus has been damaged in any way, such as power-supply cord or plug is damaged, liquid has been spilled or objects have fallen into the apparatus, the apparatus has been exposed to rain or moisture, does not operate normally, or has been dropped.
15. To reduce the risk of fire or electric shock, do not expose this apparatus to rain or moisture.
16. Apparatus should not be exposed to dripping or splashing and no objects filled with liquids, should be placed on the apparatus.
17. Use only with the battery which specified by manufacturer.
18. The power supply cord set is to be the main disconnected device.



**R** 201-180636

# WARNING

## 1. FOR OUTDOOR USE:



To reduce the risk of fire or electric shock, do not expose this apparatus to rain or moisture.

## 2. UNDER WET LOCATION:

Apparatus should not be exposed to dripping or splashing and no objects filled with liquids, such as vases should be placed on the apparatus.

## 3. SERVICE INSTRUCTIONS:

CAUTION - These servicing instructions are for use by qualified service personnel only. To reduce the risk of electric shock, do not perform any servicing other than that contained in the operating instructions unless you are qualified to do so.

	
	This symbol indicates that dangerous voltage constituting a risk of electric shock is present within this unit.
	This symbol indicates that there are important operating and maintenance instructions in the literature accompanying this unit.

## FC & IC - ID

THIS DEVICE COMPLIES WITH PART 15 OF THE FCC RULES AND RSS-123 ISSUE 2 OF CANADA. OPERATION IS SUBJECT TO THE FOLLOWING TWO CONDITIONS:

(1) This device may not cause interference.

(2) This device must accept any interference, including interference that may cause undesired operation of the device. This equipment complies with FCC RF radiation exposure limits set forth for an uncontrolled environment.



"This product can only be used at the area that the altitude is lower than 2000m for safety purpose."



"This product can be used in non-tropical locations only for safety purpose."

## Disposal

Dispose of any unusable devices or batteries responsibly and in accordance with any applicable regulations.



Disposing of used batteries with domestic waste is to be avoided!

Batteries / NiCad cells often contain heavy metals such as cadmium (Cd), mercury (Hg) and lead (Pb) that makes them unsuitable for disposal with domestic waste. You may return spent batteries/ accumulators free of charge to recycling centres or anywhere else batteries/accumulators are sold.

2005-08-13

By doing so, you contribute to the conservation of our environment!

## Federal Communication Commission Interference Statement

This equipment has been tested and found to comply with the limits for a Class B digital device, pursuant to Part 15 of the FCC Rules. These limits are designed to provide reasonable protection against harmful interference in a residential installation.

This equipment generates, uses and can radiate radio frequency energy and, if not installed and used in accordance with the instructions, may cause harmful interference to radio communications. However, there is no guarantee that interference will not occur in a particular installation. If this equipment does cause harmful interference to radio or television reception, which can be determined by turning the equipment off and on, the user is encouraged to try to correct the interference by one of the following measures:

- . Reorient or relocate the receiving antenna.
- . Increase the separation between the equipment and receiver.
- . Connect the equipment into an outlet on a circuit different from that to which the receiver is connected.
- . Consult the dealer or an experienced radio/TV technician for help.

FCC Caution: To assure continued compliance, any changes or modifications not expressly approved by the party responsible for compliance could void the user's authority to operate this equipment. (Example - use only shielded interface cables when connecting to computer or peripheral devices).

End Product Labeling

This transmitter module is authorized only for use in devices where the antenna may be installed such that 20 cm may be maintained between the antenna and users. The final end product must be labeled in visible area with the following: " Contains FCC ID: M5X- KB64ABC "

End Product Manual Information

The user manual for end users must include the following information in a prominent location "IMPORTANT NOTE: To comply with FCC RF exposure compliance requirements, the antenna used for this transmitter must be installed to provide a separation distance of at least 20cm from all persons and must not be colocated or operating in conjunction with any other antenna or transmitter. " This device complies with part 15 of the FCC rules. Operation is subject to the following two conditions (1) This device may not cause harmful interference and (2) This device must accept any interference received, including interference that may cause undesired operation.

IMPORTANT NOTE: In the event that these conditions can not be met (for example certain laptop configurations or colocation with another transmitter), then the FCC authorization is no longer considered valid and the FCC ID can not be used on the final product. In these circumstances, the OEM integrator will be responsible for reevaluating the end product (including the transmitter) and obtaining a separate FCC authorization. This device is intended only for OEM integrators under the following conditions: The antenna must be installed such that 20 cm is maintained between the antenna and users. As long as a condition above is met, further transmitter test will not be required. However, the OEM integrator is still responsible for testing their end product for any additional compliance requirements required with this module installed (for example, digital device emissions, PC peripheral requirements, etc.).

# I. Part Names, Fig. 1

## 1. Front Panel

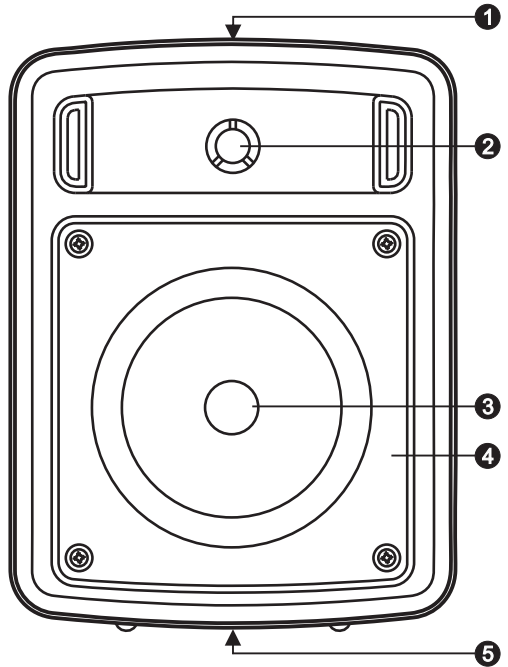

## 2. Rear Panel

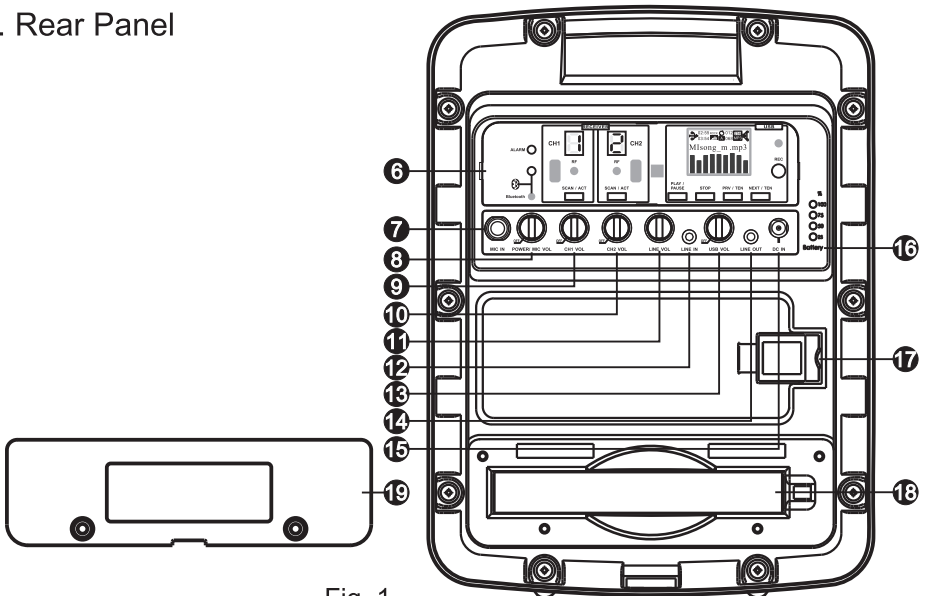

Fig. 1

## Front Panel

- ❶ Fixed Carry Handle
- ❷ Tweeter Speaker
- ❸ Woofer Speaker
- ❹ Speaker Grille
- ❺ Microphone Stand Adapter

## Rear Panel

- ❻ Function Control Panel & Display
- ❼ MIC IN: 6.3 Ø Wired Microphone Input
- ❽ POWER/MIC VOL: Power/Volume Control
- ❾ CH1 VOL: Channel 1 Wireless Mic Volume Control
- ❿ CH2 VOL: Channel 2 Wireless Mic Volume Control
- ⓫ LINE VOL: Line Input Volume Control
- ⓬ LINE IN: 3.5 Ø Line Input Jack
- ⓭ USB VOL: USB Volume Control
- ⓮ LINE OUT: Line Output Jack
- ⓯ DC IN: DC Input Jack
- ⓰ Battery Gauge & Battery Charging Indicator
- ⓱ USB Player Slot
- ⓲ Rechargeable Battery Compartment
- ⓳ Battery Compartment Cover

## II. Control Panel Part Names, Fig. 2

### 1. MA-303DB / MA-303DG (5.8 GHz) Dual-Channel

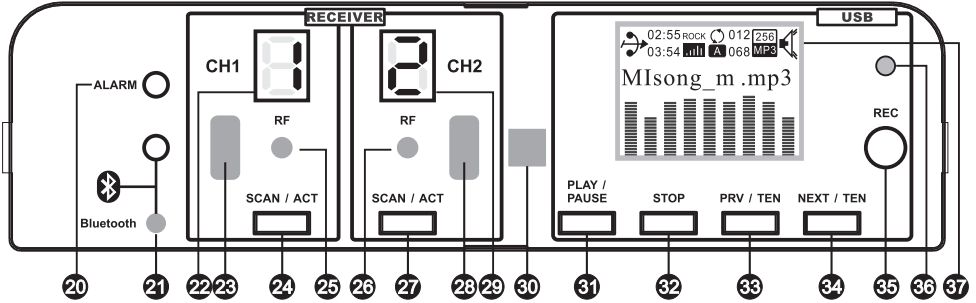

### 2. MA-303SB / MA-303SG (5.8 GHz) Single-Channel

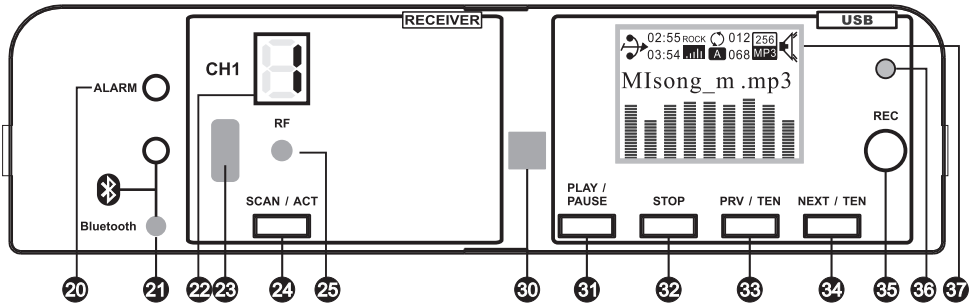

Fig. 2



- 20 ALARM: Alarm Siren Button
- 21 Bluetooth® Power & Indicator
- 22 Receiver 1 Channel Display
- 23 Receiver 1 Infrared (IR) Sync Window
- 24 Receiver 1 Channel Scan & Sync Button
- 25 CH1 RF Indicator
- 26 CH2 RF Indicator
- 27 Receiver 2 Channel Scan & Sync Button
- 28 Receiver 2 Infrared (IR) Sync Window
- 29 Receiver 2 Channel Display
- 30 USB Player Infrared (IR) Window
- 31 PLAY/PAUSE Button
- 32 STOP Button
- 33 PRV/TEN: Previous/Previous Ten Button
- 34 NEXT/TEN: Next/Next Ten Button
- 35 Recording Button
- 36 Recording Indicator
- 37 USB Player Display

### III. Operating Instructions

#### 1. Wired Microphones:

- (A) Turn on the Power/Volume Control **8**.
- (B) Plug the microphone into MIC IN **7**.
- (C) Adjust the Power/Volume Control **8** to desired volume.
- (D) Mic Volume Control and other audio inputs can be used concurrently.
- (E) To end the usage of wired microphones, turn off the Power/Volume Control **8**.

#### 2. Wireless Microphones:

- (A) Turn on the Power/Volume Control **8**.
- (B) Turn on CH1 / CH2 Power and Volume Control **9** / **10**, CH1 / CH2 Indicator **22** / **29** glows red.
- (C) Power on CH1 / CH2 transmitter, RF Indicator **25** / **26** lights.
- (D) Adjust CH1 / CH2 Power and Volume Control **9** / **10** to desired volume.
- (E) Wireless Mic Volume Controls and other audio inputs can be used concurrently.
- (F) It is not possible to transmit two wireless microphones on the same channel to MA-303 system. Only one transmitter can be used at a time on that channel. Be sure to turn off one of the two transmitters to avoid interference. Same wireless microphone can transmit to multiple MA-303 systems on the same channel for a wider and expanded coverage.
- (G) To end the usage of wireless microphones, turn off the CH1 / CH2 Power and Volume Control and Power/Volume Control **8**.

### 3. Line-input:

- (A) Turn on the Power/Volume Control **8**.
- (B) Connect the external audio source to LINE IN jack **12** and adjust the audio source to adequate volume.
- (C) Adjust LINE VOL **11** to desired volume.

### 4. Line-output:

During power-on status, all mixed audio signal can be output via LINE OUT jack **14**.

### 5. USB Operating Instructions:

#### (A) Music Playback:

- (1) Turn on the Power/Volume Control **8**.
- (2) Turn on USB Volume Control **13**. LCD Screen **37** glows. Adjust the volume to adequate position.
- (3) Press PLAY/PAUSE Button **31** to pause. Press it again for playback.
- (4) Press STOP Button **32** to stop playback. Press PLAY/PAUSE for playback.
- (5) Short press **34** for the next track; long press to fast forward to the next ten tracks.
- (6) Short press **33** for the last track; long press to fast backward to the last ten tracks.
- (7) To end the music playback, turn off USB Volume Control and Power/Volume Control.

(B) Record Tracks:

- (1) Insert a USB into USB Player Slot 17. Turn on Power/Volume Control 8 and USB Volume Control 13. LCD screen 37 glows and starts to play music.
- (2) Press STOP Button 32 or Recording Button 35 during playback will stop the playback. The screen shows STOP. Then press Recording Button and Recording Indicator 36 glows and is ready to record. Press PLAY/PAUSE Button to start recording and Recording Indicator blinks.
- (3) Press STOP Button to stop recording and turn the recorded file into MP3 format. The recorded file will play automatically after being saved.

(C) Two options for the order of playing music:

- (1) Copy the desired songs into USB storage unit one by one until copying all the desired songs. By this way, the play sequence will be based upon the order of music being programmed into USB storage unit.
- (2) Number the desired songs when copying them into folders. Then copy the folders into USB storage unit. Please note the songs must be numbered by the same digit like 00, 01, 02 or 000, 001, 002 or 0000, 0001, 0002.. and so on.

## 6. Bluetooth® Connection:

Pair Bluetooth® receiver with the mobile devices and play the music via the devices.

- (A) Turn on Power/Volume Control **8**.
- (B) Activate the Bluetooth function on the mobile device and bring the device close to the MA-303.
- (C) Press & hold the Bluetooth Power & Indicator **21** for 3-5 seconds until blue/red light is flashing intermittently.
- (D) If indicator is not flashing intermittently or not flashing, repeat by press & hold for 3~5 seconds until blue/red indicator is flashing intermittently.
- (E) Enter “0000” when prompted to enter a PIN code.
- (F) Once paired and connection is made, the Bluetooth Indicator turns into blue and flashes intermittently.
- (G) To cancel Bluetooth function, press & hold Bluetooth Power & Indicator for 3 seconds.
- (H) Power off and on the Bluetooth receiver for changing connected device. Repeat the directions above to connect a different device. Blue/red light is flashing intermittently indicates the receiver is ready to be paired.
- (I) Pairing Bluetooth® for two devices:  
Turn on one device first and operate steps A~F, then turn on the other one and do steps A~E. Press the Bluetooth button twice for each device, during blue/red indicator light flashing intermittently, two Bluetooth receivers are pairing with each other. Once paired, the blue color indicator light will flash intermittently or stay on. Now play the music from the paired smartphone and get stereo sound amplification.

## IV. Advanced Operating Instructions

### 1. Wireless Mic System:

#### (A) Channel Set-up:

- (1) To Scan for a Clear Receiver Channel: Press & hold the SCAN/ACT button **24** until current channel blinks. Release the button, blinks will last for 10 times and stop on the current channel. During blinking, press & release the SCAN/ACT button again and the receiver scans and sets at a clear channel automatically. Then the new channel will be stored, Fig. 3.

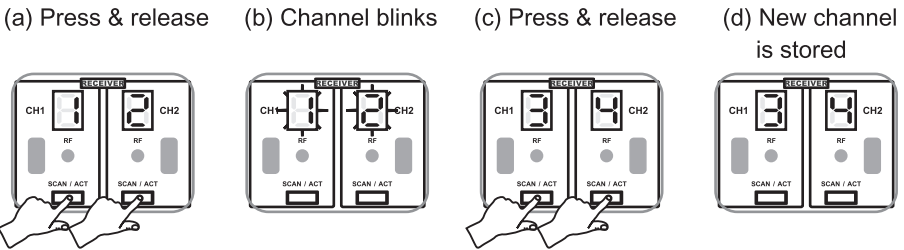

Fig. 3

- (2) Manually Forcing a Channel Change: Press & hold the SCAN/ACT button until current channel blinks. Release the SCAN/ACT button until a desired channel is reached. This will force the receiver to change to the next available clear channel, Fig. 4.

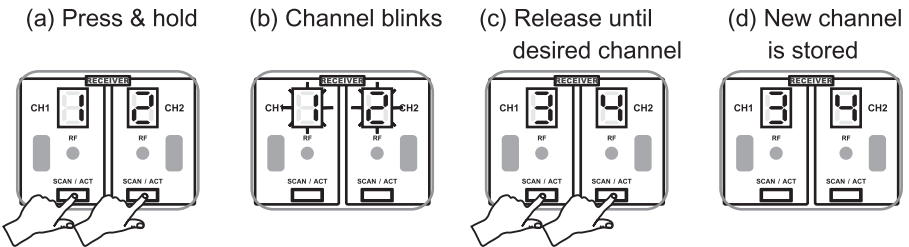

Fig. 4

#### (B) When to Change Channel:

- (1) Interference occurs during performance.
- (2) When two or more MA-303 systems need to be used at the same venue.

(C) Cautions:

- (1) Do not select a new channel while another system is operating as it may cause interference.
- (2) If “\_” is displayed during channel scanning this indicates the current channel in this frequency band is experiencing interference. If problem persists, it is recommended to change and use a different frequency band.

(D) Corresponding Channel Display: MA-303DB / MA-303SB Receiver and Transmitter, Fig. 5:

MA-303	1	2	3	4	5	6	7	8	9	0	A	B	C	D	E	F
Transmitter LCD	01 01	01 02	01 03	01 04	01 05	01 06	01 07	01 08	01 09	01 10	01 11	01 12	01 13	01 14	01 15	01 16

Fig. 5

(E) MA-303DG / MA-303SG ID (Identification) CODE:

- (1) Setting ID code enables the user to increase compatible channels at the same venue using the same operating channel, especially in a heavily congested Wi-Fi environment and interferences.
- (2) MA-303DG / MA-303SG 5.8 GHz has 9 available ID codes:  
1→2→3→4→5→6→7→8→P, P is random ID code.
- (3) Setting ID code:
  - (a) Press & hold the SCAN button. Concurrently, turn on the Power Switch/Wireless Mic Volume Control. Press & release the SCAN button will move up to the next available ID code. Turn off the Power Switch/Wireless Mic Volume Control to save this ID CODE.
  - (b) Turn on the Power Switch/Wireless Mic Volume Control back on again to perform the ACT synchronization with embedded ID code. Without performing this ACT synchronization step, no sound output because the ID codes has been changed even though the same channel number remains the same.

(F) ACT Synchronization (Sync) between Receiver and Transmitter Channels:

- (1) Press and release SCAN/ACT button, the current channel blinks and is ready for ACT synchronization.
- (2) Power on handheld or bodypack transmitter. Bring the transmitter sync port (red indicator) within 30 cm (12-inch) of CH 1 or CH 2 receiver sync port, Fig. 6.
- (3) Once ACT synchronization is done, the channel screen will stop blinking and RF indicator glows green to indicate a successful RF link.
- (4) To cancel an accidental activation of ACT function, just press SCAN/ACT button again.

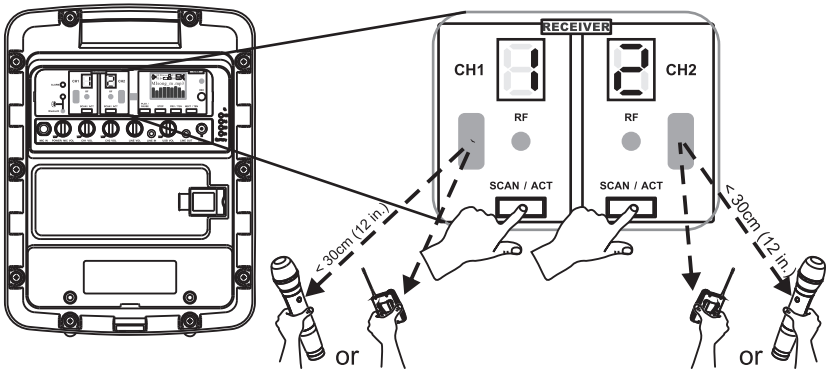

Fig. 6

(G) Caution in Operating MA-303DG / MA-303SG 5.8 GHz:

- (1) Position the MIPRO receiver at least 5-meter away from 5.8 GHz Wi-Fi or other 5.8 GHz transmitting devices.
- (2) User can scan environment for current 5.8 GHz Wi-Fi devices being used and signal strength with smartphone app. Ascertain position the MIPRO receiver away from these 5.8 GHz Wi-Fi transmitting devices.
- (3) A clear, line-of-sight provides the optimal reception range between the transmitting antenna and receiver.



## 2. Music Playback:

(A) USB Display Screen, Fig. 7:

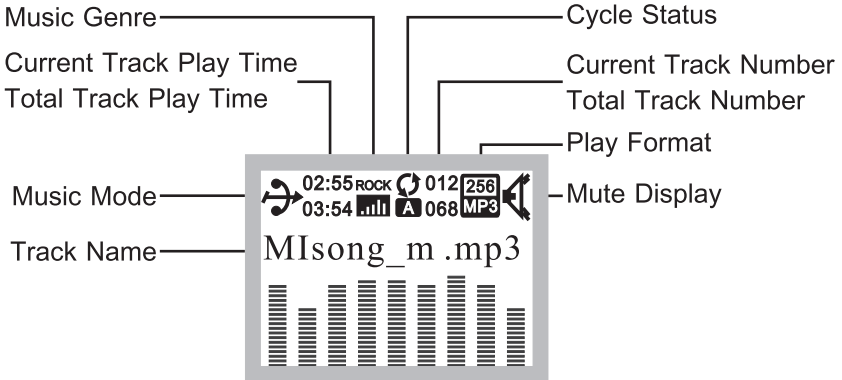

Fig. 7

(B) Press PLAY/PAUSE button  to pause track, Fig. 8:

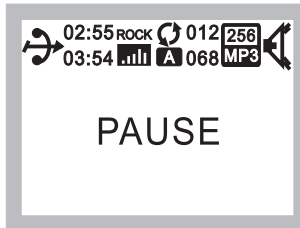







Fig. 8

(C) USB flash drive is not inserted, Fig. 9:



Fig. 9

- (D) Panel Operating Instructions: During track playing, press & hold PLAY/PAUSE  button to enter music parameter selection for changes. Press PLAY/PAUSE button and then press PRV/TEN  or NEXT/ TEN  to locate the desired parameter. Press PLAY/PAUSE to confirm change and save, Fig. 10.
- (E) Remote Operating Instructions: During track playing, press Mode button to enter music parameter selection for change. Press  or  to highlight selection. Press  to confirm.

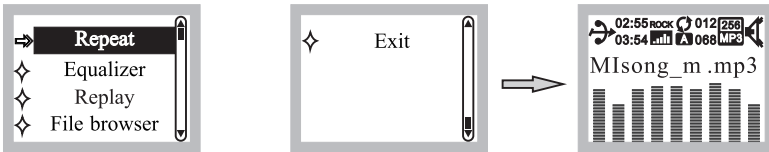





Fig. 10

- (F) Repeat Mode: Press PRV/TEN  or NEXT/TEN  to select parameter, Fig. 11.

- (1) Repeat All:  .
- (2) Repeat Folder:  .
- (3) Repeat One:  .
- (4) Random:  .

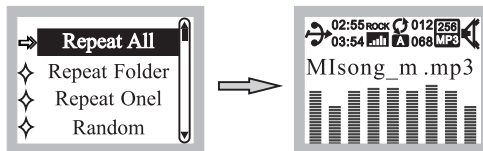









Fig. 11

(G) Equalizer Mode, Fig. 12:

- (1) Press PRV/TEN ◀◀ or NEXT/ TEN ▶▶ to select parameter.
- (2) Press PLAY/PAUSE ⏸ to confirm.
- (3)
 

NOR 	Natural: Normal	➔	POP 	Pop: Popular	➔	ROCK 	Rock: Rock	➔
JAZZ 	Jazz: Jazz	➔	CLAS 	Classic: Classical	➔	SOFT 	Soft: Soft	➔
DBB 	DBB: Deep Bass							

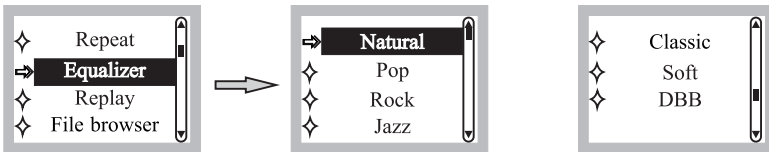

Fig. 12

(H) Replay Mode, Fig. 13:

- (1) Reply A- / -B mode.
- (2) In Replay Mode, press PLAY/PAUSE ⏸ to enter.
- (3) Press NEXT/TEN ▶▶ to select A- ; press NEXT/TEN ▶▶ again to select -B. Then it will replay A-B.
- (4) Press PLAY/PAUSE ⏸ to stop Replay Mode and return to playback mode.

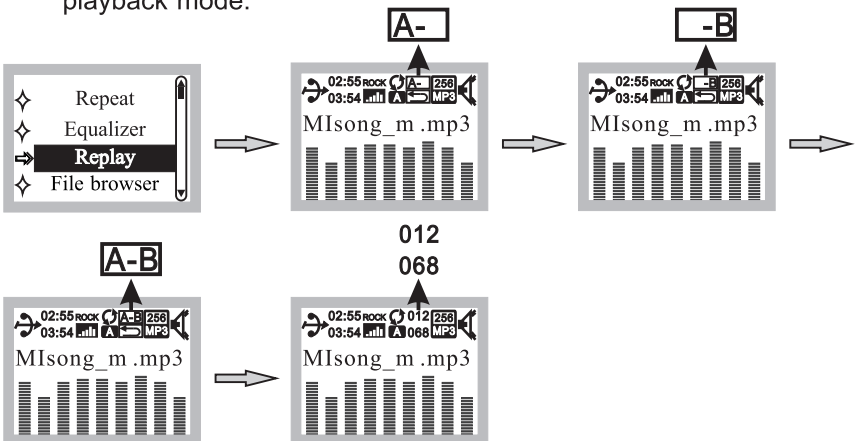





Fig. 13

- (I) File Browser Mode: Press PLAY/PAUSE  to enter track directory. Press PRV/TEN  or NEXT/ TEN  to select the desired song. Press PLAY/PAUSE to play the song tracks, Fig. 14.

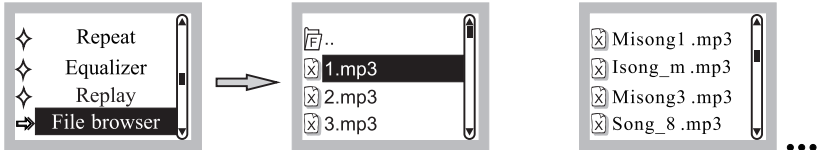



Fig. 14

- (J) Exit: In exit option, press PLAY/PAUSE  to return to the playback mode, Fig. 15.

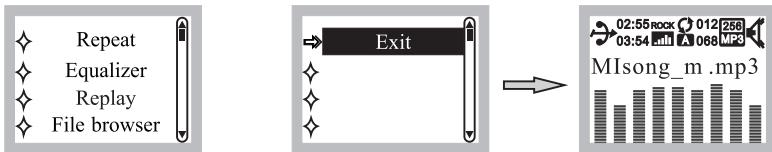



Fig. 15

- (K) Enter the Main Mode: USB flash drive not inserted or press & hold STOP button during playback.

- (1) Music Mode: Insert USB flash drive and press PLAY/PAUSE  to play music, Fig. 16.

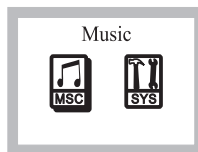

Fig. 16

- (2) System Settings Mode: Press PRV/TEN ◀◀ or the NEXT/TEN ▶▶ to change functions, press PLAY/PAUSE ▶❏ to confirm and enter system settings, Fig. 17.

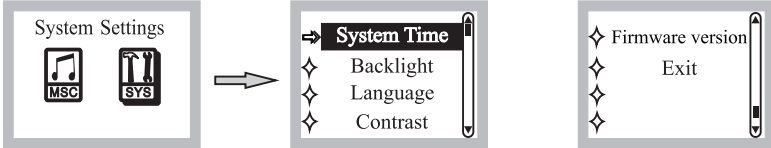

Fig. 17

- (3) Changing Date & Time: Press PLAY/PAUSE ▶❏ to enter the System Time setting mode, press PRV/TEN ◀◀ or NEXT/TEN ▶▶ to change. Press PLAY/PAUSE to confirm, Fig. 18.

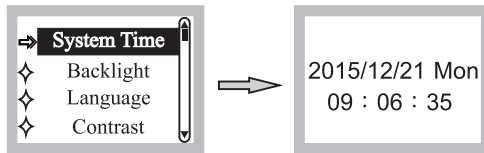

Fig. 18

- (4) Changing Backlight Brightness Time: 00 is constant. The parameter can be set by an interval of 10 seconds between 00 and 240, Fig. 19.

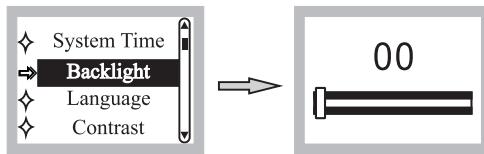

Fig. 19

- (5) Changing Language, Fig. 20.

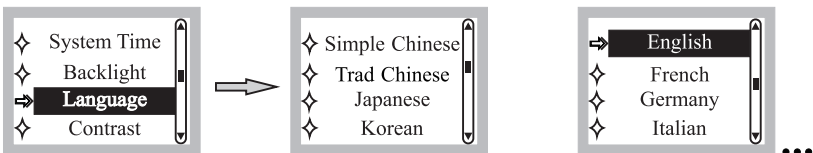

Fig. 20

(6) Changing LCD Contrast, Fig. 21.

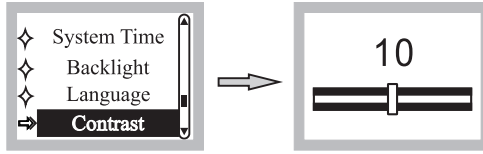

Fig. 21

(7) Firmware Version, Fig. 22.

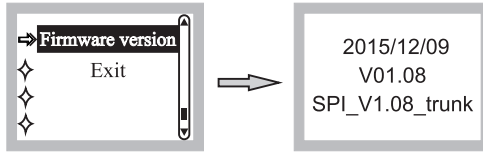

Fig. 22

(8) Exit: Return to Music & System Settings (Main Mode), Fig. 23.

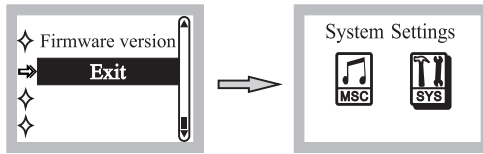

Fig. 23

(L) Directory Selection:

- (1) File Brower: Press during playback and screen displays PAUSE. Press & hold to enter the directory option. Press or to sequentially select the directory option, Fig. 24.

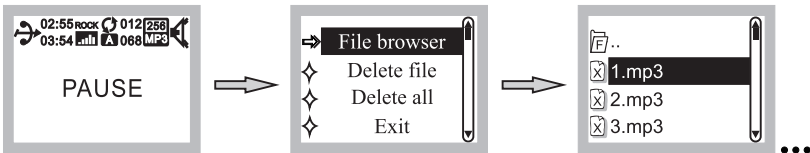

Fig. 24

- (2) Delete File: Press **▶||** to enter the “Delete file” screen. Press **◀◀** or **▶▶** to select “NO” or “YES”. Press **▶||** to confirm, Fig. 25.

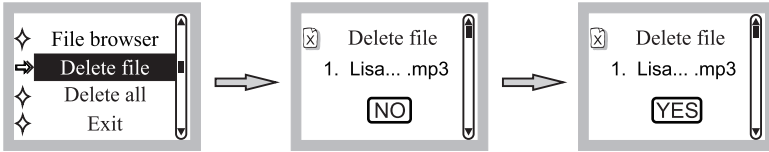

Fig. 25

- (3) Delete All: Press **▶||** to enter the “Delete all” screen. Press **◀◀** or **▶▶** to select “NO” or “YES”. Press **▶||** to confirm, Fig. 26.

- (4) Note: This function will delete all files in the flash drive, so careful action is highly recommended.

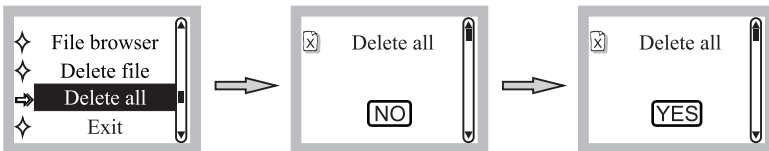

Fig. 26

- (5) Select “EXIT” to return to the PAUSE screen. Press **▶||** to return to playback mode.



Fig. 27

### 3. USB Remote Controls and Indicators, Fig. 28:

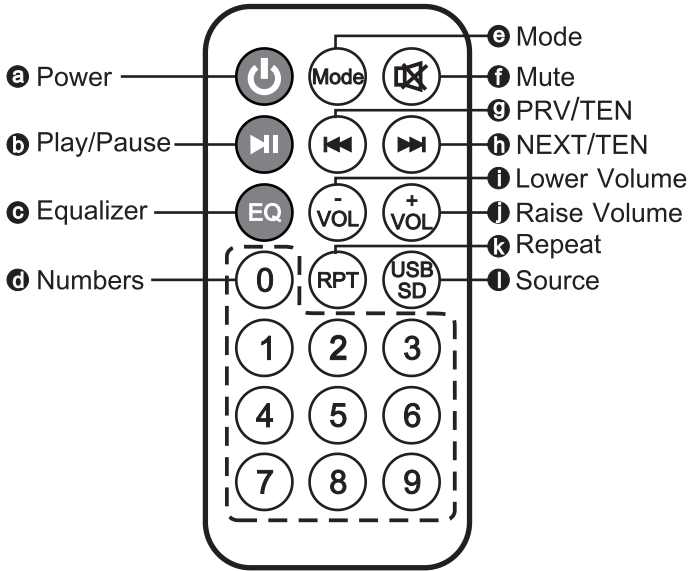

Fig. 28



#### 4. Replacing USB Remote Battery, Fig. 29:

- (A) Press and hold the tenon on the bottom of the remote control and then slide out the battery tray.
- (B) Remove the old battery and insert the new battery in, making sure that the battery's positive (+) side is facing up.
- (C) Slide the battery tray back into the remote control until it clicks.
- (D) The remote control can function at distances of up to 5 meters. The remote control uses CR2025 lithium 3V coin battery.

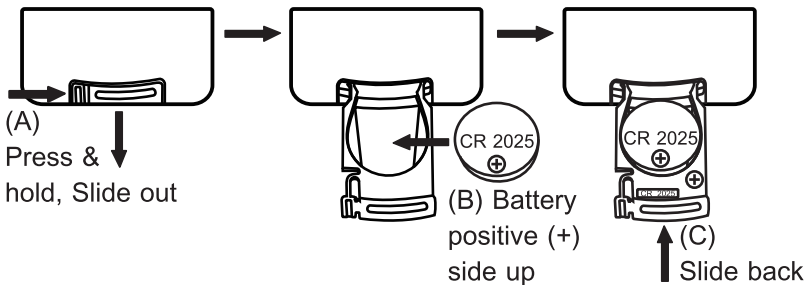



Fig. 29

#### (E) Notes:

- (1) Do not hit the player.
- (2) Do not place this player near strong magnetic fields and electric fields.
- (3) Do not disassemble, repair or modify this player.
- (4) Changes to the characteristics and design of the product will be made without notice.

## V. Rechargeable Battery

1. Instruction of Charging the Rechargeable Battery.
  - (A) Charge the battery completely in its first use to obtain its maximum capacity.
  - (B) Connect to any available AC power outlet using the included DC adapter to the DC IN jack.
  - (C) The Battery Charging Indicator  LED blinks while charging. Blinking LED may start later if the battery suffers from excessive battery drain. The battery may be damaged if the LED does not blink after charging for a while.
  - (D) The battery is low when only the red LED is on. Please recharge the batter for at least 4 hours (the time of charging depends on the type of battery).
  - (E) All LED blinking means the battery is charging. Charging completes when all LEDs glow.
  - (F) Fully charge the battery for storage if it will not be used for an extended period of time. Battery may lose some capacity overtime. Over-discharged occurs and may damage the battery if not recharged for a long period of time. Thus, it is recommended to recharge often or every 3 months.
  - (G) This device has 2 automatic power cut-off functions. Battery display will drop to red color for a period of time during low power status. Power will automatically shut-off to prevent battery operation. Recharge the battery immediately to avoid damage due to over-discharging.
  - (H) Change to a new, fresh battery when battery hours are shortened after recharges due to battery aging.

- (I) All rechargeable batteries are consumables and have a limited lifespan, and eventually need to be replaced. A standard 14.8V lithium battery from MIPRO is recommended to ensure compatibility and performance.

## 2. Steps of Changing the Rechargeable Battery.

- (A) Lay the PA system on a flat surface. Remove the two screws and use flat blade screwdriver to open the battery compartment cover, Fig. 30.
- (B) Remove the battery compartment cover, Fig. 31.

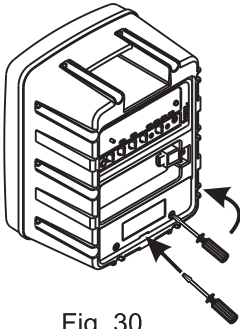

Fig. 30

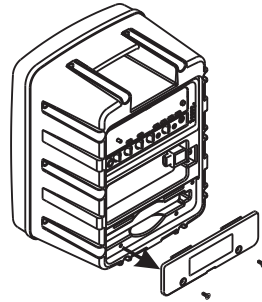

Fig. 31

- (C) Pull out the battery gently and remove it completely by detaching the connecting pins, Fig. 32, 33.

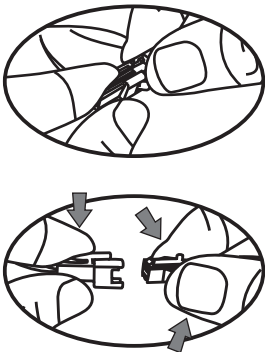

Fig. 32

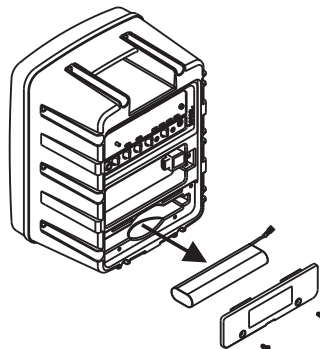

Fig. 33

- (D) Insert the replacement battery pack. Ascertain the connecting pins are connected firmly before inserting, Fig. 34.
- (E) Carefully slide the battery back into the compartment slot. Insert back the two screws back in place securely, Fig. 35.

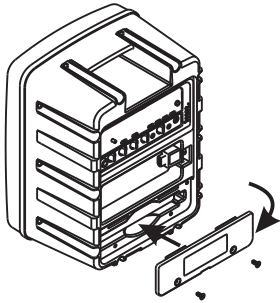

Fig. 34

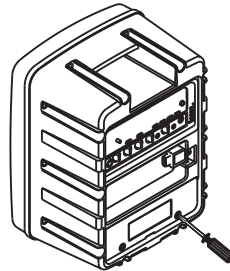

Fig. 35

## VI. Connection to External Audio Sources, Fig. 36

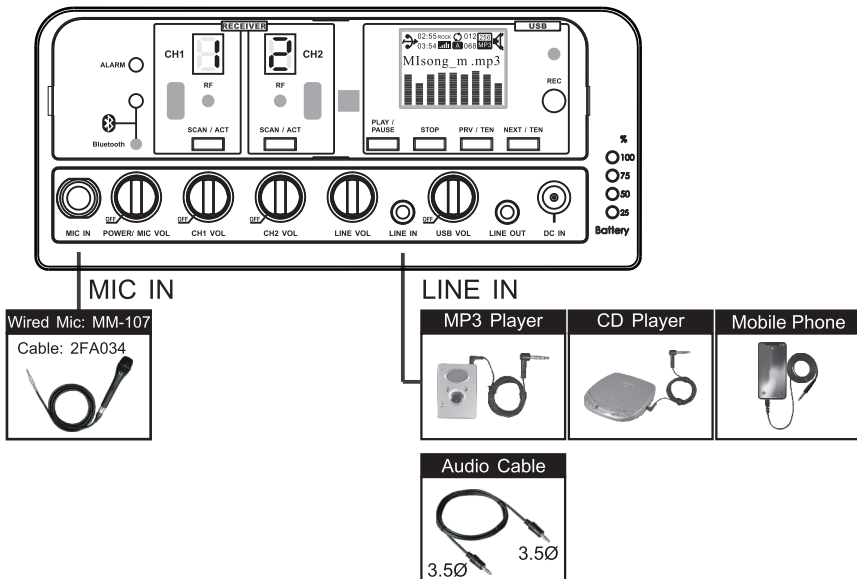
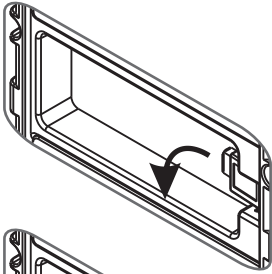
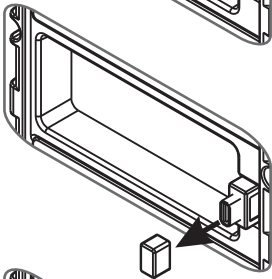

Fig. 36

## VII. USB Drive Operation, Fig. 37



1. Pull out the USB port to a 90 degree angle.



2. Remove the protective cap.

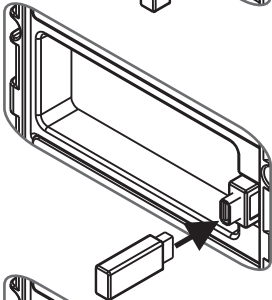

3. Insert a Type-A USB drive (USB interface).

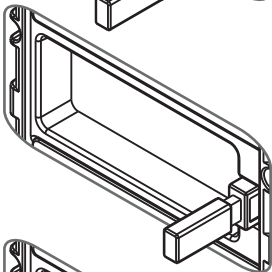

4. Ensure USB drive is plugged firmly and securely.

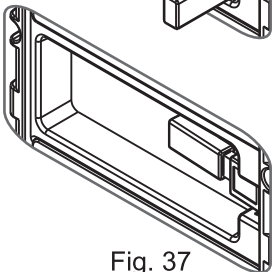

5. Push back the USB port into the standard position to prevent accidental issues.

Fig. 37

## VIII. Instruction

Set the base on any 15.8 mm (3/8 ") tripod or on top of MIPRO's MS-90 wall-mounting kit. When done, tighten the knob (see illustrations below).

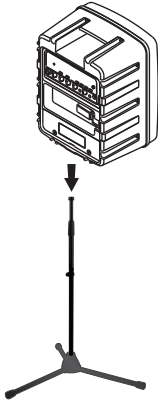

Fig. 38: Installed on a 15.8mm (3/8") tripod

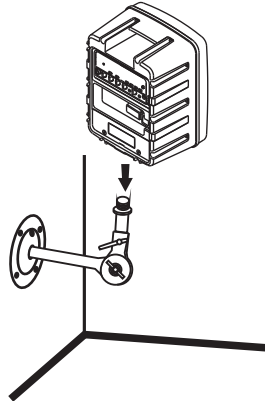

Fig. 39: Installed on a MS-90 wall-mounting kit

## IX. Note

1. Design and specifications are subject to change without prior notice. Refer to actual product in the event of product discrepancy.
2. Frequency range, output power and maximum deviation to adhere to local telecom regulations.



**MIPRO**<sup>®</sup>  
MICROPHONE PROFESSIONALS

**MIPRO Electronics Co., Ltd**

Headquarters: No. 814, Beigang Rd., Chiayi City 600079, Taiwan  
Tel : +886.5.238.0809  
www.mipro.com.tw

Fax : +886.5.238.0803  
mipro@mipro.com.tw



All rights reserved. YM 020/09

Do not copy or forward without prior approvals MIPRO.

Specifications and design subject to change without notice.



2 CE599 D