

GENELEC®

4420A
Operating Manual

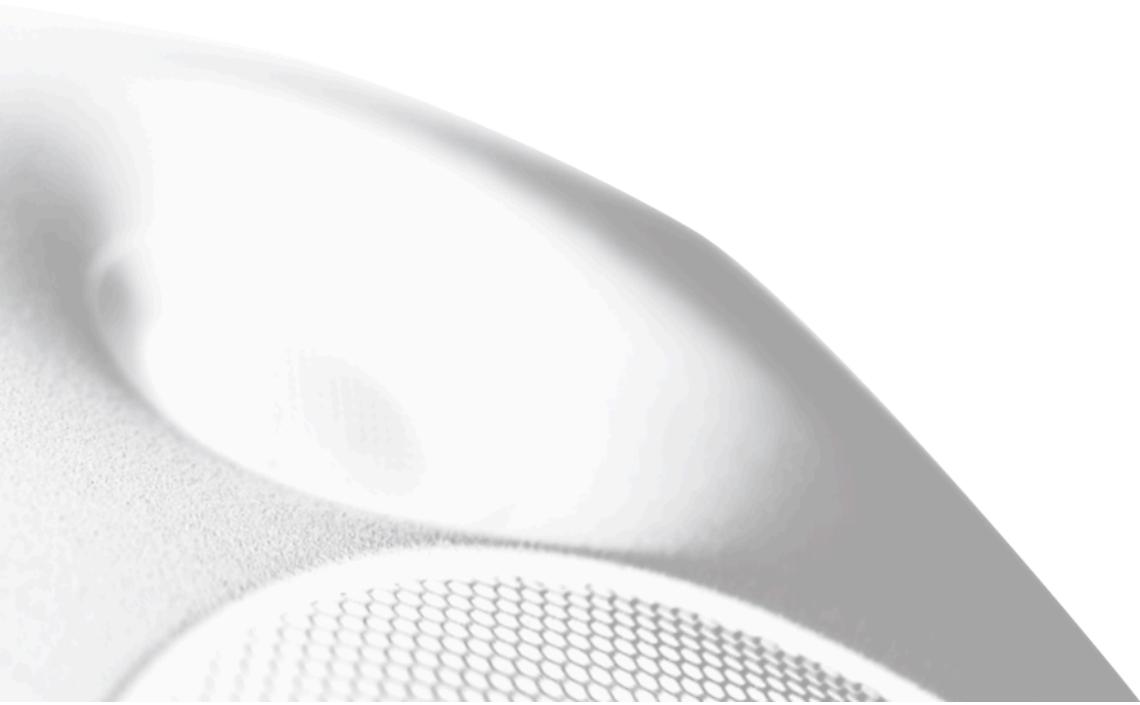

GENERAL DESCRIPTION

The bi-amplified Smart IP Genelec 4420A install loudspeaker is a compact two-way active loudspeaker for fixed installations. It requires only one CAT cable to connect, making installation easy. The 4420A loudspeaker is powered using the standard Power-over-Ethernet (PoE) technology, using PoE+ or PoE standards. The proprietary internal power supply in 4420A delivers an impressive short-term SPL.

The 4420 is a high-resolution loudspeaker delivering a signal path and acoustic output that extends to ultrasonic frequencies. It uses Genelec's Minimum Diffraction Enclosure (MDE) enclosure technology to reduce acoustic diffractions. Combined with the advanced Directivity Control Waveguide (DCW) surrounding the tweeter, this provides excellent frequency balance in difficult acoustic environments.

The 4420A loudspeaker supports Genelec Smart IP technology. The Smart IP technology provides scalable power, audio and loudspeaker configuration, supervision and calibration features via a standard CAT cable, offering integrators unrivalled power, flexibility, cost-effectiveness and simplicity of installation.

The 4420A has been designed for excellent sound quality and very long lifetime. The enclosure is made of environmentally friendly recycled die-cast aluminium. 4420A is manufactured using certified sustainable methods. All essential parts of the loudspeaker can be recycled.

The 4420A is available in black, white or 120 RAL colours on order. It is compatible with Genelec's extensive range of mounting accessories for floor, ceiling, wall, or truss mounting.

The 4420A loudspeaker contains

- highly efficient dedicated Class D power amplifiers, one for each driver,
- switched-mode power supply technology offering high SPL output using standard PoE+ and PoE power supply with an IP switch or power injector,
- active crossover filter,
- electronic system protection,
- audio-over-IP streaming input,
- balanced analogue line input,
- flexible room acoustic compensation tool set built in.

Audio-over-IP streaming supports unlimited number of channels in the playback system. These audio channels are automatically synchronized perfectly in time by the audio-over-IP streaming technology, forming a single playback system. 4420A accepts AES67/ST2110 and Dante audio-over-IP streams. The streams are set up with Dante Controller or Dante Domain Manager software. Each 4420A supports reproduction of one or the sum of two audio input channels. The stream audio sample rate can range 32-96 kHz, with 16-24 bit resolution.

The 4420A contains one rear panel CAT connector for standard Ethernet IP network connectivity. The network interface speed is 100 Mbps. The rear panel CAT connector also allows Genelec's Smart IP Manager software to work on the 4420A. This software is available for AV installers at Genelec web site and runs on Windows 10 computers. The software allows AV installers to configure an almost unlimited number of rooms, zones, loudspeakers and audio channels, and includes device discovery, a versatile room acoustic equalisation tool set, system organisation and status monitoring.

The 4420A contains an application programming interface (API) supporting control via third-party hardware, software or house automation. The API enables integration to all house and home automation systems. Detailed information about the API are provided in a separate document from Genelec.

A balanced line input is available on 4420A besides the CAT connector. The balanced line analogue audio input in each loudspeaker can be configured to use with Genelec Smart IP Manager software. When the balanced line input is used the loudspeaker must still receive PoE power on the CAT cable.

The 4420A is designed for indoor use, in temperatures 15-35 Celsius and relative humidity 20-90 %.

PACKING CONTENT

- Genelec two-way active loudspeaker 4420A.
- Keyhole-type wall mount with screws.
- Three-pin Euroblock connector for balanced analogue line input (inserted in the loudspeaker).



Figure 1. Packing content, from left to right, loudspeaker, wall mount and analogue input connector (inserted in the speaker).

POSITIONING AND MOUNTING THE LOUDSPEAKER

Place the loudspeaker so that the line of the acoustic axis points towards the main listening area. The AV install designers may indicate different aiming.

Minimum clearance for amplifier cooling and reflex port function around the loudspeaker is 3 cm (13/16 in) behind, above and on both sides of the loudspeaker. If the back side of the loudspeaker is blocked, the back side of the loudspeaker must be ventilated so that the ambient temperature remains below 35 C (95 F) under any moment of operation.

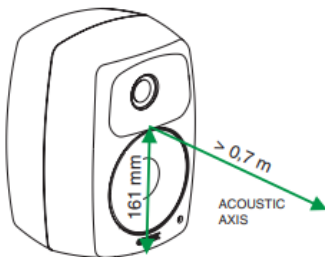

Figure 2. Definition of the acoustic axis.

The two primary mounting points are on the rear side. Use these for mounting brackets or the keyhole wall mount adapter. They have metric M6 x 10 mm holes (thread type is metric M6, thread depth is 10 mm). Do not exceed the thread depth as this can result in failure of the thread. The base of the loudspeaker carries a 3/8 in UNC-threaded hole compatible with a certain standard microphone stands. This can be used for additional support. The UNC thread is not compatible with metric threads. Do not use this point as the primary mounting point. Pay attention to mounting screw lengths. Do not use screws exceeding the depth of the hole as this can destroy the threads in the mounting points. Do not over-tighten. Do not use very short screws as the thread length covered by such screw is not enough to hold the weight of the speaker.

See Genelec Accessories Catalogue on www.genelec.com for a complete list of mounting hardware options. The accessories can come with instructions on the proper methods of installation.

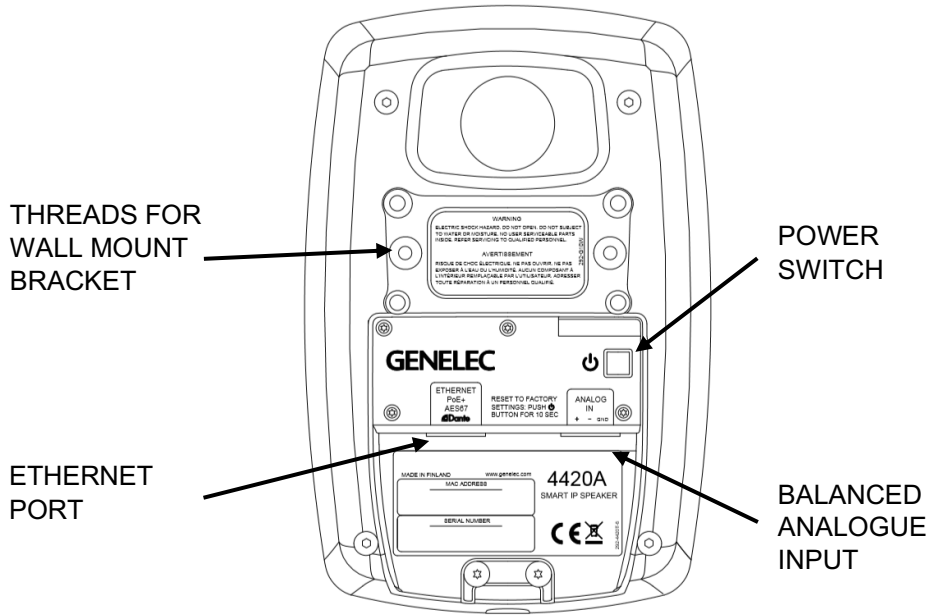

Figure 3. Connectors and controls in the 4420A rear panel.

CONNECTING LOUDSPEAKERS

To get started, connect an Ethernet cable from the PoE+ output in an IP switch to the 4420A Ethernet port. Use at least CAT5 cable or better. Press the power switch to power up the loudspeaker.

To create a working system, you will need

- IP switch with a PoE+ (802.3at) output for the 4420A loudspeaker or an IP switch with no PoE support and a PoE+ power injector
- CAT 5 or higher category Ethernet cable with RJ45 connectors
- AES67, ST2110 or Dante audio-over-IP stream source
- For 4420A setup and configuration, a computer running Macintosh OS X or Windows 10 operating system
- Genelec Smart IP Manager software
- Dante Controller software or Dante Domain Manager software

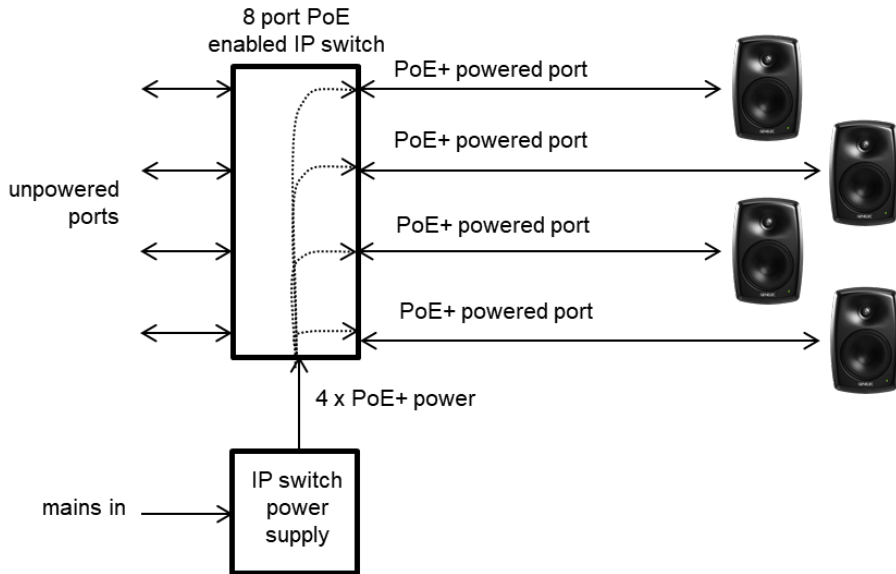

Figure 4. 4420A powered with PoE+ IP switch.

Example of powering the 4420A with a PoE+ enabled IP switch. With this method, the power budget available for all outputs connected to the IP switch must enable each 4420A to run at full PoE+ power. For 4 loudspeakers, the power supply must support 4 x PoE+ power level.

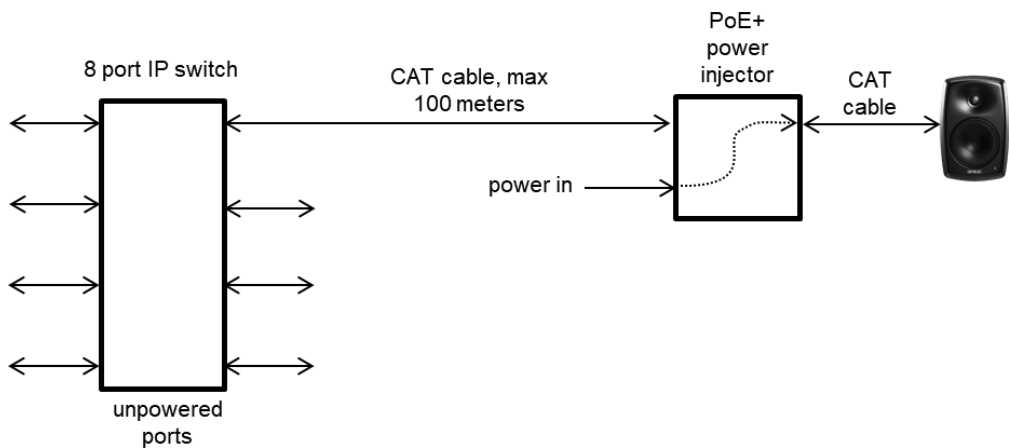

Figure 5. 4420A powered by an IP PoE+ power injector.

Example of powering the 4420A with a PoE+ power injector. This method enables the use of standard non-PoE IP switches. Each power injector must support full PoE+ power level into the device.

How PoE power management works

The 4420A internal power supply stores power for peak output. This enables the output power to exceed the input power for short durations (Figure 6). Music and speech signals are dynamic. They contain high peaks above the average level. These peaks are supplied from the energy stored in the loudspeaker power supply. The power supply has been dimensioned to work with audio and speech signals, including highly compressed wideband audio signals. The duration of peak output is limited more by the PoE supply and therefore Genelec recommends the use of PoE+ supply whenever possible.

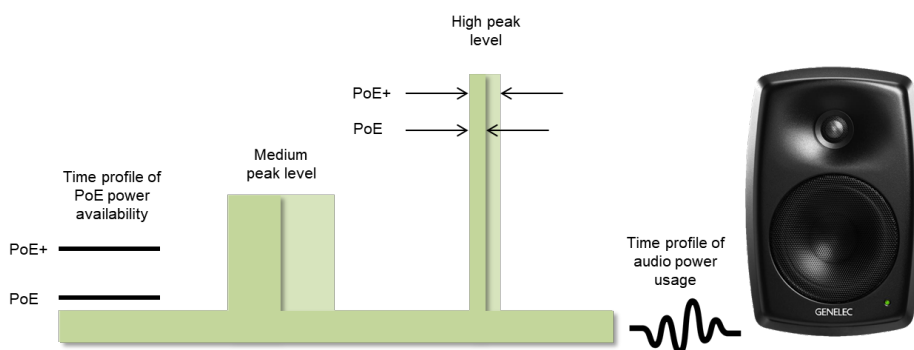

Figure 6. 4420A power supply enables high output level peaks exceeding the incoming PoE power level; the PoE standard limits the duration of the peaks

PoE budget calculation

The 4420A supports automatic negotiation with the IP switch or IP power injector to set the PoE power level. However, in some cases it may be necessary to set the PoE power level in the switch manually.

Table 1. PoE and PoE+ power levels.

Name	Standard	Power at switch	Min. power at 4420A
PoE	IEEE 802.3af-2003	15.4 W	12.95 W
PoE+	IEEE 802.3at-2009	30 W	25.5 W

There are several Power-over-Ethernet standards. The 4420A loudspeaker supports the PoE+ standard but also works with the lower power PoE standard. When the 4420A also works with lower PoE power, the duration of high SPL output is shortened, and long continuous output signals play at smaller sound level than when the PoE+ power level is used. Genelec recommends using PoE+ power level with 4420A.

Each PoE supply device (IP switch or power injector) has a certain maximum output power capacity. This can limit the number of PoE outputs that can be set on. For 4420A loudspeaker, calculate the output power for each output as 15.4 W for PoE and 30 W for PoE+. Ensure that the total power does not exceed the switch or power injector total power.

Example: IP switch total power is 150 W. You use PoE+ and four outputs are connected. The total output power is $4 \times 30 \text{ W} = 120 \text{ W}$. This is smaller than the capacity of the IP switch, 150 W. This scenario is acceptable.

PoE cable loss calculation

There is power loss in the Ethernet cable. The reason for the power loss is that the CAT cable conductor is thin and has considerable resistance. The power loss increases with increasing cable length. The maximum cable length is 100 meters (333 feet). Calculate the power loss in cable at 25 mW/m or 7,4 mW/ft. 4420A will automatically adapt to the power loss in the cable, but lower input power will affect slightly the duration of the maximum SPL output. In order to minimize the cable loss and to maximize the duration at maximum SPL, consider using power injectors close to the loudspeakers or short cable runs.

ISS AUTOSTART

The automatic power function ISS (Intelligent Signal Sensing) powers the loudspeaker automatically down when it is not in use and up when the use resumes. ISS can be activated and adjusted with the Smart IP Manager software. Powering down to standby happens after a set time when playback has ended. Playback automatically resumes with an input signal exceeding the level configured using the Smart IP Manager. There is a slight delay in the automatic powering up. If this is undesirable, ISS can be disabled with Smart IP Manager.

The intended use of this loudspeaker requires that the IP network interface is continuously enabled also in the standby mode. This enables the ISS to wake up with an API command or in response to IP audio stream. The power consumption in the ISS state for 4420A is 4 W. To save more power, the PoE+ power supply in the Ethernet switch or PoE injector can be turned off. However, loudspeaker wakeup will then take slightly longer time and the loudspeaker does not respond to any command on the IP network while it is not powered.

SELECTION OF IP SWITCH

Smart IP and 4420A are fully compatible with standard Ethernet and IP switch technology. Genelec recommends using gigabit speed managed IP switches with full PoE+ on each of the outputs intended for 4420A loudspeakers. Managed IP switches offer the ability to configure, manage and monitor the local area

network, typically using a web browser user interface, and this helps in creating a well working system.

The IP switches should support QoS and be media ready. Differentiated services (DiffServ) typically implements QoS prioritization of IP traffic. DiffServ marks IP packets according priority. In response, IP switches can prioritize media traffic to improve system performance. Differentiated services code point (DSCP) markings in the IP packet headers are sensed by the QoS capable IP switch.

Genelec does not endorse certain IP switch brands as Smart IP works perfectly with all high-quality standard IP switches with these capabilities. Use of 100 Mbps IP switches is discouraged.

NETWORK STRUCTURE

Genelec recommends always designing a network structure with star topology. Only one IP device (for example, one 4420A) should be connected at one port in an IP switch. IP device ports should not be daisy chained to several IP devices.

Audio-over-IP requires the use of cable-based LAN network. Low-latency uncompressed audio-over-IP streaming does not work over WLAN.

SETTING UP AUDIO STREAMS

Audio stream setup is done by using Dante Controller software. Download the software from <https://www.audinate.com/products/software/dante-controller>

An AES67/ST2110 audio stream supported by the loudspeaker can have contain the maximum of 8 audio channels. Dante automatically divides a multichannel stream into several low channel count flows suitable for the speaker and this process is largely automatic.

The 4420A can select one audio channel or a sum of two channels in a stream.

The AES67 compatibility mode must turned ON to enable reception of AES67 or ST2110 streams. Follow these instructions:

- Double click on the loudspeaker to be configured. The **Device View** window opens.
- Click **AES67 Config** -tab.
- In the **AES67 Mode** panel, go to **New:** and select **Enabled**.
- In the **Reset Device** panel, click **Reboot** to reboot loudspeaker with AES67 enabled.

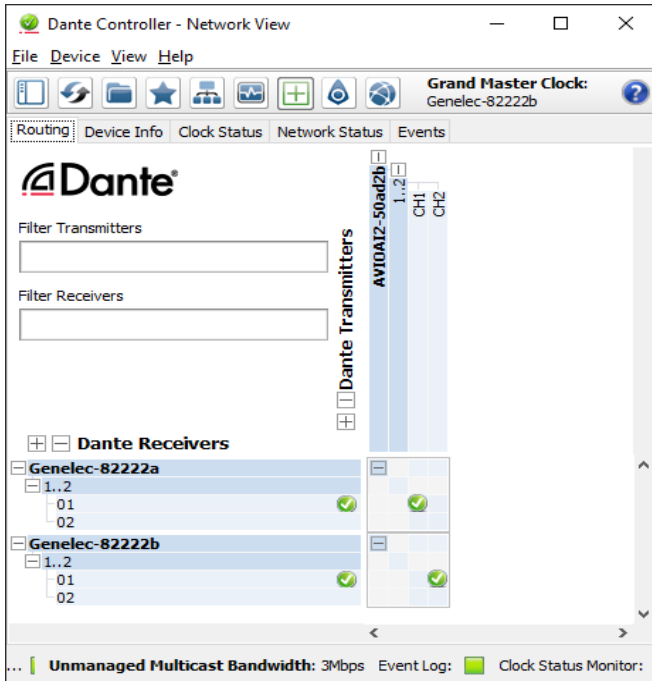

Figure 7. Configuring for AES67/ST2110 streams in the Dante controller.

ANALOG INPUT

An analogue audio input is provided using a screw-mount Euroblock connector. This enables easy connectivity and daisy-chaining the balanced audio signal to several loudspeakers. When you daisy-chain loudspeakers, connect a second signal cable to the plug (Figure 8).

The input impedance of the analogue input is 10 kOhm. The pin sequence of the connector is shown in Figure 8. The number of loudspeakers that can be on the same daisy chain is set by the capability of the source device analogue output. The daisy-chained loudspeakers appear electrically in parallel, reducing the load impedance presented to the source device. Typically, 10 to 20 loudspeakers can be daisy-chained on one balanced line.

Avoid connecting 4420A to the power amplifier outputs. If this must be done, use a balanced attenuator. Typically, an attenuation of about 20 dB is needed. Beware that some power amplifiers can provide a signal that exceeds the maximum voltage at the analogue input, and this can result in failure of the analogue input.



Figure 8. Balanced analogue input pin-out (left) and daisy-chaining cables in the analogue input Euroblock connector (right).

GENELEC SMART IP MANAGER SOFTWARE

Acoustic calibration, zone setup, input selection and loudspeaker management are done using Genelec Smart IP Manager software. This is a software intended for AV installers. Genelec recommends using the Application Programming Interface (API) inside the loudspeaker to be used with house automation systems for the end-user control.

Download Smart IP Manager at <https://www.genelec.com/smart-ip-manager> and follow screen instructions to install. For detailed use of the Genelec Smart IP manager software, please refer to Smart IP Manager operating manual.

Zone settings

A zone is a collection of loudspeakers working as a system. The settings collectively applied to a selection of loudspeakers called the Zone includes

- mute
- zone level control
- settings profile selection

Normally, level is adjusted at the stream source. In the Smart IP manager software, the output level of the Zone or a complete system can be set by adjusting the level in the Smart IP Manager software using the '-' and '+' buttons.

Each zone can have up to five different Profiles. A Profile contains a collection of settings including settings of all acoustical controls, the input selection and the level and delay alignments. These are first designed and stored in each loudspeaker. Then, each zone can work as a system. Selecting a Profile will collectively recall all setting stored under this profile in each loudspeaker belonging into this Zone.

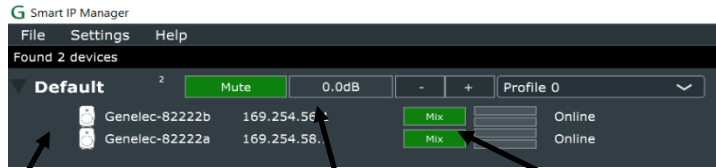

Unallocated Smart IP devices are listed under “Default” zone.

Zone can be muted and level controlled with ‘-’ and ‘+’ buttons.

Turn on audio inputs:
mix → stream in →
analogue in → no input →
mix.

Figure 9. Controlling the zone with Smart IP Manager software.

Editing acoustic settings

The frequency response of the 4420A can be compensated for the room’s acoustical influences by editing the settings in the Acoustics tab in the Genelec Smart IP Manager. Acoustical calibration settings are specific to each loudspeaker.

To set, select one or more loudspeakers in the device list. Selecting more than one loudspeaker applies the settings to all selected loudspeakers at once.

To adjust, select the Acoustics tab. You have several controls in the tab

- delay (delay alignment control)
- sensitivity (to align this loudspeaker output level with other loudspeakers)
- 20 parametric acoustic settings (to compensate to room acoustic influences)

The acoustic measuring tool normally used by AV installers can be used to set these adjustments. Careful listening with test recordings is also recommended.

For each parametric filter, select the filter by clicking on the filter box icon. Select the function for this filter in the Type drop down box. Each parametric filter has up to three slider controls that set the parameter values. Quick selections are also provided for Bass Roll-off, Bass Tilt and Treble Tilt.

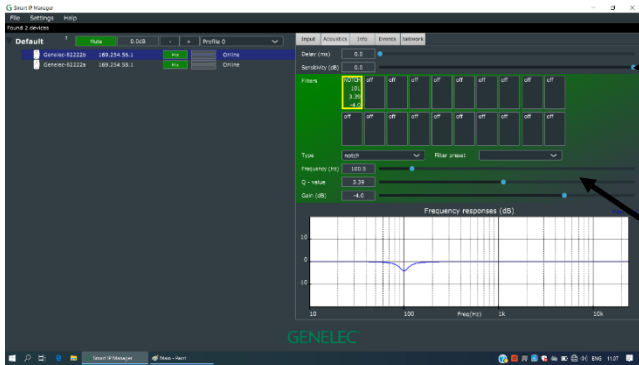

Set 'delay' and 'sensitivity' as needed.

Click on a filter button, select 'filter type' and adjust parameters.

Select 'preset' to assign all parameters for selected speaker.

Figure 10. Modifying the acoustic settings of Smart IP loudspeaker.

Factory settings

The factory setting for all acoustic settings is “OFF”, sensitivity attenuator set to 0 dB, and delay set to 0 ms. These give a flat anechoic response. Both the audio-over-IP stream and analogue inputs are selected to play. Audio stream settings are reset. With the factory settings, all that is needed to play audio is to provide a signal to the analogue input or to configure an audio-over-IP stream in the stream input. Set stream again to resume normal streaming operation.

To reset 4420A to factory settings, press the power button for more than 10 seconds. The loudspeaker indicates that the reset process starts. Then, you can release the power button but do not disconnect power supplied by the Ethernet cable until the reset process is complete. Once the reset is complete, the loudspeaker again becomes available and active on the Smart IP Manager software. This typically takes less than one minute.

APPLICATION PROGRAMMING INTERFACE (API)

4420A Smart IP loudspeaker has a set of API commands that can be used to enable control of 4420A using a house automation system or similar IP network connected device. The document describing the API command and how to use them is available from Genelec. Please visit www.genelec.com.

MAINTENANCE

There are no user-serviceable parts in the loudspeaker. Maintenance or repair of the 4420A must only be done by Genelec authorised service personnel. This is particularly important to maintain.

SAFETY CONSIDERATIONS

The 4420A has been designed in accordance with international safety standards. The following warnings and cautions must be observed to ensure safe operating conditions:

- Servicing and adjustment may only be performed by qualified service personnel.
- The loudspeaker must not be opened.
- Do not expose the loudspeaker to water or moisture.
- Do not place objects filled with liquid, such as vases, on the loudspeaker or near it.
- This loudspeaker can produce sound pressure levels in excess of 85 dB, which may cause permanent hearing damage.
- Free flow of air behind the loudspeaker is necessary to maintain sufficient cooling. Do not obstruct airflow around the loudspeaker.
- The loudspeaker is not disconnected from the power supply unless the CAT cable is removed from the loudspeaker. Powering down the speaker using the power switch does not disconnect power.
- Ensure that mountings for example to walls or ceilings are able to carry the full weight of the loudspeaker in all circumstances, the installations have been designed and are implemented according to the local safety regulations and follow principles of good workmanship.
- The Genelec products and accessories can come with instructions on the proper methods of installation and use. Follow these instructions.

GUARANTEE

This product is guaranteed for a period of two years against faults in materials or workmanship. Refer to supplier for full sales and guarantee terms.

Specifications

SYSTEM SPECIFICATIONS	
Lower cut-off frequency, -6dB	≤ 55 Hz
Upper cut-off frequency, -6dB	> 42 kHz
Frequency response within ± 1.5 dB	62 Hz – 20 kHz
Minimum delay from analogue input to acoustic output	2.3 ms
Maximum short-term sine wave output on axis in half space, average 100 Hz to 3 kHz, at 1 m, using PoE+ power	≥ 100 dB SPL
Maximum long-term RMS acoustic output in same conditions with IEC-weighted noise, at 1 m using PoE+ power (limited by driver unit protection circuit and the PoE power supply being used)	≥ 94 dB SPL
Maximum peak acoustic output per unit in a listening room with music material, at 1 m, using PoE+ power	> 104 dB SPL
Self-generated noise level in free space, at 1 m on the acoustical axis, A-weighted	≤ 5dB
Harmonic distortion at 85 dB SPL at 1 m on axis frequency range 50 – 200 Hz frequency range >200 Hz	< 3% < 0.5%
Dispersion angle (degrees), horizontal	120°
Dispersion angle (degrees), vertical	100°
Bass driver	105 mm (4 in) cone
Treble driver	19 mm (3/4 in) metal dome
Weight	3.1 kg
Height	226 mm (9 in)
Width	151 mm (6 in)
Depth	142 mm (5 2/3 in)

Maximum short-term output level is limited by the PoE technology being used and the crest factor of the audio signal. The stated values are typical for music and speech signals.

Maximum long-term output level can be further limited by loudspeaker system protection. Genelec recommends using PoE+ whenever possible. Using lower-power PoE can limit short-term maximum and long-term maximum, depending on the characteristics of the signal being reproduced.

User selectable filters can be set to positive gain. Positive gain must be used with care as it is possible to cause premature overload of the loudspeaker at specific frequencies.

INPUT / CROSSOVER SECTION	
Ethernet connection	100BASE-TX 1 x RJ45
Nominal SPL with 0 dBFS digital audio input at maximum sensitivity	130 dB SPL
Audio-over-IP streaming formats	AES67, ST2110-30, Dante
Analogue input, connector type	3 pin Euroblock
Analogue input, Input impedance	10 kOhm, balanced
Analogue input level for 100 dB SPL at 1 m	-6 dBu
Analogue input, maximum input signal	24dBu
Crossover frequency, bass/treble	2.9 kHz
Number of user-adjustable filters	20
User selectable filters, choice of function for each user-adjustable filter	parametric notch high frq. shelf low frq. shelf bass roll-off bass tilt treble tilt
User selectable filters, parameter adjustment ranges for a notch filter <ul style="list-style-type: none"> • gain • Q-value • center frequency 	-20...+2 dB 0.1...20 10 Hz...16 kHz
Sensitivity, adjustment range	-60...0 dB
Delay, adjustment range	0...98 ms

AMPLIFIER SECTION	
Bass amplifier output power, short-term	50W
Treble amplifier output power, short-term	50W
Supply power at switch, power-over-Ethernet PoE+ (Class 4) PoE (Class 3)	30 W 15.4 W
Supported PoE standards PoE+ (supports signature and LLDP) PoE (supports signature)	IEEE 802.3at IEEE 802.3af
CAT cable specification	5, 5e, 6
Maximum CAT cable length	100 m (333 ft)
Power consumption in idle	5 W
Power consumption in ISS power-down mode	4 W

MEASUREMENTS

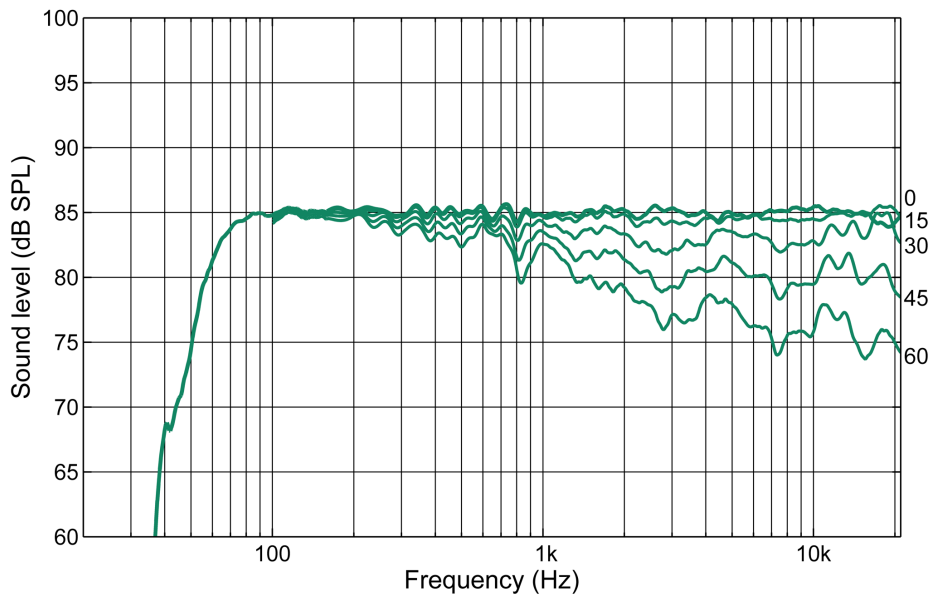

Figure 11. Frequency responses on the horizontal plane. Off-axis angle indicated in degrees.

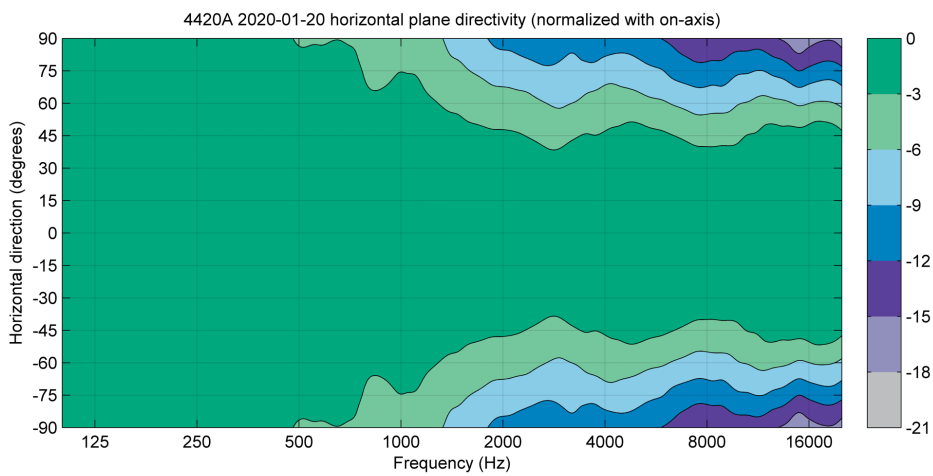

Figure 12. Horizontal directivity plot of the 4420A. Colour bar indicates dB level.

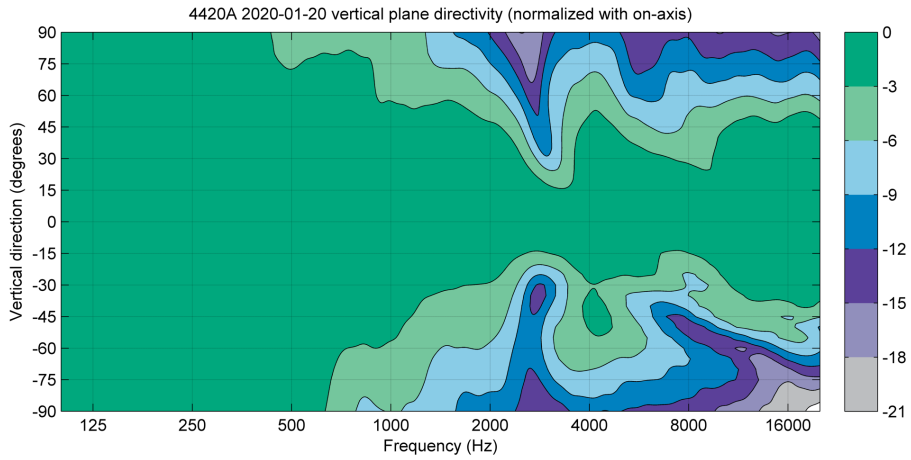

Figure 13. Vertical directivity plots of the 4420A. Colour bar indicates dB level.

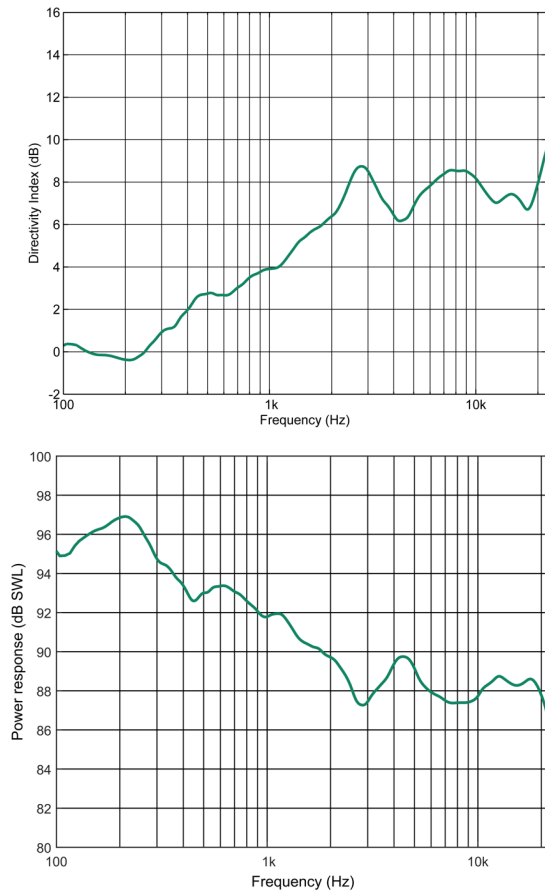

Figure 14. Directivity index (top) and power response (bottom).

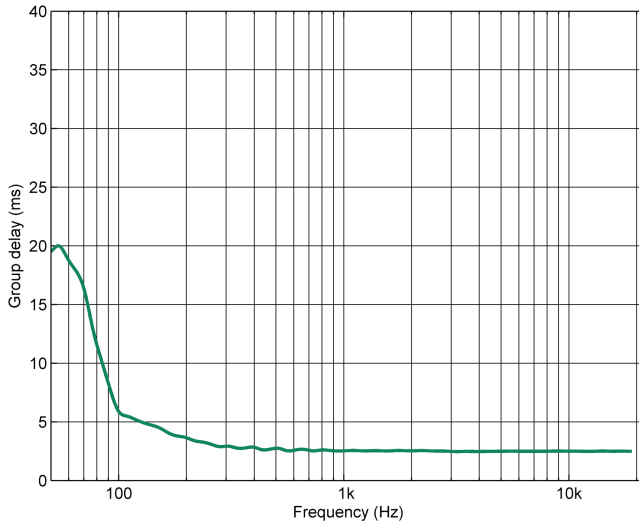

Figure 15. System delay from the analogue signal input to the acoustic output. For the audio-over-IP stream input, additional delay may result from the audio-over-IP transport.

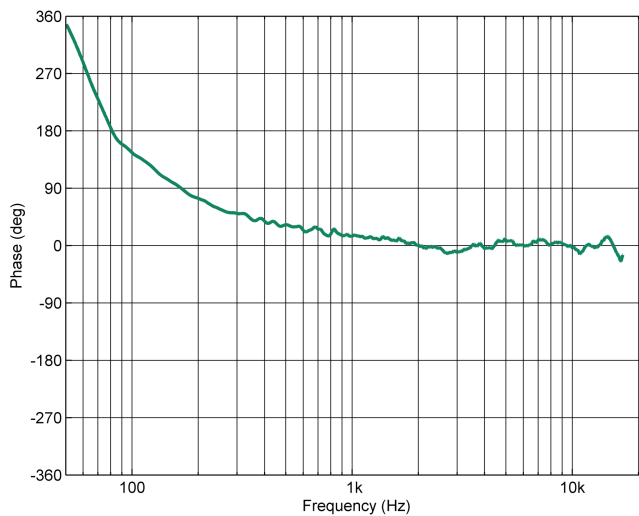

Figure 16. Phase response.

GENELEC®

International enquiries

Genelec, Olvitie 5
FI 74100, Iisalmi, Finland
Phone +358 17 83881
Fax +358 17 812 267
Email genelec@genelec.com

In Sweden

Genelec Sverige
Ellipsvägen 10A
SE-141 75 Kungens Kurva
Sweden
Phone +46 8 449 5220
Email sweden@genelec.com

In Denmark

Genelec Denmark
Danmarksvej 32D
8660 Skanderborg
Denmark
Phone +45 71 741 641
Email denmark@genelec.com

In the USA

Genelec, Inc., 7 Tech Circle
Natick, MA 01760, USA
Phone +1 508 652 0900
Fax +1 508 652 0909
Email genelec.usa@genelec.com

In China

Beijing Genelec Audio Co.Ltd
Room 101, Building B33
Universal Business Park
No. 10 Jiuxianquiao Road
Chaoyang District
Beijing 100015, China
Phone +86 10 5823 2014
Phone +86 400 700 1978
Email genelec.china@genelec.com

In Japan

Genelec Japan Inc
2-22-21 Akasaka
Minato-ku
JP-107-0052 Tokyo
Japan
Phone +81 3 6441 0591
Email genelec.japan@genelec.com

www.genelec.com