



Share Your Vision

A 1st-Generation Network and Serial Camera Controller

# PT-SUPERJOY-G1



## User Guide

V1.1



ptzoptics.com || 1 800 486-5276

## **Thank You!**

Thank you for selecting our joystick camera controller built to support both IP and serial communication. As you read through this manual it will help identify the options you have for setting up the device, connecting equipment as well as recommended configurations; as a result we recommend reading over this guide prior to beginning any setup to have the best possible experience.

-The PTZOptics team

## **Using this guide to Get Started**

We recommend that you read the entire user guide prior to any setup and please refer to the Table of Contents when attempting to locate specific product information or setup instructions.

### ***Copyright Notice***

*The entire contents of this manual / guide, whose copyright belongs to PTZOptics, may not be cloned, copied, or translated in any way without the explicit permission of the company. The product specifications referred to in this document are for reference only and as such are subject to updating at any time without prior notice.*

# What's in the Box?

- PT-SUPERJOY-G1 joystick controller
- 12V 2A international power supply
- 8' (2.4m) RS-232C / DB9 female to 8-pin mini-din male cable
- PTZOptics PT-SUPERJOY-G1 Quick Start Guide

## Introducing the PT-SUPERJOY-G1

The PT-SUPERJOY-G1 is designed to provide in depth control of the PTZOptics and HuddleCamHD line of cameras for use in production environments and more. With the ability to support both IP and Serial control from a single controller, the PT-SUPERJOY-G1 presents itself as a flexible control solution.

When used via a Local Area Network (LAN), you can connect to cameras using TCP or UDP communications to send PTZOptics VISCA over IP commands, with limited support for NDI & Sony VISCA over IP capable cameras. If using the serial connections via RS-232, RS-485 or RS-422 you have PTZOptics VISCA commands, Pelco-D, Pelco-P and limited Sony VISCA support.

*Note using this with non PTZOptics or HuddleCamHD products may offer limited or no control capabilities.*



You can view the PTZOptics VISCA and VISCA over IP command libraries at [ptzoptics.com/downloads/](http://ptzoptics.com/downloads/)

## How to care for your PT-SUPERJOY-G1

Please read the recommendations below to ensure you do not damage the product or possibly void your warranty.

- Keep the joystick away from rain and out of moist environments
- Do not remove any portions of the case, cover or interfaces
  - Removal may result in the risk of an electrical shock
  - Removal will void the manufacturer's warranty.
- Only use the product within the recommended temperature and humidity ranges
  - Operating temperature range: 14° ~ 122°F (-10° ~ +50°C)
  - Operating humidity range: 10 ~ 90% *\*Non-condensing*
- Do not use any other power supply than the one originally supplied with the joystick.
- Keep the joystick and signal cables away from strong electromagnetic sources or abnormal and unreliable control may be experienced
- If you need to clean the surface of the product please use a soft dry cloth.
  - If the joystick becomes extremely dirty, use a diluted neutral detergent to clean the surface.
  - Do not use any type of solvents, which may damage the surface of the product.

*In case of abnormal operation, please contact our support team at [support@ptzoptics.com](mailto:support@ptzoptics.com)*

# Table of Contents

<a href="#">Preface</a>	i
<a href="#">Copyright Notice</a>	i
<a href="#">What's in the Box</a>	ii
<a href="#">Introducing the PT-SUPERJOY-G1</a>	ii
<a href="#">How to care for your PT-SUPERJOY-G1</a>	ii
<a href="#">Table of Contents</a>	iii
<a href="#">PT-SUPERJOY-G1 Overview</a>	1
<a href="#">Top Down View &amp; Layout</a>	1
<a href="#">Button &amp; Dial Descriptions</a>	2
<a href="#">Rear Panel View &amp; Layout</a>	4
<a href="#">Technical Specifications</a>	5
<a href="#">Preparing to use the Joystick</a>	6
<a href="#">Installation and Setup</a>	6
<a href="#">Power</a>	6
<a href="#">Physically Connecting a Camera to the Controller</a>	6
<a href="#">Network Setup</a>	7
<a href="#">Serial Control Setup &amp; Options</a>	8
<a href="#">Adding a Camera</a>	9
<a href="#">From the Joystick</a>	9
<a href="#">From the Web Interface</a>	10
<a href="#">Joystick OSD Menu Control</a>	11
<a href="#">Operating the Camera</a>	12
<a href="#">Pan, Tilt, &amp; Zoom Operations</a>	12
<a href="#">Setting and Calling Presets</a>	12
<a href="#">Adjusting the Camera's Image</a>	13
<a href="#">Camera OSD Menu Control</a>	14
<a href="#">Basic Mode</a>	14
<a href="#">Matrix Mode</a>	14
<a href="#">Joystick Web Interface</a>	15
<a href="#">Device Management</a>	15
<a href="#">Settings</a>	16
<a href="#">Troubleshooting and Extras</a>	17
<a href="#">Troubleshooting</a>	17
<a href="#">Additional Information</a>	18
<a href="#">Warranty</a>	18
<a href="#">Certifications</a>	18
<a href="#">Changelog</a>	18

# PT-SUPERJOY-G1 Overview

## Top Down View & Layout

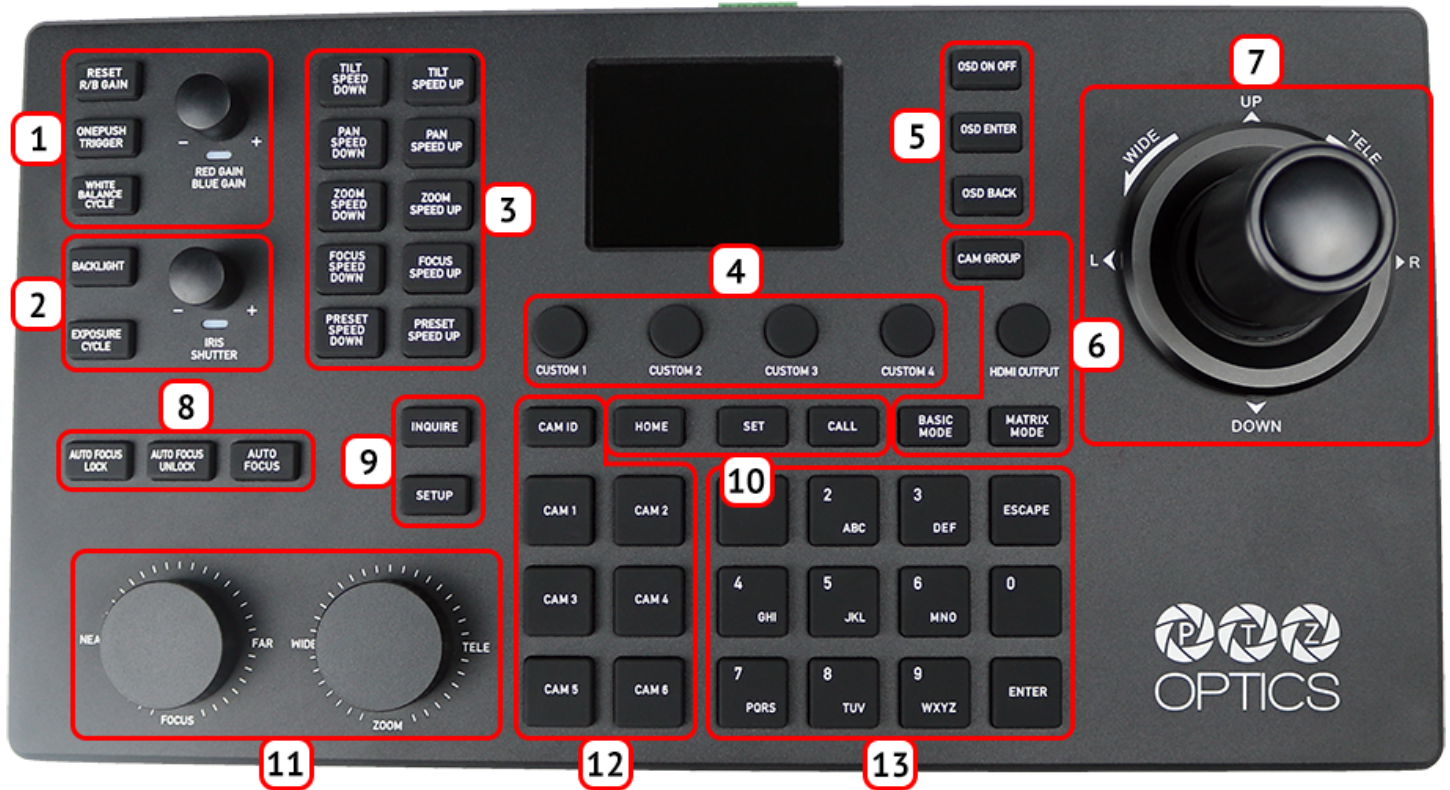

1. White Balance Control
2. Exposure Control
3. Speed Control
4. Custom Control Buttons
5. Camera OSD Control
6. SuperJoy Unique Control
7. Joystick Controller

8. Focus Mode Control
9. Controller Information
10. Preset Control Buttons
11. Focus & Zoom Control Dials
12. Camera Select Control
13. Alpha-Numeric Keypad

## Button & Dial Descriptions

The below descriptions will describe the buttons and dials available on the controller.

### 1. White Balance Control

The White Balance Control section allows you to adjust the white balance settings of the camera.

- a. **[RESET R/B GAIN] Button**  
Press the [RESET R/B GAIN] button to reset the red & blue gain to default values.
- b. **[ONEPUSH TRIGGER] Button**  
Press the [ONEPUSH TRIGGER] button allows you to
- c. **[WHITE BALANCE CYCLE] Button**  
Press the [WHITE BALANCE CYCLE] button to cycle through the White Balance Modes. Options include: Auto, Indoor, Outdoor, OnePush, & Manual.
- d. **[RED GAIN / BLUE GAIN] Knob**  
The [RED GAIN / BLUE GAIN] knob can be used to adjust the red & blue gain values.

### 2. Exposure Control

The Exposure Control section allows you to adjust the exposure settings of the camera.

- a. **[BACKLIGHT] Button**  
Press the [BACKLIGHT] button to toggle the camera's backlight compensation.
- b. **[EXPOSURE CYCLE] Button**  
Press the [EXPOSURE CYCLE] button to cycle through the Exposure Modes. Options include: Auto, Manual, Shutter Priority, Iris Priority, & Brightness Priority.
- c. **[IRIS / SHUTTER] Knob**  
The [IRIS / SHUTTER] knob allows you to adjust the Iris and Shutter values of the camera.

### 3. Speed Control Buttons

Use the Speed Control section to adjust the speeds the joystick controls the camera(s).

- a. **[TILT SPEED UP / DOWN] Buttons**  
Press the [TILT SPEED UP / DOWN] buttons to adjust the camera tilt speed.
- b. **[PAN SPEED UP / DOWN] Buttons**  
Press the [PAN SPEED UP / DOWN] buttons to adjust the camera pan speed.
- c. **[ZOOM SPEED UP / DOWN] Buttons**  
Press the [ZOOM SPEED UP / DOWN] buttons to adjust the camera zoom speed.
- d. **[FOCUS SPEED UP / DOWN] Buttons**  
Press the [FOCUS SPEED UP / DOWN] buttons to adjust the camera focus speed.
- e. **[PRESET SPEED UP / DOWN] Buttons**  
Press the [PRESET SPEED UP / DOWN] buttons to adjust the camera preset speed.

### 4. Custom Control Buttons

Use the Custom Control buttons to set up custom commands typically not available to the SuperJoy.

- a. **[CUSTOM 1 - 4] Button**  
The four (4) Custom buttons allow you to send custom commands to network based equipment. Options include: HTTP Trigger, UART, TCP, UDP, & Super Presets.

### 5. Camera OSD Control Buttons

The Camera OSD Control section allows you to open and adjust the camera's on screen display menu.

- a. **[OSD ON / OFF] Button**  
Press the [OSD ON / OFF] button to open and close the on screen display menu. Move the joystick up, down, left, and right to traverse the camera's OSD menu.
- b. **[OSD ENTER] Button**  
Press the [OSD ENTER] button to select an OSD menu option.

c. **[OSD BACK] Button**

Press the [OSD BACK] button to go back an OSD menu option.



Refer to the Camera OSD Menu Control section of this guide for more information.

6. **SuperJoy Unique Control**

The SuperJoy includes unique buttons for use with

a. **[CAM GROUP] Button**

Press the [CAM GROUP] button to cycle through the four (4) Camera Groups.

b. **[HDMI OUTPUT] Button**

Press the [HDMI OUTPUT] button to enable the HDMI output of the connected camera.

c. **[BASIC MODE] Button**

Press the [BASIC MODE] button to toggle between Basic Mode control and normal control.

d. **[MATRIX MODE] Button**

Press the [MATRIX MODE] button to toggle between Matrix Mode control and normal control.

7. **Joystick Controller**

The joystick allows you to pan, tilt, and zoom (twist) the camera. The control speed is affected by the Speed Control dial.

8. **Focus Mode Control**

The Focus Mode section allows you to change the focus mode of the camera.

a. **[AUTO FOCUS LOCK] Button**

Press the [AUTO FOCUS LOCK] button to lock the focus in its current position.

b. **[AUTO FOCUS UNLOCK] Button**

Press the [AUTO FOCUS UNLOCK] button to unlock the focus from its current position.

c. **[AUTO FOCUS] Button**

Press the [AUTO FOCUS] button to set the camera to auto focus mode.

9. **Controller Information Button**

The Controller Information section allows you to find and edit the parameters of the controller.

a. **[INQUIRE] Button**

Press the [INQUIRE] button to open the controller's device list.

b. **[SETUP] Button**

Press the [SETUP] button to open the controller's OSD menu.



Refer to the Joystick OSD Menu Control section of this guide for more information.

10. **Preset Control Buttons**

The Preset Control section allows you to set and call presets of the camera.

a. **[HOME] Button**

Press the [HOME] button to send the camera to the home position (facing forward).

b. **[SET] Button**

Press the [SET] button to set a camera preset. Use the alpha-numeric keypad to set a preset number.

c. **[CALL] Button**

Press the [CALL] button to call a camera preset. Use the alpha-numeric keypad to call a preset number.



Refer to the Setting and Recalling Presets section of this guide for more information.

d. **Quick Set Preset Shortcut**

Press and hold a number on the alpha-numeric keypad for 3+ seconds to set a camera preset in the current location.

**e. Quick Call Preset Shortcut**

Quickly press a number on the alpha-numeric keypad to call a camera preset.

**11. Focus & Zoom Control Dials**

The Focus & Zoom Control section allows you to adjust the image based on the scene.

**a. [FINE TUNE FOCUS] Dial**

The [FINE TUNE FOCUS] dial allows you to finely zoom the camera in and out at the lowest speed (1).

**b. [FINE TUNE ZOOM] Dial**

The [FINE TUNE ZOOM] dial allows you to finely zoom the camera in and out at the lowest speed (1).

**12. Camera Select Buttons**

The Camera Select section allows you to select a camera to control.

**a. [CAM ID] Button**

The [CAM ID] button allows you to select any camera on the controller using the alpha-numeric keypad.

**b. [CAM #] Button**

The [CAM #] button allows you to quickly select a camera to control.

Options include: 1 - 6.

**13. Alpha-Numeric Keypad**

The alpha-numeric keypad allows you to use many of the controller features that require numbers and letters.



## Rear Panel View & Layout

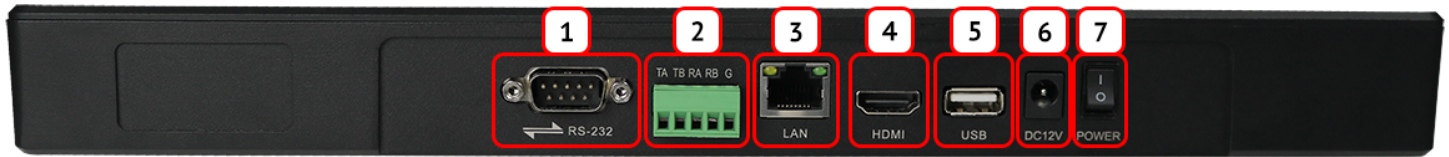

1. RS-232 Control Connection
2. RS-422 / RS-485 Control Connection



Refer to the Physically Connecting a Camera to the Controller section of this guide for more information.

3. Ethernet / RJ-45 (PoE) Network Connection  
Supports 802.3af PoE power
4. HDMI Output Connection
5. USB Port Connection
6. 12VDC Power Connection
7. Power Switch

# Technical Specifications

<b>Control Interfaces</b>	Network: NIC (TCP and UDP) Serial: RS-232 Full Duplex, RS-485 Semi Duplex, RS-422 Full Duplex
<b>Protocols</b>	PTZOptics VISCA and VISCA over IP PELCO-D and PELCO-P via Serial Ports Limited Sony VISCA and VISCA over IP support Limited ONVIF support Limited NDI support
<b>Variable Baud Rate</b>	1200 to 19200 bps
<b>Maximum Cable Distance*</b>	Ethernet: 328 feet   100 Meters RS-232: 50 feet   15 Meters RS-485: 3,937 feet   1200 Meters RS-422: 50 feet   15 Meters
<b>Maximum Cameras</b>	28 channels / cameras
<b>Power Voltage</b>	12V DC
<b>Power Consumption</b>	6W
<b>Power over Ethernet</b>	802.3af
<b>Working Temperature</b>	14° F ~ 122° F (-10° C ~ +50° C)
<b>Working Humidity</b>	10% ~ 90% (non condensation)
<b>Weight</b>	3.75 lbs   1.70 kg
<b>Dimensions</b>	13.94in W x 7.09in D x 1.97in H (3.98in H including joystick) 354mm W x 180mm D x 50mm H (101mm H including joystick)
<b>Shipping Weight</b>	5.80 lbs   2.63 kg
<b>Box Dimensions</b>	14.57in W x 8.46in D x 4.61in H 370mm W x 215mm D x 117mm H
<b>Warranty</b>	2 Year Manufacturer Warranty

*\*Using high quality certified cabling*

# Preparing to use the Joystick

## Installation & Setup

### Power

You can power your joystick using the included power supply or Power over Ethernet (802.3af). After applying power make sure that the I/O switch is flipped to “1” for “On”.



*Do not power the joystick controller using PoE and the power supply at the same time.*

### Physically Connecting a Camera to the Controller

To connect to a camera, you first need to decide which supported control method you need

**Network Control:** To control your camera(s) over a network, connect an ethernet cable from your Local Area Network (LAN) to the controller and another one to the camera. Afterwards, add the camera’s IP address to the joystick’s list of cameras and designate a control address. *\*These steps are detailed in the [Adding a Camera](#) section*

**Serial RS-232 Control:** To control your camera(s) over a serial connection, use the included RS-232C cable to connect the joystick and the camera. Then, designate a control address for the camera. *\*These steps are detailed in the [Adding a Camera](#) section*

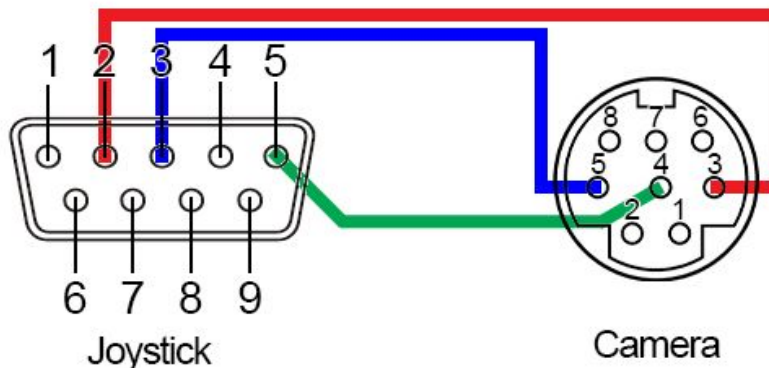

**Serial RS-485 Control:** To control your camera(s) over an RS-485 connection, see below.

- Joystick Ta - Pin 1 - Camera (+)
- Joystick Tb - Pin 2 - Camera (-)
- Joystick GND - Pin 5 - Camera (G) (If present. Some cameras won’t require ground)

**Serial RS-422 Control:** To control your camera(s) over an RS-422 connection, see below.

- Joystick Ta - Pin 1 - Camera (Rx-)
- Joystick Tb - Pin 2 - Camera (Rx+)
- Joystick Ra - Pin 3 - Camera (Tx-)
- Joystick Rb - Pin 4 - Camera (Tx+)
- Joystick GND - Pin 5 - Camera (G) (If present. Some cameras won’t require ground)



For a more in-depth guide to adding cameras to the joystick, check out the [Adding a Camera](#) section

## Network Setup

The PT-SUPERJOY-G1 will dynamically obtain an IP address upon connection to your LAN. If your network is not able to supply DHCP addresses you must assign a static IP address to the controller.

To set a static IP address, follow the steps below.

1. Obtain the IP address scheme of your network.
2. Connect your joystick to power and to your network.
3. Press the [SETUP] button, and move down to option 4. Network Connection.
4. Move the joystick left or right to “Static”, and press the [ENTER] key to set the static IP address.
5. Enter an available IP address similar to the IP address scheme of your network using the alpha-numeric keypad.
6. Enter the Gateway and Subnet Mask of your network.
7. When all the fields are filled, press the [ENTER] key to restart the joystick with the assigned static IP address.



For more information on methods to obtain your network information such as the IP address, Default Gateway, and Subnet Mask refer to the following PTZOptics [Knowledge Base Article](#).



Note that If any aspect of your network scheme only requires 1 or 2 digits (e.g. 192.168.1.150), you can move the joystick right to advance to the next field.

## Serial Control Setup & Options

To control cameras using serial communications, first review the above section marked “[Physically Connecting a Camera](#)” to select the appropriate option for your setup.

Once you have selected a serial communications method, connect the appropriate cable to the joystick's selected control port, and then to the camera's matching control input (RS-485 or RS-232).

When controlling multiple cameras, you have two (2) methods of connection. The two (2) methods consist of “Daisy Chaining” and a “Home-Run” setup.

### Daisy-Chain

To utilize a Daisy-Chaining setup, you will first connect the joystick to camera 1, then connect camera 2 to camera 2, etc. Daisy-Chaining can be used with both RS-232 & RS-485. Please use the figures below for reference.



Daisy-Chain Connection Guide

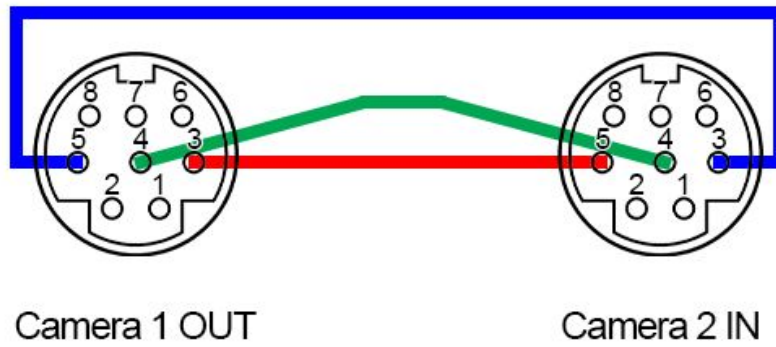

Camera 1 OUT

Camera 2 IN

RS-232 Daisy-Chain connection



RS-485 Daisy-Chain connection

**Home-Run**

To utilize a Home-Run setup, you will need to connect all the cameras to the controllers' 5 port phoenix connector. Home-Run setups can be used with both RS-485 & RS-422. Please use the figures below for reference.



Home-Run Connection Guide



RS-485 Home-Run connection

## Adding a Camera

### From the Joystick

To add a camera to the joystick from using the OSD setup menu, follow the steps below.

1. Adding an IP camera
  - a. Press the [SETUP] button, and select option one (1) “Network Device” for IP
  - b. Fill out the Network Device fields to connect your camera.  
Channel: Joystick Camera Address [CAM ID]. Options include 1 - 7.  
Protocol: Options include VISCA (UDP), VISCA (TCP), Sony VISCA (UDP), ONVIF, & NDI.  
IP: Camera IP address  
Ctrl Port: Camera control port.
  - c. Once the above fields are filled, press the [ENTER] button to save the camera to the controller.



*For PTZOptics and HuddleCamHD cameras, by default, the port assignments are 1259 for UDP control and port 5678 for TCP control.*

2. Adding a Serial camera
  - a. Press the [SETUP] button, and select option two (2) “Analog Device”
  - b. Fill out the Analog Device fields to connect your camera.  
Channel: Joystick Camera Address. Options include: 1 - 7.  
Protocol: Control protocol. Options include: VISCA, PELCO-D, & PELCO-P  
Address: Camera control address. For best results, set Joystick & Camera control address to the same value.  
Baud Rate: Baud rate. Options include: 1200, 2400, 4800, 9600, 19200, 38400, & 115200. For best results, use 9600.
  - c. Once the above fields are filled, press the [ENTER] button to save the camera to the controller.

## From the Web Interface

To add a camera to the controller from the web interface, follow the steps below.

1. Type the IP address displayed on the controllers OSD into a web browser to access the web interface.
2. Type in the login credentials to access the joysticks WebUI configuration page.
  - a. Default username: “admin”
  - b. Default password: (there is no password by default)
3. Click the Group # of the camera(s) you wish to configure.
4. Click the Modify button under the “Operate” column of the camera address you wish to configure a camera for.

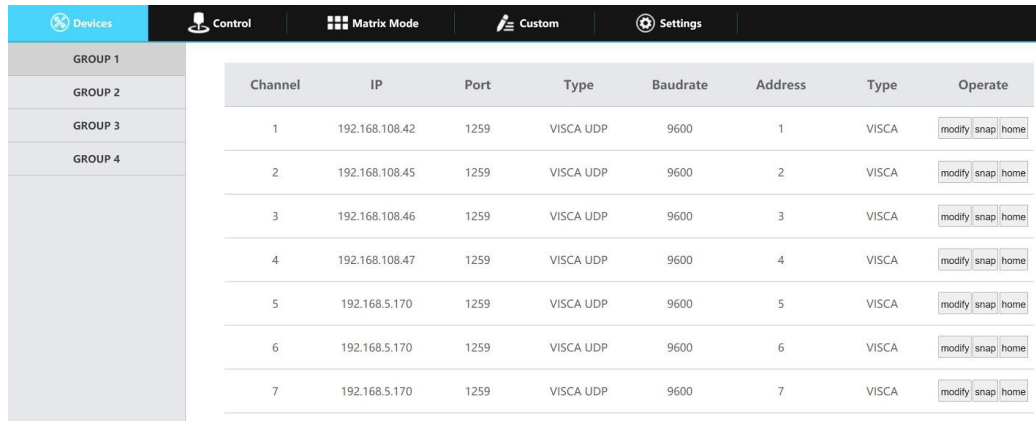

Channel	IP	Port	Type	Baudrate	Address	Type	Operate
1	192.168.108.42	1259	VISCA UDP	9600	1	VISCA	modify snap home
2	192.168.108.45	1259	VISCA UDP	9600	2	VISCA	modify snap home
3	192.168.108.46	1259	VISCA UDP	9600	3	VISCA	modify snap home
4	192.168.108.47	1259	VISCA UDP	9600	4	VISCA	modify snap home
5	192.168.5.170	1259	VISCA UDP	9600	5	VISCA	modify snap home
6	192.168.5.170	1259	VISCA UDP	9600	6	VISCA	modify snap home
7	192.168.5.170	1259	VISCA UDP	9600	7	VISCA	modify snap home

5. From here, fill out the information based on the deployed connection to the camera, with your options detailed below.

- **Network:**

- **Protocol:** Options include: VISCA (UDP), VISCA (TCP), SONY VISCA (UDP), ONVIF, & NDI.
- **IP:** Enter the IP address of your camera
- **Port:** Enter the control port of your camera

- **Serial:**

- **Protocol:** Options include: VISCA, PELCO-D, & PELCO-P
- **Baud Rate:** Options include: 1200, 2400, 4800, 9600, 19200, 38400, & 115200
- **Address:** (Unchangeable) This address matches the camera address at the top of the window.

6. Once the above fields are filled, click the Save button to finish adding the camera to the controller.

Channel:

**Network:**

Protocol:

IP:

Ctrl Port:

Rtsp User:

Rtsp Pwd:

Rtsp Url:

**Analog:**

Protocol:

Baudrate:

Address:

# Joystick OSD Menu Control

## 1. Add Network Device



Refer to the [Adding a Camera](#) section of this guide for more information.

## 2. Add Serial Device



Refer to the [Adding a Camera](#) section of this guide for more information.

## 3. Device List

- Move the joystick to see the current configuration of the 28 channels.
- Move the joystick up or down to traverse the menu by increments of 1.  
Move the joystick left or right to traverse the menu by increments of 5.

## 4. Network Connection



Refer to the [Network Setup](#) section of this guide for more information.

## 5. Language

- Move the joystick left or right to adjust the language.  
*Options include: English*

## 6. Button Tone

- Move the joystick left or right to select On or Off.
- After making a selection, press the [ENTER] button to apply.

## 7. Upgrade Firmware (USB)

- Connect a USB drive to the USB 2.0 port on the back of the SuperJoy with a SuperJoy firmware file.
- After making the connection, press the [ENTER] button to start.

## 8. Import Config (USB)

- Connect a USB drive to the USB 2.0 port on the back of the SuperJoy with a SuperJoy export file.
- After making the connection, press the [ENTER] button to import the settings.

## 9. Export Config (USB)

- Connect a USB drive to the USB 2.0 port on the back of the SuperJoy.
- After making the connection, press the [ENTER] key to export the SuperJoy's settings.

## 10. Restore Factory

- Press the [ENTER] button to restore the joystick to factory default settings.
- You will be prompted to confirm, press the [ENTER] key again to restore to factory default, or press the [ESC] button to cancel.



*Restoring the joystick to factory default settings will remove all cameras, set all control speeds back to default, and reset network information.*

## 11. System Info

- Press the [ENTER] button to view the controller's system information. Includes: Software Version, Hardware Version, Web Version, Gateway, & Subnet Mask.



# Operating the Camera

To begin remotely operating a camera, you will first need to use the Camera Select buttons to begin using the controller. Once selected, you will have full remote operation of the camera from the controller.

## Pan, Tilt, and Zoom Operation

The controller supports variable speed pan / tilt / zoom control, which allows you to set the control speeds prior to use.

You can adjust the control speed using the Speed Buttons located on the left of the LCD screen. Once the control speeds are set to a comfortable value, you can use the joystick controller to move the camera.

In addition to the joystick itself, you can use the Fine Tune Zoom Dial to zoom in and out at the slowest possible speed.

## Setting and Recalling Presets

Using the Quick Presets you can set and call presets 0 - 9 using the Alpha-Numeric keypad by following the steps below.

### Quick Presets:

1. Move the camera to the location you wish to set the preset.
2. Press and hold one of the Alpha-Numeric buttons for 3+ seconds to set the corresponding preset.



The controller OSD will notify you upon successfully storing a quick preset.

3. To call a Quick Preset, tap one of the Alpha-Numeric buttons.

Alternatively, you can use the Set and Call buttons to set or call presets 0 - 255.

### Set and Call:

1. Move the camera to the location you wish to set the preset.
2. Press the [SET] button.
3. Using the Alpha-Numeric keypad, type in a preset number to associate with the preset. Press [ENTER] to save the preset.
4. To call a preset, press the [CALL] button, and type in a preset number. Press the [ENTER] key to call the preset.



When using a PTZOptics camera, you can call a preset at a specific focus value by setting the preset while in manual focus mode.

### Home Button

- Use the Home Button to send the camera to the Home position (facing forward).

## Adjusting the Camera's Image

There are many options for adjusting the camera's image which we will detail below

You can adjust White Balance & Exposure settings, Red & Blue Gain, Iris, Shutter, Focus, & Backlight Compensation to achieve the desired image style and quality.

- **White Balance Control:** Use the [WHITE BALANCE MODE] button to cycle through the camera's White Balance modes. Options include: Indoor White Balance, Outdoor White Balance, One Push White Balance, Manual White Balance, & Auto White Balance respectively.

You can use the [R GAIN / B GAIN] Knob to adjust the Red & Blue Gain values.

Press the knob to toggle between Red Gain and Blue Gain. For adjustment when in supporting White Balance Modes.



*The camera will automatically change to Manual White Balance upon twisting the R Gain / B Gain Knob.*

*When the camera is in One Push White Balance, you can press the [ONEPUSH TRIGGER] button from the White Balance Control section of the controller to calibrate the white balance.*

- **Exposure Control:** Use the [EXPOSURE MODE] button to cycle through the camera's Exposure modes. Options include: Manual Exposure, Shutter Priority, Iris Priority, Brightness Priority, & Auto Exposure respectively.

You can use the [IRIS / SHUTTER] Knob to adjust the Iris and Shutter values.

Press in the knob to toggle between Iris and Shutter. For adjustment when in supporting Exposure Modes.



*The camera will automatically change to Manual Exposure upon twisting the Iris / Shutter Knob.*

- **Focus Control:** Twist the [FOCUS] Dial towards Near or Far to focus the camera on a subject. You can press the [AUTO FOCUS] Button to enable AutoFocus mode.



*PTZOptics cameras will return to Auto Focus mode upon zooming in or out. You can lock the camera's focus from returning to Auto Focus mode by pressing the [AUTO FOCUS LOCK] button. While the focus is locked, you have full manual focus control from the [FOCUS] Dial. Press the [AUTO FOCUS UNLOCK] button to return to normal focus control.*

- **Backlight Compensation:** Press the [BACKLIGHT] button to enable or disable Backlight Compensation.

## Camera OSD Menu Control

To access the camera's On Screen Display, OSD, menu and fine tune the camera, follow the steps provided below.

1. Press the [OSD ON / OFF] button.
2. Move the joystick up or down to traverse the camera's OSD menu.
3. Press the [OSD ENTER] button to select a specific option.
4. Move the joystick left and right to adjust the settings.
5. Press the [OSD BACK] button to return to the previous window.
6. Press the [OSD ON / OFF] button again to close the camera's OSD menu.



*PTZOptics cameras will automatically close their OSD Menu after 2 minutes 30 seconds of inactivity by default.*

## Basic Mode

Basic Mode allows you to disable most of the capabilities of the SuperJoy and limit the control to the joystick and/or calling presets.

1. Press the [BASIC MODE] button to enable Basic Mode with Joystick.
2. Press the [BASIC MODE] button again to enable Basic Mode without Joystick.
3. Press the [BASIC MODE] button again to disable Basic Mode.

## Matrix Mode

Matrix Mode allows you to disable most of the capabilities of the SuperJoy and limit the controls to calling presets 1 - 3 of cameras 1 - 3.

1. Press 1 - 3 on the alpha-numeric keypad to call camera 1 presets 1 - 3 respectively.
2. Press 4 - 6 on the alpha-numeric keypad to call camera 2 presets 1 - 3 respectively.
3. Press 7 - 9 on the alpha-numeric keypad to call camera 3 presets 1 - 3 respectively.

# Joystick Web Interface

## Device Management

The Device Management page, available from the controllers web interface, allows you to define new cameras and adjust already configured cameras.

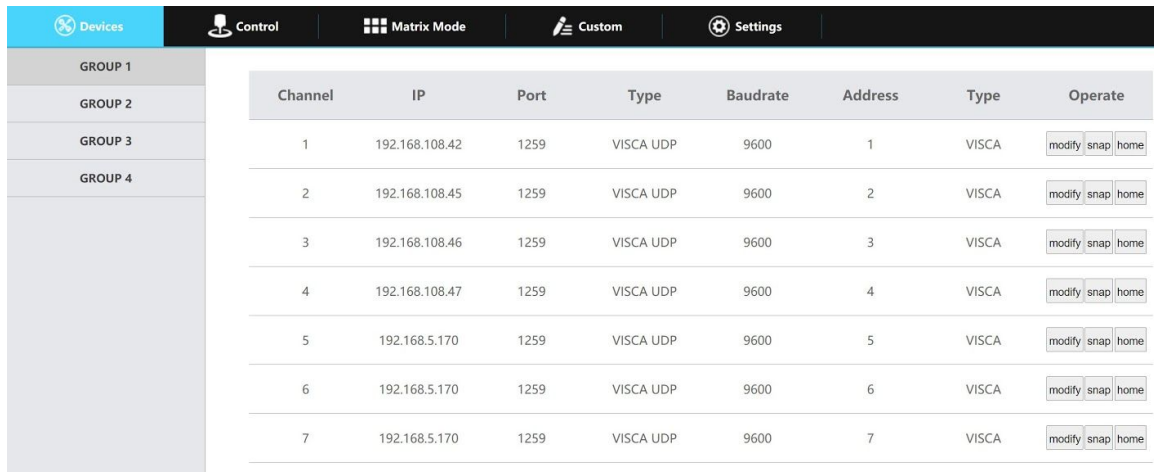

The screenshot shows the 'Devices' tab selected in the top navigation bar. Below the navigation bar, there are four groups (GROUP 1 to GROUP 4) listed on the left. The main area displays a table with 7 columns: Channel, IP, Port, Type, Baudrate, Address, and Operate. Each row represents a camera configuration. The 'Operate' column contains three buttons: 'modify', 'snap', and 'home'.

Channel	IP	Port	Type	Baudrate	Address	Type	Operate
1	192.168.108.42	1259	VISCA UDP	9600	1	VISCA	modify snap home
2	192.168.108.45	1259	VISCA UDP	9600	2	VISCA	modify snap home
3	192.168.108.46	1259	VISCA UDP	9600	3	VISCA	modify snap home
4	192.168.108.47	1259	VISCA UDP	9600	4	VISCA	modify snap home
5	192.168.5.170	1259	VISCA UDP	9600	5	VISCA	modify snap home
6	192.168.5.170	1259	VISCA UDP	9600	6	VISCA	modify snap home
7	192.168.5.170	1259	VISCA UDP	9600	7	VISCA	modify snap home

**Group 1-4:** Camera groups 1 - 4. Each group includes 7 channels / cameras.

**Channel:** Joystick control address.

Options include: 1 - 7 (IP & Serial)

**IP:** The IP address of the saved network camera.

**Port:** The control port of the saved network camera.

**Type (Network):** The control protocol of the saved network camera.

**Baudrate:** The baud rate of the saved serial camera.

**Address:** The camera control address of the saved serial camera.

**Type (Serial):** The control protocol of the saved serial camera.

**Operate:** Click “modify” to edit the settings of the saved camera. Use “snap” to take a snapshot of the camera’s current view. “Home” will allow you to send the camera to the home position.

 For more information on editing already configured cameras from the Device Management interface, check out the Adding a Camera > [From the Web Interface](#) section.

## Control

The Control page, available from the controllers web interface, allows you to call presets of the connected cameras. This page acts similarly to [Basic Mode without Joystick](#).

## Matrix Mode

The Matrix Mode page, available from the controllers web interface, allows you to call presets 1-3 of cameras 1-3. This page acts similarly to [Matrix Mode](#).

# Settings

The Settings interface allows you to adjust the configuration settings of the joystick.

**Network:** Allows configuration of the joystick's network configuration (DHCP / Static IP).

Options include: DHCP or Static IP Address, Subnet Mask, Gateway, DNS1, & DNS2.

**Upgrade:** Upgrade the joystick's firmware to the latest version.

**Factory Restore:** Restores the joystick to factory default settings.

**Restart:** Restart the joystick.

**Import:** Import joystick settings from PC.

**Export:** Export joystick settings to PC.

**User:** Add or edit admin and guest login credentials.

**System Settings:** Invert Pan and/or Tilt

**Version:** Displays the Hardware, Software, and Web firmware versions on the joystick.



*For more information on how to obtain an IP address, Default Gateway, & Subnet Mask, see the following PTZOptics Knowledgebase Article: [Discovering your Network IP Information](#)*

# Troubleshooting and Additional Information

## Troubleshooting

### LCD Display shows “Control Failure”

This can occur when the controller doesn't receive a response from the camera.

1. Please check that the network jacks you are using are active.
2. Please check that the network cable you are using is not failing.
3. Please check that the camera is supplying an Acknowledgement and Completion response.

### The joystick isn't controlling any cameras at all

This can occur when the camera(s) and/or joystick aren't properly set up.

1. Check that the network jacks you are using are active.
2. Check that the network or serial cables you are using are not failing.
3. Check that the camera control address matches the joystick control address.

### Multiple cameras are being controlled at once

This can occur when multiple cameras are set to the same joystick control address.

1. Check the camera's control addresses and ensure that each camera has a unique address.
  - a. Log into the WebUI and select Devices. Check that none of the connected cameras have the same control address.
  - b. Press the [INQUIRE] button to view the devices added to the joystick. Check that none of the added cameras have the same control address.

### Camera doesn't stop moving when the joystick controller is upright

This can occur when the joystick is in OSD Menu control mode or when the network is congested.

1. Move the joystick left and check that the LCD display says “Left”. LCD display will say “CAM Menu Left” while in OSD Menu control mode.
  - a. Power cycle the joystick.
  - b. Press [OSD OPEN/CLOSE], then [OSD ENTER], then press [OSD OPEN/CLOSE] twice.
2. Move the joystick to an isolated network and test again. If the issue ceases, the original network is congested and/or overloaded.

### Certain functions don't work with my camera

This can occur when you are not using a PTZOptics camera, or your camera's firmware isn't up to date.

1. Some functions do not work with non-PTZOptics cameras as each camera manufacturer has some of their own unique commands that may not be fully compatible with the design of this controller.
2. For PTZOptics cameras use the PTZOptics Firmware Finder to update your camera's firmware.



Check out the PTZOptics [Firmware Finder](#) to always have the latest features using your serial number.



Check out the PTZOptics [Knowledge Base](#) and [Forums](#) for troubleshooting.



Contact the PTZOptics Support Team, [Submit a Ticket](#) if you need some extra assistance.

## Additional Information

### Warranty

The PT-SUPERJOY-G1 includes a 2 Year Limited Warranty. This warranty covers all manufacturers defects, and any damage that is done to the joystick during shipping. This warranty does not cover physical damage to the joystick that is due to lack of proper care. If you have trouble with your joystick and wish to see if it is covered under the manufacturer's warranty, please contact our support team by submitting a ticket at <http://help.ptzoptics.com>.

### Certifications

This joystick has been tested and certified for the standards shown below

- FCC Class B - Tested under FCC 47 CFR Part 15 Subpart B, Class B(sDoC), ANSI C63.4 -2014
- CE - Tested under EMC Directive 2014/30/EU
  - EN 55032: 2015+A11:2020
  - EN 55035:2017+A11:2020
  - EN IEC 61000-3-2:2019
  - EN 61000-3-3:2013/A1:2019
- RoHS - Tested under RoHS Directive 2011/65/EU

### Changelog

Feb/2021 - Rev 1.1 - Added NDI support  
Sept/2020 - Rev 1.0 - Initial document.