

# DATA SHEET



## Community L SERIES Beamforming Venue Horn™

# LVH-906/AS

60° HORIZONTAL DISPERSION,  
ACTIVE STANDARD, 20°, 40°, 60° VERTICAL DISPERSION,  
ARRAYABLE, HIGH OUTPUT LOUDSPEAKER

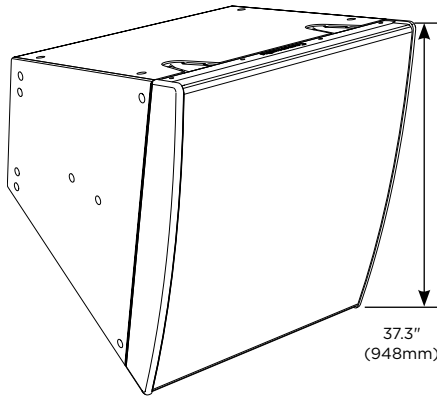

### FEATURES

- Designed for extraordinary performance in large venues
- Large format, horn-loaded triaxial array maintains pattern control to 400Hz
- Colinear manifold for HF and MF beamforming
- Indoor or Outdoor weather-resistant models

### TECHNICAL SPECIFICATIONS<sup>1</sup>

Operating Mode	Multi-Amplifier with FIR DSP Beamforming		
Operating Environment	Indoor or Outdoor Direct Exposure		
Operating Range (-10dB) <sup>2</sup>	60 Hz to 18 kHz		
Nominal Beamwidth	<b>Horizontal:</b> 60° <b>Vertical:</b> 60°, 40°, 20° Traditional symmetrical (FIR DSP user selectable presets)		
Transducers	<b>LF</b> - 4 x 12" (305mm) with 3" (76mm) CCAW voice coil, inherently weather-resistant cone in cast aluminum chassis <b>MF</b> - 3 x M200, 2" (51mm) exit, ketone polymer diaphragm, compression driver <b>HF</b> - 4 x 1.5" (38mm) CCAW voice coil, 1" (25mm) exit, ketone polymer diaphragm, compact neodymium compression driver		
Continuous Signal Voltage @ Nominal Impedance <sup>3</sup>	LF1, LF2 (each) MF 1 & 3 MF 2 HF 1 & 4 HF 2 & 3	89V, 8 ohms (178V peak) 26V, 5 ohms (52V peak) 26V, 10 ohms (52V peak) 23V, 8 ohms (46V peak) 23V, 8 ohms (46V peak)	
Crossover Frequencies	550 Hz, 2.5kHz		
Equalized Maximum SPL @ 1m <sup>4</sup>	Single - 20° pattern	Peak 143 dB	Continuous 137 dB
	Single - 40° pattern	142 dB	136 dB
	Single - 60° pattern	141 dB	135 dB
Recommended Amplifiers	DSP with Linear Phase FIR processing included in all Community Amplified Loudspeaker Controllers (ALC models)		
	LF1, LF2 (2 Ch.) All MF & HF (4 Ch.)	ALC-1604D (Bridged) ALC-404D	

### APPLICATIONS

Stadiums · Houses of Worship · Arenas  
Theaters · Ice Rinks · Auditoriums  
Large multipurpose outdoor and indoor venues

### DESCRIPTION

Biamp's Community L SERIES LVH-900/AS Beamforming Venue Horn™, combined with the Community Amplified Loudspeaker Controllers (ALCs), precisely tailors the directivity of each loudspeaker, or array of loudspeakers, to meet the sound requirements in any application.

Designed for exceptional performance in large venues, each LVH-906/AS (Active Standard) model consists of four 12-inch LF drivers, three Community M200 midrange compression drivers and four 1.5-inch HF compression drivers. Using patent-pending techniques, all drivers integrate into a single triaxial waveguide that fills the entire 36 x 31-inch face of the enclosure, providing pattern control to below 400 Hz. The LVH-906 offers 60° of fixed horizontal dispersion, and has presets for vertical dispersion beamforming in 60°, 40°, 20° configurations. The LVH-900 Active Standard (AS) models allow DSP settings and control of individual driver pairs to provide uniform sound to the audience areas.

Typical applications include music and speech reinforcement for large houses of worship, stadiums, theatres, and much more. Possessing advanced features, highly-focused dispersion patterns, weather-resistant construction, and most importantly sonic excellence, LVH-900 loudspeakers make installations not only fast and simple, but as functionally effective as possible.

*Biamp strives to improve its products on a continual basis. Specifications are therefore subject to change without notice.*

### PHYSICAL

Input Connection	Lever-actuated wire clamping 4 and 8-position terminal blocks
Mounting Points	(24) M10 rigging inserts
Operation Environment	<b>Indoor and Outdoor</b> <b>Outdoor:</b> IP56 per IEC 60529 when used with the input panel and seal cup cover plates; Weather resistant to IEC 60068-2-5 Solar Radiation, IEC 60068-2-11 Salt Mist, IEC 60068-2-42 SO2, IEC 60068-2-60 Chlorine, and IEC 60529 IP56 test conditions
Dimensions H x W x D	37.3" x 31.4" x 30.5" (948 x 797 x 775 mm)
Weight	250 lbs (113.4 kg) Indoor model 210 lbs (95.3 kg) Outdoor weather-resistant model
Finish	Refer to the Technical Drawing (page 5)

### OPTIONS

Accessories (full list on page 6)	<b>Splay Bracket:</b> LVH-900SP1 Type 1; LVH-900SP2 Type 2 <b>Indoor Frames:</b> LVH-900AF Array frame; LVH-900PB Pull-back; LVH-900UB U-Bracket (single cabinet only) <b>LVH-900ASPTP:</b> MF/HF Pass-Thru Panel <b>3rd party rigging:</b> Indoor & outdoor
-----------------------------------	---



# Community L SERIES Beamforming Venue Horn

## LVH-906/AS

60° HORIZONTAL DISPERSION,  
ACTIVE STANDARD, 20°, 40°, 60° VERTICAL DISPERSION,  
ARRAYABLE, HIGH OUTPUT LOUDSPEAKER

**20° VERT PATTERN**

### AXIAL PROCESSED SENSITIVITY (dB)<sup>5</sup>

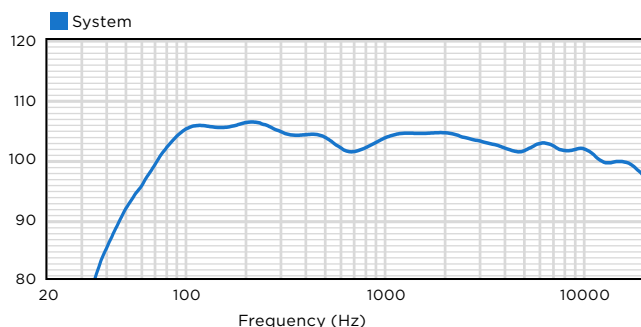

### HORIZONTAL OFF-AXIS RESPONSE (dB)<sup>6</sup>

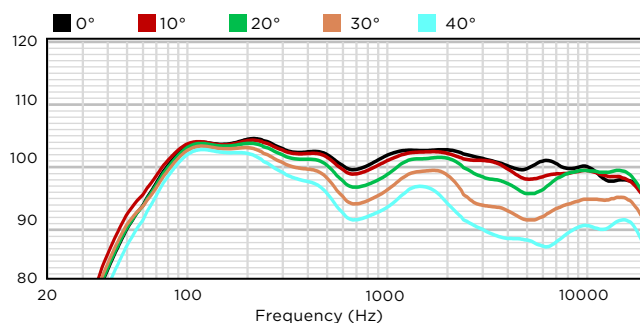

### IMPEDANCE (Ohms)

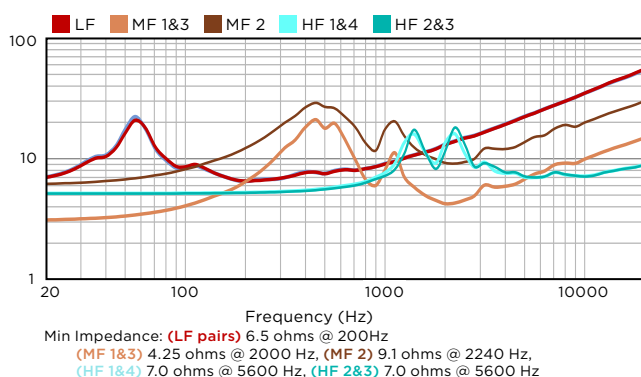

### VERTICAL OFF-AXIS RESPONSE (dB)<sup>6</sup>

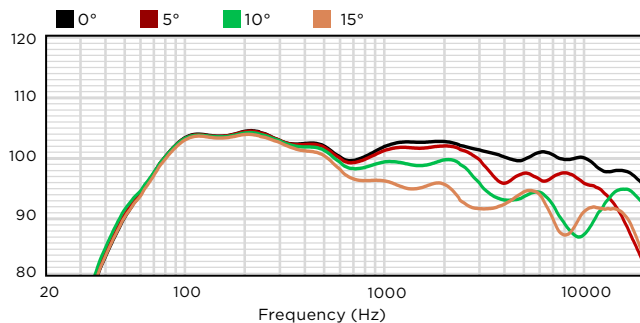

### DIRECTIVITY INDEX (dB)<sup>7</sup>

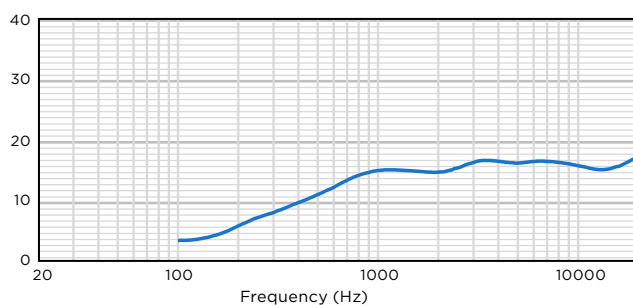

### BEAMWIDTH (Degrees)<sup>8</sup>

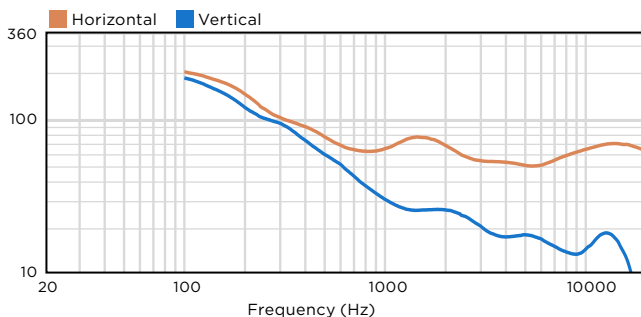

# Community L SERIES Beamforming Venue Horn

## LVH-906/AS

60° HORIZONTAL DISPERSION,  
ACTIVE STANDARD, 20°, 40°, 60° VERTICAL DISPERSION,  
ARRAYABLE, HIGH OUTPUT LOUDSPEAKER

**40° VERT PATTERN**

### AXIAL PROCESSED SENSITIVITY (dB)<sup>5</sup>

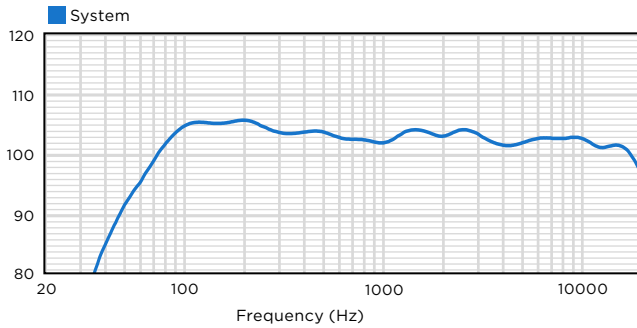

### HORIZONTAL OFF-AXIS RESPONSE (dB)<sup>6</sup>

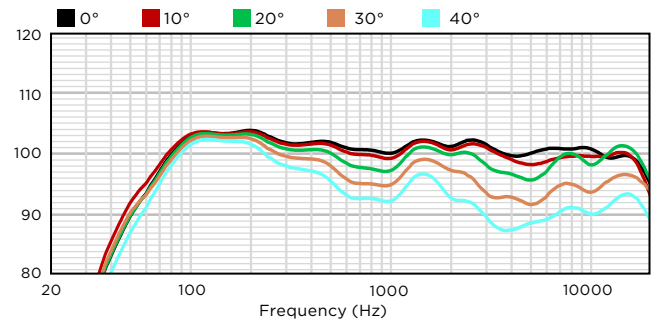

### IMPEDANCE (Ohms)

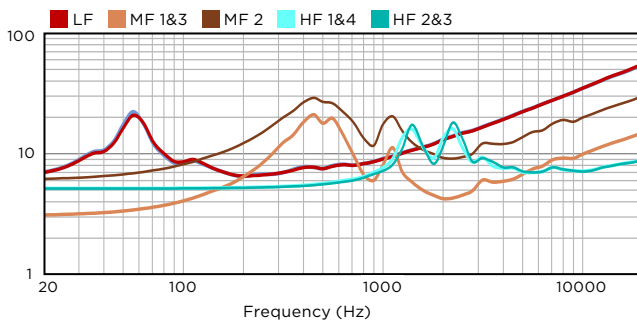

Min Impedance: (LF pairs) 6.5 ohms @ 200Hz  
(MF 1&3) 4.25 ohms @ 2000 Hz, (MF 2) 9.1 ohms @ 2240 Hz,  
(HF 1&4) 7.0 ohms @ 5600 Hz, (HF 2&3) 7.0 ohms @ 5600 Hz

### VERTICAL OFF-AXIS RESPONSE (dB)<sup>6</sup>

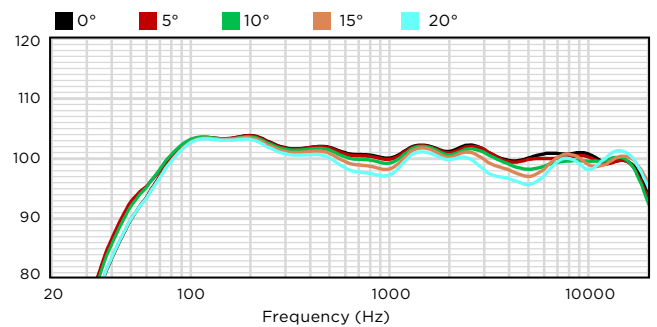

### DIRECTIVITY INDEX (dB)<sup>7</sup>

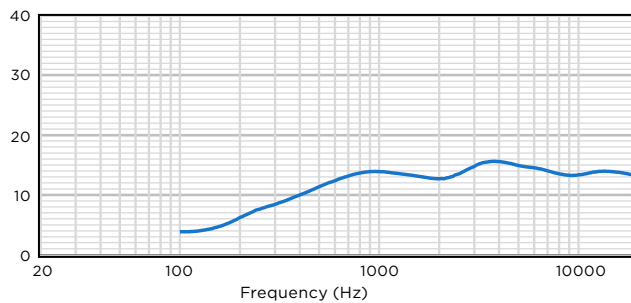

### BEAMWIDTH (Degrees)<sup>8</sup>

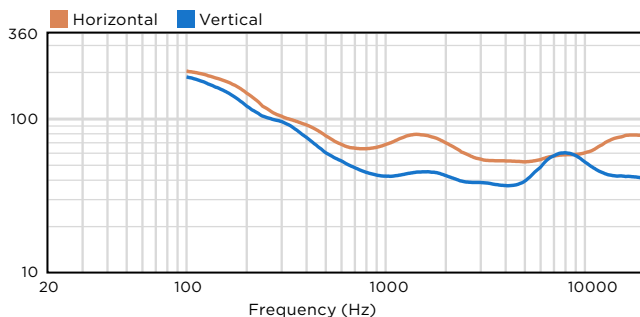

# Community L SERIES Beamforming Venue Horn

## LVH-906/AS

60° HORIZONTAL DISPERSION,  
ACTIVE STANDARD, 20°, 40°, 60° VERTICAL DISPERSION,  
ARRAYABLE, HIGH OUTPUT LOUDSPEAKER

**60° VERT PATTERN**

### AXIAL PROCESSED SENSITIVITY (dB)<sup>5</sup>

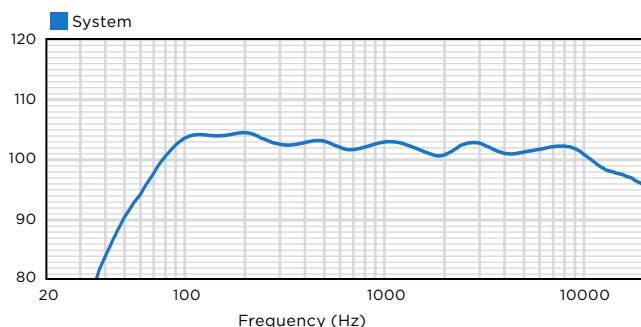

### HORIZONTAL OFF-AXIS RESPONSE (dB)<sup>6</sup>

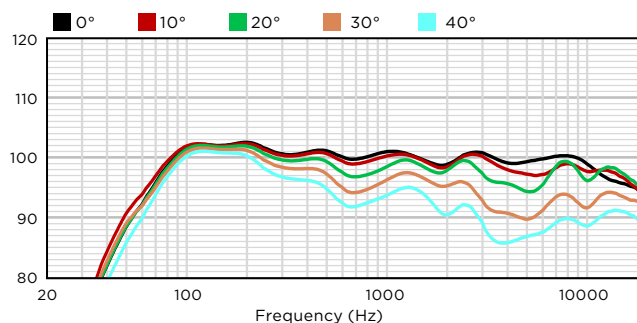

### IMPEDANCE (Ohms)

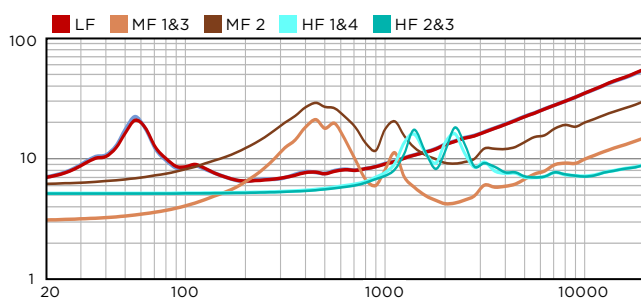

Min Impedance: (LF pairs) 6.5 ohms @ 200Hz  
(MF 1&3) 4.25 ohms @ 2000 Hz, (MF 2) 9.1 ohms @ 2240 Hz,  
(HF 1&4) 7.0 ohms @ 5600 Hz, (HF 2&3) 7.0 ohms @ 5600 Hz

### VERTICAL OFF-AXIS RESPONSE (dB)<sup>6</sup>

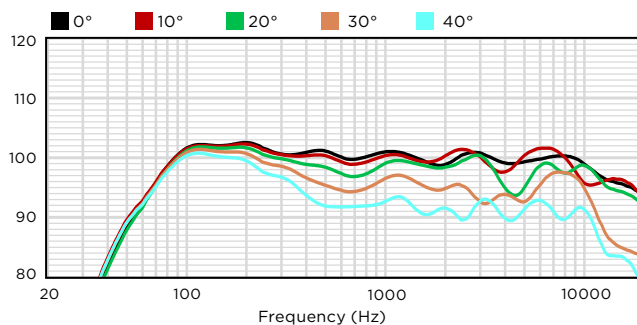

### DIRECTIVITY INDEX (dB)<sup>7</sup>

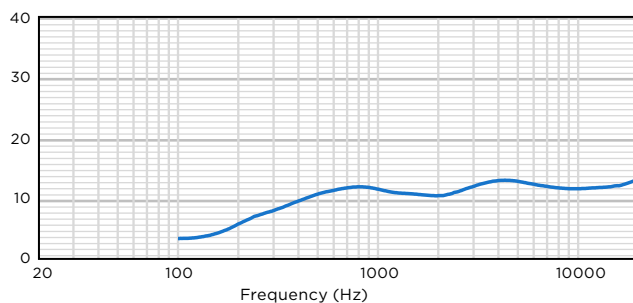

### BEAMWIDTH (Degrees)<sup>8</sup>

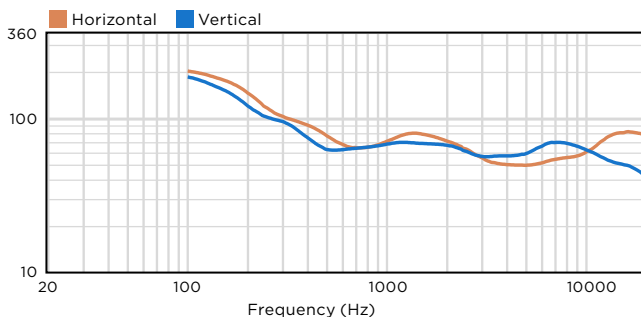

# Community L SERIES Beamforming Venue Horn

## LVH-906/AS

60° HORIZONTAL DISPERSION,  
ACTIVE STANDARD, 20°, 40°, 60° VERTICAL DISPERSION,  
ARRAYABLE, HIGH OUTPUT LOUDSPEAKER

### TECHNICAL DRAWING / DIMENSIONS / FINISH

#### H x W x D

37.3" x 31.4" x 30.5"  
(948 x 797 x 775 mm)

#### Unit Weight

250 lbs (113.4 kg) (Indoor)  
210 lbs (95.3 kg) (Outdoor Weather-resistant)  
**Shipping Weight** (on a pallet)  
307 lbs (139.3 kg) (Indoor)  
267 lbs (121 kg) (Outdoor Weather-resistant)

#### Enclosure Finish

**Indoor:** Powder-coated perforated steel (indoor) grille backed with acoustically transparent woven fabric with a low gloss, uniformly textured painted 15mm Baltic Birch plywood enclosure  
**Outdoor (WR):** Powder-coated marine grade aluminum grille featuring hydrophobically-treated acoustically transparent woven black fabric backing on a 15mm PolyGlas™ enclosure coated with heavily textured industrial-grade exterior-rated paint.

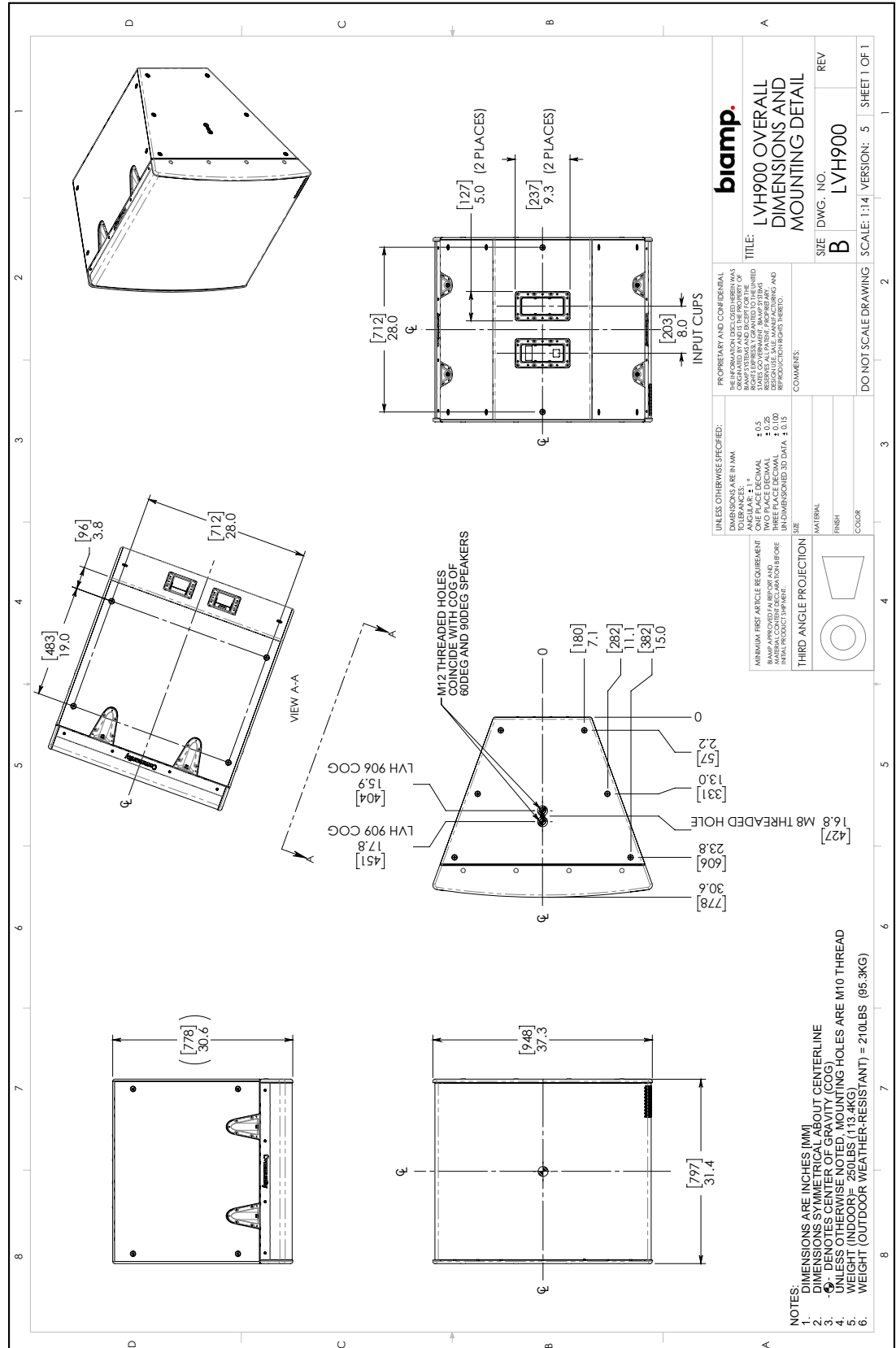

# Community L SERIES Beamforming Venue Horn

## LVH-906/AS

60° HORIZONTAL DISPERSION,  
ACTIVE STANDARD, 20°, 40°, 60° VERTICAL DISPERSION,  
ARRAYABLE, HIGH OUTPUT LOUDSPEAKER

### SPLAY BRACKETS / CABINET CONNECTIONS

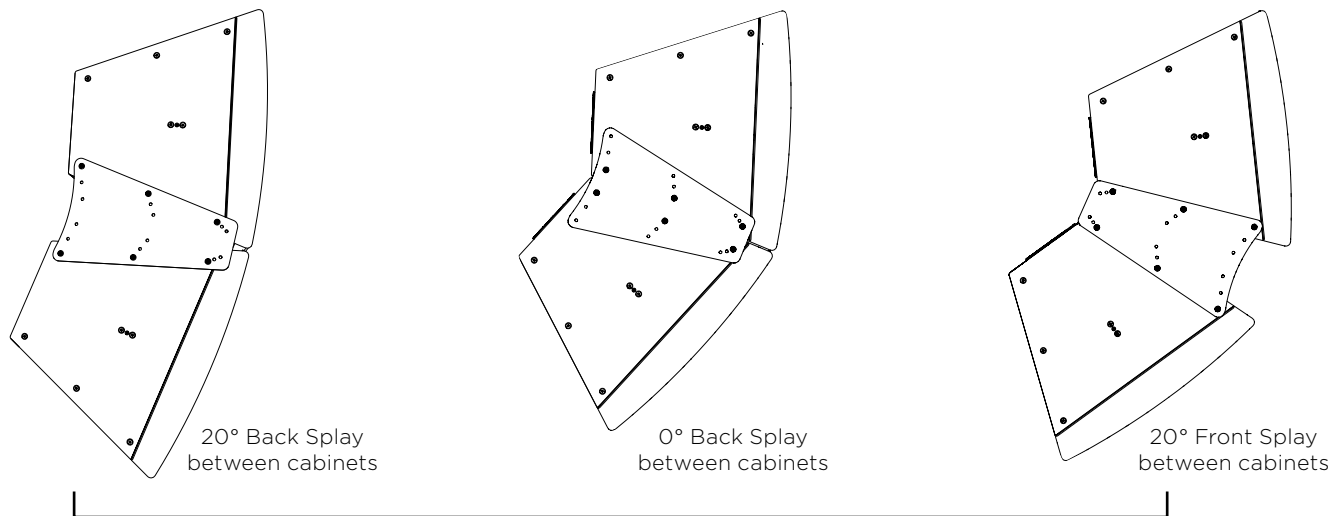

Type 1 Splay Bracket

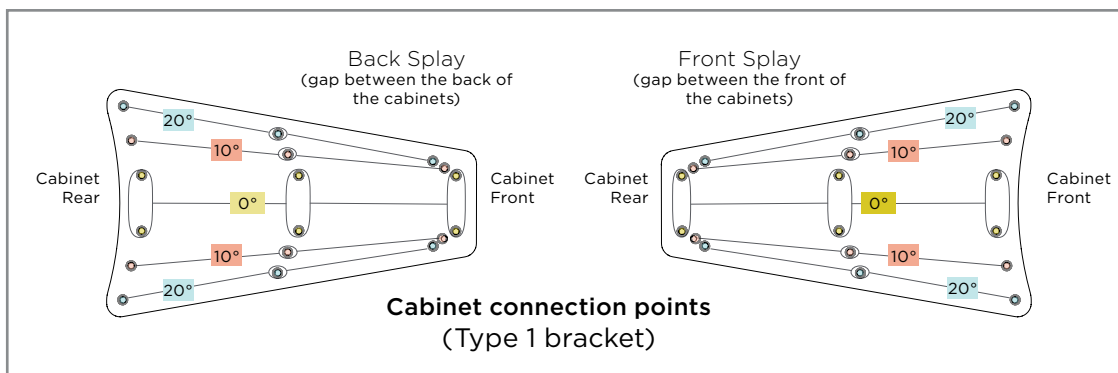

### MODELS and ACCESSORIES

Models	Description
LVH-906/ASB	LVH-900 60DEG ACTIVE-STD BLK
LVH-906/ASW	LVH-900 60DEG ACTIVE-STD WHT
LVH-906WR/ASG	LVH-900WR 60DEG ACTIVE-STD GRY
LVH-906WR/ASB	LVH-900WR 60DEG ACTIVE-STD BLK
LVH-906WR/ASW	LVH-900WR 60DEG ACTIVE-STD WHT
LVH-906C/AS	LVH-900 60DEG ACTIVE-STD CTO
LVH-906WRC/AS	LVH-900WR 60DEG ACTIVE-STD CTO
LVH-909/ASB	LVH-900 90DEG ACTIVE-STD BLK
LVH-909/ASW	LVH-900 90DEG ACTIVE-STD WHT
LVH-909WR/ASG	LVH-900WR 90DEG ACTIVE-STD GRY
LVH-909WR/ASB	LVH-900WR 90DEG ACTIVE-STD BLK
LVH-909WR/ASW	LVH-900WR 90DEG ACTIVE-STD WHT
LVH-909C/AS	LVH-900 90DEG ACTIVE-STD CTO
LVH-909WRC/AS	LVH-900WR 90DEG ACTIVE-STD CTO

Accessories	Description
LVH-900AFB	LVH-900 ARRAY FRAME BLK
LVH-900AFW	LVH-900 ARRAY FRAME WHT
LVH-900PBB	LVH-900 PULL BACK BAR BLK
LVH-900PBW	LVH-900 PULL BACK BAR WHT
LVH-900UBB	LVH-900 U-BRACKET BLK
LVH-900UBW	LVH-900 U-BRACKET WHT
LVH-900SP1B	LVH SPLAY PLATE PAIR TYPE1 BLK
LVH-900SP1W	LVH SPLAY PLATE PAIR TYPE1 WHT
LVH-900SP1G	LVH SPLAY PLATE PAIR TYPE1 GRY
LVH-900SP2B	LVH SPLAY PLATE PAIR TYPE2 BLK
LVH-900SP2W	LVH SPLAY PLATE PAIR TYPE2 WHT
LVH-900SP2G	LVH SPLAY PLATE PAIR TYPE2 GRY
LVH-900ASPTP	LVH MF/HF PASS THRU PANEL

# Community L SERIES Beamforming Venue Horn

## LVH-906/AS

60° HORIZONTAL DISPERSION,  
ACTIVE STANDARD, 20°, 40°, 60° VERTICAL DISPERSION,  
ARRAYABLE, HIGH OUTPUT LOUDSPEAKER

### CONNECTION DIAGRAMS

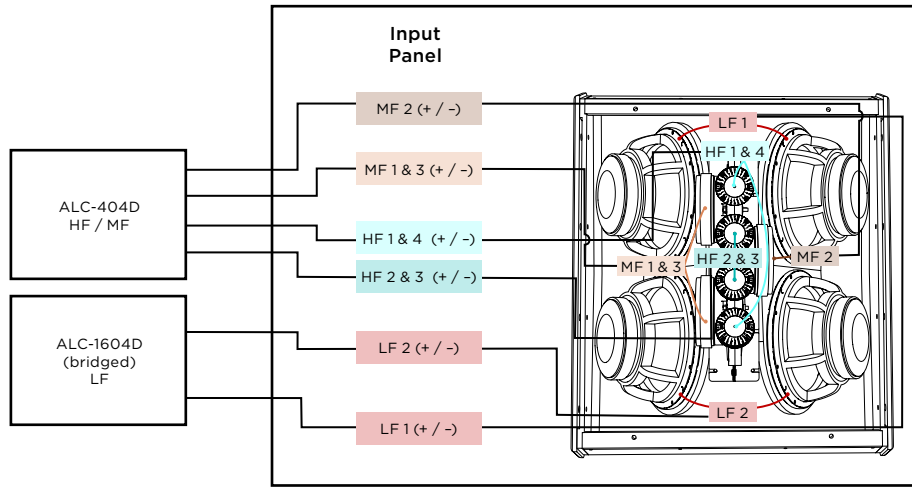

LVH-900/AS (with ALC-404D & ALC-1604D)

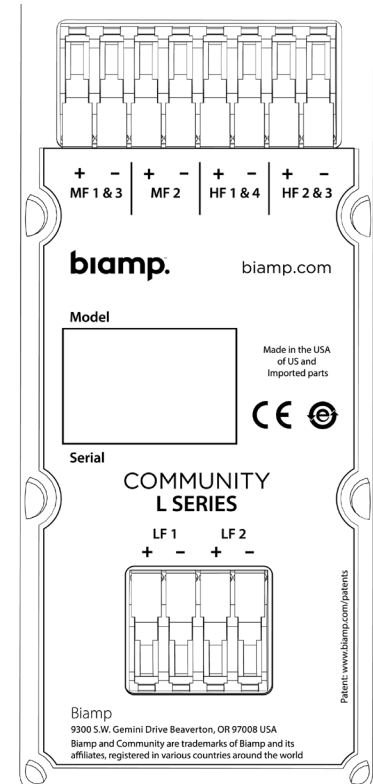

Input panel

Refer to the LVH Installation and Operation Guide for detailed wiring instructions.

### NOTES

- PERFORMANCE SPECIFICATIONS** All measurements are taken indoors using a time-windowed and processed signal to eliminate room effects, approximating an anechoic environment, a distance of 6.0 m. All acoustic specifications are rounded to the nearest whole number. An external DSP using settings provided by Biamp is required to achieve the specified performance; further performance gains can be realized using the FIR loudspeaker optimization presets available in Biamp's Community Amplified Loudspeaker Controllers (ALC SERIES).
- OPERATING RANGE** The frequency range in which the on-axis processed response remains within 10dB of the average SPL.
- CONTINUOUS POWER HANDLING** Maximum continuous input voltage at the stated nominal impedance that the system can withstand, without damage, for a period of 2 hours using an EIA-426-B defined spectrum; with recommended signal processing and protection filters.
- EQUALIZED MAXIMUM SPL** The SPL produced when an EIA-426-B signal is applied to the equalized loudspeaker system, at a level which drives at least one subsection to its rated continuous input voltage limit, referenced to a distance of 1 meter. The peak SPL represents the 2:1 (6dB) crest factor of the EIA-426-B test signal.
- AXIAL PROCESSED SENSITIVITY** The on-axis variation in acoustic output level with frequency for a 1 Watt swept sine wave, referenced to 1 meter with recommended signal processing applied.
- HORIZONTAL / VERTICAL OFF-AXIS RESPONSES** The loudspeaker's magnitude response at various angles off-axis, with recommended signal processing applied in the operating mode which utilizes the largest number of individually amplified pass bands.
- DIRECTIVITY INDEX** The ratio of the on-axis SPL squared to the mean squared SPL at the same distance for all points within the measurement sphere for each given frequency; expressed in dB.
- BEAMWIDTH** The angle between the -6dB points in the polar response of the loudspeaker when driven in the operating mode which utilizes the largest number of individually amplified pass bands.

Data presented on this spec sheet represents a selection of the basic performance specifications for the model. These specifications are intended to allow the user to perform a fair, straightforward evaluation and comparison with other loudspeaker spec sheets. For a detailed analysis of this loudspeaker's performance, please download the GLL file and/or the CLF file from our website. ([LVH-900/AS data here](#))

**CAUTION:** Installation of loudspeakers should only be performed by trained and qualified personnel. It is strongly recommended that a licensed and certified professional structural engineer approve the mounting design.