

INTERIOR DESIGN SERIES

HB-1 FLUSH-MOUNT SUBWOOFER

THE TOA HB-1 FLUSH-MOUNT SUBWOOFER is the ideal solution for adding low frequency enhancement to commercial, residential and retail sound systems. The HB-1's unique minimum-depth design allows discreet flush-mount installation in ceiling structures or in walls between studs spaced on 16" centers.

The HB-1 features a tuned, ported enclosure and a heavy-duty 8" woofer for high power handling and extended low frequency response. An acoustic bandpass filter design eliminates the need for an external crossover. The solidly constructed steel enclosure also acts as a heat-sink to dissipate excessive heat from the speaker component. Other features include a paintable grille and removable terminal block. Options include a matching transformer for connecting the HB-1 to distributed speaker systems and a 900 Series Low Pass Filter Module for convenient system equalization. The HB-1 also carries a five year warranty.



HIGHLIGHTS

- **Low Frequency Enhancement**
for a wide variety of speaker system applications including hotels, houses of worship, museums, offices, residential spaces, restaurants, and retail stores.
- **Minimum-Depth Design**
allows recessed, flush-mount installation in spaces with only 4.1" of available depth.
- **Wall-Mount**
between 16" spaced wall studs.
- **Ceiling-Mount**
using supplied rigging points.
- **Tuned, Ported Enclosure**
for deep bass and low distortion.
- **Acoustic Bandpass Filter Design**
eliminates need for external crossover.
- **High Power Handling:**
240 W (Continuous Program)
- **Frequency Response:**
45 - 200 Hz (-10 dB, 1/2 space)
- **High Sensitivity:**
91 dB SPL (1 W / 1 m, 1/2 space)
- **Heavy-Duty Loudspeaker Component:**
8" woofer with ferrite magnet
- **Solid, Vibration-Free Steel Enclosure:**
also acts as heat-sink to dissipate excessive heat away from the speaker component.
- **Removable Terminal Block**
with loop-through terminations for convenient connection of parallel speakers.
- **Paintable Grille**
to custom-match to the environment.
- **Mounting Bracket Included**
- **Five Year Warranty**

OPTIONAL ACCESSORIES

- | | |
|-----------------|--|
| E-07S | 900 Series Low Pass Filter Module for convenient system equalization |
| MT-S0601 | Matching Transformer (60 W max.) for 70.7 V/ 100 V distributed speaker systems, mountable inside enclosure |

SPECIFICATIONS

HB-1 FLUSH-MOUNT SUBWOOFER

Tel: 800-733-7088
 Fax: 800-733-9766
 www.toaelectronics.com



Model No.	HB-1
Enclosure Type	Port radiation, acoustic bandpass
Speaker Component	8" (20 cm) cone woofer with ferrite magnet, rubber surround
Impedance	8 Ω
Sensitivity (1 W / 1 m, 1/2 space)	91 dB SPL
Power Handling (40 - 200 Hz)	
Continuous Program:	240 W
Continuous Pink Noise:	80 W
Frequency Response (-10dB, 1/2 Space)	45 -200 Hz
Material / Finish	Enclosure: Steel plate, black Grille: Rolled steel plate, white, paintable Grille Frame: Fire-resistant ABS resin, white, paintable Base Frame: Steel
Input Connector	Removable terminal block with screw terminals (AWG #14 - #24). Two pairs of (+)/(-) for input and loop-through terminations.
Cutout Size	14.17" x 18.9" (360 mm x 480 mm)
Minimum Depth Required (including board thickness)	4.1" (103 mm)
Dimensions (W x H x D)	16.93" x 21.42" x 5.32" (430 mm x 544 mm x 135 mm)
Weight (including grille and mounting bracket)	24.25 lbs. (11 kg)
Accessories (included)	Mounting Bracket, Grille, Mounting Screws
Options	E-07S 900 Series Low Pass Filter Output Module (100 Hz, -12 dB/oct.) MT-S0501 Matching Transformer: 70.7 V Line: 60 W, 30 W, 15 W, 7.5 W 100 V Line: 60 W, 30 W, 15 W

FREQUENCY RESPONSE

E-07S LPF In/Out

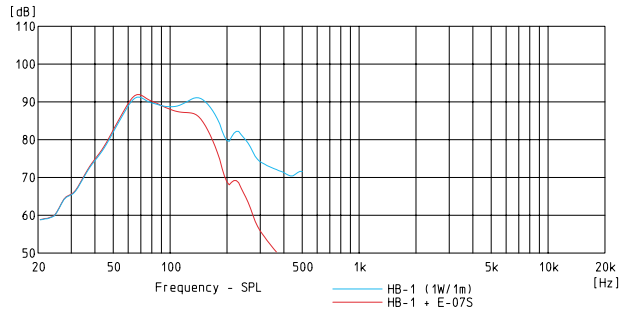

H-1 and HB-1

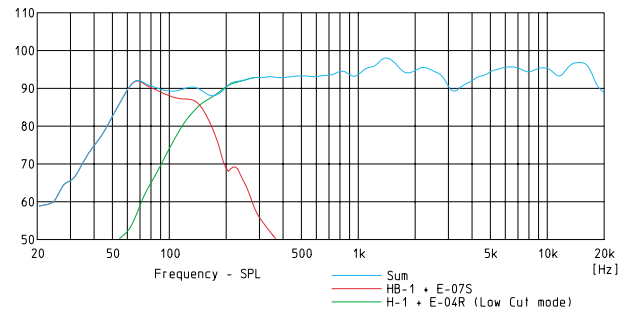

H-2 and HB-1

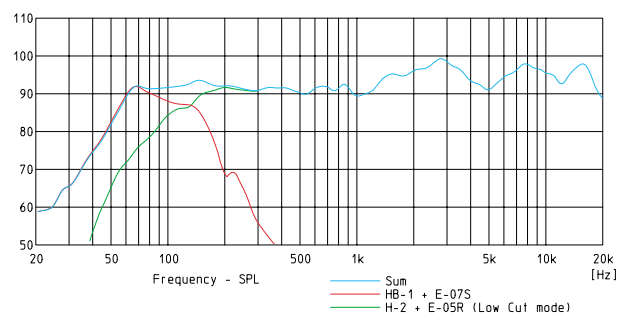

H-3 and HB-1

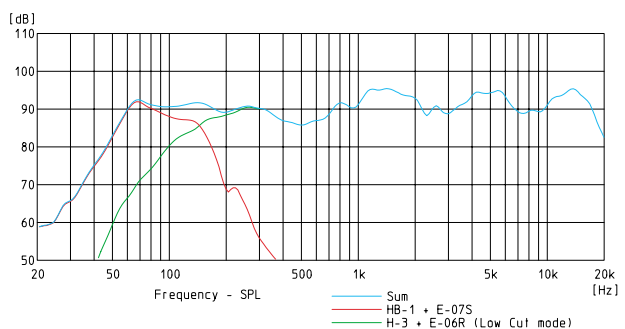

SPECIFICATIONS

HB-1 FLUSH-MOUNT SUBWOOFER

Tel: 800-733-7088
Fax: 800-733-9766
www.toaelectronics.com



DIMENSIONAL DRAWING

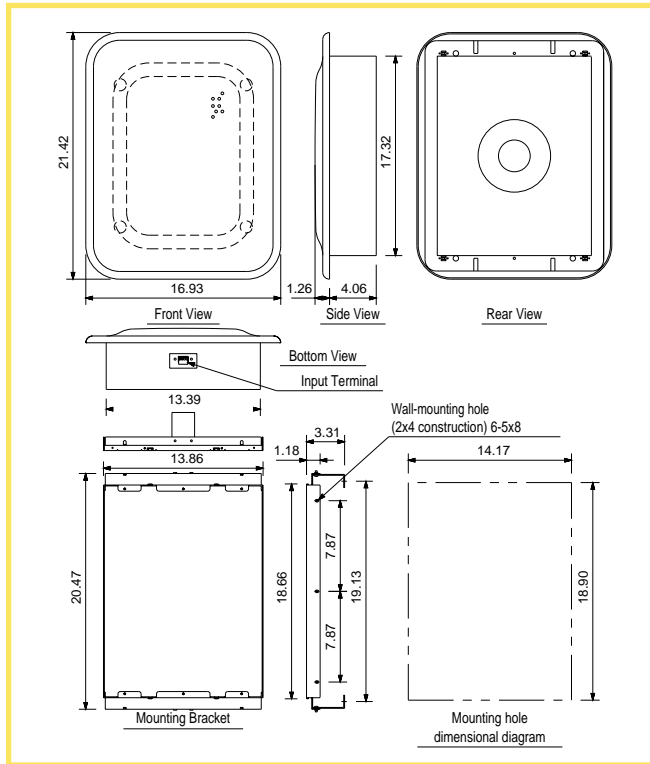

WALL MOUNTING

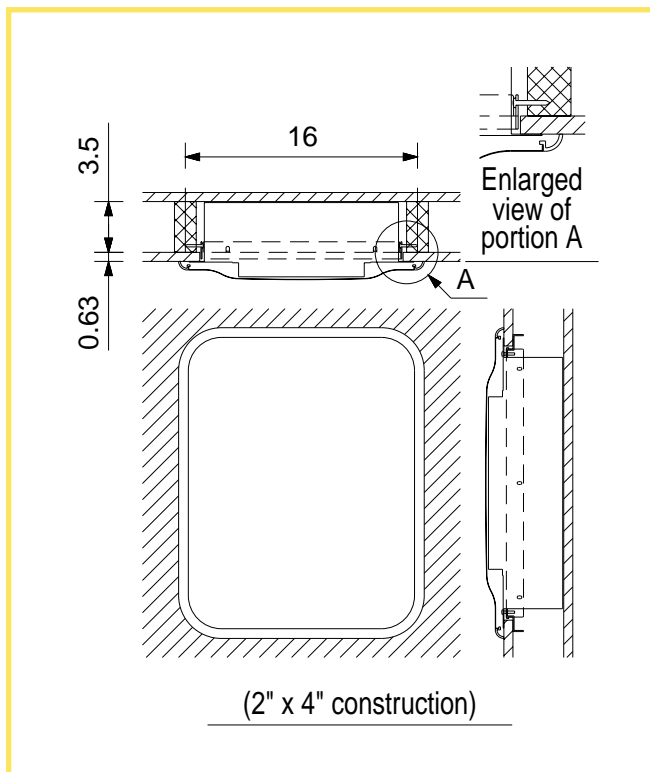

CEILING MOUNTING

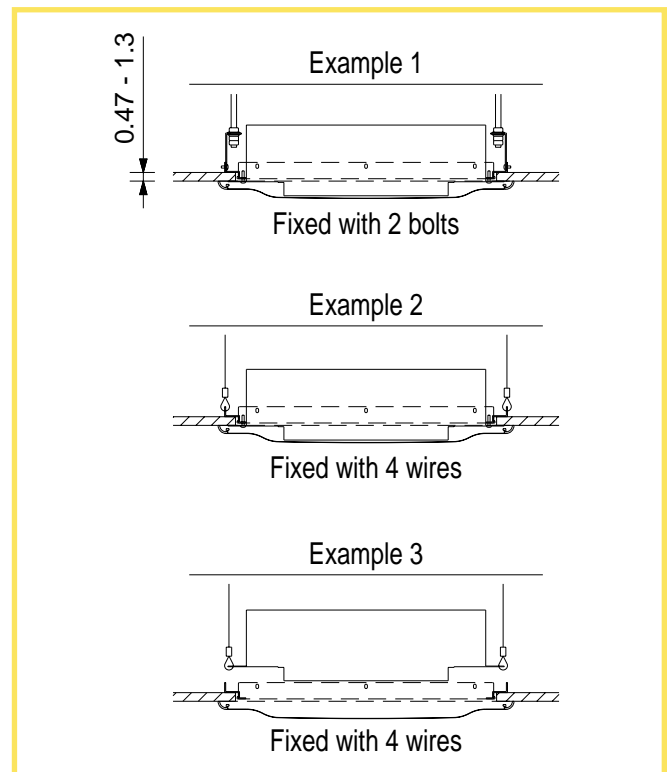

SPECIFICATIONS

HB-1 FLUSH-MOUNT SUBWOOFER

Tel: 800-733-7088
Fax: 800-733-9766
www.toaelectronics.com



ARCHITECT'S & ENGINEER'S SPECIFICATIONS

The subwoofer shall be a tuned, ported enclosure with acoustic bandpass filter design. The enclosure shall be compact and suitable for flush-mount installation in a space 14.17" x 18.9" (360 mm x 480 mm) and occupy a maximum depth of 4.1" (103 mm) including board thickness. The loudspeaker component shall have a diameter of 8" (20 cm) with ferrite magnet, rubber surround and a nominal impedance of 8 ohms. The rated power handling from 40 to 200 Hz (-10 dB) shall be 240 W Continuous Program and 80 W Continuous Pink Noise. The frequency response shall be 45 - 200 Hz (-10 dB, 1/2 space). The output sound pressure level shall be 91 dB SPL (half-space) at a distance of one meter with one watt of input power applied. The subwoofer enclosure shall be steel plate with a black paint finish. The grille frame shall be constructed of fire-resistant ABS resin with a white, paint-ready finish. The mounting bracket shall be of heavy-duty steel construction. The input connector shall be a removable terminal block with screw terminals allowing two pairs of speaker wire for input and loop-through terminations. An optional low pass filter module shall be available for system equalization. An optional matching transformer shall be available for connecting the subwoofer to a distributed speaker system. The transformer shall mount inside the subwoofer enclosure with selectable wattage taps of 60 W, 30 W, 15 W and 7.5 W at 70.7 V line and 60 W, 30 W and 15 W at 100 V line. The enclosure dimensions shall be 16.93" W x 21.42" H x 5.32" D (430 mm x 544 mm x 135 mm) and the weight shall be 24.25 lbs. (11 kg).

The subwoofer shall be the TOA HB-1.

TOA Electronics, Inc.

601 Gateway Boulevard
Suite 300
South San Francisco, CA 94080

Tel: 800-733-7088 Fax: 800-733-9766

www.toaelectronics.com

TOA Canada Corp.

Tel: 905-564-3570 Fax: 905-564-3569

Literature Order #: L-HB-1
Specifications subject to change without notice.
© 2004 TOA Electronics, Inc.