



UPS8 Series

Pure Sine Wave Line Interactive UPS

Models UPS8-1100, UPS8-1500, UPS8-2000, UPS8-2200, UPS8-3000

User & Installation Manual

TABLE of CONTENTS

IMPORTANT SAFETY WARNING	3
Transportation	3
Preparation	3
Installation	3
Operation	3
Maintenance, Service, Faults	4
INSTALLATION & SET UP	5
Rear Panel View	5
Operating Principle	5
Install the UPS	6
Set Up the UPS	8
Battery Replacement	10
Battery Kit Assembly	12
OPERATION	15
Button Operation	15
LCD Panel	15
Audible Alarms	17
Abbreviations in LCD Display	17
UPS Setting	18
Operating Mode Descriptions	21
Fault Reference Codes	22
Warning Indicators	22
TROUBLESHOOTING	23
STORAGE & MAINTENANCE	24
Operation	24
Storage	24
SPECIFICATIONS	25
OBTAINING SERVICE	26
LIMITED WARRANTY	27
APPENDIX A: EXTERNAL BATTERY PACK (Model UPS-XBP-48, UPS-XBP-72)	28
Important Safety Instructions	28
Product Overview & Set Up	29
Type of Battery Required	31
Battery Replacement	31
Wiring Diagrams	34
Storage & Maintenance	36

IMPORTANT SAFETY WARNINGS

Please comply with all warnings and operating instructions in this manual strictly. Save this manual properly and read carefully the following instructions before installing the unit. Do not operate this unit before reading through all safety information and operating instructions carefully.

Transportation

- Transport the UPS system only in the original package to protect against shock and impact.

Preparation

- Condensation may occur if the UPS system is moved directly from cold to warm environment. The UPS system must be absolutely dry before being installed. Allow at least two hours for the UPS system to acclimate to the environment.
- Do not install the UPS system near water or in moist environments.
- Do not install the UPS system where it would be exposed to direct sunlight or near heater.
- Do not block ventilation holes in the UPS housing.

Installation

- Do not connect appliances or devices which would overload the UPS system (e.g. laser printers) to the UPS output sockets.
- Place cables in such a way that no one can step on or trip over them.
- Do not connect domestic appliances such as hair dryers to UPS output sockets.
- The UPS can be operated by any individual with no previous experience.
- Connect the UPS system only to an earthed shockproof outlet which must be easily accessible and close to the UPS system.
- Use only VDE-tested, CE-marked mains cable (e.g. the mains cable of your computer) to connect the UPS system to the building wiring outlet (shockproof outlet).
- Use only VDE-tested, CE-marked power cables to connect the loads to the UPS system.
- When installing the equipment, it should ensure that the sum of the leakage current of the UPS and the connected devices does not exceed 3.5mA.
- Temperature Rating: Units are considered acceptable for use in a maximum ambient temperature of 104°F (40°C) .
- For PLUGGABLE EQUIPMENT, the socket-outlet shall be installed near the equipment and shall be easily accessible.
- **Caution**—the unit is heavy. Lifting the unit requires a minimum of two people.
- Check if there is a protection device against over current and short circuit in the upstream of the UPS system. The recommended protection spec is 11A for 1100VA, 15A for 1500VA, 20A for 2000VA and 2200VA, and 30A for 3000VA with a B or C trip curve.

Operation

- Do not disconnect the mains cable on the UPS system or the building wiring outlet (shockproof socket outlet) during operation since this would cancel the protective earthing of the UPS system and of all connected loads.
- The UPS system features its own internal current source (batteries). The UPS output sockets or output terminals block may be electrically live even if the UPS system is not connected to the building wiring outlet.
- In order to fully disconnect the UPS system, first press the OFF/Enter button to disconnect the mains.
- Prevent fluids and other foreign objects from getting inside the UPS system.
- The EPO, RS-232 and USB circuits are an IEC 60950 safety extra low voltage (SELV) circuit. This circuit must be separated from any hazardous voltage circuits by reinforced insulation.

Maintenance, Service & Faults

- The UPS system operates with hazardous voltages. Repairs may be carried out only by qualified maintenance personnel.
- **Caution**—risk of electric shock. Even after the unit is disconnected from the mains (building wiring outlet), components inside the UPS system are still connected to the battery and electrically live and dangerous.
- Before carrying out any kind of service and/or maintenance, disconnect the batteries and verify that no current is present and no hazardous voltage exists in the terminals of high capability capacitor such as BUS-capacitors.
- To avoid electrical shock, turn off the unit and unplug it from the AC power source before servicing the battery.
- Only persons who are adequately familiar with batteries and with the required precautionary measures may replace batteries and supervise operations. Unauthorized persons must be kept well away from the batteries.
- **Caution**—risk of electric shock. The battery circuit is not isolated from the input voltage. Hazardous voltages may occur between the battery terminals and the ground. Before touching, please verify that no voltage is present!
- Batteries may cause electric shock and have a high short-circuit current. Please take the precautionary measures specified below and any other measures necessary when working with batteries:
 - Remove wristwatches, rings and other metal objects.
 - Use only tools with insulated grips and handles.
- When changing batteries, install the same number and same type of batteries.
- Do not attempt to dispose of batteries by burning them. This could cause battery explosion.
- Do not open or destroy batteries. Escaping electrolyte can cause injury to the skin and eyes. It may be toxic.
- When replacing batteries, replace with the same type and number of batteries or battery packs.
- Do not dismantle the UPS system.
- A battery can present a risk of electrical shock and high short-circuit current. The following precautions should be observed when working on batteries:
 - >> Remove watches, rings, and other metal objects.
 - >> Use tools with insulated handles.
 - >> Wear rubber gloves and boots.
 - >> Do not lay tools or metal parts on top of batteries.
 - >> Disconnect charging source prior to connecting or disconnecting battery terminals.
 - >> Determine if battery is inadvertently grounded. If inadvertently grounded, remove source from ground. Contact with any part of a grounded battery can result in electrical shock. The likelihood of such shock can be reduced if such grounds are removed during installation and maintenance.

INSTALLATION & SET-UP

NOTE: Inspect the unit before installation. Be sure that nothing inside the package is damaged. Keep the original package in a safe place for future use.

Rear Panel View

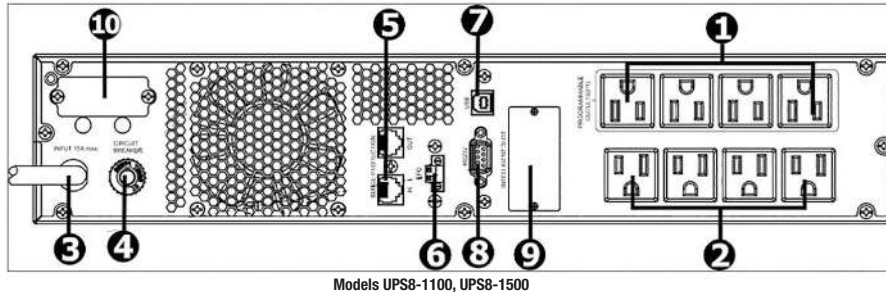

Models UPS8-1100, UPS8-1500

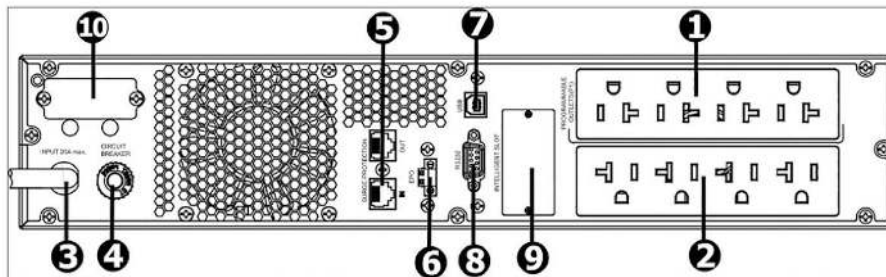

Models UPS8-2000, UPS8-2200, UPS8-3000

1. Programmable outlets: connect to non-critical loads
2. Output receptacles: connect to mission-critical loads.
3. AC input
4. Input circuit breaker
5. Network/Fax/Modem surge protection
6. Emergency power off function connector (EPO)
7. USB communication port
8. RS-232 communication port
9. SNMP intelligent slot
10. External battery connector

Operating Principle

The operating principle of the UPS is shown below. The UPS is composed of mains input, EMI/RFI filters, inverter, battery charger, DC-to-DC converter, battery, AVR TX and UPS output.

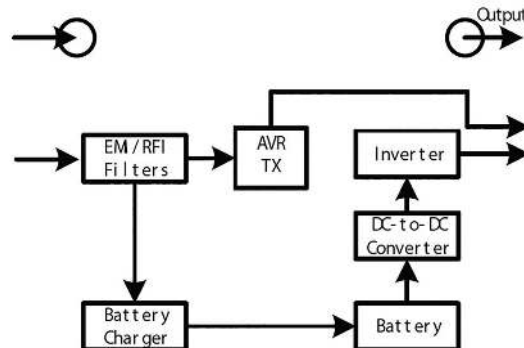

Install the UPS

For safety consideration, the UPS is shipped out from the factory without connecting battery wires. Before installing the UPS, follow these steps to re-connect battery wires.

Connect Battery Wires:

Step 1: Remove front panel.

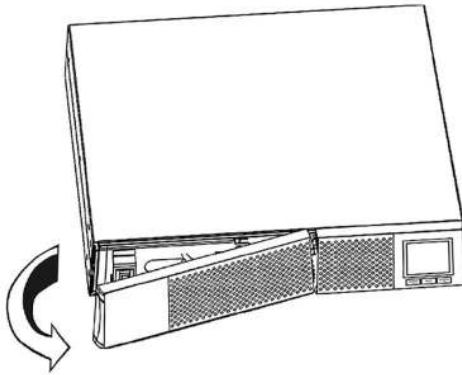

Step 2: Connect the AC input and re-connect battery wires.

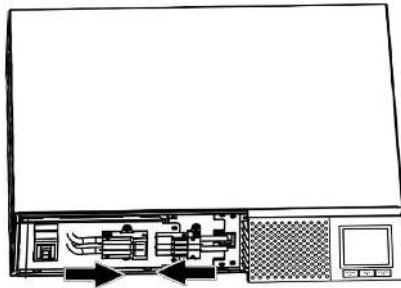

Step 3: Replace front panel.

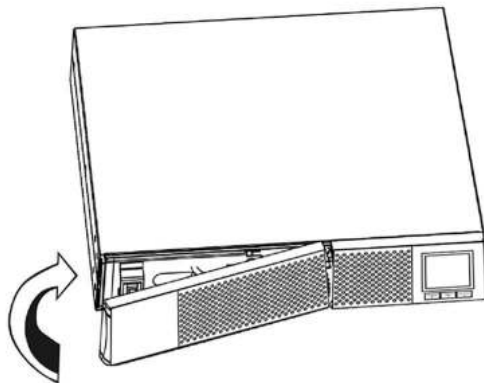

Rackmount Installation (with 4-point rail kit):

Step 1: Mount the 4-point rail kit to the rack. Use the (8) 10-32 screws provided to mount left and right support rails (front and rear).

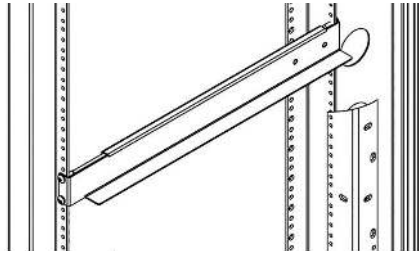

Step 2: Attach the mounting brackets to the UPS. **CAUTION**—DO NOT use mounting brackets to lift the UPS; brackets are only to secure it to the rack.

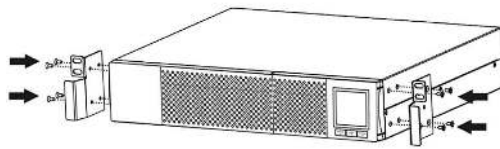

Step 3: Place UPS on the support rails and secure in place with front screws, allowing the horizontal rails to support the weight of the UPS.

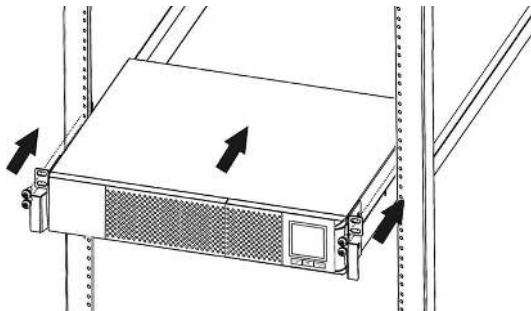

Tower Installation:

NOTE: When installing the UPS or battery pack with feet, keep 2.75 inches (70mm) distance from the edge of the unit.

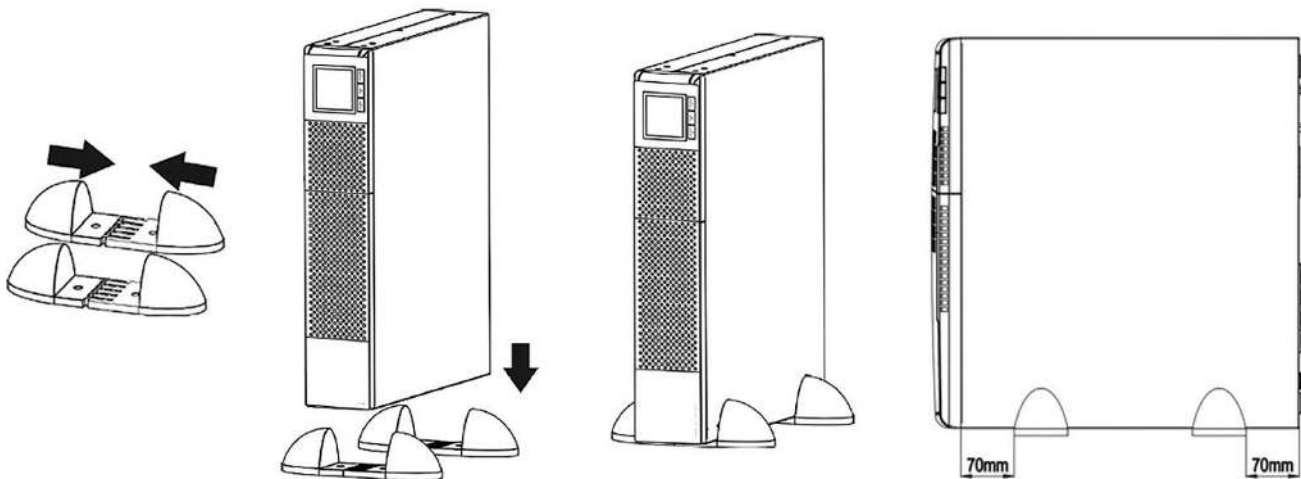

Set Up the UPS

Step 1: UPS Input Connection.

Plug the UPS into a two-pole, three-wire, grounded receptacle only. Avoid using extension cords.

Step 2: UPS Output Connection.

There are two kinds of outputs: programmable outlets and general outlets. Connect non-critical devices to the programmable outlets and critical devices to the general outlets. During power failure, you may extend the backup time to critical devices by setting shorter backup time for non-critical devices.

Step 3: Communication Connection.

Communication ports:

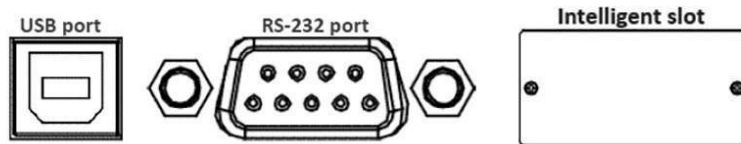

- **USB Port or RS-232 Port:** To allow for unattended UPS shutdown/start-up and status monitoring, connect the communication cable, one end to the USB/RS-232 port and the other to the communication port of your PC. With the monitoring software installed, you can schedule UPS shutdown/start-up and monitor UPS status through the PC.

NOTE: USB port and RS-232 port can't work at the same time.

- **Intelligent Slot:** The UPS is equipped with an intelligent slot ideal for either an SNMP or Dry Contact/Relay card. When installing either an SNMP or Dry Contact/Relay card in the UPS, it will provide advanced communication and monitoring options.

Step 4: Surge Protection.

Connect a single modem/phone/fax line into surge-protected "IN" outlet on the back panel of the UPS unit. Connect from "OUT" outlet to the equipment with another modem/fax/phone line cable.

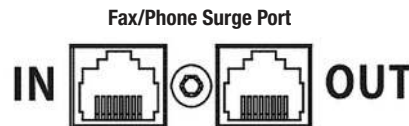

Step 5: Disable and Enable EPO Function.

Keep the pin 1 and pin 2 closed for UPS normal operation. To activate EPO function, cut the wire between pin 1 and pin 2.

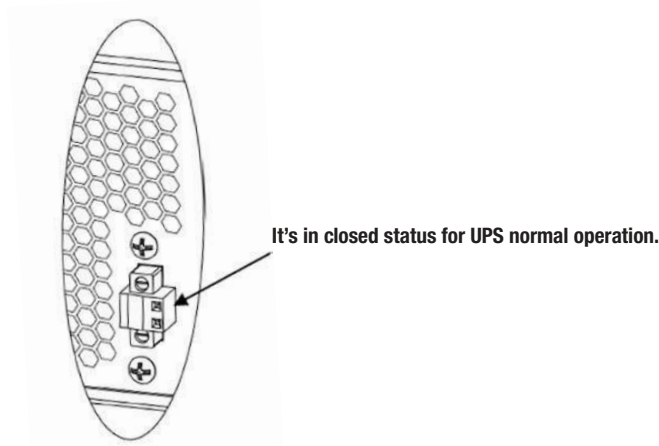

Step 6: External Battery Connection.

Connect one end of external battery cable to UPS unit and the other end to battery box. Use supplied battery connection wire in connection port of UPS unit and plug the other end to battery bank.

CAUTION: Connection to External Battery shall be installed by SERVICE PERSONNEL only.

NOTE: External battery boxes can only be connected to one (1) UPS.

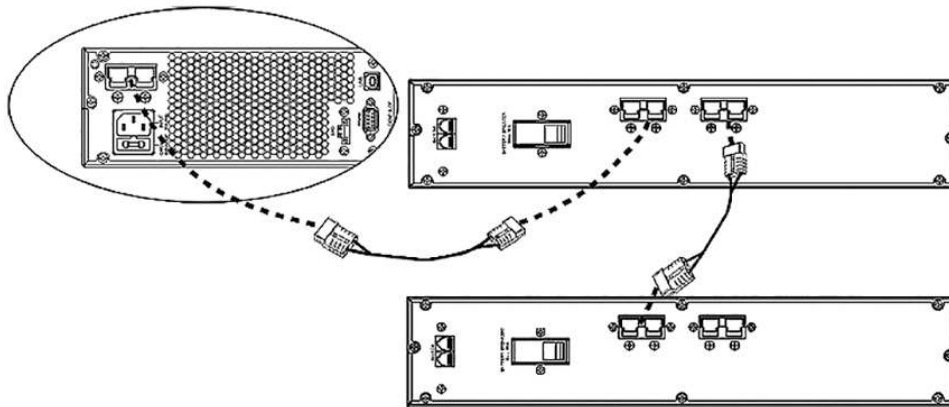

Step 7: Turn the UPS on.

Press the ON/Mute button on the front panel for two seconds to power on the UPS.

NOTE: The battery charges fully during the first five hours of normal operation. Do not expect full battery run capability during this initial charge period.

Step 8: Install software.

For optimal computer system protection, install UPS monitoring software to fully configure UPS shutdown. Follow steps below to download and install monitoring software:

1. Go to the website <http://www.power-software-download.com>
2. Click ViewPower software icon and then choose your required OS to download the software.
3. Follow the on-screen instructions to install the software.
4. When your computer restarts, the monitoring software will appear as an orange plug icon located in the system tray, near the clock.

Battery Replacement

NOTICE: This UPS is equipped with internal batteries and only service personnel can replace the batteries.

CAUTION! Consider all warnings, cautions, and notes before replacing batteries.

Note: Upon battery disconnection, equipment is not protected from power outages.

Step 1: Remove front panel.

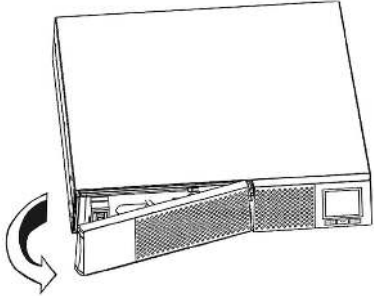

Step 2: Disconnect battery wires.

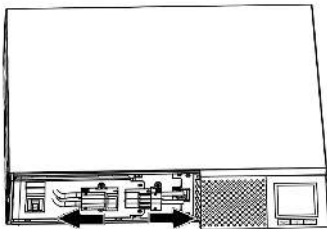

Step 3: Pull the battery box out by removing two screws on the front panel.

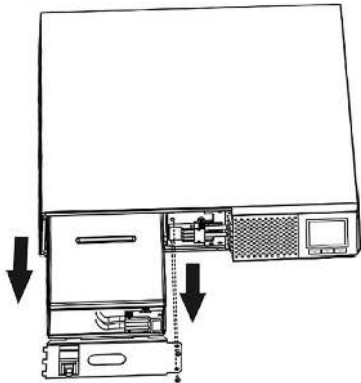

Step 4: Remove the top cover of battery box and replace the inside batteries.

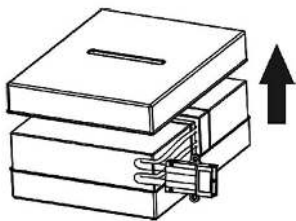

Step 5: After replacing the batteries, return battery box to original location; screw tightly.

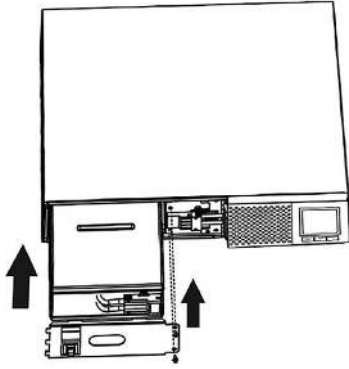

Step 6: Re-connect the battery wires

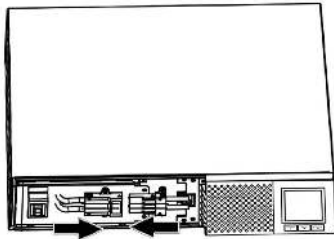

Step 7: Replace front panel.

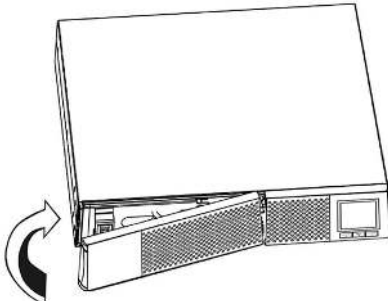

Battery Kit Assembly

NOTICE: Assemble the battery kit first before installing it inside of UPS. Select correct battery kit procedure (two, four, or six battery kit listed below) to assemble it.

TWO (2) Battery Kit:

Step 1: Remove adhesive tapes.

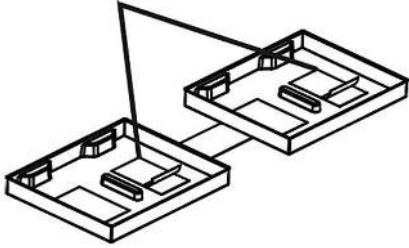

Step 2: Connect all battery terminals per diagram.

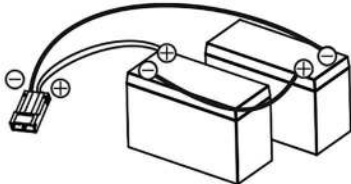

Step 3: Put assembled battery packs on one side of plastic shells.

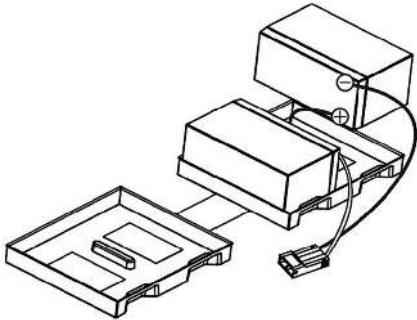

Step 4: Cover the other side of plastic shell as shown. The battery kit is then fully assembled.

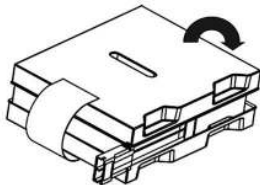

FOUR (4) Battery Kit:

Step 1: Remove adhesive tapes.

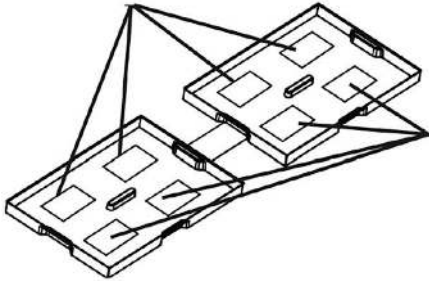

Step 2: Connect all battery terminals per diagram.

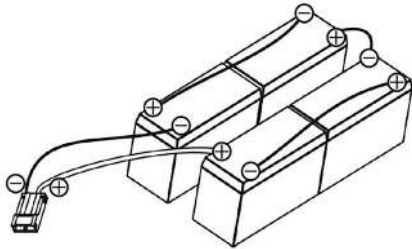

Step 3: Put assembled battery packs on one side of plastic shells.

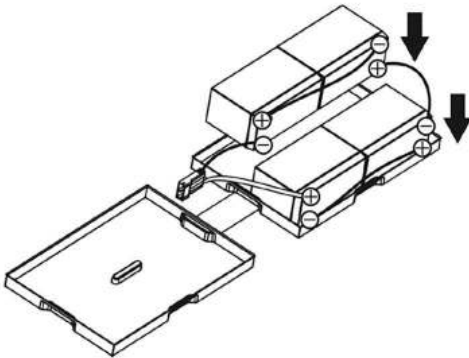

Step 4: Cover the other side of plastic shell as shown. The battery kit is then fully assembled.

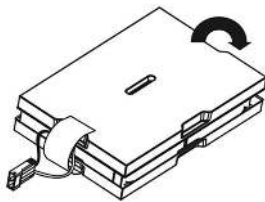

SIX (6) Battery Kit:

Step 1: Remove adhesive tapes.

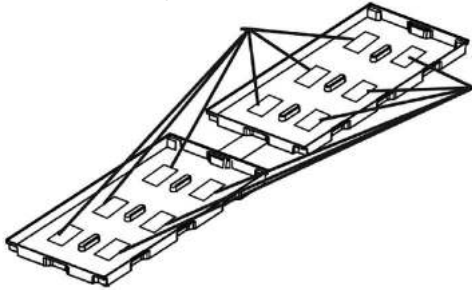

Step 2: Connect all battery terminals per diagram.

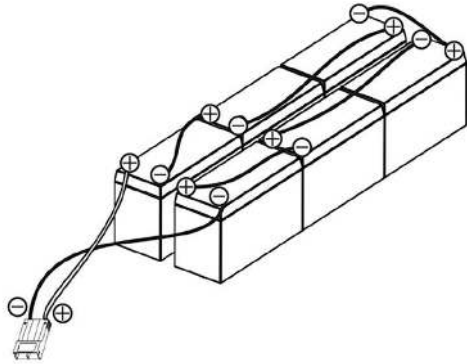

Step 3: Put assembled battery packs on one side of plastic shells.

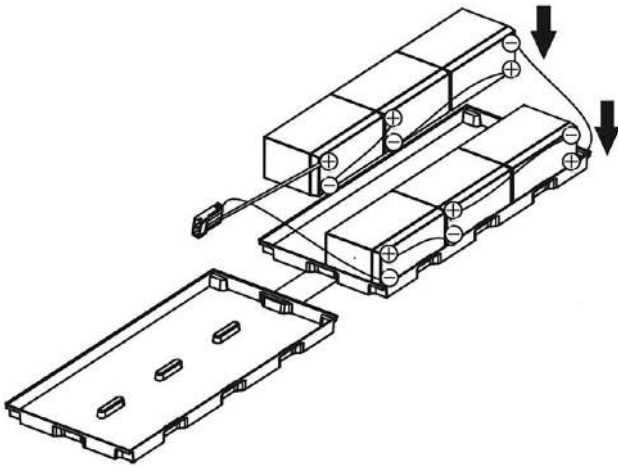

Step 4: Cover the other side of plastic shell as shown. The battery kit is then fully assembled.

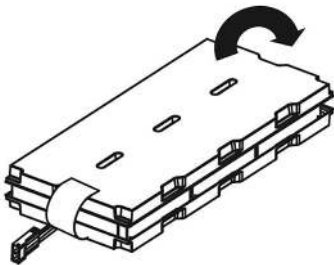

OPERATION

Button Operation

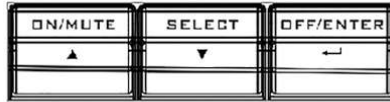

Button	Function
ON/MUTE	<ul style="list-style-type: none"> • Turn On: Press and hold this button for at least 2 seconds to turn the UPS on. • Mute Alarm: After UPS is turned on in battery mode, press and hold this button for at least 3 seconds to disable or enable alarm system. But it's not applied to the situations when warnings or errors occur. • Up Key: Press this button to display previous selection in UPS setting mode. • Switch to UPS Self-Test Mode: Press and hold ON/MUTE button for 3 seconds to enter UPS self-testing while in AC mode.
OFF/ENTER	<ul style="list-style-type: none"> • Turn Off: Press and hold this button for at least 2 seconds to turn the UPS off. • Confirm Selection Key: Press this button to confirm selection in UPS setting mode.
SELECT	<ul style="list-style-type: none"> • Switch LCD Message: Press this button to change the LCD message for input voltage, input frequency, battery voltage, output voltage, and output frequency. • Setting Mode: Press and hold this button for 3 seconds to enter UPS setting mode when UPS is off. • Down Key: Press this button to display next selection in UPS setting mode.
SELECT + OFF/ENTER	<ul style="list-style-type: none"> • Rack or Tower Display Switch: Press SELECT and OFF/ENTER buttons simultaneously for 3 seconds. The display changes from/to Rack to/from Tower.





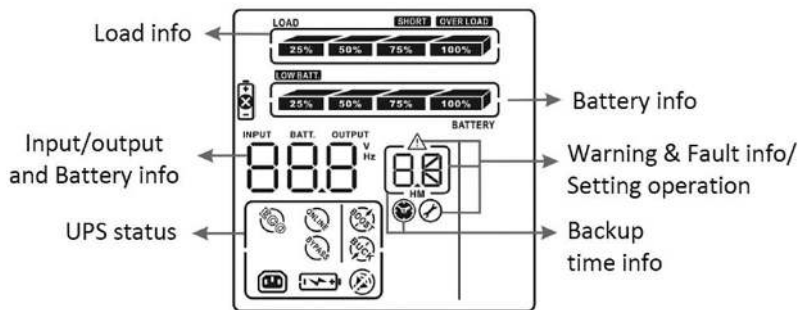



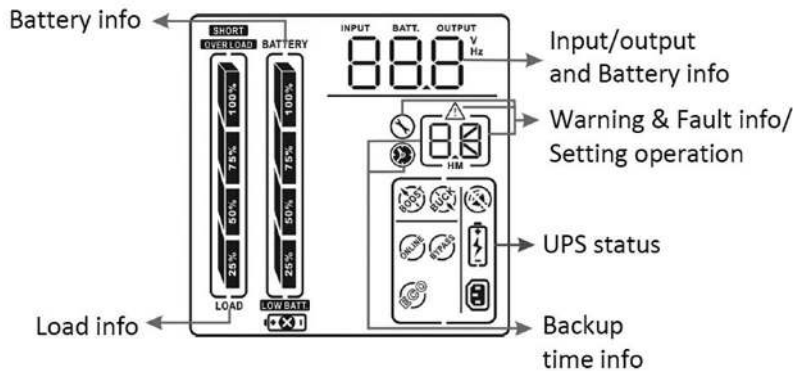







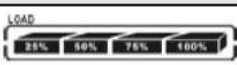

LCD Panel

Rack Display



Tower Display



Display	Function
Backup Time Information	
	Indicates the backup time in pie chart.
	Indicates the backup time in numbers. H: hours, M: minutes
Warning & Fault Information	
	Indicates that warning and fault occurs.
	Indicates the warning fault codes, which are listed in detail in this manual.
Setting Operation	
	Indicates the setting operation.
Input/Output & Battery Information	
	Indicates the output/input voltage, output/input frequency or battery voltage. V: output voltage, Hz: frequency
Load Information	
	Indicates the load level by 0-25%, 26-50%, 51-75%, and 76-100%.
	Indicates overload.
	Indicates the load or the UPS output is short circuited.
UPS Status	
	Indicates that programmable management outlets are working.
	Indicates that the UPS alarm is disabled.
	Indicates the UPS powers the output directly from the mains.
	Indicates the battery charger is working.
	Indicates the UPS is working in boost mode.
	Indicates the UPS is working in buck mode.
Battery Information	
	Indicates the battery level by 0-25%, 26-50%, 51-75%, and 76-100%.
	Indicates low battery.
	Indicates there is something wrong with the battery.

Audible Alarms

Description	Buzzer Status
Battery Mode	Sounds every 10 seconds
Low Battery	Sounds every 2 seconds
Overload	Sounds every second
Fault	Continuously sounds

Abbreviations in LCD Display

Abbreviation	Display	Meaning
ENA	ENR	Enable
DIS	dl S	Disable
ESC	ESC	Escape
ON	ON	ON
OK	OK	OK
EP	EP	EPO
TP	TP	Temperature
CH	CH	Charger
RAC	RAC	Rack Display
TOE	TOE	Tower Display
SF	SF	Site Fault
EE	EE	EEPROM Error
BR	BR	Battery Replacement

UPS Setting

There are two parameters to set up the UPS:

- **Parameter 1:** For program alternatives. Refer to below table for details.
- **Parameter 2:** For setting options or values for each program.

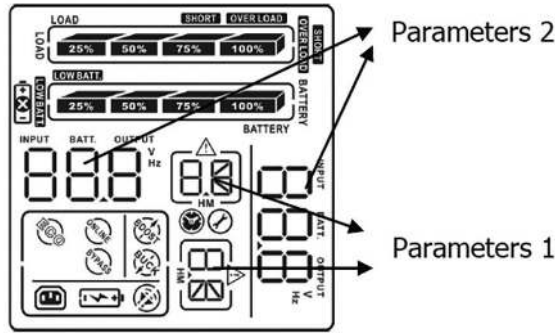

01: Output Voltage Settings

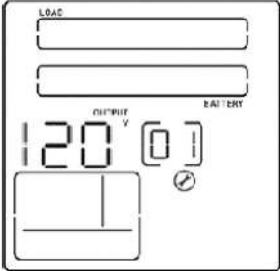
Interface	Setting
	<p>You may choose the following output voltage:</p> <p>110: presents output voltage as 110VAC 115: presents output voltage as 115VAC 120: presents output voltage as 120VAC (default) 127: presents output voltage as 127VAC</p>

02: Programmable Outlets Enable/Disable

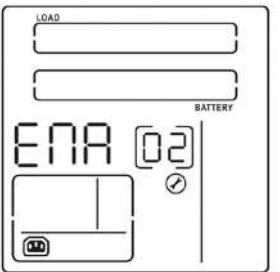
Interface	Setting
	<p>ENA: Programmable outlets enable (default) DIS: Programmable outlets disable</p>

03: Programmable Outlets Setting

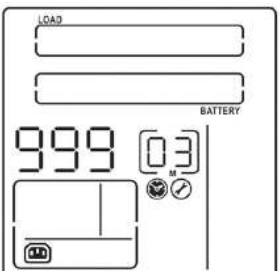
Interface	Setting
	<p>Setting the backup time limit in minutes from 0-999 for programmable outlets which connect to non-critical devices on battery mode.</p>

04: Maximum Charger Current Setting

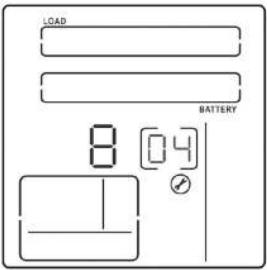
Interface	Setting
	<p>Set up the maximum charger current.</p> <p>1/2/4/6/8: Setting the maximum charger current at 1/2/4/6/8A (default: 8A)</p> <p>Note: This setting is only effective for super charger.</p>

05: LCD Display Direction Setting

Interface	Setting
	<p>RAC: The LCD display is horizontal.</p> <p>TOE: The LCD display is vertical.</p>

06: Autonomy Limitation Setting

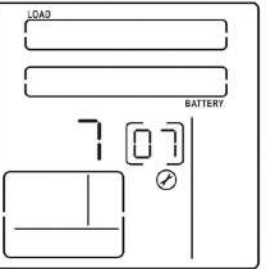

Interface	Setting
	<p>Parameter 2: Set up backup time on battery mode for general outlets.</p> <p>0-999: Setting the backup time in minutes from 0-999 for general outlets on battery mode.</p> <p>DIS: Disable the autonomy limitation and the backup time will depend on battery capacity. (default)</p> <p>Note: When setting is "0", the backup time will be only 10 seconds.</p>

07: Battery Total AH Setting

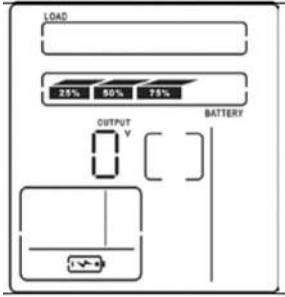

Interface	Setting
	<p>Parameter 2: Set up the battery total AH of the UPS.</p> <p>7-999: Setting the battery total capacity from 7-999 in AH.</p> <p>Please set the correct battery total capacity if external battery bank is connected.</p>

00: Exit Setting

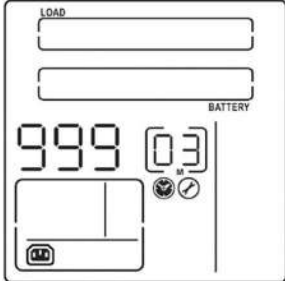
Steps for setting programmable outlet

<p>Step 1: Before entering setting mode, the UPS should be in Stand-by mode (off-charging) and make sure the battery is connected. The LCD display is shown at right.</p>	 <p>The LCD display shows the following information: a 'LOAD' bar at the top, a battery level indicator showing 25%, 50%, and 75% marks, 'OUTPUT V' showing 0, and 'BATTERY' status. There are also some empty bars and a small icon at the bottom left.</p>
<p>Step 2: Press and hold the "Select" button for 3 seconds to enter Setting mode.</p>	 <p>The LCD display shows 'LOAD' bars, 'OUTPUT V' showing 120, and 'BATTERY' status. A parameter '01' is displayed in a box on the right side.</p>
<p>Step 3: Press the "Up" button (ON/MUTE) to switch to "02" of program list. Then press "Enter" button to enter value setting of parameter 2. Press the "Up" button to change the value to "ENA" to enable the programmable outlet function. Then press "Enter" button again to confirm the setting.</p>	 <p>The LCD display shows 'LOAD' bars, 'OUTPUT V' showing ENA, and 'BATTERY' status. A parameter '02' is displayed in a box on the right side. There is a small icon at the bottom left.</p>
<p>Step 4: Press the "Up" button (ON/MUTE) again to switch to "03" of program list. Then press "Enter" button for setting programmable outlet time. Push "Up" button to change the value of backup time desired. Then press "Enter" to confirm the setting.</p>	 <p>The LCD display shows 'LOAD' bars, 'OUTPUT V' showing 999, and 'BATTERY' status. A parameter '03' is displayed in a box on the right side. There are two small icons at the bottom right.</p>
<p>Step 5: Press "UP" button (ON/MUTE) to switch to "00" of program list. Then press "Enter" button to exit setting menu.</p>	
<p>Step 6: Disconnect AC input and wait until the LCD display is off. The new setting will be activated when turning the UPS on again.</p>	

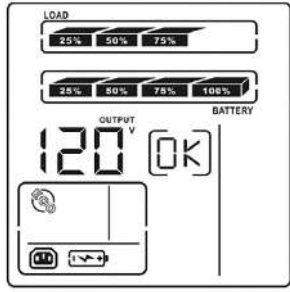

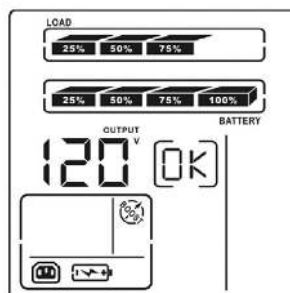
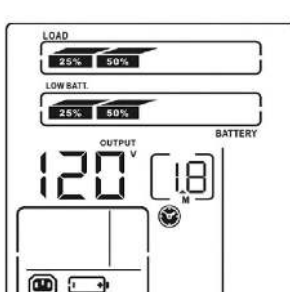
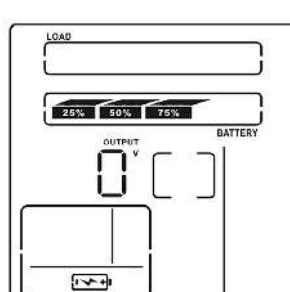







Operating Mode Descriptions

Operating Mode	Description	LCD Display
ECO mode	When the input voltage is within voltage regulated range, UPS will power the output directly from the mains. ECO is an abbreviation of Efficiency Corrective Optimizer. In this mode, when battery is fully charged, the fan will stop working for energy saving.	 <p>The LCD display for ECO mode shows two load bars at the top (25%, 50%, 75% and 25%, 50%, 75%, 100%), an output voltage of 120V, an OK indicator, and a battery level indicator at the bottom.</p>
Buck mode when AC is normal	When the input voltage is higher than the voltage regulation range but lower than high loss point, the buck AVR will be activated.	 <p>The LCD display for Buck mode shows two load bars at the top, an output voltage of 120V, an OK indicator, and a battery level indicator at the bottom.</p>
Boost mode when AC is normal	When the input voltage is lower than the voltage regulation range but higher than low loss point, the boost AVR will be activated.	 <p>The LCD display for Boost mode shows two load bars at the top, an output voltage of 120V, an OK indicator, and a battery level indicator at the bottom.</p>
Battery mode	When the input voltage is beyond the acceptable range or power failure and alarm is sounding every 10 seconds, UPS will backup power from battery.	 <p>The LCD display for Battery mode shows two load bars at the top, an output voltage of 120V, a 18M indicator, and a battery level indicator at the bottom.</p>
Standby mode	UPS is powered off without output power, but the battery is still being charged.	 <p>The LCD display for Standby mode shows two load bars at the top, an output voltage of 0V, and a battery level indicator at the bottom.</p>

Fault Reference Codes







Fault Event	Fault Code	Icon	Fault Event	Fault Code	Icon
Bus start failure	01	x	Inverter output short	14	SHORT
Bus over	02	x	Battery voltage too high	27	x
Bus under	03	x	Battery voltage too low	28	
Inverter soft start fail	11	x	Over temperature	41	x
Inverter voltage high	12	x	Overload	43	OVER LOAD
Inverter voltage low	13	x	Charger failure	45	x

Warning Indicators

Warning	Icon (flashing)	Alarm
Low Battery		Sounds every 2 seconds
Overload		Sounds every second
Battery Not Connected		Sounds every 2 seconds
Overcharge		Sounds every 2 seconds
Site Wiring Fault		Sounds every 2 seconds
EPO Enable		Sounds every 2 seconds
Over Temperature		Sounds every 2 seconds
Charger Failure		Sounds every 2 seconds
Battery Fault		Sounds every 2 seconds (At this time UPS is off to remind users that something is wrong with the battery)
EEPROM Error		Sounds every 2 seconds
Battery Replacement		Sounds every 2 seconds

TROUBLESHOOTING

If the UPS does not operate correctly, use the table below to troubleshoot the problems.

Symptom	Possible Cause	Remedy
No indication and alarm even though the utility is normal.	The AC input power is not connected well.	Check that the input power cord is firmly connected to the utility.
	The AC input is connected to the UPS output.	Plug the AC input power cord into the AC input utility correctly.
The icon  and the warning code EP are flashing on LCD display and alarm is sounding every second.	EPO function is enabled.	Set the circuit to the closed position to disable EPO function.
The icon  and SF are flashing on LCD display and alarm is sounding every second.	Line and neutral conductors of UPS input are reversed.	Have a qualified electrician correct the input receptacle wiring.
The icon  and  are flashing on LCD display and alarm is sounding every second.	The internal battery is incorrectly connected.	Check to make sure all batteries are properly connected.
Fault code is shown as 27 and the icon  is showing on LCD display and alarm is continuously sounding.	Battery voltage is too high or the charger is in fault condition.	Contact your dealer for support.
Fault code is shown as 28 and the icon  is showing on LCD display, and alarm is continuously sounding.	Battery voltage is too low or the charger is in fault condition.	Contact your dealer for support.
Fault code is shown as 14 and alarm is continuously sounding.	The UPS shut down automatically because short circuit condition occurred on the UPS output.	Disconnect loads and check output wiring or connected devices are in short circuit status.
Fault code is shown as 01, 02, 03, 04, 11, 12, 13, and 41 on LCD display and alarm is continuously sounding.	A UPS internal fault has occurred. There are two possible results: 1. The load is still supplied, but directly by AC utility via bypass. 2. The load is no longer supplied with power.	Contact your dealer for support.
Battery backup time is shorter than expected.	Batteries are not fully charged.	Charge the batteries for at least 5 hours and then re-check capacity. If the problem still exists, contact your dealer for support.
	Batteries are defective.	Contact your dealer for battery replacement.

STORAGE & MAINTENANCE

Operation

The UPS system contains no user-serviceable parts. If the battery service life (3~5 years at 77°F [25°C] ambient temperature) has been exceeded, the batteries must be replaced. In this case, contact your dealer.

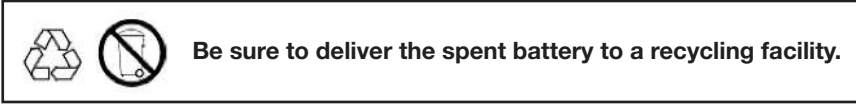

Storage

Before storing, charge the UPS at least 5 hours. Store the UPS covered and upright in a cool, dry location. During storage, recharge the battery in accordance with the following table:

Storage Temperature	Recharge Frequency	Charging Duration
-13°F to 104°F (-25°C to 40°C)	Every 3 months	1-2 hours
104°F to 113°F (40°C to 45°C)	Every 2 months	1-2 hours

SPECIFICATIONS

MODEL NO.		UPS8-1100	UPS8-1500	UPS8-2000	UPS8-2200	UPS8-3000
CAPACITY	Power rating	1100VA (990W)	1500VA (1350W)	2000VA (1800W)	2200VA (2000W)	3000VA (2700W)
INPUT	Voltage nominal	120VAC				
	Voltage range	-32% to +27% without use of battery				
	Frequency	50/60Hz auto-sensing				
OUTPUT	Voltage	120VAC nominal (110/115/127 selectable)				
	Waveform	Pure sine wave				
	Transfer time (typical)	2–6ms				
	Efficiency	Up to 99% ECO mode, 95% buck and boost mode				
	Harmonic distortion	2% @ 100% linear load; 5% @ 100% non-linear load				
BATTERY	Battery type	Sealed, maintenance-free lead acid				
	Battery quantity/size	(2) 12V 9AH	(4) 12V 7AH	(4) 12V 9AH	(6) 12V 7AH	(6) 12V 9AH
	Charging current	1.5A max				
	Typical recharge	4 hours to 90%				
PHYSICAL	Dimensions W x D x H	17.2 x 15.1 x 3.5 in	17.2 x 18.9 x 3.5 in		17.2 x 23.6 x 3.5 in	
	Weight	30.5 lbs	44.7 lbs	47.4 lbs	61.7 lbs	67.1 lbs
	Line cord	6 ft, 5–15P	6 ft, 5–15P	6 ft, 5–20P	6 ft, 5–20P	6 ft, L5–30P
	Receptacles	(8) NEMA 5–15R		(8) NEMA 5–15/20R		
OPTIONAL BATTERY PACKS	Model number	N/A	UPS-XBP-48		UPS-XBP-72	
	Dimensions W x D x H	N/A	17.2 x 18.9 x 3.5 in		17.2 x 23.6 x 3.5 in	
	Weight	N/A	74.6 lbs		104.4 lbs	
	Battery	N/A	(8) 12V 9AH / 48V		(12) 12V 9AH / 72V	
ENVIRONMENT	Operating temperature	32–104°F (0–40°C)				
	Audible noise	< 45dBA				
	Altitude	11,500 ft above sea level				
APPROVALS	UL, cUL, RoHS					
WARRANTY	3 years electronics, 3 years battery warranty (USA and Canada)					
COMMUNICATIONS INTERFACE	RS-232, USB, EPO, intelligent slot for optional cards (web/SNMP, relay/dry contact)					
INCLUDED IN BOX	software CD, 4-point rail kit, brackets, tower pedestals					

OBTAINING SERVICE

If the UPS requires service:

1. Use the TROUBLESHOOTING section in this manual to eliminate obvious causes.
2. Verify there are no circuit breakers tripped.
3. Call your dealer for assistance. If you cannot reach the dealer or if they cannot resolve the problem, call Lowell Manufacturing Company at (800) 325-9660. Technical support inquiries can also be made by email to sales@lowellmfg.com. Please have the following information available BEFORE calling:
 - Your name and address.
 - The serial number of the unit.
 - Where and when the unit was purchased.
 - All of the model information about your UPS.
 - Any information on the failure, including LEDs that may or may not be illuminated.
 - A description of the protected equipment, including model numbers if possible.
 - A representative will ask you for the above information and, if possible, help solve the problem over the phone. In the event that the unit requires factory service, the representative will issue you a Return Material Authorization number (RMA).

If you are returning the UPS for service, please follow these procedures:

1. Pack the UPS in its original packaging. If the original packaging is no longer available, ask the Lowell representative about obtaining a replacement set of packaging material. It is important to pack the UPS properly in order to avoid damage in transit. Never use Styrofoam beads for a packing material.
2. Include a letter with your name, address, daytime phone number, RMA number, a copy of your original sales receipt, and a brief description of the problem.
3. Mark the RMA number on the outside of all packages. Lowell Manufacturing cannot accept any package without the RMA number marked on the outside of the boxes.
4. Return the UPS by insured, prepaid carrier to the address provided by the Lowell representative.
5. Refer to the Warranty statements in this manual for additional details on what is covered.

LIMITED WARRANTY

Lowell Manufacturing Company warrants Lowell UPS equipment, when properly applied and operated within specified conditions, against faulty materials or workmanship for a period of **three years for UPS8 Series products** from the date of purchase. Lowell Manufacturing Company warrants **internal batteries for a period of three years** from the date of purchase. For equipment sites within the United States and Canada, this warranty covers repair or replacement, at the sole discretion of Lowell Manufacturing Company. The customer is responsible for the costs of shipping the defective product to Lowell Manufacturing Company. Lowell Manufacturing Company will pay for ground shipment of the repaired or replacement product. This warranty applies only to the original purchaser.

If equipment provided by Lowell Manufacturing Company is found to be **Dead-on-Arrival (DOA)**, Lowell Manufacturing Company will be responsible for the costs of shipping product to and returning equipment from the customer in a timely manner as agreed to with the customer, once the customer has requested and received a **Return Material Authorization (RMA)** number. DOA equipment is defined as equipment that does not properly function according to user documentation when initially received and connected in conjunction with proper procedures as shown in the user documentation or via support provided by Lowell Manufacturing Company personnel or authorized agents.

This warranty shall be void if (a) the equipment is repaired or modified by anyone other than Lowell Manufacturing Company or a Lowell Manufacturing Company approved third party; (b) the equipment is damaged by the customer, is improperly used or stored, is subjected to an adverse operating environment, or is operated outside the limits of its electrical specifications; or (c) the equipment has been used or stored in a manner contrary to the equipment's operating manual, intended use or other written instructions. Any technical advice furnished by Lowell Manufacturing Company or a Lowell Manufacturing Company authorized representative before or after delivery with regard to the use or application of Lowell Manufacturing Company equipment is furnished on the basis that it represents Lowell Manufacturing Company's best judgment under the situation and circumstances, but it is used at the recipient's sole risk.

EXCEPT AS STATED ABOVE, Lowell Manufacturing Company DISCLAIMS ALL WARRANTIES, EXPRESSED OR IMPLIED, INCLUDING WARRANTIES OF MERCHANTABILITY AND FITNESS FOR A PARTICULAR PURPOSE.

EXCEPT AS STATED ABOVE, IN NO EVENT WILL Lowell Manufacturing Company BE LIABLE FOR DIRECT, INDIRECT, SPECIAL, INCIDENTAL, OR CONSEQUENTIAL DAMAGES ARISING OUT OF THE USE OF Lowell Manufacturing Company UPS8 Series EQUIPMENT, including but not limited to, any costs, lost profits or revenue, loss of equipment, loss of use of equipment, loss of software, loss of data, cost of substitutes, or claims by third parties. Purchaser's sole and exclusive remedy for breach of any warranty, expressed or implied, concerning Lowell Manufacturing Company equipment, and the only obligation of Lowell Manufacturing Company under this warranty, shall be the repair or replacement of defective equipment, components, or parts; or, at Lowell Manufacturing Company's sole discretion, refund of the purchase price or substitution of an equivalent replacement product.

APPENDIX A: External Battery Pack (Model UPS-XBP-48, UPS-XBP-72)

Important Safety Instructions

Please comply with all warnings and operating instructions in this manual strictly. Save this manual properly and read carefully the following instructions before installing the unit. Do not operate this unit before reading through all safety information and operating instructions carefully.

- Do not try to repair the unit yourself, contact your local supplier or your warranty will be void.
- To eliminate any overheating of the battery box, keep all ventilation openings free from obstruction and do not place any foreign objects on top of the battery bank. Keep the battery box 8 inches (20cm) away from the wall.
- Make sure the battery box is installed within the proper environment as specified. (0-40°C and 30-90% non-condensing humidity)
- Do not install the battery box under direct sunlight. Your warranty will be void if the batteries fail due to overheating.
- This battery box is not designed for use in dusty, corrosive and salty environments.
- The warranty for this battery bank will be void if water or other liquid is spilled or poured directly onto the battery box. Similarly we do not warrant any damage to the battery box if foreign objects are deliberately or accidentally inserted into the battery box enclosure.
- The battery will discharge naturally if the system is unused for a period of time.
- It should be recharged every 2-3 months if unused. If this is not done, then the warranty will be null and void. During normal operation, the batteries will automatically remain in charged condition.
- Servicing of batteries should be performed or supervised by trained personnel with knowledge of batteries and the required precautions.
- When replacing batteries, it is necessary to replace ALL batteries with the same quantity, type & capacity.
- **CAUTION** – Do not dispose of battery or batteries in a fire. The battery may explode.
- **CAUTION** – Do not open or mutilate the batteries. The electrolyte from the batteries is toxic and harmful to the skin and eyes.
- **CAUTION** – Risk of Electric Shock –Hazardous voltage may exist between battery terminals and ground. Test before touching with bare hands.
- **CAUTION** – A battery can present a risk of electrical shock and high short circuit current. The following precautions should be observed when working on batteries:
 - Remove watches, rings, and other metal objects.
 - Use tools with insulated handles.
 - Wear rubber gloves and boots.
 - Do not lay tools or metal parts on top of batteries.
 - Disconnect charging source prior to connecting or disconnecting battery terminals.
- Do not plug or unplug the battery connector if UPS works in DC (discharging) mode.

Product Overview & Set Up

NOTE: Before installation, inspect the unit. Be sure that nothing inside the package is damaged. Keep the original package in a safe place for future use.

Rear Panel View:

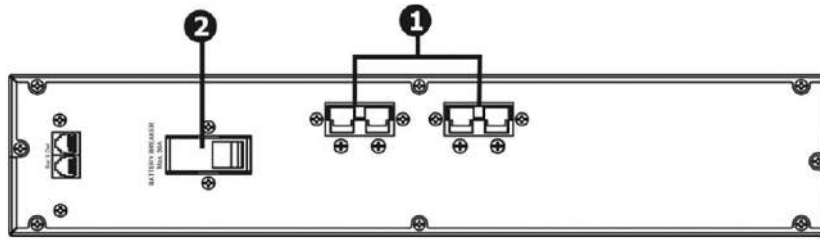

1. DC connector: Connects to either UPS or second battery box
2. DC breaker: Battery over-current protection breaker

Installation & Set Up With UPS:

Unpacking & Inspection:

1. Remove the battery box from the packing.

NOTE: The battery box is very heavy, be cautious when unpacking and lifting the unit to avoid injury.

2. Check inside the package
 - Battery box unit
 - Battery connection cable
 - Ears (brackets) with screws
 - Extended stand
 - 4-point rail kit with screws

Selecting Installation Position:

It is necessary to select a proper environment to install the unit, in order to minimize the possibility of damage to the battery box and extend the life of the batteries. Please follow the instructions below:

1. Keep at least 8 inches (20cm) clearance from the rear panel of the unit from the wall or other obstructions.
2. Do not block the air-flow to the ventilation openings of the unit.
3. Ensure the installation site environmental conditions are in accordance with the unit's working specifications to avoid overheating and excessive moisture.
4. Do not place the unit in a dusty or corrosive environment or near any flammable objects.
5. This unit is not designed for outdoor use.

This unit can either be rackmounted or placed vertically on the desk.

Rack Installation (with 4-point rail kit):

Step 1: Mount the 4-point rail kit to the rack. Use the (8) 10-32 screws provided to mount left and right support rails (front and rear).

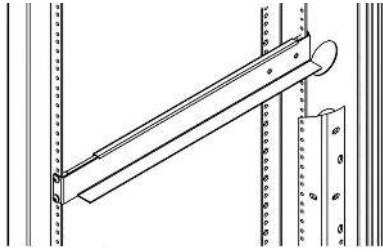

Step 2: Attach the mounting brackets to the unit. **CAUTION**—DO NOT use mounting brackets to lift the unit; brackets are only to secure it to the rack.

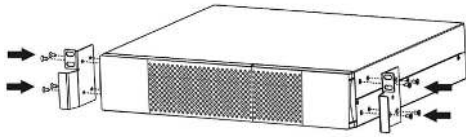

Step 3: Place unit on the support rails and secure in place with front screws, allowing the horizontal rails to support the weight of the unit.

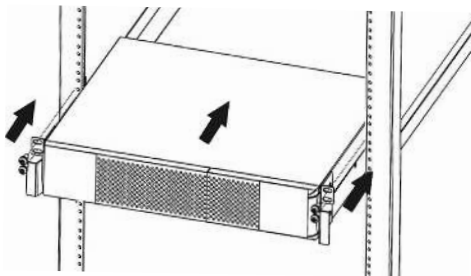

Tower Installation:

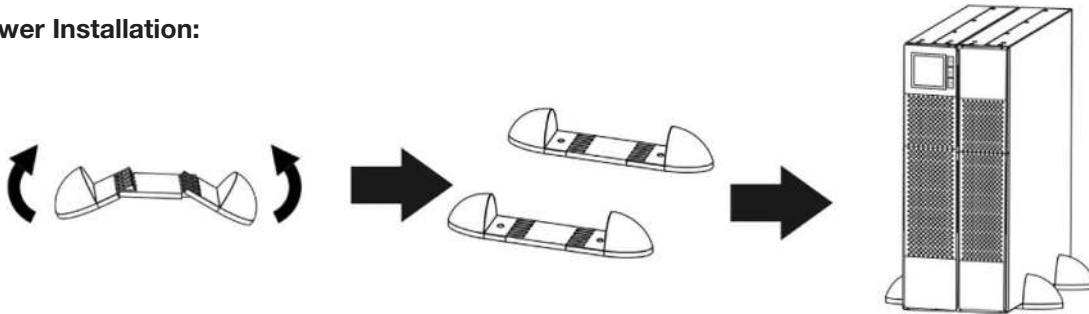

Connecting with UPS and Other Battery Box:

Follow installation below to connect with UPS and another battery box with included cable.

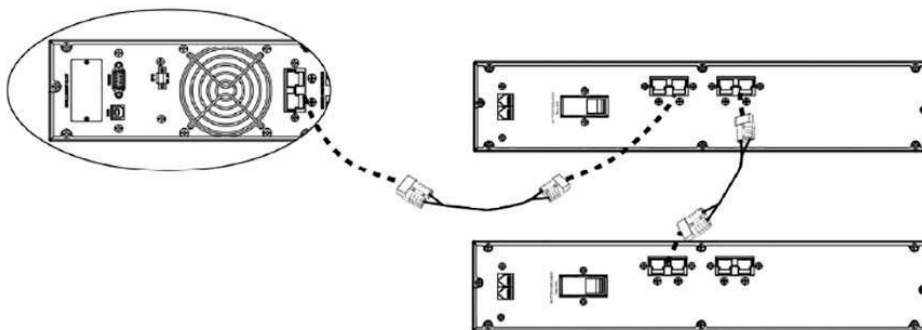

Type of Battery Required

This battery box has been designed to operate with the following types of batteries:

48V/9Ah Version: 4 pieces of 12V 9Ah batteries per string.

72V/9Ah Version: 6 pieces of 12V 9Ah batteries per string.

Battery Replacement

If your battery box is not installed with batteries, follow proper procedure to put batteries inside of unit.

NOTE: MAKE SURE THAT THE BATTERY BOX IS DISCONNECTED FROM THE UPS BEFORE PERFORMING THE FOLLOWING SEQUENCE OF OPERATIONS.

MODEL NO. UPS-XBP-48:

Step 1: Open the package and place the battery box on a horizontal plane.

Step 2: Remove the left side of the front panel by pulling it from the lower extremity.

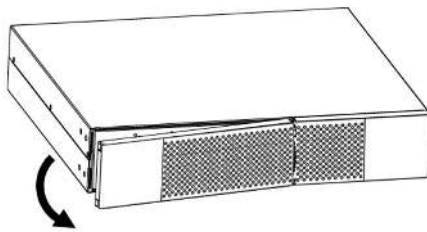

Step 3: Remove the fixed part of the front panel by removing the 2 screws present.

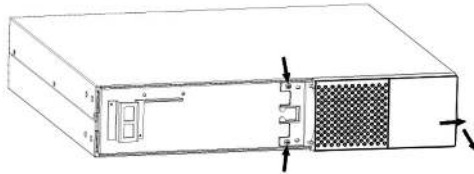

Step 4: Remove the metal top cover of the battery box by unscrewing 8 screws on the sides (4 per side), 3 screws on top, and 4 screws on back.

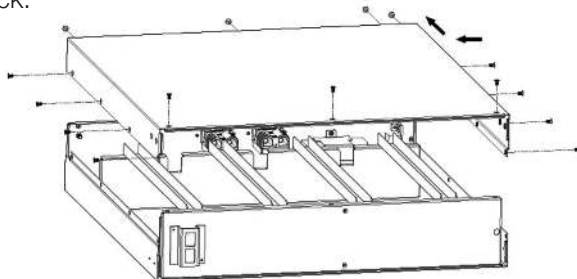

Step 5: Once the battery box is opened, remove the hold down brackets on the left side by unscrewing the 2 screws on each bracket. **Note:** To install a second string of batteries, repeat the same procedure on the battery hold down brackets on the right side of battery box.

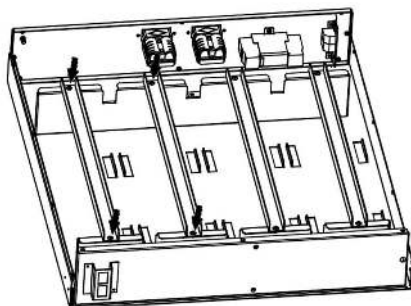

Step 6: Now, it is possible to put all batteries inside the unit by following the drawing below, which indicates wire fastener positions for correct battery placement. **Note:** To install a second string of batteries, repeat the same procedure on the right side of battery box.

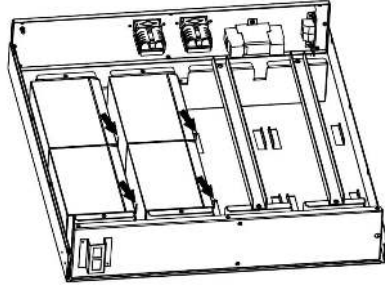

Step 7: Connect all batteries following the Wiring Diagram in the next section.

Step 8: Put all batteries inside and secure in place with hold down brackets. **Note:** To install a second string of batteries, repeat the same procedure on the right side of battery box.

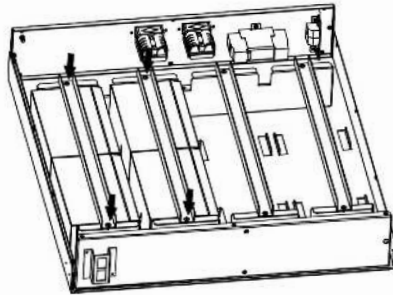

Step 9: Replace the metal top cover on the unit. Close the front fixing plate and the two parts of the front panel and secure with screws.

Step 10: Connect the battery box to the UPS.

MODEL NO. UPS-XBP-72:

Step 1: Open the package and place the battery box on a horizontal plane.

Step 2: Remove the left side of the front panel by pulling it from the lower extremity.

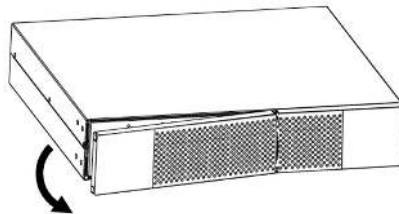

Step 3: Remove the fixed part of the front panel by removing the 2 screws present.

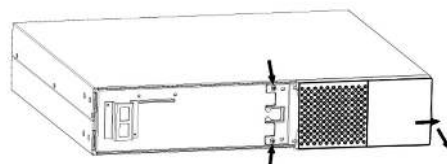

Step 4: Remove the metal top cover of the battery box by unscrewing 8 screws on the sides (4 per side), 3 screws on top, and 4 screws on back.

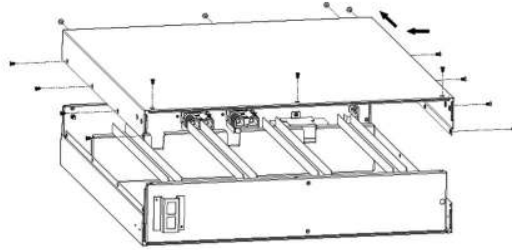

Step 5: Once the battery box is opened, remove the hold down brackets on the left side by unscrewing the 2 screws on each bracket. **Note:** To install a second string of batteries, repeat the same procedure on the hold down brackets on the right side of battery box.

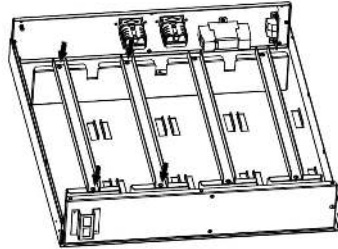

Step 6: Now, it is possible to put all batteries inside the unit by following the drawing below, which indicates wire fastener positions for correct battery placement. **Note:** To install a second string of batteries, repeat the same procedure on the right side of battery box.

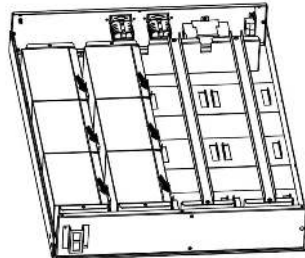

Step 7: Connect all batteries following the Wiring Diagram in the next section.

Step 8: Put all batteries inside and secure in place with hold down brackets. **Note:** To install a second string of batteries, repeat the same procedure on the right side of battery box.

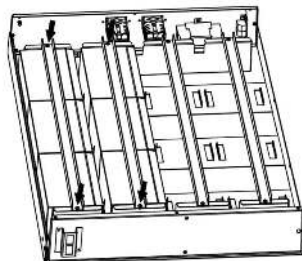

Step 9: Replace the metal top cover on the unit. Close the front fixing plate and the two parts of the front panel and secure with screws.

Step 10: Connect the battery box to the UPS.

Wiring Diagrams:

MODEL NO. UPS-XBP-48:

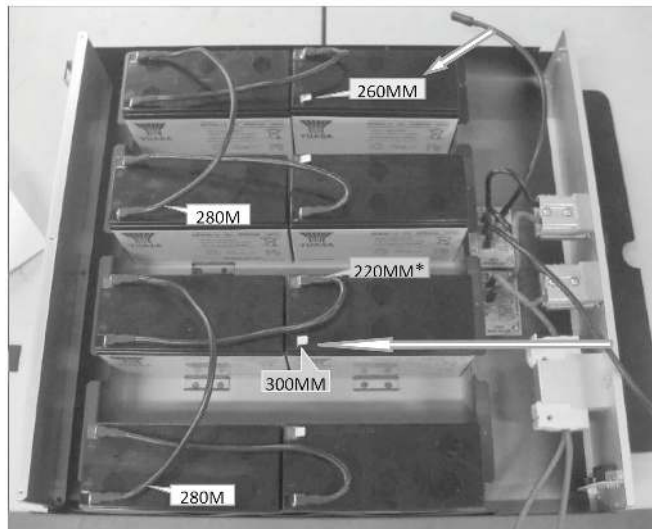
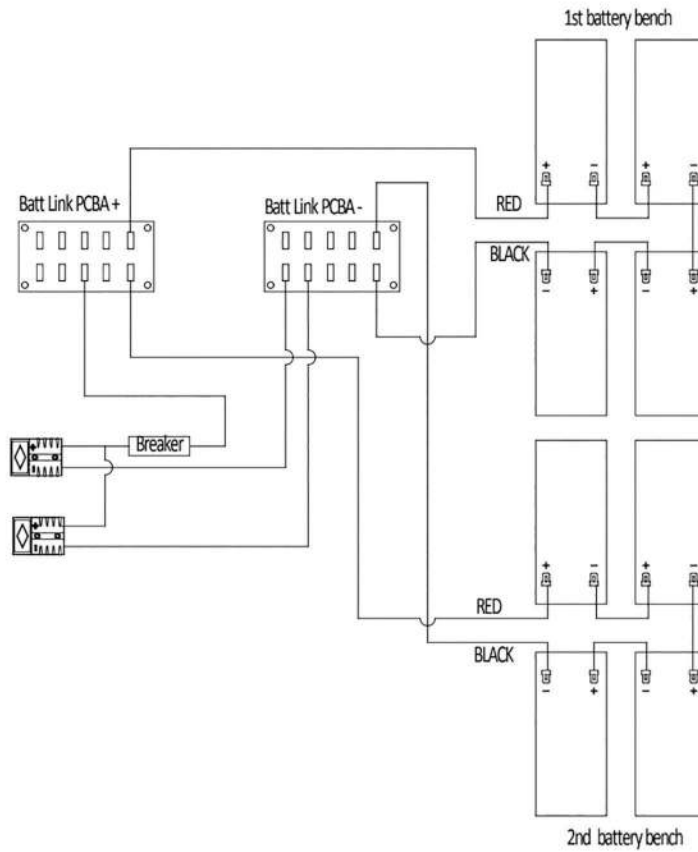

NOTE: The cable connection from the external battery connector to PCB is already present inside the battery box. All the other cable connections should be made in accordance with the above wiring diagram.

MODEL NO. UPS-XBP-72:

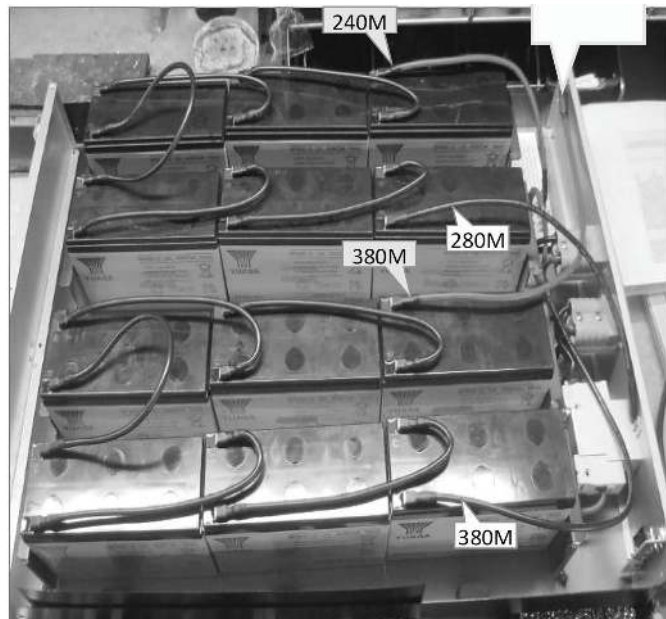
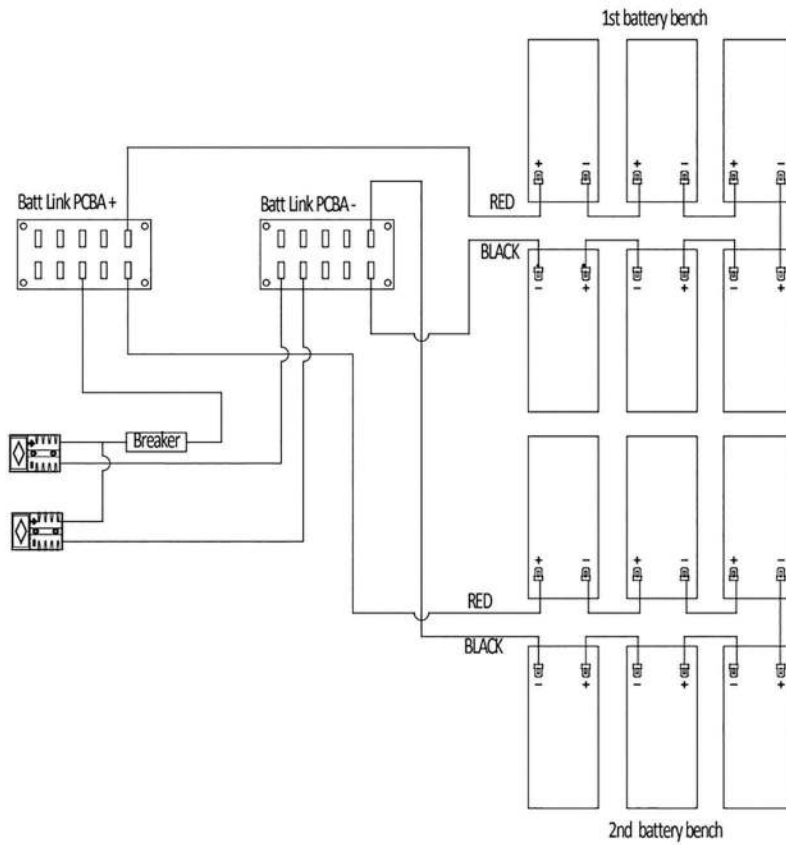

NOTE: The cable connection from the external battery connector to PCB is already present inside the battery box. All the other cable connections should be made in accordance with the above wiring diagram.

STORAGE & MAINTENANCE

The unit contains no user-serviceable parts. If the battery service life (3~5 years at 77°F [25°C] ambient temperature) has been exceeded, the batteries must be replaced. In this case, contact your dealer.

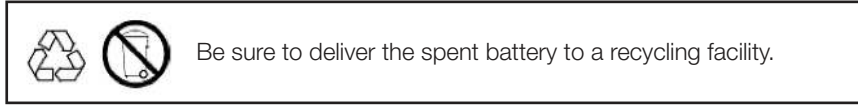

Storage

Before storing, charge the unit 4 hours. Store the unit covered and upright in a cool, dry location. During storage, recharge the battery in accordance with the following table:

Storage Temperature	Recharge Frequency	Charging Duration
-13°F to 104°F (-25°C to 40°C)	Every 3 months	1-2 hours
104°F to 113°F (40°C to 45°C)	Every 2 months	1-2 hours