

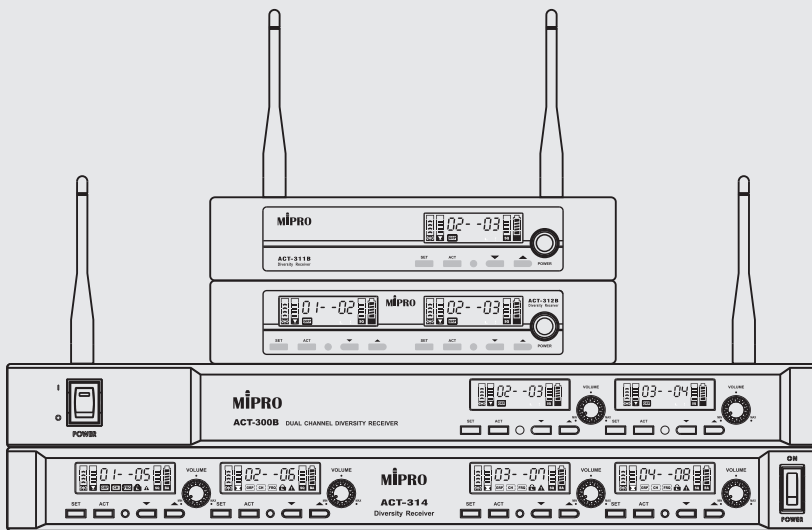

ACT 3-Series Diversity Wireless Receivers

User Guide





! IMPORTANT SAFETY INSTRUCTIONS !

1. Read these instructions.
2. Keep these instructions.
3. Heed all warnings.
4. Follow all instructions.
5. Do not use this apparatus near water.
6. Clean only with a dry cloth.
7. Do not block any ventilation openings. Install in accordance with the manufacturer's instructions.
8. Do not install near any heat sources such as radiators, heat registers, stoves, or other apparatus (including amplifiers) that produce heat.
9. Do not defeat the safety purpose of the polarised or ground plug: A polarised plug has two blades with one wider than the other. The wide blade is provided for your safety. When the provided plug does not fit into your outlet, consult an electrician for replacement of the obsolete outlet.
10. Protect the power cord from being walked on or pinched particularly at plug, convenience receptacles, and the point where they exit from the apparatus.
11. Only use attachments/accessories specified by the manufacturer.
12. Use only with a cart, stand, tripod, bracket, or table specified by the manufacturer, or sold with the apparatus. When a cart is used, use caution when moving the cart/apparatus combination to avoid injury from tip-over.
13. Unplug this apparatus during lightning storms or when unused for long periods of time.
14. Refer all servicing to qualified service personnel. Servicing is required when the apparatus has been damaged in any way, such as power-supply cord or plug is damaged, liquid has been spilled or objects have fallen into the apparatus, the apparatus has been exposed to rain or moisture, does not operate normally, or has been dropped.
15. To reduce the risk of fire or electric shock, do not expose this apparatus to rain or moisture.
16. Apparatus should not be exposed to dripping or splashing and no objects filled with liquids, should be placed on the apparatus.
17. Use only with the battery which specified by manufacturer.
18. The power supply cord set is to be the main disconnected device.
19. Where the MAINS plug or an appliance coupler is used as the disconnect device, the disconnect device shall remain readily operable.



WARNING

1. **FOR OUTDOOR USE:**



To reduce the risk of fire or electric shock, do not expose this apparatus to rain or moisture.

2. **UNDER WET LOCATION:**

Apparatus should not be exposed to dripping or splashing and no objects filled with liquids, such as vases should be placed on the apparatus.

3. **SERVICE INSTRUCTIONS:**

CAUTION - These servicing instructions are for use by qualified service personnel only. To reduce the risk of electric shock, do not perform any servicing other than that contained in the operating instructions unless you are qualified to do so.

	
	This symbol indicates that dangerous voltage constituting a risk of electric shock is present within this unit.
	This symbol indicates that there are important operating and maintenance instructions in the literature accompanying this unit.

FC & IC - ID

THIS DEVICE COMPLIES WITH PART15 OF THE FCC RULES AND RSS-123 ISSUE2 OF CANADA. OPERATION IS SUBJECT TO THE FOLLOWING TWO CONDITIONS:

- (1) This device may not cause interference.
- (2) This device must accept any interference, including interference that may cause undesired operation of the device. This equipment complies with FCC RF radiation exposure limits set forth for an uncontrolled environment.

Disposal Dispose of any unusable devices or batteries responsibly and in accordance with any applicable regulations.



2005-08-13

Disposing of used batteries with domestic waste is to be avoided!

Batteries / NiCad cells often contain heavy metals such as cadmium(Cd), mercury(Hg) and lead(Pb) that makes them unsuitable for disposal with domestic waste. You may return spent batteries/ accumulators free of charge to recycling centres or anywhere else batteries/accumulators are sold.

By doing so, you contribute to the conservation of our environment!

Contents

- 1 Part Names
- 3 Receiver Installation
- 4 Receiver Operation
- 5 Rackmount Installation for Receivers
- 6 Tips for Improving System Performance
- 7 LCD Screen
- 13 NOTE

Diversity Wireless Receivers

Part Names, Fig. 1.

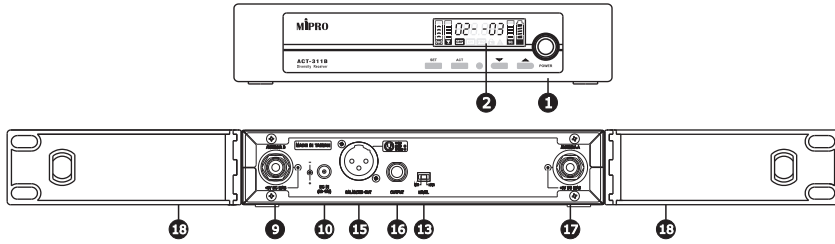

ACT-311B Single-Channel

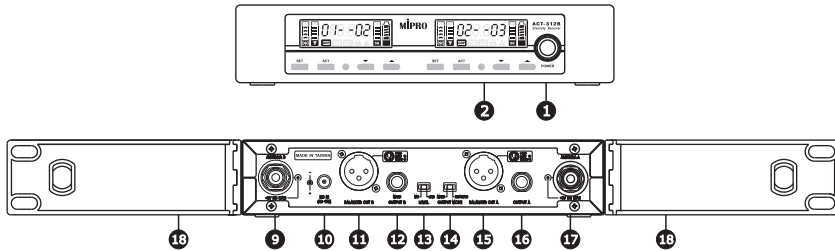

ACT-312B Dual-Channel

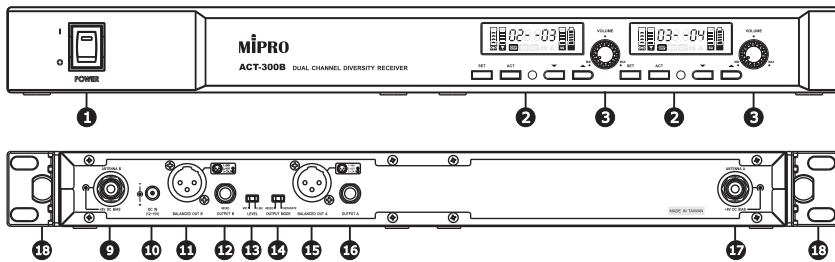

ACT-300B Dual-Channel

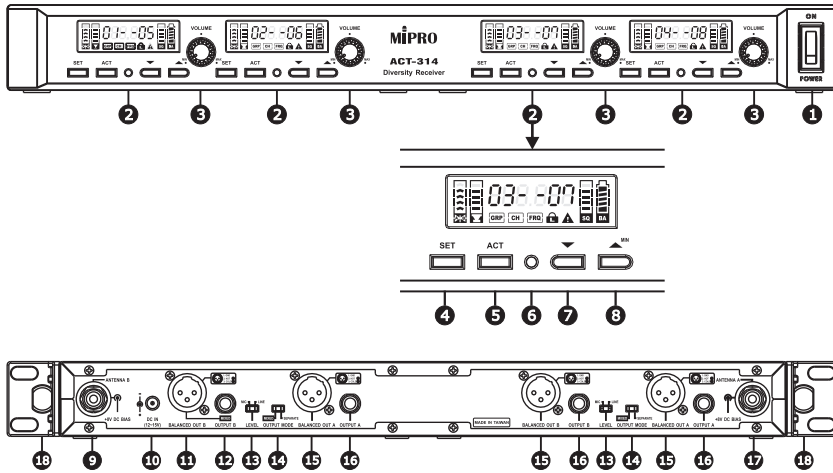

ACT-314 Quad-Channel

Fig. 1

- ① Power switch.
- ② LCD Screen.
- ③ Volume Control.
- ④ SET button.
- ⑤ ACT button.
- ⑥ ACT sync port.
- ⑦ ▼ Down button: Decrease parameter value.
- ⑧ ▲ Up button: Increase parameter value.
- ⑨ B antenna connector.
- ⑩ DC Input Jack: center pin positive.

Diversity Wireless Receivers

- 11 Balanced XLR Audio Output Jack.
- 12 Unbalanced 6.3 ϕ Phone Jack.
- 13 Unbalanced Output Level Switch.
- 14 Balanced & unbalanced output mixed switch.
- 15 Balanced Audio Output XLR connector.
- 16 Unbalanced Audio Output 6.3 ϕ Phone Jack.
- 17 A antenna connector.
- 18 19-inch 1U rackmount kit (optional).

Receiver Installation

1. Connect an antenna to each of the antenna connectors 9 17 on the rear panel. Fig. 2.

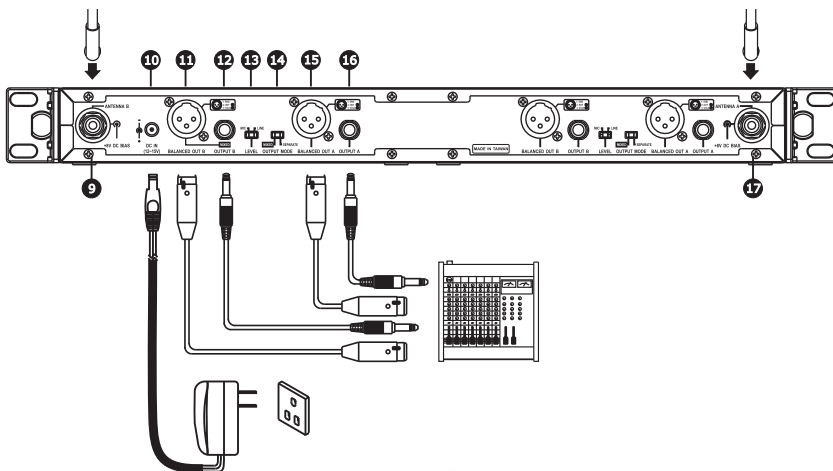

Fig. 2

2. Connect the power supply to the receiver DC input 10 and plug into an AC power source. Fig. 2.

3、 Audio Output Connection:

- (A) Connect the receiver audio output Jack ⑪ ⑮ to a mixer or amplifier MIC IN jack using a XLR cable. See Fig. 3 for 3-pin XLR connector wiring diagram.
- (B) Connect unbalanced phone jack ⑫ ⑯ to a mixer or amplifier LINE IN jack using a PHONE cable.
- (C) Switch the output mixed switch ⑭ to MIXED position, the multiple channel outputs are mixed and connect to the mixed output jacks ⑪ ⑫ .
- (D) Output for electric guitar/bass: Use a 6.3φ phone cable. One end to receiver's unbalanced output jack and the other end to guitar/bass amplifier's input jack. Switch the output level to "LINE" position.

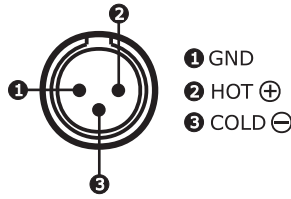

Fig. 3

- 4、 Antenna Connection: antenna connectors provide 8-volt DC bias to work with MIPRO antenna boosters. If the antenna cable is longer than 10 meters, it is advisable to install an antenna booster to ensure optimal reception.

Receiver Operation

- 1、 Prior to powering on the receiver, ensure all transmitters are turned off and the mixer's volume control is set to a minimized setting.
- 2、 RF meter level ⑳ glows when a transmitter is powered on. Once audio signal is received from the transmitter, the AF level meter displayed upon signal strength. System is abnormal and adjustment or repair maybe required if no sound or indicator does not glow.
- 3、 The microphone volume is adjusted at the amplifier or mixer. No need for volume adjustment at the receiver (ACT-311B/ACT-312B) .

Rackmount Installation for Receivers

1. Single half-rack receiver: Install the optional rack mount kit and fasten with screws on both sides Fig. 4.

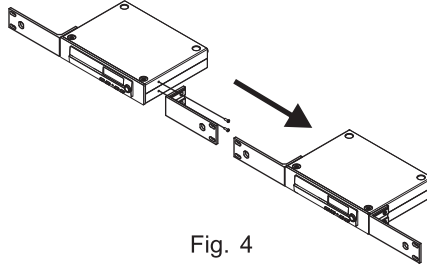

Fig. 4

2. Single 1-rack receiver: Install the optional rack mount kit and fasten with screws on both sides. Fig. 5.

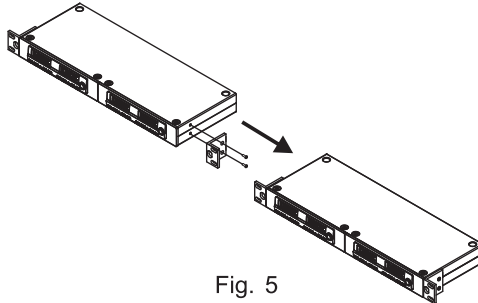

Fig. 5

3. Receiver Rack-Mount Kits. Fig. 6.

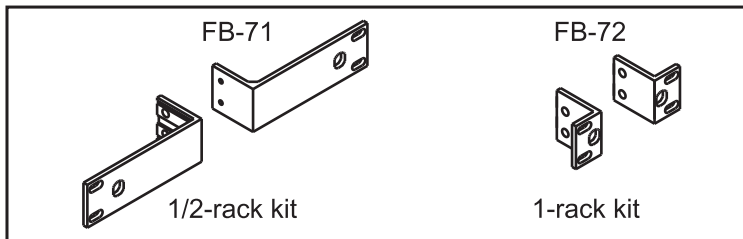

Fig. 6

- 4、 To be fitted on an EIA standard 19-inch rack case. Fig. 7.
- 5、 For ideal reception range, install the receiver at least 1 meter above the ground and away from EMI / RFI “noise” sources. In addition, place the transmitter at least 1 meter away from the receiving antenna, as shown. Fig. 8.

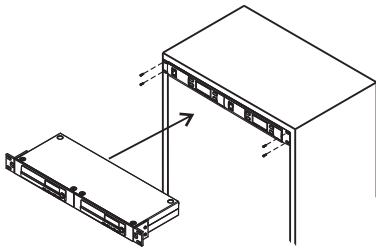

Fig. 7

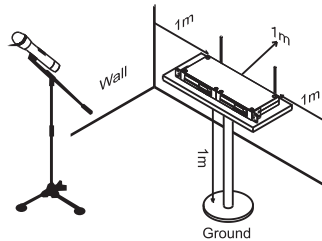

Fig. 8

Tips for Improving System Performance

- 1、 Proper install of antennas influences the operating efficiency of receiver. Most important rule is to minimize the distance between the receiving antenna and transmitter for best reception quality.
- 2、 Use MIPRO supplied antennas to ensure proper receiver sensitivity.
- 3、 Antenna connector provides 8V DC biased output. Short circuits should be avoided.
- 4、 Use Install MIPRO directional antennas and boosters if extended reception distance is required.
- 5、 Proper antenna distribution to reduce antenna clutter is vital to achieve ideal receiving efficiency from multiple wireless systems operating in the same venue.
- 6、 MIPRO's factory preset interference-free channels within the same group are recommended to ensure optimum performance from multiple wireless systems operating in the same venue.

LCD Screen

1、Displays all Parameters. Fig. 9



Fig. 9

- ①⑨ Antenna A/B reception indicator.
- ②⑩ GRP Group icon.
- ②① CH Channel icon.
- ②② FRQ Frequency icon.
- ②③ Lock mode icon, lights at locked.
- ②④ Interference warning icon, lights at interferenced.
- ②⑤ SQ Squelch Level: Indicate Sensitivity Level.
- ②⑥ Transmitter Battery Level, indicate current transmitter battery level.
- ②⑦ RF Signal Level, indicate RF signal strength from the transmitter.
- ②⑧ Audio Signal Level, indicate audio signal strength from transmitter.
- ②⑨ Channel & Frequency Display, displays Group/Channel & Frequency.

2、LCD Screen displays all Parameter Values. Fig. 10

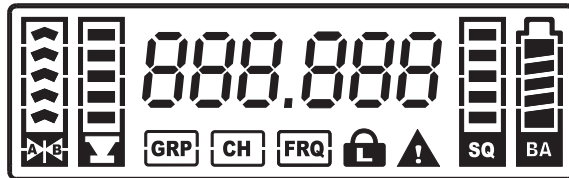

Fig. 10

3、Receiver Parameters : 4 receiver parameters can be programmed using the 'SET' button. Fig. 11



Fig. 11

4、Programmable Parameters

(A) GROUP Setting. Fig. 12

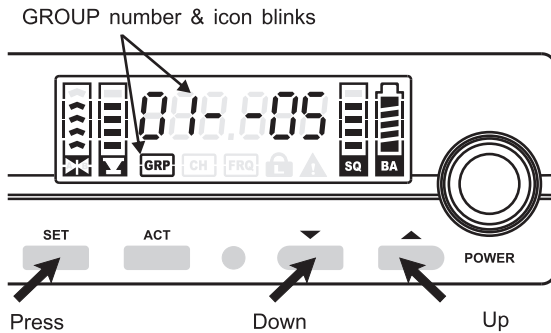

Fig. 12

- (1) Press and release the 'SET' 4 button until both GRP 20 cursor and a group number start to blink denoting it is ready to accept parameter change.
- (2) During blinking, press ▼ 7 or ▲ 8 button to one of the factory preset groups.

Diversity Wireless Receivers

(B) CHANNEL Setting. Fig. 13

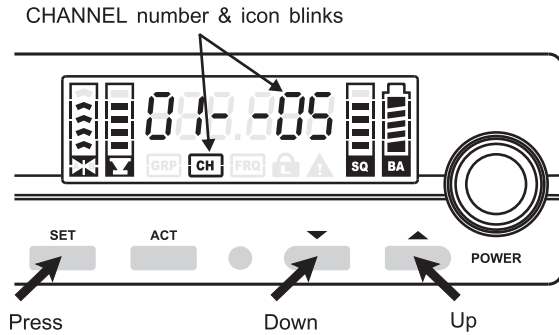

Fig. 13

- (1) Press and release the 'SET' **4** button until both CH **21** cursor and a group number start to blink denoting it is ready to accept parameter change.
- (2) During blinking, press **7** or **8** button to one of the factory preset groups.
- (3) Groups 1~6 and Group 11:
During blinking, press and hold **7** or **8** button to stop one of the 8 factory preset channels in any of these groups.
Groups 7~10:
During blinking, press and hold **7** or **8** button to stop one of the 16 factory preset channels in any of these group.

(C) FREQUENCY Setting. Fig. 14

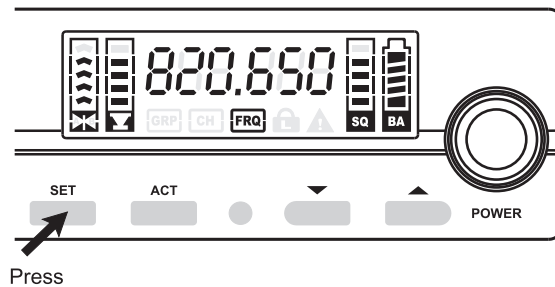

Fig. 14

GROUP 11 is user-defined and designated for frequency programmable only. Other Otherwise, frequencies are listed and corresponded to pre-set channels and cannot be programmed.

(D) FREQUENCY Setting. Fig. 15

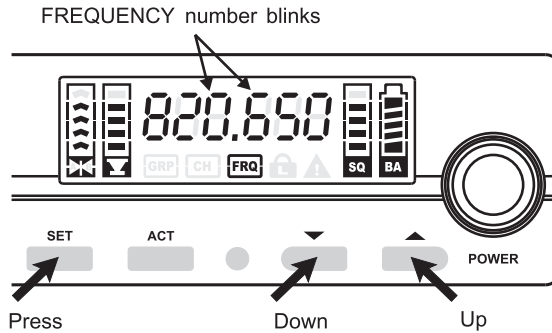

Fig. 15

- (1) Press SET until GRP cursor blinks. Select group 11.
- (2) Press SET again to desire channel.
- (3) Press SET to FRQ cursor. Press SET again. First 3 numbers blink denoting it is ready to accept parameter change
- (4) Press ▼ or ▲ button to move down or up by 1 MHz step.
- (5) Press SET button during blinking and last 3 numbers blink denoting it is ready to accept parameter change.
- (6) Press ▼ or ▲ button to move down or up by 25 kHz step.

Diversity Wireless Receivers

(E) SQUELCH Setting. Fig. 16

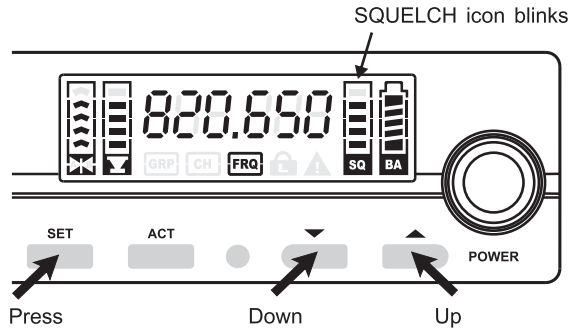

Fig. 16

- (1) Press and release the 'SET' button until SQ cursor starts to blink denoting it is ready to accept parameter change.
- (2) During blinking, press ▼ or ▲ button to increase or decrease one squelch level.
- (3) Decreased SQ level setting has higher sensitivity level resulting in longer reception range.

(F) LOCK Setting. Fig. 17 :

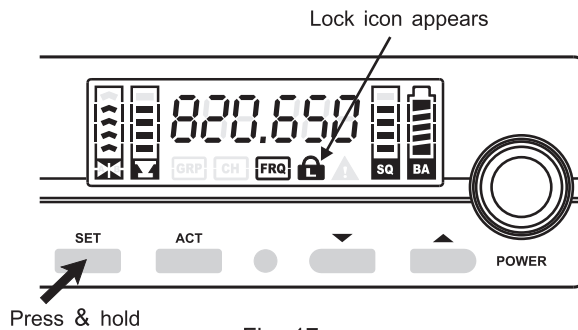

Fig. 17

- (1) The purpose of Lock function is to lock and prevent accidental changing of settings once programmed.
- (2) To Lock: Press and hold the 'SET' button until the Lock icon appears.
- (3) To Unlock: Press and hold the 'SET' button until the Lock icon disappears.

(G) ACT synchronization setting. Fig. 18

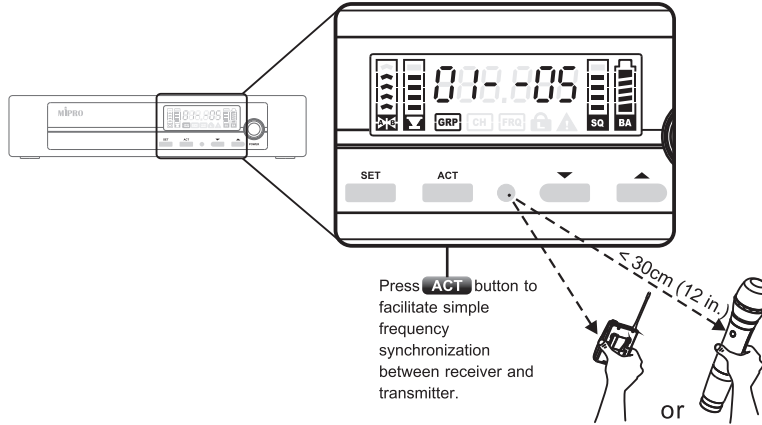

Fig. 18

- (1) Press ACT button. Word ACT blinks and synchronization process starts. ◦
- (2) Ensure transmitter is powered-on. During ACT blinking on the receiver LCD screen, bring a handheld or bodypack transmitter within 30cm (12") of the IR port on the receiver. The frequency will sync automatically. If sync is done successfully the word ACT stops blinking and GRP & RF meter are lit.
- (3) To cancel ACT synchronization in process, simply press ACT button again. GROUP or FREQUENCY stops blinking.

Diversity Wireless Receivers

5. BA: Transmitter Battery Level. The battery meter is lit when the transmitter is powered on. The battery meter gives a percentage (%) indication of remaining battery life, as shown. Replace with new, fresh batteries when battery indicators fall to 10% (1 indicator remaining). Fig. 19.

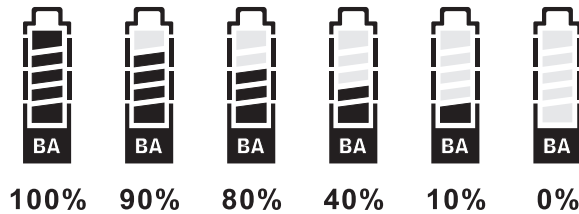

Fig. 19

6. Error Message: ERR01 indicates internal data error.
7. LCD Backlight Display Status:
 - (A) When backlight is fully lit denotes it received signals from transmitter or interference. Half-lit denotes standby status.
 - (B) To lock fully lit backlight, press and hold ▼ button. To cancel, press and hold ▲ button.
8. LCD screen is fully-lit when it is powered on. If setting a parameter is not programmed within 5 seconds, it leaves the setting status. If signals are not received from the transmitter within 10 seconds, it reverts to half-lit standby status. Press SET or ACT button reverts to a fully-lit operational status.

NOTE

1. Design and specifications are subject to change without prior notice. Refer to actual product in the event of product discrepancy.
2. Frequency range, output power, and maximum deviation to adhere to local telecom regulations.



MIPRO[®]
MICROPHONE PROFESSIONALS

All rights reserved. MN 017/11

Do not copy or forward without prior approvals MIPRO.

Specifications and design subject to change without notice.

MIPRO Electronics Co., Ltd

Headquarters : 814 Pei-Kang Road, Chiayi,60096,Taiwan

Tel : +886.5.238.0809

www.mipro.com.tw

Fax : +886.5.238.0803

mipro@mipro.com.tw



2CE610A