



# SLX-D

## Shure SLX-D Digital Wireless

Shure SLX-D Digital Wireless quick start guide.  
Version: 5.0 (2020-G)

# Table of Contents

<b>SLX-D Shure SLX-D Digital Wireless</b>	<b>3</b>	<b>Set Up the Receiver</b>	<b>8</b>
		Install Transmitter Batteries	9
<b>IMPORTANT SAFETY INSTRUCTIONS</b>	<b>3</b>	<b>What are Groups and Channels?</b>	<b>10</b>
<b>WARNING</b>	<b>4</b>	Using the Guided Frequency Setup	11
		Manual Frequency Selection	13
<b>Important Product Information</b>	<b>4</b>	<b>Sound Check and Gain Adjustment</b>	<b>13</b>
LICENSING INFORMATION	4	<b>More Information Available Online</b>	<b>13</b>
Australia Warning for Wireless	4	<b>Certifications</b>	<b>13</b>
<b>System Components</b>	<b>5</b>	Information to the user	13

# SLX-D

## Shure SLX-D Digital Wireless

### IMPORTANT SAFETY INSTRUCTIONS

1. READ these instructions.
2. KEEP these instructions.
3. HEED all warnings.
4. FOLLOW all instructions.
5. DO NOT use this apparatus near water.
6. CLEAN ONLY with dry cloth.
7. DO NOT block any ventilation openings. Allow sufficient distances for adequate ventilation and install in accordance with the manufacturer's instructions.
8. DO NOT install near any heat sources such as open flames, radiators, heat registers, stoves, or other apparatus (including amplifiers) that produce heat. Do not place any open flame sources on the product.
9. DO NOT defeat the safety purpose of the polarized or grounding type plug. A polarized plug has two blades with one wider than the other. A grounding type plug has two blades and a third grounding prong. The wider blade or the third prong are provided for your safety. If the provided plug does not fit into your outlet, consult an electrician for replacement of the obsolete outlet.
10. PROTECT the power cord from being walked on or pinched, particularly at plugs, convenience receptacles, and the point where they exit from the apparatus.
11. ONLY USE attachments/accessories specified by the manufacturer.
12. USE only with a cart, stand, tripod, bracket, or table specified by the manufacturer, or sold with the apparatus. When a cart is used, use caution when moving the cart/apparatus combination to avoid injury from tip-over.



13. UNPLUG this apparatus during lightning storms or when unused for long periods of time.
14. REFER all servicing to qualified service personnel. Servicing is required when the apparatus has been damaged in any way, such as power supply cord or plug is damaged, liquid has been spilled or objects have fallen into the apparatus, the apparatus has been exposed to rain or moisture, does not operate normally, or has been dropped.
15. DO NOT expose the apparatus to dripping and splashing. DO NOT put objects filled with liquids, such as vases, on the apparatus.
16. The MAINS plug or an appliance coupler shall remain readily operable.
17. The airborne noise of the Apparatus does not exceed 70dB (A).
18. Apparatus with CLASS I construction shall be connected to a MAINS socket outlet with a protective earthing connection.
19. To reduce the risk of fire or electric shock, do not expose this apparatus to rain or moisture.
20. Do not attempt to modify this product. Doing so could result in personal injury and/or product failure.
21. Operate this product within its specified operating temperature range.



This symbol indicates that dangerous voltage constituting a risk of electric shock is present within this unit.



This symbol indicates that there are important operating and maintenance instructions in the literature accompanying this unit.

## WARNING

- Battery packs may explode or release toxic materials. Risk of fire or burns. Do not open, crush, modify, disassemble, heat above 140°F (60°C), or incinerate.
- Follow instructions from manufacturer
- Only use Shure charger to recharge Shure rechargeable batteries
- **WARNING:** Danger of explosion if battery incorrectly replaced. Replace only with same or equivalent type.
- Never put batteries in mouth. If swallowed, contact your physician or local poison control center
- Do not short circuit; may cause burns or catch fire
- Do not charge or use battery packs other than Shure rechargeable batteries
- Dispose of battery packs properly. Check with local vendor for proper disposal of used battery packs.
- Batteries (battery pack or batteries installed) shall not be exposed to excessive heat such as sunshine, fire or the like
- Do not immerse the battery in liquid such as water, beverages, or other fluids.
- Do not attach or insert battery with polarity reversed.
- Keep away from small children.
- Do not use abnormal batteries.
- Pack the battery securely for transport.

## Important Product Information

### LICENSING INFORMATION

Licensing: A ministerial license to operate this equipment may be required in certain areas. Consult your national authority for possible requirements. Changes or modifications not expressly approved by Shure Incorporated could void your authority to operate the equipment. Licensing of Shure wireless microphone equipment is the user's responsibility, and licensability depends on the user's classification and application, and on the selected frequency. Shure strongly urges the user to contact the appropriate telecommunications authority concerning proper licensing, and before choosing and ordering frequencies.

低功率電波輻射性電機管理辦法

第十二條

經型式認證合格之低功率射頻電機，非經許可，公司、商號或使用者均不得擅自變更頻率、加大功率或變更原設計之特性及功能。第十四條

低功率射頻電機之使用不得影響飛航安全及干擾合法通信；經發現有干擾現象時，應立即停用，並改善至無干擾時方得繼續使用。前項合法通信，指依電信法規定作業之無線電通信。低功率射頻電機須忍受合法通信或工業、科學及醫療用電波輻射性電機設備之干擾。

## Australia Warning for Wireless

This device operates under an ACMA class licence and must comply with all the conditions of that licence including operating frequencies. Before 31 December 2014, this device will comply if it is operated in the 520-820 MHz frequency band.

**WARNING:** After 31 December 2014, in order to comply, this device must not be operated in the 694-820 MHz band.

## Canada Warning for Wireless

This device operates on a no-protection, no-interference basis. Should the user seek to obtain protection from other radio services operating in the same TV bands, a radio licence is required. For further details, consult Innovation, Science and Economic Development Canada's document Client Procedures Circular CPC-2-1-28, Voluntary Licensing of Licence-Exempt Low-Power Radio Apparatus in the TV Bands.

Ce dispositif fonctionne selon un régime de non-brouillage et de non-protection. Si l'utilisateur devait chercher à obtenir une certaine protection contre d'autres services radio fonctionnant dans les mêmes bandes de télévision, une licence radio serait requise. Pour en savoir plus, veuillez consulter la Circulaire des procédures concernant les clients CPC-2.1.28, Délivrance de licences sur une base volontaire pour les appareils radio de faible puissance exempts de licence et exploités dans les bandes de télévision d'Innovation, Sciences et Développement économique Canada.

(一) 符合“低功率频段无线电发射设备目录和技术要求”的具体条款和使用场景，所用的无线类型和功能、控制、调整及开关等使用方法；  
 (二) 不得擅自改变使用场景或使用条件、扩大发射功率位置、加大发射功率（包括额外加载射频功率放大器），不得擅自更改发射天线；  
 (三) 不得对其他合法的无线电台（站）产生有害干扰，也不得提出免受有害干扰保护；  
 (四) 应当承受辐射剂量超量的工业、科学及医疗（ISM）应用设备的干扰其他合法的无线电台（站）干扰；  
 (五) 如对其他合法的无线电台（站）产生有害干扰时，应立即停止使用，并采取措施消除干扰后方可继续使用；

เครื่องโพรคมนาควมและอุปกรณ์นี้มีความสอดคล้องตามมาตรฐานหรือข้อกำหนดทางเทคนิคของ กสทช.

## System Components

### All systems include:

- ①  
Rack mounting hardware
- ②  
1/4-wave antennas (2)
- ③  
Power supply
- ④  
1.5V AA batteries (2)
- ⑤  
SLXD4 or SLXD4D receiver

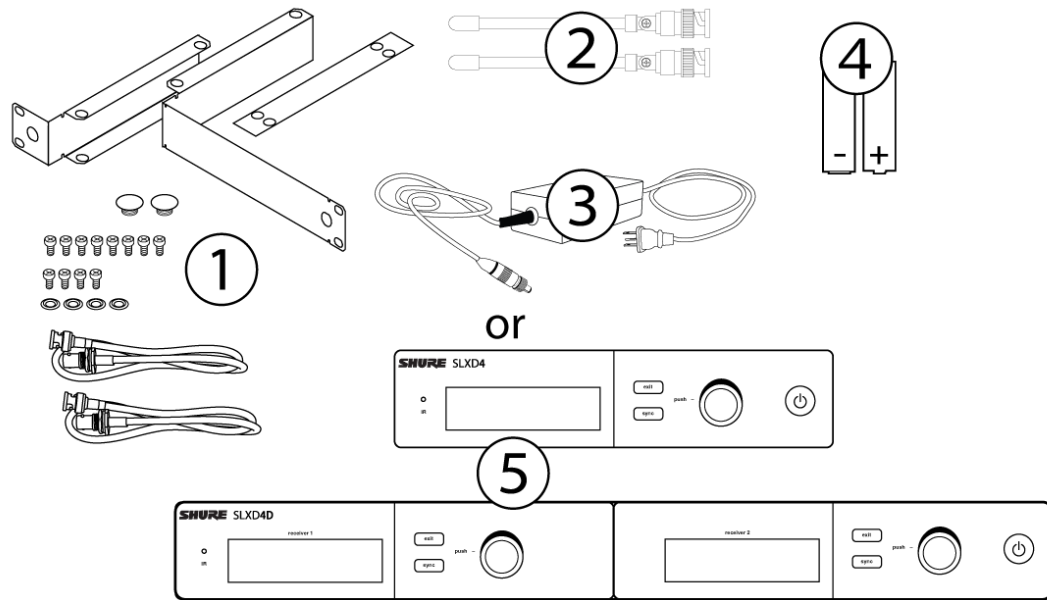

**Guitar system includes:**

- ⑥ 1/4" to mini 4-pin guitar cable
- ⑦ SLXD1 bodypack transmitter

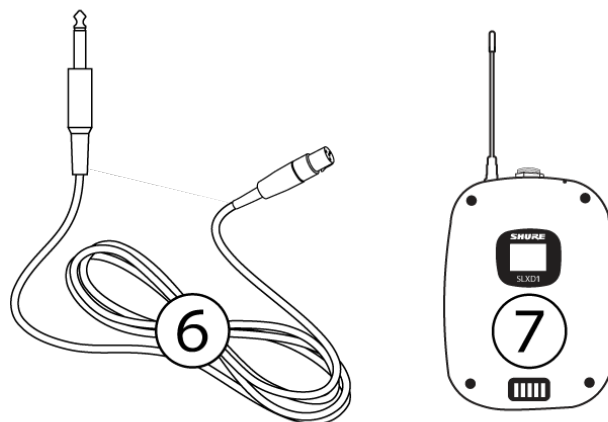

**Vocal system includes:**

- ⑧

## Microphone clip

⑨

SLXD2 handheld transmitter with microphone cartridge (choice of SM58<sup>®</sup>, SM86, Beta 58A<sup>®</sup>, Beta 87A<sup>™</sup>, Beta 87C<sup>™</sup>, or KSM8/B\*)

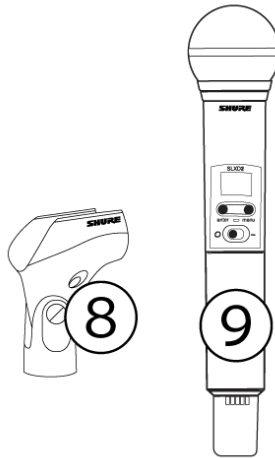

\*KSM8/B availability depends on region.

**Lavalier, Headworn, and Instrument systems include bodypack transmitter (⑦) and one of the following:**

⑩

WL183/WL185 lavalier microphone

⑪

WL93 miniature lavalier microphone

⑫

SM35 headset microphone

⑬

Beta 98H/C<sup>™</sup> instrument microphone

⑭

MX153 earset headworn microphone

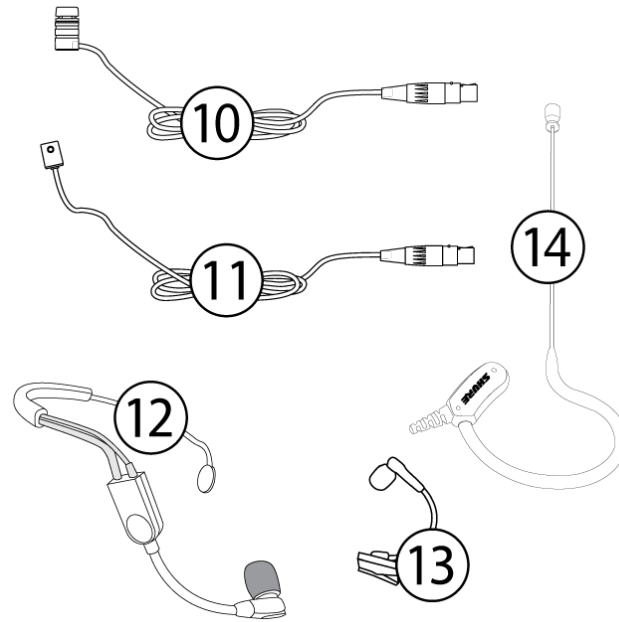
**Combo system includes:**

⑦

SLXD1 bodypack transmitter

⑨

Handheld transmitter with SM58 microphone head

⑪

WL185 lavalier microphone

---

## Set Up the Receiver

1. Attach the included antennas to the back of the receiver.

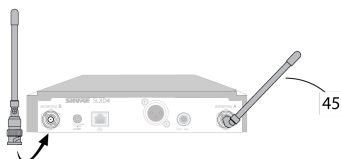

2. Connect the power supply to the receiver and plug the cord into an AC power source.



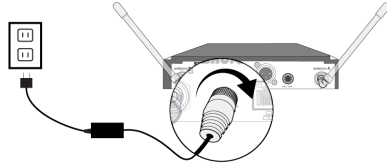

3. Connect the audio output to an amplifier or mixer.

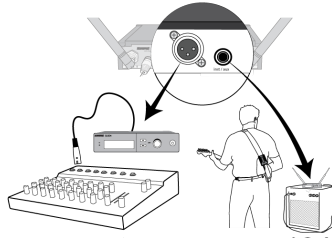

4. Press the power button on the receiver. Use the menu to set the system to microphone (mic) or instrument (line) level as appropriate.

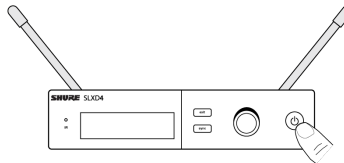

## Install Transmitter Batteries

**Important:** To avoid damaging transmitters, only use Shure SB903 Li-ion rechargeable batteries or 1.5V AA batteries.

### Bodypack:

1. Push the tab up and open the battery door to access the battery compartment.
2. Place a Shure SB903 Li-ion rechargeable battery or 2 AA batteries in the compartment.
3. Close the battery door.

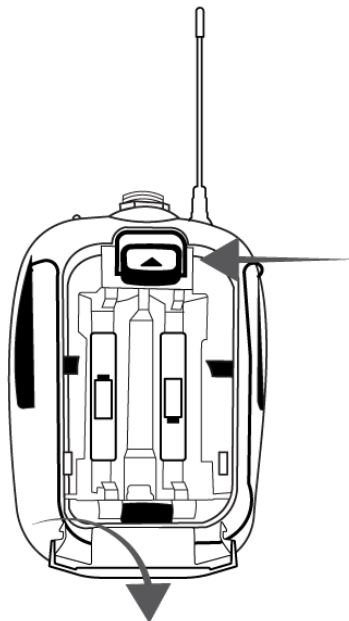
**Handheld:**

1. Remove the battery cover to access the battery compartment.
2. Lift the battery door to open the battery compartment.
3. Place a Shure SB903 Li-ion rechargeable battery or 2 AA batteries in the compartment.
4. Replace the battery cover.

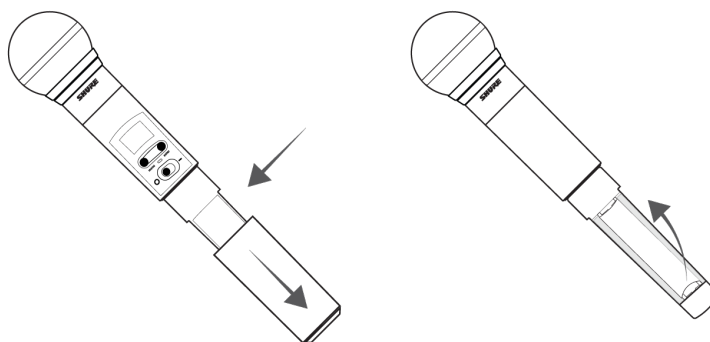

---

## What are Groups and Channels?

To minimize interference, Shure wireless systems organize RF bands into predefined **groups** and **channels**. A group is a set of compatible frequencies within a frequency band. A single frequency within a group is a channel. Tune a receiver and transmitter to the best available channel within its group to set up your system.

**Note:** Because groups are band-dependent, some systems don't have multiple groups. Single-group bands have the same RF performance as those with multiple groups.

All receivers in the same band should be set to the same group. You can set them manually, or use the Guided Frequency Set-up to walk you through the process.

Connect all the receivers in your system using Ethernet cables. For best results, use a network switch when connecting 3 or more receiver units.

**Important!** To avoid interference, before you begin:

**Turn off** all transmitters for the systems you are setting up. This prevents them from interfering with the frequency scan.

**Turn on** the following devices so they are operating as they would be during the presentation or performance. This will allow the scan to detect and avoid any interference from these devices:

- Configured wireless systems or devices
- Computers
- Large LED panels
- Effects processors
- CD players

## Using the Guided Frequency Setup

Set up a new system:

1. Push the control knob on the receiver and select 1. Frequency Setup > 1.1 Guided Frequency Setup.
2. Select Initialize My System and push the control knob to continue.
3. Turn off all transmitters you plan to use with your system.
4. Select start scan.
5. After the scan is done, push the control knob to assign frequencies to the receiver.
6. Turn on the transmitter you plan to use with this receiver.

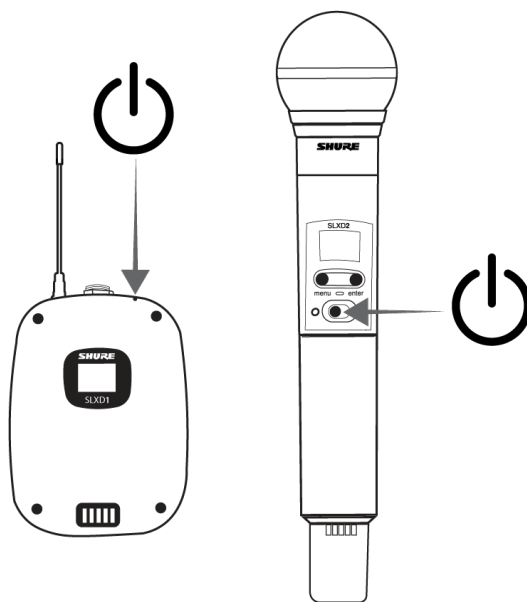

7. Align the infrared (IR) ports on the transmitter and receiver, and push the sync button.

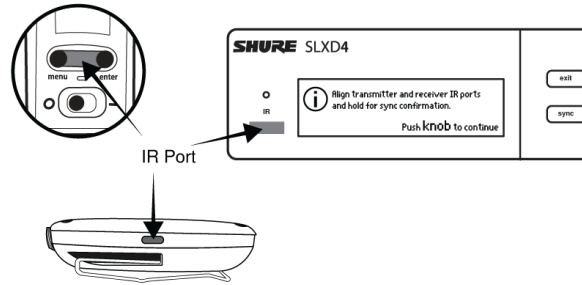

8. Once the sync is complete, the system is ready for use.

Add a new receiver to your system:

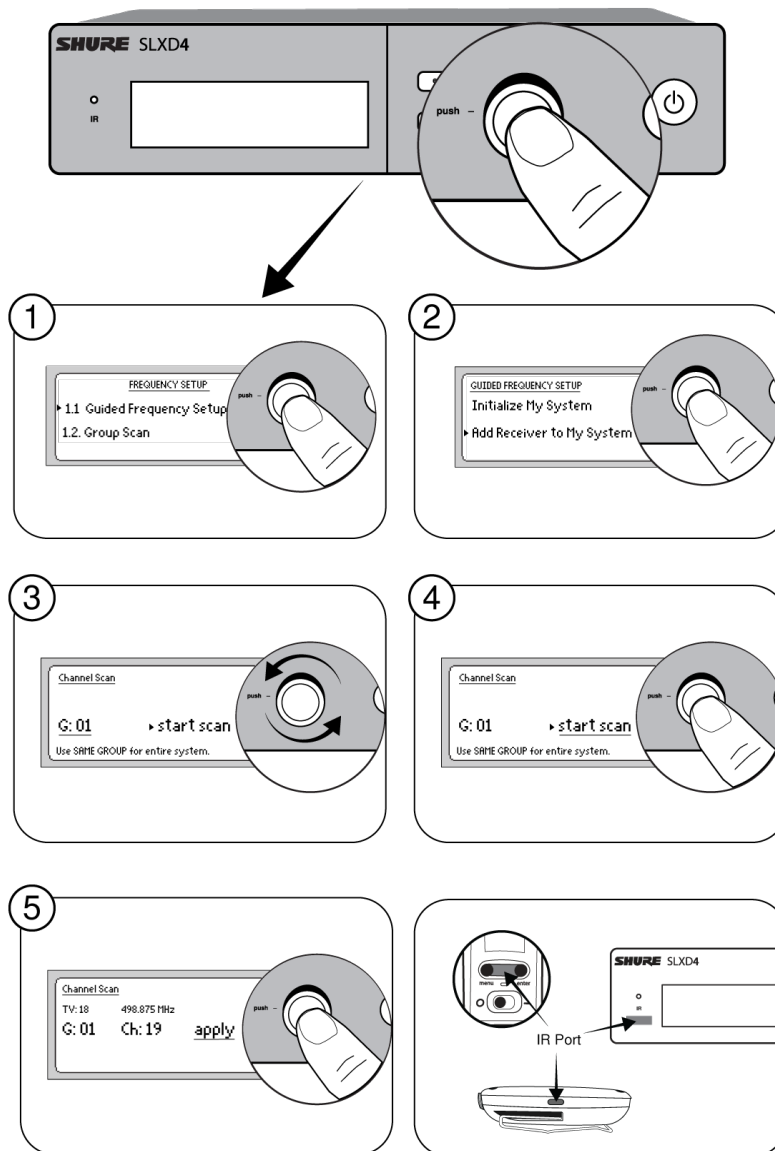

1. Push the control knob and select 1. Frequency Setup > 1.1 Guided Frequency Setup.

2. Select Add Receiver to My System.
3. To change the group, rotate the control knob to select G:, push to select, rotate to change the number, push again to confirm.
4. Select start scan.
5. After the scan completes, push the control knob to apply the receiver channel.
6. Turn on the transmitter you plan to use with this receiver.
7. Align the infrared (IR) port on the transmitter with that on the receiver, and push the sync button.
8. Once the sync is complete, the system is ready for use.

## Manual Frequency Selection

To manually adjust group, channel or frequency:

1. Select 1. Frequency Setup > 1.4 Manual Frequency Setup from the receiver menu.
2. Use the control knob to select and adjust the group (G), channel (C), or frequency (MHz).
3. Select apply and push the control knob to save.

## Sound Check and Gain Adjustment

Navigate to the receiver's Gain screen to test the transmitter at performance levels. Adjust the gain to keep the audio indicator within the optimal range. Reduce the gain if there is audible distortion of the audio.

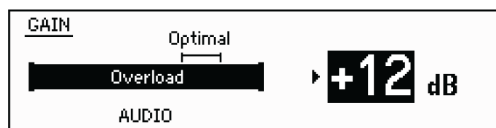

## More Information Available Online

A comprehensive online user guide is available at [pubs.shure.com](https://pubs.shure.com).

## Certifications

### Information to the user

This device complies with part 15 of the FCC Rules. Operation is subject to the following two conditions:

1. This device may not cause harmful interference.
2. This device must accept any interference received, including interference that may cause undesired operation.

**Note:** This equipment has been tested and found to comply with the limits for a Class B digital device, pursuant to part 15 of the FCC Rules. These limits are designed to provide reasonable protection against harmful interference in a residential installa-

tion. This equipment generates uses and can radiate radio frequency energy and, if not installed and used in accordance with the instructions, may cause harmful interference to radio communications. However, there is no guarantee that interference will not occur in a particular installation. If this equipment does cause harmful interference to radio or television reception, which can be determined by turning the equipment off and on, the user is encouraged to try to correct the interference by one or more of the following measures:

- Reorient or relocate the receiving antenna.
- Increase the separation between the equipment and the receiver.
- Connect the equipment to an outlet on a circuit different from that to which the receiver is connected.
- Consult the dealer or an experienced radio/TV technician for help.

This device operates on frequencies shared with other devices. Consult the Federal Communications Commission White Space Database Administration website to determine available channels in your area prior to operation.

This device contains licence-exempt transmitter(s)/receiver(s) that comply with Innovation, Science and Economic Development Canada's licence-exempt RSS(s). Operation is subject to the following two conditions:

1. This device may not cause interference.
2. This device must accept any interference, including interference that may cause undesired operation of the device.

L'émetteur/récepteur exempt de licence contenu dans le présent appareil est conforme aux CNR d'Innovation, Sciences et Développement économique Canada applicables aux appareils radio exempts de licence. L'exploitation est autorisée aux deux conditions suivantes :

1. L'appareil ne doit pas produire de brouillage;
2. L'appareil doit accepter tout brouillage radioélectrique subi, même si le brouillage est susceptible d'en compromettre le fonctionnement.

These transmitters have been tested and found to comply with international radiation exposure limits set forth for an uncontrolled environment. This equipment is in direct contact with the body of the user under normal operating conditions. These transmitters must not be co-located or operating in conjunction with any other antenna or transmitter.

Certified under FCC Part 15 and FCC Part 74.

Certified by ISED in Canada under RSS-102 and RSS-210.

CAN ICES-3 (B)/NMB-3 (B)

Approved under the Declaration of Conformity (DoC) provision of FCC Part 15.

**FCC ID:** DD4SLXD1G58, DD4SLXD1H55, DD4SLXD1J52, DD4SLXD2G58, DD4SLXD2H55, DD4SLXD2J52. **IC:** 616A-SLXD1G58, 616A-SLXD1H55, 616A-SLXD1J52, 616A-SLXD2G58, 616A-SLXD2H55, 616A-SLXD2J52 .

Meets essential requirements of the following European Directives:

- WEEE Directive 2012/19/EU, as amended by 2008/34/EC
- RoHS Directive EU 2015/863

*Note: Please follow your regional recycling scheme for batteries and electronic waste*

This product meets the Essential Requirements of all relevant European directives and is eligible for CE marking.

Hereby, Shure Incorporated declares that the radio equipment is in compliance with Directive 2014/53/EU. The full text of the EU declaration of conformity is available at the following internet address: <http://www.shure.com/europe/compliance>

Authorized European representative:

Shure Europe GmbH

Headquarters Europe, Middle East & Africa

Department: EMEA Approval

Jakob-Dieffenbacher-Str. 12

75031 Eppingen, Germany

Phone: +49-7262-92 49 0

Fax: +49-7262-92 49 11 4  
Email: [EMEAsupport@shure.de](mailto:EMEAsupport@shure.de)