

Canon EF LENS

EF400mm f/2.8L IS III USM



IMAGE STABILIZER
 ULTRASONIC

ENG
Instructions

Thank you for purchasing a Canon product.

Canon's EF400mm f/2.8L IS III USM is an Image Stabilizer-equipped super-telephoto lens for use with EOS cameras.

- "IS" stands for Image Stabilizer.
- "USM" stands for Ultrasonic Motor.

Camera Firmware

Please use the latest version of firmware with the camera in use. For details on whether the firmware is the latest version or not, and for details on updating the firmware, please check the Canon website.

Conventions used in these instructions



Warning to prevent lens or camera malfunction or damage.



Supplementary notes on using the lens and taking pictures.

Safety Precautions

Precautions to ensure that the camera is used safely. Read these precautions thoroughly. Make sure all details are observed in order to prevent risks and injury to the user and other people.

 **Warning** Details pertaining to risks that may result in death or serious injury.

- **Do not look directly at the sun or other strong light sources through a lens or a single-lens reflex camera with a lens attached.** This may result in loss of sight.
- **Do not leave a lens in the sun without the lens cap attached.** The lens may concentrate entering sunlight and cause a malfunction or fire.
- **Do not point a lens at the sun.** Even when the sun does not appear on the screen, the lens may concentrate entering sunlight and cause a malfunction or fire.
- **Where the lens is mounted on a camera, make sure to properly support the lens.** If you hold only the camera, the lens may fall off the camera and cause a malfunction or injury.
- **Be sure to attach the included strap to the lens when carrying a camera around with the lens mounted on it.** Using the strap for the camera may allow the lens to fall off the camera and cause a malfunction or injury.

 **Caution** Details pertaining to risks that may result in injury.

- **Do not leave the product in places exposed to extremely high or low temperatures.** The product may cause burns or injury when touched.
- **Only mount the product on a tripod that is sufficiently sturdy.**

Caution Details pertaining to risks that may result in damage to property.

- Do not leave the product in excessive heat such as in a car in direct sunlight. High temperatures can cause the product to malfunction.

This device complies with Part 15 of the FCC Rules.

Operation is subject to the following two conditions: (1) This device may not cause harmful interference, and (2) this device must accept any interference received, including interference that may cause undesired operation.

Do not make any changes or modifications to the equipment unless otherwise specified in the instructions. If such changes or modifications should be made, you could be required to stop operation of the equipment.

This equipment has been tested and found to comply with the limits for a class B digital device, pursuant to part 15 of the FCC Rules. These limits are designed to provide reasonable protection against harmful interference in a residential installation. This equipment generates, uses and can radiate radio frequency energy and, if not installed and used in accordance with the instructions, may cause harmful interference to radio communications.

However, there is no guarantee that interference will not occur in a particular installation. If this equipment does cause harmful interference to radio or television reception, which can be determined by turning the equipment off and on, the user is encouraged to try to correct the interference by one or more of the following measures:

- Reorient or relocate the receiving antenna.
- Increase the separation between the equipment and receiver.
- Connect the equipment into an outlet on a circuit different from that to which the receiver is connected.
- Consult the dealer or an experienced radio/TV technician for help.

General Precautions

Handling Precautions

- If the lens is taken from a cold environment into a warm one, condensation may develop on the lens surface and internal parts. To prevent condensation in this case, first put the lens into an airtight plastic bag before taking it from a cold to warm environment. Then take out the lens after it has warmed gradually. Do the same when taking the lens from a warm environment into a cold one.
- Please also read any lens related handling precautions listed in your camera's instruction manual.

Shooting Precautions

- The lens' focusing ring is electronic.
The lens will not focus when the focusing ring is turned while the camera is turned off.

Nomenclature

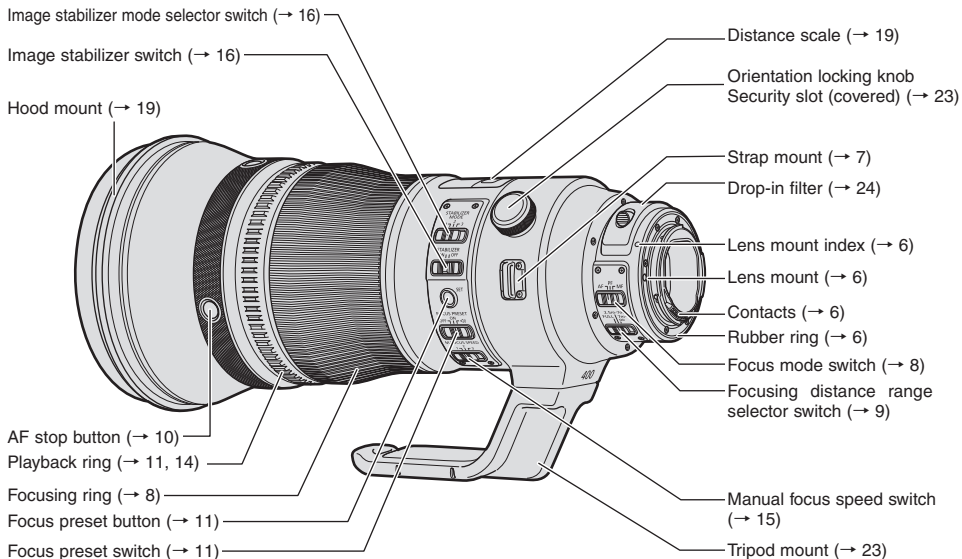

● For detailed information, reference page numbers are provided in parentheses (→ **).

1. Attaching and Detaching the Lens

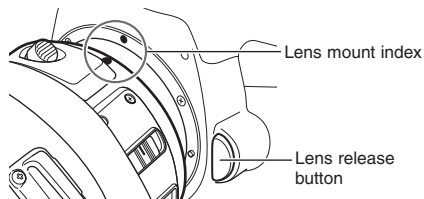

Attaching the Lens

Align the lens mount indexes of the lens and camera, and turn the lens clockwise until you hear a click.

Detaching the Lens

Turn the lens counterclockwise while pressing the camera's lens release button. Detach the lens once it has stopped turning.

Please refer to the camera's instructions for details.



- Set the camera's power switch to OFF when attaching or detaching the lens.
- After detaching the lens, place the lens with the rear end up and attach the dust cap to prevent the lens surface and contacts from getting scratched. Make sure the lens and dust cap mount indexes are aligned when attaching the dust cap.
- Contacts that are scratched, soiled, or have fingerprints on them may result in faulty connections or corrosion, which may lead to malfunctions. If the contacts get soiled, clean them with a soft cloth.
- The lens mount has a rubber ring to improve dust-resistance and water-resistance performance. This rubber ring may cause friction marks to appear around the camera's lens mount, although this will have no effect on usage.



- Since the lens is heavier than the camera, turn the camera when attaching or detaching the lens. Ensuring that the lens can rest safely on its own is recommended, such as first mounting it on a tripod.
- Rubber rings can be replaced at a Canon Service Center at cost.

2. Attaching the Strap

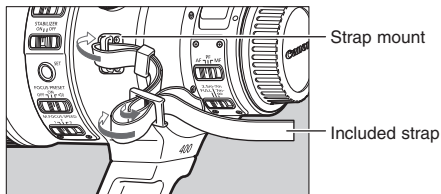

Thread the end of the strap through the strap mount on the lens and then back through the clasp on the strap. Pull the strap tight and check that there is no slack in the clasp.

- Before using the lens, check that the strap is attached securely, that it is not worn (damaged), etc.

3. Setting the Focus Mode

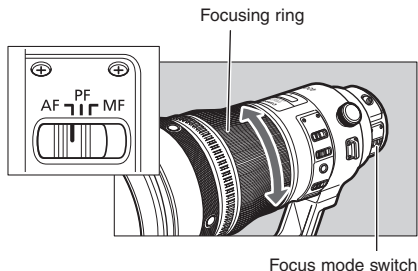

- Quickly turning the focusing ring may result in delayed focus.

- The lens' focusing ring is electronic.
- When AF operation is set to [ONE SHOT], manual focus is possible after autofocus has been completed by continuing to press the shutter button halfway (Full-time manual focus). There are times when camera setting changes are required.
- When the AF button assignment is changed from the “shutter button” (using the camera’s Custom Function), manual focus is always possible regardless if the shutter button is pressed halfway any time the lens is not autofocusing.

To shoot in autofocus (AF) mode, set the focus mode switch to AF.

To use only manual focusing (MF), set the focus mode switch to MF, and focus by turning the focusing ring.

See p. 14 for information on power focus (PF).

4. Setting the Focusing Distance Range

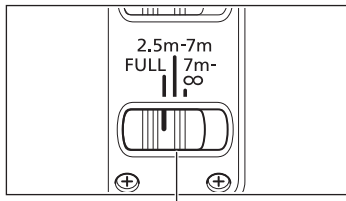

Focusing distance range selector switch

You can set the focusing distance range with a switch. By setting a suitable focusing distance range, the actual autofocus time will be shorter.

Focusing distance range

- ① FULL (2.5 m – ∞)
- ② 2.5 m – 7 m
- ③ 7 m – ∞

5. AF Stop Buttons

You can use the AF stop buttons to temporarily pause autofocus.

AF stop buttons

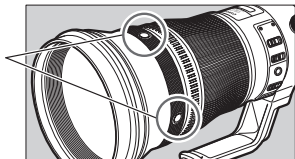

During autofocus operation, you can press an AF stop button to temporarily pause autofocus, and then release the button to resume. Press an AF stop button to maintain a focusing distance or to avoid focus search. Press the shutter button while holding down an AF stop button to shoot at that focusing distance.

- Autofocus will not resume even after you let go of an AF stop button in the following instances.
 - Camera: EOS 630, EOS RT, EOS 5, EOS 10
In continuous shooting mode with [AI SERVO]
 - Camera: EOS 5, EOS 10
In sports mode
- Useful when autofocus is operating mostly in [AI SERVO].
- You can change the function of the AF stop buttons depending on the camera. Please refer to the camera's instructions for details.
- Angle positioning of the AF stop buttons is adjustable by a Canon Service Center at cost.

6. Focus Preset

By using focus presets, you can turn the playback ring to focus the lens at any preset focusing distance. To use focus presets, set the focus preset switch to ON or .

If set to , the lens beeps when being preset and when moving.

Operation differs to set one preset or two presets.

One Preset

Set one focusing distance.

< Preset the Focusing Distance >

- 1 Focus the lens at a focusing distance you want to preset.
- 2 Press the focus preset button to preset the distance in memory.

< Shoot at the Preset Focusing Distance >

Turn the playback ring left or right to move the focus to the preset distance.

Press the shutter button while the playback ring is turned to shoot at that distance.

Beep Sounds (Beeper)

- One beep: When presetting a focusing distance
- Two beeps: When the focus moves to the preset focusing distance

Focus preset button

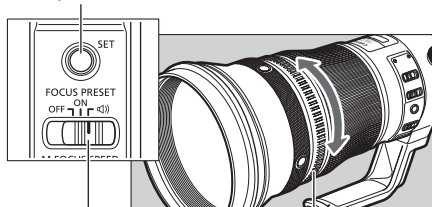

Focus preset switch

Playback ring

Two Presets

Hold down the focus preset button to preset two focusing distances.

< Preset the Focusing Distance >

- 1 Focus the lens at a focusing distance you want to preset.
- 2 Hold down the focus preset button (at least 1 second), and then immediately turn the playback ring left or right to preset the distance in memory for that direction.
- 3 Use the same steps to preset another distance.

< Shoot at the Preset Focusing Distances >

Turn the playback ring left or right to move the focus to each of the preset distances.
Press the shutter button while the playback ring is turned to shoot at that distance.

Beep Sounds (Beeper)

- Two beeps (slow): When button held down
- One beep: When presetting a focusing distance
- Two beeps (fast): When the focus moves to the preset focusing distance

Focus preset button

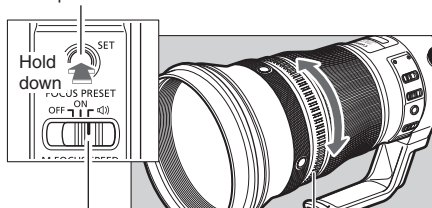

Focus preset switch

Playback ring

Focus Preset

- When setting two presets, pressing the focus preset button but then not turning the playback ring causes the lens to beep three times and cancel presetting. Set presets from the start again.
 - The camera may turn off while setting two presets. Press the shutter button halfway, and then set presets from the start again.
 - When not using focus presets, set the focus preset switch to OFF.
 - With the following camera models, focus presets cannot be used with Live View shooting or movie shooting.
EOS 60Da, EOS REBEL T5/1200D, EOS REBEL T6/1300D, EOS REBEL T7/2000D/1500D, EOS REBEL T100/4000D/3000D
As well as all EOS cameras released in 2011 and earlier
-
- Focus presets can be used in all focus modes. Focus speed is slow only during movie shooting when the focus mode is PF, and is fast for all other settings. In slow speed, you can make a 2-step change in focus speed depending on how much the playback ring is turned.
 - All focus presets are initially at the lens' mechanical limit in the infinity direction (not at infinity) when the lens is mounted on a camera.
 - Preset focusing distances remain in memory until the lens is detached from the camera.

7. Power Focus (PF)

By using power focus, you can turn the playback ring to change the focus smoothly. This is a useful feature for changing focus when shooting movies.

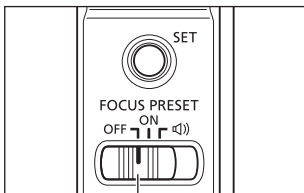

Focus preset switch

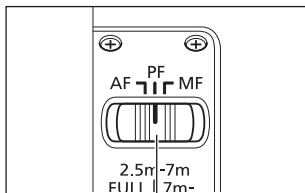

Focus mode switch

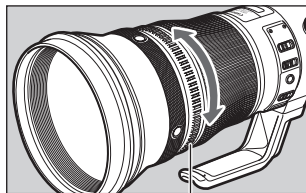

Playback ring

- 1 Set the focus preset switch to OFF, and the focus mode switch to PF.
 - 2 Turn the playback ring manually to change the focus.
- You can make a 2-step change in power focus speed, depending on how much the playback ring is turned.

8. Manual Focus (MF)

When shooting images using manual focus (MF), you can select the manual focus speed.



Use the manual focus speed switch to select a manual focus speed. Speed is fastest at 1, with 2 and 3 being progressively slower.

9. Image Stabilizer

Image stabilization corrects vibrations that occurs with hand-held shots.

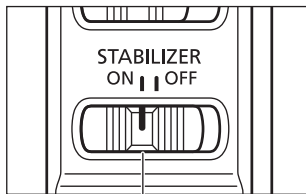

Image stabilizer switch

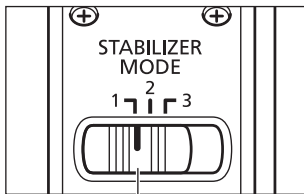
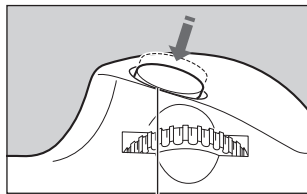

Image stabilizer mode selector switch



Camera shutter button

- 1** Set the STABILIZER switch to ON.
 - If you are not going to use image stabilization, set the image stabilizer switch to OFF.
- 2** Select an Image Stabilizer mode according to the application and shooting conditions.
- 3** Press the shutter button down halfway. Once you have a stable image, press down all the way to take the picture.*
 - * Only MODE 3 does not allow you to check the effect gained from stabilization.

Image Stabilizer modes

- MODE 1: Corrects vibrations in all directions. It is suited to shooting still subjects.
- MODE 2: When you take a panning shot either horizontally or vertically, corrects vibrations at right angles to the direction of panning. It is suited to shooting moving subjects.
- MODE 3: During exposure, corrects vibrations in the same way as MODE 2. Since vibration is corrected only during exposure, It is suited to shooting irregularly moving subjects.

10. Tips on Using Image Stabilization

The Image Stabilizer for this lens is suited to hand-held shots in the following conditions.

MODE 1

Shooting still subjects



- In semi-darkened areas such as indoors or outdoors at night.
- In locations where a flash cannot be used, such as art museums and theater stages.
- In situations where your footing is uncertain.
- In situations where fast shutter speed settings cannot be used.

MODE 2

Shooting moving subjects



- Panning shots of vehicles, trains, etc.

MODE 3

Shooting irregularly moving subjects



- Sports photography of soccer, basketball, etc.
- Photography of animals

Tips on Using Image Stabilization



- The Image Stabilizer cannot compensate for a blurred shot caused by a subject that moved.
- The Image Stabilizer might not be fully effective in the following conditions:
 - Large shake or fast vibration
 - Panning in MODE 1
- Setting the STABILIZER switch to ON consumes more power than when OFF.
- The Image Stabilizer operates for about two seconds even when your finger is off the shutter button. Do not detach the lens while the stabilizer is in operation. Detaching the lens at this time will cause a malfunction.
- Although image stabilization will operate when using a tripod, depending on the kind of tripod and shooting conditions, sometimes it may be better to turn off the Image Stabilizer.
- Although image stabilization will operate when using a monopod, depending on the shooting conditions, sometimes the Image Stabilizer might not be fully effective.
- Setting the STABILIZER switch to OFF is recommended when you are taking pictures using the Bulb setting (long exposures). If the STABILIZER switch is set to ON, the Image Stabilizer may introduce errors.
- With the EOS-1V/HS, 3, ELAN 7E/ELAN 7/30/33, ELAN 7NE/ELAN 7N/30V/33V, ELAN II/ELAN II E/50/50E, REBEL 2000/300, IX, IX Lite/IX7, and D30, the Image Stabilizer will not work during self-timer operation.



- Depending on the camera there may be image shake, such as after releasing the shutter. However, this does not affect shooting.
- If you set the camera's Custom Function to change the AF button assignment, the Image Stabilizer will operate when you press the newly assigned AF button.

11. Infinity Compensation Mark

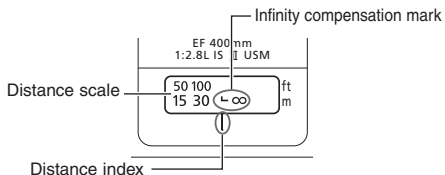

To compensate for shifting of the infinity focus point that results from changes in temperature, there is a margin at the infinity (∞) position. The infinity position at normal temperature is the point at which the vertical line of the distance scale L mark is aligned with the distance index.

- For accurate focusing in MF on subjects at infinity distance, look through the viewfinder or at an enlarged image on the LCD monitor* while turning the focusing ring.

* On cameras capable of Live View shooting

12. Hood

The custom lens hood cuts out unwanted light and protects the front of the lens from rain, snow, and dust.

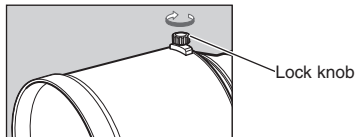

Attaching the Hood

Loosen the hood lock knob by turning it counterclockwise. Fit the hood onto the lens's hood mount, and tighten the lock knob to fix it in place securely.

To stow the lens, reverse the lens hood and slip it over the lens.

13. Lens Cap

The dedicated lens cap protects the front of the lens from shock and dust when the lens is stowed or not in use.

This lens cap can also be attached to the hood as well as the lens.

Attaching the Lens Cap to the Lens

Attach the lens cap by slipping it directly over the end of the lens (hood mount) as shown. Draw the strings to affix the lens cap and prevent it from coming off easily.

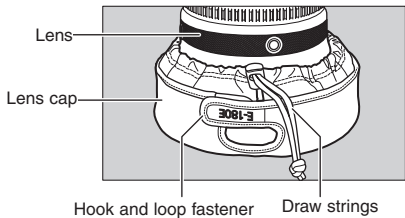

Attaching the Lens Cap to a Hood

Attach the lens cap by slipping it over the end of the hood as shown. Use the hook and loop fastener and the strings to affix the lens cap and prevent it from coming off easily.

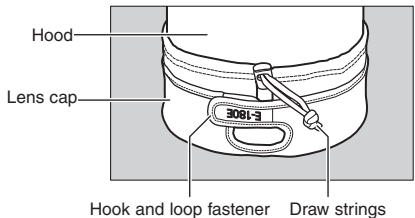

Lens Cap

Stowing the Lens

Reverse the lens hood and slip it over the lens. Tighten the hood lock knob to fix the hood in place securely with the lock knob in a line with the tripod mount.

Attach the lens cap by slipping it on where the hood lock knob is located as shown*. Use the hook and loop fastener and the strings to affix the lens cap and prevent it from coming off easily.

* Fasten the hook and loop fastener around the lock knob.

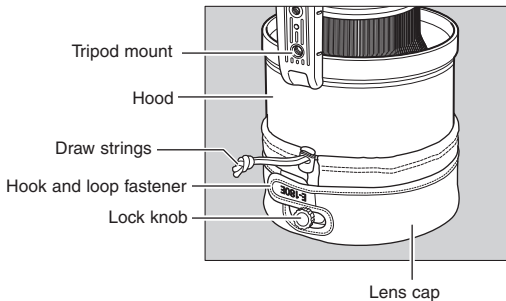

14. Case

Use the case to carry the lens.

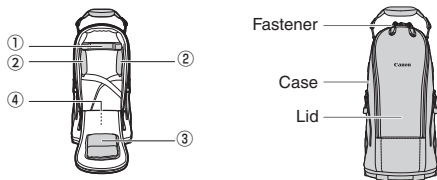

Attach all cushions inside the case as shown.

- ① Cushion (U-shaped)*¹ ×1
- ② Cushion (square, small) ×2
- ③ Cushion (square, large) ×1
- ④ Cushion (round)*² ×1

*¹ Attach ① where it holds the drop-in filter area of the lens.

*² ④ is attached to the bottom of the case.

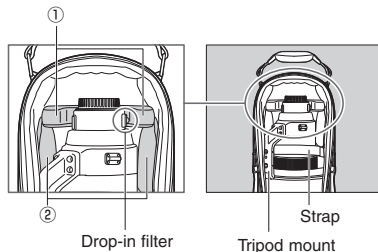

Proper Way to Stow the Lens

- 1 Attach the dust cap on the lens.
- 2 Reverse the lens hood, slip it over the lens, and then attach the lens cap. See p. 21 for information on attaching items.
- 3 Place the lens in the case, with the tripod mount closest to you and facing the left as shown.
- 4 Fasten the lens securely with the strap.
- 5 Pull the fastener and close the lid.

- Before stowing the lens, be sure to attach all cushions inside the case.
- The lens should always be stowed in the proper way.

15. Tripod Mount

A tripod or monopod attaches to the tripod mount on the lens.

Switching the Orientation of the Image

By loosening the orientation locking knob on the tripod mount you can rotate the camera and the lens to switch the image in any orientation (vertical, horizontal, etc.).

The mount clicks at 4 positions, every 90°.

● Since the tripod mount requires special fastening, as a safety precaution, do not replace the mount yourself.

● Replacement with a monopod mount (sold separately) can be done at a Canon Service Center at cost.

16. Security Slot

This lens is fitted with a security slot to prevent theft.

The security slot is located under the cover for the orientation locking knob. Attach a commercially-available wire-type security lock here.

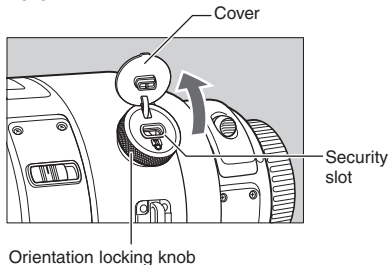

17. Drop-In Filters

A 52(WIII)-series Canon drop-in filter can be used with the lens.

Detaching Drop-In Filters

To detach a drop-in filter, press in both lock buttons and pull the filter holder straight out of the slot.

Attaching Drop-In Filters

To attach a drop-in filter, push the filter holder straight down into the slot until it clicks into place. The filter holder can be attached facing either forwards or backwards.

A Drop-In Screw-Type Filter Holder 52(WIII) and Canon PROTECT filter are included with the lens.

Before using a commercially available lens filter, first detach the PROTECT filter. The filter size is 52 mm, and only one filter can be used.

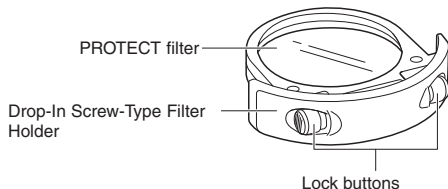
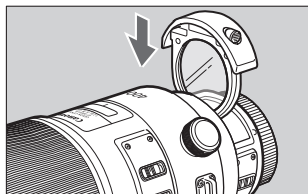

Drop-In Filters



- Because the lens optics are designed to include a filter, you must always attach either a Canon PROTECT filter or a commercially available filter before attaching a Drop-In Screw-Type Filter Holder.
- Note that filter frame thickness may prevent some commercially available lens filters from being used.
- With EOS cameras that have a built-in flash, a drop-in filter may come in contact with the camera. Before attaching/detaching a drop-in filter, detach the lens from the camera.





- The Drop-In Gelatin Filter Holder 52(WIII) and Drop-In Circular Polarizing Filter PL-C52(WIII) are also available (sold separately).
- The 52/52(WII)-series drop-in filters can also be used. However, their exterior color is different than the lens body.

18. Extenders (Sold Separately)

Use an extender EF1.4× III or EF2× III to shoot a larger image of a subject. Lens specifications when using an extender are as follows.

		EF1.4× III	EF2× III
Focal length (mm)		560	800
Aperture		f/4 – 45	f/5.6 – 64
Angle of view	Horizontal	3° 40'	2° 35'
	Vertical	2° 25'	1° 40'
	Diagonal	4° 25'	3° 05'
Maximum magnification (×)		0.25	0.36

-  Attach the extender to the lens, and then attach the camera. To detach it, reverse the order. Errors may occur if you attach the extender to the camera first.
- Extenders cannot be used more than one at a time.

-  When an extender is attached, the AF speed will become slower to retain proper control.

19. Extension Tubes (Sold Separately)

Use an extension tube EF12 II or EF25 II to get closer to a subject and shoot a larger image. Lens specifications when using an extension tube are as follows.

EF12 II

	Close distance	Long distance
Focusing distance range (mm)	2192	13105
Magnification (×)	0.22	0.03

EF25 II

	Close distance	Long distance
Focusing distance range (mm)	1946	6330
Magnification (×)	0.30	0.07

-  MF mode is recommended for accurate focusing.

Specifications

Focal Length/Aperture	400mm f/2.8
Lens Construction	13 groups, 17 elements
Minimum Aperture	f/32
Angle of View	Horizontal: 5° 10' Vertical: 3° 30' Diagonal: 6° 10'
Min. Focusing Distance	2.5 m/8.2 ft.
Max. Magnification	0.17×
Field of View	Approx. 202 × 135 mm/7.95 × 5.31 in. (at 2.5 m / 8.2 ft.)
Filter	Any 52(WIII)-series drop-in filter
Max. Diameter and Length	163 × 343 mm/6.42 × 13.50 in.
Weight	Approx. 2840 g/100.2 oz
Hood	ET-155 (WIII) ET-155B (sold separately)
Lens Cap	E-180E
Case	LS400 400E (sold separately)

- The lens length is measured from the lens mount surface to the front end of the lens.
- The max. diameter × length and weight listed are for the lens only.
- The Close-up Lenses 250D and 500D cannot be attached.
- Aperture settings are specified on the camera.
- All data listed is measured according to Canon standards.
- Product specifications and appearance are subject to change without notice.

Canon