



FOCUS SPOT 6Z



User Manual

USA# FOC635
EU# 1237000301
UPC# 818651028133

©2020 ADJ Products, LLC all rights reserved. Information, specifications, diagrams, images, and instructions herein are subject to change without notice. ADJ Products, LLC logo and identifying product names and numbers herein are trademarks of ADJ Products, LLC. Copyright protection claimed includes all forms and matters of copyrightable materials and information now allowed by statutory or judicial law or hereinafter granted. Product names used in this document may be trademarks or registered trademarks of their respective companies and are hereby acknowledged. All non-ADJ Products, LLC brands and product names are trademarks or registered trademarks of their respective companies.

ADJ Products, LLC and all affiliated companies hereby disclaim any and all liabilities for property, equipment, building, and electrical damages, injuries to any persons, and direct or indirect economic loss associated with the use or reliance of any information contained within this document, and/or as a result of the improper, unsafe, insufficient and negligent assembly, installation, rigging, and operation of this product.

DOCUMENT VERSION

Due to additional product features and/or enhancements, an updated version of this document may be available online.

Please check www.adj.com for the latest revision/update of this manual before beginning installation and/or programming.



Date	Document Version	Software Version	DMX Channel Modes	Notes
07/31/2020	1.0	1.2.1	21 / 25 / 29 Channels	Initial Release
08/11/2020	1.1	NC	No Change	Updated Gobo Replacement
09/10/2020	1.2	1.2.2	No Change	Updated System Menu, DMX Modes & Values, Primary-Secondary Setup

Europe Energy Saving Notice

Energy Saving Matters (EuP 2009/125/EC)

Saving electric energy is a key to help protecting the environment. Please turn off all electrical products when they are not in use. To avoid power consumption in idle mode, disconnect all electrical equipment from power when not in use. Thank you!

Introduction	4
Features Warranty Registration	5
Safety Precautions	6
Installation	7
Overview	10
DMX Setup	11
DMX Addressing	13
DMX Modes & Values	14
System Menu	23
Primary-Secondary Setup	30
Dimmer Modes	31
Gobo Replacement	32
Gobos	36
Color Wheels Fuse Replacement	37
Multi Unit Power Linking Trouble Shooting Cleaning	38
Software Updates	39
Warranty	40
Dimensional Drawings	41
Specifications	42

Unpacking: Thank you for purchasing the Focus Spot 6Z by ADJ Products, LLC. Every unit has been thoroughly tested and has been shipped in perfect operating condition. Carefully check the shipping carton for damage that may have occurred during shipping. If the carton appears to be damaged, carefully inspect your fixture for any damage and be sure all accessories necessary to operate the unit have arrived intact. In the case that damage has been found or parts are missing, please contact our toll free customer support number for further instructions. Do not return this unit to your dealer without first contacting customer support.

Introduction: The Focus Spot 6Z is a DMX intelligent, moving head, LED fixture. This fixture can be used in stand alone mode, or connected in a Master/Slave configuration. The fixture comes equipped with motorized focus and zoom, 6 different dimming options, and 3 DMX channel modes (21, 25, or 29 channels). ***This product is intended to be used by professionally trained personnel only and is not suitable for private use.***

Customer Support: Contact ADJ Service for any product related service and support needs. Also visit forums.adj.com with questions, comments or suggestions.

Parts: To purchase parts online visit <http://parts.adj.com>

ADJ SERVICE USA - Monday - Friday 8:00am to 4:30pm PST

Voice: 800-322-6337 | Fax: 323-582-2941 | support@adj.com

ADJ SERVICE EUROPE - Monday - Friday 08:30 to 17:00 CET

Voice: +31 45 546 85 60 | Fax: +31 45 546 85 96 | support@adj.eu

ADJ PRODUCTS LLC USA

6122 S. Eastern Ave. Los Angeles, CA. 90040

323-582-2650 | Fax 323-532-2941 | www.adj.com | info@adj.com

ADJ SUPPLY Europe B.V

Junostraat 2 6468 EW Kerkrade, The Netherlands

+31 (0)45 546 85 00 | Fax +31 45 546 85 99

www.adj.eu | info@adj.eu

ADJ PRODUCTS GROUP Mexico

AV Santa Ana 30 Parque Industrial Lerma, Lerma, Mexico 52000

+52 (728) 282-7070

Caution! There are no user serviceable parts inside this unit. Do not attempt any repairs yourself, doing so will void your manufactures warranty. In the unlikely event your unit may require service please contact ADJ Products, LLC.

PLEASE recycle the shipping carton when ever possible.

Focus Spot 6Z

Features

- Motorized Focus
- 2 Frost Filters to create wash effects
- Motorized Zoom: 9~28 degrees
- 2 Prism FX: Rotating 6-facet Linear & Rotating 6-facet Circular
- Motorized Iris
- Motorized Shutter
- GOBO Morphing
- 0-100% smooth dimming
- Various strobe speeds
- USB firmware update port

Included:

- 1x Locking power cord
- 2x Omega brackets

Focus Spot 6Z

Warranty Registration

The Focus Spot 6Z carries a 2 year limited warranty. Please fill out the enclosed warranty card to validate your purchase. All returned service items whether under warranty or not, must be freight pre-paid and accompany a return authorization (R.A.) number. The R.A. number must be clearly written on the outside of the return package. A brief description of the problem as well as the R.A. number must also be written down on a piece of paper included in the shipping carton. If the unit is under warranty, you must provide a copy of your proof of purchase invoice. You may obtain an R.A. number by contacting our customer support team. All packages returned to the service department not displaying an R.A. number on the outside of the package will be returned to the shipper.

- **DO NOT TOUCH** the fixture housing during operation. Disconnect the power and allow approximately 15 minutes for the fixture to cool down before servicing.
- **DO NOT** shake the fixture, and avoid brute force when installing and/or operating the fixture.
- **DO NOT** operate the fixture if the power cord has become frayed, crimped and/or damaged. If the power cord is damaged, replace immediately with a new one of similar power rating.
- **DO NOT** attempt to remove or break off the ground prong from the electrical cord. This prong is used to reduce the risk of electrical shock and fire in case of an internal short.
- **DO NOT** attempt to operate this unit if it has been damaged.
- **DO NOT** spill water or other liquids into or on to your unit.
- This unit is intended for indoor use only. Use of this product outdoors voids all warranties.
- To reduce the risk of electrical shock or fire, do not expose this unit rain or moisture.
- Disconnect from main power before making any type of connection.
- **DO NOT** block any air ventilation slots. All fan and air inlets must remain clean and never blocked. Allow approx. 6" (15cm) between fixture and other devices or a wall for proper cooling.
- Always be sure to mount this unit in an area that will allow proper ventilation. Allow about 6" (15cm) between this device and a wall.
- During the initial operation of this fixture, a light smoke or smell may emit from the interior of the fixture. This is a normal process and is caused by excess paint in the interior of the casing burning off from the heat. This will decrease gradually over time.
- **DO NOT** remove the cover under any conditions. There are no user serviceable parts inside.
- When installing fixture in a suspended environment, always use mounting hardware that is no less than M10 x 25mm, and always install fixture with an appropriately rated safety cable.
- Never operate this unit with the cover removed.
- Never plug this unit in to a dimmer pack
- During long periods of non-use, disconnect the unit's main power.
- Always mount this unit in safe and stable matter.
- Power-supply cords should be routed so that they are not likely to be walked on or pinched by items placed upon or against them, paying particular attention to the point they exit from the unit.
- Cleaning -The fixture should be cleaned only as recommended by the manufacturer.
- Heat -The appliance should be situated away from heat sources such as radiators, heat registers, stoves, or other appliances (including amplifiers) that produce heat.
- The fixture should be serviced by qualified service personnel when:
 - A. The power-supply cord or the plug have been damaged.
 - B. Objects have fallen onto, or liquid has been spilled into, the fixture.
 - C. The fixture has been exposed to rain or water.
 - D. The fixture does not appear to operate normally or exhibits a marked change in performance.
 - E. The fixture has fallen and/or subjected to extreme handling.

POTENTIAL INTERNAL FIXTURE DAMAGE FROM EXTERNAL SOURCES OF LIGHT BEAMS

External sources of light beams from direct sunlight, lighting moving head fixtures, and lasers, which are focused directly towards the exterior housing and/or penetrate the front lens opening of ADJ lighting fixtures, can cause severe internal damage including burning of optics, dichroic color filters, glass and metal gobos, prisms, animation wheels, frost filters, iris, shutters, motors, belts, wiring, discharge lamps, and LEDs.

This issue is not specific only to ADJ lighting fixtures; it is a common issue with lighting fixtures from all manufacturers. Although there is no true way to fully prevent this issue from happening, the guidelines below can prevent any potential damage from occurring if followed. Contact ADJ Service for more details.

DO NOT EXPOSE THE FIXTURE AND/OR FRONT LENS OPENING TO LIGHT BEAMS FROM DIRECT SUNLIGHT, OTHER LIGHTING MOVING HEAD FIXTURES, AND LASERS DURING UNPACKING, INSTALLATION, USE, AND EXTENDED IDLE TIMES OUTDOORS.

DO NOT FOCUS A LIGHT BEAM FROM ONE LIGHTING FIXTURE DIRECTLY TOWARDS ANOTHER.

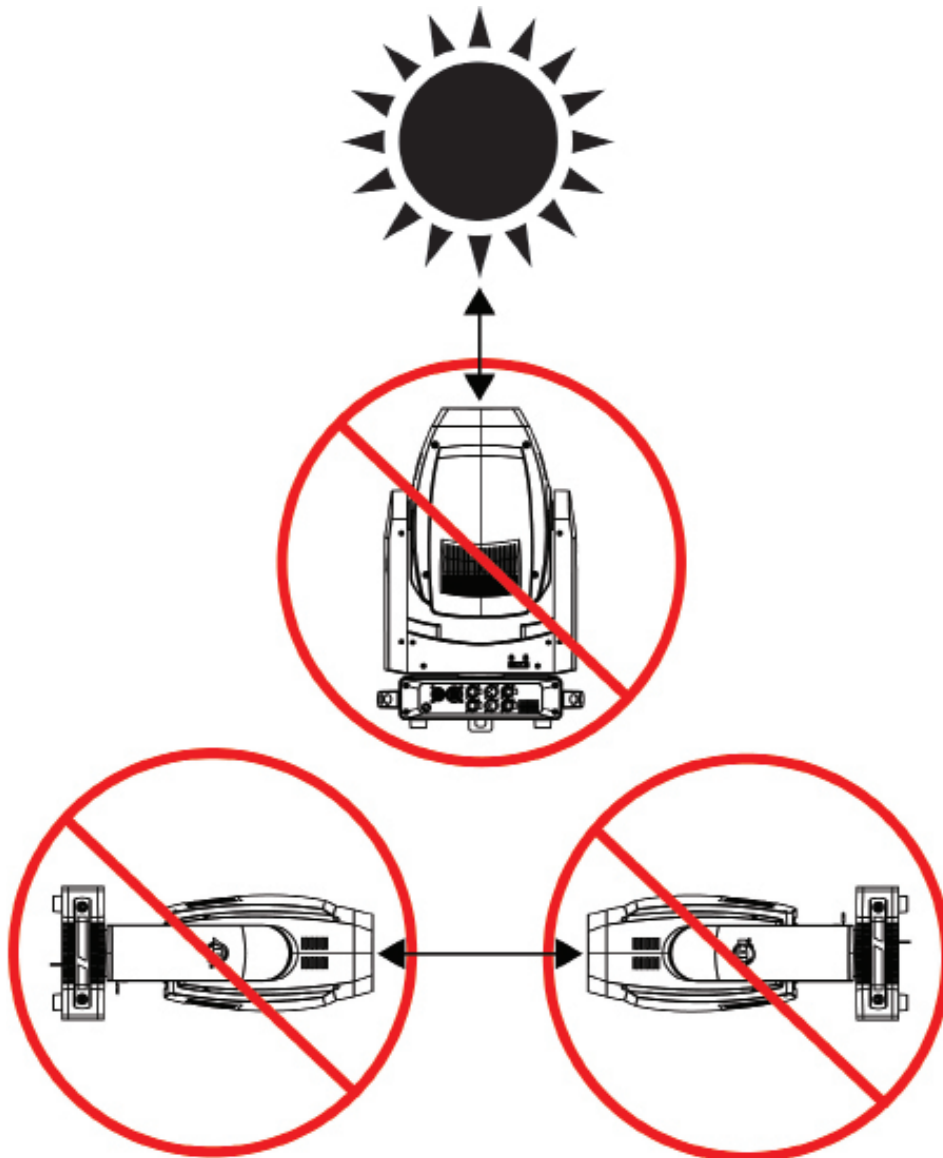

Screw one clamp each via a M12 screw and nut into the Omega bracket. Insert the quick-lock fasteners of the Omega holder's into the respective holes on the bottom of the Focus Spot 6Z. Tighten the quick-lock fasteners fully clockwise. Pull the safety cable through the openings located on the base plate and over the trussing system or a safe fixation spot. Insert the end in the carabine and tighten the safety screw.

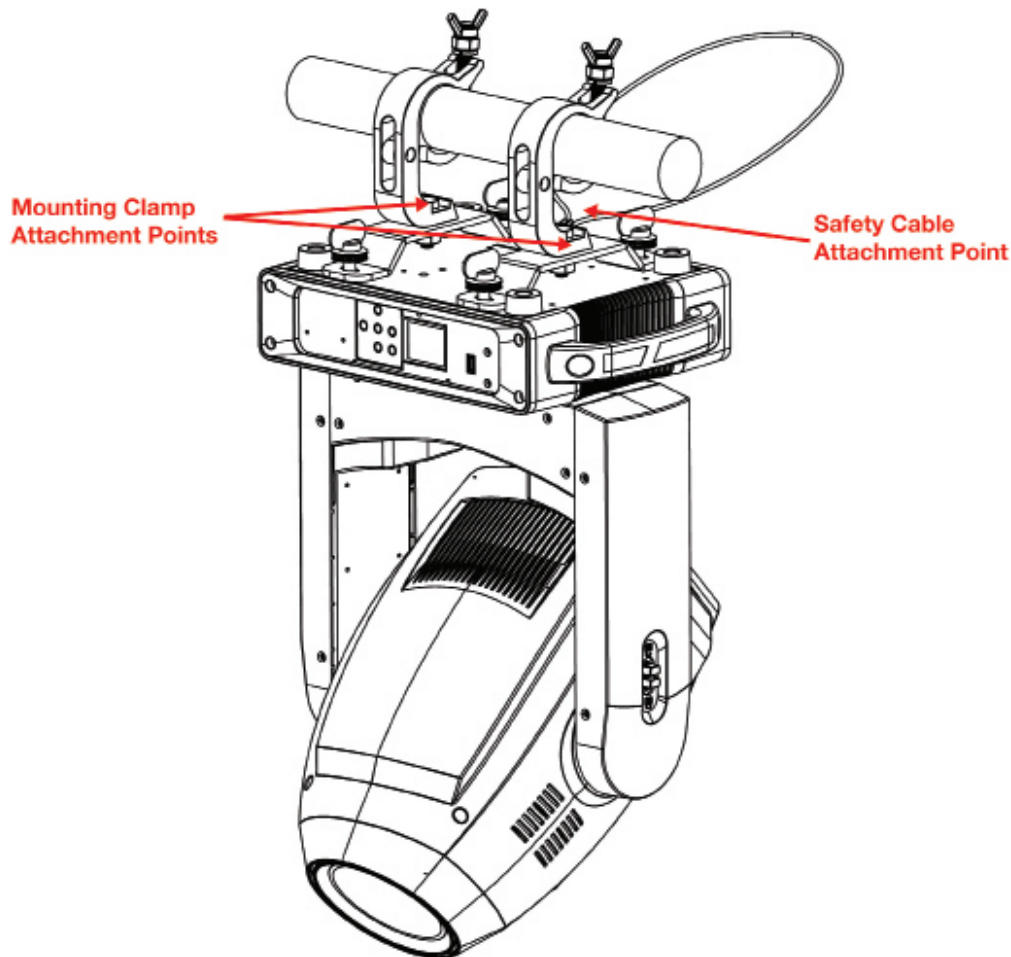

When installing the unit, the trussing or area of installation must be able to hold 10 times the weight without any deformation. When installing the unit must be secured with a secondary safety attachment, e.g. and appropriate safety cable. Never stand directly below the unit when mounting, removing, or servicing the unit.

Overhead mounting requires extensive experience, including calculating working load limits, installation material being used, and periodic safety inspection of all installation material and unit. If you lack these qualifications, do not attempt the installation yourself.

These installation should be checked by a skilled person once a year.

NOTICE: The max suitable enviromental temperature for this lighting fixture is **45° C**. Do not place this lighting fixture in an enviroment where the temperatures are under or above the temperatures stated above. This will allow the fixture to run at its best and help prolong the fixture life.

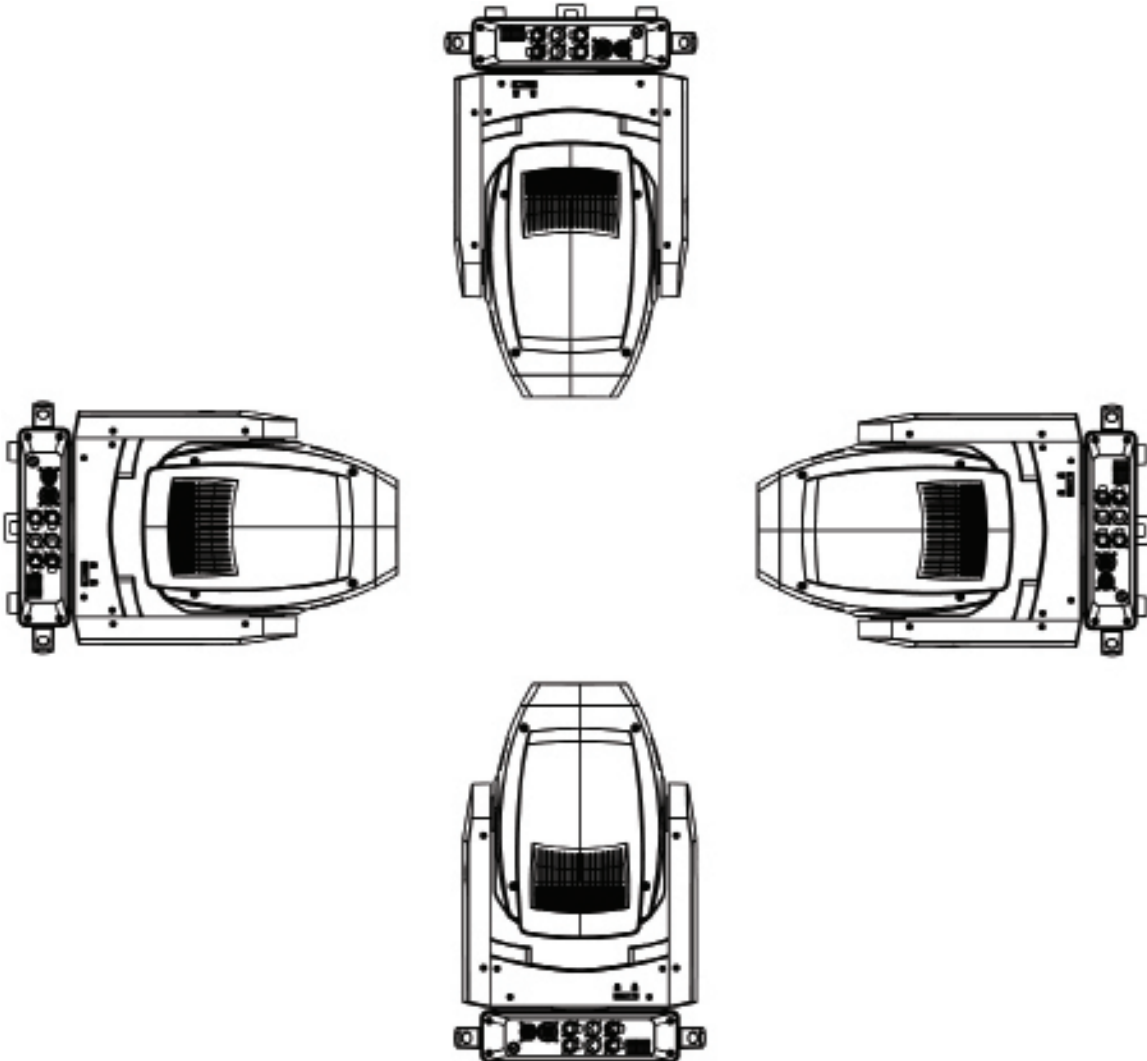

The Focus Spot 6Z is fully operational in three different mounting positions, hanging upside-down from a ceiling or trussing, sideways on trussing, or set on a flat level surface. Be sure this fixture is kept at least 12m (40ft) away from any flammable materials (decoration etc.). Always use and install a safety cable (not included) as a safety measure to prevent accidental damage and/or injury in the event the clamp fails. Never use the carrying handles for secondary attachment.

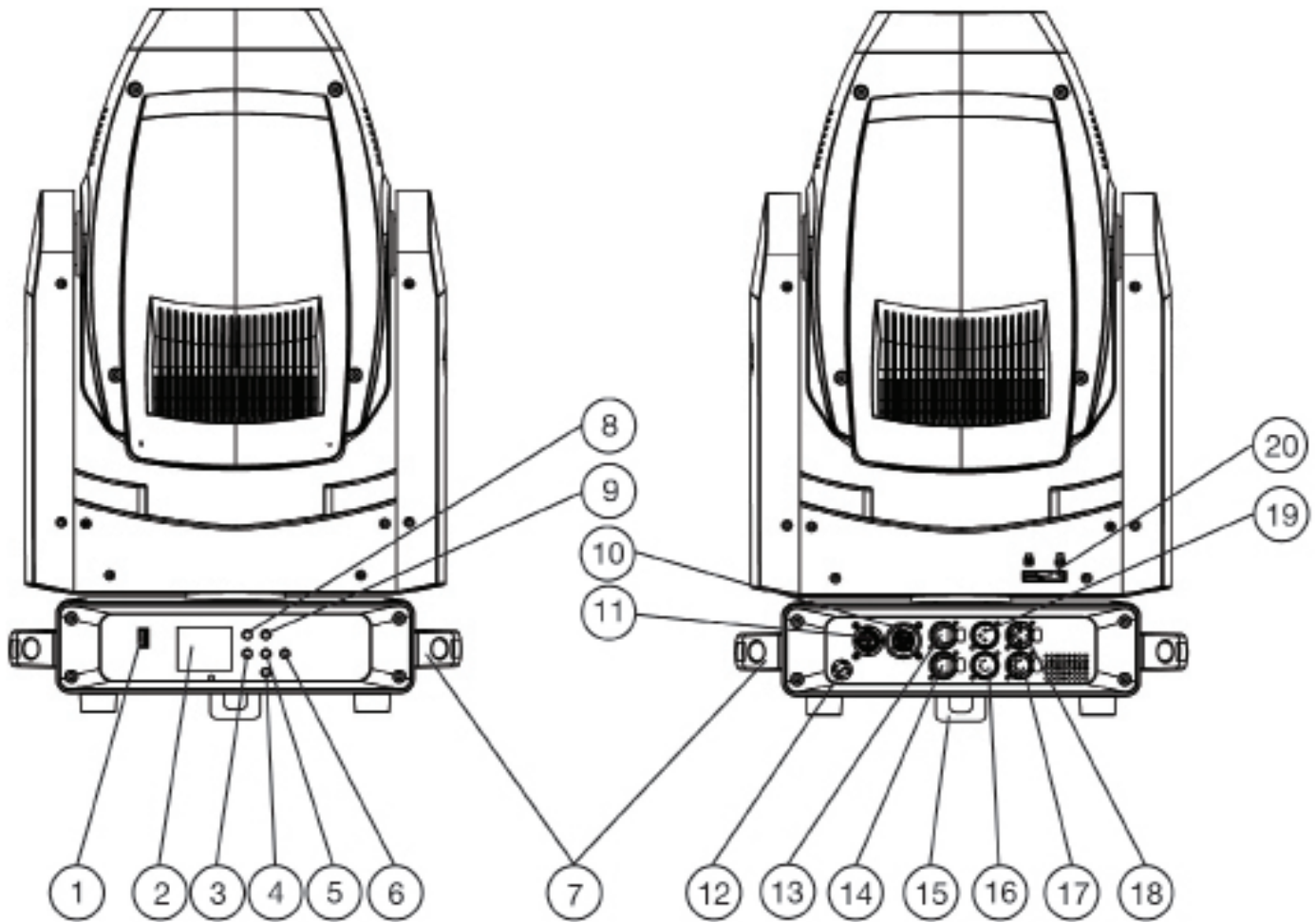

- 1. Service Port
- 2. Display Screen
- 3. Left Button
- 4. Down Button
- 5. Enter Button
- 6. Right Button
- 7. Carry Handles
- 8. Mode Button
- 9. Up Button
- 10. Power Out

- 11. Power In
- 12. Fuse T5A/250V
- 13. Net In
- 14. Net Out
- 15. Safety Cable Attachment Point
- 16. 5-pin DMX In
- 17. 5-pin DMX Out
- 18. 3-pin DMX Out
- 19. 3-pin DMX In
- 20. Pan Lock

DMX-512: DMX is short for Digital Multiplex. This is a universal protocol used as a form of communication between intelligent fixtures and controllers. A DMX controller sends DMX data instructions from the controller to the fixture. DMX data is sent as serial data that travels from fixture to fixture via the DATA “IN” and DATA “OUT” XLR terminals located on all DMX fixtures (most controllers only have a DATA “OUT” terminal).

DMX Linking: DMX is a language allowing all makes and models of different manufactures to be linked together and operate from a single controller, as long as all fixtures and the controller are DMX compliant. To ensure proper DMX data transmission, when using several DMX fixtures try to use the shortest cable path possible. The order in which fixtures are connected in a DMX line does not influence the DMX addressing. For example; a fixture assigned a DMX address of 1 may be placed anywhere in a DMX line, at the beginning, at the end, or anywhere in the middle. When a fixture is assigned a DMX address of 1, the DMX controller knows to send DATA assigned to address 1 to that unit, no matter where it is located in the DMX chain.

Data Cable (DMX Cable) Requirements (For DMX Operation): The Focus Spot 6Z can be controlled via DMX-512 protocol. The DMX address is set on the front panel of the Focus Spot 6Z. Your unit and your DMX controller require a standard 3-pin XLR connector for data input and data output. We recommend Accu-Cable DMX cables. If you are making your own cables, be sure to use standard 110-120 Ohm shielded cable (This cable may be purchased at almost all pro lighting stores). Your cables should be made with a male and female XLR connector on either end of the cable. Also remember that DMX cable must be daisy chained and cannot be split.

Notice: Be sure to follow figures 1 and 2 when making your own cables. Do not use the ground lug on the XLR connector. Do not connect the cable’s shield conductor to the ground lug or allow the shield conductor to come in contact with the XLR’s outer casing. Grounding the shield could cause a short circuit and erratic behavior.

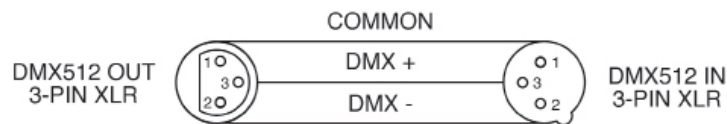

Figure 1

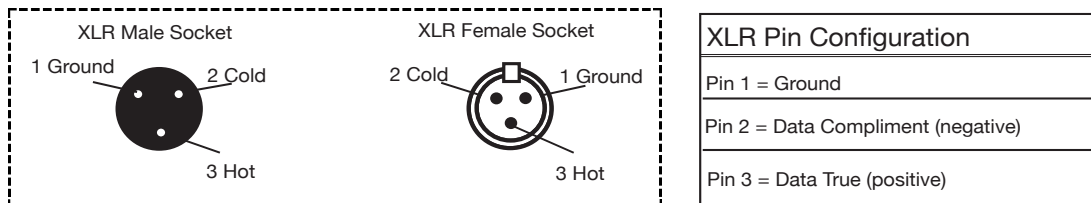
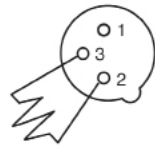

Figure 2

Special Note: Line Termination. When longer runs of cable are used, you may need to use a terminator on the last unit to avoid erratic behavior. A terminator is a 110-120 ohm 1/4 watt resistor which is connected between pins 2 and 3 of a male XLR connector (DATA + and DATA -). This unit is inserted in the female XLR connector of the last unit in your daisy chain to terminate the line. Using a cable terminator (ADJ part number Z-DMX/T) will decrease the possibilities of erratic behavior.



Termination reduces signal errors and avoids signal transmission problems and interference. It is always advisable to connect a DMX terminal, (Resistance 120 Ohm 1/4 W) between PIN 2 (DMX-) and PIN 3 (DMX +) of the last fixture.

5-Pin XLR DMX Connectors. Some manufactures use 5-pin DMX-512 data cables for DATA transmission in place of 3-pin. 5-pin DMX fixtures may be implemented in a 3-pin DMX line. When inserting standard 5-pin data cables in to a 3-pin line a cable adaptor must be used, these adaptors are readily available at most electric stores. The chart below details a proper cable conversion.

3-Pin XLR to 5-Pin XLR Conversion		
Conductor	3-Pin XLR Female (Out)	5-Pin XLR Male (In)
Ground/Shield	Pin 1	Pin 1
Data Compliment (- signal)	Pin 2	Pin 2
Data True (+ signal)	Pin 3	Pin 3
Not Used		Do Not Use
Not Used		Do Not Use

All fixtures should be given a DMX starting address when using a DMX controller, so the correct fixture responds to the correct control signal. This digital starting address is the channel number from which the fixture starts to “listen” to the digital control signal sent out from the DMX controller. The assignment of this starting DMX address is achieved by setting the correct DMX address on the digital control display on the fixture.

You can set the same starting address for all fixtures or a group of fixtures, or set different addresses for each individual fixture. Setting all fixtures to the same DMX address will cause all fixtures to react in the same way, in other words, changing the settings of one channel will affect all the fixtures simultaneously.

If you set each fixture to a different DMX address, each unit will start to “listen” to the channel number you have set, based on the quantity of DMX channels of each fixture. That means changing the settings of one channel will only affect the selected fixture.

In the case of the Focus Spot 6Z, when in 21 channel mode you should set the starting DMX address of the first unit to 1, the second unit to 22 ($21 + 1$), the third unit to 43 ($22 + 21$), and so on. (See the chart below for more details.)

Channel Mode	Unit 1 Address	Unit 2 Address	Unit 3 Address	Unit 4 Address
21 Channels	1	22	43	64
25 Channels	1	26	51	76
29 Channels	1	30	59	88

ADJ Focus Spot 6Z - DMX Modes and Values

Supports software version 1.2.2 and up.

Features subject to change without notice.

Channel Mode			Values	Traits
Basic	Standard	Ext		
1	1	1	000 - 255	Pan Movement, 8-bit
	2	2	000 - 255	Pan Fine Control, 16-bit
2	3	3	000 - 255	Tilt Movement, 8-bit
	4	4	000 - 255	Tilt Fine Control, 16-bit
3	5	5	<i>Color Wheel 1</i>	
			000 - 015	Open / white
			016 - 031	Red
			032 - 047	Orange
			048 - 063	Green
			064 - 079	Light Blue
			080 - 095	Purple
			096 - 111	Magenta
			112 - 127	Yellow
			128 - 189	Clockwise, fast to slow
			190 - 193	No rotation
			194 - 255	Counter-clockwise, slow to fast
4	6	6	<i>Color Wheel 2</i>	
			000 - 015	Open / white
			016 - 031	Orange Red
			032 - 047	Yellow Green
			048 - 063	Peacock Blue
			064 - 079	CTO
			080 - 095	CTB
			096 - 111	Flourescent Blue
			112 - 127	Light Yellow
			128 - 189	Clockwise, fast to slow
			190 - 193	No rotation
			194 - 255	Counter-clockwise, slow to fast
5	7	7	<i>Gobo 1, Continuous Rotation (see Gobos section for gobo patterns)</i>	
			000 - 009	Open
			010 - 019	Gobo 1

CONTINUED ON NEXT PAGE

ADJ Focus Spot 6Z - DMX Modes and Values				
Supports software version 1.2.2 and up.				
Features subject to change without notice.				
Channel Mode			Values	Traits
Basic	Standard	Ext		
5	7	7	<i>Gobo 1, Continuous Rotation (see Gobos section for gobo patterns) (cont'd from prev page)</i>	
			020 - 029	Gobo 2
			030 - 039	Gobo 3
			040 - 049	Gobo 4
			050 - 059	Gobo 5
			060 - 069	Gobo 6
			070 - 079	Gobo 7
			080 - 094	Gobo 1 shake, slow to fast
			095 - 109	Gobo 2 shake, slow to fast
			110 - 124	Gobo 3 shake, slow to fast
			125 - 139	Gobo 4 shake, slow to fast
			140 - 154	Gobo 5 shake, slow to fast
			155 - 169	Gobo 6 shake, slow to fast
			170 - 189	Gobo 7 shake, slow to fast
			190 - 221	Clockwise, fast to slow
222 - 223	No rotation			
224 - 255	Counter-clockwise, slow to fast			
6	8	8	<i>Gobo 1 Rotation</i>	
			000 - 127	Indexing
			128 - 189	Clockwise, fast to slow
			190 - 193	No rotation
			194 - 255	Counter-clockwise, slow to fast
7	9	9	<i>Gobo 2, Continuous Rotation (see Gobos section for gobo patterns)</i>	
			000 - 009	Open
			010 - 019	Gobo 1
			020 - 029	Gobo 2
			030 - 039	Gobo 3
			040 - 049	Gobo 4
			050 - 059	Gobo 5
			060 - 069	Gobo 6

CONTINUED ON NEXT PAGE

ADJ Focus Spot 6Z - DMX Modes and Values				
Supports software version 1.2.2 and up.				
Features subject to change without notice.				
Channel Mode			Values	Traits
Basic	Standard	Ext		
7	9	9	<i>Gobo 2, Continuous Rotation (see Gobos section for gobo patterns) (cont'd from previous page)</i>	
			070 - 079	Gobo 7
			080 - 094	Gobo 1 shake, slow to fast
			095 - 109	Gobo 2 shake, slow to fast
			110 - 124	Gobo 3 shake, slow to fast
			125 - 139	Gobo 4 shake, slow to fast
			140 - 154	Gobo 5 shake, slow to fast
			155 - 169	Gobo 6 shake, slow to fast
			170 - 189	Gobo 7 shake, slow to fast
			190 - 221	Clockwise, fast to slow
			222 - 223	No rotation
224 - 255	Counter-clockwise, slow to fast			
8	10	10	<i>Gobo 2 Rotation</i>	
			000 - 127	Indexing
			128 - 189	Clockwise, fast to slow
			190 - 193	No rotation
194 - 255	Counter-clockwise, slow to fast			
9	11	11	<i>Shutter, Strobe</i>	
			000 - 031	No function (shutter closed)
			032 - 063	Shutter open
			064 - 095	Strobe, slow to fast
			096 - 127	Shutter open
			128 - 159	Pulse effect, slow to fast
			160 - 191	Shutter open
			192 - 223	Random strobe, slow to fast
224 - 255	Shutter open			
10	12	12	000 - 255	Dimmer Intensity, 0 to 100%
		13	000 - 255	Dimmer Fine Control, 0 to 100%
CONTINUED ON NEXT PAGE				

ADJ Focus Spot 6Z - DMX Modes and Values				
Supports software version 1.2.2 and up.				
Features subject to change without notice.				
Channel Mode			Values	Traits
Basic	Standard	Ext		
11	13	14	<i>Prism 1</i>	
			000 - 031	Open
			032 - 255	6 facet prism
12	14	15	<i>Prism 1 Indexing and Rotation</i>	
			000 - 127	Indexing
			128 - 189	Clockwise, fast to slow
			190 - 193	No rotation
		194 - 255	Counter-clockwise, slow to fast	
		16	000 - 255	Prism 1 fine indexing, 16-bit
13	15	17	<i>Prism 2</i>	
			000 - 031	Open
			032 - 255	5 Linear prism
14	16	18	<i>Prism 2 Indexing and Rotation</i>	
			000 - 127	Indexing
			128 - 189	Clockwise, fast to slow
			190 - 193	No rotation
		194 - 255	Counter-clockwise, slow to fast	
		19	000 - 255	Prism 2 fine indexing, 16-bit
15	17	20	000 - 255	Focus adjustment, far to near
16	18	21	000 - 255	Zoom, min to max beam angle
		22	000 - 255	Zoom fine indexing
17	19	23	<i>Iris</i>	
			000 - 191	Indexing
			192 - 223	Pulse Open, slow to fast
			224 - 255	Pulse Close, fast to slow
18	20	24	000 - 255	Frost Filter 1, 0 to 100%
19	21	25	000 - 255	Frost Filter 2, 0 to 100%
	22	26	<i>Dim Modes</i>	
			000 - 020	Standard
			021 - 040	Stage
			041 - 060	TV

CONTINUED ON NEXT PAGE

ADJ Focus Spot 6Z - DMX Modes and Values

Supports software version 1.2.2 and up.

Features subject to change without notice.

Channel Mode			Values	Traits
Basic	Standard	Ext		
			<i>Dim Modes (cont'd from previous page)</i>	
			061 - 080	Architectural
			081 - 100	Theatre
			101 - 120	Stage 2
			<i>Dimming Speed</i>	
			121	0.1 s
			122	0.2 s
			123	0.3 s
			124	0.4 s
			125	0.5 s
			126	0.6 s
			127	0.7 s
			128	0.8 s
			129	0.9 s
			130	1.0 s
			131	1.5 s
			132	2.0 s
			133	3.0 s
			134	4.0 s
			135	5.0 s
			136	6.0 s
			137	7.0 s
			138	8.0 s
			139	9.0 s
			140	10.0 s
			141 - 255	Default to unit setting

CONTINUED ON NEXT PAGE

ADJ Focus Spot 6Z - DMX Modes and Values				
Supports software version 1.2.2 and up.				
Features subject to change without notice.				
Channel Mode			Values	Traits
Basic	Standard	Ext		
	23	27	<i>Dim Curves</i>	
			000 - 020	Linear
			021 - 040	Square
			041 - 060	Inv. Squa
			061 - 080	S. Curve
			081 - 255	No function
20	24	28	000 - 255	Pan/Tilt Speed, max to min speed
21	25	29	<i>LED Refresh Rate</i>	
			000 - 010	Default LED Refresh Rate
			011	900 Hz
			012	910 Hz
			013	920 Hz
			014	930 Hz
			015	940 Hz
			016	950 Hz
			017	960 Hz
			018	970 Hz
			019	980 Hz
			020	990 Hz
			021	1000 Hz
			022	1010 Hz
			023	1020 Hz
			024	1030 Hz
			025	1040 Hz
			026	1050 Hz
027	1060 Hz			
028	1070 Hz			
029	1080 Hz			
030	1090 Hz			
031	1100 Hz			
CONTINUED ON NEXT PAGE				

ADJ Focus Spot 6Z - DMX Modes and Values				
Supports software version 1.2.2 and up.				
Features subject to change without notice.				
Channel Mode			Values	Traits
Basic	Standard	Ext		
21	25	29	<i>LED Refresh Rate (cont'd from previous page)</i>	
			032	1110 Hz
			033	1120 Hz
			034	1130 Hz
			035	1140 Hz
			036	1150 Hz
			037	1160 Hz
			038	1170 Hz
			039	1180 Hz
			040	1190 Hz
			041	1210 Hz
			042	1220 Hz
			043	1230 Hz
			044	1240 Hz
			045	1250 Hz
			046	1260 Hz
			047	1270 Hz
			048	1280 Hz
			049	1290 Hz
			050	1300 Hz
			051	1310 Hz
052	1320 Hz			
053	1330 Hz			
054	1340 Hz			
055	1350 Hz			
056	1360 Hz			
057	1370 Hz			
058	1380 Hz			
059	1390 Hz			
060	1400 Hz			
061	1410 Hz			
<i>CONTINUED ON NEXT PAGE</i>				

ADJ Focus Spot 6Z - DMX Modes and Values

Supports software version 1.2.2 and up.

Features subject to change without notice.

Channel Mode			Values	Traits
Basic	Standard	Ext		
21	25	29	<i>LED Refresh Rate (cont'd from previous page)</i>	
			062	1420 Hz
			063	1430 Hz
			064	1440 Hz
			065	1450 Hz
			066	1460 Hz
			067	1470 Hz
			068	1480 Hz
			069	1490 Hz
			070	1500 Hz
			071	2500 Hz
			072	4000 Hz
			073	5000 Hz
			074	6000 Hz
			075	10,000 Hz
			076	15,000 Hz
			077	20,000 Hz
			078	25,000 Hz
			079	Disable LED Refresh Rate
			<i>Function</i>	
			080 - 089	Enable blackout while Pan/Tilt moving
			090 - 099	Disable blackout while Pan/Tilt moving
			100 - 109	Enable blackout while color changing
			110 - 119	Disable blackout while color changing
			120 - 129	Enable blackout while gobo changing
			130 - 139	Disable blackout while gobo changing
			<i>Reset</i>	
140 - 149	Reset All			
150 - 159	Reset Pan/Tilt			
160 - 169	Reset Color and Gobo			
170 - 179	Reset Effects and Focus			
CONTINUED ON NEXT PAGE				

ADJ Focus Spot 6Z - DMX Modes and Values

Supports software version 1.2.2 and up.

Features subject to change without notice.

Channel Mode			Values	Traits
Basic	Standard	Ext		
21	25	29	<i>Internal Programs</i>	
			180 - 185	Internal Program 1 (Scenes 1-8)
			186 - 191	Internal Program 2 (Scenes 9-16)
			192 - 197	Internal Program 3 (Scenes 17-24)
			198 - 199	Internal Program 4 (Scenes 25-32)
			200 - 205	Internal Program 5 (Scenes 33-40)
			206 - 211	Internal Program 6 (Scenes 41-48)
			212 - 216	Internal Program 7 (Scenes 49-56)
			<i>Fan Modes</i>	
			217 - 227	Fan Mode Low
			228 - 238	Fan Mode High
			239 - 249	Fan Mode Auto
			250 - 255	No Function

CONTROL PANEL

The fixture includes an easy to navigate system menu control panel display where all necessary settings and adjustments are made. (See image below) During normal operation, pressing the **MENU** button once will access the fixture's main menu. Once in the main menu, you can navigate through the different functions and access the sub-menus with the **UP** and **DOWN** buttons. When you reach a field that requires adjusting, press the **ENTER** button to access that field and use the **UP** and **DOWN** buttons to adjust the field. Pressing the **ENTER** button once more will confirm your setting. You may exit the main menu at any time without making any adjustments by pressing the **MENU** button.

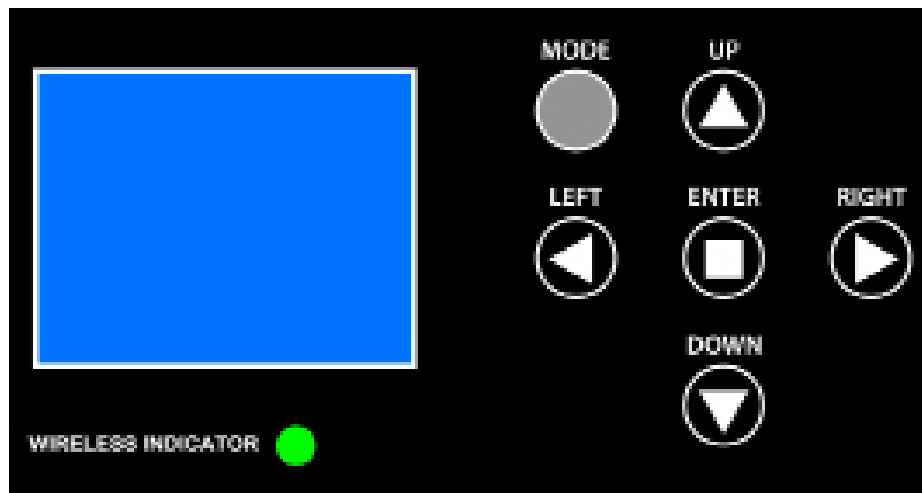

LCD CONTROL PANEL LOCKOUT

When the **Key Lock** function is activated, the control panel will automatically lock after the time set under the **Display** submenu "**Screen Saver Delay**".

When the **Key Lock** function is set to **ON**, the control panel will lock. Press and hold the **MODE** button for 3 seconds to unlock.

When the **Key Lock** function is set to **ON1**, the control panel will lock, and will not unlock without a code. To unlock the display follow these steps:

1. Press the **UP** button, and the display will change to:

*			
---	--	--	--

 (one * appears).
2. Press the **DOWN** button, and the display will change to:

*	*		
---	---	--	--

 (two * appear).
3. Press the **UP** button, and the display will change to:

*	*	*	
---	---	---	--

 (three * appear).
4. Press the **DOWN** button, and the display will change to:

*	*	*	*
---	---	---	---

 (four * appear).
5. Press the **ENTER** button, and the display will be unlocked.

If the button sequence was entered correctly, the display and control panel will unlock. If the button sequence was entered incorrectly, the display will return to the DMX address display.

DMX SETTINGS	Set Address	A001~AXXX			
	DMX Channel Mode	Basic (21-ch)			
		Standard (25-ch)			
		Extended (29-ch)			
	No DMX Status	Hold Last			
		Blackout			
Manual					
PERSONALITY	Primary	On / Off			
	Secondary	On / Off			
	Status Settings	Pan Degree	540 / 630		
		Pan Invert	On / Off		
		Tilt Invert	On / Off		
		P/T Feedback	On / Off		
		P/T Speed	Speed 1		
			Speed 2		
		Hibernation	Off		
			01~99 min		
	15 min				
	Fixture ID	Service PIN	Password = 050		
		Universe	000 - 255		
		Unit IP Addr			
		Mask Addr			
	Protocol Set	ArtNet			
		sACN			
	Net Switch	On / Off			
	Fan Settings	Head	Auto		
			High		
			Silent		
	Dim Modes	Standard			
		Stage			
TV					
Architectural					
Theatre					
<i>CONTINUED ON NEXT PAGE</i>					

PERSONALITY (cont'd from prev page)	Dim Modes (cont'd from prev page)	Stage 2			
		Dim Speed	0.1s ~ 10s		
	LED Refresh Rate	900~1500 Hz	10 KHz (Default)		
		2500 Hz			
		4000 Hz			
		5000 Hz			
		6000 Hz			
		10 KHz			
		15 KHz			
		20 KHz			
		25 KHz			
		Gamma	1.0		
	2.0				
	2.2				
	2.4				
	2.6				
	2.8				
	Reset Motors	Reset All Motors	Yes / No		
		Pan/Tilt Reset	Yes / No		
		Effect Reset	Yes / No		
		Shutter Reset	Yes / No		
	Display	Intensity	1 ~ 10		
		Display Invert	Yes / No		
		Screen Saver Delay	Off - 10min		
		Key Lock	Off / On		
	Service	Effect Adjust	Pan, Tilt, ColorWheel1, ColorWheel2, Gobo1, Gobo1Rot1...7, Gobo2, Gobo2Rot1...7, Prism1, Prism1Rot, Prism2, Prism2Rot, Focus, Zoom, Iris, Frost1, Frost2		
		USB Port Power	On / Off		
		Update Software	Yes / No		
		Factory Restore	Yes / No		Passcode = 011
	CONTINUED ON NEXT PAGE				

MANUAL CONTROL	Pan	000 - 255		
	Pan Fine	000 - 255		
	Tilt	000 - 255		
	Tilt Fine	000 - 255		
	Color1	000 - 255		
	Color2	000 - 255		
	Gobo1	000 - 255		
	Gobo1 Rot	000 - 255		
	Gobo2	000 - 255		
	Gobo2 Rot	000 - 255		
	Prism 1	000 - 255		
	Prism 1 Rot	000 - 255		
	Prism 2	000 - 255		
	Prism 2 Rot	000 - 255		
	Shutter	000 - 255		
	Dimmer	000 - 255		
	Dimmer Fine	000 - 255		
	Focus	000 - 255		
	Zoom	000 - 255		
	Iris	000 - 255		
	Frost 1	000 - 255		
	Frost 2	000 - 255		
	Dim Modes	000 - 255		
	P/T Speed	000 - 255		
Special Function	000 - 255			
INTERNAL PROGRAMS	Program 1	Speed	000 - 255	
		Fade	000 - 255	
	Program 2	Speed	000 - 255	
		Fade	000 - 255	
	Program 3	Speed	000 - 255	
		Fade	000 - 255	
	Program 4	Speed	000 - 255	
		Fade	000 - 255	
<i>CONTINUED ON NEXT PAGE</i>				

INTERNAL PROGRAMS <i>(cont'd from previous page)</i>	Program 5	Speed	000 - 255	
		Fade	000 - 255	
	Program 6	Speed	000 - 255	
		Fade	000 - 255	
	Program 7	Speed	000 - 255	
		Fade	000 - 255	
INFORMATION	Fixture Life Time	Power On Time	<i>Lifetime fixture run time, non resettable</i>	
		P-On Time-R	<i>Fixture run time since last reset</i>	
		P-On Time Reset	Passcode = 050	
	Total LED Time	LED On Time	<i>Lifetime LED run time, non resettable</i>	
		LED On Resettable Time	<i>LED run time since last reset</i>	
		LED Hours Reset	Passcode = 050	
	Fixture Temps	LEDs	Current	
			Max Resettable	
			Max Not Resettable	
		Reset LED Temp	Yes / No	Passcode = 050
	Fan Info	LED Fan		
	DMX Values	Pan		
		Tilt		
		...		
		Special Function		
Error Logs	Fixture Errors	Passcode = 050		
	Reset Error Log	Yes / No	Passcode = 050	
Software Version	1.2.2			

DMX SETTINGS

- **SET ADDRESS** - In this submenu you can find and set your desired DMX address.
- **DMX CHANNEL MODE** - In this submenu you can find and set your desired DMX channel mode.
- **NO DMX STATUS** - This submenu setting is used as a precaution mode in case the DMX signal is lost or interrupted. The operating mode chosen in this submenu is the running mode the fixture will go into when the DMX signal is lost. Listed below are the 3 modes.
 - **Hold Last** - This setting will have the fixture stay in the last DMX setup.
 - **Blackout** - This setting will have the fixture automatically go into stand by mode.
 - **Manual** - This setting will go into the current manual control set up. See **MANUAL CONTROL**.

PERSONALITY

- **PRIMARY-SECONDARY MODE** - In these submenus, you are able to configure the fixture to function as a primary or secondary unit.
- **STATUS SETTINGS** - In this submenu you are able to access and adjust/change: Pan Degree, Pan Invert, Tilt Invert, P./T. Feedback, P./T. Speed, and Hibernation.
- **FIXTURE ID** - In this submenu you are able to assign the universe, IP address, and mask address for this fixture.
- **PROTOCOL SET** - In this submenu you are able to select whether the fixture will adhere to the ArtNet or sACN protocol.
- **NET SWITCH** - In this submenu you are able to enable or disable the Network ports.
- **FAN SETTINGS** - In this submenu you are able to select your desired fan speed setting.
- **DIM MODES** - In this submenu you are able to select your desired dimmer mode and adjust the dimming speed time.
- **LED REFRESH RATE** - In this submenu you are able to select your desired LED refresh rate.
- **GAMMA** - In this submenu you are able to adjust the gamma correction factor.
- **RESET MOTORS** - In this submenu you are able to reset selected motors.
- **DISPLAY** - In this submenu you you are able to adjust the display intensity, invert the display, set the idle time before the screen auto-locks, and activate/deactivate the display lock.
- **SERVICE** - In this submenu you are able to access and adjust/change: the calibration (effect adjust), activate the service port, update software, and restore the factory settings.

MANUAL CONTROL - This menu is for manual testing and manual control. Pan, tilt, color wheel, gobo wheels, gobo rotation, prisms, prism rotation, shutter, dimmer, focus, zoom, iris, frost filters, dim modes, pan/tilt speed, and special functions can be controlled.

INTERNAL PROGRAMS - In this menu you are able to select 1 of 7 internal programs to run. Program running speed and fade speed are adjustable.

INFORMATION -

- FIXTURE LIFE TIME

- **Power On Time** - The **TOTAL** power ON running time of the unit is displayed. This time **CANNOT** be reset.
- **P-On Time-R** - The **CURRENT** power ON running time of the unit is displayed. This running time may not be the same as the total power ON running time displayed under "**Power On Time**". This time **CAN** be reset.
- **P-On Time-Reset** - Reset the **CURRENT** power ON running time that is displayed under "**P-On Time-R**".

- TOTAL LED TIME

- **LED On Time** - The **TOTAL** LED ON time is displayed. This total LED ON time **CANNOT** be reset.
- **LED On Time-R** - The **CURRENT** LED ON running time is displayed. This running time may not be the same as the total LED ON time displayed under "**LED On Time**". This total LED ON time **CAN** be reset.
- **LED On Time Reset** - With this function you can reset the **CURRENT** LED ON time that is displayed under "**LED On Time-R**".

- FIXTURE TEMPS

- **LED** - The current temperature of the LED is displayed.
- **Reset LED Temp** - Reset the LED temperature reading.

- **FAN INFO. (RPM)** - In this submenu the current fan speed will be displayed.

- **DMX VALUES** - Displays the DMX values of any DMX channel that is currently in use. **NOTE: DMX value options depend on the current DMX channel mode setting.**

- **ERROR LOGS** - In this submenu you are able to check any unit errors as well as clearing the error log.

- **SOFTWARE VERSION** - Current software version is displayed.

Primary-Secondary Configuration:

This function will allow you to link units together to run in a Primary-Secondary set-up, in which one unit will act as the controlling unit and the others will react to the controlling unit's built-in programs. Any unit can be configured to act as a Primary or as a Secondary, but only one unit in a given system can be programmed to act as the Primary.

Primary-Secondary Connections and Settings:

1. Daisy chain your units via the XLR connector on the rear of the unit. Use standard XLR data cables to link your units together. Remember that the Male XLR connector is the input and the Female XLR connector is the output. The first unit in the chain (master) will use the female XLR connector only. The last unit in the chain will use the male XLR connector only.
2. **Primary Unit:**
Use the display screen and control panel to navigate to **Personality > Primary**. Select this sub-menu using the **ENTER** button, and use the arrows to toggle between ON and OFF. Press **ENTER** to confirm your selection.
3. **Secondary Unit(s):**
Use the display screen and control panel to navigate to **Personality > Secondary**. Select this sub-menu using the **ENTER** button, and use the arrows to toggle between ON and OFF. Press **ENTER** to confirm your selection. Repeat this step for all units that will operate in the slave mode setting.
4. The secondary units will now follow the behavior of the primary unit.

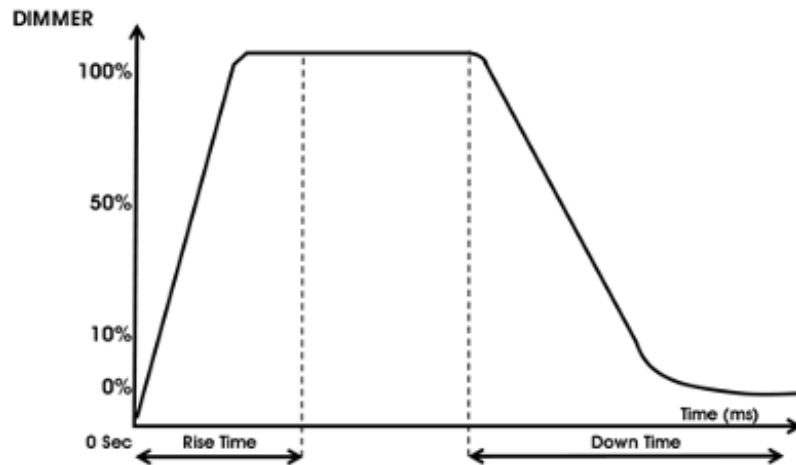

Dimming Curve Ramp Effect	0 sec Fade Time		1 sec Fade Time	
	Rise Time (ms)	Down Time (ms)	Rise Time (ms)	Down Time (ms)
Standard (default)	0	0	0	0
Stage	780	1100	1540	1660
TV	1180	1520	1860	1940
Architectural	1380	1730	2040	2120
Theatre	1580	1940	2230	2280
Stage 2	0	1100	0	1660

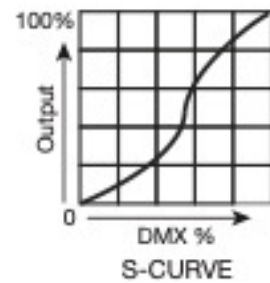
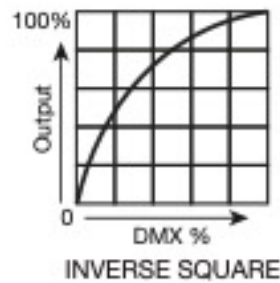
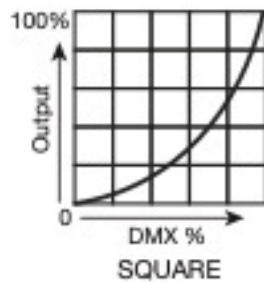
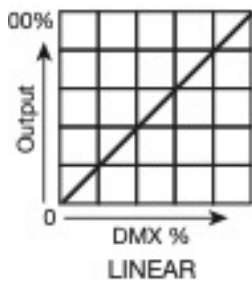

The gobo's featured in this unit are interchangeable. Remember when changing these gobos that they are easily bent or damaged. Please perform this procedure with caution in order to avoid damaging the gobos.

Caution! Never open the unit when in use. Always disconnect the main power before attempting to change the gobos.

1. Engage both the pan and tilt locks. Unscrew the four (4) screws that secure the cover to the head, then remove the safety clip that attaches near the bottom of the head and remove the cover.



2. Locate the gobo wheels and color wheels. They are positioned near the second large silver thumb screw on each side of the head. Turn the color wheel to that the open slot is facing towards you, and then turn the gobo wheel until the gobo you wish to replace is aligned with the open slot of the color wheel.

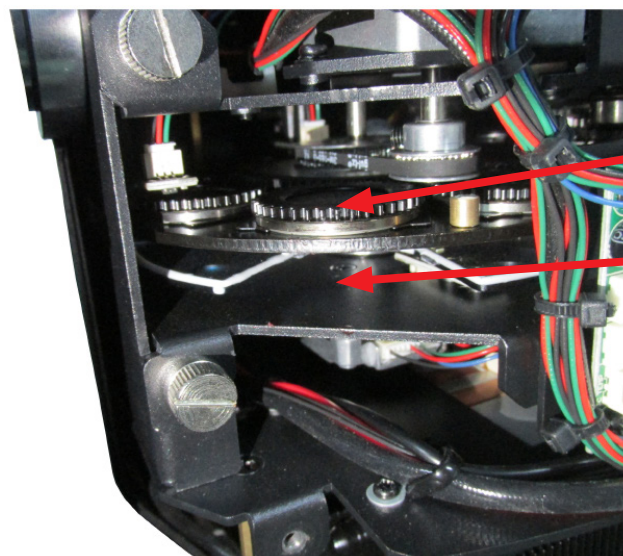

Gobo being changed is aligned to open slot in color wheel

Open slot in color wheel pointing towards user

3. Gently push the gobo holder upwards from below (left). When the silver part of the gobo holder clears the face of the gobo wheel, gently grasp the black geared portion of the gobo holder with your fingers and pull the gobo holder away from the gobo wheel (right). The gobo holder should come away easily. **DO NOT USE EXCESSIVE FORCE WHEN PERFORMING THIS STEP!**

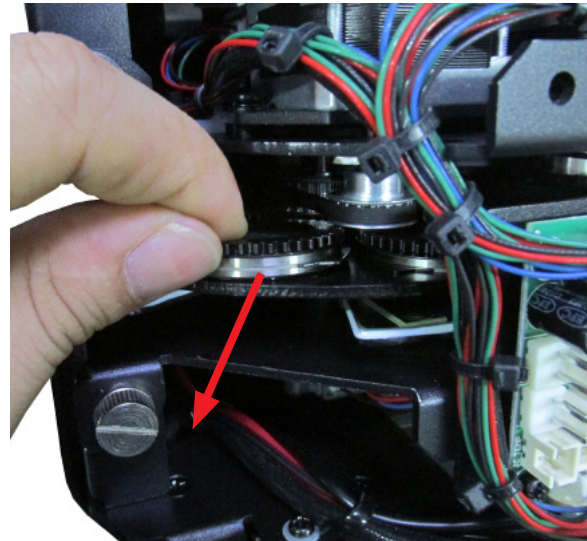
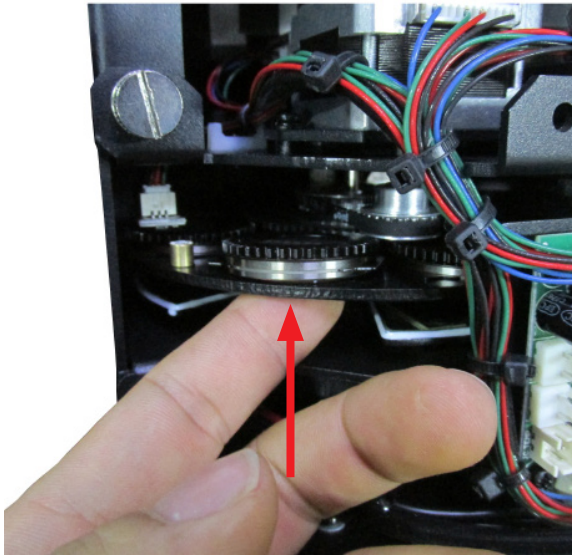

4. Place the gobo holder with the black gear side down. Using a set of tweezers, remove the retaining spring by grasping the end of the spring with the bent tip (right).



BENT TIP OF SPRING



5. Remove both the retaining spring and the gobo from the gobo holder.



6. Place the new gobo in the gobo holder with the black side facing downward. Re-install the retaining spring with the un-bent end of the spring in contact with the gobo.

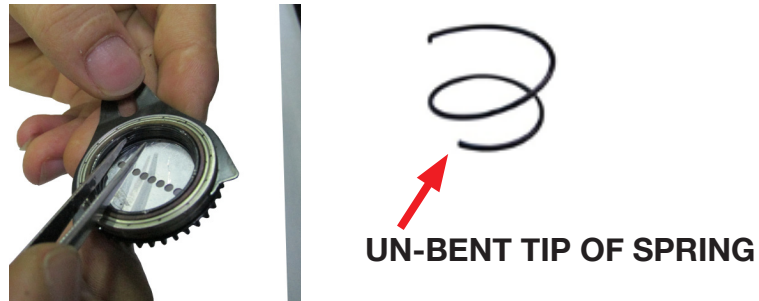

7. Turn the gobo holder over so that the black geared side is facing you. Rotate the geared portion of the gobo holder until the mark on the face of the geared portion is aligned with the clip of the gobo holder.

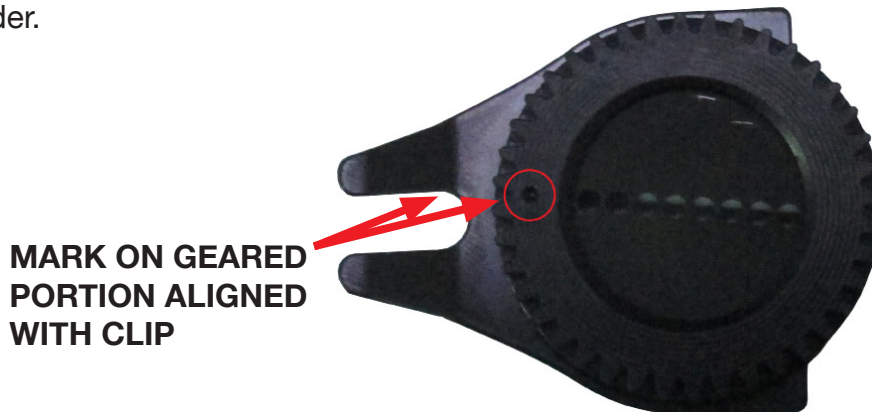

8. Locate the large gear on the gobo wheel that meshes with the geared parts of the gobo holders. Rotate the gobo wheel to turn this large gear until the small, circular magnet on this large gear is pointing outwards.

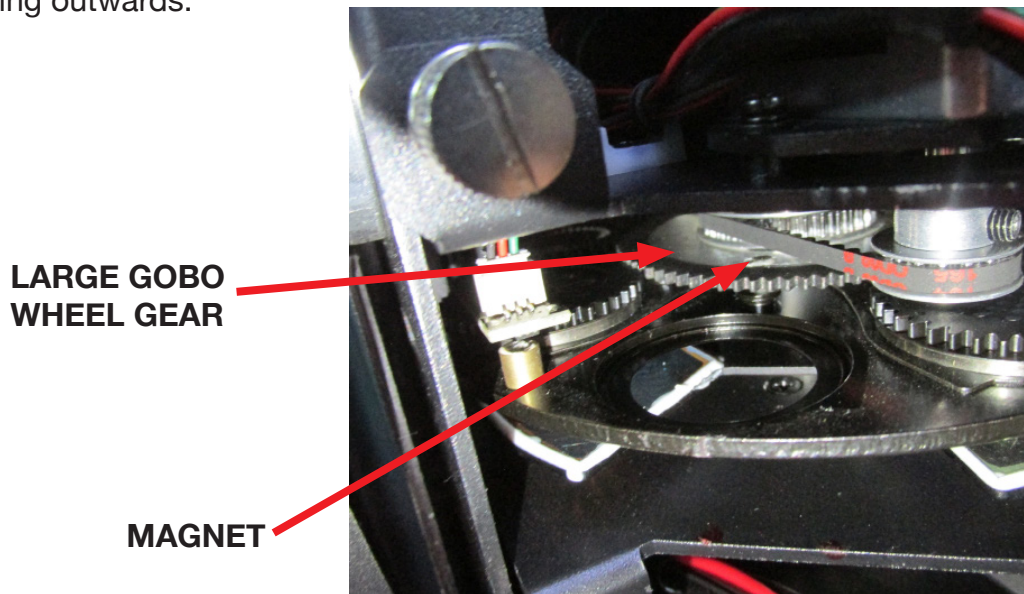

9. Making sure that the mark on the geared portion of the gobo holder is still aligned with the gobo holder clip, insert the clip of the gobo holder onto the attachment point on the gobo wheel. You should hear an audible click as the gobo holder snaps into place.

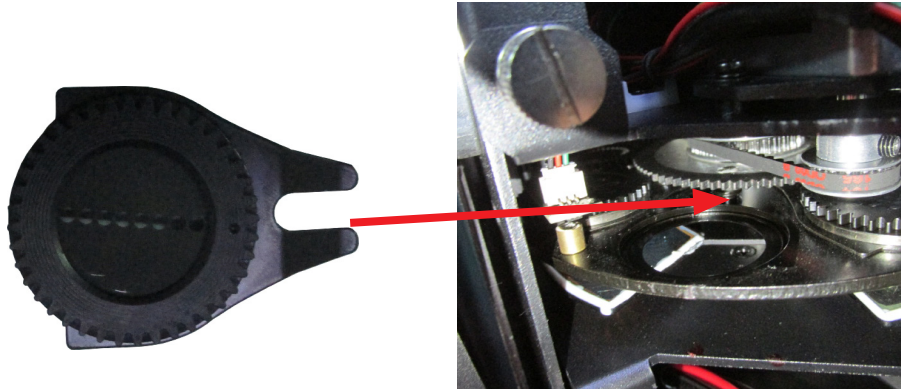

10. Gently push the gobo holder upwards from below, until the silver portion of the gobo holder clears the surface of the gobo wheel. Hold the gobo holder in this position and rotate the gobo holder so that the mark on the black geared portion is aligned with the small circular magnet on the large gobo wheel gear.

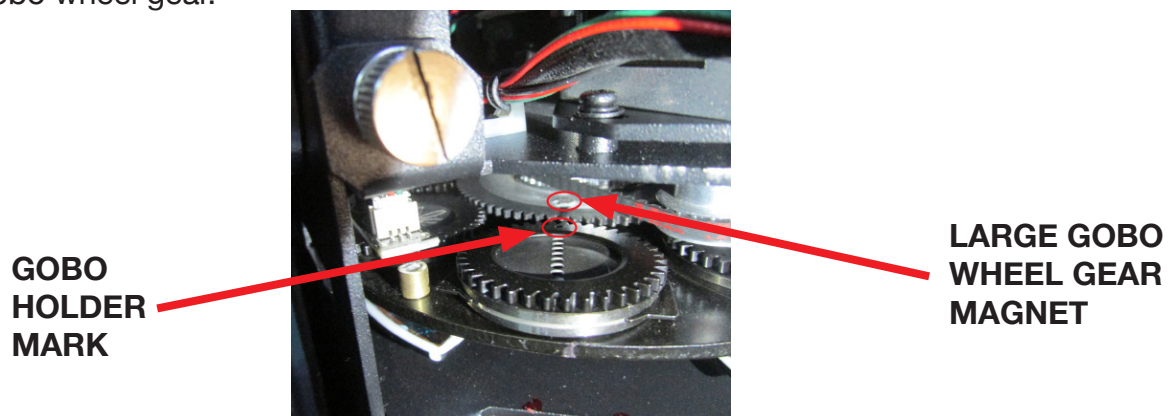





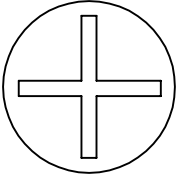

11. Re-attached the safety clip from the cover to the attachment point at the base of the head. Put the cover back in place and tighten the four (4) screws to secure the cover in place.

12. Power the fixture on. Calibrate the newly installed gobo by going to the following location:

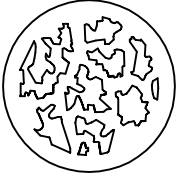
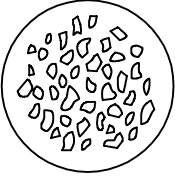
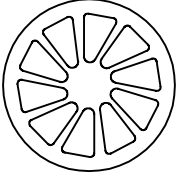
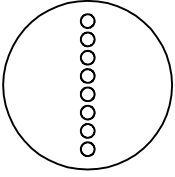
Personality > Service > Effect Adjust.

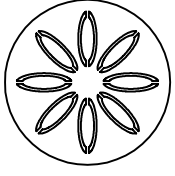
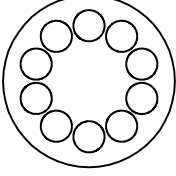
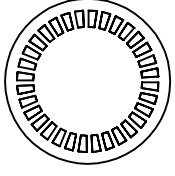
Select the gobo that was just replaced to calibrate. “Gobo1Rot1” represents Gobo Wheel 1, Gobo 1 Rotation; “Gobo1Rot2” represents Gobo Wheel 1, Gobo 2 Rotation, etc. Refer to the **Gobos** section for the assigned value of each gobo as installed by the factory.

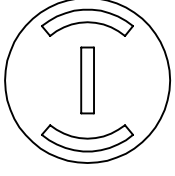
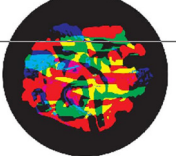
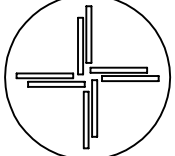
GOBO WHEEL 1		GOBO WHEEL 2	
Gobo No.	Pattern	Gobo No.	Pattern
1		1	
2		2	
3		3	
4		4	
5		5	
6		6	
7		7	

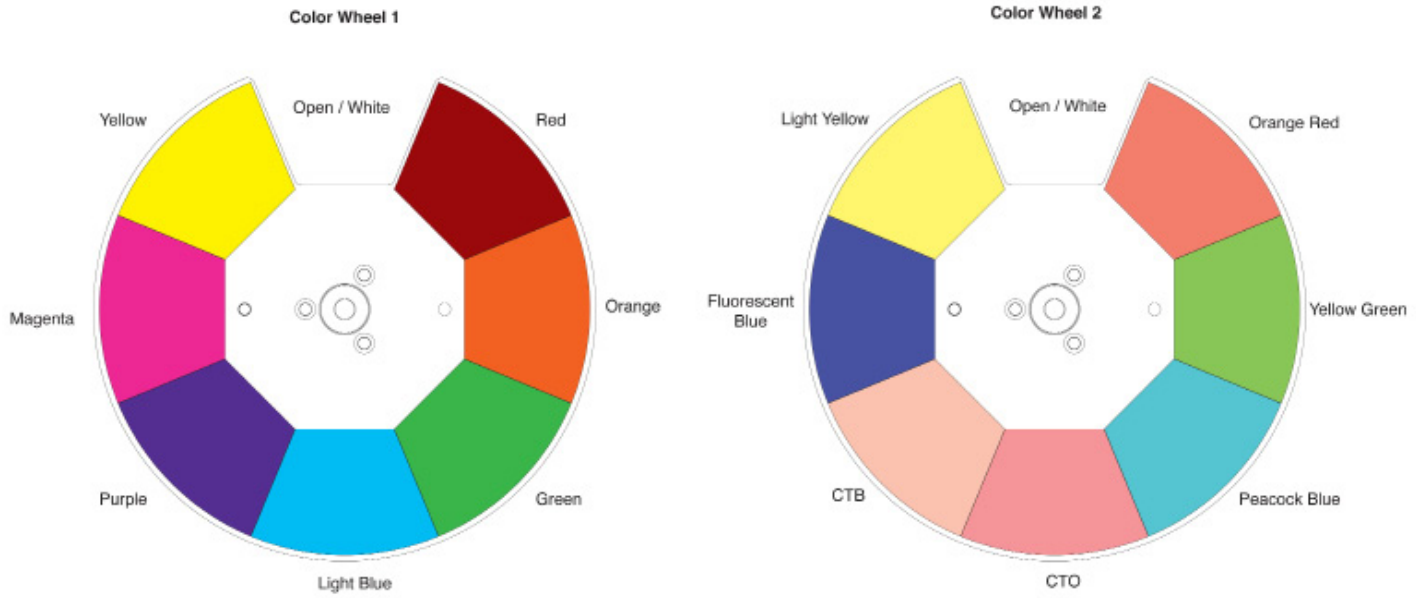

Unplug the unit from any power source it may be connected to. Once the power has been disconnected, use a flat head screw driver to unscrew the fuse holder located next to the Power In port. Remove the bad fuse and replace with a new one, and screw the fuse holder back in. **Replace only with a new fuse of the same type and rating.**

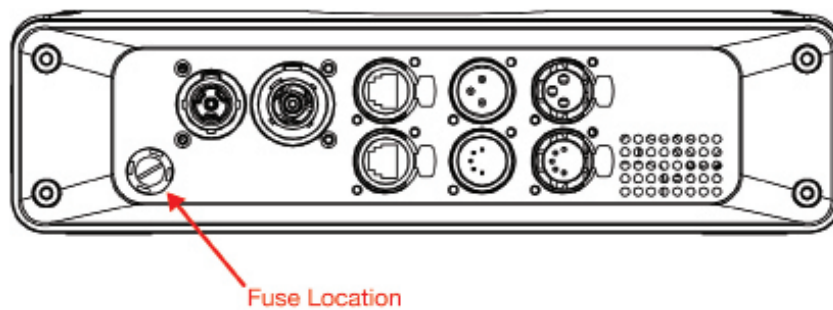

With this feature you can connect the fixtures to one another using the power cable input and output sockets.

NOTE: USE CAUTION WHEN POWER LINKING OTHER FIXTURES AS THE POWER CONSUMPTION OF OTHER MODEL FIXTURES MAY EXCEED THE MAX POWER OUTPUT ON THIS FIXTURE! CHECK SILK SCREEN FOR MAX AMPS.

Listed below are a few common problems the user may encounter, with solutions.

Unit not responding to DMX:

Check that the DMX cables are connected properly and are wired correctly. Also, check that all cables are connected to the right connectors, as connecting the inputs and outputs in the correct order is crucial for proper operation.

Due to fog residue, smoke, and dust, cleaning the internal and external optical lenses must be carried out periodically to optimize light output.

- Use normal glass cleaner and a soft cloth to wipe down the outside casing.
- Clean the external optics with glass cleaner and a soft cloth every 20 days.
- Always be sure to dry all parts completely before plugging the unit back in.
- Cleaning frequency depends on the environment in which the fixture operates. Heavy exposure to smoke, fog residue, dust, dew, etc. may mean that more frequent cleaning is required.

ONLY QUALIFIED TECHNICIANS SHOULD PERFORM THIS FUNCTION! NOTE ALL MENU SETTINGS BEFORE UPDATING SOFTWARE!

FIXTURE SOFTWARE CAN NOT BE DOWNGRADED!

DOWNLOAD FIXTURE SOFTWARE TO PC ONLY! (NO MAC SUPPORT) PLEASE CONTACT ADJ CUSTOMER SERVICE FOR FURTHER INFORMATION.

1. Contact ADJ customer service to obtain the updated software. Download to a USB flash drive. In order to minimize the risk of downloading the incorrect software to your device, make sure that the desired update files are the only files on the USB flash drive.
2. Disconnect any DMX connections from your device. Insert the USB flash drive into the service port on your device.
3. Use the display screen control panel to navigate to Personality > Service > USB Port Power. See the **System Menu** section for detailed instructions. Enter the passcode when prompted, and switch the USB Port Power setting to ON.
4. Highlight the desired file and press **ENTER** to select it and begin the download.
5. The unit will then update, run an automatic software check, and reset. This may take some time.
6. Repeat this process for each software update file.
7. Verify by navigating to Information > Software Version and confirming that the correct software version number is shown there (see the **System Menu** section for detailed instructions).

MANUFACTURER'S LIMITED WARRANTY

- A. ADJ Products, LLC hereby warrants, to the original purchaser, ADJ Products, LLC products to be free of manufacturing defects in material and workmanship for a prescribed period from the date of purchase (see specific warranty period on reverse). This warranty shall be valid only if the product is purchased within the United States of America, including possessions and territories. It is the owner's responsibility to establish the date and place of purchase by acceptable evidence, at the time service is sought.
- B. For warranty service you must obtain a Return Authorization number (RA#) before sending back the product—please contact ADJ Products, LLC Service Department at 800-322-6337. Send the product only to the ADJ Products, LLC factory. All shipping charges must be pre-paid. If the requested repairs or service (including parts replacement) are within the terms of this warranty, ADJ Products, LLC will pay return shipping charges only to a designated point within the United States. If the entire instrument is sent, it must be shipped in its original package. No accessories should be shipped with the product. If any accessories are shipped with the product, ADJ Products, LLC shall have no liability whatsoever for loss of or damage to any such accessories, nor for the safe return thereof.
- C. This warranty is void if the serial number has been altered or removed; if the product is modified in any manner which ADJ Products, LLC concludes, after inspection, affects the reliability of the product; if the product has been repaired or serviced by anyone other than the ADJ Products, LLC factory unless prior written authorization was issued to purchaser by ADJ Products, LLC; if the product is damaged because not properly maintained as set forth in the instruction manual.
- D. This is not a service contract, and this warranty does not include maintenance, cleaning or periodic check up. During the period specified above, ADJ Products, LLC will replace defective parts at its expense with new or refurbished parts, and will absorb all expenses for warranty service and repair labor by reason of defects in material or workmanship. The sole responsibility of ADJ Products, LLC under this warranty shall be limited to the repair of the product, or replacement thereof, including parts, at the sole discretion of ADJ Products, LLC. All products covered by this warranty were manufactured after August 15, 2012, and bear indentifying marks to that effect.
- E. ADJ Products, LLC reserves the right to make changes in design and/or improvements upon its products without any obligation to include these changes in any products theretofore manufactured.

No warranty, whether expressed or implied, is given or made with respect to any accessory supplied with products described above. Except to the extent prohibited by applicable law, all implied warranties made by ADJ Products, LLC in connection with this product, including warranties of merchantability or fitness, are limited in duration to the warranty period set forth above. And no warranties, whether expressed or implied, including warranties of merchantability or fitness, shall apply to this product after said period has expired. The consumer's and/or Dealer's sole remedy shall be such repair or replacement as is expressly provided above; and under no circumstances shall ADJ Products, LLC be liable for any loss or damage, direct or consequential, arising out of the use of, or inability to use, this product.

This warranty is the only written warranty applicable to ADJ Products, LLC Products and supersedes all prior warranties and written descriptions of warranty terms and conditions heretofore published.

MANUFACTURER'S LIMITED WARRANTY PERIODS:

- **Non L.E.D. Lighting Products = 1-year (365 days) Limited Warranty** (Such as: Special Effect Lighting, Intelligent Lighting, UV lighting, Strobes, Fog Machines, Bubble Machines, Mirror Balls, Par Cans, Trussing, Lighting Stands etc. excluding LED and lamps)
- **Laser Products = 1 Year (365 Days) Limited Warranty** (excluding laser diodes which have a 6 month limited warranty)
- **L.E.D. Products = 2-year (730 days) Limited Warranty** (excluding batteries which have a 180 day limited warranty).
Note: 2 Year Warranty only applies to purchases within the United States.
- **StarTec Series = 1 Year Limited Warranty** (excluding batteries which have a 180 day limited warranty).
- **ADJ DMX Controllers = 2 Year (730 Days) Limited Warranty**

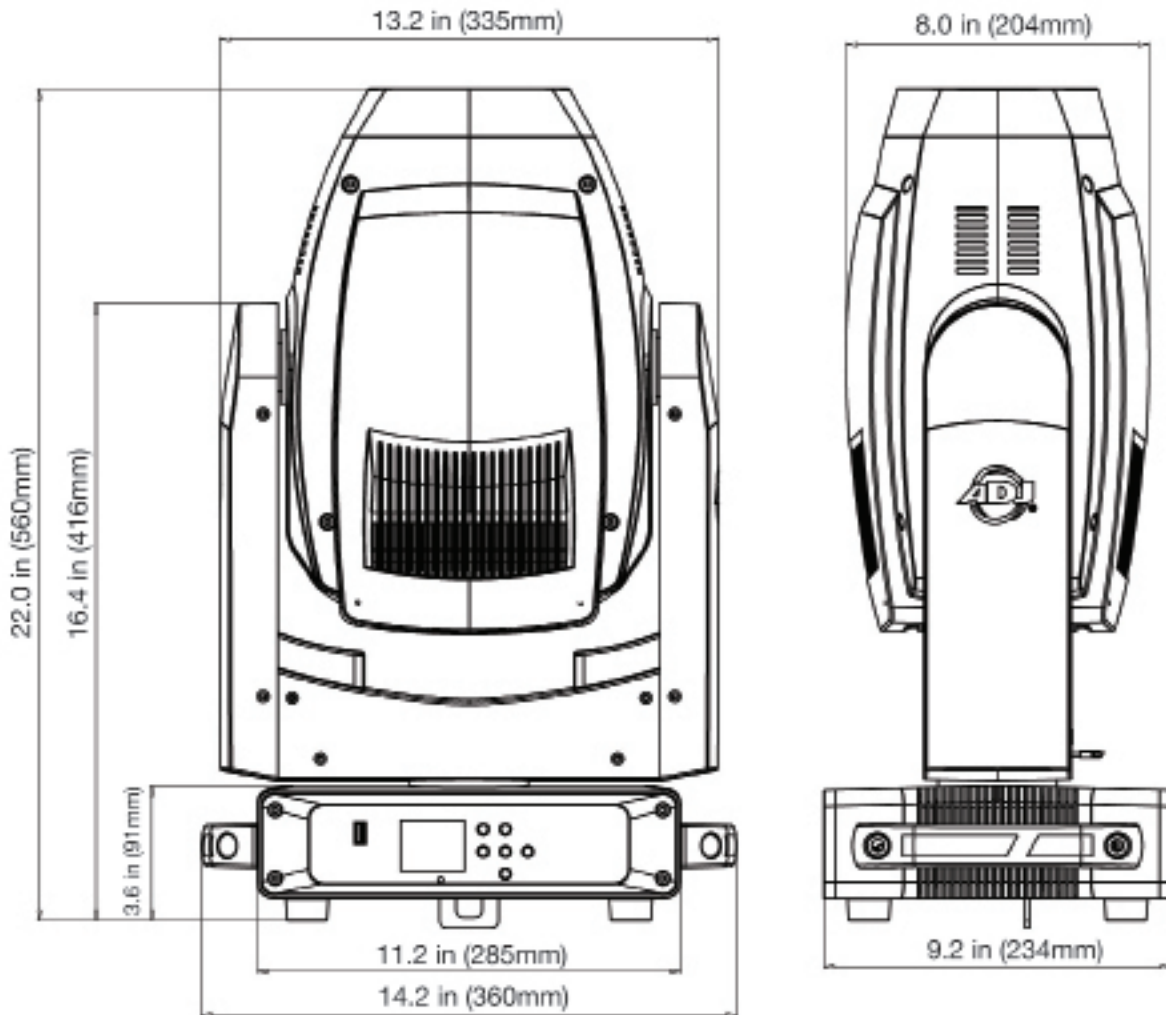

Drawings may not be to scale.

Light Source:

- 300W Cool White LED Engine (50,000 hr.)

Features:

- Motorized Focus
- 2 Frost Filter to create wash effects
- Motorized Zoom: 9~28-degrees
- 2 Prism FX: Rotating 6-facet Linear & rotating 6-facet Circular
- Motorized Iris
- Motorized Shutter
- GOBO Morphing
- 0-100% smooth dimming
- Various strobe speeds
- USB firmware update port

Color Wheels:

- Color Wheel 1: 7 dichroic colors + white
- Color Wheel 2: 7 dichroic colors (includes CTO & CTB)

GOBO Wheels:

- GOBO Wheel 1: 7 GOBOS + open
- GOBO Wheel 2: 7 GOBOS + open
- GOBO Morphing
- GOBO Shake Effect
- Metal GOBO Size: 23mm (outer), 19mm (viewable), 0.5mm (thickness)
- Glass GOBO Size: 23mm (outer), 19mm (viewable), 1.6mm (thickness)

Prism Wheel:

- Prism Wheel 1: Rotatable 6-facet Linear
- Prism Wheel 2: Rotatable 6-facet Circular
- Each Prism is indexable

Frost Filters:

- Frost 1: Heavy frost for wash effect
- Frost 2: Light frost creates lightly blurred edges for GOBO and Prism FX

Control:

- 3 DMX Channel Modes: 21/25/29 Channels
- Color LCD display with 6-button function menu
- Control Mode: DMX512 or internal programs
- 6 Dimming Curve Modes: Standard, Stage, TV, Architectural, Theatre, Stage 2
- 0-100% smooth dimming
- Various strobe speeds
- USB firmware update port
- With Wired Digital Communication Network

Pan/Tilt:

- Pan: 540/630 degrees
- Tilt: 270 degrees
- 16-bit fine Pan & Tilt
- Pan & Tilt locks

Connections:

- DMX Connections: 3-pin & 5-pin XLR In/Out
- Power Connections: PowerLock In/Out to daisy chain power
- RJ45 In/Out connections for Art-Net & sACN control

Electrical:

- Multi-voltage operation: AC 90-240V, 50/60Hz
- Max power consumption: 380W

Dimensions & Weight:

- Dimensions (LxWxH): 14.18" x 9.21" x 22.04" / 360 x 234 x 560mm
- Weight: 42.4 lbs. / 19.4 kg.

Please Note: Specifications and improvements in the design of this unit and this manual are subject to change without any prior written notice.

