

ECM

UHF



USER'S MANUAL

ANY SPOT[®]

WIRELESS MICROPHONE SYSTEM

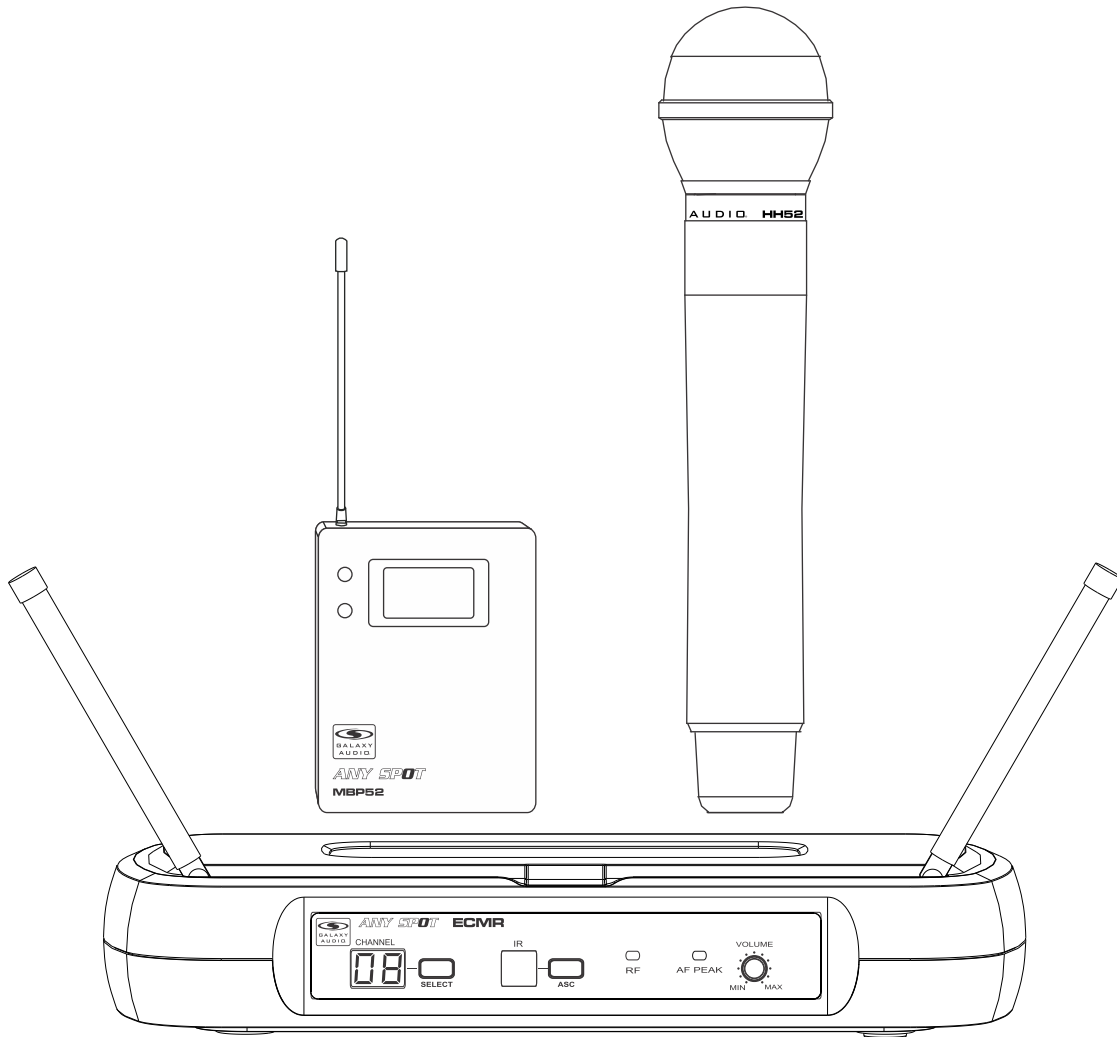

MAKERS OF THE ORIGINAL
HOT SPOT PERSONAL MONITOR

System Components

All ECM systems include the following components:

- ECMR Receiver
- One 1/4" Audio Cable
- Power Adapter
- Quick Start Guide

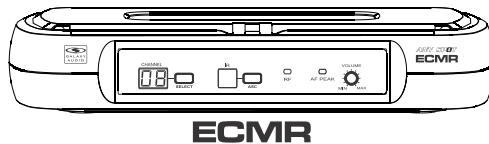

ECMR

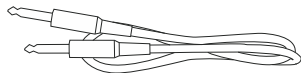

**1/4" to 1/4"
Audio Cable**

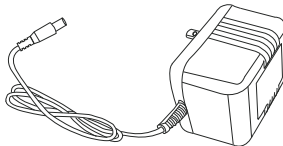

**PS-13.5-.35.5
Power
Adaptor**

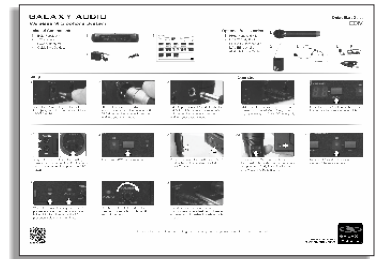

Quick Start Guide

Handheld Microphone Systems:
HH52 Handheld Transmitter

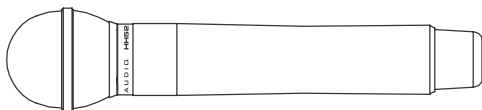

HH52

Lavalier/Headset/Guitar Systems:
MBP52 Body Pack Transmitter
Microphone (choice of Lavalier,
Headset, or Guitar Cable)

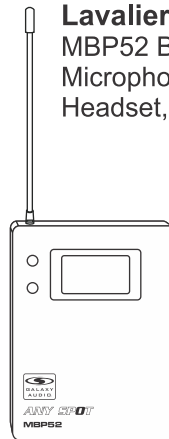

MBP52

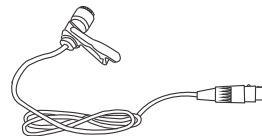

LV-U3BK

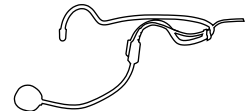

HS-U3BK



AS-GTRVE

**Replacement parts can be purchased
at www.galaxyaudio.com**

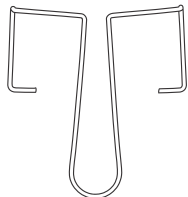

AS-CLIP911R
Belt Clip
for MBP52

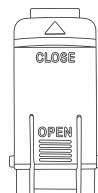

BATTCLR11005264
Battery Cover
for MBP52

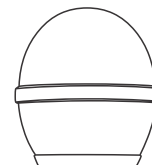

WS-GR52
Mesh Grill Cover
for HH52

Front Panel

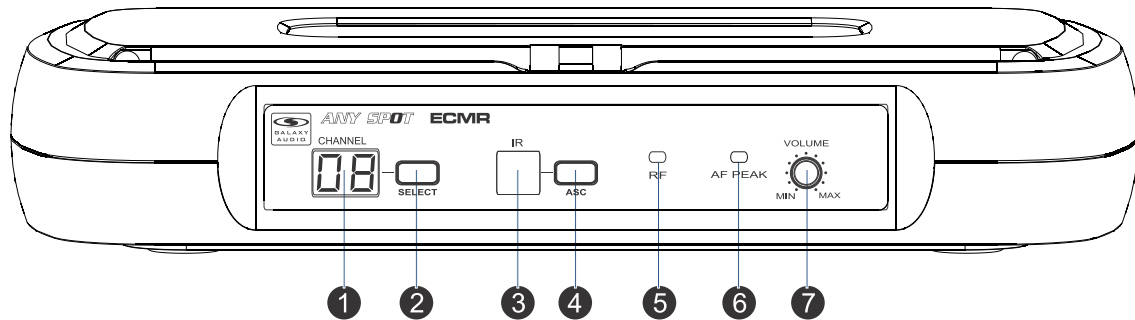

- ① Channel Display. Displays selected Channel.
- ② Channel select button
- ③ IR Window. Unit sends Infrared Signal to the Transmitter through this Window for Frequency Synchronization.
- ④ ASC Synchronizing Signal Transmit Button. Press this Button to establish Infrared connection between the Receiver and Transmitter.
- ⑤ RF Signal LED
- ⑥ Audio LED. Indicates a peak Audio Signal.
- ⑦ Audio Output Level Control. Left turn for Output Level Decrease, right turn for Output Level Increase.

Rear Panel

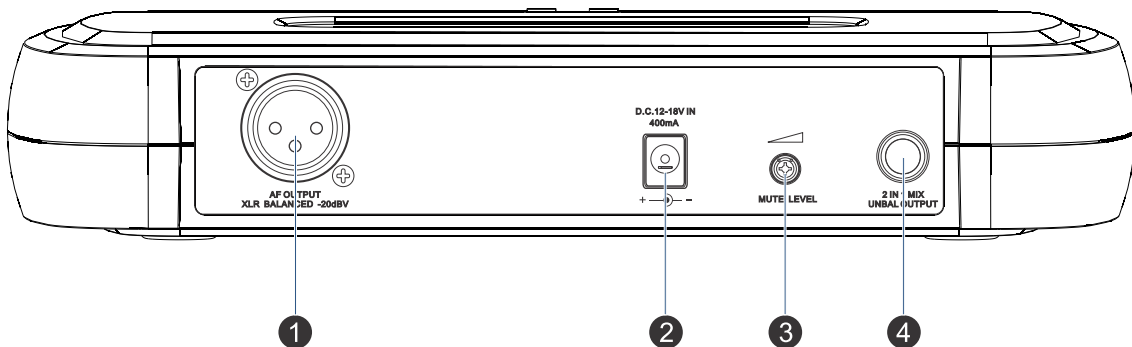

- ① AF Audio Output.
- ② Power Adapter Jack.
- ③ AF Output fine adjustment of Mute Threshold Level. This is factory set and usually does not need to be adjusted. If interference signals are present, this Threshold Value can be Increased by turning the knob Clockwise until RF Signal LED goes out.
- ④ 1/4" Audio Output.

HH52/HH52SC Handheld Transmitter

Functions:

- ① Microphone Head.
- ② Gain (Sensitivity) Control.
Turn Left to Decrease Sensitivity.
Turn Right to Increase Sensitivity.
- ③ RF Power Level Switch.
H for High Level RF Power.
L for Low Level RF Power.
- ④ IR Window.
Receives Infrared signal to synchronize frequencies
between Receiver and Transmitter.
- ⑤ Battery Tray.
- ⑥ Power/ASC/Low Battery Indicator.
Green: Power On.
Flashing Green: IR Transmission in progress.
Red: Batteries Low.
- ⑦ Power On/Off Switch.

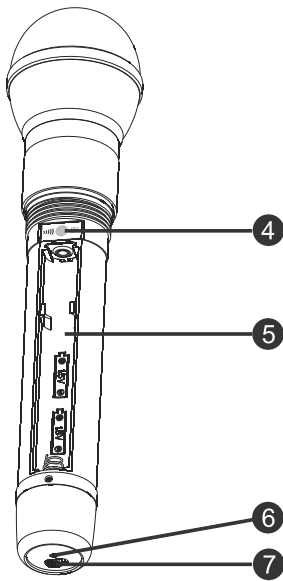
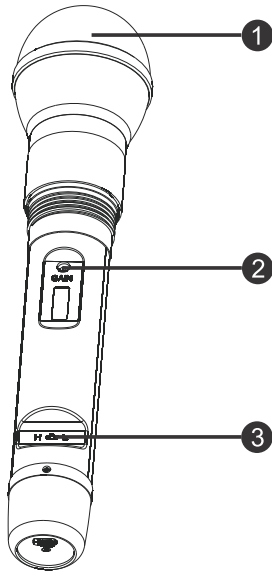

Changing Batteries:

Unscrew cover to access the Battery Tray. Observe correct polarity markings when installing Batteries. Expected life for two alkaline batteries is about 8 hours.

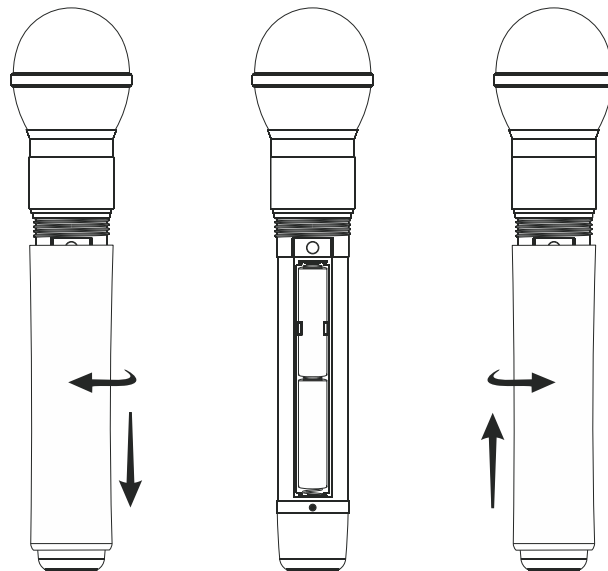

MBP52 Bodypack Transmitter

Functions:

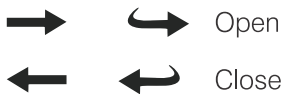
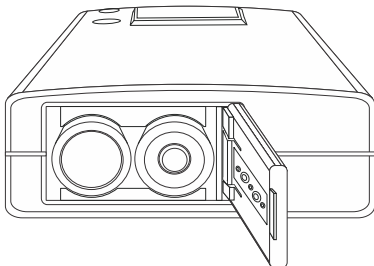
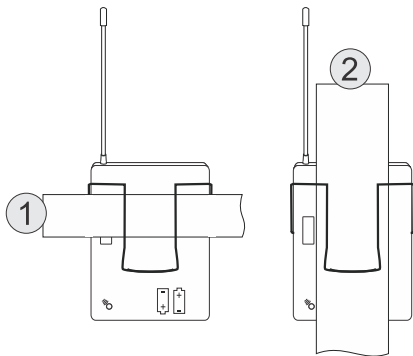
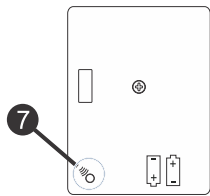
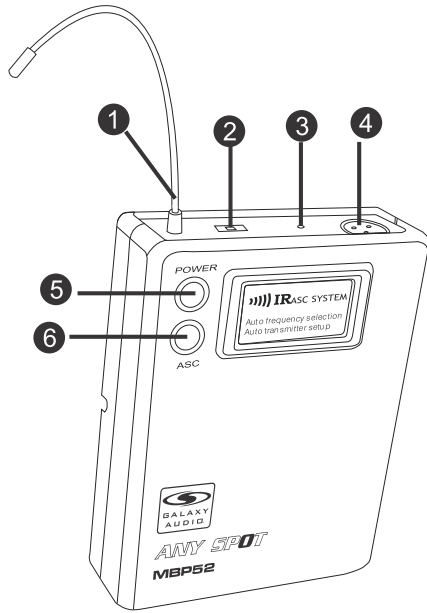

1 Antenna.

2 Input Gain Switch.

There are three Gain settings. Select the setting most suitable to your application.
Mic.: Microphone Level.
0: Guitar Level.
-10dB: Line Level.

3 Power/Low Battery/IR Transmission LED.

Green: Power On, Batteries OK.
Flashing Red: Low Batteries.
Flashing Green: IR transmission in Progress.

4 3-pin Input Jack.

5 Power Button.

Press and Hold to switch Power On/Off.

6 ASC Automatic Frequency Synchronization.

Press this button to establish Infrared connection between the Transmitter and Receiver.

7 IR Window.

This window receives the Infrared signal during ASC.

How to Wear the MBP52 Transmitter:

Slide the transmitter clip onto the belt ①, or run a guitar strap through the transmitter clip ②, as shown in the diagram at left.

Battery Replacement:

Slide open the Battery Door as shown. Install Batteries while observing correct polarity markings.

The life expectancy of two alkaline batteries is about 8 hours.



ECM Receiver Setup:

Group and Channel Selection

Press Channel UP or Channel DOWN buttons to select desired Channel. For best results when operating multiple systems, set every channel to achieve the maximum distance between channels.

Receiver Volume Control:

Turn Left for Output Level decrease, turn Right for Output Level increase.

Mute Level Threshold Adjustment:

The Mute Level is factory set and normally needs no adjustment. However, you may turn clockwise if interference is present.

Automatic Transmitter Setup (ASC):

Remove the access cover on the Handheld Transmitter. Point the IR Window of the Handheld towards the IR Window on the Receiver and press the ASC button.

Point the MBP52 Body Pack IR Window towards the Receiver IR Window, then press the ASC buttons on both the Transmitter and Receiver.

The Receiver transmits sync frequencies for 25 seconds each time you press the "ASC" button.

Whenever the ASC button on the MBP52 is pressed, the synchronizing signal will be transmitted continually for 25 seconds.

Note: When establishing infrared connection between the receiver and the transmitter, the distance between them should not exceed 1.64ft (0.5m). When more than one system are used, only IR window of one transmitter should be pointed to the receiver for each infrared connection.

ECM Frequency Chart

ECM D CODE

1	584.400
2	587.500
3	589.575
4	591.050
5	593.425
6	595.200
7	598.450
8	599.650
9	601.275
10	603.775
11	605.500
12	606.750
13	586.025
14	590.525
15	594.150
16	602.450

ECM N CODE

1	518.625
2	519.900
3	520.525
4	521.950
5	523.700
6	524.575
7	526.075
8	531.200
9	531.950
10	534.025
11	535.250
12	537.200
13	538.200
14	539.650
15	540.075
16	541.475

ECM
Frequency Chart



<https://www.galaxyaudio.com/assets/uploads/media/MasterFrequency.pdf>

GALAXY AUDIO
Frequency Page



<http://www.galaxyaudio.com/support/schematics-and-frequency-charts>

ECM System

Available Channels: 16

Frequency Range: CODE D 584~607 MHz
CODE N 518~542MHz

Transmitter Output level: 10 dBm

Band: UHF

Operating Range Under Typical Conditions: 200' (61m)

Note: actual range depends on RF signal absorption, reflection, and interference.

Audio Frequency Response: (+/-3dB) 60Hz~16KHz

Total Harmonic Distortion (+/-30KHz deviation, 1KHz tone): <1%

Dynamic Range: >90dB A-weighted

Operating Temperature Range: 14°F to 122°F (-10° C to +50° C)

Note: battery characteristics may limit this range

MBP52 Bodypack Transmitter:

Audio Input Level: 0 dBV to +10dBV

Gain Adjustment Range: 20dB

Input Impedance: 5KΩ

Dimensions: 3.3" x 2.6" x 1" (85 x 65 x 24 mm) (HxWxD)

Weight: 3 oz (85 g) (without batteries)

Power Requirements: 2 AA Batteries alkaline or rechargeable batteries

Battery Life: About 8 hours

ECMR Receiver:

Audio Output Level: (+/-30KHz deviation, 1KHz tone)

XLR connector (into 600Ω load) -12dBV

1/4" connector (into 3KΩ load) -18dBV

Output Impedance: XLR connector 200Ω
1/4" connector 1KΩ

XLR output: Impedance balanced

Pin1: Ground (cable shield)

Pin2: Audio

Pin3: No Audio

Sensitivity: -93dBm for 30dB

Image Rejection: >90dB

Dimensions: 1.75" x 9.25" x 4.75" (44.45 x 235 x 121 mm)(HxWxD)

Weight: 0.85 lb (0.39 kg)

Power Requirements: 13.5 V dc at 300mA, supplied by external power supply.

HH52 Handheld Transmitter:

Max Audio input level: 0dBV

Dimensions: 9.8" x 2.1" (250 x 53 mm)(LxDia.)

Weight: 9.5 oz (270 g) (without batteries)

Power Requirements: 2 "AA" size alkaline or rechargeable batteries

Battery Life: About 8 hours

DTV Frequency Ranges & FCC Consumer Alert

Wireless Tips

Maintain line of sight between the transmitter and receiver antennas.

Do not have walls, metal objects, large crowds, etc. blocking the line of sight between the transmitter and receiver.

Antennas on the stationary equipment should be kept several feet above the ground.

Antennas can be mounted on stands or walls using brackets such as the ANT-LB.

On body pack receivers/transmitters, avoid putting them in your pocket, and/or folding the antenna under the pack. The antenna should hang freely and openly.

Keep the distance between transmitters and receivers as short as possible.

If distances above 20-30' are unavoidable, directional antennas such as the ANT-PDL can improve reception by rejecting signals outside their pickup angle.

Find out what TV stations are broadcasting in your area and avoid the channels they are on.

This information is available from many sources on line, such as www.tvfool.com.

If your receiver is showing that it is receiving RF when your transmitter is turned off, you need to move to another frequency.

If you are using several systems, you can contact service@galaxyaudio.com for assistance in frequency coordination.

Make certain you are using fresh batteries, rechargeable batteries may be used, but they discharge at a much faster rate than alkaline.

The frequencies of the Galaxy UHF Wireless Systems are on frequencies that are used by Digital Television stations.

To be assured of the best performance, you should determine on what RF channels the DTV stations in your area are broadcasting, then set your wireless systems on frequencies that are not being used.

You can find that information on this FCC web site. <https://www.fcc.gov/media/engineering/dtvmaps>

Enter the zip code of the location where the wireless system will be used into the location search bar. A list of stations in that area will be listed. Click on the call sign of the stations and the details will appear, showing you the RF channel the TV station is using. Compare these with the chart to the left, and using the Galaxy frequency charts on page 5, find a frequency that is not on an active DTV RF channel.

For example, if you have an L-Band ECMR and your location has DTV stations on RF channels 45 and 48, you will want to set your ECMR on a frequency that is on RF channel 46 or 47.

FCC Consumer Alert for Wireless Microphones (U.S.)

Most users do not need a license to operate this wireless microphone system. Nevertheless, operating this microphone system without a license is subject to certain restrictions: the system may not cause harmful interference; it must operate at a low power level (not in excess of 50 milliwatts); and it has no protection from interference received from any other device. Purchasers should also be aware that the FCC is currently evaluating use of wireless microphone systems, and these rules are subject to change.

For more information, call the FCC at 1-888-CALL-FCC (TTY: 1-888-TELL-FCC) or visit the FCC's wireless microphone website at www.fcc.gov/cgb/wirelessmicrophones

DTV RF Channel	Frequency Range
14	470-476
15	476-482
16	482-488
17	488-494
18	494-500
19	500-506
20	506-512
21	512-518
22	518-524
23	524-530
24	530-536
25	536-542
26	542-548
27	548-554
28	554-560
29	560-566
30	566-572
31	572-578
32	578-584
33	584-590
34	590-596
35	596-602
36	602-608
37	608-614
38	614-620
39	620-626
40	626-632
41	632-638
42	638-644
43	644-650
44	650-656
45	656-662
46	662-668
47	668-674
48	674-680
49	680-686
50	686-692
51	692-698



MAKERS OF THE ORIGINAL
HOT SPOT PERSONAL MONITOR



www.galaxyaudio.com

THREE YEAR LIMITED WARRANTY

WARRANTY Information can be viewed online at
<https://www.galaxyaudio.com/support/warranty>



www.galaxyaudio.com/support/warranty

ECM USER'S MANUAL

Specifications in this manual are subject to change without notice.
For the most up to date manual and information
visit www.galaxyaudio.com.

1-800-369-7768 www.galaxyaudio.com

© Copyright Galaxy Audio 2019