



VP7212/64DP

Powered 12"
2-Way Integrated
Loudspeaker System

VP7212/64DP-AN (Optional network input module)

VP7212/64DP-CN (Optional network input module with digital audio)

Key Features:

- ▶ Powered bi-amplified full-range loudspeaker with JBL DrivePack® technology for portable or installed use
- ▶ 2200 watts peak output power, 1100 watts continuous
- ▶ 12-inch Differential Drive® low-frequency driver for extended low-frequency output
- ▶ 60° x 40° coverage
- ▶ Stylized and ergonomically designed powder-coated die cast aluminum handles
- ▶ Six 3-inch fly track suspension points and fourteen M10 fittings (optional detachable flying fittings and forged eye bolt kits available)
- ▶ Optional DPAN or DPCN (CobraNet™) digital audio input modules available for HiQnet™ network control



Applications:

- ▶ High-impact audio/visual presentations
- ▶ Theatrical sound design
- ▶ Houses of Worship
- ▶ Sound reinforcement rental companies
- ▶ Live performance venues
- ▶ Performing arts centers
- ▶ Corporate learning centers
- ▶ Themed entertainment venues

The VP7212/64DP is a powered 12" 2-way integrated loudspeaker system featuring 2200 watts of peak output power, 1100 watts continuous, and onboard digital signal processing. Designed in cooperation with Crown International, the JBL DrivePack® DP-2 features leading-edge technology such as patented high efficiency Class-I power amplifier technology. Network control and monitoring is optionally available via *System Architect* software.

VP7212/64DP transducers are JBL's 2262G 12" diameter Differential Drive® woofer and the JBL 2452H-SL large format 1.5" exit compression driver. The high frequency driver is coupled to a JBL PT-H64HF Progressive Transition (PT) Waveguide for excellent 60° x 40° pattern control, smooth frequency response, and low distortion. Easily rotated for horizontal or vertical system orientation.

Specifications:

Frequency Response (+/-3 dB):	63 Hz - 18 kHz
Frequency Range (-10 dB):	47 Hz - 20 kHz
Coverage Pattern:	60° x 40° rotatable waveguide
Directivity Factor (Q):	15.8
Directivity Index (DI):	12 dB
Maximum Peak Output ¹ :	136 dB SPL 1m
Transducer Section:	
Low Frequency Section:	JBL 2262G, 304 mm (12 in) dia., 76 mm (3 in) Dual Coil neodymium Differential Drive®, Direct Cooled
Bandpass Nominal Impedance:	4 ohms
High Frequency:	JBL2452H-SL, 100mm (4 in) titanium damped diaphragm, 1.5 in. exit.
Bandpass Nominal Impedance:	8 ohms
System:	
DP2 Internal Amplification Output (at nominal load)	2200 Watts Peak, 1100 Watts Continuous
DP2 Output (Continuous IEC shaped pink noise into rated load impedance):	750LF/350HF Watts
DP2 Output Section:	2-Channel, Class I
Audio Input connector	XLR with loop-through
Network control connector	Ethernet, RJ45 (DPAN, DPCN options)
Signal Processing:	DSP based, resident in Input Module. See page 2 For input module specifications.
System Management:	DSP based limiters for mechanical and thermal protection
AC Power Operating Range:	Auto Select 90-132VAC/216-264VAC, 50/60 Hz
AC Line Voltage:	50/60 Hz, Auto-Detect; 120V/240V (-15%, +10%)
AC Input Connector:	Neutrik PowerCon (NAC 3MPA)
AC Loop-thru:	Neutrik PowerCon (NAC 3MPB)
AC Current Requirement:	6A per system at 120V, 3A per system at 240V
Enclosure:	
Box Construction:	5/8 in. multi-ply exterior grade Baltic birch. Internally braced. Black DuraFlex™ finish.
Suspension System:	6 standard air-cargo 3 in. track and 14 M10 fittings.
Grille:	14 Gauge Black powder-coated perforated steel with foam backing.
Dimensions (H x W x D):	701.8 x 383.8 x 523.5 mm 27.63 x 15.11 x 20.61 in.
Net Weight:	35.4 kg (78 lbs.)

¹Measured with IEC shaped noise in free field conditions.

▶ VP7212/64DP Powered 12" 2-Way Integrated Loudspeaker System

Input module characteristics and options

Features

Description	DPIP (standard input module) input module)	DPAN (optional HiQnet network input module)	DPCN (optional HiQnet network input module; digital audio)
HiQNet Compliant	No	Yes	Yes
Network Communication	No	100MB Ethernet	100MB Ethernet
Network Connections	N/A	RJ-45, CAT5	RJ-45, CAT5
Audio signal format	Analog	Analog	Digital with analog backup
CobraNet™ digital audio over ethernet	No	No	Yes
Level Controls	Attenuator, 16dB range	Network Controllable	Network Controllable
Remote Load Monitoring	No	Yes	Yes
User Assignable Filters	No	16	16
User Accessible Delays	No	Yes	Yes
Noise Generator	No	Pink, White	Pink, White
Sine Wave Generator	No	Continuous, Burst	Continuous, Burst
User Assignable Filter Types	None	9	9
Error Reporting	No	Yes, via software	Yes, via software
Digital Speaker Setting Presets	2, fixed	10, user assignable	10, user assignable
Polarity Reverse	No	Yes, via software	Yes, via software
Listen Bus line level remote monitor	No	No	Yes
Firmware upgrades via network	No	Yes	Yes
Mute	No	Remote via network	Remote via Network

Specifications

Analog Audio Input Connectors	XLR, female	XLR, female	XLR, female
Input Type	Electronically Balanced, RF Filtered		
Signal Loop-through	XLR, male, passive pass-through		
Input Impedance	20K Ohms Bal	20K Ohms Bal	20K Ohms Bal
Polarity	(+ voltage on XLR pin 2 yields (+) LF pressure		
Input Sensitivity at 1m	0 dBu: 122 dB spl 0 dBV: 120 dB spl (Input attenuator set at 0 dB)	0 dBu: 122 dB spl 0 dBV: 120 dB spl (Internal sensitivity set to +4dBu)	0 dBu: 122 dB spl 0 dBV: 120 dB spl (Internal sensitivity set to +4 dBu)
Max Input Level	+23 dBu		
Frequency Response	20 Hz – 20K Hz ± 0.5 dB		
DSP Processing	dbx Type IV analog-to-digital conversion circuitry	24 Bit conversion, 32 bit floating point processing	24 Bit conversion, 32 bit floating point processing
Dynamic Range (20-20 KHz)	> 107 dB (A Weighted)	> 110 dB (A Weighted)	> 110 dB (A Weighted)
THD+N (20-20 KHz), rated power	< 0.5%		
Crosstalk	> 60 dB @ 1kHz		
User Programmable Signal Delay	N/A	2 seconds	2 seconds
Front Panel Controls	Gain, Sub Filter Enable	Enable ALT Preset	Enable ALT Preset
Front Panel Indicators	Signal/clip, ready, thermal, fault, sub filter on/off	Signal/clip, ready, thermal, fault, alt. preset select, Network: activity, link	Signal/clip, ready, thermal, fault, alt. preset select, Network: activity, link, CobraNet conductor

JBL DrivePack® Software Control Panel

With optional HiQnet-compatible input modules installed, JBL DrivePack systems can be remotely controlled and monitored using *HiQnet System Architect*™ software. A Windows-based application, it provides an intuitive, unified platform for system configuration and operation of JBL DrivePack-equipped systems and any other HiQnet-compliant audio devices in the signal chain. *HiQnet System Architect* enables the unified layout of on-screen product control surfaces, and simple preset configuration of an entire system across multiple brands and product classes.

Advanced remote control and diagnostic capabilities, custom control panel creation, and the recall of presets on all connected HiQnet devices are included. In addition, the application enables a user to copy / paste like parameter values from, and to, multiple products across the HiQnet network.

HiQnet System Architect is available for download at harmanpro.com.

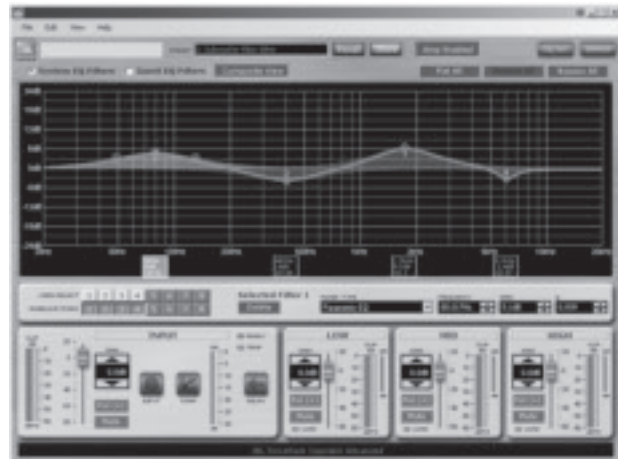

JBL DrivePack input modules are used to implement crossovers, equalization, time alignment, and protection for the attached speaker system. Speaker-dependent settings are not user-configurable from any version of the input module. The following options are available for connectivity, audio signal path and control functionality.

DPIP (Standard dbx Input Module)

JBL DrivePacks are equipped with a modular input bay and are available in several versions. The standard DPIP input module features analog audio inputs and sophisticated onboard digital signal processing technology. Precision bandpass limiting, pre-equalization filters and automatic self-test functions ensure optimized performance. Front panel controls include a 32-position detented rotary attenuator calibrated in 0.5 dB steps which provides a 16 dB range of control. This can be useful for setting up downfill shading or overall system gain structuring. Another feature is the “Enable Subwoofer Filter” button. This is a momentary-contact type switch which enables or disables the selected function. On subwoofer applications, the low-pass frequency is set to 80 Hz. For full-range systems used with subwoofers, the high-pass is raised to 80 Hz.



DPAN (Optional HiQnet Network Input Module with Analog Audio)

In addition to all of the features included on the standard input module, the DPAN adds 100 Mb Ethernet networking functionality and HiQnet compatibility. It enables remote control and monitoring via HiQnet System Architect™ software. Network Control and Monitoring is enabled by the JBL DP-SCP (DrivePack Software Control Panel) supplied within HiQnet System Architect. Network capabilities include monitoring of status, input and output levels, clipping, temperature, load faults and gain reduction. Additional control features available in software include load supervision, dynamic processing, ten internal pre-e.q.filter presets, delays, onboard noise and sine-wave generators, network device event logging, and user alert messaging.

 HiQnet™



DPCN (Optional HiQnet Network Input Module with Digital Audio)

In addition to all of the features included on the DPAN, the DPCN input module adds CobraNet™ to the mix and offers the ability to direct up to 64 audio channels on one network, with digital audio and remote control and monitoring via Ethernet combined on a single cable. DPCN includes the option to use an analog input as a backup audio source providing you complete reliability and flexibility to cover any situation. With HiQnet System Architect providing the software user interface, the HiQnet communications protocol provides remote access to digital speaker preset files in the JBL DrivePack. As with the DPAN, user-addressable features include ten internal pre-e.q. filter presets, up to 2 seconds of delay per channel, onboard noise and sine-wave generators, network device event logging, and user alert messaging.

 HiQnet™

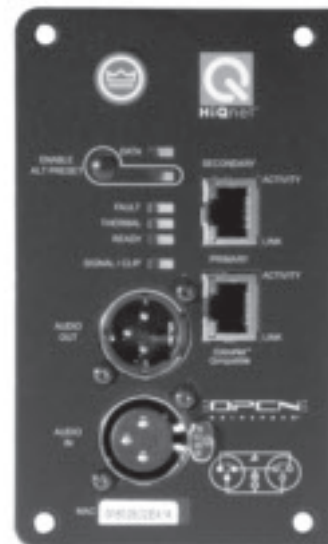

▶ VP7212/64DP Powered 12" 2-Way Integrated Loudspeaker System

Frequency Response

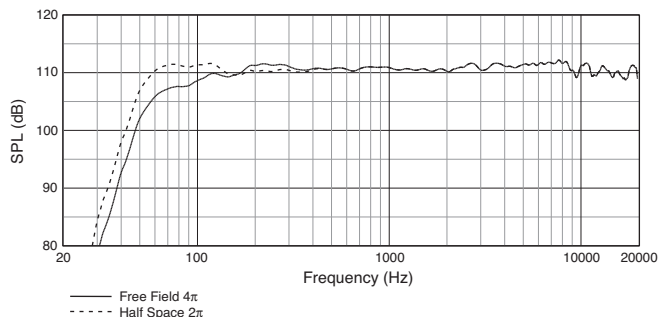

Horizontal Off-Axis Frequency Response

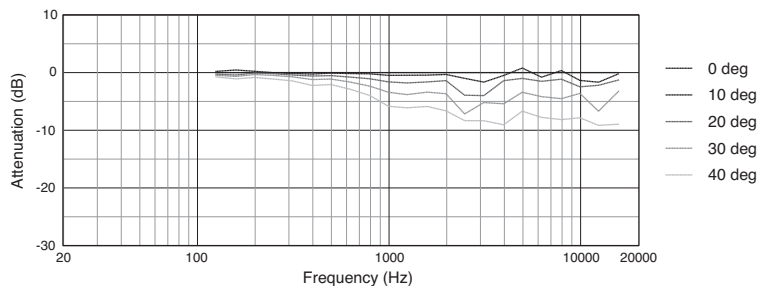

Beamwidth

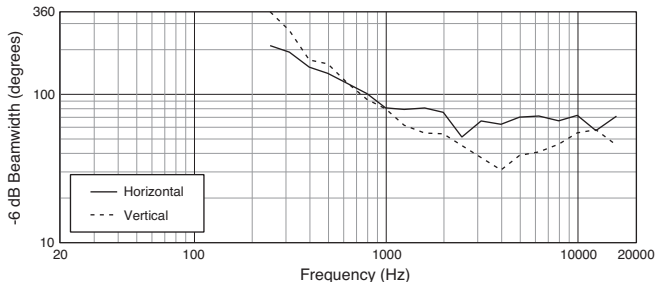

Vertical Off-Axis Frequency Response

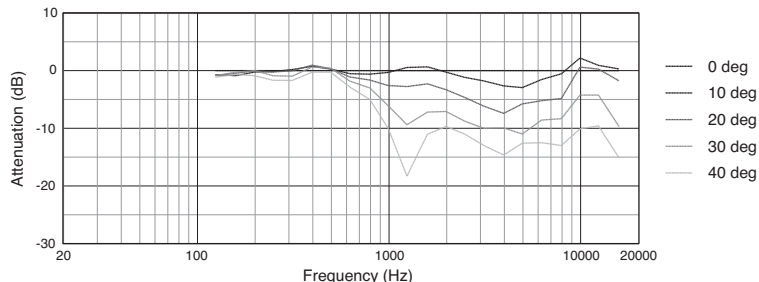

Directivity Index, Q

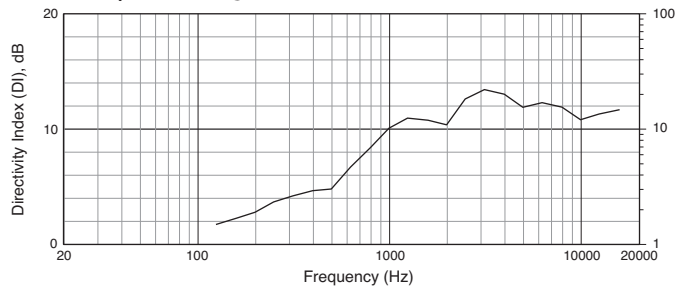

Vertical Down Off-Axis Frequency Response

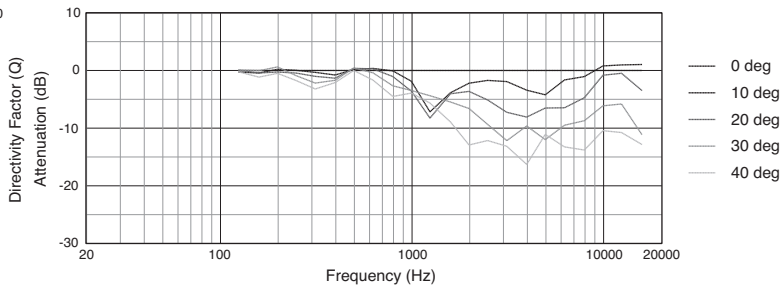

For a complete set of polar plots, EASE Acoustical Modeling Files, and DXF Format Drawing Files please visit: www.jblpro.com/pages/software_downloads.htm

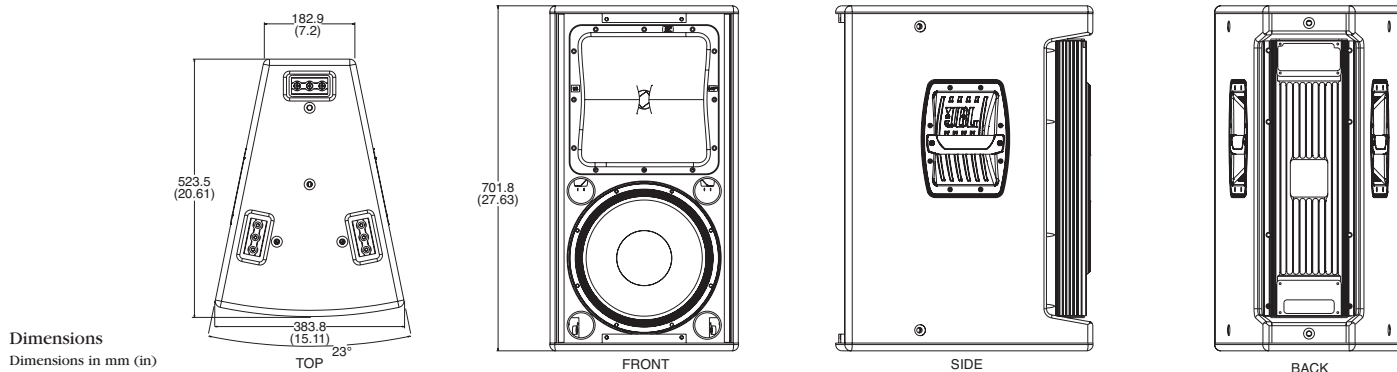

Accessories:

JBL offers a wide variety of accessories including rigging accessories and transport covers. Please visit www.jblpro.com for a complete list of VP Series accessories.



JBL Professional
8500 Balboa Boulevard, P.O. Box 2200
Northridge, California 91329 U.S.A.
A Harman International Company
© Copyright 2007 JBL Professional

VP SERIES
venue performance



SS VP7212/64DP
CRP 5M
01/07