

# AS-1800 UHF



## USER'S MANUAL

# ANY SPOT

## WIRELESS PERSONAL MONITOR

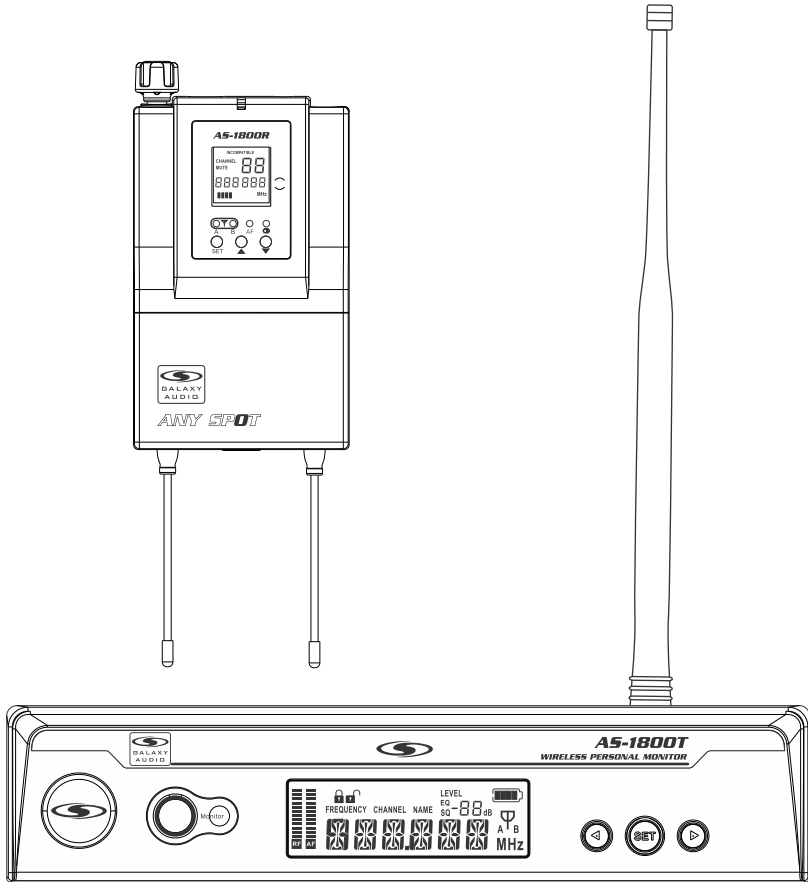

[www.galaxyaudio.com/AS1800.php](http://www.galaxyaudio.com/AS1800.php)



MAKERS OF THE ORIGINAL  
HOT SPOT PERSONAL MONITOR



USING THIS SYSTEM AT EXCESSIVE VOLUMES CAN CAUSE PERMANENT HEARING DAMAGE.  
USE AS LOW A VOLUME AS POSSIBLE.

**WARNING!**

In order to use this system safely, avoid prolonged listening at excessive sound pressure levels. Please use the following guidelines established by the Occupational Safety Health Administration (OSHA) on maximum time exposure to sound pressure levels before hearing damage occurs.

90 dB SPL at 8 hours	110 dB SPL at ½ hour
95 dB SPL at 4 hours	115 dB SPL at 15 minutes
100 dB SPL at 2 hours	120 dB SPL — avoid or damage may occur
105 dB SPL at 1 hour	

It is difficult to measure the exact Sound Pressure Levels (SPL) present at the eardrum in live applications. In addition to the volume setting on the Personal Monitors, the SPL in the ear is affected by ambient sound from floor wedges or other devices. The isolation provided by the fit of quality earpieces is also an important factor in determining the SPL.

Here are some general tips to follow in the use of this product to protect your ears from damage.

- Turn up the volume control only far enough to hear properly.
- Ringing in the ears may indicate that the gain levels are too high. Try lowering the gain levels.
- Have your ears checked by an audiologist on a regular basis. If you experience wax buildup in your ears, stop using the system until an audiologist has examined your ears.
- Wipe the ear molds with an antiseptic before and after use to avoid infections. Stop using the earphones if they are causing great discomfort or infection.

**! IMPORTANT SAFETY INSTRUCTIONS !**

1. READ these instructions.
2. KEEP these instructions.
3. HEED all warnings.
4. FOLLOW all instructions.
5. DO NOT use this apparatus near water.
6. CLEAN ONLY with dry cloth.
7. DO NOT block any ventilation openings. Install in accordance with the manufacturer's instructions.
8. DO NOT install near any heat sources such as radiators, heat registers, stoves, or other apparatus (including amplifiers) that produce heat.
9. DO NOT defeat the safety purpose of the polarized or grounding-type plug. A polarized plug has two blades with one wider than the other. A grounding type plug has two blades and a third grounding prong. The wider blade or the third prong are provided for your safety. If the provided plug does not fit into your outlet, consult an electrician for replacement of the obsolete outlet.
10. PROTECT the power cord from being walked on or pinched, particularly at plugs, convenience receptacles, and the point where they exit from the apparatus.
11. ONLY USE attachments/accessories specified by the manufacturer.
12. UNPLUG this apparatus during lightning storms or when unused for long periods of time.
13. REFER all servicing to qualified service personnel. Servicing is required when the apparatus has been damaged in any way, such as power-supply cord or plug is damaged, liquid has been spilled or objects have fallen into the apparatus, the apparatus has been exposed to rain or moisture, does not operate normally, or has been dropped.
14. DO NOT expose the apparatus to dripping and splashing. DO NOT put objects filled with liquids, such as vases, on the apparatus.
15. Remove the batteries from the receiver if the system will not be used for a long period of time. This will avoid any damage resulting from a defective, leaking battery.
16. DO NOT throw used batteries into a fire. Be sure to dispose of or recycle used batteries in accordance with local waste disposal laws.

**LICENSING INFORMATION**

**THIS RADIO EQUIPMENT IS INTENDED FOR USE IN PROFESSIONAL ENTERTAINMENT AND SIMILAR APPLICATIONS.**

Changes or modifications not expressly approved by Galaxy Audio Incorporated could void your authority to operate the equipment. Licensing of Galaxy Audio wireless microphone equipment is the user's responsibility, and licensability depends on the user's classification and application, and on the selected frequency. Galaxy Audio strongly urges the user to contact the appropriate telecommunications authority concerning proper licensing, and before choosing and ordering frequencies.

**NOTE: THIS EQUIPMENT MAY BE CAPABLE OF OPERATING ON SOME FREQUENCIES NOT AUTHORIZED IN YOUR REGION. PLEASE CONTACT YOUR NATIONAL AUTHORITY TO OBTAIN INFORMATION ON AUTHORIZED FREQUENCIES FOR WIRELESS MICROPHONE PRODUCTS IN YOUR REGION**

**Licensing:** Note that a ministerial license to operate this equipment may be required in certain areas. Consult your national authority for possible requirements.

## Contents:

Introduction.....	1-2
Transmitter Installation and Connections.....	2
Installation.....	2
Connections.....	2
Transmitter Controls and Functions.....	3
AS-1800T Front Panel.....	3
AS-1800T Rear Panel.....	3
Receiver Controls and Functions.....	4
AS-1800R Front Panel.....	4
AS-1800R Upper Side.....	4
Receiver Battery Installation.....	4
System setup.....	5-7
AS-1800R Transmitter Setup.....	5
AS-1800R Receiver Setup.....	6
Stereo/Mono/Mixed Mono Setup.....	6
Specifications.....	8

# System Components

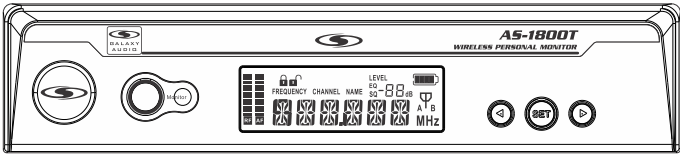

Transmitter

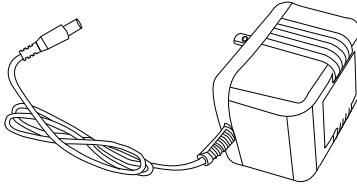

Power

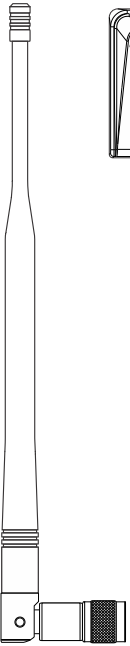

Antenna



Earphone

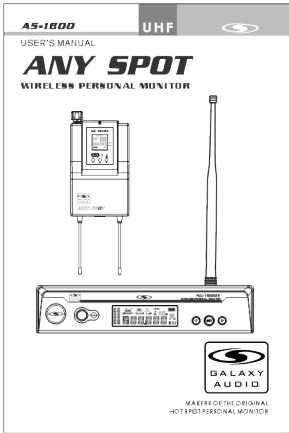

User's Manual

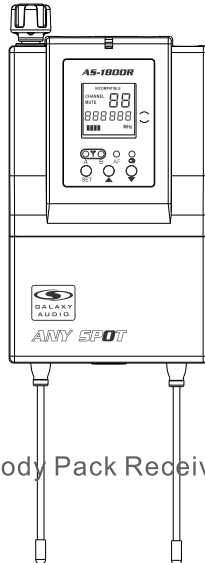

Body Pack Receiver

Thank you for choosing a Galaxy Audio professional wireless in-ear monitor system. You have joined thousands of other satisfied customers. Our years of professional experience in design and manufacturing ensure our products' quality, performance and reliability.

## 1. Introduction

1. EIA-standard metal materials half - rack transmitter chassis.
2. Durable, ergonomic metal body Receiver with soft-touch controls.
3. 16MHz Bandwidth, 640 Selectable UHF frequencies / 32 Channels and True Diversity reception for interference-resistant operation and High-visibility white LCD information display
4. PLL (Phase Lock Loop frequency control) design ensures transmission reliability, "Noise Lock" squelch effectively blocks stray RF.
5. Designed to provide incredible audio quality and reliable performance for artists, broadcasters and other demanding audio environments.

## 2. Transmitter Installation and Connections

### Installation

1. For better operation the transmitter should be at least 3ft. (1m) above the ground and at least 3ft. away from a wall or metal surface to minimize reflections.
2. Keep antennas away from noise sources such as computer, digital equipment, motors, automobiles and neon lights, as well as away from large metal objects.
3. Antenna are normally positioned 45° from vertical for best transmission.
4. Keep open space between the receiver and transmitter for better reception.
5. The transmitter should be at least 6ft. (2m) from the receiver.

### Connections:

1. The 12V, 500mA switching power supply is designed to operate properly from any AC power source without user adjustment. Simply connect the transmitter to a standard AC power outlet, using only an IEC-type input cordset approved for the country of use. Power to the unit is controlled by the front panel power switch.
2. There are two audio inputs on the rear panel: 1/L and 2/R audio INPUTS. Suitable for an XLR balanced audio input connector or a balanced/unbalanced 1/4" (6.3mm) input connector. The two audio inputs simultaneous feed from two different outputs. Use the appropriate shielded audio cable for connections between the transmitter and the output(s) of the mixer or other audio output equipment.

# AS-1800T Transmitter Features:

## Figure A: Front Panel:

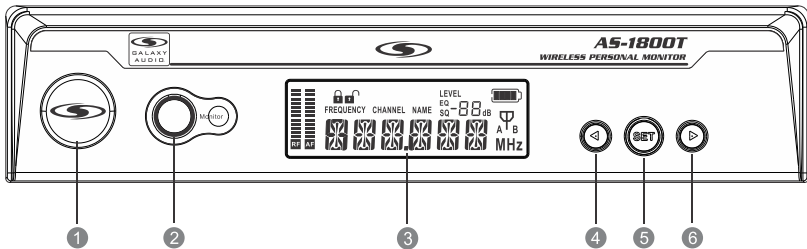

- 1 Power Switch:** Press power switch in for 3 seconds and the transmitter readouts will light.
- 2 1/4" Monitor:** Earphone output jack.
- 3 LCD Window:** Liquid Crystal Display indicates control setting and operational readings. See "System setup" on page (5) for details.
- 4 6 UP / DOWN Buttons:** Press Up or Down arrow button, in conjunction with the Set button, to step through menus, select operating frequency and edit transmitter functions.
- 5 SET Button:** Use in conjunction with the Up / Down arrow buttons to step through menus, choose operating frequency and select transmitter functions.

## Figure B: Rear Panel:

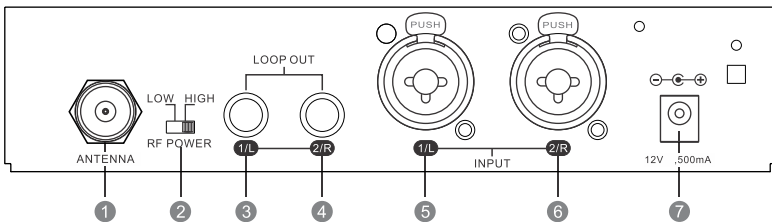

- 1 Antenna Input Jack:** BNC type antenna connector.
- 2 RF POWER Output:** Two-position switch adjusts RF power output with LOW of 30mW, HIGH of 100mW.
- 3 1/L LOOP OUT:** Balanced 1/4" (6.3mm) output jack to connect to another AS-1800 transmitter's Balanced Input.
- 4 2/R LOOP OUT:** Balanced 1/4" (6.3mm) output jack to connect to another AS-1800 transmitter's Balanced Input
- 5 1/L Balanced Input Jack:** XLR - 1/4" type connector. A standard 2 conductor plus shield cable can be used to connect the transmitter input to a balanced output on a mixer or integrated amplifier.
- 6 2/R Balanced Input Jack:** XLR - 1/4" type connector. A standard 2 conductor plus shield cable can be used to connect the transmitter input to a balanced output on a mixer or integrated amplifier.
- 7 DC Power Input Jack:** 12V / 500mA.

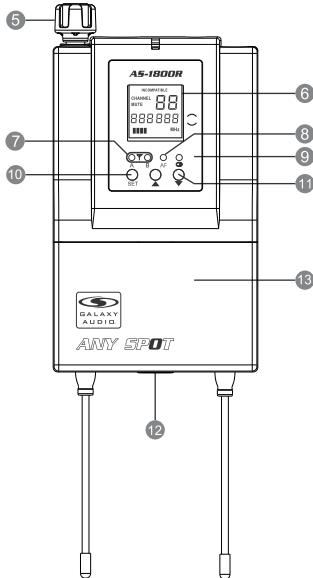
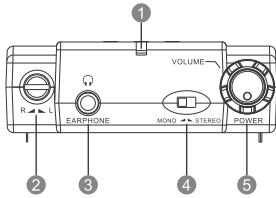

- ① Power indicator
- ② Left and Right Channels Balanced Switch:  
To balance the volume of left and right channels for the Headphone.
- ③ Headphone Jack.
- ④ Mono or Stereo Selector Switch: If selecting Stereo, indicator (9) lights.
- ⑤ Power Switch.
- A: Power supply switch: When powered on, the indicator is green.
- B: Volume control: Once the receiver power is ON, adjust this switch to control the volume of Headphone.
- ⑥ LCD Window: Liquid crystal display indicates operational frequency, channel and battery condition. The transmitter's "fuel gauge" battery indicator displays a maximum of 4 bar segments. When it leaves 1 bar segment, the batteries should be replaced immediately to ensure continued operation.
- ⑦ Antenna Diversity Receiving Signal Strength Indicator.
- ⑧ AF Signal Indicator.
- ⑨ Stereo Indicator.
- ⑩ SET Button: Use in conjunction with the Up / Down arrow buttons to step through menus, choose operating frequency and select receiver function options.
- ⑪ UP / DOWN Buttons: Press Up or Down arrow button, in conjunction with the Set button, to step through menus, select operating frequency and edit receiver functions.
- ⑫ Battery Door Switch
- ⑬ Battery Compartment

## Wearing the Body Pack Receiver

**Belt Clip:** For best results, clip the receiver onto a belt by pushing the receiver down onto the belt as far as possible. For Guitarists: Slide the guitar strap "through" the receiver clip.

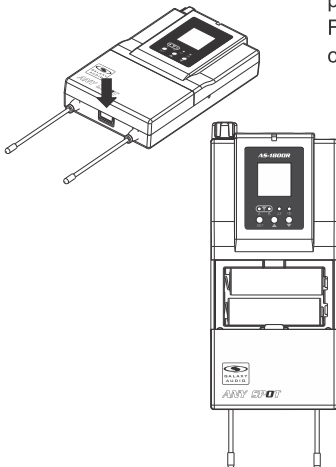

## Changing Batteries

Expected life for two Alkaline batteries is approximately 7 hours.

Locate the Battery Door Switch, Open the battery door by sliding the switch. Insert 2 fresh 1.5V AA batteries. (Alkaline type is recommended, always replace both batteries.)

Observe correct polarity as marked inside the battery compartment.

## AS-1800 Transmitter Setup

- 1.) Turn down the AF level of the associated mixer or amplifier.
- 2.) Turn on the transmitter, the LCD displays the preset data.
- 3.) Change the frequency by Pressing </> button to change the frequency, then "SET" to confirm the selected frequency.
- 4.) To enter the menu mode: Press and hold the SET button for 3 seconds to enter the edit mode, press the < or > button once to select and set RENAME, SENSITI, LOCK, DISP, INPUT or LEVEL.

**A.) RENAME:** Select "RENAME", then press the "SET" Button to enter edit mode (System pre-set name is AS-1800), when the first number flashes, press the < or > arrow button to choose any number (0-9) or letter (A-Z) or character. After the first number has been picked, press the "SET" button, then the second letter flashes. Repeat till the sixth letter is programmed. Press the "SET" button on the transmitter to confirm the desired choice.

**B.) Mode** Select "MODE" then press set to enter edit mode press </> button to select "TUNE" or "CHAN". Then press the Set button to confirm the desired choice. "TUNE" accesses all 640 frequencies, "CHAN" accesses just the 32 preset channel frequencies.

**C.) SENSITI (Sensitivity):** Select "SENSITI", then press the SET button to enter edit mode, press </> button to select "HIGH" or "LOW". Press the "SET" button on the transmitter to confirm the desired choice.

**D.) LOCK:** Select "LOCK", then press the SET Button to enter edit mode, press the </> arrow button to select "ON" or "OFF", when "ON" is selected, the AS-1800T enters a lock mode, the user can not make changes to the AS-1800T settings; When "OFF" is selected, the user can make changes to the AS-1800T settings. Press the SET Button on the transmitter to confirm the desired choice.

**E.) DISP (display):** Select "DISP", then press the SET Button to enter edit mode, press the </> arrow button to select "FREQUENCY" (frequency), "CHAN" (channel) or "NAME". When selecting "FREQ", the LCD will display the operational frequency; When selecting "CHAN", the LCD will display the operational channel; When selecting "NAME", the LCD will display the user name; Press the SET Button on the transmitter to confirm the desired choice.

**F.) INPUT:** Select "INPUT", then press the SET Button to enter edit mode, press the </> arrow button to select "MONO" or "STEREO". When "MONO" is selected, the AS-1800T is transmitting a mono signal; When "STEREO" is selected the AS-1800T is transmitting a stereo signal. Press the SET Button to confirm the desired choice. *(When the AS-1800T is set to transmit in Mono, Only the 2/R Input should be used)*

**G.) LEVEL (Squelch):** Select "LEVEL", then press the SET button to enter edit mode, press the </> button to scroll through the available choice for the function. The squelch level is adjustable in 80 1dB steps, providing 0dB to -80dB range. Press SET Button to confirm the desired choice.



## AS-1800 Receiver Setup

- 1.) Turn on the receiver, the LCD displays the preset data.
  - 2.) Change the frequency by pressing the </> button to change the frequency, then "SET" to confirm the selected frequency.
  - 3.) To enter the menu mode: Press and hold the SET button for 3 seconds to enter the edit mode, press the </> button to select and set SQ, LOC or P OFF.
- A.) SQ (squelch):** Select "SQ", then press SET Button to enter edit mode, the squelch level flashes to indicate editing, press the </> button to scroll through the available choice. The squelch level is adjustable in ten 5dB steps, providing a 50dB range. Press the SET button to confirm the desired choice.  
(SQUELCH of receiver has been preset at the factory. If interference is a problem, first consider trying a different frequency. If it is not necessary, please do not adjust the SQUELCH randomly. This could cause unwanted interference. )
- B.) LOC (lock):** Select "LOC", then press the SET Button to enter edit mode, press < or > arrow button to select "ON" or "OFF", When "ON" is selected, the AS-1800R enters lock mode, the user can not use any button for any control; When selecting "OFF", changes to the AS-1800R can be made. Press the SET Button on the receiver to confirm the desired choice.
- C.) P OFF (power off):** Select "P OFF", then press SET Button to enter edit mode, press < or > arrow button to select "OPEN" or "CLOSE", When "OPEN" is selected, the unit will turn off automatically after 30 minutes if it is outside the communications service area (no signal available ); When "CLOSE" is selected, the unit has to be turned off manual. Press the SET Button on the receiver to confirm the desired choice.

## Stereo/Mono/Mixed Mono Setup

**Stereo Mode:** The transmitter and receiver should both be switched into stereo.

### STEREO MODE

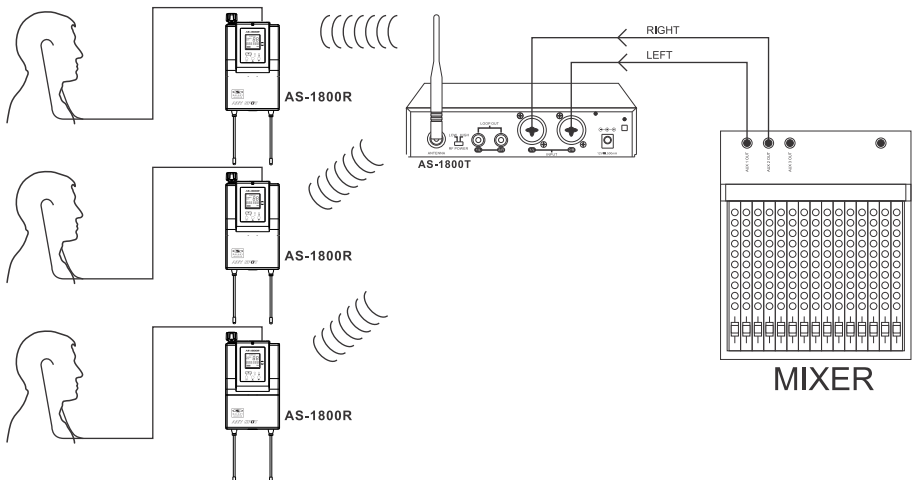

# System Setup

## Stereo/Mono/Mixed Mono Setup (continued)

**Mono Mode:** Use the 2/R input, switch the transmitter to mono, the receiver can remain switched to stereo as the transmitter is sending a mono mix to both ears.

### MONO MODE

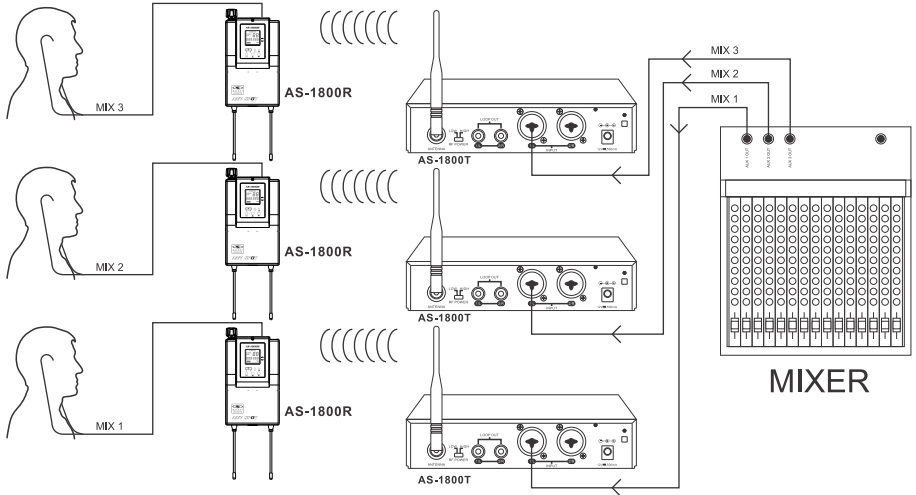

**Mixed Mono Mode:** When you are sending two mixes to the transmitter, the transmitter should be set to stereo and the receiver should be set to mono. The pan control on the receiver then becomes the balance control between the two mixes and both mixes are in both ears. The stereo mono switch for the receiver is a slide switch next to the volume control.

### MIXED MONO MODE

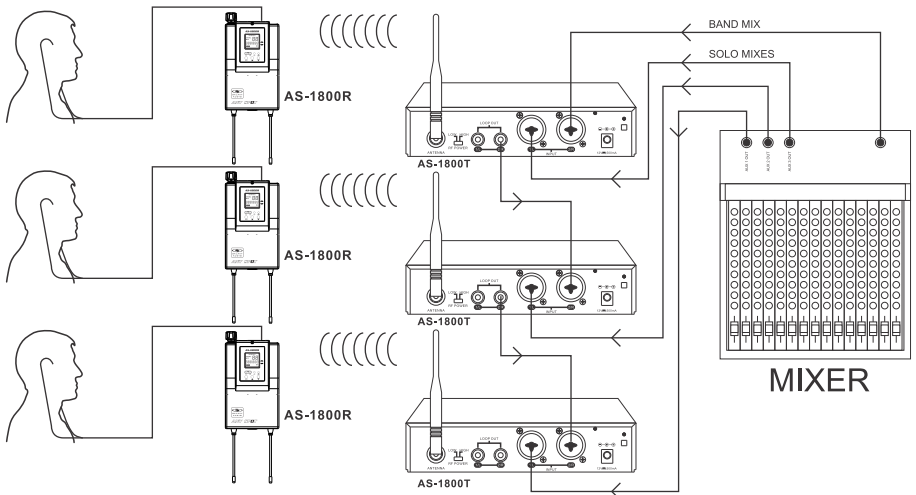

# Specifications

## AS-1800T Stereo Transmitter

**Main Frame Size:** EIA STANDARD 1/2 U

**Channels:** 32 Channels / 640 Selectable Frequencies

**Frequency Stability:**  $\pm 0.0005\%$ , Phase Lock Loop frequency control

**Available Frequencies :** **B2** 538~554 MHZ

**B3** 554~570 MHZ

**Modulation Mode:** FM stereo modulation

**Output Power:** 30mW or 100mW

**Operating Range:** 300' (100M) typical (in open space)

**Oscillation:** PLL synthesized

Spurious Rejection  $< -60\text{dBm}$

**Maximum Deviation Range:**  $\pm 68\text{KHz}$

**Band Width:** 16MHz

**S/N:**  $> 105\text{dB}$

**T.H.D.:**  $< 0.7\%$  @ 1KHz

**Frequency response:** 45Hz~18KHz $\pm 1\text{dB}$

**Audio Input:** Line level X 2, XLR and 1/4" Combo jack

**Audio Output:** 6.3mm $\varnothing$  unbalanced jack X 2

**Dimensions:** 1.7" x 8.2" x 8.1" (44mm (H) x 209mm (W) X 206mm (D))

**Weight:** 2.3 lbs 1.04kg

## AS-1800R Stereo

### Bodypack Receiver

**Channels:** 32 Channels / 640 Selectable Frequencies

**Frequency Stability:**  $\pm 0.0005\%$ , Phase Lock Loop frequency control

**Available Frequencies :** **B2** 538~554 MHZ

**B3** 554~570 MHZ

**Modulation Mode:** FM stereo modulation

**Operating Range:** 300' (100M) typical (in open space)

**Oscillation:** PLL synthesized

**Sensitivity:** 6dB $\mu\text{V}$ , S/N $> 60\text{dB}$  at 25 deviation (mono)

**Band Width:** 16MHz

**Max. Deviation Range:**  $\pm 68\text{KHz}$

**S/N:**  $> 105\text{dB}$

**T.H.D.:**  $< 0.7\%$  @ 1KHz

**Frequency response:** 45Hz~18KHz $\pm 1\text{dB}$

**Stereo Separation:**  $\geq 45\text{dB}$  (at 1KHz)

**Output Connector:** 3.5mm ( $\varnothing$ ) stereo earphone connector

**Output Power:** 150mW at 1KHz (THD1%)

**Battery:** AA X 2

**Current Consumption:** 185mA typical

**Battery Current / Life:** About 7 hours

**Dimension:** 4.25" x 2.6" x 0.87" (108mm(H) X 66mm(W) X 22mm(D))

**Weight:** 0.35 lbs (0.16kg)



MAKERS OF THE ORIGINAL  
HOT SPOT PERSONAL MONITOR



[www.galaxyaudio.com](http://www.galaxyaudio.com)

## ***THREE YEAR LIMITED WARRANTY***

**WARRANTY** Information can be viewed online at  
<http://www.galaxyaudio.com/warranty.php>



[www.galaxyaudio.com/warranty.php](http://www.galaxyaudio.com/warranty.php)

# **A5-1800 USER'S MANUAL**

Specifications in this manual are subject to change without notice.  
For the most up to date manual and information  
visit [www.galaxyaudio.com](http://www.galaxyaudio.com).

1-800-369-7768    [www.galaxyaudio.com](http://www.galaxyaudio.com)

© Copyright Galaxy Audio 2014

Printed in China

V20141001