

VS-PTC-IP

PTZ Camera Remote Controller



User Manual

Table of Contents

Trademark Acknowledgement 2

1. IMPORTANT INFORMATION 2

2. WHAT'S IN THE BOX 4

3. MODELS 6

4. KEYBOARD DIAGRAMS 7

 VS-PTC-IP 7

 SYSTEM OVERVIEW 10

 CONNECTION 10

 INITIAL SETUP 11

Power 11

 CONNECTOR PINOUT DEFINITION 12

 IP CONNECTION 12

 RS232 CONNECTION 13

 RS422 CONNECTION 15

 RS485 CONNECTION 17

5. KEYBOARD CONFIGURATION 18

Interacting with the VS-PTC-IP 18

Setup Button 18

Keyboard Setup 19

Button Light 20

Assign keys 21

Factory Default 22

GPI I/O 22

6. PASSWORD SETTING 23

Model Info 23

 HOW TO ASSIGN CAMERA 24

Manually adding cameras 24

 ADDING AN ONVIF CAMERA TO KEYBOARD 25

Adding manually from Local Area Network (LAN) 25

Scanning Local Area Network (LAN) for available ONVIF cameras 25

Adding ONVIF cameras to be controlled via WAN 27

 ADDING A VISCA OVER IP CAMERA TO KEYBOARD 28

Adding manually from Local Area Network (LAN) 28

Scanning local network for available VISCA over IP cameras 29

Adding VISCA over IP cameras to be controlled via WAN 30

7. INTERACTING WITH CAMERAS 31

 RS422 A BUTTON AND RS422 B BUTTON 31

 OPTIONS FOR CALLING CAMERA 31

 CONTROLLING A CAMERA 32

Engaging the Camera OSD Menu for non-IP cameras 32

Engaging the Camera OSD Menu for PELCO-D or ONVIF-IP Cameras 32

 MANUAL MOVEMENTS 32

 SETTING AND CALLING PRESETS 33

Setting / creating presets: 33

Calling presets: 34

Resetting / Clearing presets: 34

 ADJUSTING IMAGE PARAMETERS 35

8. FIRMWARE UPGRADE 36

9. DIMENSIONS 37

 Junction Box 37

 VS-PTC-IP 38

Operating Instructions

Thank you for purchasing our Marshall VS-PTC-IP Controller. If there are any questions, please contact the Authorized Dealer or Marshall Electronics directly (800) 800-0688.

Before operating the unit, please read this manual thoroughly and retain it for future reference.

Copyright

Copyright Marshall Electronics all rights reserved. No part of this manual may be copied, reproduced, translated, or distributed in any form or by any means without prior consent in writing from our company.

Trademark Acknowledgement

Marshall Electronics and other Marshall trademarks and logos are the property of Marshall Electronics. Other trademarks, company names and product names contained in this manual are the property of their respective owners.

1. Important Information

Legal Notice

Attention:

To ensure account security, please change the password after your first login. You are recommended to set a strong password (no less than eight characters). Password login does not apply to some models that do not need password login.

The contents of this document are subject to change without prior notice. Updates will be added to the new version of this manual. We will readily improve or update the products or procedures described in the manual.

Best effort has been made to verify the integrity and correctness of the contents in this document, but no statement, information, or recommendation in this manual shall constitute formal guarantee of any kind, expressed or implied. We shall not be held responsible for any technical or typographical errors in this manual.

The product appearance shown in this manual is for reference only and may be different from the actual appearance of your device.



This manual is a guide for multiple product models and so it is not intended for any specific product.

In this manual, the illustrations of displayed interface, parameters displayed, drawings and value ranges may vary with models. Please see the actual product for details.

Due to uncertainties such as physical environment, discrepancies may exist between the actual values and reference values provided in this manual.

Use of this document and the subsequent results shall be entirely on the user's own responsibility.

Symbols

Symbol	Description
 WARNING!	Contains important safety instructions and indicates situations that may cause bodily injury.
 CAUTION!	User must be careful and improper operations may cause damage or malfunction of product.
 NOTE!	Indicates useful or supplemental information about the use of product.

Safety Information



WARNING!

Installation and removal of the unit and its accessories must be carried out by qualified personnel. You must read all of the Safety Instructions supplied with your equipment before installation and operation.

Warnings:

- If the product does not work properly, please contact your dealer. Never attempt to disassemble the unit yourself. (We will not assume any responsibility for problems caused by unauthorized repair or maintenance.)
- This installation should be made by a qualified service person and should conform to all the local codes.
- When shipping, the unit should be packed in its original packaging.
- Make sure the power supply voltage is correct before connecting to the unit.
- Do not drop or subject the unit to physical shock.

Maintenance Precautions:

- Ensure that no moisture or liquid comes into contact with any surface of the keyboard, as liquid may damage the functions of the keyboard.
- Keep the RJ-45 ports free from dust and moisture
- Only use the original, uncut (not spliced) power supply that is included with the keyboard

Regulatory Compliance

FCC Part 15

This equipment has been tested and found to comply with the limits for digital device, pursuant to part 15 of the FCC Rules. These limits are designed to provide reasonable protection against harmful interference when the equipment is operated in a commercial environment. This equipment generates, uses, and can radiate radio frequency energy and, if not installed and used in accordance with the instruction manual, may cause harmful interference to radio communications. Operation of this equipment in a residential area is likely to cause harmful interference in which case the user will be required to correct the interference at his own expense.

This product complies with Part 15 of the FCC Rules. Operation is subject to the following two conditions:

This device may not cause harmful interference.

This device must accept any interference received, including interference that may cause undesired operation.



This product complies with the European Low Voltage Directive 2006/95/EC and EMC Directive 2004/108/EC.



WEEE Directive-2002/96/EC

The product this manual refers to is covered by the Waste Electrical & Electronic Equipment (WEEE) Directive and must be disposed of in a responsible manner.

2. WHAT'S IN THE BOX

Standard Accessories



Keyboard



Power supply and power cord



Junction box



RJ45 Control Cable

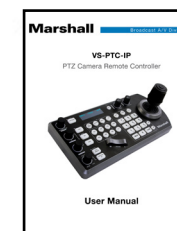

User Manual

Optional Accessories

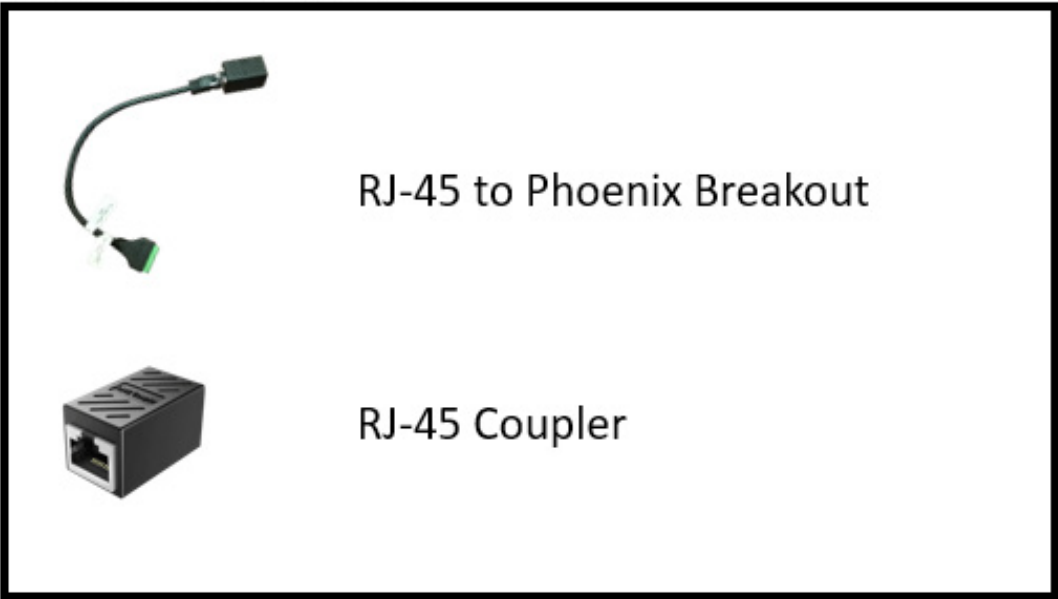

When the "Optional" Accessories will be needed:

- When RS422 and RS232 cameras are being controlled simultaneously
- When more than one group of RS422 cameras is being controlled simultaneously

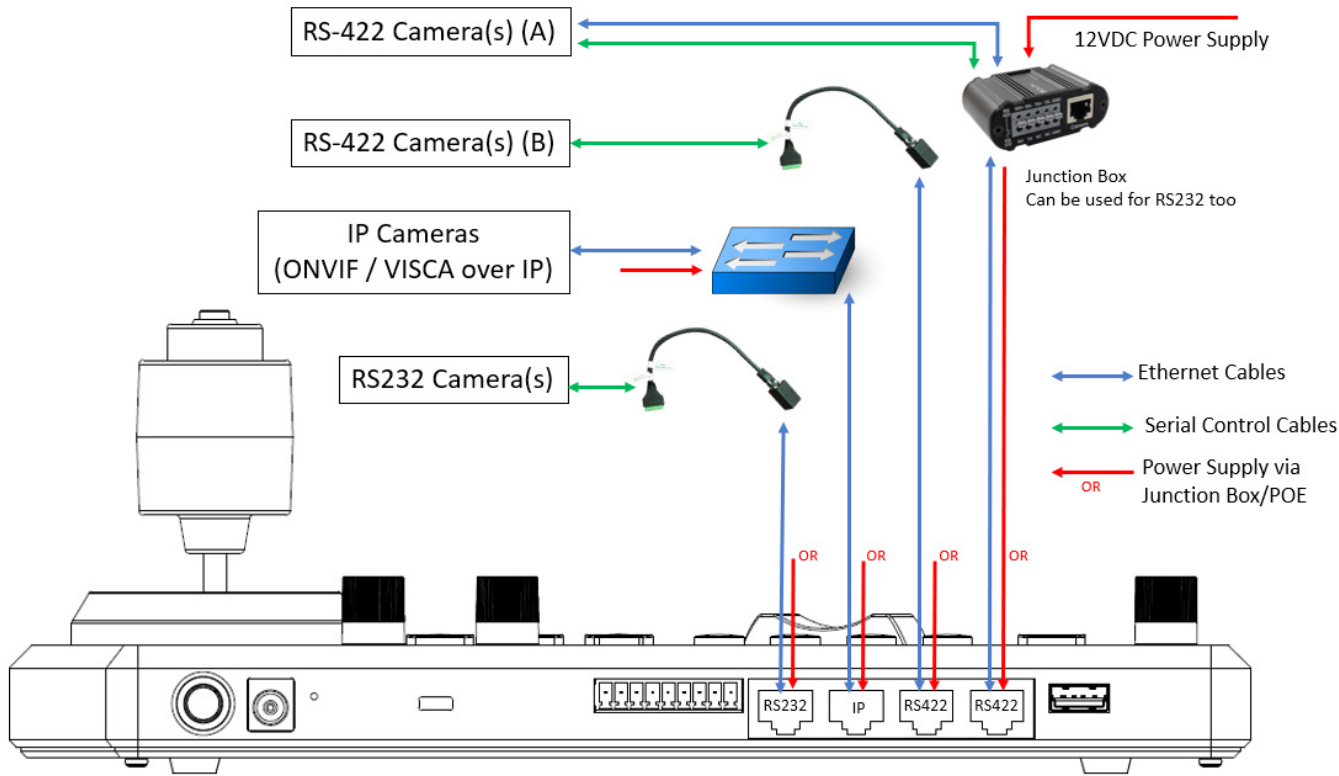

Simultaneous Cross-Protocol Mix-Control

Figure 2 - When the junction box is powered, it will provide power to the keyboard via any port that it is connected to --RS232, IP, RS422(A), RS422(B). **No additional power supply is required for the keyboard when a powered junction box is being used.**

Please Note regarding Serial Control protocols (RS422 and RS232):

- When controlling only RS232 cameras, the keyboard can control a total of 7 RS232 cameras
- When controlling RS422 and RS232 cameras simultaneously, the keyboard can control a total of 7 RS232 and RS422 cameras
- When controlling only RS422 cameras, the keyboard can control up to 14 RS422 cameras (2 daisy chains of 7)

The keyboard is capable of simultaneously controlling up to 255 cameras, between mixed protocols (RS422, RS232, and IP)

3. Models

This user guide is suitable for the following model:

- VS-PTC-IP

Key Features:

- Cross protocol mix-control with RS232/RS422 and IP
- Protocol support: VISCA, PELCO D/P, ONVIF, VISCA over IP
- Quick Access Control
- High-quality sync-6-way joystick control

Independent dual power input: 12VDC, POE

Functionalities:

- Easy, ergonomic PTZ control of multiple remote cameras for live event production and content creation. Applications: Education, Broadcast, Video Conferencing, House of Worship etc.
- This compact remote controller features a high-quality joystick that allows effortless one-handed pan, tilt and zoom adjustments. Zoom can also be controlled via the joystick or a supplementary seesaw lever; dedicated knobs and control buttons simplify direct access to frequently-needed camera functions without needing to use the camera menus.
- Quick Access features include the control of Exposure, Shutter Speed, Iris, Compensation, White Balance, Focus, PT Speed, Zoom Speed.
- The controller supports serial RS232/RS422 and IP mix-control. It allows you to use RS232/RS422/IP control on one controller to control cameras in a single system.
- With IP control, automatically search available IP cameras in the network and assign IP addresses easily. IP control supports ONVIF, VISCA Over IP.
- Up to 256 camera presets with memory of image parameters and 8 patterns/cruises to recall camera moves. (Requires camera support)
- Tally Indicator: Includes Normal Tally/On-Air Tally/Contact Modes
- Supports 2 groups (7 cameras per group) via VISCA RS422 daisy chain control. Unlimited number of controllers can operate on a single network to control up to 255 IP cameras. Controls up to total 255 cameras (Combine using PELCO/VISCA/ONVIF IP/VISCA-Over-IP Protocol).
- Up to 6 selectable ASSIGN function keys, additional functions can be assigned to ASSIGN buttons.
- Multi-color Key/Button illumination indicator
- Full compatibility is provided with all Marshall PTZ cameras and Sony BRC, SRG series PTZ cameras and most PTZ cameras in the market that support RS232/RS422/RS485/IP control.
- Control firmware upgrade is available via USB to keep the performance of the controller up to date.

4. Keyboard Diagrams

VS-PTC-IP

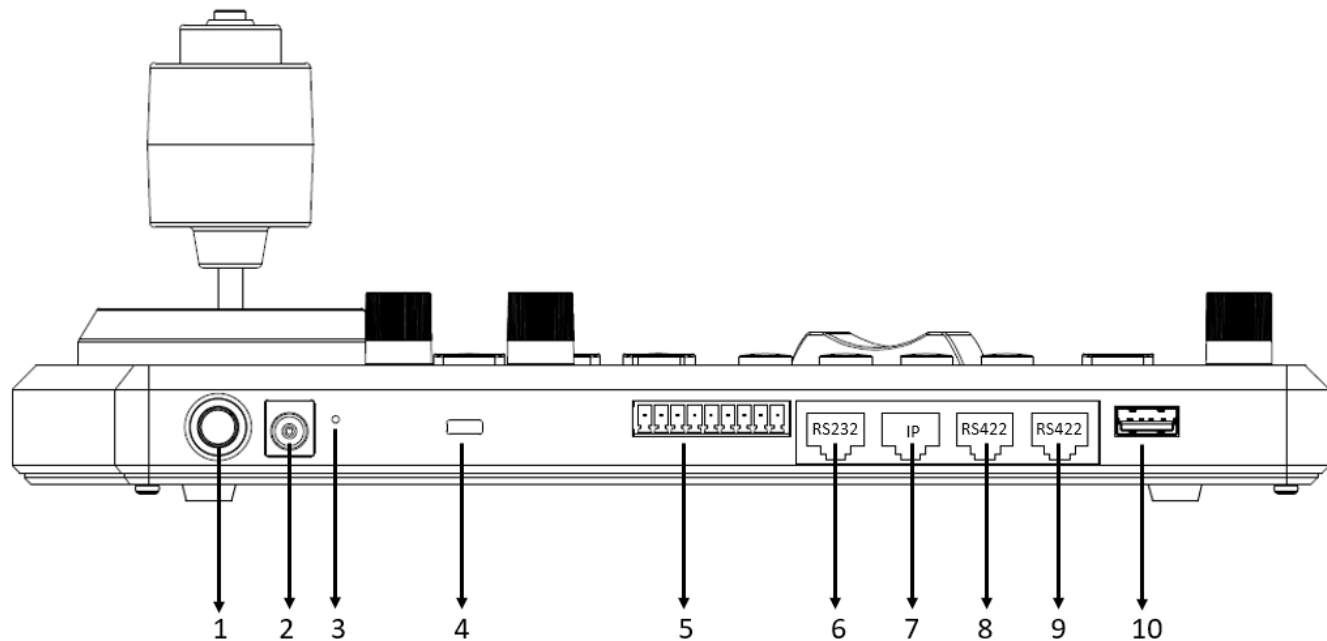

- 1. Power Button**
Power on / Power off the keyboard
- 2. 12V DC Power Port**
Connect the supplied DC power adaptor and cord
- 3. Firmware Interface Button**
Engages firmware update mode on the keyboard
- 4. Kensington Security slot**
Use a lock to physically secure the keyboard in place
- 5. Tally / Contact**
Tally control interface
- 6. RS232 interface / RJ-45 port**
Connect RS232 adapter
- 7. IP Interface / RJ-45 port**
Connect the keyboard to a network
- 8. RS422 (B) interface / RJ-45 port**
Connect an RS422 adapter to control up to 7 daisy-chained RS422 cameras (Group A)
- 9. RS422(A) interface / RJ-45 port**
Connect an RS422 adapter to control up to 7 daisy-chained RS422 cameras (Group B)
- 10. Firmware Upgrade USB port**

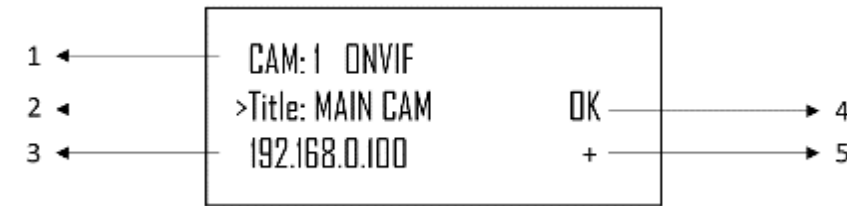

1. Camera Identifier – Identifies which camera is being controlled, and the protocol being used
2. Camera Title – User-defined title of the current camera
3. IP Address – The IP address of the current camera (if applicable)
4. Communication indicator for current device
 - a. OK means the keyboard has established communication with the current device
 - b. If “OK” does not appear, the keyboard is unable to reach the current device
5. Network Connectivity indicator
 - a. If the “+” appears, this means that the network is successfully connected
 - b. If the “+” does not appear, this means that the network is not connected

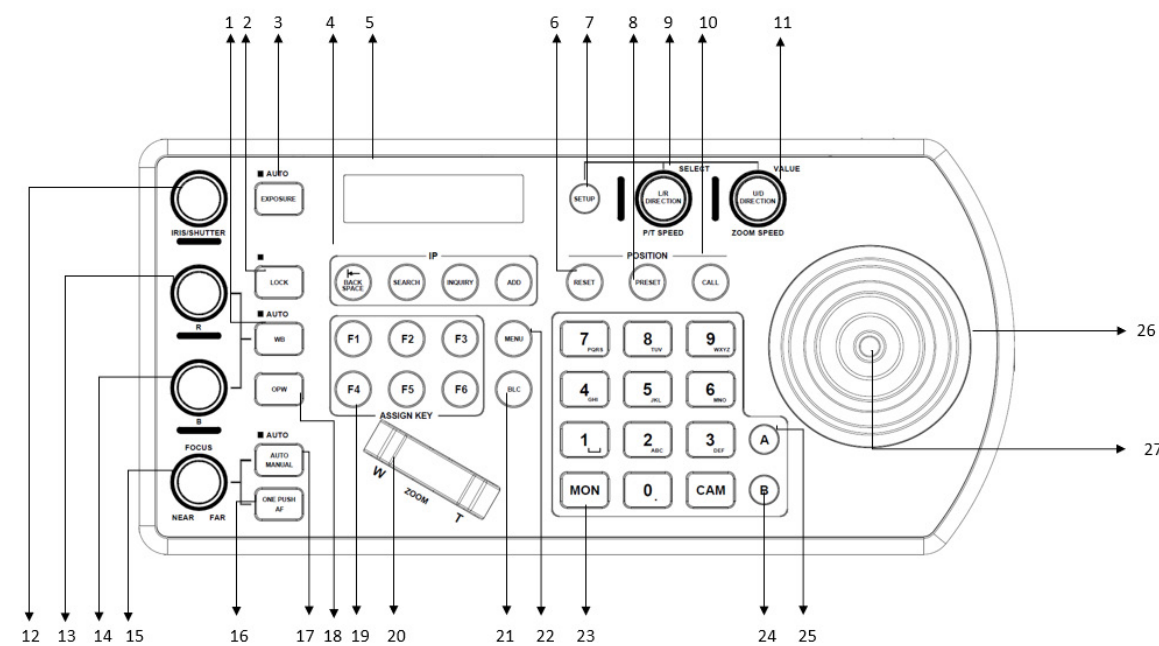

1. White Balance, (Auto, Manual)
 - Press once for Auto
 - Press again to activate manual adjustments
2. Lock – locks all image adjustment buttons and dials
3. Exposure, (Auto, Iris PRI, Shutter PRI)
4. IP Interface Buttons – used to interact with IP cameras
5. LCD Screen – Display for navigating keyboard settings

6. Reset – used for clearing presets
7. Setup – used for keyboard menu setting
8. Preset – used for saving camera presets
9. Pan Tilt Speed knob
 - Rotate: Speed adjustment / Navigate (in menu)
 - Press: Select (in menu)
 - Long press: Invert L/R direction
10. Call – used for calling camera presets
11. Zoom Speed knob
 - Rotate: Zoom speed adjustment / Adjust value (in menu)
 - Press: Save (in menu)
 - Long press: Invert U/D Direction
12. IRIS / Shutter Adjustment for Exposure
13. Manual Red Adjustment for White Balance
14. Manual Blue Adjustment for White Balance
15. Manual Focus
16. One-Push Focus
17. Focus Auto/ Manual Toggle
18. OPW (One Push WB) For White Balance
19. Assign Keys – used to assign quick access to commands
20. Zoom Seesaw – For zoom in / zoom out
21. BLC (Back Light Compensation) – Toggles Back Light Compensation setting in camera
22. Menu For pulling out camera OSD menu
23. Alphanumeric Keypad – used for camera call, preset call, entering data (in menu)
24. RS422 Group B Selection
25. RS422 Group A Selection
26. PTZ Joystick
27. Enter Button for menu setting to Enter/Confirm data.

System Overview

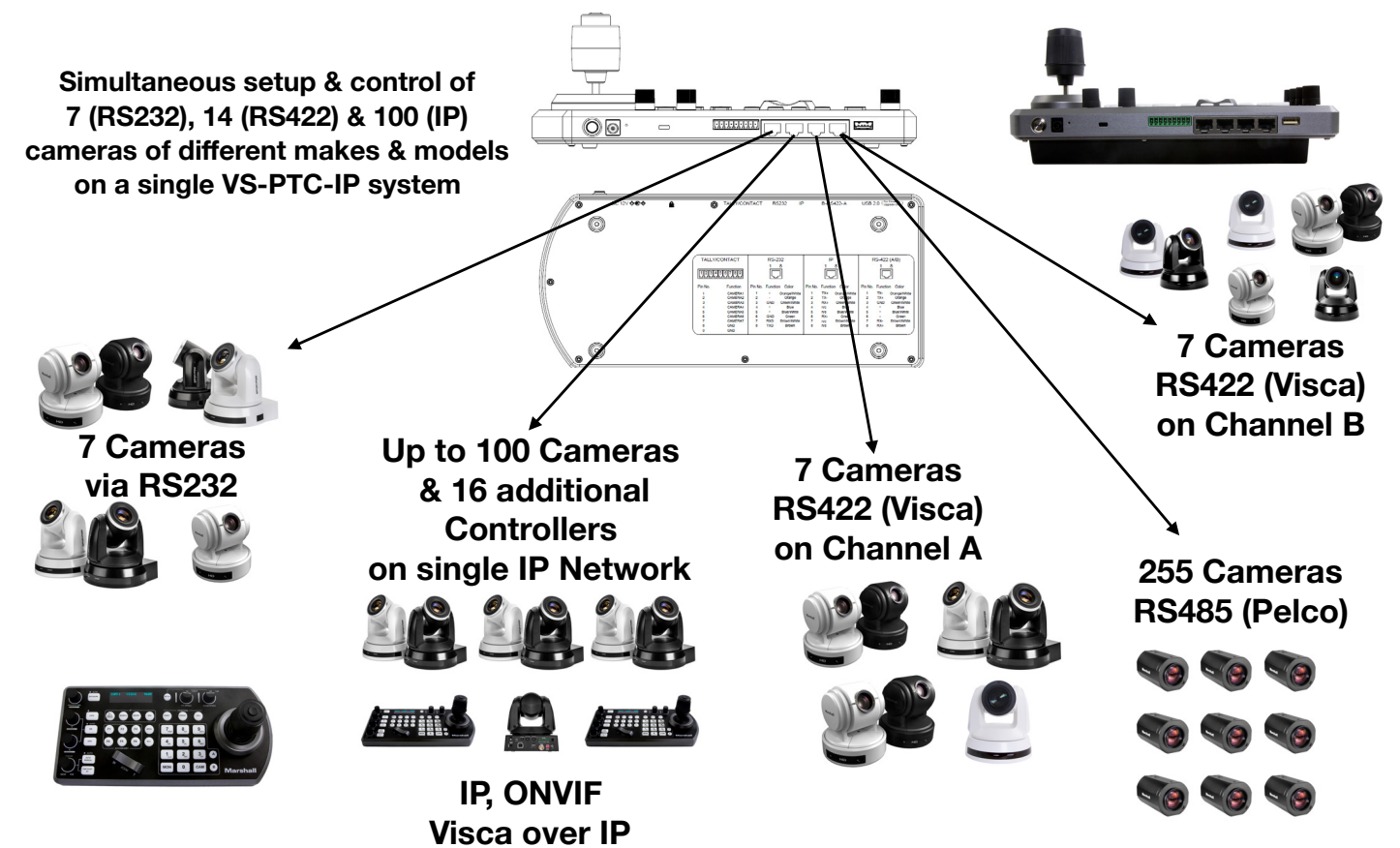

Connection

The controller supports serial RS232/RS422 and IP Cross protocol mix-control. It allows you to use RS232/RS422/IP control on one controller to control cameras (Protocol support: VISCA, PELCO D/P, ONVIF, VISCA over IP, CGI*) in a single system.

Depending on the protocol being used to control the cameras, you may need to connect one or more of the following:

IP port to network switch

- Used for logging in to web interface of VS-PTC-IP
- Used to control the following PTZ protocols:
 - VISCA over IP
 - ONVIF
- RS232 Connection1 to 1 connection with keyboard and camera
- Keyboard connection to RS232 daisy chain

RS422 Connection

- Keyboard RS422 (A or B) RJ-45 port to RS422 adapter to RS422 cameras (daisy chain)
- Keyboard RS422 (A or B) RJ-45 port to RS422 adapter to RS485 cameras.

Initial Setup

Power

Power up the controller using one of the following options:

1. Power supply (included)
 - Power Voltage Tolerance 9V – 12V
2. Use POE (connect Ethernet IP port to POE switch)
 - Maximum distance 80M using CAT6 Plus cable
3. Use included junction box
 - Connect junction box to power supply
 - Connect Ethernet cable from “Controller” port on the junction box to the RS422 or RS232 port on the VS-PTC-IP
 - When using Junction Box to provide power to the keyboard via RS422 or RS232 port on the keyboard. Does not need extra power supply for keyboard.

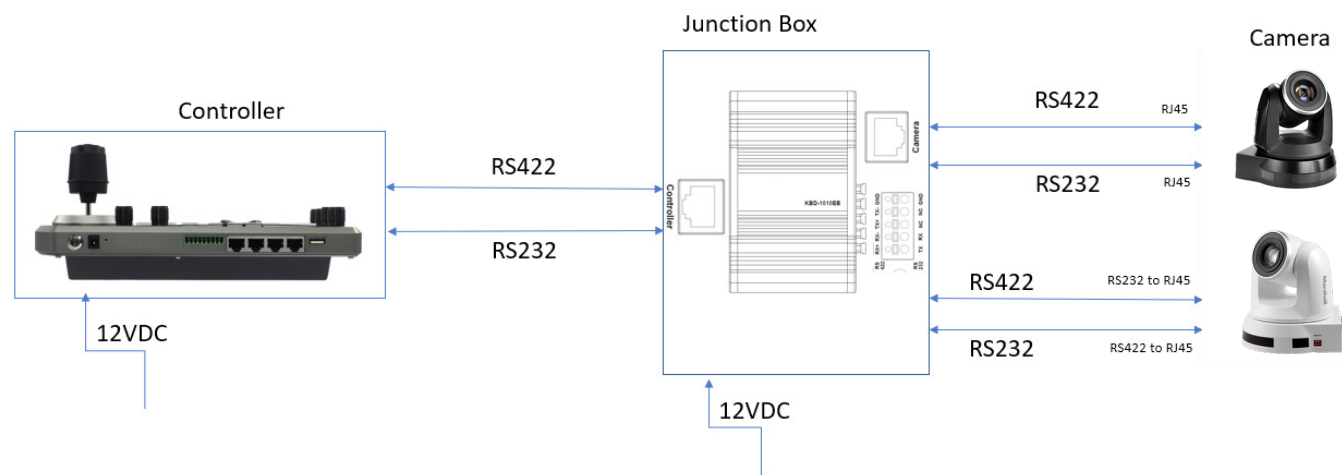
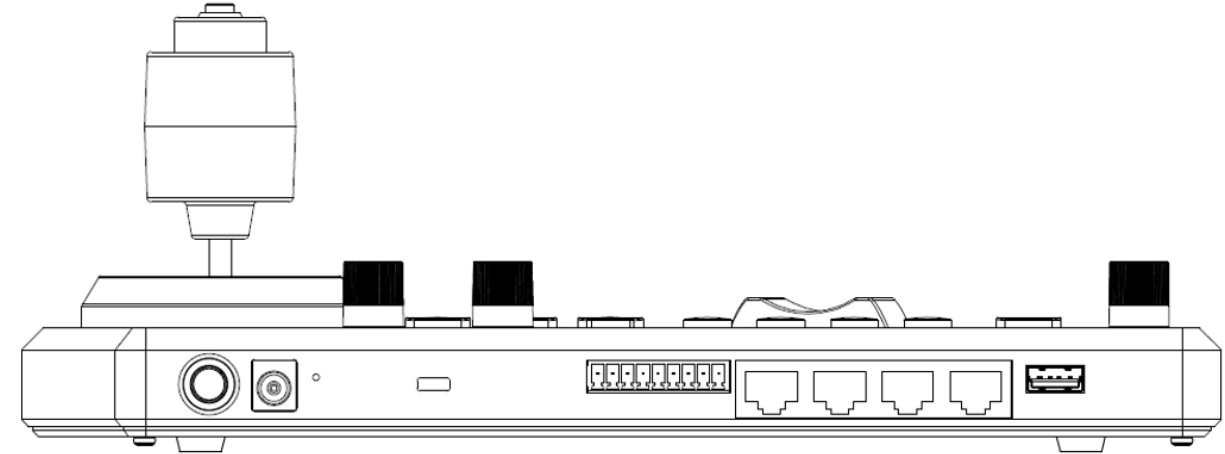

Figure 3 - Power supply is required at EITHER the keyboard OR the Junction Box. If the junction box is powered, no additional power supply is needed for the keyboard, as the junction box will provide power to the keyboard via the control port

Connector Pinout Definition



TALLY/CONTACT		RS-232			IP			RS-422 (A/B)		
1 2 3 4 5 6 7 8 9		1 8			1 8			1 8		
Pin No.	Function	Pin No.	Function	Color	Pin No.	Function	Color	Pin No.	Function	Color
1	CAMERA1	1	-	Orange/White	1	TX+	Orange/White	1	TX-	Orange/White
2	CAMERA2	2	-	Orange	2	TX-	Orange	2	TX+	Orange
3	CAMERA3	3	GND	Green/White	3	RX+	Green/White	3	GND	Green/White
4	CAMERA4	4	-	Blue	4	n/c	Blue	4	-	Blue
5	CAMERA5	5	-	Blue/White	5	n/c	Blue/White	5	-	Blue/White
6	CAMERA6	6	GND	Green	6	RX-	Green	6	-	Green
7	CAMERA7	7	TXD	Brown/White	7	n/c	Brown/White	7	RX-	Brown/White
8	GND	8	RXD	Brown	8	n/c	Brown	8	RX+	Brown
9	GND									

IP connection

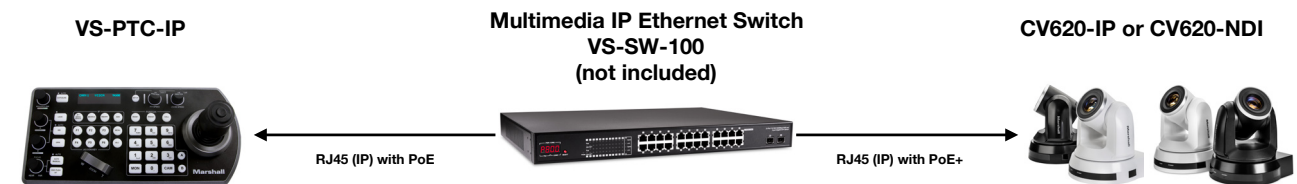

Connect the keyboard's "IP" port to a port on an Ethernet switch

For more information regarding adding ONVIF and VISCA over IP cameras to be controlled by the keyboard, please see the section on [Keyboard Configuration](#)

RS232 connection

- Follow the diagram below for the following options:
 - 1 to 1 connection, Marshall camera ONLY - Use the included (premade) Ethernet cable direct connect or standard Ethernet cable.
 - 1 to 1 connection, Non-Marshall camera – Follow the pinout for the RS232 port on the keyboard to make a cable suitable for controlling your camera

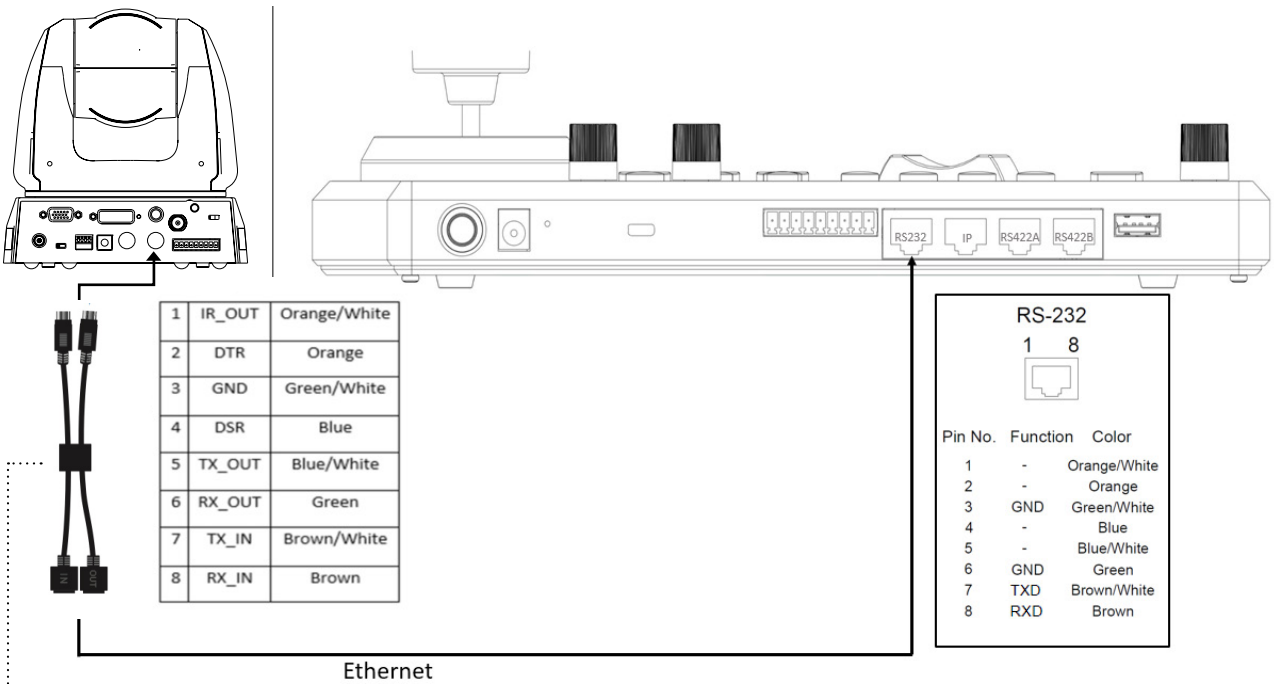

Marshall CV620-Cable-07
Ethernet to 8-pin (RS232)
*sold separately

2. Use RJ45-RS232 adapter (Marshall/Non-Marshall camera)

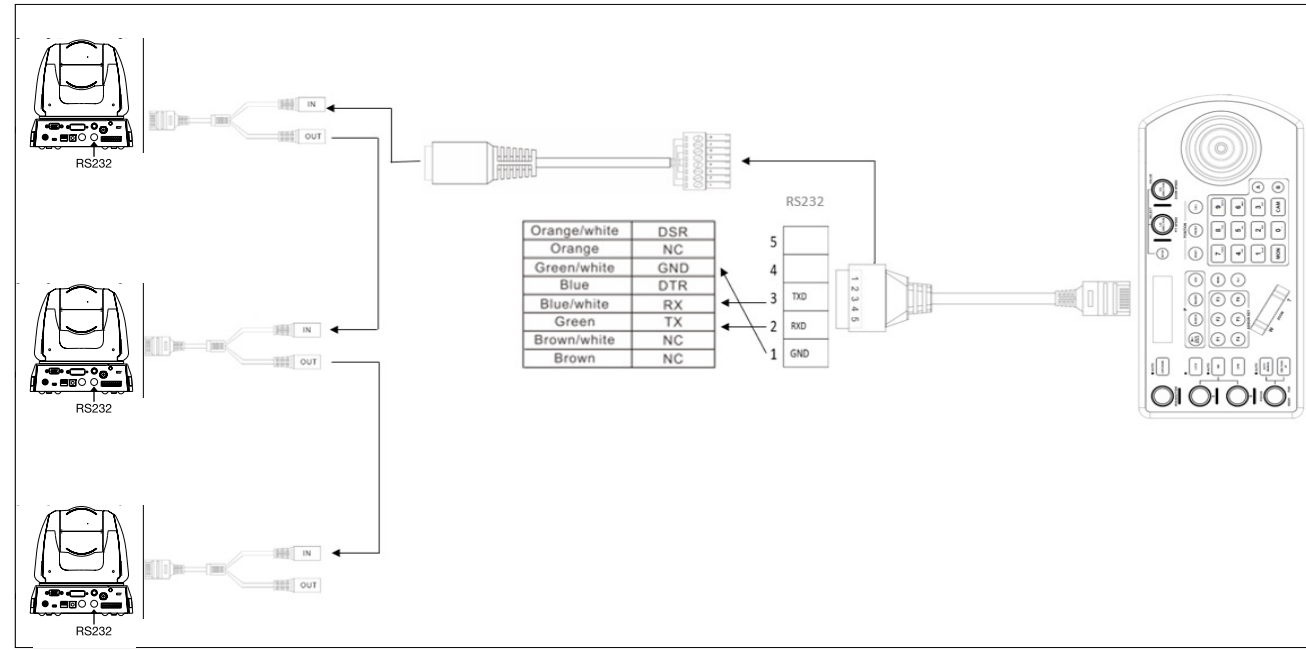

3. Use Junction Box (Marshall/Non-Marshall camera)

One-To-One:

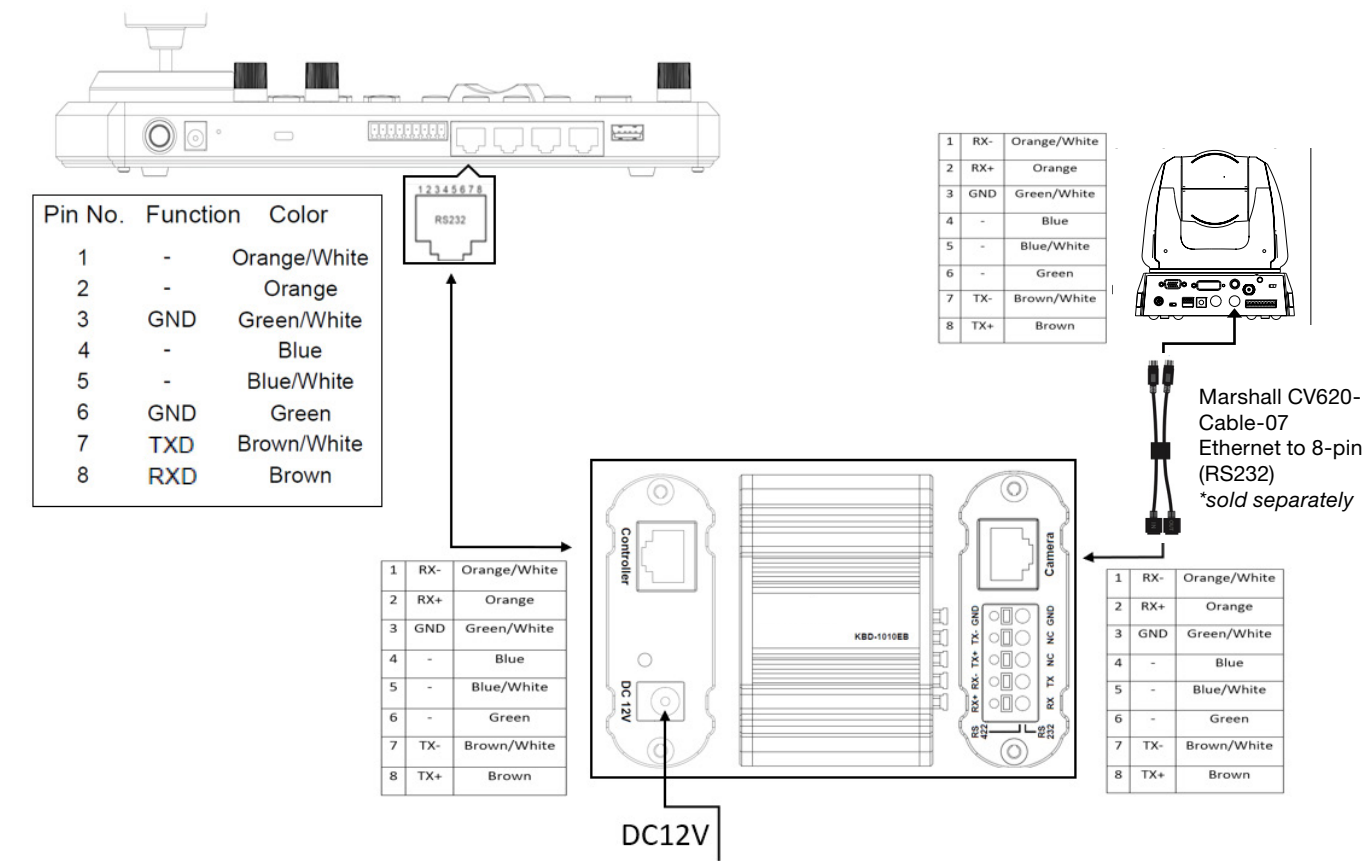

Marshall CV620-Cable-07
Ethernet to 8-pin (RS232)
*sold separately

Daisy Chain:

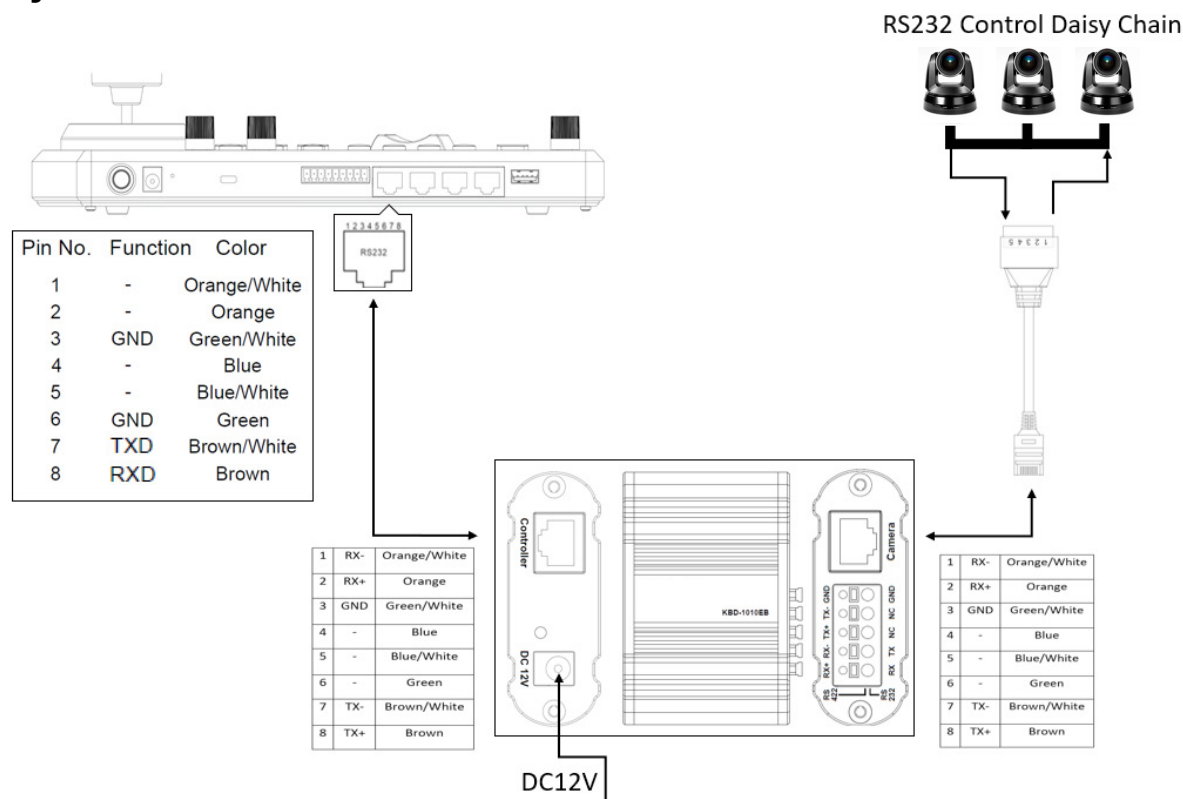

2. Use RJ45-RS422 adapter + control wire (Daisy Chain) (Marshall/Non-Marshall camera)

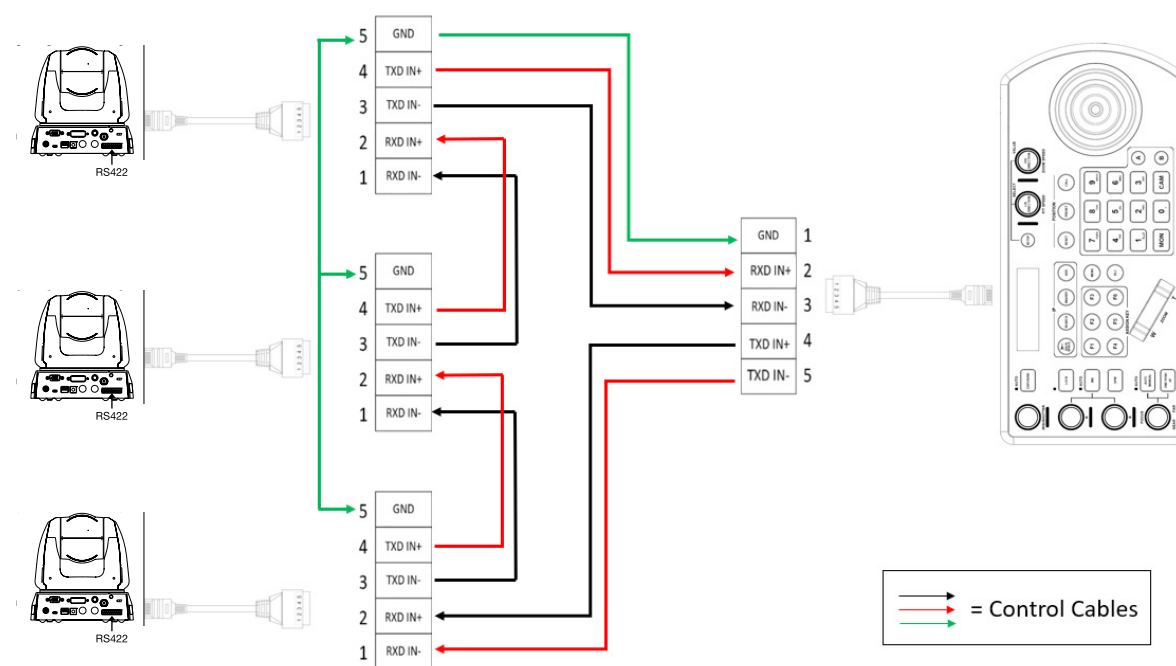

3. Use Junction Box (Marshall/Non-Marshall camera)

RS422 connection

- Follow the diagram below for the following options:
 - Use premade network cable direct connect (1 to 1 connection)

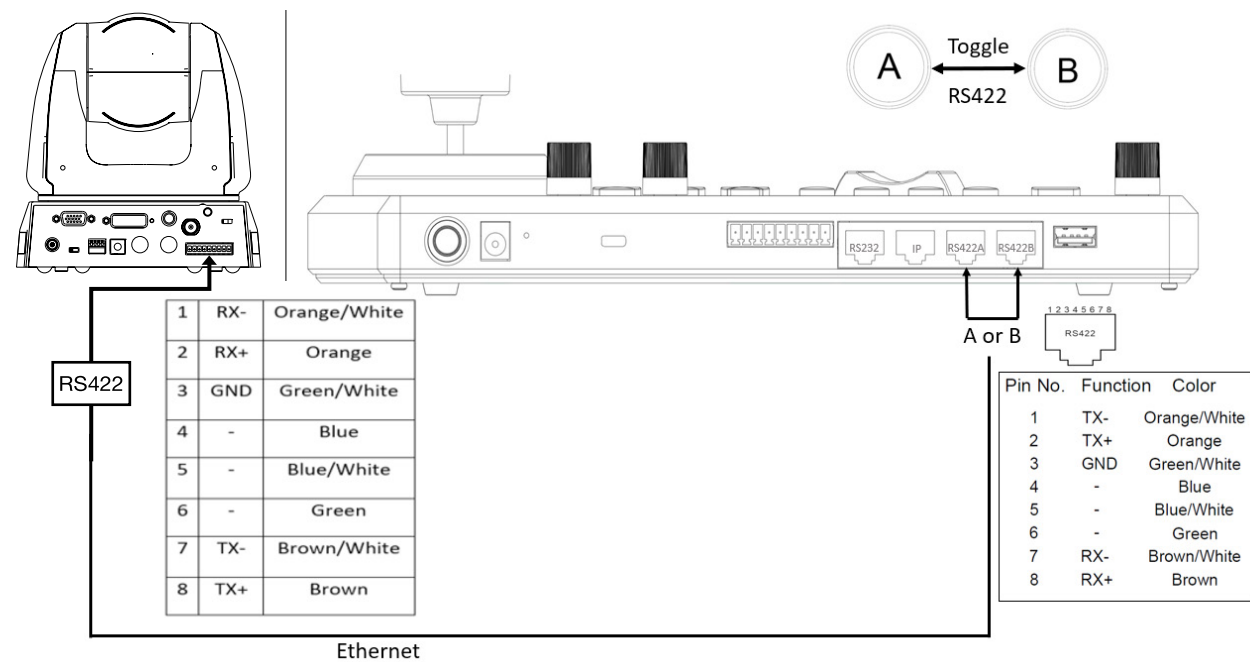

RS422 Control Daisy Chain

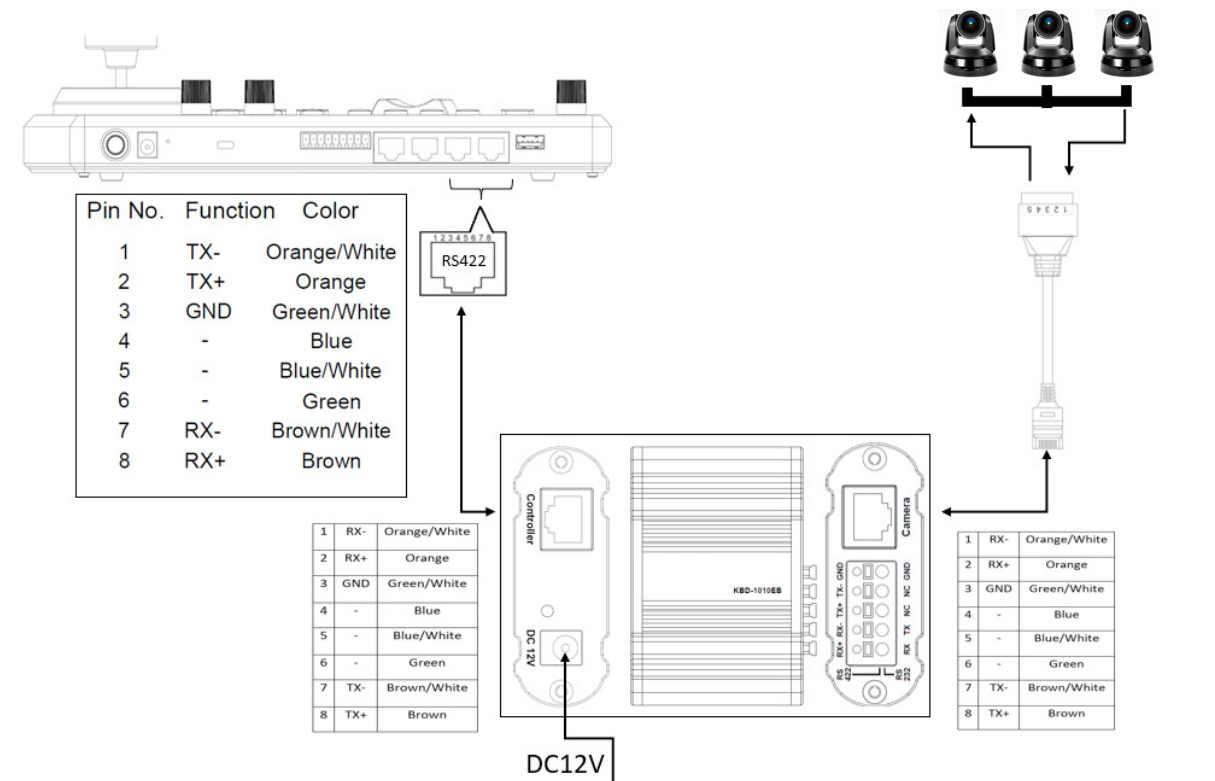

Make your own cable to connect (Use pinout) (Marshall/Non-Marshall camera)

RS485 connection

1. Follow the diagram below for the following options:

- Use premade network cable direct connect (1 to 1 connection)
- Make your own cable to connect (Use pinout) (Marshall/Non-Marshall camera)

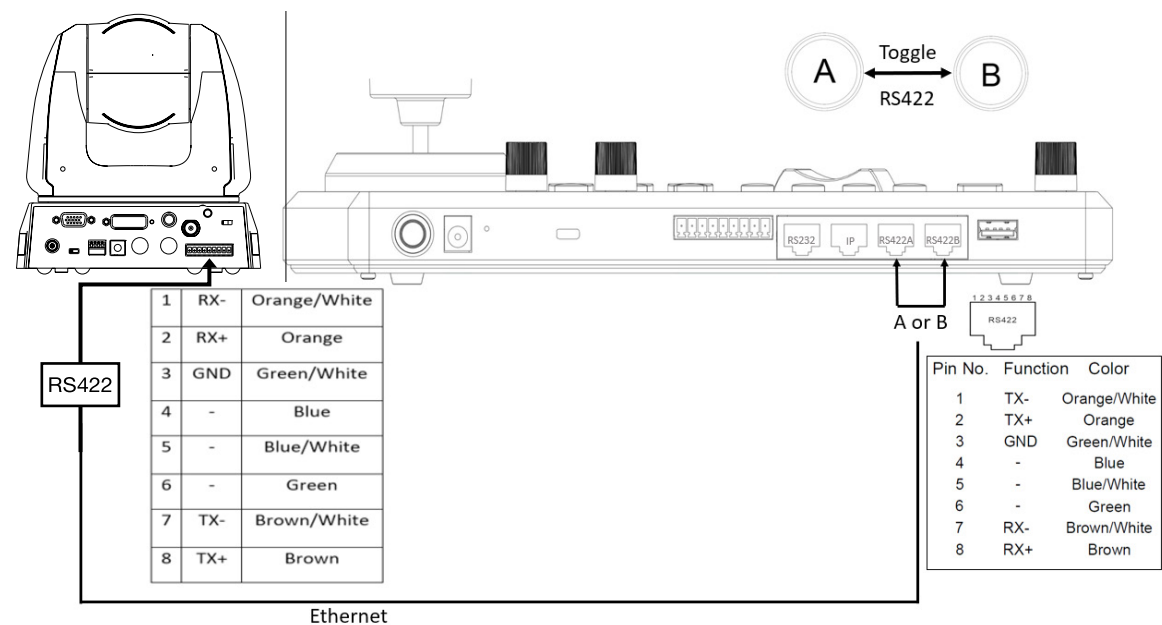

2. Use RJ45-RS422 adapter + control wire (Daisy Chain) (Marshall/Non-Marshall camera)

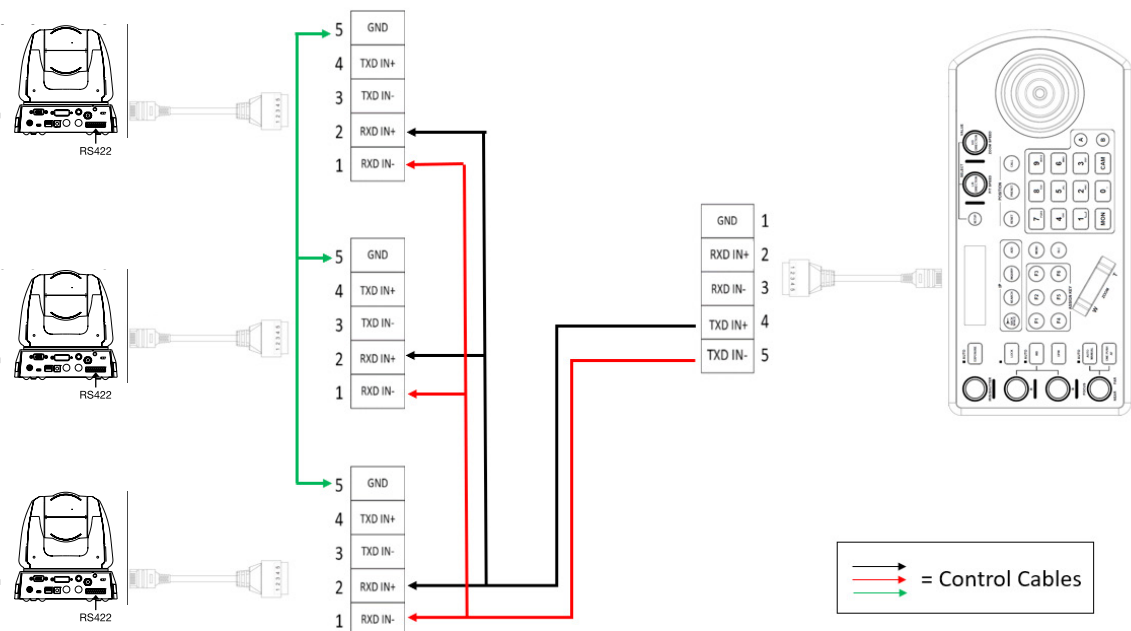

3. Use Junction Box (Marshall/Non-Marshall camera)

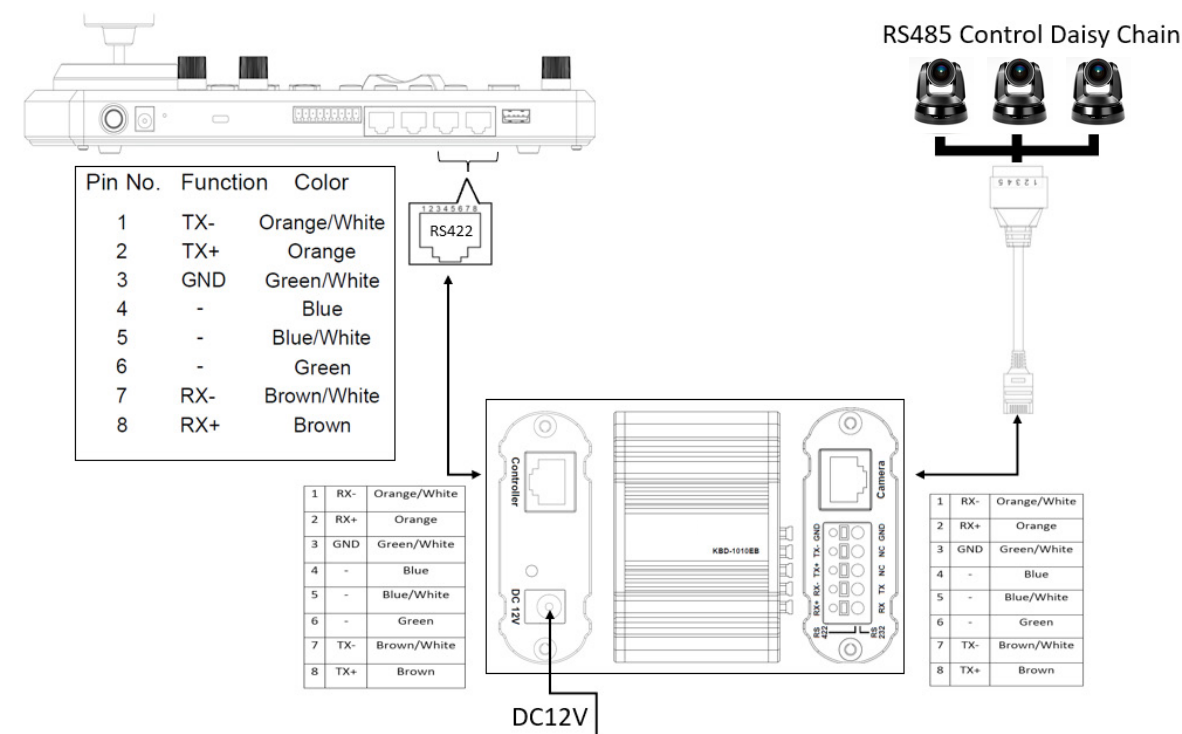

5. Keyboard Configuration

Interacting with the VS-PTC-IP

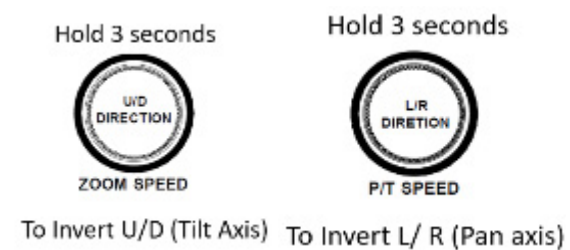

Setup Button:

P/T Speed Dial:

- Rotate: Move Cursor
- Click: Select
- Long Press: Invert L/R (pan axis)

Zoom Speed Dial:

- Rotate: Select Value
- Click: Save

- Long Press: Invert U/D (Tilt axis)

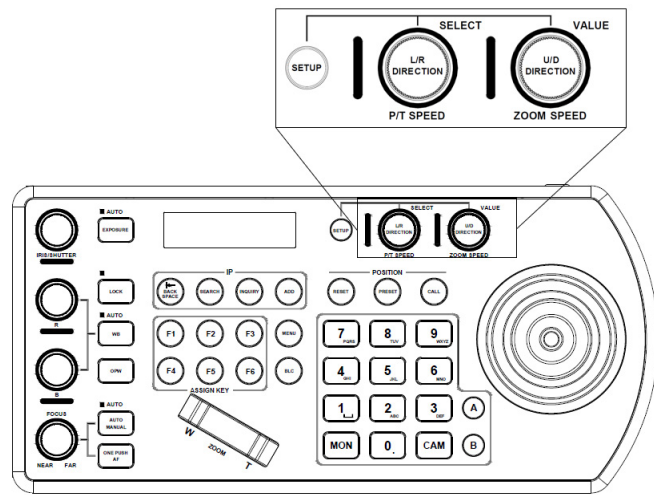

Keyboard Setup

Default Password: 0000

The password can be changed under

Setup > Keyboard Setting > Password Setting

Opens Menu on LCD screen

The Setup button opens the setup menu on the LCD screen

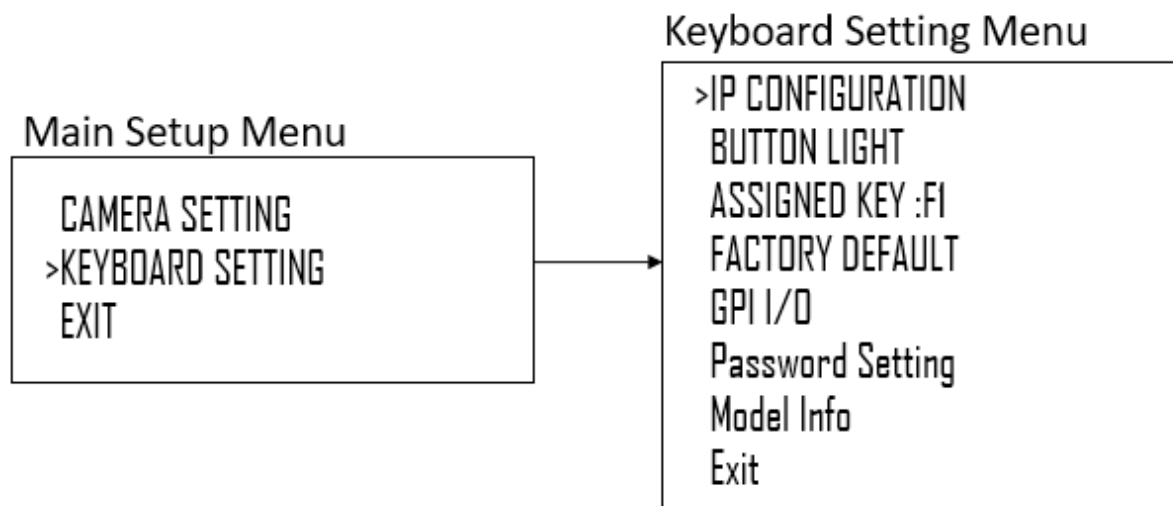

The IP address can be set to either STATIC or DHCP.

IP Configuration Menu

Keyboard Setting Menu

```
>IP CONFIGURATION
BUTTON LIGHT
ASSIGNED KEY :F1
FACTORY DEFAULT
```

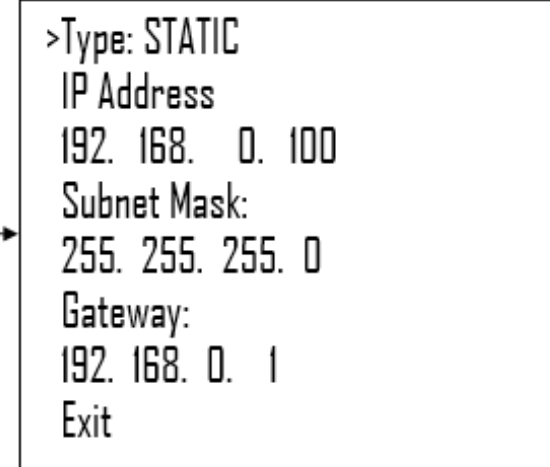

- If setting the IP address to DHCP, move the cursor to the Type field, and rotate the Zoom Speed dial to change the value to DHCP. Click the Zoom Speed dial to save
- If setting the IP address to a STATIC address, ensure that the Type field shows STATIC, and then rotate the P/T Speed dial to move the cursor between the IP address octets. Move the cursor to each octet and use the alphanumeric keypad to enter its value. Rotate the P/T Speed dial to move to the next octet and repeat until all IP address octets are set to the desired values.
- Click the Zoom Speed dial to save
- Edit the Subnet Mask and Gateway as necessary to communicate on your network
- Click the Zoom Speed dial to save
- Exit this menu

Button Light

The Button Light value affects the brightness of the button backlight

Keyboard Setting Menu

```
IP CONFIGURATION
>BUTTON LIGHT
ASSIGNED KEY :F1
FACTORY DEFAULT
```

Button Light Menu

```
>Level : 0
Exit
```

- Rotate the Zoom Speed dial to adjust the value
- Click the Zoom Speed Dial to save
- Exit this menu

Assign keys

Assigned keys can be configured as shortcuts to activate camera functions

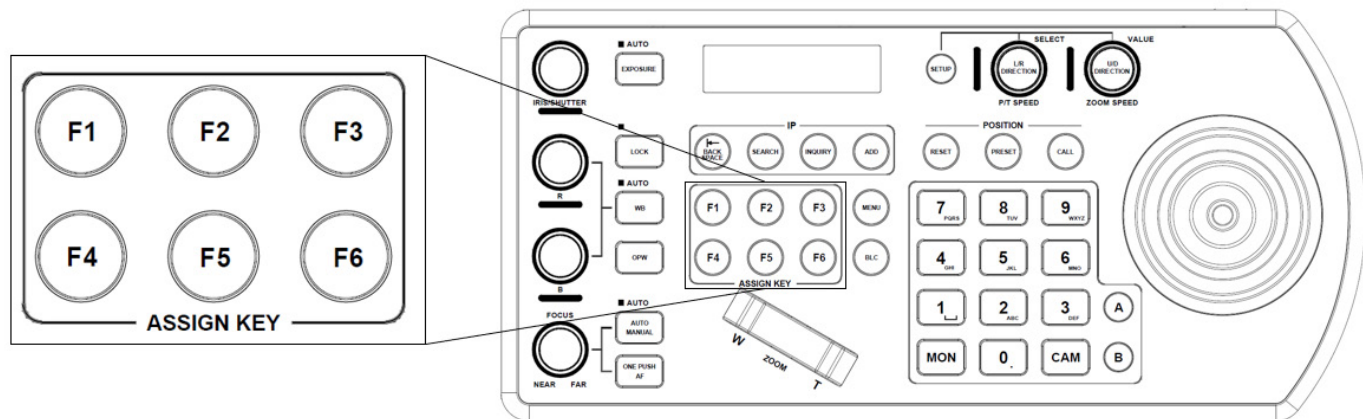

Keyboard Setting Menu

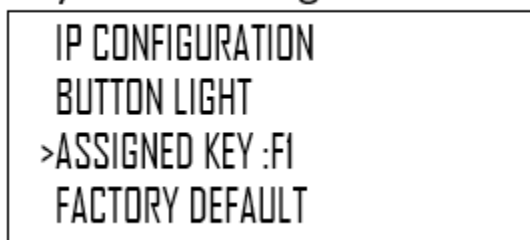

Assigned Key Menu

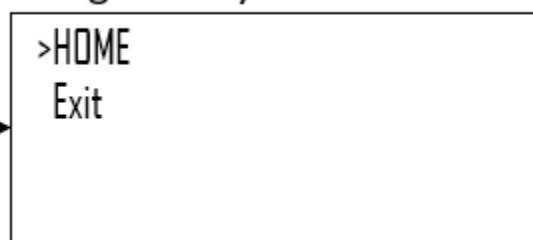

- From the keyboard Setup Menu, move the cursor to the ASSIGNED KEY field
- Rotate the Zoom Speed dial to select which Assigned key to configure
- Click the P/T Speed button to apply the function to the assign key
- Assigned key can be assigned to camera features from following:
 - **Home** – Command the selected camera to activate its ‘Home’ preset
 - **P/T Reset** – Reset the selected camera
 - **Power** – Power off the selected camera
 - **Mute** – Mute the audio from the selected camera
 - **Picture Freeze** – Freeze the image of the selected camera
 - **Picture Flip** – Flip the image of the selected camera
 - **Picture LR Reverse** – Invert the L/R (pan direction) of the selected camera
- Exit

Factory Default

Clear all keyboard settings, and restore factory default

Keyboard Setting Menu

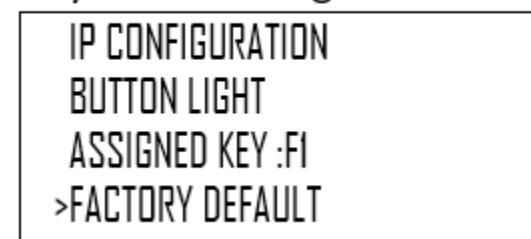

Factory Default

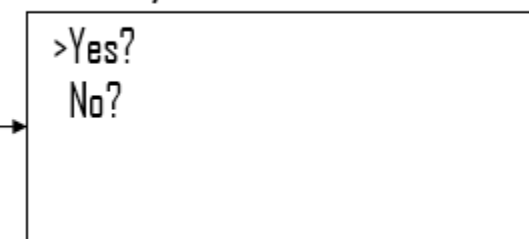

- From the Keyboard Setup Menu, select FACTORY DEFAULT
- Select Yes

NOTE: DO NOT move the Joystick nor the Zooming Seesaw and leave them at original position while the FACTORY DEFAULT is processing.

GPI I/O

GPI I/O Menu is used to configure the Tally settings

Keyboard Setting Menu

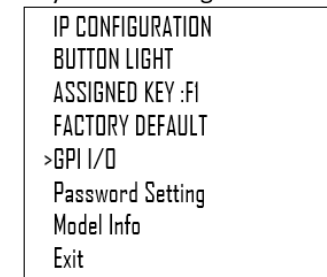

Tally Setting Menu

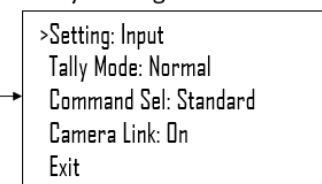

Setting:

- **Input** - Sets the control signal direction of the GPI I/O connector to INPUT. In this case, connect a tally control input signal to the connector
- **Output** - Sets the control signal direction of the GPI I/O connector to OUTPUT. In this case, the connector functions as a contact output connector which outputs the camera number of the target camera.

Tally Mode

- **Normal** - Displays the tally input lamp corresponding to the number of the camera with tally input ON, and automatically selects the camera as the target camera.
- **On Air** - Displays the tally input lamp corresponding to the number of the camera with tally input ON.

Command Select:

- **Standard** - Sets the input/output method to STANDARD method. The camera numbers and input/output pin numbers have a 1:1 correspondence.
 - If the unit and cameras are connected by serial connection, cameras 1 to 7 correspond to input/outputs 1 to 7.
 - If the unit and cameras are connected by LAN connection, cameras 1 to 10 in group 1 correspond to input/outputs 1 to 10.

- Expand - Handles camera numbers as binary numbers.
 - Tally input numbers 8 and higher in a serial connection are ignored. In this case, the response is equivalent to no input.
 - Numbers in a LAN connection, corresponding to cameras 1 to 10 in groups 1 to 10, are handled as the numbers 1 to 100. Tally input numbers 101 and higher are ignored. In this case, the response is equivalent to no input.

Camera Link - Turns tally lamp control on/off. The tally lamp control operation varies depending on the combination of the SETTING and CAMERA LINK settings. For details, see "Tally lamp control operation" below.

6. Password Setting

Keyboard Setting Menu

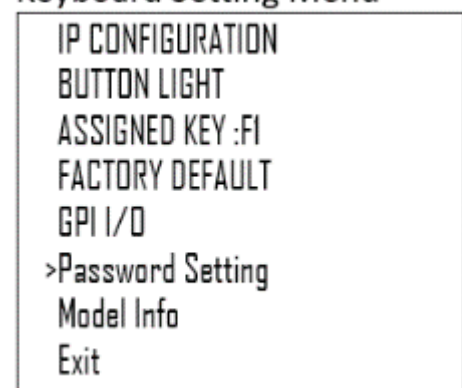

Password Setting Menu

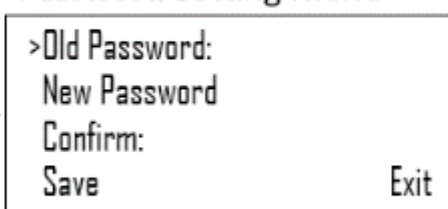

- Old Password: Enter the current password
- New Password: Enter the password you would like to set
- Confirm: Enter the new password again to confirm
- Save: Select this to apply the password. "OK" will appear, confirming that the new password has been applied

Model Info

Keyboard Setting Menu

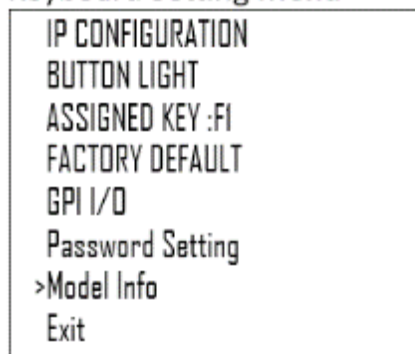

Model Info Menu

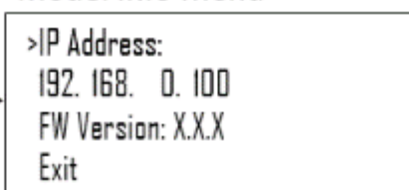

The Model info screen contains the current IP address and Firmware Version of the unit

How to assign camera

Manually adding cameras

Main Setup Menu

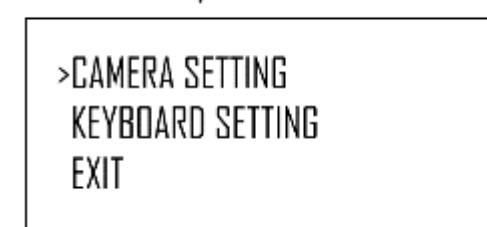

Camera Setting Menu

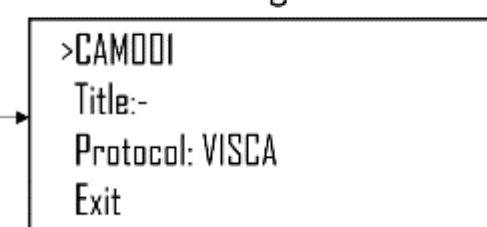

The keyboard can store settings to control up to

- 255 cameras by RS485 PELCO protocol separately
- 7 cameras by VISCA protocol via RS422 group A separately
- 7 cameras by VISCA protocol via RS422 group B separately
- 255 cameras by IP ONVIF protocol separately
- 255 cameras by VISCA-Over-IP protocol separately
- Total 255 cameras by cross protocol mix-controlling.

With the cursor on the Camera Selection, use the Zoom Speed dial to select which camera slot to assign a camera.

Each camera can be configured to be controlled using any of the following protocols:

- VISCA
- PELCO-D
- PELCO-P
- ONVIF
- VISCAIP (VISCA over IP)

Camera Setting Menu

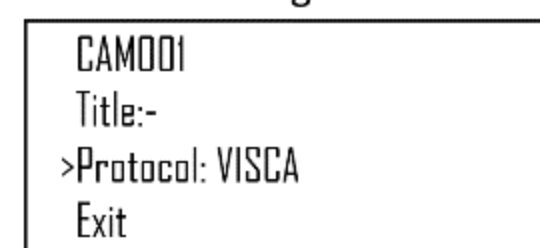

Baud Rate Setting

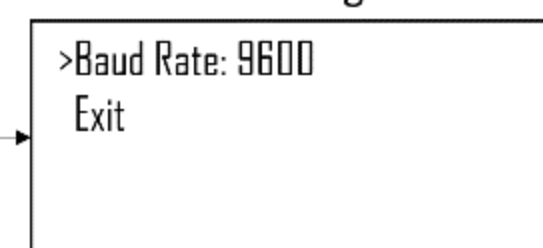

If VISCA, PELCO-D, or PELCO-D are selected as the protocol, the Baud Rate Setting screen will appear. Use the Zoom Speed dial to set the baud rate. Click the Zoom Speed dial to save, and then exit this menu.

Adding an ONVIF camera to Keyboard

Adding manually from Local Area Network (LAN)

Selecting ONVIF as the protocol and clicking the P/T Speed dial will cause the ONVIF Camera Setup menu to appear

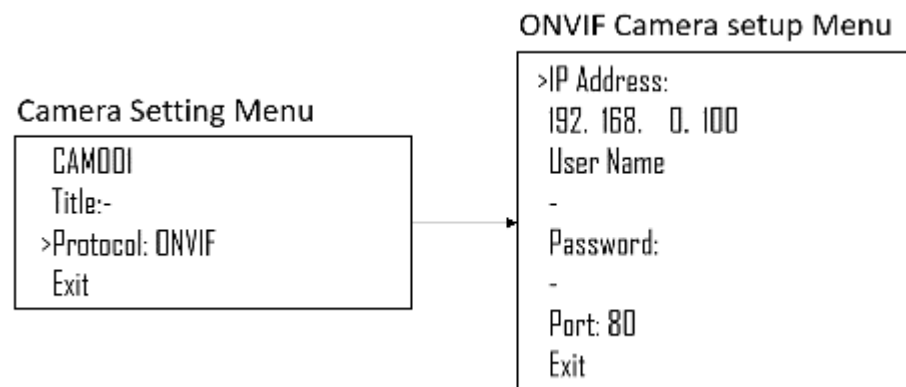

- Must know about the IP address of the camera.
- The IP address of the camera has to be within the same subnet as the Keyboard
- Rotate the P/T Speed dial to move the cursor between the IP address octets. Move the cursor to each octet and use the alphanumeric keypad to enter its value. Rotate the P/T Speed dial to move to the next octet and repeat until all IP address octets are set to the desired values. Click the Zoom Speed dial to save
- Move the cursor to the User Name field, and use the alphanumeric keypad to enter the username (ESC button works as a backspace)
- Click the Zoom Speed button to save
- Move the cursor to the password field and use the alphanumeric keypad to enter the password (ESC button works as a backspace)
- Click the Zoom Speed button to save
- Move the cursor to the Port field
- If the camera is configured to communicate on a field other than port 80, change the port number using the alphanumeric keypad (ESC button works as a backspace)
- Exit this menu

Scanning Local Area Network (LAN) for available ONVIF cameras

Cameras can be detected on the network and added to the keyboard to be controlled

- Press the Search button to bring up the Auto Search menu
- Move the cursor to ONVIF-IP
- Select Yes to start the search
- A list of discovered cameras will appear showing the cameras that have been discovered. Scroll through the discovered cameras using the Zoom Speed dial
- To add a camera to be controlled by the VS-PTC-IP, press the ADD button
- With the cursor on CAM ID, Assign the camera to a CAM ID by rotating the Zoom Speed dial
- Click the Zoom Speed dial to save

- Move the cursor to the Title, and use the alphanumeric keypad to give the camera a title
- Click the Zoom Speed dial to save
- Enter the username for the camera
- Click the Zoom Speed dial to save
- Enter the password for the camera
- Click the Zoom Speed dial to save
- Exit this menu

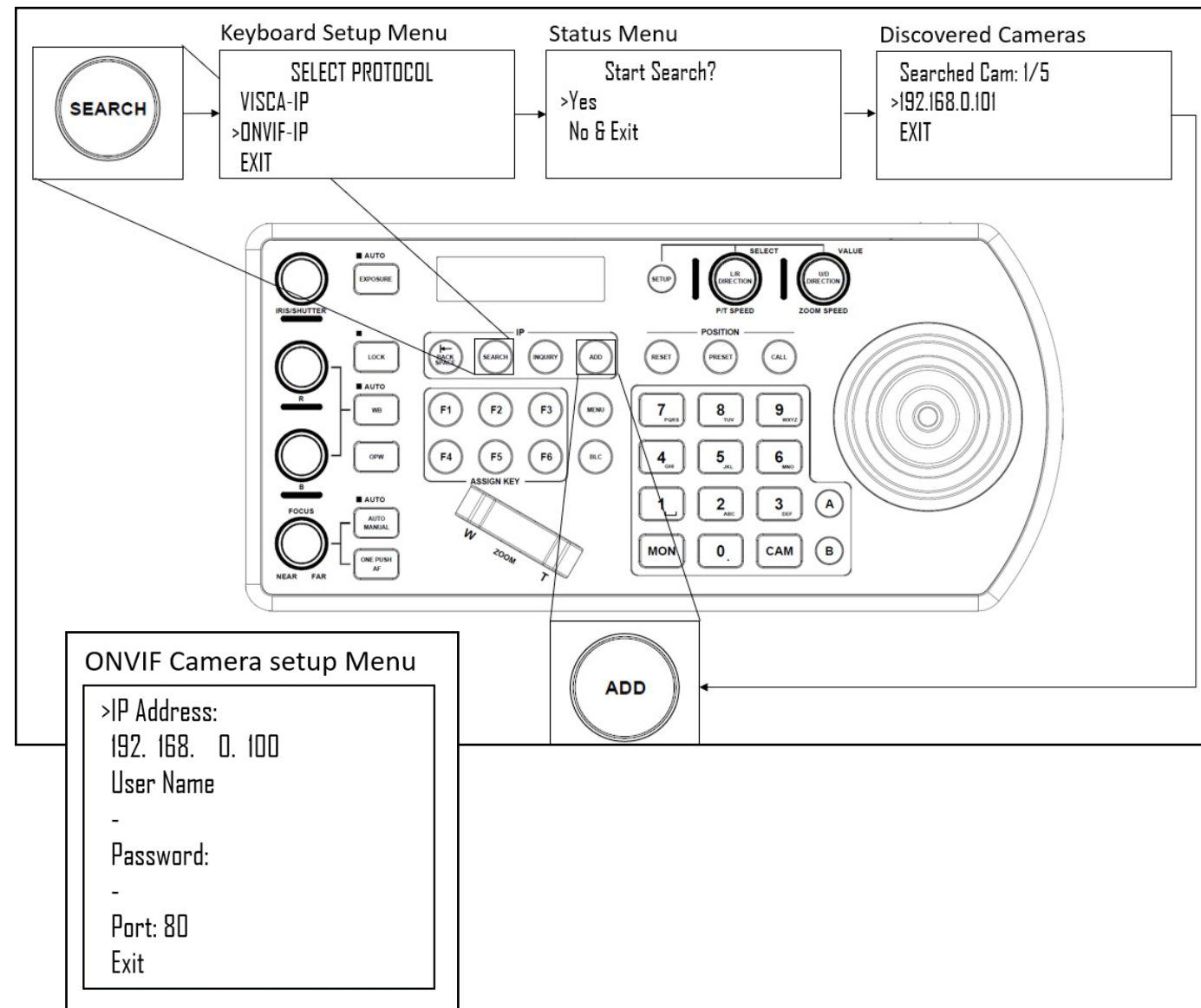

Repeat this process for each discovered camera that you wish to add to the VS-PTC-IP

Adding ONVIF cameras to be controlled via WAN

1. At Camera Location:

- For commands to flow from outside the network in to a camera, ports must be opened
- Contact the network administrator at the camera location to create a port-forwarding rule in the router allowing commands to flow through the necessary ports using these values:
 - Source/ external port: 80 (default)
 - Destination / internal port: 80 (default)
 - IP Address: IP Address of the camera
 - Protocol: Both (TCP and UDP)

2. At Keyboard location:

- Set the keyboard to DHCP
- Contact the network administrator at the Keyboard location to create a port-forwarding rule in the router allowing commands to flow through the necessary ports using these values:
 - Source/ external port: 80 (default)
 - Destination / internal port: 80 (default)
 - IP Address: IP Address of the keyboard
 - Protocol: Both (TCP and UDP)
- Within the Setup menu of the VS-PTC-IP, add the ONVIF camera using the WAN IP of the camera location as the IP Address
- Click the P/T Speed dial to save
- Enter the username of the camera
- Click the P/T Speed dial to save
- Enter the password of the camera
- Click the P/T Speed dial to save

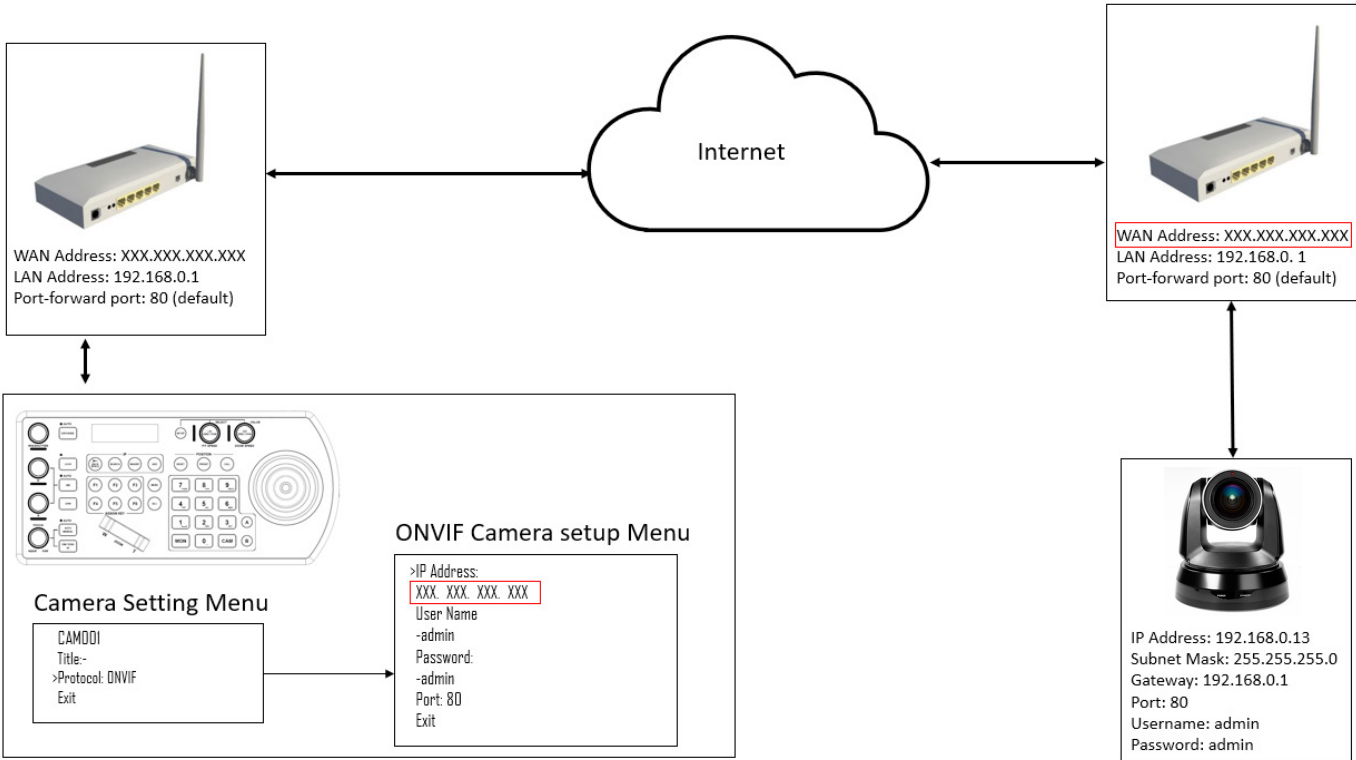

Adding a VISCA over IP camera to Keyboard

Adding manually from Local Area Network (LAN)

Selecting VISCAIP (VISCA over IP) as the protocol and clicking the P/T Speed dial will cause the VISCAIP configuration menu to appear

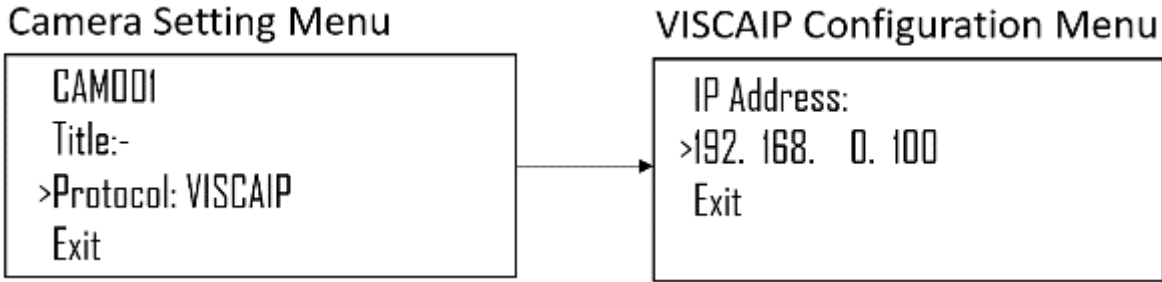

- Rotate the P/T Speed dial to move the cursor between the IP address octets. Move the cursor to each octet and use the alphanumeric keypad to enter its value. Rotate the P/T Speed dial to move to the next octet and repeat until all IP address octets are set to the desired values.
- Click the Zoom Speed dial to save
- Exit this menu

Repeat this process for each camera that you wish to control with the VS-PTC-IP keyboard.

Scanning local network for available VISCA over IP cameras

- Press the Search button to bring up the Auto Search menu
- Move the cursor to VISCA-IP
- Select Yes to start the search
- A list of discovered cameras will appear showing the cameras that have been discovered. Scroll through the discovered cameras using the Zoom Speed dial
- To add a camera to be controlled by the VS-PTC-IP, press the ADD button
- With the cursor on CAM ID, Assign the camera to a CAM ID by rotating the Zoom Speed dial
- Click the Zoom Speed dial to save
- Move the cursor to the Title, and use the alphanumeric keypad to give the camera a title
- Click the Zoom Speed dial to save

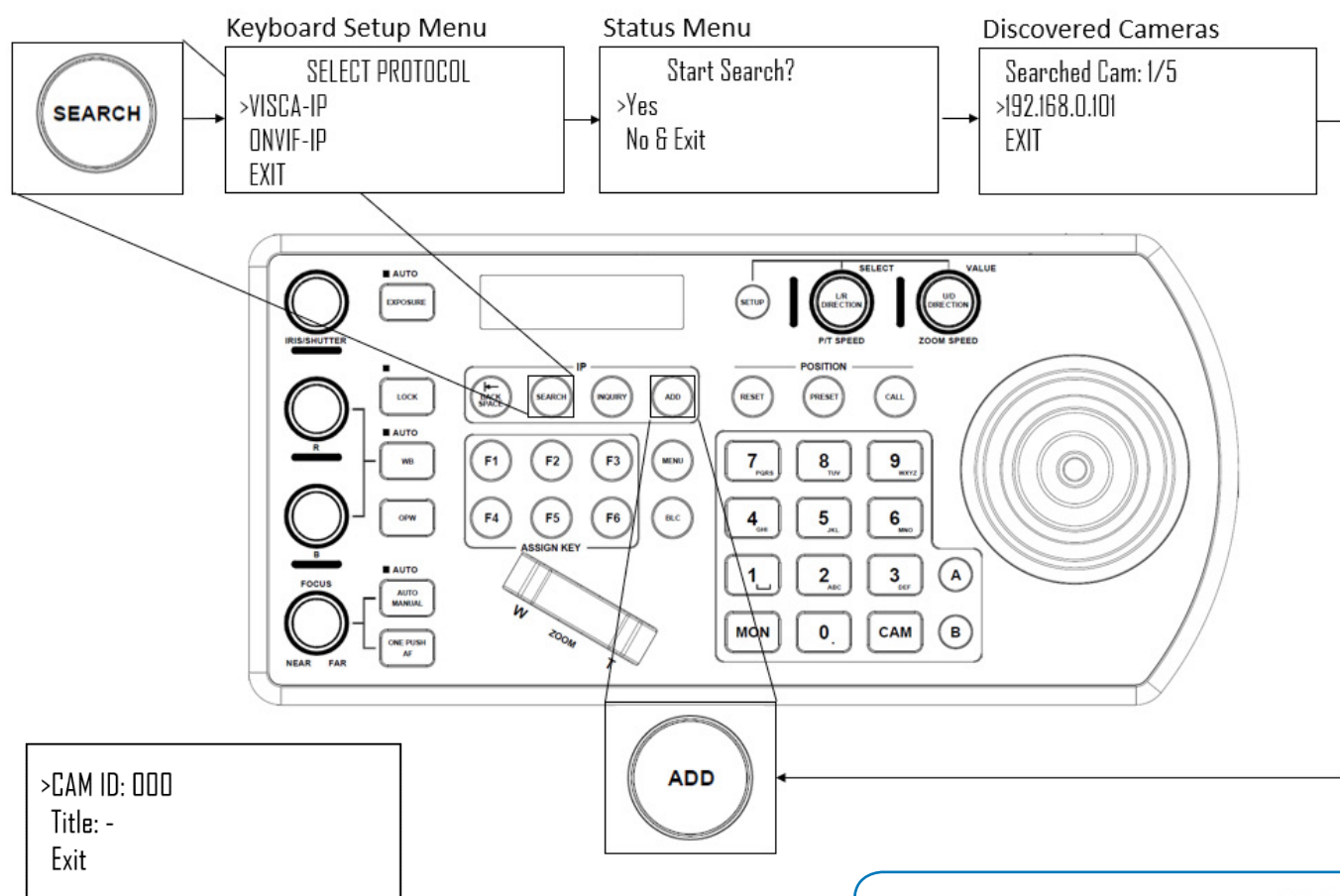

Repeat this process for each discovered camera that you wish to add to the VS-PTC-IP

Note: Visca over IP requires that all of the Camera Address Selectors on camera-side be set to "1". This would apply to all IP cameras being setup over IP and controlled by VS-PTC-IP controller. On the Marshall CV620-IP, CV620-NDI, CV630-IP, CV630-NDI and other Marshall IP PTZ cameras the Camera Address Selector DIAL is found under camera base (see right).

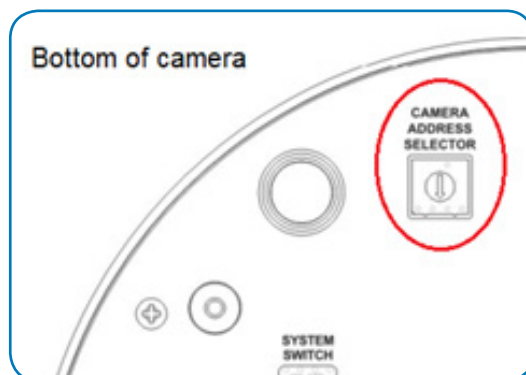

Adding VISCA over IP cameras to be controlled via WAN

3. At Camera Location:

- For commands to flow from outside the network into a camera, ports must be opened
- Contact the network administrator at the camera location to create a port-forwarding rule in the router allowing commands to flow through the necessary ports using these values:
 - Source/ external port: 52381
 - Destination / internal port: 52381
 - IP Address: IP Address of the camera
 - Protocol: Both (TCP and UDP)

4. At Keyboard location:

- Set the keyboard to DHCP
- Contact the network administrator at the Keyboard location to create a port-forwarding rule in the router allowing commands to flow through the necessary ports using these values:
 - Source/ external port: 52381
 - Destination / internal port: 52381
 - IP Address: IP Address of the keyboard
 - Protocol: Both (TCP and UDP)
- Within the Setup menu of the VS-PTC-IP, add the VISCA over IP camera using the WAN IP of the camera location as the IP Address
- Click the P/T Speed dial to save

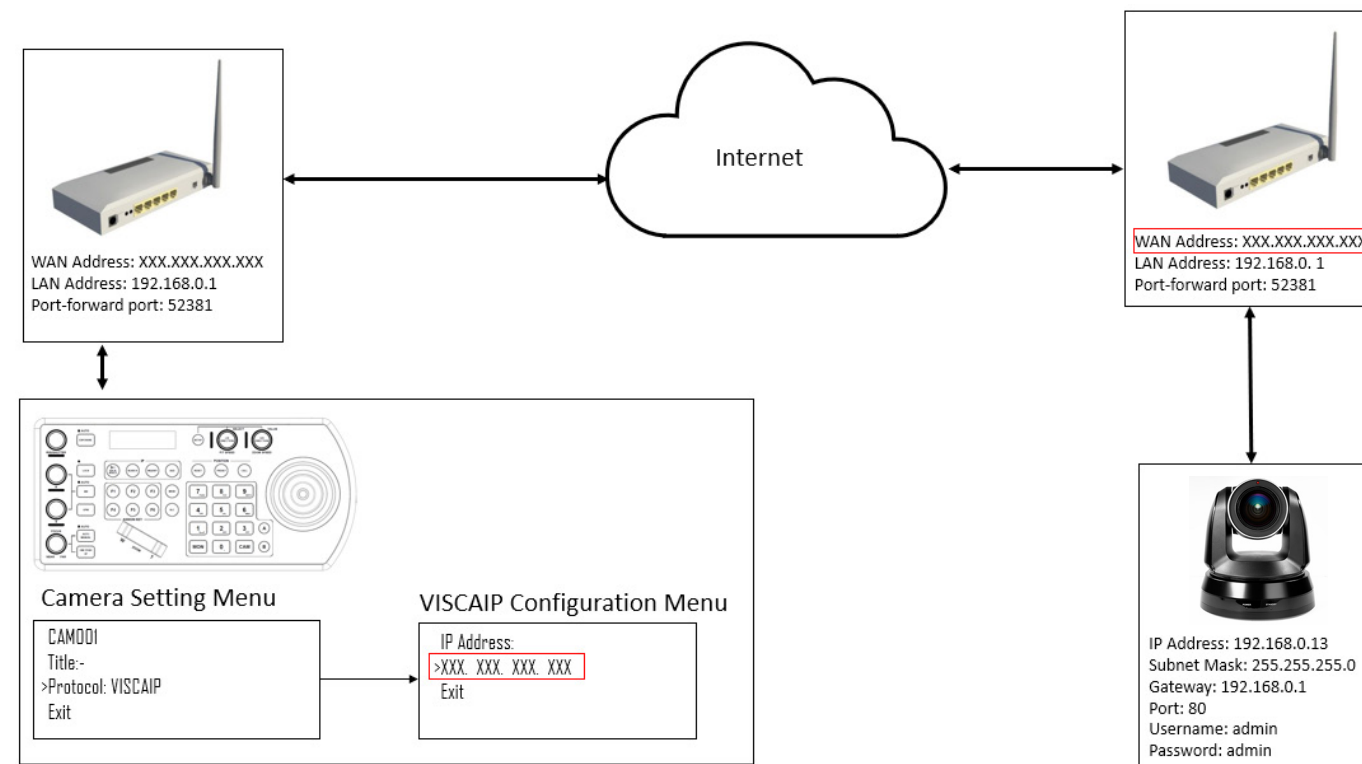

7. Interacting with Cameras

RS422 A button and RS422 B button

There are 2 RS422 ports on the back panel of the keyboard. Up to 7 cameras can be daisy chained off of each RS422 port. You can toggle between these by using the A and B buttons

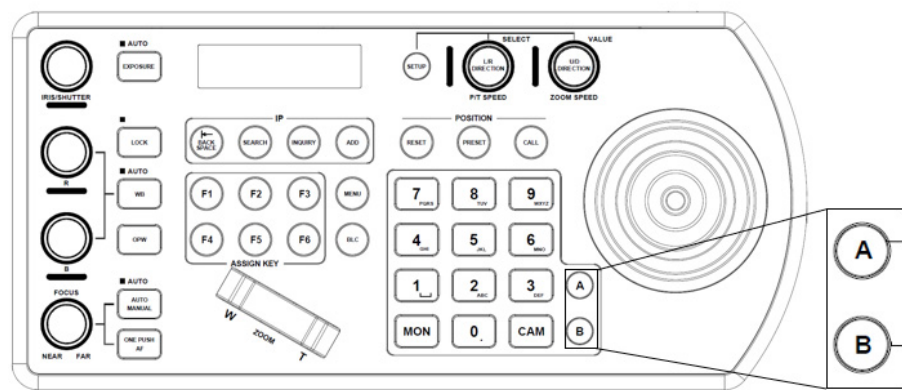
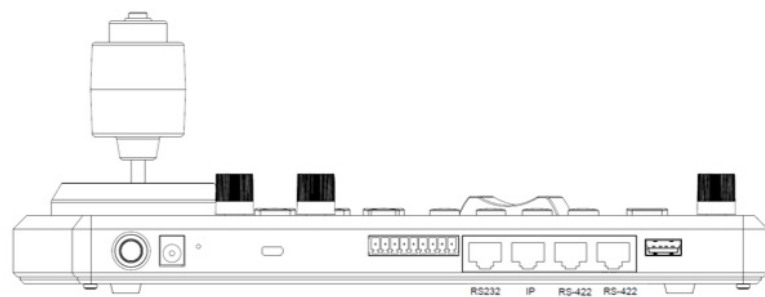

Options for calling camera

1. Use the keypad to call the camera by CAM ID
 - Enter the CAM ID on the keypad
 - Press CAM

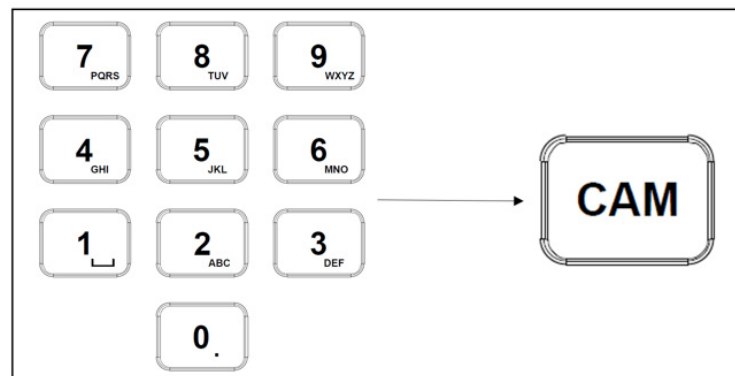

2. Call the IP cameras by selecting from a list of available devices
 - Press the Inquiry button
 - Select a protocol
 - Scroll through the list using the Zoom Speed dial
 - Move the cursor to "Call", and click the P/T Speed dial

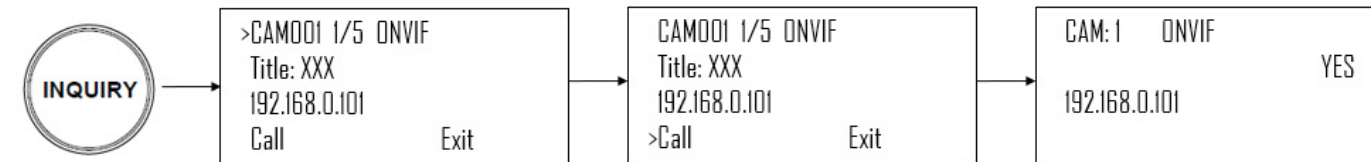

Controlling a Camera

Engaging the Camera OSD Menu for non-IP cameras

1. Press the Menu button on the keyboard to send a command to the camera to engage the OSD menu
2. Navigate the menu by using the joystick
 - Move up / down to navigate through menu options
 - Move the joystick to the right to send an "enter" command
 - Move up / down to adjust values
 - Move the joystick to the left to send an "exit" command

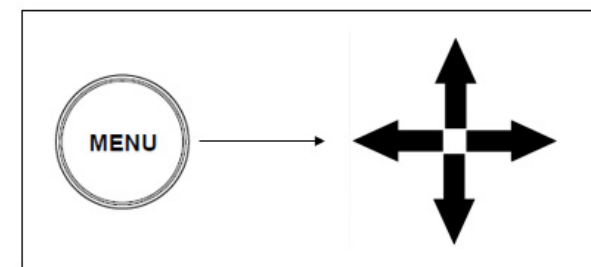

Engaging the Camera OSD Menu for PELCO-D or ONVIF-IP Cameras

1. On the alphanumeric keypad, call preset 95 to engage the menu (type 95, and then press the "Call" button)



Manual Movements

- Pan, Tilt, and Zoom movements can be executed simultaneously
- The joystick can be used to pan / tilt the camera in any direction
- The joystick handle can be rotated to zoom in / zoom out
- When not in a menu, the P/T Speed and Zoom Speed dials control how fast the camera Pans, Tilts, and Zooms in response to commands from the keyboard
- The Zoom Seesaw can be engaged to zoom in / Zoom out

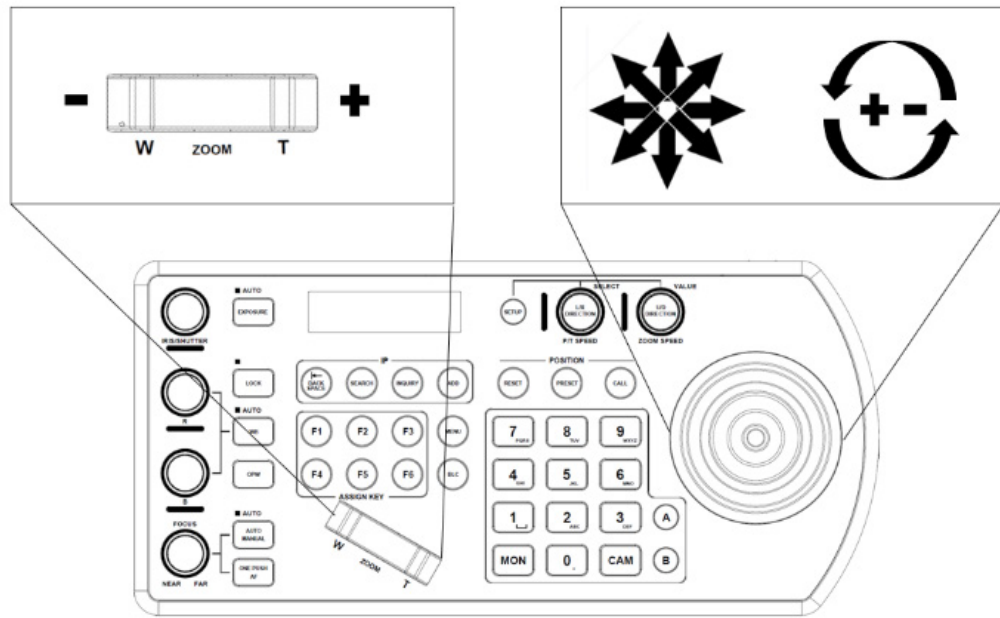

Setting and calling presets

Setting / creating presets:

1. Move the camera to the desired position
2. Enter the desired preset number on the alphanumeric keyboard, and then hold the Preset button for 3 seconds to save

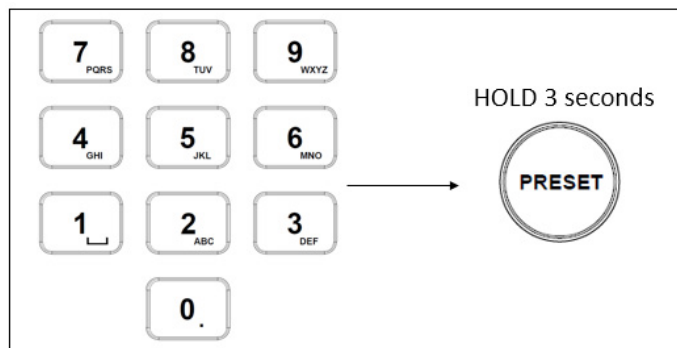

Calling presets:

1. Enter the desired preset number on the alphanumeric keypad
2. Press the Call button

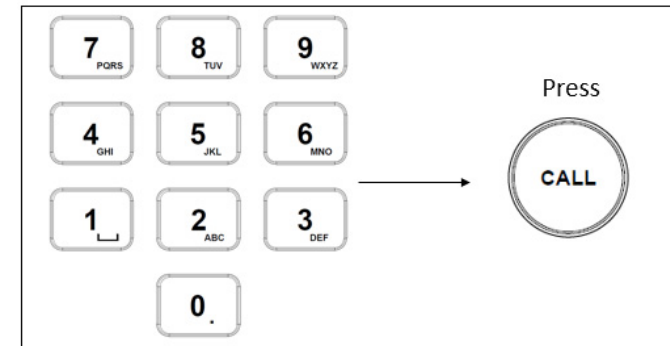

Resetting / Clearing presets:

1. Enter the number of the preset you would like to clear
2. Press the Reset button

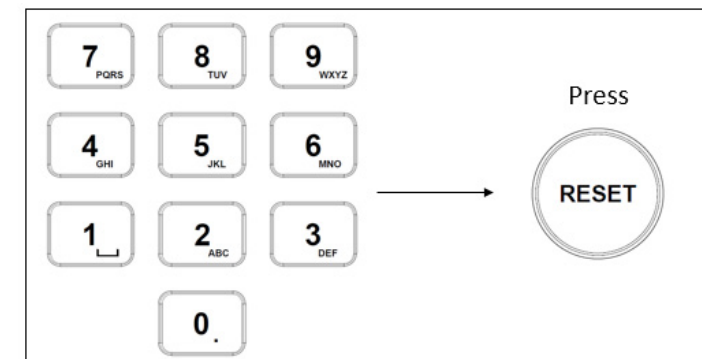

Adjusting image parameters

The following image parameters can be set/adjusted by using the Image Adjustment Panel

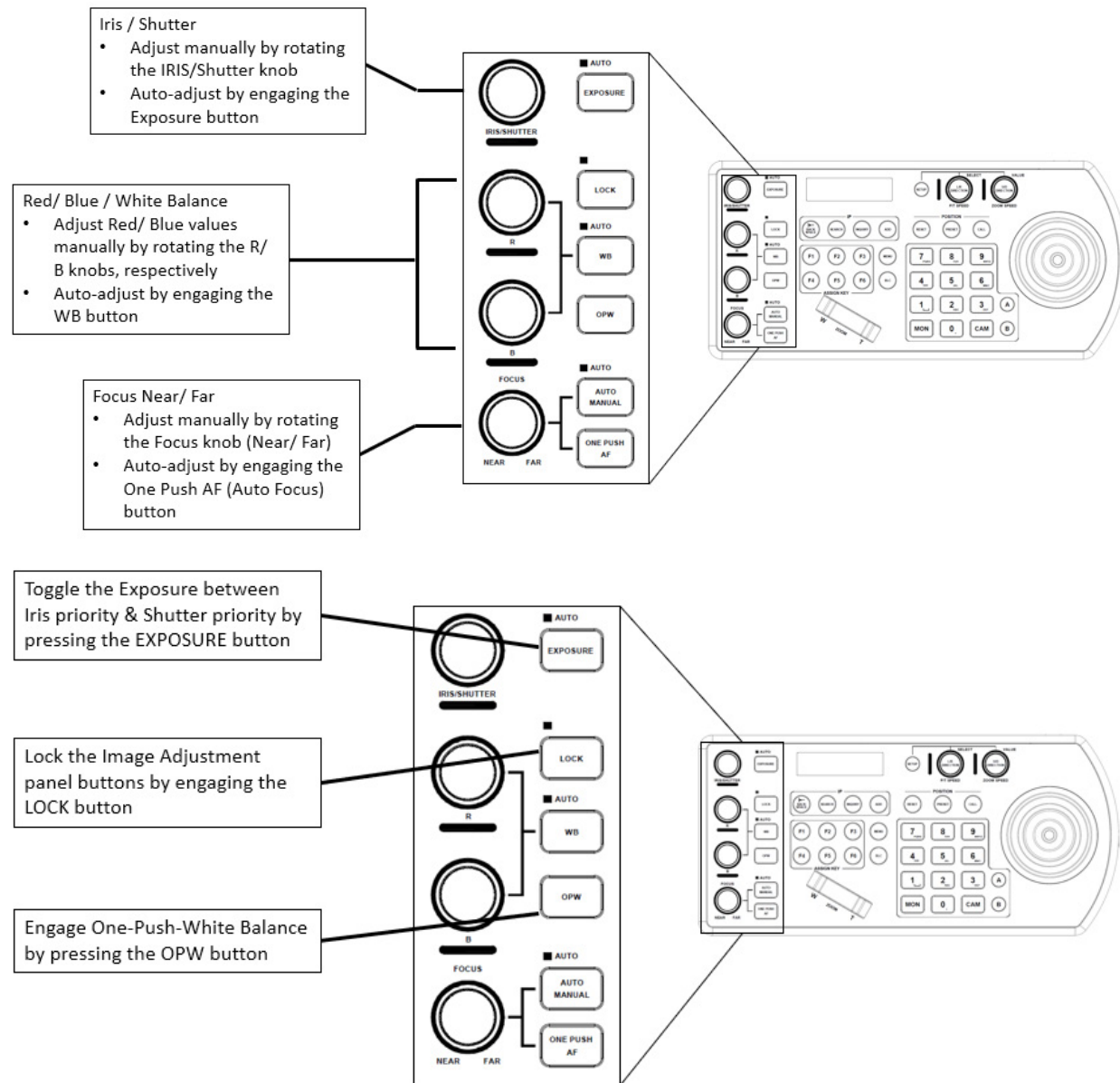

8. Firmware Upgrade

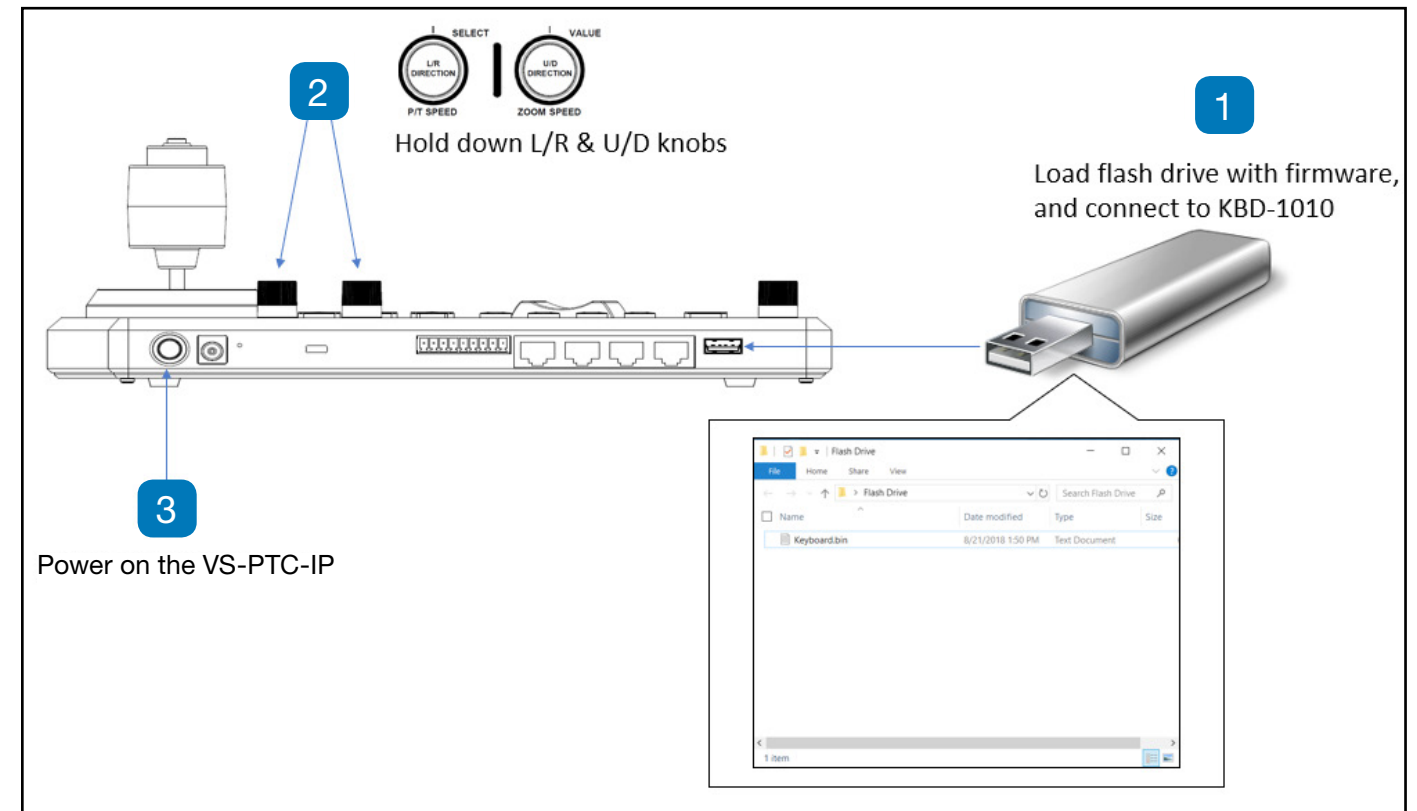

The latest firmware files are available for download at www.marshall-usa.com

This process begins with the keyboard powered off.

1. Load a flash drive with the “.bin” firmware file in the root directory (not inside of a folder), and place the flash drive into the USB port on the back panel of the VS-PTC-IP.
2. Hold down the L/R Direction knob and the U/D Direction Knob
3. While holding the knobs down, power on the keyboard by clicking the power button into the “On” position. The keyboard will display a confirmation that the upgrade is taking place
4. When the upgrade is finished, power cycle the keyboard

9. Dimensions

Junction Box

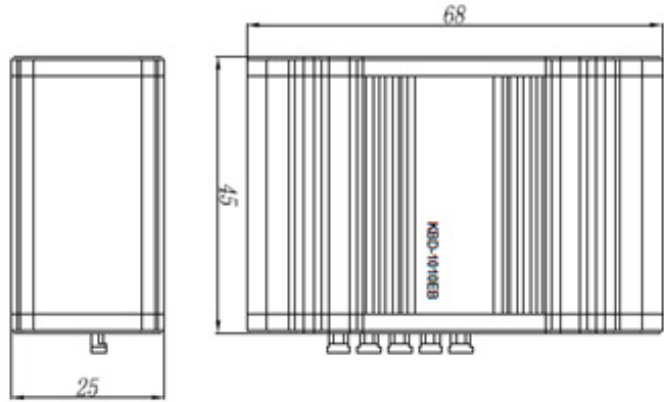

VS-PTC-IP dimensions

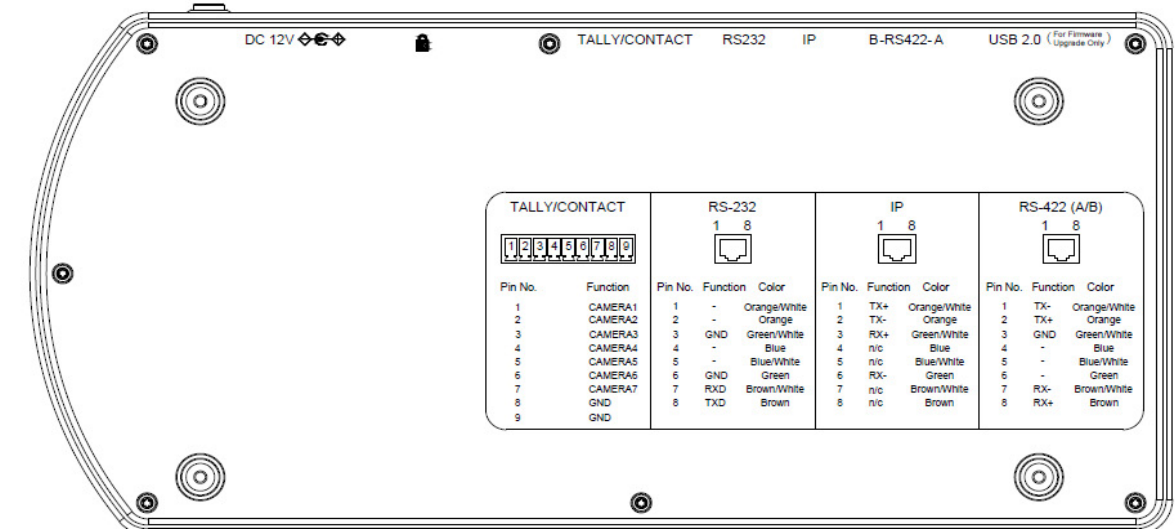
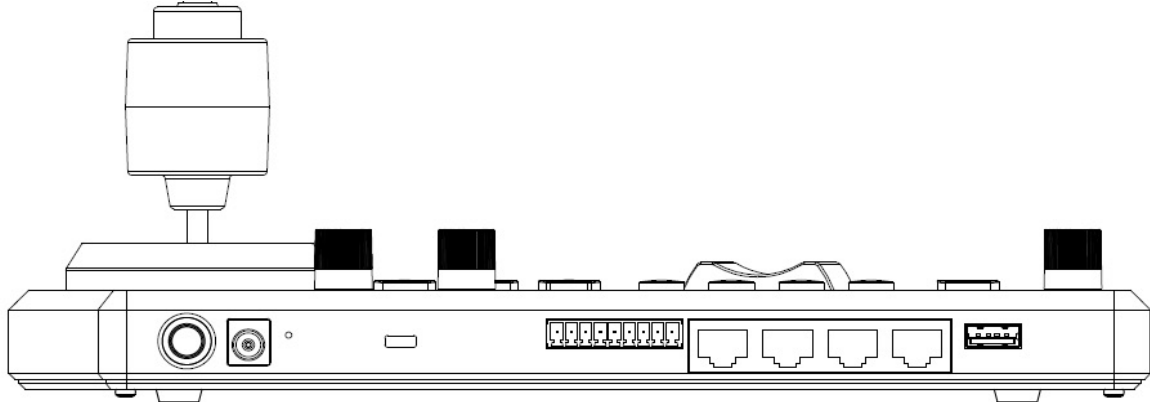
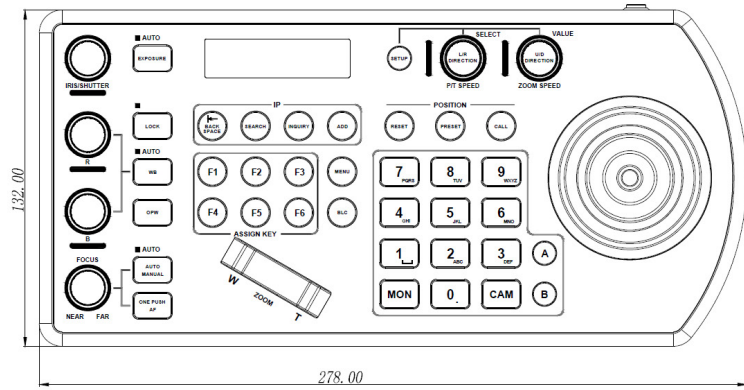
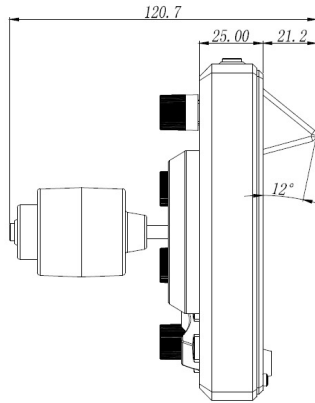

Unit: mm

Warranty

Marshall Electronics warrants to the first consumer that this device will, under normal use, be free from defects in workmanship and materials, when received in its original container, for a period of two years from the purchase date. This warranty is extended to the first consumer only, and proof of purchase is necessary to honor the warranty. If there is no proof of purchase provided with a warranty claim, Marshall Electronics reserves the right not to honor the warranty set forth above. Therefore, labor and parts may be charged to the consumer. This warranty does not apply to the product exterior or cosmetics. Misuse, abnormal handling, alterations or modifications in design or construction void this warranty. No sales personnel of the seller or any other person is authorized to make any warranties other than those described above, or to extend the duration of any warranties on behalf of Marshall Electronics, beyond the time period described above.

Due to constant effort to improve products and product features, specifications may change without notice.

Marshall

20608 Madrona Avenue, Torrance, CA 90503

Tel: (800) 800-6608 / (310) 333-0606 • Fax: 310-333-0688

www.marshall-usa.com

support@marshall-usa.com