

# datavideo

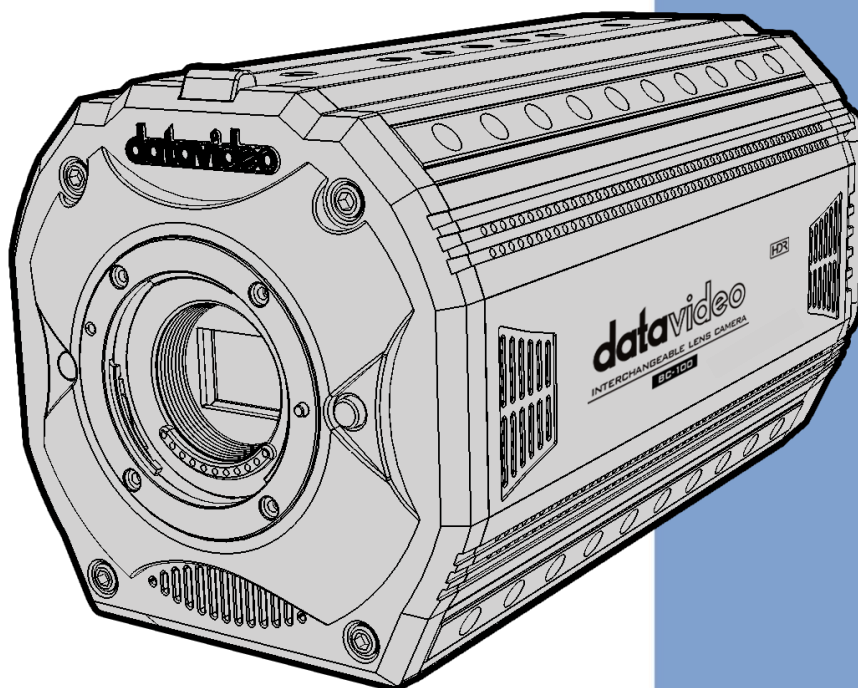

INTERCHANGEABLE LENS

CAMERA

**BC-100**

## Instruction Manual

[www.datavideo.com](http://www.datavideo.com)

# Table of Contents

<b>TABLE OF CONTENTS</b> .....	<b>2</b>
<b>FCC COMPLIANCE STATEMENT</b> .....	<b>4</b>
<b>WARNINGS AND PRECAUTIONS</b> .....	<b>4</b>
<b>WARRANTY</b> .....	<b>5</b>
<b>STANDARD WARRANTY</b> .....	<b>5</b>
<b>THREE YEAR WARRANTY</b> .....	<b>5</b>
<b>DISPOSAL</b> .....	<b>6</b>
1.1 FEATURES.....	7
<b>CHAPTER 2 APPLICATIONS</b> .....	<b>8</b>
<b>CHAPTER 3 CONNECTIONS</b> .....	<b>9</b>
3.1 FRONT VIEW .....	9
3.2 REAR VIEW .....	10
3.3 PIN DEFINITION OF THE TALLY CABLE FOR TALLY IN & TALLY OUT .....	13
3.4 PIN DEFINITION OF THE LANC REMOTE CONTROL .....	13
3.5 DIP SWITCH OF THE BC-100 .....	14
3.6 DIRECT CONNECTION TO CAMERA .....	15
3.7 DVIP .....	16
3.8 BROADCAST AND UDP COMMANDS INDEX .....	16
<b>CHAPTER 4 QUICK START GUIDE</b> .....	<b>19</b>
<b>CHAPTER 5. USE BC-100 APP TO CONTROL THE CAMERA</b> .....	<b>22</b>
5.1 SETTINGS .....	22
HOW TO ENTER THE SETTINGS MENU OPTIONS.....	23
HOW TO STREAM TO YOUTUBE STREAMING PLATFORM (TAKE ANDROID PHONE AS AN EXAMPLE) .....	26
5.2 CURRENT .....	30
5.3 EXPOSURE MODES .....	33
5.4 RECORDING STATUS REMINDER .....	38
5.5 AUTOMATIC WHITE BALANCE (AWB) .....	40
5.6 GAIN/GAIN LIMIT .....	42
5.7 FRAME RATE .....	43
5.8 FOCUS .....	44
5.9 IRIS.....	47
5.10 ADVANCED FUNCTION .....	48
5.11 EC (EXPOSURE COMPENSATION).....	48
5.12 BRIGHTNESS.....	49
5.13 SHUTTER OR SHUTTER LIMIT .....	50
5.14 HDR (HIGH DYNAMIC RANGE) .....	51
5.15 SATURATION .....	52
5.16 CONTRAST .....	53
5.17 SHARPNESS.....	54
<b>CHAPTER 6. FIRMWARE UPDATE (TAKE ANDROID PHONE AS AN EXAMPLE)</b> .....	<b>55</b>
<b>CHAPTER 7. OPTIONAL ACCESSORIES</b> .....	<b>59</b>
<b>CHAPTER 8. DIMENSIONS</b> .....	<b>60</b>
<b>CHAPTER 9. SPECIFICATION</b> .....	<b>61</b>

**Disclaimer of Product & Services**

The information offered in this instruction manual is intended as a guide only. At all times, Datavideo Technologies will try to give correct, complete and suitable information. However, Datavideo Technologies cannot exclude that some information in this manual, from time to time, may not be correct or may be incomplete. This manual may contain typing errors, omissions or incorrect information. Datavideo Technologies always recommend that you double check the information in this document for accuracy before making any purchase decision or using the product. Datavideo Technologies is not responsible for any omissions or errors, or for any subsequent loss or damage caused by using the information contained within this manual. Further advice on the content of this manual or on the product can be obtained by contacting your local Datavideo Office or dealer.

# FCC Compliance Statement

This device complies with part 15 of the FCC rules. Operation is subject to the following two conditions:

- (1) This device may not cause harmful interference, and
- (2) This device must accept any interference received, including interference that may cause undesired operation.

## Warnings and Precautions



1. Read all of these warnings and save them for later reference.
2. Follow all warnings and instructions marked on this unit.
3. Unplug this unit from the wall outlet before cleaning. Do not use liquid or aerosol cleaners. Use a damp cloth for cleaning.
4. Do not use this unit in or near water.
5. Do not place this unit on an unstable cart, stand, or table. The unit may fall, causing serious damage.
6. Slots and openings on the cabinet top, back, and bottom are provided for ventilation. To ensure safe and reliable operation of this unit, and to protect it from overheating, do not block or cover these openings. Do not place this unit on a bed, sofa, rug, or similar surface, as the ventilation openings on the bottom of the cabinet will be blocked. This unit should never be placed near or over a heat register or radiator. This unit should not be placed in a built-in installation unless proper ventilation is provided.
7. This product should only be operated from the type of power source indicated on the marking label of the AC adapter. If you are not sure of the type of power available, consult your Datavideo dealer or your local power company.
8. Do not allow anything to rest on the power cord. Do not locate this unit where the power cord will be walked on, rolled over, or otherwise stressed.
9. If an extension cord must be used with this unit, make sure that the total of the ampere ratings on the products plugged into the extension cord do not exceed the extension cord rating.
10. Make sure that the total amperes of all the units that are plugged into a single wall outlet do not exceed 15 amperes.
11. Never push objects of any kind into this unit through the cabinet ventilation slots, as they may touch dangerous voltage points or short out parts that could result in risk of fire or electric shock. Never spill liquid of any kind onto or into this unit.
12. Except as specifically explained elsewhere in this manual, do not attempt to service this product yourself. Opening or removing covers that are marked "Do Not Remove" may expose you to dangerous voltage points or other risks, and will void your warranty. Refer all service issues to qualified service personnel.
13. Unplug this product from the wall outlet and refer to qualified service personnel under the following conditions:
  - a. When the power cord is damaged or frayed;
  - b. When liquid has spilled into the unit;
  - c. When the product has been exposed to rain or water;
  - d. When the product does not operate normally under normal operating conditions. Adjust only those controls that are covered by the operating instructions in this manual; improper adjustment of other controls may result in damage to the unit and may often require extensive work by a qualified technician to restore the unit to normal operation;
  - e. When the product has been dropped or the cabinet has been damaged;

- f. When the product exhibits a distinct change in performance, indicating a need for service.

## Warranty

### Standard Warranty

- Datavideo equipment are guaranteed against any manufacturing defects for one year from the date of purchase.
- The original purchase invoice or other documentary evidence should be supplied at the time of any request for repair under warranty.
- The product warranty period begins on the purchase date. If the purchase date is unknown, the product warranty period begins on the thirtieth day after shipment from a Datavideo office.
- All non-Datavideo manufactured products (product without Datavideo logo) have only one year warranty from the date of purchase.
- Damage caused by accident, misuse, unauthorized repairs, sand, grit or water is not covered under warranty.
- Viruses and malware infections on the computer systems are not covered under warranty.
- Any errors that are caused by unauthorized third-party software installations, which are not required by our computer systems, are not covered under warranty.
- All mail or transportation costs including insurance are at the expense of the owner.
- All other claims of any nature are not covered.
- All accessories including headphones, cables, and batteries are not covered under warranty.
- Warranty only valid in the country or region of purchase.
- Your statutory rights are not affected.

### Three Year Warranty

- All Datavideo products purchased after July 1st, 2017 are qualified for a free two years extension to the standard warranty, providing the product is registered with Datavideo within 30 days of purchase.



- Certain parts with limited lifetime expectancy such as LCD panels, DVD drives, Hard Drive, Solid State Drive, SD Card, USB Thumb Drive, Lighting, Camera module, PCIe Card are covered for 1 year.
- The three-year warranty must be registered on Datavideo's official website or with your local Datavideo office or one of its authorized distributors within 30 days of purchase.

## Disposal

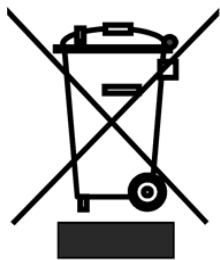

### **For EU Customers only - WEEE Marking**

This symbol on the product or on its packaging indicates that this product must not be disposed of with your other household waste. Instead, it is your responsibility to dispose of your waste equipment by handing it over to a designated collection point for the recycling of waste electrical and electronic equipment. The separate collection and recycling of your waste equipment at the time of disposal will help to conserve natural resources and ensure that it is recycled in a manner that protects human health and the environment. For more information about where you can drop off your waste equipment for recycling, please contact your local city office, your household waste disposal service or the shop where you purchased the product.

# Chapter 1 Introduction

Equipped with a 4/3 inch CMOS sensor and the real time HDR function, the BC-100 series is designed by Datavideo to suppress darkness noise to the minimum in the low light environment, thus creating stunning real colors and fine black and white levels. What is more is that the BC-100 performs better than all cameras of the same grade and is designed for high-end applications.

What is unique about the BC-100 Interchangeable Lens Camera is its removable lens and its compatibility with the Micro 4/3 high performance lens group allow the user to form the perfect combination for specific photography requirements and satisfy the highly professional and the best Internet celebrity groups. Simply leave professional photography to us, and all you need to do is to come up with a good story. The Datavideo BC-100 Interchangeable Lens Camera is designed to touch your and my hearts.

## 1.1 Features

- High quality low light image performance
- Supports App control by the iOS/Android-based handset
- Supports live streaming through App control (USB connection)
- Supports standard M4/3 lens mount (Panasonic / Panasonic LEICA/Olympus)
- Supports Real-Time HDR (High Dynamic Range)
- Supports 12-bit image processing capability
- The high quality image of the BC-100 is the best source for the chromakey application of the TVS-1000A/1200A/2000A virtual studios to combine the real images and virtual scenes together
- Ruggedized aluminum alloy enclosure with double-row fixed holes for expansion accessories
- Supports ultra-high 3D signal noise reduction capability
- 4/3 inch CMOS sensor
- Output Interfaces: Supports simultaneously output for 1 HDMI and 2 SDI output interfaces
- Output Resolutions: 1920x1080
- Shutter Speed: Supports shutter speed range from 1/2000 to 1/25 (S)
- Audio Input: Supports dynamic microphone and +48V condenser microphone.

## Chapter 2 Applications

The Datavideo BC-100 Interchangeable Lens Camera provides many features such as the 4/3 inch large size CMOS sensor, the capability to reduce the shadow noise to the lowest level and real-time HDR for users to achieve high image quality in low-light situation. Please see following paragraphs for the recommended scenes for applying the BC-100 Interchangeable Lens Camera.

- **E-Sports:** The eSport industry is an ideal scene for the BC-100 application. The impressive gaming screen, colorful sound and light effects and the dramatically changing visual environment make the eSport scene the best scene for totally expressing BC-100's astonishing HDR capability. The BC-100 makes the live broadcasting just like the real scene.
- **Wedding Ceremony:** Wedding ceremony is the most important day for most of the people and you need a high quality camera that can help you to save your precious memories. The BC-100 achieves color reduction and multi-level faithful performance in the low-light environment. The BC-100 captures high quality images and saves these significant moments permanently so that they will stay in your memory without fading away.
- **Virtual Studios:** The BC-100's proprietary high definition video is the best source for the virtual studio chromakey application. The most challenging transparent cup, smoke and hair in the virtual studio can be perfectly demonstrated by combining BC-100's 12-bit CMOS sensor and rich levels with the chromakey technology of the TVS-100A, TVS-1200A and TVS-2000A. The virtual and real scenes can be naturally combined without any flaw.
- **Nightclub Dancing Competition:** The ultra-high noise reduction capability of the BC-100 allows it to keep high screen quality even in the luxurious and dusky nightclub environment. The BC-100 reduces the shadow Signal-to-Noise ratio to the lowest level. Moreover, its dynamic performance of the 50/60P reappears the real scenes of the nightclub in the BC-100 videos.
- **Evening Party & Concert:** Large evening party or concert is also a very good environment for demonstrating BC-100's capabilities. The carefully arranged programs, always-changing stage laser light effects, and intermittent darkness and light are great challenges for a camera. With the BC-100, you are able to shoot a high quality video as the cinematic camera. Moreover, you can release the burden of the post production. Due to this reason, you can put your focus on the touching moment on the stage. The real-time HDR shows interactions between actors and audience clearly on the monitor at the same time.
- **Candlelight Scenes:** Candlelight is the only illuminating tool in most of the romantic or silent scenes. This kind of low-light environment is the best place for demonstrating BC-100's features such as ultra-high signal noise suppressing capability and high definition image to help you to revert the touching moment just as the live scene.
-



# Chapter 3 Connections

This section will introduce users the connections of Datavideo BC-100 Interchangeable Lens Camera. Please see following paragraphs for details.

## 3.1 Front View



No.	Interface	Description
1.	M4/3 lens mount with standard 11 pin electronic contacts	This lens mount is used for users to mount the M4/3 compatible interchangeable lenses such as Panasonic, Panasonic LEICA and Olympus lenses.
2.	Tally Light	In the EFP production, if a PGM signal is received by the BC-100 from the switcher, the tally light will light on in red. However, if a PVM signal is received by the BC-100 from the switcher, the tally light will light on in green.
3	Lens-release Button	This lens-release button allows users to remove the lens of the camera. When the lens-release button is pressed, the lens lock pin will be retracted and then users can rotate the lens easily. Before installing the camera lens, please rotate the lens until there is a click to show that the camera lens is locked properly.

### 3.2 Rear View

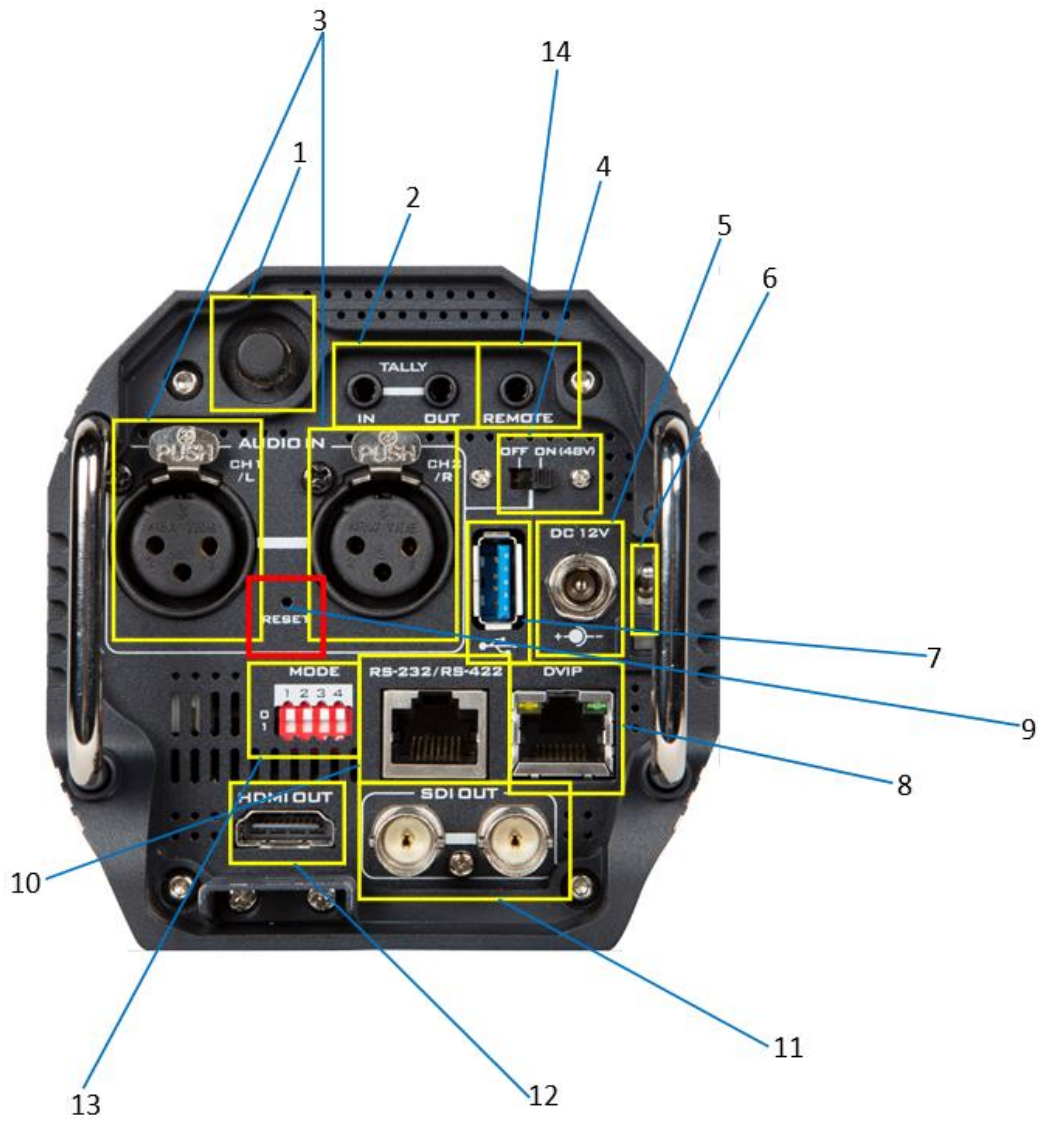

No.	Interface	Description
1	WiFi Antenna (Optional)	The Wi-Fi function is optional, if the Wi-Fi function is purchased by the user, this interface can be used to install the Wi-Fi antenna for transmitting and receiving the Wi-Fi signal.
2.	Tally IN& Tally OUT	Tally IN is used to receive tally signal from the switcher. Tally OUT loops out the signal from Tally IN for next device.
3	XLR Phantom Microphone Inputs	Allows users to input up to two XLR balanced analog audio sources (CH1/L & CH2/R). Connect these two ports to external microphones.   <b>Note: If the microphone is the condenser microphone, please select the 48V phantom power on the rear panel of the BC-100 before use, if the microphone is the dynamic microphone, please turn off the 48V phantom power.</b>
4.	Phantom Power Switch	If the microphone is the condenser microphone, please turn on the 48V phantom power on the rear panel of the BC-100 before use, if the microphone is the dynamic microphone, please turn off the 48V phantom power.
5.	DC 12V Power Connector	DC in socket connects the supplied 12V PSU. The connection can be secured by screwing the outer fastening ring of the DC In plug to the socket. The operating voltage range of the BC-100 is from 7V to 15V.
6.	Power Switch	Turns on/off the 12V power. This power switch provides delay shutdown function for users.
7.	USB 3.0	This is the USB 3.0 port. Connect the BC-100 to an Android-based mobile phone for control and preview. Please pay attention that it is a must to use a USB OTG cable for connecting this USB 3.0 interface. This USB 3.0 interface supports the Android OS only.
8.	DVIP	This port is used to connect an Ethernet cable to control the camera through DVIP.
9.	RESET	Press and hold the RESET button for 5 seconds through a

		needle will clear the Wi-Fi password of the BC-100.
10.	RS-232/RS-422	This port is used to connect to an Ethernet cable to control the camera through the RS-232 or RS-422 protocol.
11.	SDI OUT	These two SDI output connectors can be connected to different back-end devices such as recorder and look-back monitor. They can be combined with one HDMI output port on the rear panel of the BC-100 to simultaneously output two SDI and one HDMI signals
12.	HDMI OUT	This HDMI output connectors can be connected to different back-end devices such as recorder and look-back monitor. It can be combined with two SDI output ports on the rear panel of the BC-100 to simultaneously output one HDMI and two SDI signals
13.	DIP Switch	The 4 position Dip Switch is used for controlling modes of the BC-100. For the details of the BC-100 dip switch, please refer to <a href="#">3.5 DIP Switch of the BC-100</a> .
14.	LANC Remote Control Interface	This remote connector is used for users to connect the BC-100 to an external recorder such as Atomos Ninja Blade 5" HDMI Recorder/Monitor/Player with a 3.5mm TRS/3 pin plug for remote controlling by LANC interface.

### 3.3 Pin Definition of the Tally Cable for Tally IN & Tally OUT

Please see following table for the pin definition of the Tally IN & Tally OUT of the NH-100.

Pin No.	3.5mm Mini-Plug	Signal
1	Tip	RED LED
2	Ring	GREEN LED
3	Sleeve	GND

### 3.4 Pin Definition of the LANC Remote Control

The LANC remote control button (optional) allows users to control an external connected Recorder/Monitor/Player such as the Atomos Ninja Blade series with a 3.5mm male to 2.5mm male & 3.5mm male adapter cable. The main 3.5mm male plug must be connected to the Remote connector on the rear panel of the BC-100. For the adapter cable, the 2.5mm male plug must be connected to the LANC connector on the Atomos Recorder/Monitor/Player, and the 3.5mm male plug must be connected to the 3.5mm connector for “LANC” on the LANC control button. Please connect the LANC control adapter cable according to following diagram.

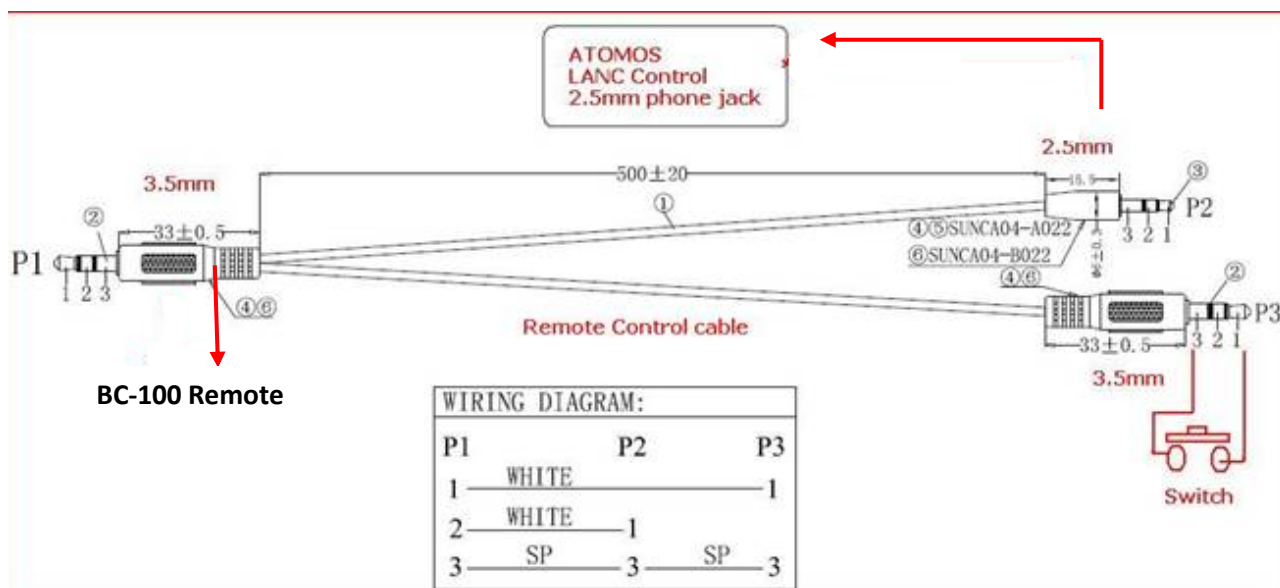

### 3.5 DIP Switch of the BC-100

The 4 position Dip Switch is used for controlling modes of the BC-100. Please refer to following paragraphs for details of the DIP Switch control.

For the DIP Switch of the BC-100, the position 1 is reserved for future extension, the position 2 is used for RS-232/RS-422 control mode switching, the position 3 is used for tally signal switching and the position 4 is used for LANC control mode switching (Master/Slave).

BC-100 DIP Switch				
Position	Function	Note		
1	Reserved for future extension	Please fix the DIP Switch at 0.		
2	Control mode switching (RS-232/RS-422)			
3	Tally signal source	For connecting the BC-100 to the Atomos/BMD recorder, please slide this position to 0. If the BC-100 is connected to a switcher, please slide this position to 1.		
4	LANC control mode switching	For connecting the BC-100 to the Atomos recorder, please slide this position to 0.		
BC-100 DIP Switch				
	1	2	3	4
0	Reserved for future extension	RS-232	Internal Tally	LANC Master
1		RS-422	External Tally	LANC Slave

### 3.6 Direct Connection to Camera

To use the PTZ Camera Control Unit to directly control the BC-100 camera, connect the RS-422/RS-232 port on the camera's rear panel to the RJ-45 port of the camera control unit by using any RJ-45 cable. The RS-422/RS-232 wiring schemes are shown below.

#### RS-422

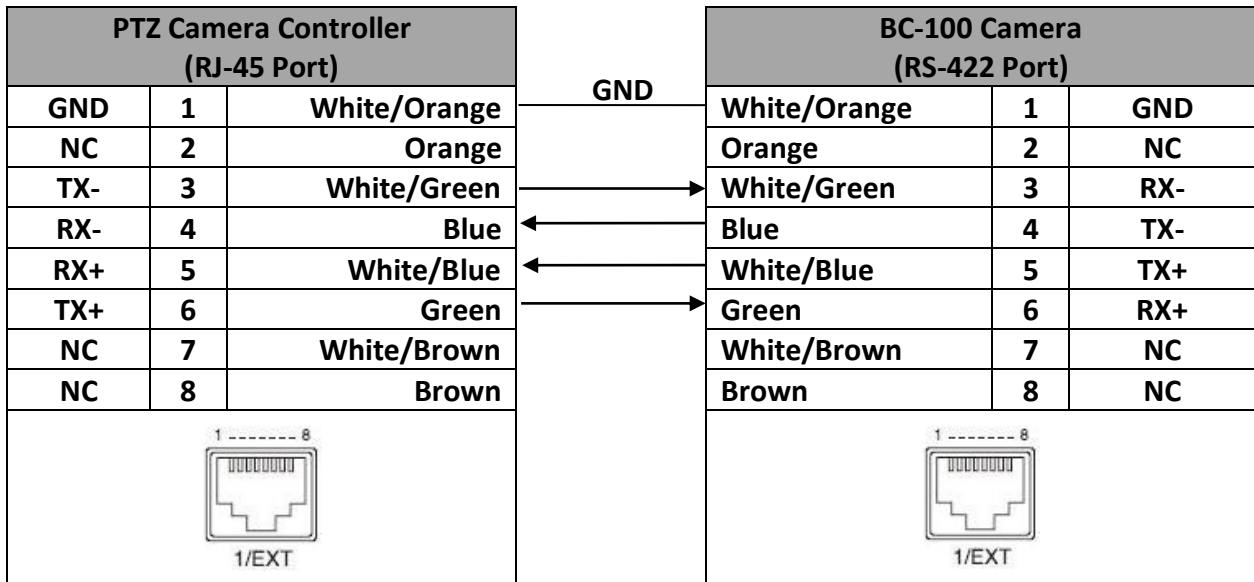

#### RS-232

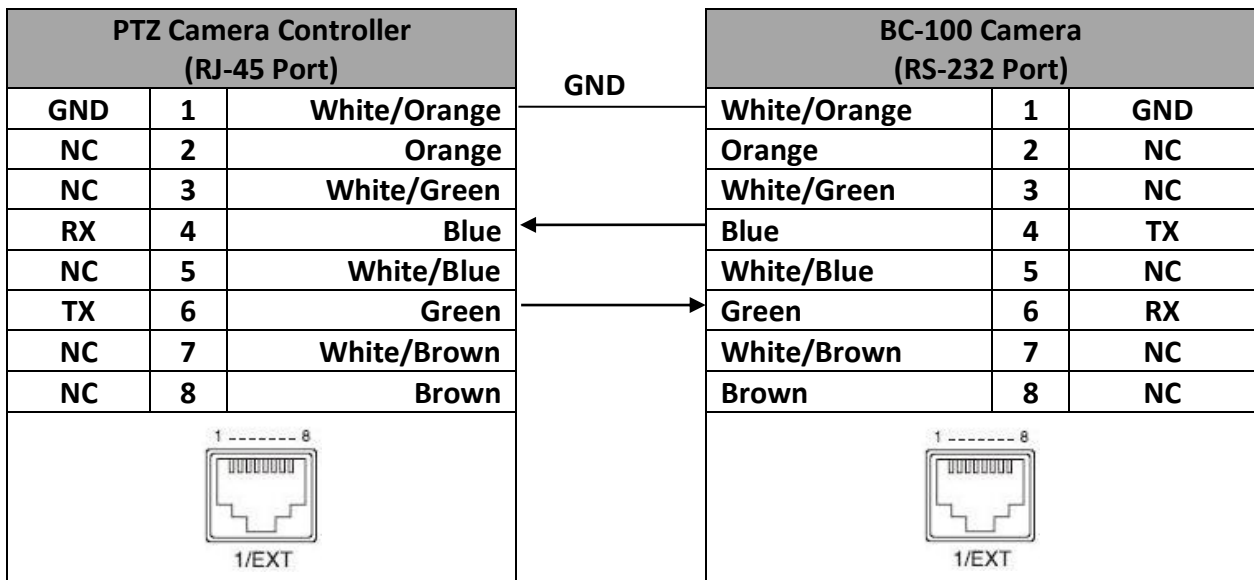

### 3.7 DVIP

- **The Introduction of the DVIP**

The concept of the DVIP is to search Davavideo related products and to set the network configurations of those devices by broadcasting through the UDP socket. After that, the control commands will be transferred through TCP socket.

- **How to Connect the BC-100 Camera and the Remote Controller via the DVIP Control**

The BC-100 camera can be **directly connected to a PC** for DVIP controlling through an RJ-45 Ethernet cable.

- **Broadcast Packet**

The UDP is a communication protocol to transfer data to remote host. For transferring data through the UDP packet, it is a must for you to know the destination IP address and the DVIP device server (UDP) port number. The PC uses broadcast packet to obtain DVIP device information in the same network. Please follow following information for the destination IP address and the DVIP device server (UDP) port number.

- Destination IP address: 255.255.255.255
- DVIP Device Server(UDP) port number: 5002

For further information of the broadcast packet and the UDP/TCP protocols, please refer to “**Datavideo DVIP Ethernet Control Operation Guide**”.

**Note: For users who need “Datavideo DVIP Ethernet Control Operation Guide”, please contact your local Datavideo office or dealer.**

### 3.8 Broadcast and UDP Commands Index

Please see following tables for broadcast/UDP commands Index.

- **Broadcast Command Index**

Command	Code	Support Levels	Note
ETH_REQ	0x00	Mandatory	Find DVIP devices in the same network.
FWVER_REQ	0x01	Mandatory	Get firmware information of specific (MAC address) DVIP device.
SET_DHCPMODE	0x02	Mandatory	Set DHCP mode of specific (MAC address) DVIP device.
SET_IPADR	0x03	Mandatory	Set IP & Gateway address of specific (MAC address) DVIP device.
RESET	0x04	Mandatory	Request specific (MAC address) DVIP device to reboot (software reset)
BOOTLOADER	0x05	Optional	Request specific (MAC address) DVIP device to jump to Boot Loader.
E2P_DEFAULT	0x06	Mandatory	Request specific (MAC address) DVIP device



			to reset to factory default.
E2P_READ	0x07	Vendor-Dependent	Read EEPROM data from specific (MAC address) DVIP device.
GET_MODEL	0x40	Mandatory	Get Vendor and Product IP of specific (MAC address) DVIP device.
GET_MODEL_NAME	0x41	Recommended	Get model name of specific (MAC address) DVIP device.
GET_VERSION	0x42	Vendor-Dependent	Get detailed version information of specific (MAC address) DVIP device.
GET_PRESET_COUNT	0x43	Recommended	Get preset count number of specific (MAC address) DVIP device
GET_PRESET_NAME	0x44	Recommended	Get preset count number of specific (MAC address) DVIP device.

● **UDP Command Index**

Command	Code	Support Levels	Note
ETH_REQ	0x00	Mandatory	Get network information of specific (IP address) DVIP device
FWVER_REQ	0x01	Mandatory	Get firmware revision of specific (IP address) DVIP device
SET_DHCPMODE	0x02	Mandatory	Configure DHCP mode of specific (IP address) DVIP device
SET_IPADR	0x03	Mandatory	Configure IP & Gateway address of specific (IP address) DVIP device
RESET	0x04	Optional	Request specific (IP address) DVIP device to reboot (software reset)
RD_E2P	0x05	Vendor-Dependent	Read EEPROM data from specific (IP address) DVIP device
WR_E2P	0x06	Vendor-Dependent	Write EEPROM data to specific (IP address) DVIP device
RD_IFLASH	0x07	Vendor-Dependent	Read internal Flash data of specific (IP address) DVIP device
BOOTLOADER	0x08	Optional	Request specific (IP address) DVIP device to reboot to Boot Loader
SET_DHCPNAME	0x09	Mandatory	Set DHCP host name of specific (IP address) DVIP device
SET_MACADR	0x0A	Mandatory	Set MAC address of specific (IP address) DVIP device
SET_NETMASK	0x0B	Mandatory	Set Net Mask of specific (IP address) DVIP device

SET_GATEWAY	0x0C	Mandatory	Set Gateway address of specific (IP address) DVIP device
SET_PRIDNS	0x0D	Mandatory	Set Primary DNS address of specific (IP address) DVIP device
SET_SECDNS	0x0E	Mandatory	Set Secondary DNS address of specific (IP address) DVIP device
INIT_E2P	0x0F	Vendor-Dependent	Initial specific (IP address) DVIP device configuration data
GET_MODEL	0x40	Mandatory	Get VID & PID of specific (IP address) DVIP device
GET_MODEL_NAME	0x41	Recommended	Get product name of specific (IP address) DVIP device
GET_VERSION	0x42	Vendor-Dependent	Get detailed version information of specific (IP address) DVIP device
GET_PRESET_COUNT	0x43	Mandatory	Get preset count number of specific (IP address) DVIP device
GET_PRESET_NAME	0x44	Mandatory	Get preset name of specific preset number of specific (IP address) DVIP device
RECALL_PRESET	0x45	Mandatory	Recall preset date of specific preset number of specific (IP address) DVIP device

# Chapter 4 Quick Start Guide

Please follow following steps for quick connection and setting guidance of the BC-100.

- **Connect the BC-100 camera to the Android handset by the USB OTG Cable**

Step1. Please connect the DC 12V power adapter to the DC 12V connector on the rear panel of the BC-100.

Step 2. Please turn on the BC-100 by the power switch on the rear panel of the BC-100.

Step 3. Please download the BC-100 App from Google Play and then please install the App to your Android handset.

Step 4. Please use a USB OTG adapter cable (USB Type A (male) to micro USB or USB Type A (male) to USB Type C) to connect the BC-100 and your Android handset.

Step 5. After that, you can open the BC-100 App.

Step 6. After the BC-100 App is launched, the main interface of the App will be shown as following and then you can control the BC-100 Interchangeable Lens Camera by your handset.

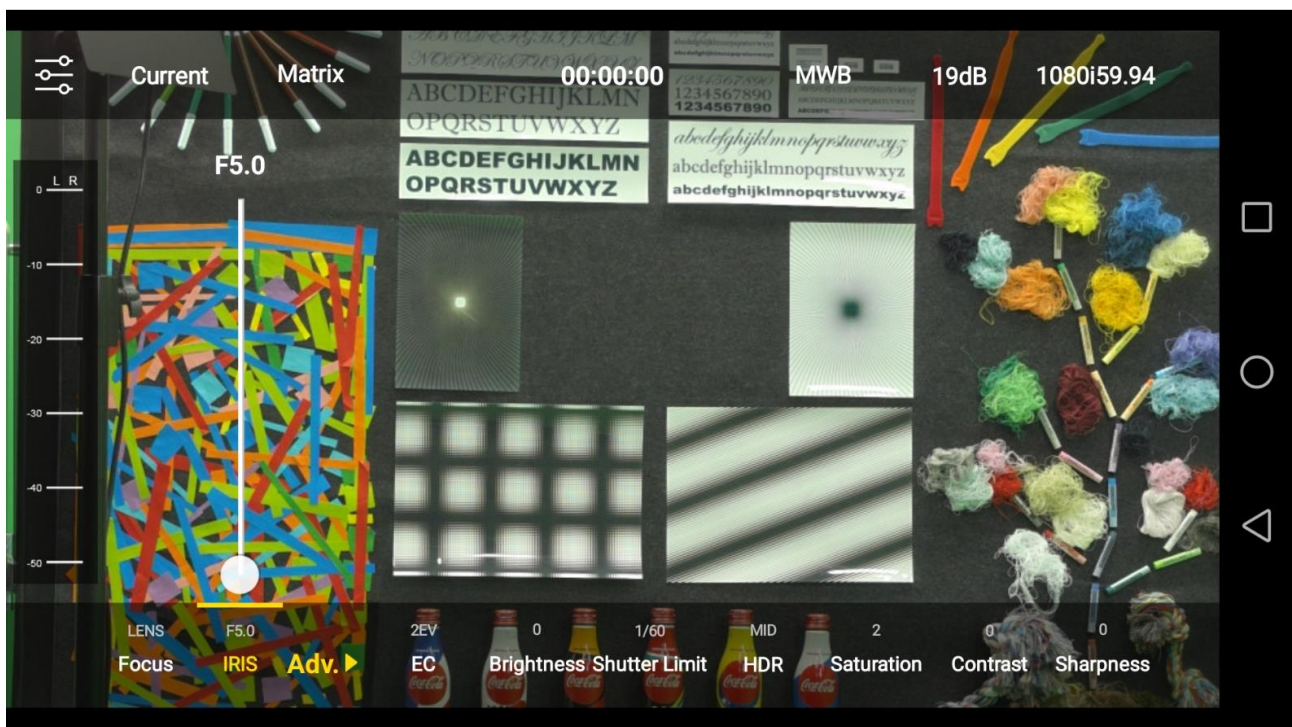

**Note: The Wi-Fi antenna is optional**

- **Connect the BC-100 camera and Android handset by Wi-Fi**

Step 1. Please connect the DC 12V power adapter to the DC 12V connector on the rear panel of the BC-100.

Step 2. Please turn on the BC-100 by the power switch on the rear panel of the BC-100.

Step 3. Please download the BC-100 App from Google Play and then please install the App to your Android handset.

Step 4. Please turn on the Wi-Fi of your handset and then please search the SSID of the BC-100 camera. The default SSID of the BC-100 camera is “BC-100\_xxxx” without password. If users want to modify the name of the SSID or the Wi-Fi password, please modify those parameters in the BC-100 App.

Step 5. After your handset is connected to the BC-100 camera through the BC-100 hotspot, you can open the BC-100 App.

Step 6. After the BC-100 App is launched, the main interface of the App will be shown as following. You can control the BC-100 Interchangeable Lens Camera by your handset.

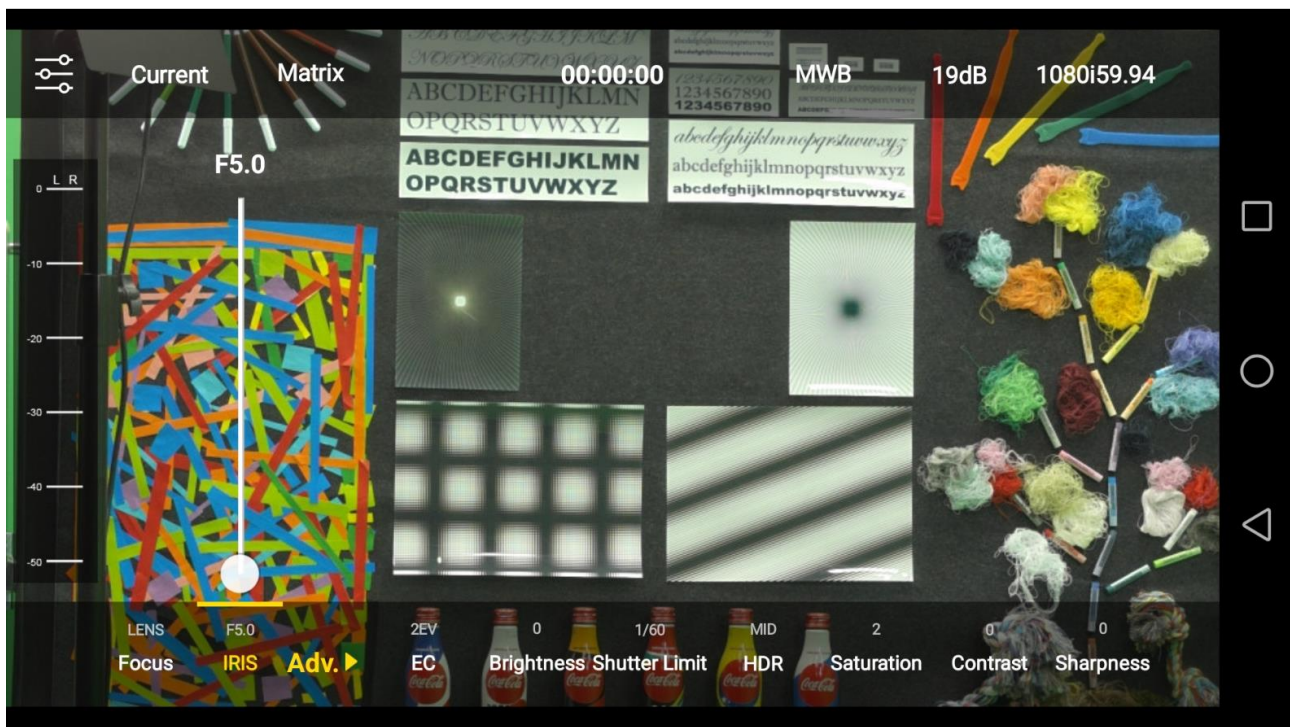

**Note:** If the Wi-Fi and USB connection are existed together, following screen will be shown for users to select their desired way for connection.

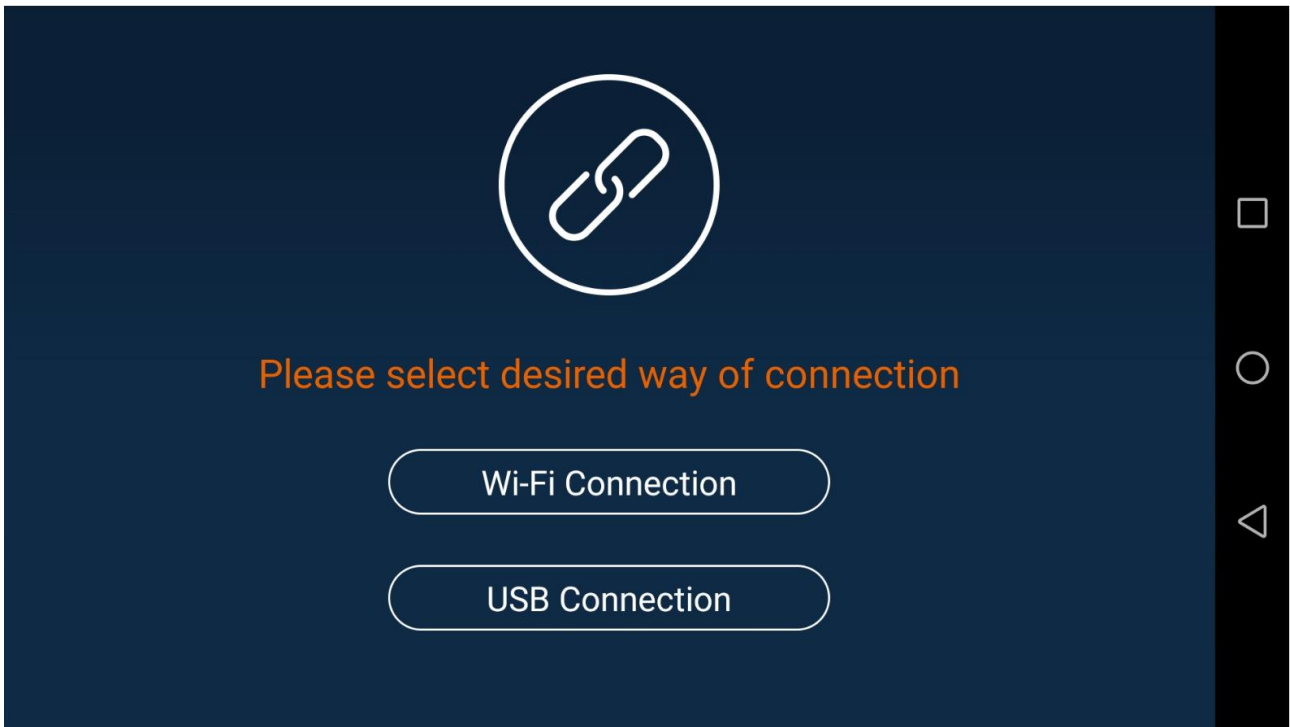

- Click **“Wi-Fi Connection”** to enter the main interface of the App directly.
- Click **“USB Connection”** and then the following warning window for USB connection will be shown. Please click **“Use by default for this USB device”** and then press **“OK”** to enter the main interface of the App.

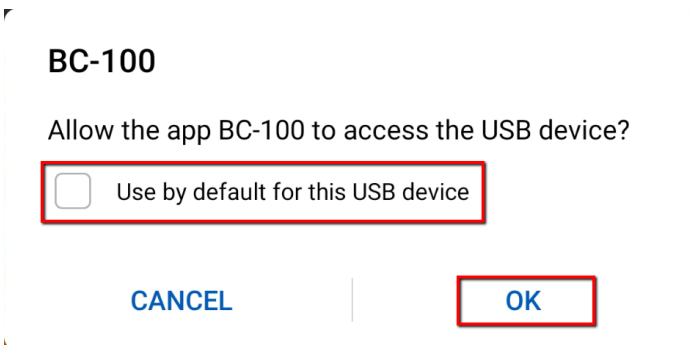

## Chapter 5. Use BC-100 App to Control the Camera

BC-100 is an Android App for users to control Datavideo BC-100 camera by Android/iOS handsets. Please follow following steps to control the BC-100 camera by the BC-100 app (Take Android OS as an example).

Step 1. Take Android handset as an example, please search BC-100 App from Google Play and then click the install button to install it.

Step 2. After the installation is finished, users can see BC-100 App from the desktop of the handset.

Step 3. Please click the icon to open the BC-100 app. After that, users can see the main interface of the BC-100 which is shown as following.

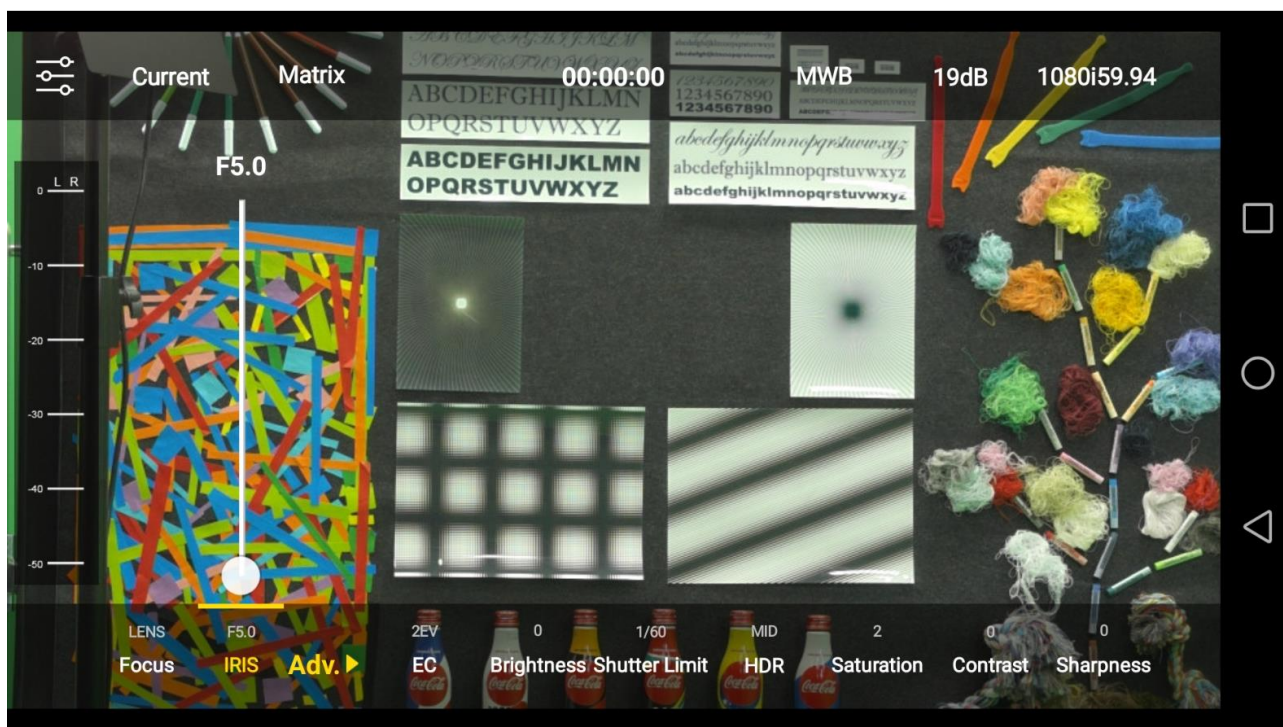

### 5.1 Settings



The settings icon  is located at the top-left side of the main interface. This settings icon allows users to set various functions including 3D Noise Reduction, Audio Level Standard, Audio Level, Display the Volume Bar, Stream Setting, Connection Mode, Wi-Fi Setting and App Version.

## How to Enter the Settings Menu Options

Please enter setting menu options according to following steps.

Step 1. Please click the settings icon .

Step 2. The settings interface which is shown as following will provide users to set several functions including 3D Noise Reduction, Audio Level Standard, Audio Level, Display the Volume Bar, Stream Setting, Connection Mode, Wi-Fi Setting and App Version.

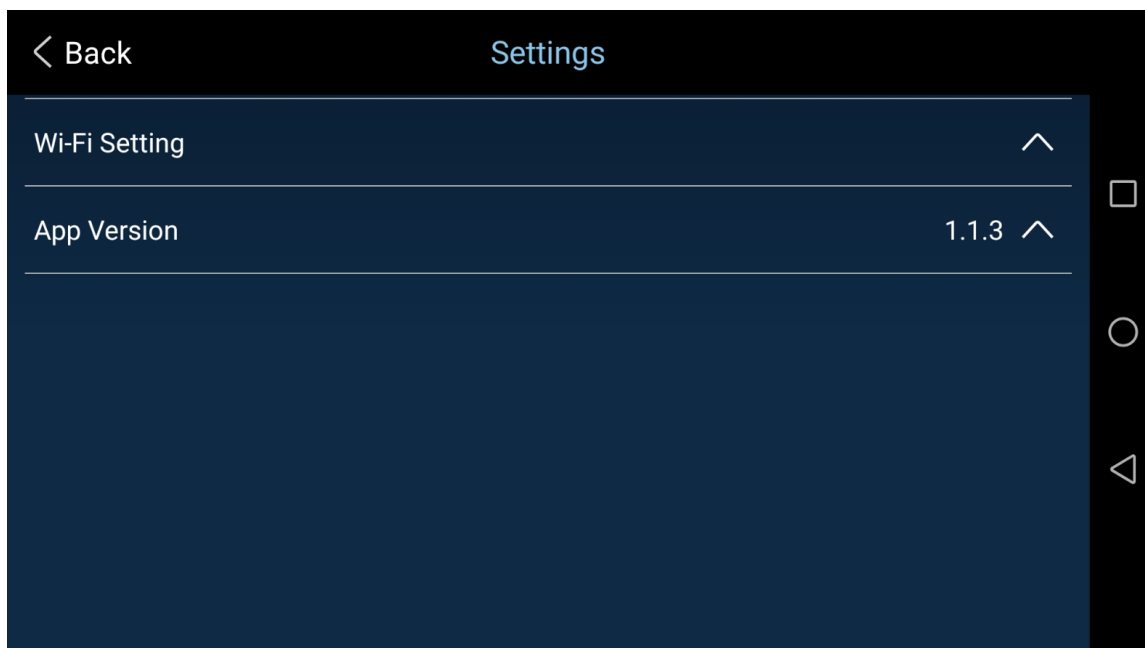
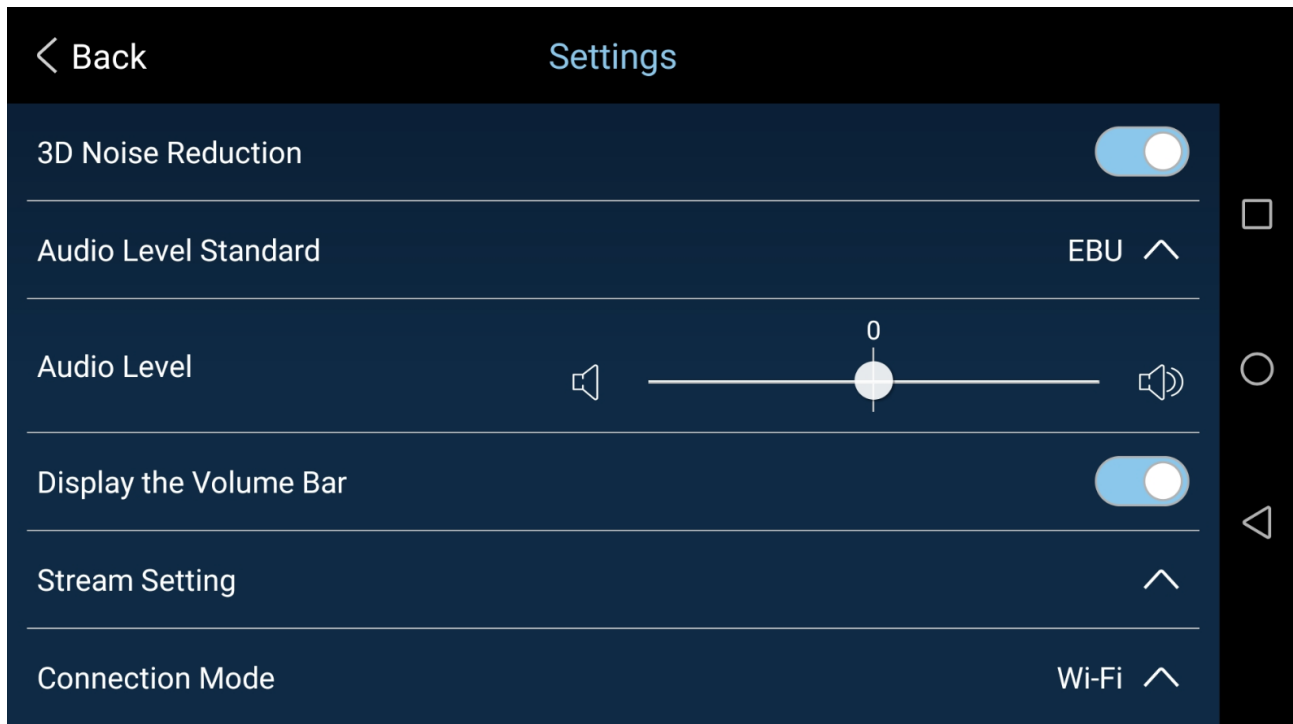

Please set the parameters of settings menu options according to following steps.

- **3D Noise Reduction** : The 3D Noise Reduction option allows users to turn on/off the 3D noise reduction function.

Step 1. Please press the 3D Noise Reduction option to turn on/turn off the 3D noise reduction function.

- **Audio Level Standard**: The Audio Level Standard option allows users to select two audio level standard including SMPTE and EBU.

Step 1. Please press the Audio Level Standard option to select your desired Audio Level Standard from the drop-down menu.

- **Audio Level**: Audio Level option allows users to adjust the audio level.

Step 1. Users can adjust the audio level by using the audio level setting slider to set the audio level. The default value of the audio level is 0 and the range for adjustment is from -25 to +25.

- **Display the Volume Bar**: This option allows users to determine whether they want to show the volume bar on the main user interface of the App or not.

Step 1. Please press the Display the Volume Bar option to turn on or turn off this function.

- **Stream Setting**: The Stream Setting option allows users to set various parameters including Stream Key, Server URL, Stream Resolution and Bit Rate.

Step 1. Please press the Stream Setting option to open the following Stream Setting menu.

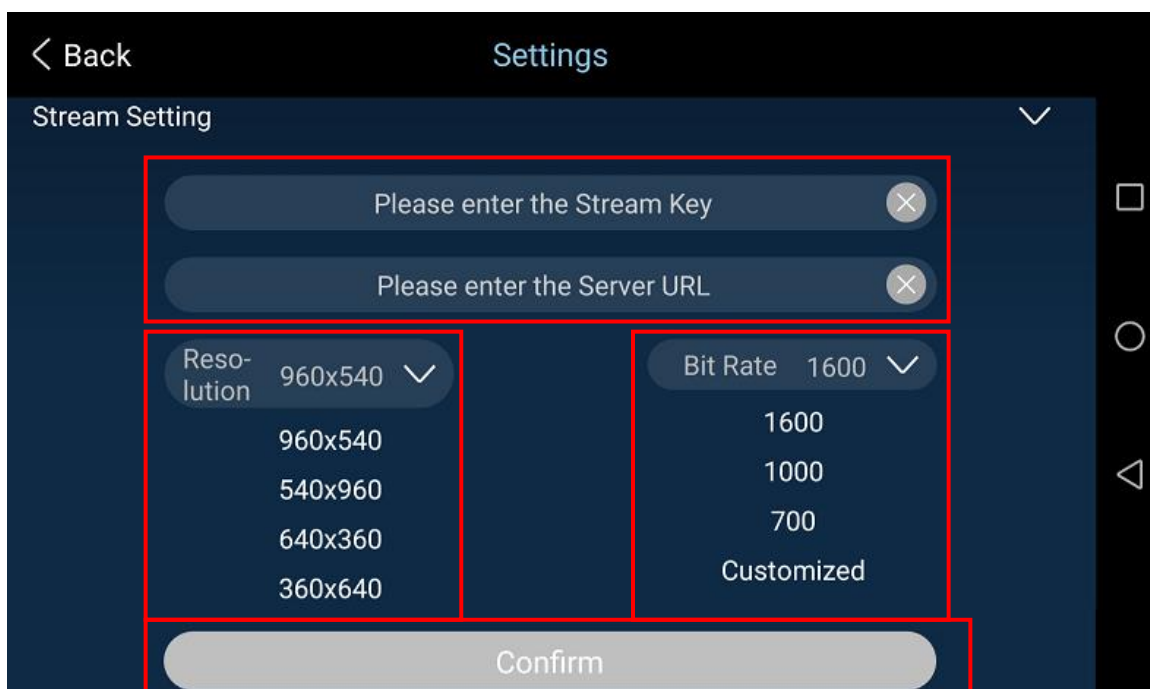



Step 2. Please press the “Please enter the Stream Key” column on the above diagram to enter the Stream Key.

Step 3. Please press the “Please enter the Server URL” column on the above diagram to enter the Stream Server URL.

Step 4. Please press the “Resolution” and “Bitrate” drop down menus on the above diagram to select your desired resolution and bitrate. After that, please press the “Confirm” button.

➤ **Customized Bit Rate**

Please follow following steps for setting the customized Bit Rate. (The Bit Rate range that can be customized by users is from 500 to 3500kbps).

1. Please press the “Customized” option **Customized** on the above diagram and then the customized Bit Rate window will be shown as following diagram.

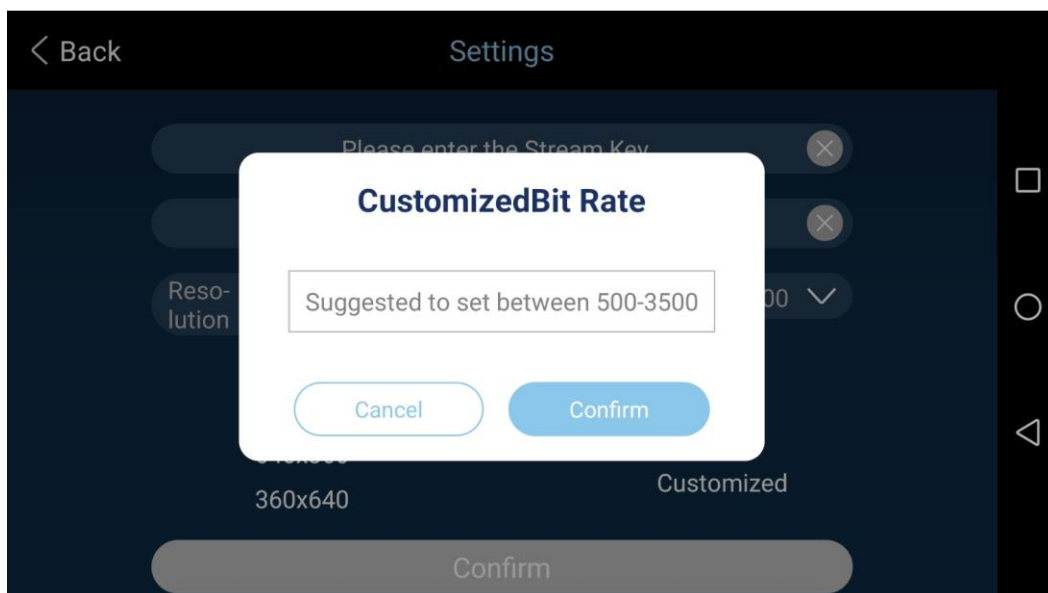

2. After the desired Bit Rate is entered and the “Confirm” button is pressed, the customized Bit Rate will be saved and then users can go back to the setting interface. If the “Cancel” button is pressed, users can go back to the setting interface directly.

Step 5. Please press the “Confirm” button which is shown on the above diagram to save the new settings.

## How to Stream to Youtube Streaming Platform (Take Android Phone as an Example)

Please follow following steps for streaming to Youtube streaming platform by the BC-100 camera.

Step 1. Please make sure that your handset is connected to the public network by the Wi-Fi connection (If the Wi-Fi of your handset is still connected to the BC-100\_xxxx, it is impossible for users for live-streaming). Moreover, users can also use the 4G mobile network for live-streaming.

Step 2. Please connect your Android handset to the BC-100 camera by a USB-OTG cable.

Step 3. Please open the BC-100 App.

Step 4. Please press the “OK” button to allow the BC-100 App to access the USB device.

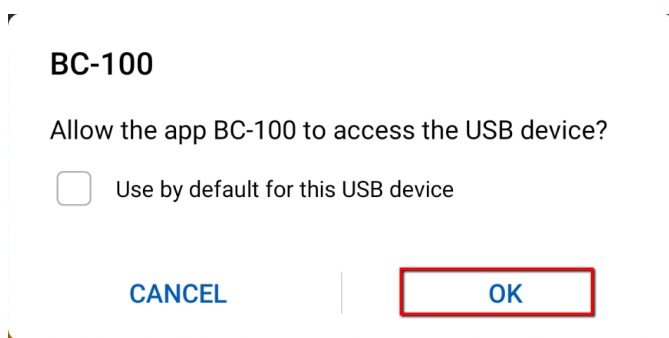

Step 5. Users can enter the main interface of the BC-100 App directly.



Step 6. Please go to Google website [www.google.com](http://www.google.com) for logging in your Google Account. After that, please go to Youtube Live website [https://www.youtube.com/live\\_dashboard](https://www.youtube.com/live_dashboard) and then press the “Stream now” option on the left column.

Step 7. Please copy the “Server URL” on the lower side of the Youtube Live web page.

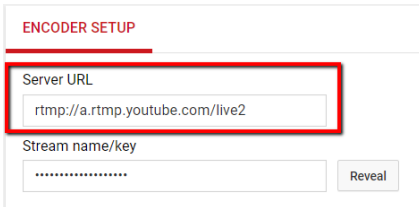

ENCODER SETUP

Server URL  
rtmp://a.rtmp.youtube.com/live2

Stream name/key  
.....

Step 8. Please press the settings icon  of the BC-100 App and then please press the “Stream Setting” option.

Step 9. Please paste the “Server URL” on the lower side of the Youtube Live webpage into the “Please enter the Server URL” column in the “Stream Setting” option of the BC-100 App.

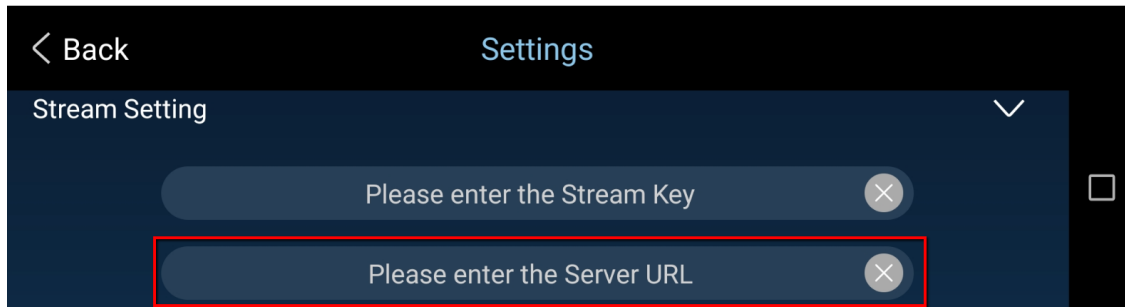

< Back Settings

Stream Setting

Please enter the Stream Key

Please enter the Server URL

Step 10. Please copy the Stream name/key on the lower side of the Youtube Live web page.

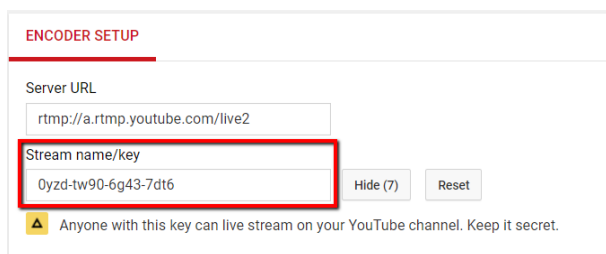

ENCODER SETUP

Server URL  
rtmp://a.rtmp.youtube.com/live2

Stream name/key  
0yzd-tw90-6g43-7dt6

⚠ Anyone with this key can live stream on your YouTube channel. Keep it secret.

Step 11. Please paste the Stream name/key into the “Please enter the Stream Key” column in the Stream Setting option of the BC-100 App.

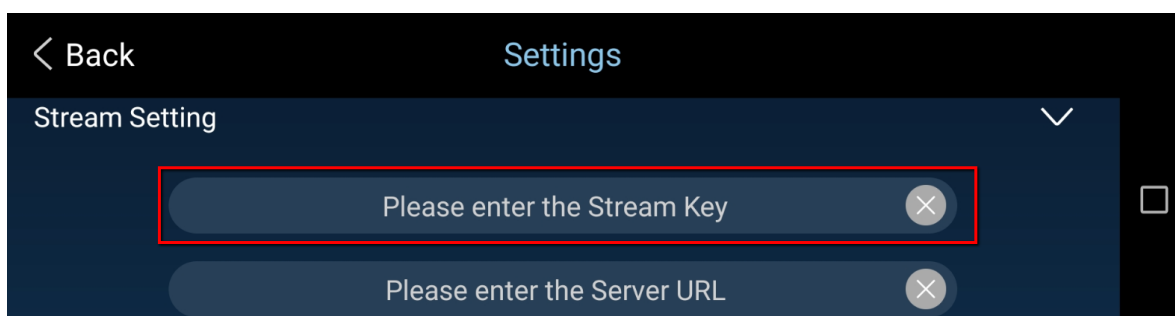

< Back Settings

Stream Setting

Please enter the Stream Key

Please enter the Server URL

Step 12. Please press “Resolution” and “Bit Rate” buttons to select your desired resolution and Bit Rate from the drop-down menus.

Step 13. Please press the “Confirm” button and then users can see that the “Live” icon on the top side of the BC-100 App becomes red and the live scene can be streamed to the Youtube Live platform successfully.



Step 14. If users want to stop the live-streaming, please press the “Live” icon again and then the “Live” icon will become white and the live-streaming will be stopped.

- **Connection Mode:** This option allows users to select two connection modes including Wi-Fi and USB.

**\*The selection of the connection mode can be done only when the camera is connected by both Wi-Fi and USB.**

Step 1. Please press the “Connection Mode” **Connection Mode** option and then the connection mode setting interface will be shown as following diagram.

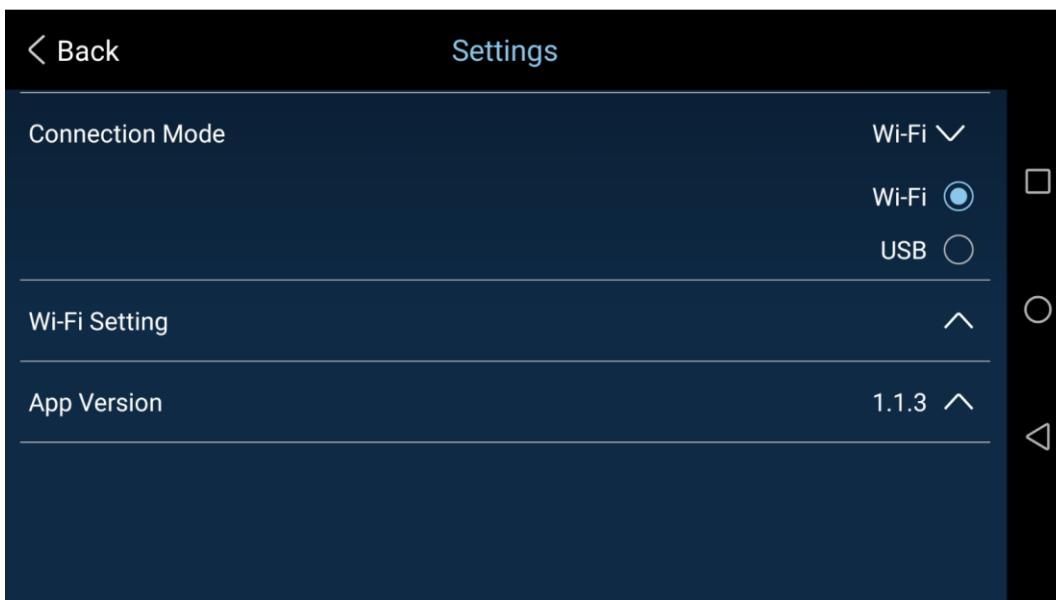

Step 2. Users can select their desired connection mode from the “Connection Mode” option.

- **Wi-Fi Setting:** This option allows users to set the Wi-Fi password (can be used only for Wi-Fi connection).

Step 1. Users can press the “Wi-Fi Setting” option and then press the “Set” button to set the Name and Password of the Wi-Fi.

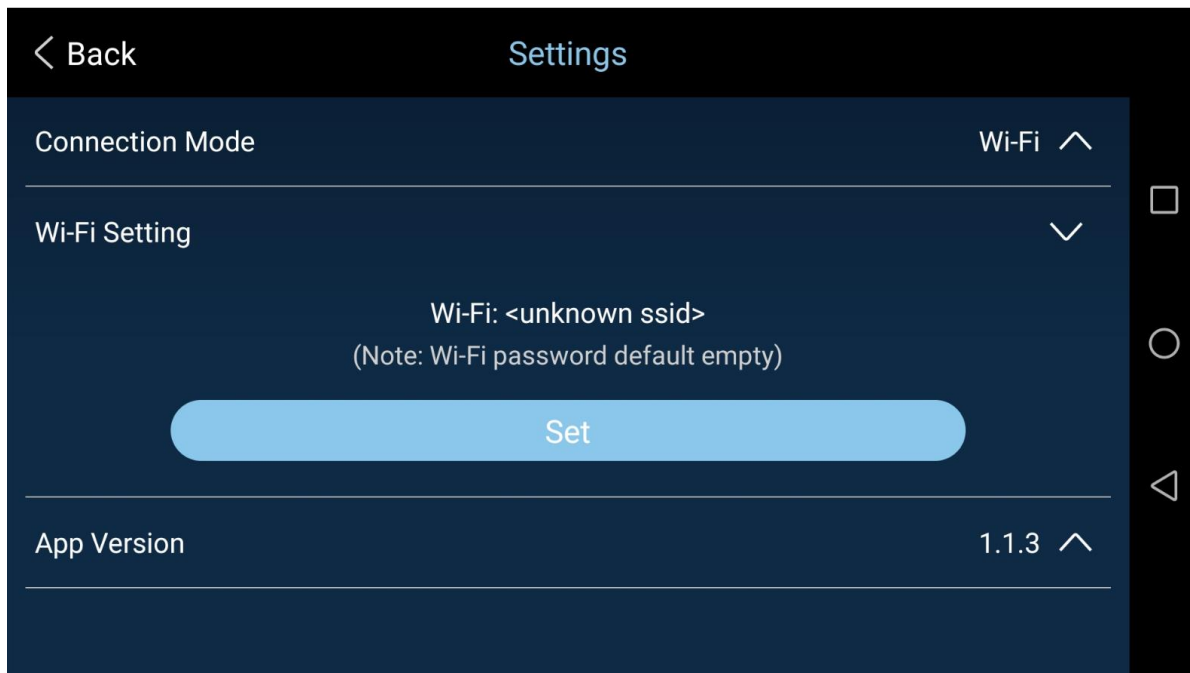

Step 2. After the Password is entered, please press the “Confirm” button to save the password.

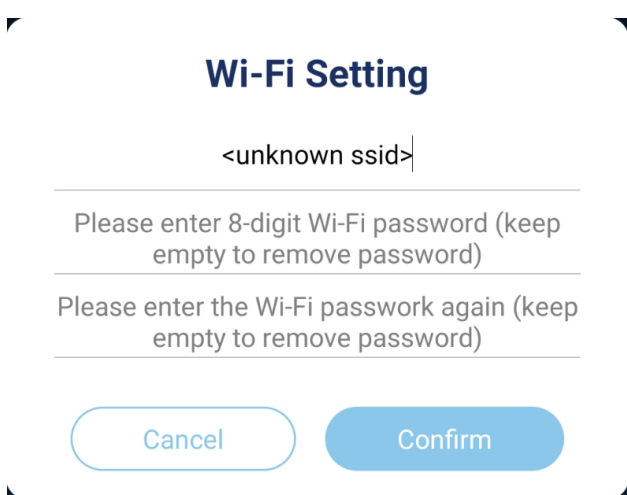

- **App Version:** This option allows users to check current App version and to update the latest BC-100 firmware. **Please see “Firmware Update” related chapter for the details of the firmware update.**

Step 1. Please press the App Version option to show the current BC-100 firmware version which is shown as following diagram.

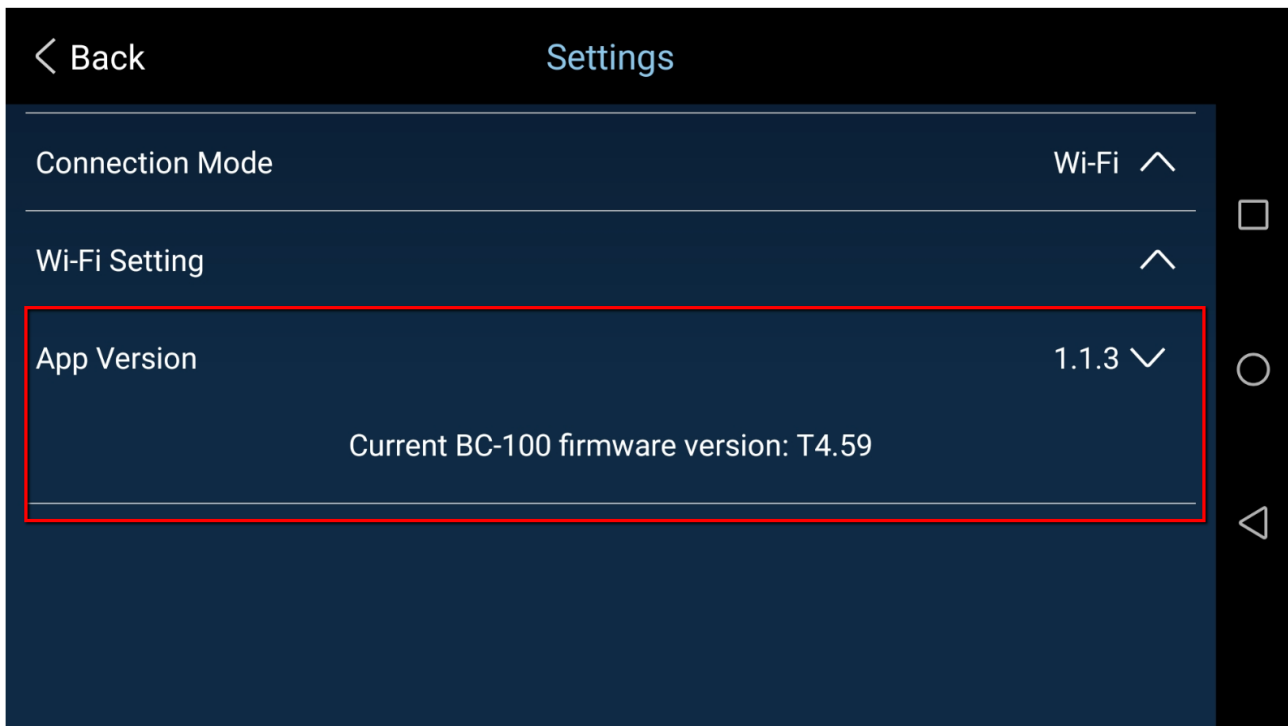

## 5.2 Current

The "Current" option is on the top-left side of the main interface. This option provides users four main items including "Default", "User1", "User2" and "Save".

### How to Enter Current Option

Please follow following options for entering the "Current" option.

Step 1. Please press the "Current" option  from the main interface of the App.

Step 2. The setting interface which is shown as following diagram will be shown for users to set various settings including Default, User1, User2, Save, Export Current Setting and Import Setting.

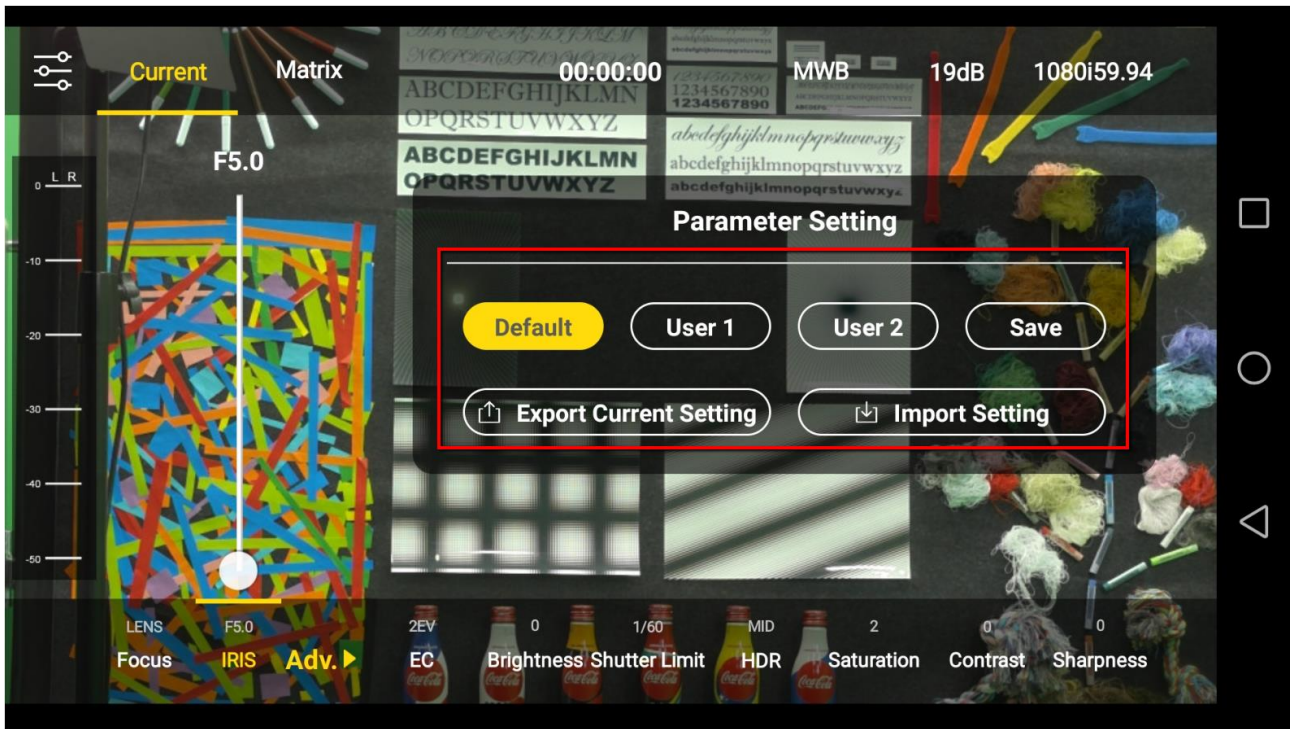

- **Default:** Press this key to set the current BC-100 parameters to factory default values.
- **User 1 and User 2:** User 1 and User 2 allow users to adopt pre-saved 2 sets of parameters that are set by themselves.

Step 1. Please press “User 1” or “User 2” and then the following window will be shown to ask whether users want to adopt pre-saved user-defined settings or not.

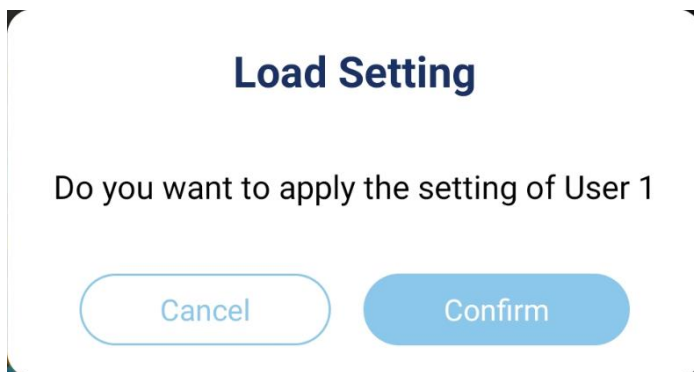

Step 2. Please press the “Confirm” button to load the user-defined setting.

- **Save:** The “Save” button allows users to save 2 sets of user-defined settings.

Step 1. Please set the parameters of the BC-100 in advance.

Step 2. Please press the “Save” button.

Step 3. The “Save Current Setting” window will be shown. Please press “User 1” or “User 2” and then please press the “Confirm” button to save the preset parameters to “User 1” or “User 2”.

## Save Current Setting

Save current adjusting parameter setting to:

User 1	<input checked="" type="radio"/>
User 2	<input type="radio"/>

Cancel

Confirm

- **Export Current Setting:** The “Export Current Setting” option allows users to export current settings.

Step 1. After all parameters are set, please press the Current option on the main interface and then users can select “**Export Current Setting**” from the pop-up window.

Step 2. Please enter your desired name for the setting in the “Export Current Setting” pop-up window. After that, please press the “Confirm” button to export the parameters to the handset which is used to control the BC-100 for future application.

## Export Current Setting

Please enter the name of the setting

Cancel

Confirm

- **Import Setting:** The “Import Setting” option allows users to import pre-saved parameters.

Step 1. After all parameters are set, please press the “Current” option on the main interface and then users can select “**Import Setting**” from the pop-up window.



Step 2. In the pop-up “Import Setting” window, please select the parameter setting name that users want to import into the camera and then please press the “Confirm” button to import the setting into the BC-100 camera.

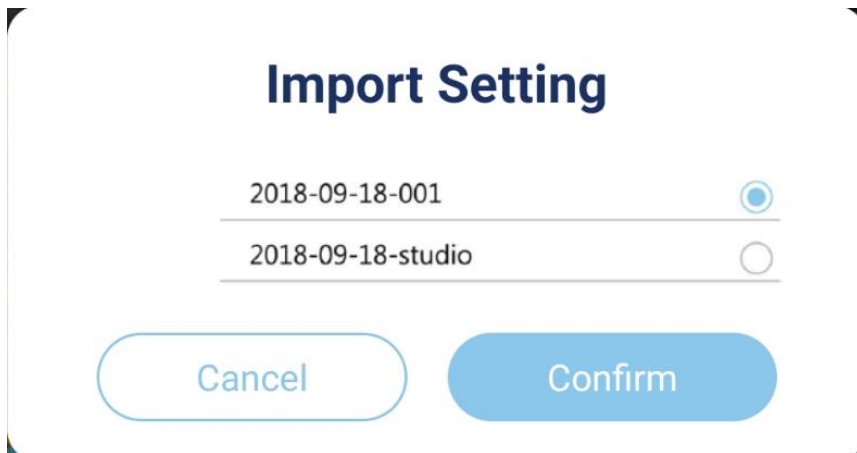

### 5.3 Exposure Modes

The Exposure Modes option is located on the option menu bar on the top side of the main interface. This option provides four Exposure Modes including **Matrix Metering**, **Center-Weighted Metering**, **Exposure Lock** and **Manual Exposure** for users.

#### How to Enter the Exposure Mode Option

Please follow following steps for entering the Exposure Mode option.

Step 1. Please press the Matrix option **Matrix** from the main interface of the BC-100 App.

Step 2. The setting interface which is shown as following diagram will be shown to provide four exposure modes include **Matrix Metering**, **Center-Weighted Metering**, **Exposure Lock** and **Manual Exposure** for users.

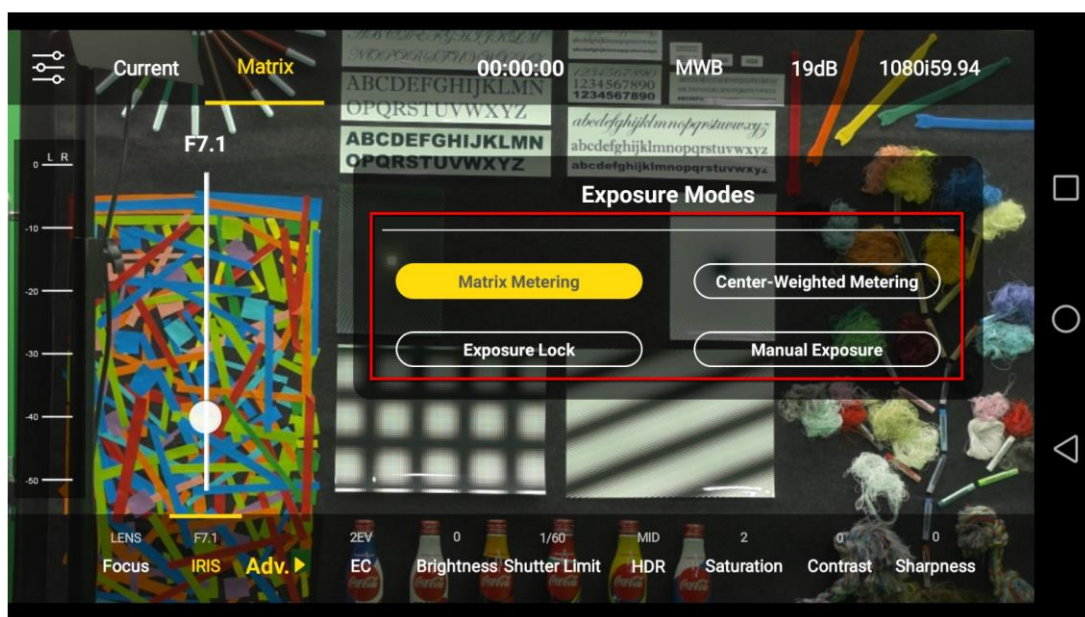

- **Matrix Metering:** The Matrix Metering technology is an automatic exposure technology to achieve stable exposure status by measuring the average brightness of the whole scene. Moreover, this technology also takes the photo composition and the change of the subject location into consideration. The Matrix Metering is a common exposure technology. It separate the scene of the whole picture into several blocks and each block has its independent exposure value. After the exposure value of each block is calculated, the exposure values of all blocks will be combined together for further calculation in order to provide a final exposure value. The Matrix Metering technology allows users to take a picture with average brightness to prevent the picture from too bright or too dark. The Matrix Metering technology is suitable for taking group or scenery pictures in average brightness. The Matrix Metering exposure technology can be set as default exposure mode.

➤ **The Scenarios that is suitable for using the Matrix Metering**

A: The scenario for taking pictures has average brightness and the brightness, darkness and contrast of the picture are moderate.

B: The Matrix Metering can be used in “front light of the subject” and “front side light of the subject”.

Please follow following steps for using the Matrix Metering.

Step 1. Please press the Matrix Metering option **Matrix** from the main interface of the App.

Step 2. The setting interface which is shown as following diagram will provide four exposure modes including **Matrix Metering**, **Center-Weighted Metering**, **Exposure Lock** and **Manual Exposure**.

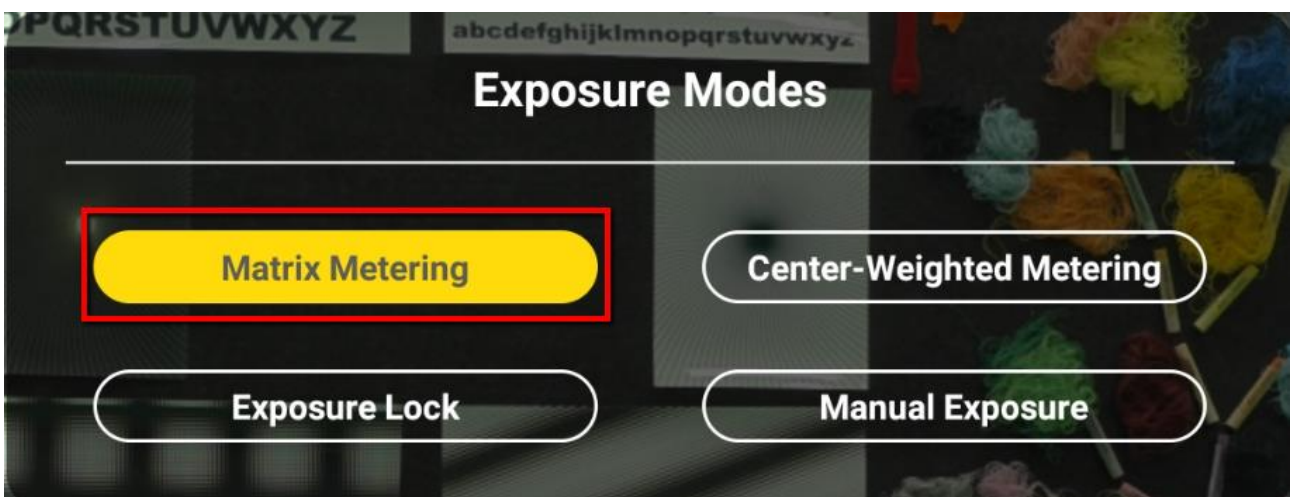

Step 3. Please press the **Matrix Metering** button to finish the setting.

- **Center-Weighted Metering:** The Center-Weighted Metering measures the average brightness of the whole picture. At the same time, the central area of the picture is emphasized (Center-Weighted Metering). The reason for designing this exposure mode is that for most of the people, they will put the subject of the photo at the center. The Center-Weighted Metering

will average the exposure value of the whole picture. However, it will give extra-weighted calculation for the subject on the central location. So, if the subject of the picture is not located at the center of the picture (occupy about 30% of the space of the picture), it is not recommended to use this Center-Weighted Metering.

➤ **The Scenarios that is suitable for using the Center-Weighted Metering**

A: The subject of the picture is located at the center of the picture.

B: The subject of the picture is back-lighted or is surrounded by glare.

Please follow following steps for using the Center-Weighted Metering.

Step 1. Please press the Matrix Metering option **Matrix** from the main interface of the App.

Step 2. The setting interface which is shown as following diagram will provide four exposure modes including **Matrix Metering**, **Center-Weighted Metering**, **Exposure Lock** and **Manual Exposure**.

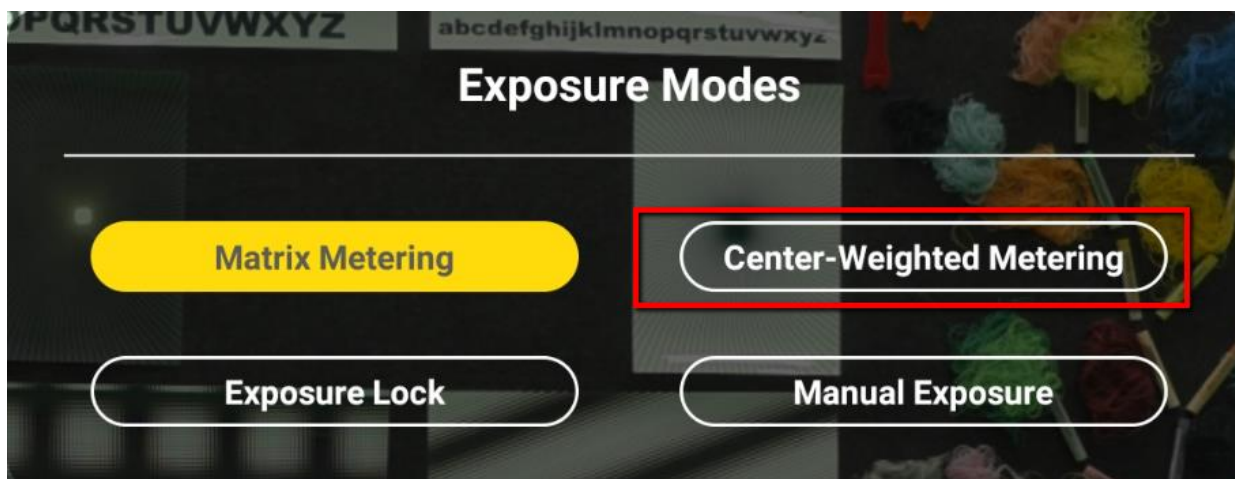

Step 3. Please press the **Center-Weighted Metering** button to finish the setting.

- **Exposure Lock:** After the Exposure Lock button is pressed, the BC-100 will stop light metering and the light metering value will be kept at the value before the camera is moved. At this time, no matter how the BC-100 camera is moved, the light metering value will remain unchanged.

Note: After the Exposure Lock button is pressed, the Gain Limit, Shutter Limit and Exposure Compensation value can not be adjusted.

➤ **The Scenarios that is suitable for using the Exposure Lock**

If the contrast between the subject and the background is high (For example: taking pictures for back-lighted subject or the subject that is beside the window), users can do the light metering at the point that the subject is with proper brightness. After that, users can lock the Exposure value before taking pictures. If users want to reduce the brightness of the subject, users can do the light

metering at the point that the brightness is higher than the subject. After that, users can lock the Exposure value of the whole screen. If users want to take a picture with brighter subject, users can do the light metering at the point that is darker than the subject. After that, users can lock the Exposure value of the whole screen.

Please follow following steps for using the Exposure Lock.

Step 1. Please press the Matrix Metering option **Matrix** from the main interface of the App.

Step 2. The setting interface which is shown as following diagram will provide four exposure modes including **Matrix Metering**, **Center-Weighted Metering**, **Exposure Lock** and **Manual Exposure**.

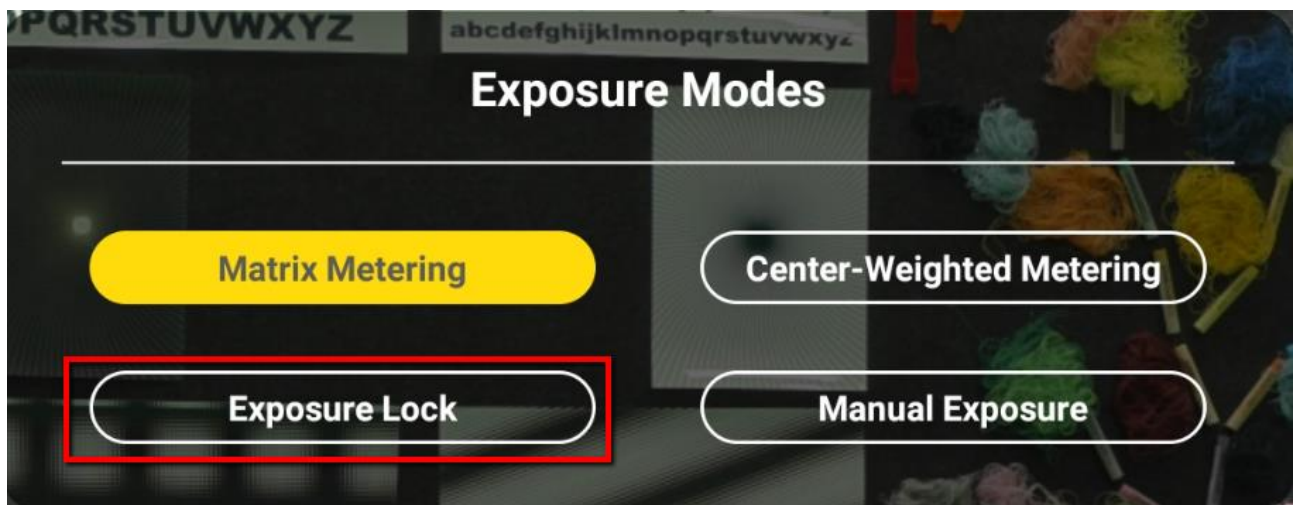

Step 3. Please press the **Exposure Lock** button to finish the setting.

Note: After the Exposure Lock button is pressed, the Exposure Compensation function can not be used.

- **Manual Exposure:** The Manual Exposure mode allows users to set various parameters including Iris, Shutter and Gain manually.

Please follow following steps for using the Manual Exposure.

Step 1. Please press the Matrix Metering option **Matrix** from the main interface of the App.

Step 2. The setting interface which is shown as following diagram will provide four exposure modes including **Matrix Metering**, **Center-Weighted Metering**, **Exposure Lock** and **Manual Exposure**.

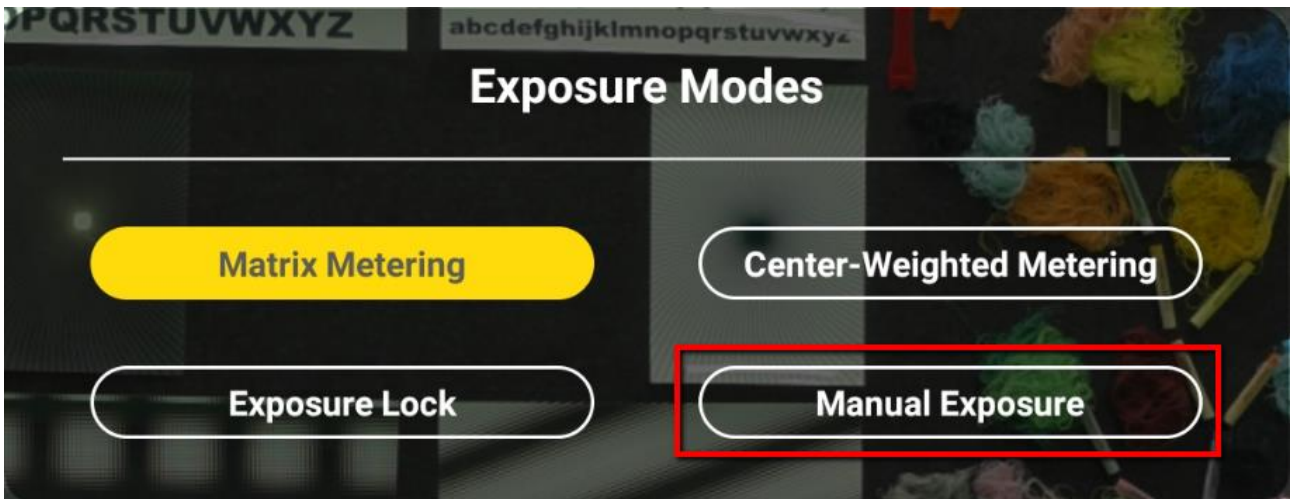

Step 3. Users can press the **Manual Exposure** button which is shown as the above diagram for setting the Shutter and Gain manually.

Step 4. In Manual Exposure Mode, please press the Adv. Option which is shown as following diagram to show the shutter option for users to adjust the shutter speed manually by the shutter slider.

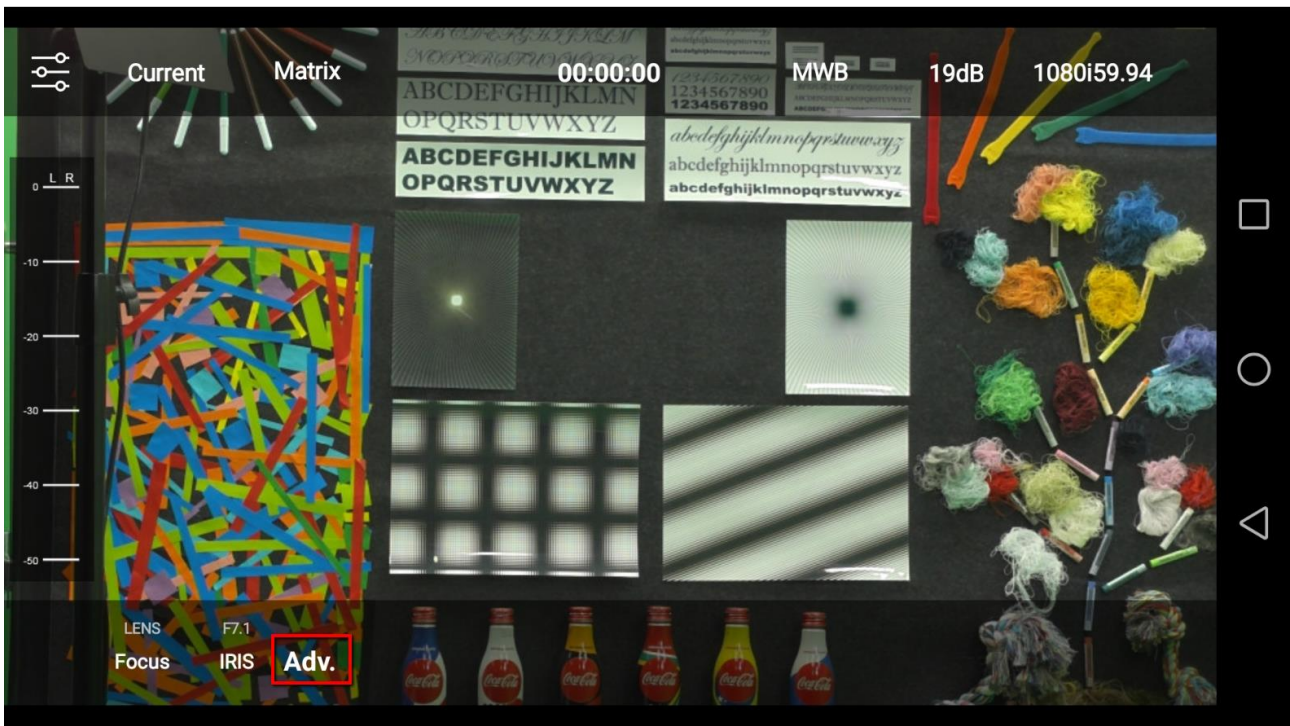

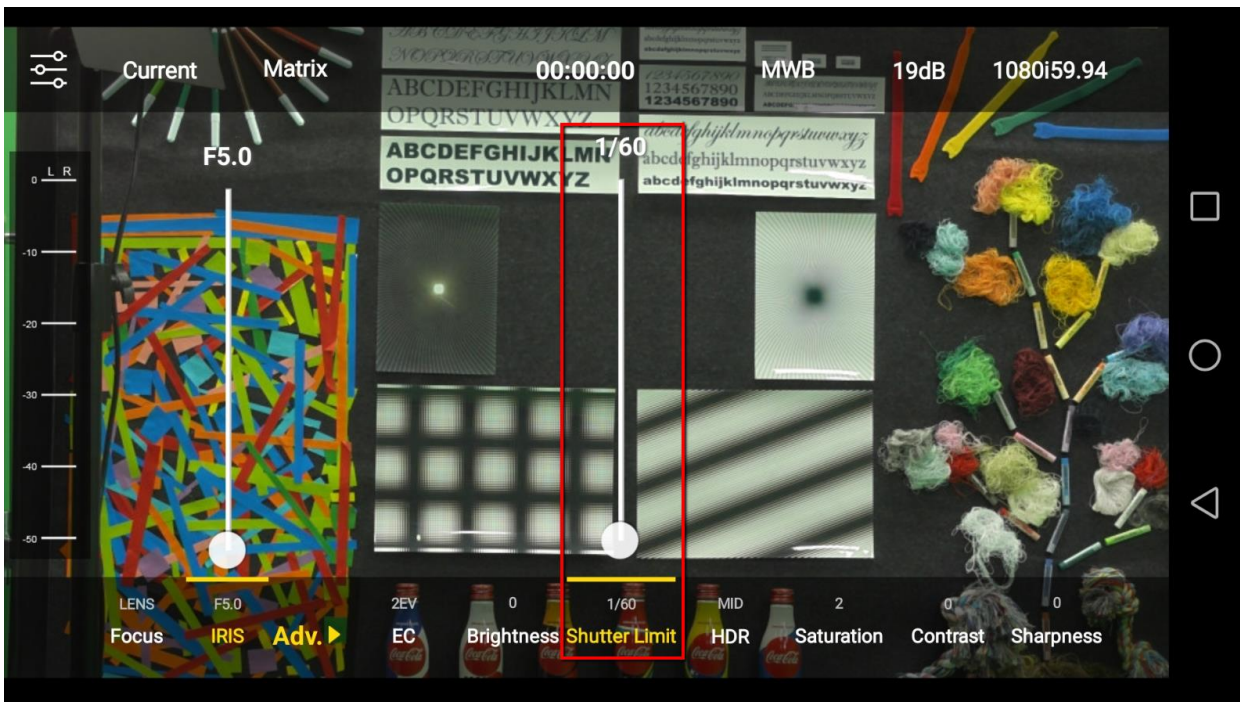

Step 5. In the Manual Exposure Mode, please press the 19dB option which is shown as following diagram to enter the Gain Limit option to adjust the Gain Limit manually by the Gain Limit slider.

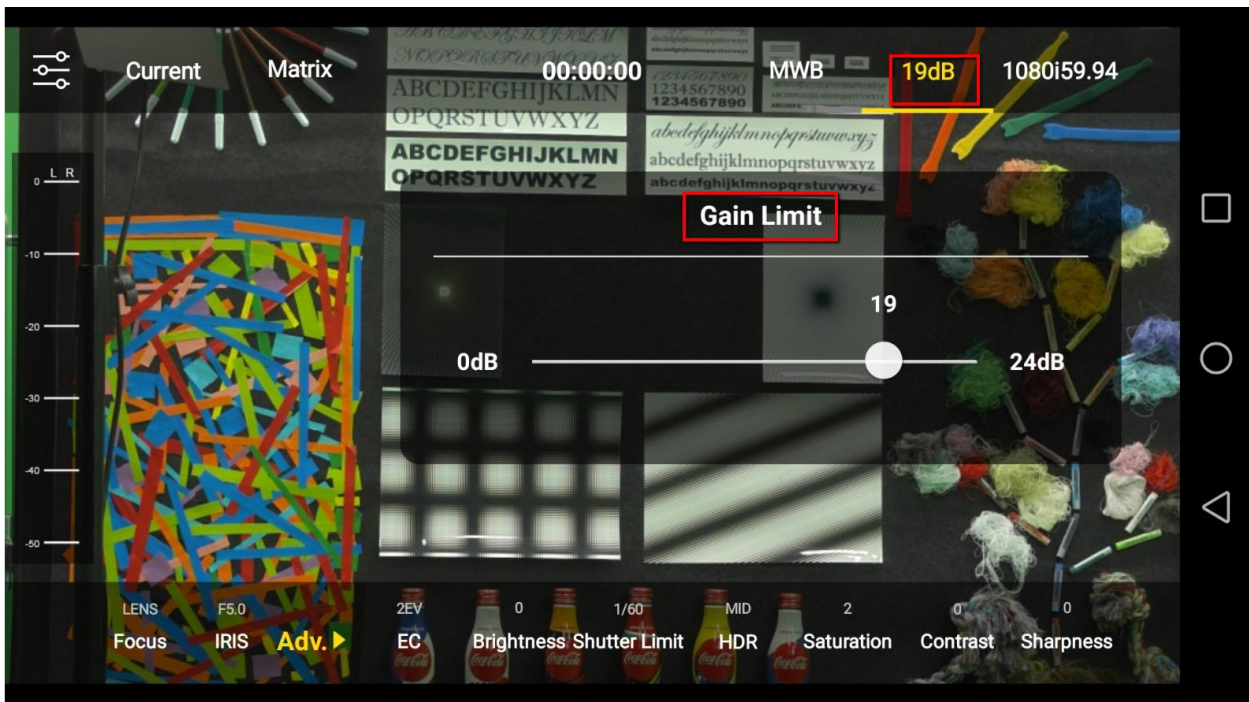

#### 5.4 Recording Status Reminder

The purpose of the Time Code and the Status Reminder are used to remind users about the recording status. Because the BC-100 interchangeable lens camera does not have the recording function, so, users need to connect the BC-100 to the external connected recorder such as Atomos or Blackmagic Design recorder for video recording.

After the Time Code which is shown as following diagram is pressed by users, there is a recording reminder window will pop-up to remind users to check that the external connected recorder is connected successfully and then the video recording can be started.

00:00:00

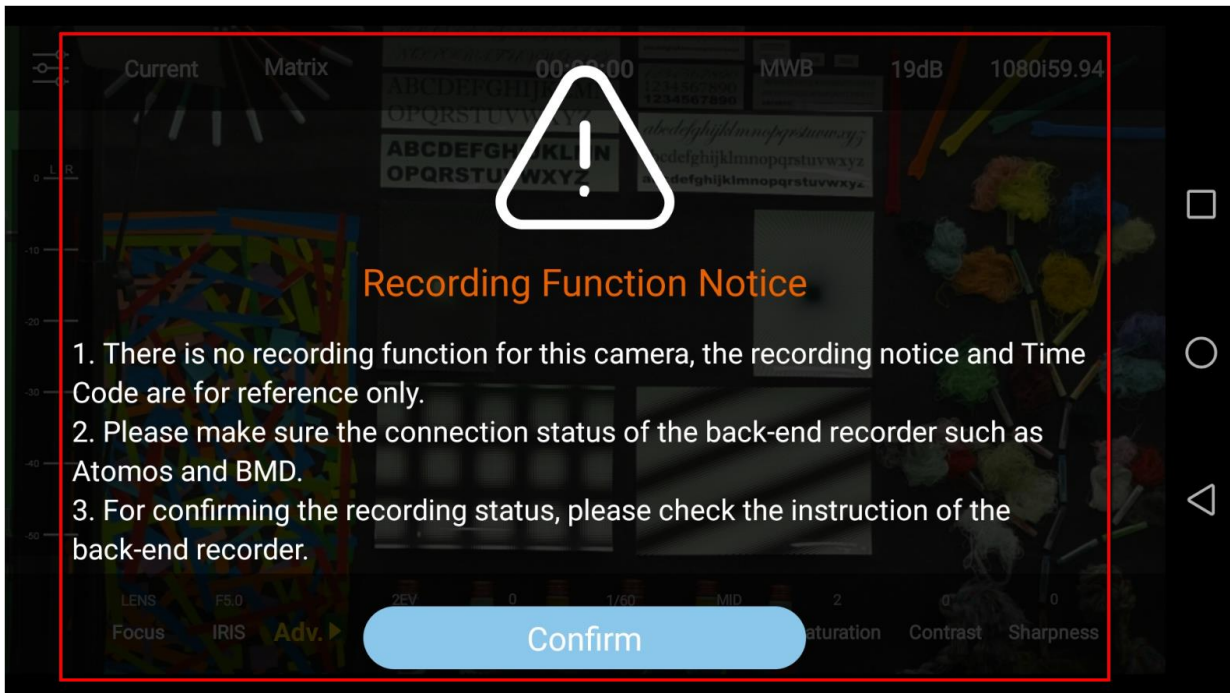

Because the BC-100 App can not detect that whether the back-end recorder is connected or not, so, once the external connected optional LANC control button of the BC-100 is pressed, the recording Time Code timer will be started. In recording process, the red dot which is next to the recording Time Code will be lighted up. If the recording is terminated, the red dot will disappear.

**Note:**

1. There is no recording function for the BC-100 camera, the recording reminder and the Time Code in the App are for reference only.
2. Please remember to check the connection status of the back-end recorder such as Atomos or Blackmagic Design's recorder.
3. For confirming the status of the video recording, please check the status of the back-end external connected recorder.

## 5.5 Automatic White Balance (AWB)

### What is AWB

Human eyes can adjust itself automatically in the nature environment to see the white light. However, the camera can not do the same thing as the human eyes, so, the color temperature of the camera must be set in advance before pressing the shutter. The color temperature setting allows the camera to balance the color temperature and to see the white light. The function of this setting is the so called “White Balance”.

The AWB option is in the menu bar on the top of the main interface of the App. This option provides five White Balance modes including AWB, AWB Lock, One Push, MWB and MWB Pro for users.

### How to Enter the AWB Option

Please follow following steps for entering the AWB option  .

Step 1. Please press the AWB option from the main interface of the App.

Step 2. The setting interface which is shown as following diagram will be shown to provide five White Balance modes including **AWB**, **AWB Lock**, **One Push**, **MWB** and **MWB Pro** for users to select.

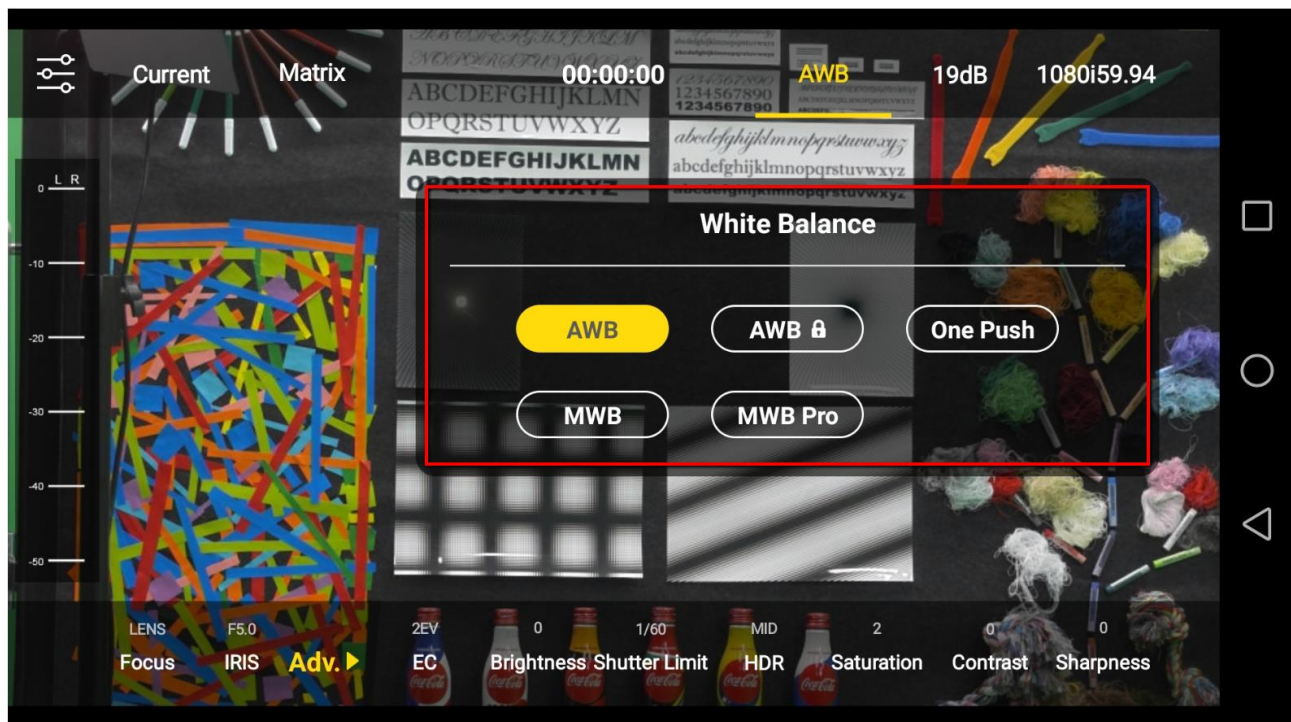

- **AWB:** Press the **AWB** button which is shown as the following diagram allows users to adopt AWB setting by pressing one button only.
- **AWB (Lock):** Users can press the **AWB (Lock)** button at once after the AWB button is pressed to lock the current AWB setting.



- **One Push:** The **One Push** button allows users to use the One Push White Balance function and then lock the current WB setting.

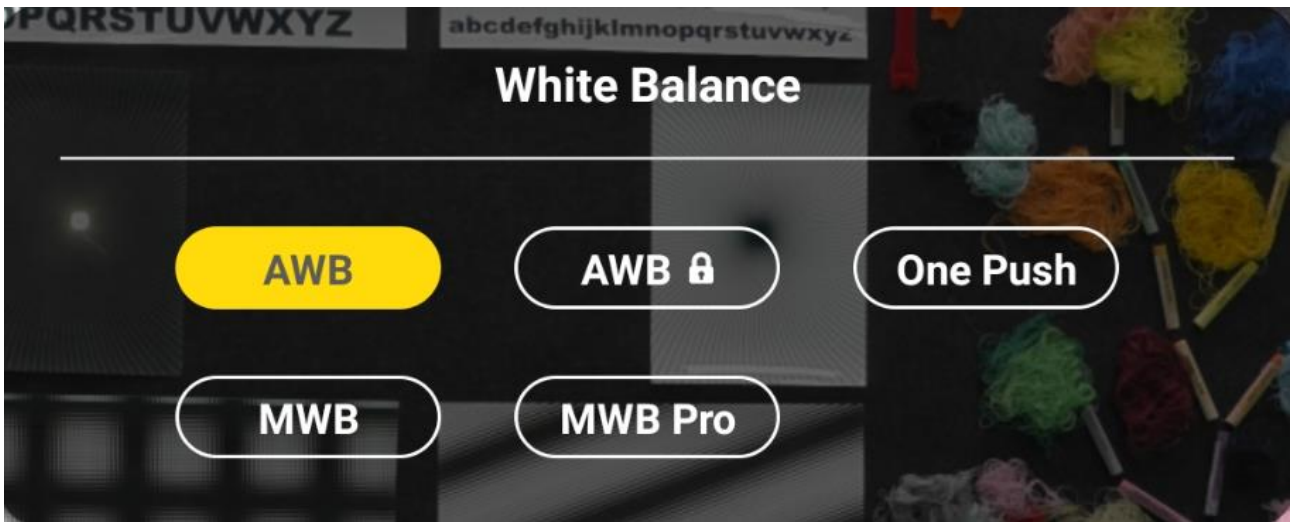

- **MWB:** Users can press the MWB button to adjust the desired White Balance color temperature by the slider which is shown as the following diagram. The adjustable color temperature range is 2500K to 10000K.

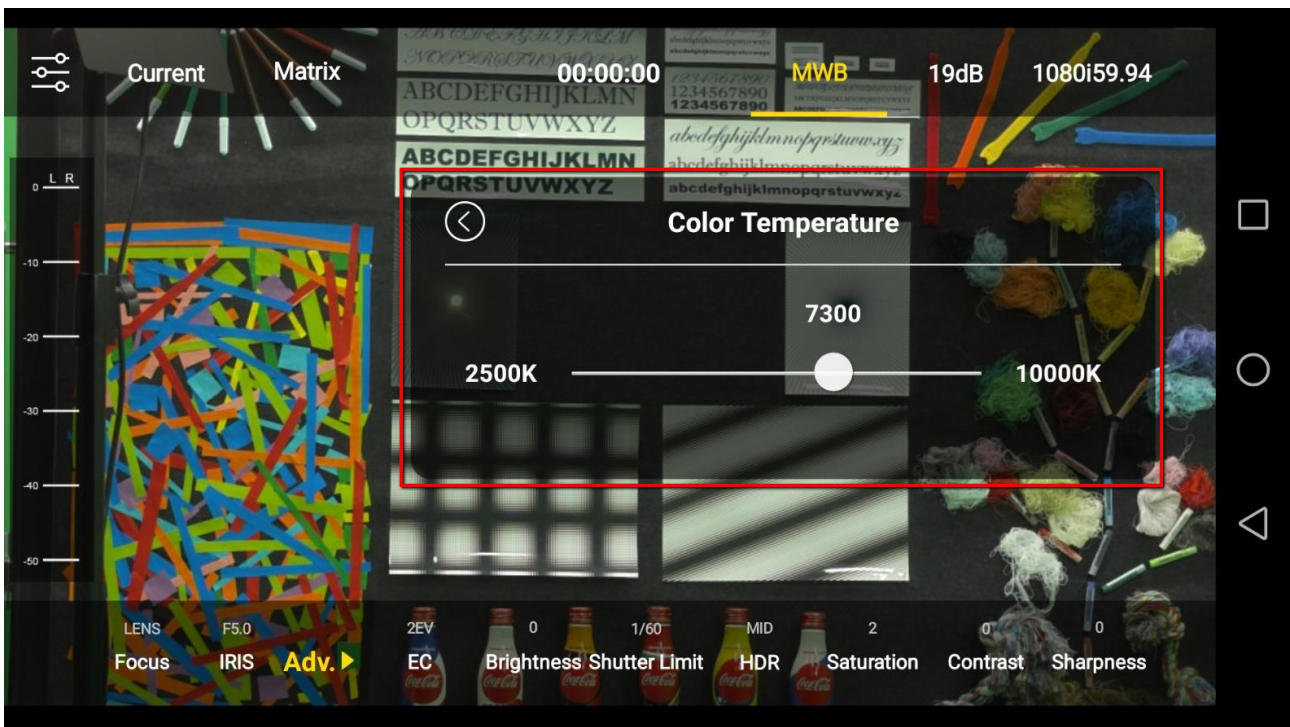

- **MWB Pro:** Users can press the **MWB Pro** button in the White Balance menu to adjust the **R Gain** and **B Gain** manually by the slider which is shown in the following diagram.

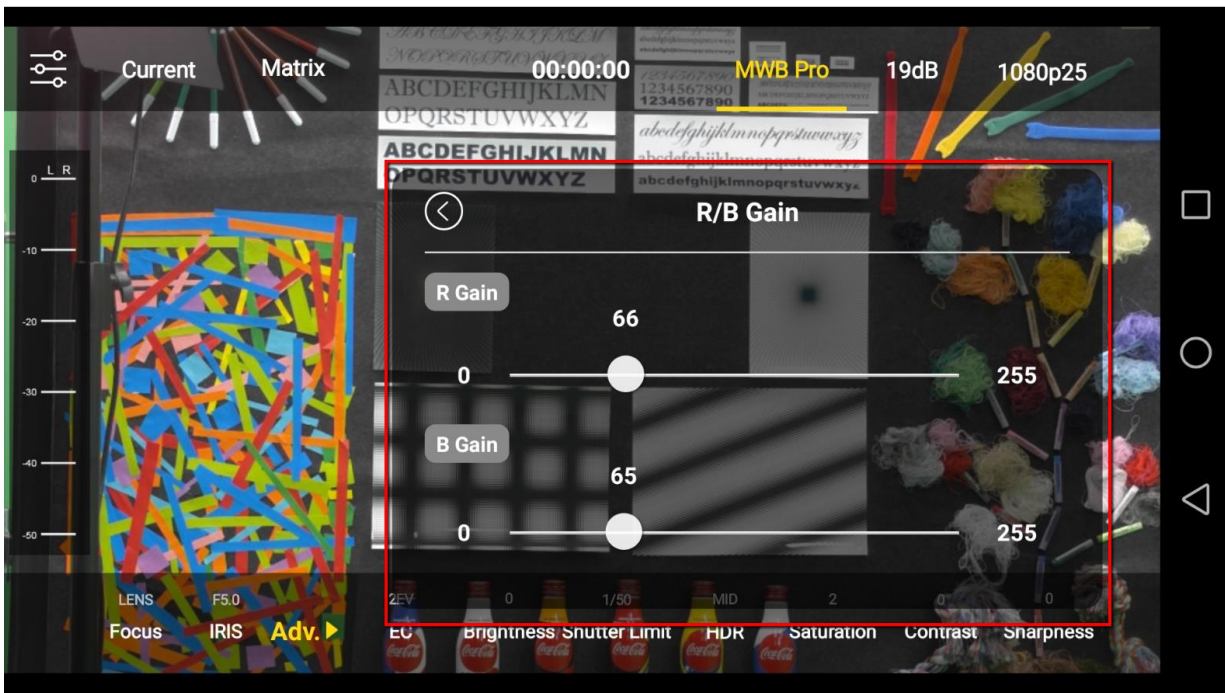

## 5.6 Gain/Gain Limit

The Gain of the camera is used to enhance the sensitivity of the CCD component. Users can adjust the Gain option depending on the change of the brightness of the shooting environment. When the environment is too dark, users can increase the Gain value and the picture will become brighter. If the environment is too bright, decrease the Gain value and the picture will become darker. If the shooting environment has normal brightness, users can set the Gain value in normal range.

### How to Enter the Gain Limit/Manual Gain Option

Please follow following steps for entering the Gain Limit or Manual Gain option.

Step 1. Please press the 19dB option on the main interface of the App.

Step 2. The setting interface which is shown as following diagram will be shown for users to adjust their desired Gain value manually by the slider.

**Note:** The adjustment range for the Gain/Gain Limit is 0 to 24 dB. This option will show to be **Gain Limit** if the camera is set in automatic exposure modes. Moreover, in Manual Exposure mode, this option will show to be **Manual Gain**.

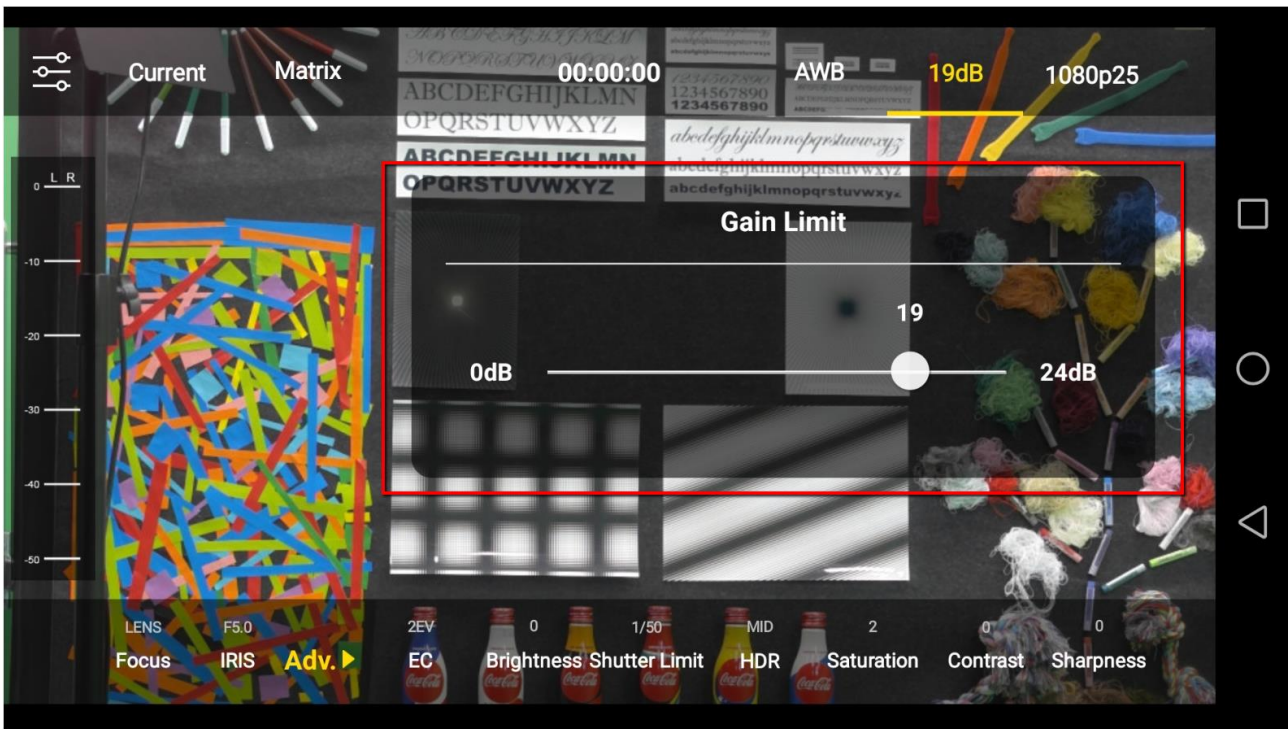

## 5.7 Frame Rate

Frame rate means that the camera can record how many pictures within 1 second. If the frame rate is set to be 60fps, it means that users need to use the  $\frac{1}{60}$  second or faster shutter speed. Why? Because if the  $\frac{1}{30}$  second shutter speed is used, it means that there are only 30 shutters within 1 second. If the recording format is 60fps, it means every two frame must share the same picture that is sent by the same shutter. The outcome is the same with 30fps but it needs one time storage space than the  $\frac{1}{60}$  second shutter. Moreover, if users want to play this video in slow-motion mode, it can not be played as smooth as the video that is shot by the 60fps format. So, the shutter speed must be set to be faster than the frame rate. For example, if the frame rate is set to be 60fps, the shutter speed must be set to be  $\frac{1}{60}$ ,  $\frac{1}{120}$  or  $\frac{1}{180}$ .

### How to Enter the Frame Rate Option

Please follow following steps for entering the Frame Rate option **1080p25** .

Step 1. Please press the Frame Rate option (1080p25) from the main interface of the App.

Step 2. The Frame Rate selection button interface which is shown as following diagram will be shown for users to select their desired Frame Rate.

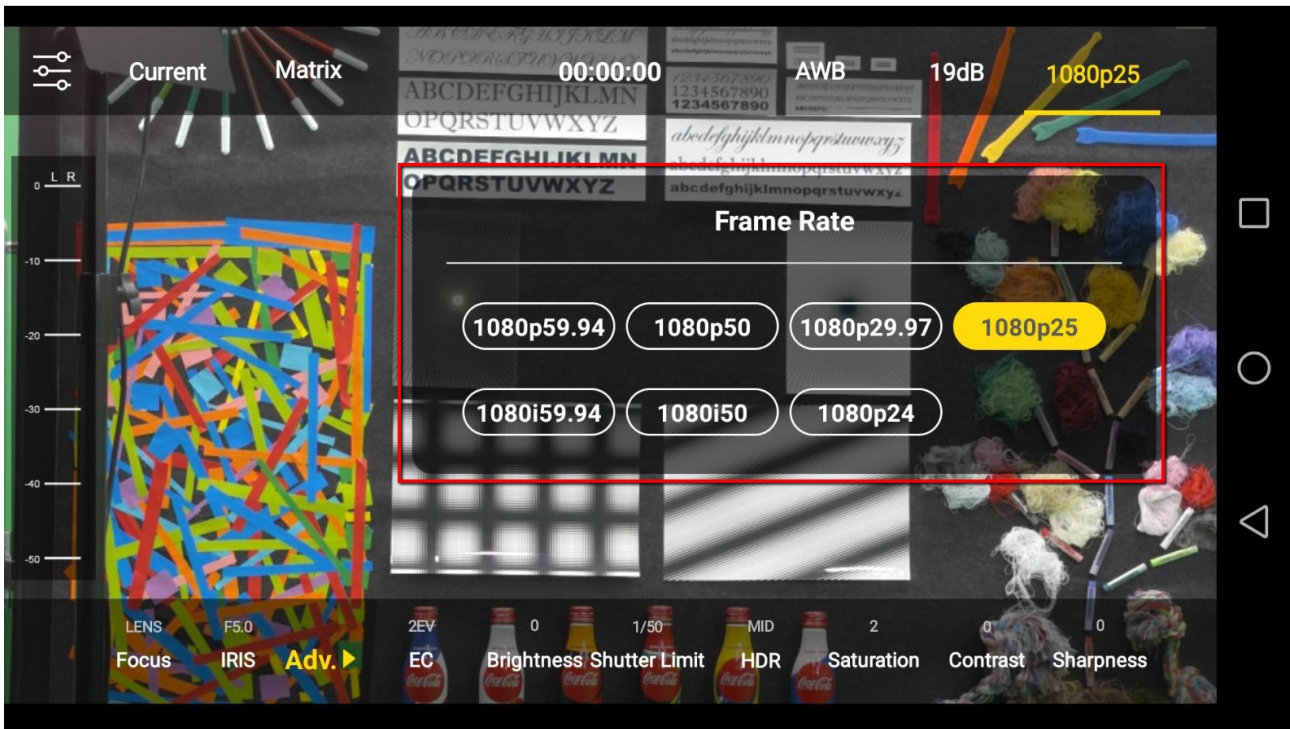

Step 3. Press your desired Frame Rate button to finish the Frame Rate setting.

## 5.8 Focus

The Focus option provides three Focus modes including **AF**, **MF** and **Lens** for users to select their desired Focus mode.

### How to Enter the Focus Option

Please follow following steps for entering the Focus option .

Step 1. Please press the Focus option on the main interface of the App.

Step 2. The Focus Selection buttons interface which is shown as following will be shown for users to select their desired Focus mode.

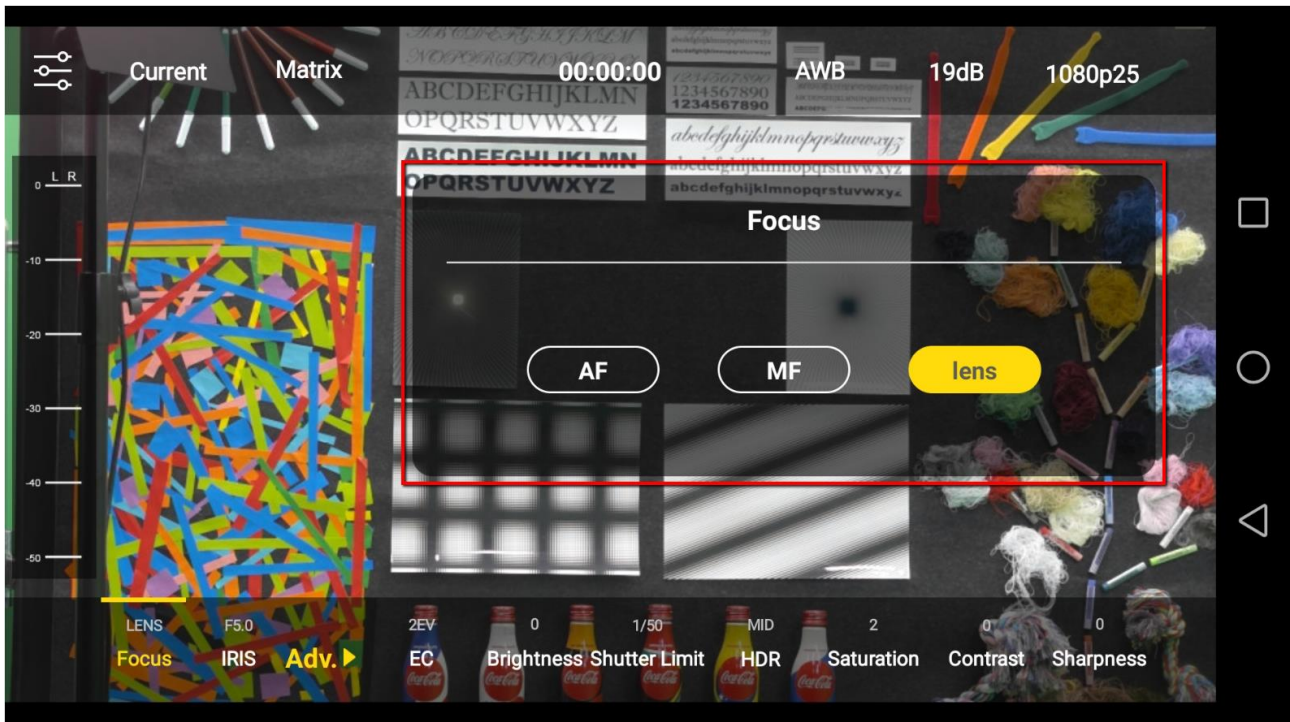

- AF: AF is the Auto Focus function. Please follow following steps for using the AF function.

Step 1. Please set the AF/MF switch on the camera lens which is connected to the BC-100 in AF mode.

**Note:** If there is no AF/MF switch on the camera lens, it is no need for users to switch the Focus mode.

Step 2. Please press the AF button in the Focus option to adopt the AF setting.

Step 3. Please press any point on the screen for using the AF function (The Auto Focus Tracking function is not available).

- MF: MF is the Manual Focus function, please follow following steps for using the MF function.

Step 1. Please set the AF/MF switch on the lens of the BC-100 camera to be MF.

**Note:** If there is no AF/MF switch on the camera lens, it is no need for users to switch the Focus mode.

Step 2. Please press the MF button in the Focus option to use the MF slider for MF setting. When the point of the slider is located at the center, push the slider to the up side for Infinity and push the slider to the down side for the minimum focal length.

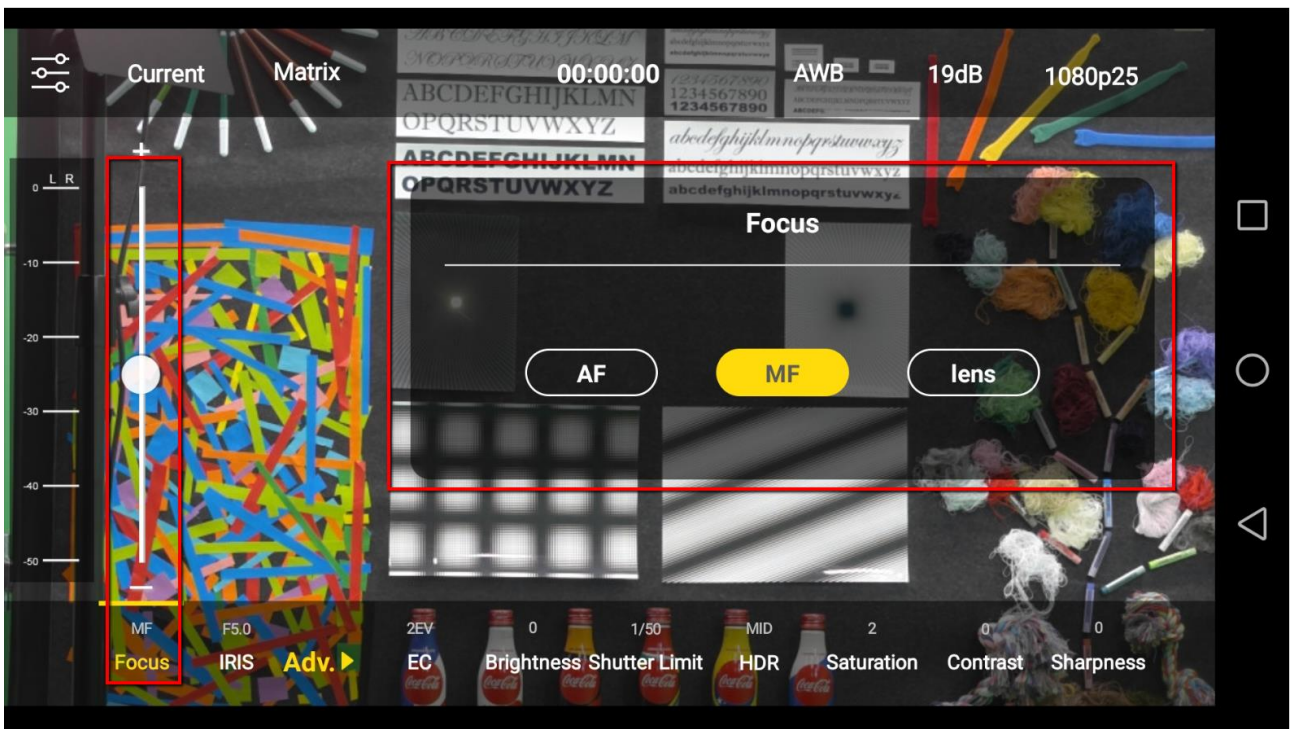

Step 3. After the adjustment is finished, press the MF option again to hide the slider.

- The MF button on the main interface: When users press the Focus option and then select the MF mode, there is a MF button that will be shown beside the Focus option. If you want to switch from the MF mode to other Focus mode, please press this MF button and then the Focus option window which is shown as above diagram will be shown for you to switch to other Focus modes.

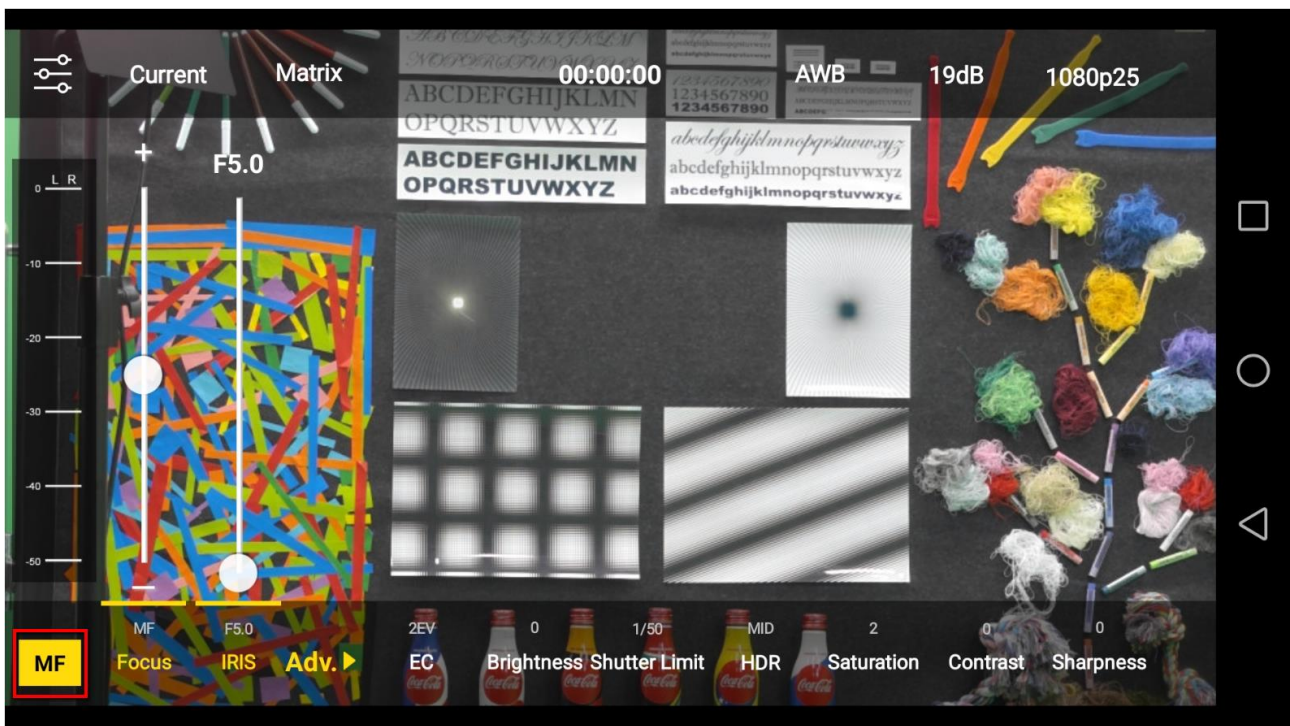

- Lens: The Lens option allows users to use the Focus function on the camera lens directly. Please follow following steps for using the Lens function.

Step 1. Please set the AF/MF switch on the lens of the BC-100 camera to be MF, if there is no AF/MF switch on the camera lens, it is no need for users to switch the Focus mode.

Step 2. After the Lens option is pressed, users can adjust the Focus ring on the camera lens to set the Focus point directly.

## 5.9 IRIS

The IRIS option allows users to adjust the IRIS value. The IRIS value determines how much the incoming light that will received by the IRIS of the camera. Users can set a low IRIS value for achieving a larger IRIS. Moreover, a high IRIS value means a smaller IRIS. A lower IRIS value helps users for taking high quality and bright pictures. Moreover, the IRIS value also affect the Depth of Field of a picture. The “Depth of Field” means the range that the image is clear. A higher IRIS value can help users to take a picture with the “Deep Depth of Field” effect. However, a low IRIS value can help users to take a picture with the “Shallow Deep of Field” effect. The BC-100 App provides the IRIS range from F2.8 to F22 for users to set their desired IRIS value. The IRIS value is set by reading the IRIS value of the camera lens. If there is no controllable camera lens that is detected by the App, the IRIS option can not be selected by users.

### How to Enter the IRIS Option

Please follow following steps for entering the IRIS option .

Step 1. Please press the IRIS option from the main interface of the App.

Step 2. The IRIS adjustment slider which is shown as following diagram allows users to select their desired IRIS value.

Step 3. After the adjustment is finished, please press the IRIS option again to hide the slider.

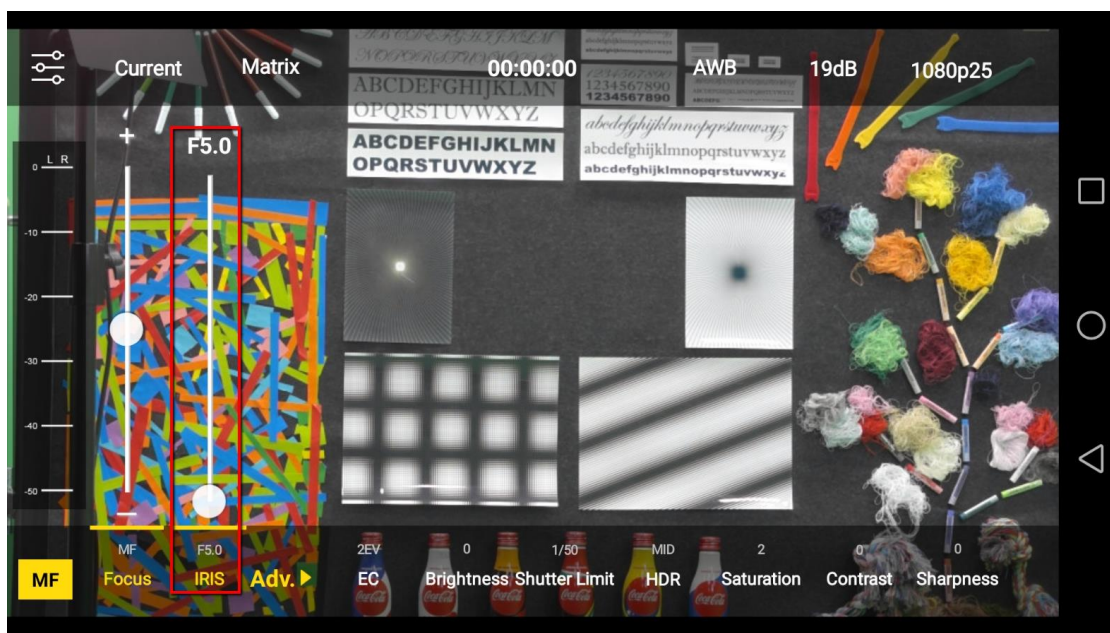

## 5.10 Advanced Function

The BC-100 App provides several advanced functions for users including **EC** (Exposure Compensation), **Brightness**, **Shutter** or **Shutter Limit**, **HDR**, **Saturation**, **Contrast** and **Sharpness**. In normal situation, all advanced functions are hidden, users can show those advanced functions by pressing the Adv. Option which is shown as following diagram.

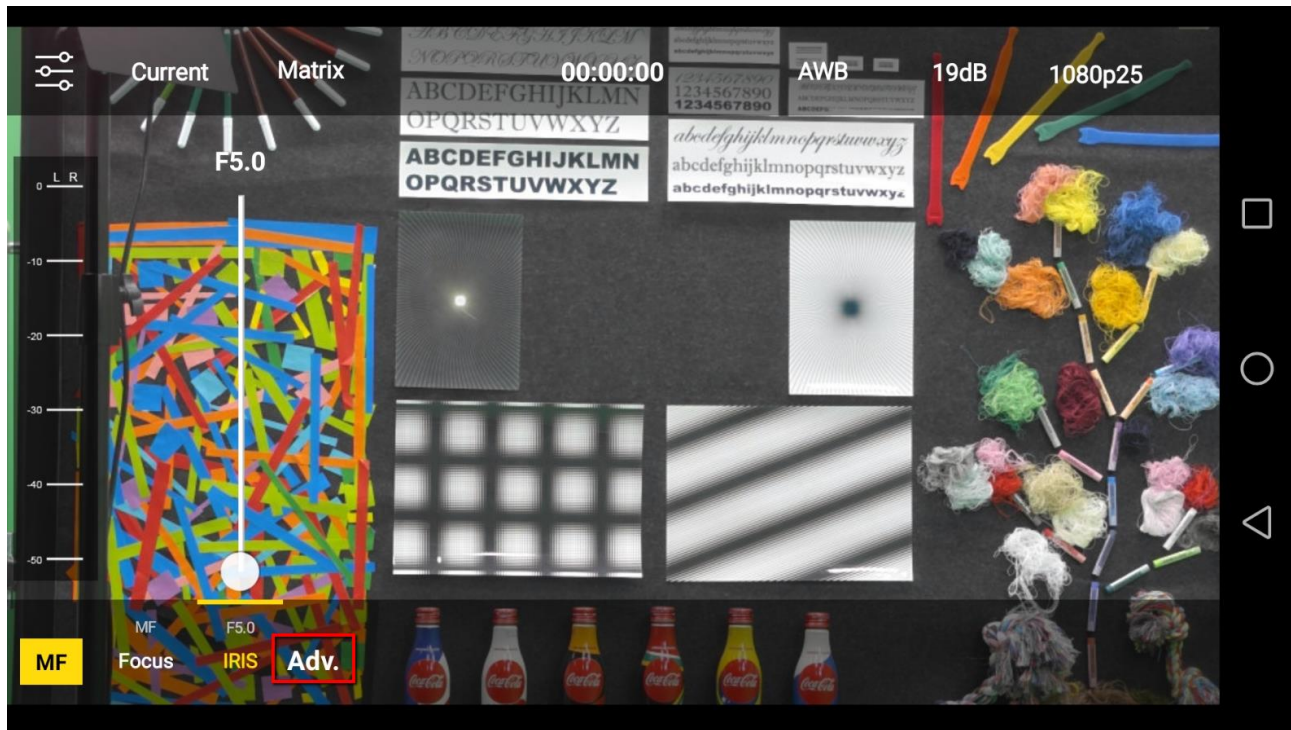

## 5.11 EC (Exposure Compensation)

BC-100 provides Exposure Compensation range from -8EV to +8EV for users to adjust the Exposure Compensation level. No matter which Exposure mode is selected by the user, the camera will measure the light of the current scenario. After that, an EV level based on the ISO and light-measuring formula according to the current scenario will be generated (the total volume of incoming light). This EV value is generated by the combination of IRIS and Shutter. The purpose of the Exposure Compensation is that if users do not satisfy for the light-measuring outcome of the camera, they can adjust the EV value to get an “Expected EV value” for taking a better picture. 0EV is the default EV value of the camera. +1EV means brighter EV value and -1EV means darker EV value.

### How to Enter the EC Option

Please follow following steps for entering the EC option .

Step 1. Please press the EC option from the main interface of the App.

Step 2. The EC adjustment slider will be shown for users to select their desired EC level.



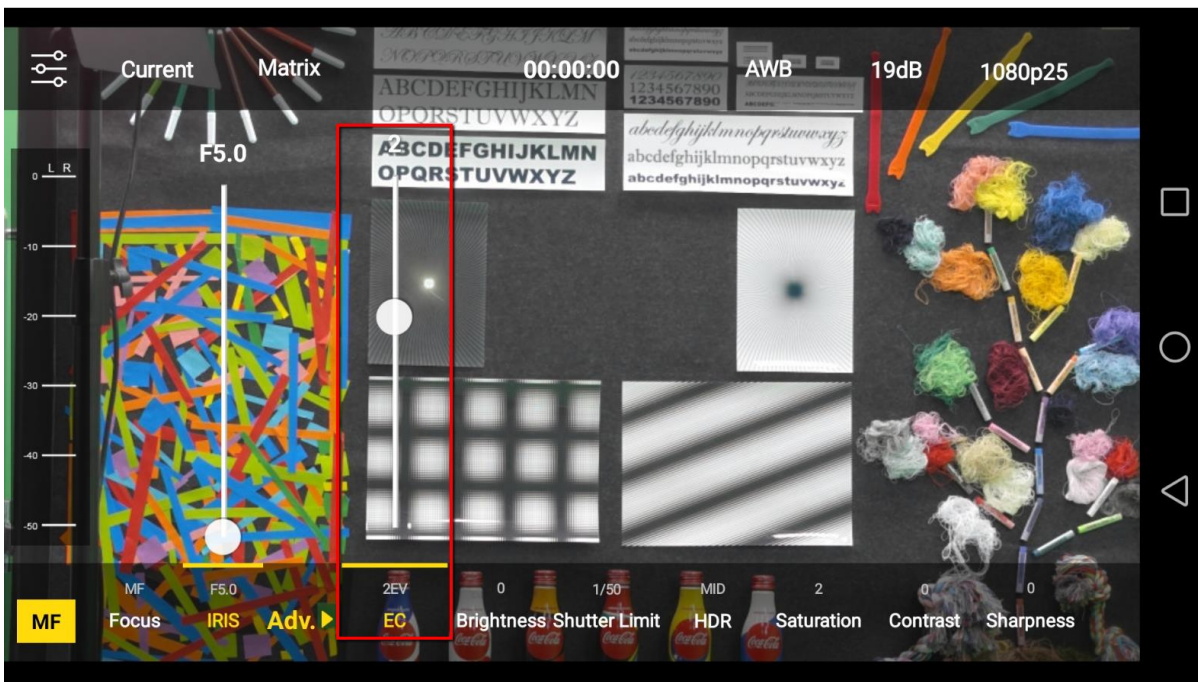

## 5.12 Brightness

The BC-100 provides the Brightness adjustment range from -10 to +10 for users. The Brightness option allows users to adjust the brightness by a slider. When the slider is set at the negative value, it will provide contrast for the high-light area. Moreover, the middle tone will become darker (those areas except high-light and shadow areas). When the slider is set at positive value, the scenario can be brighter. The brightness adjustment is useful when the Exposure Compensation may cause the color-fading of the high-light area.

### How to Enter the Brightness Option

Please follow following steps for entering the Brightness option .

Step 1. Please press the Brightness option from the main interface of the App.

Step 2. The brightness adjustment slider that is shown as the following diagram allows users to select their desired brightness value.

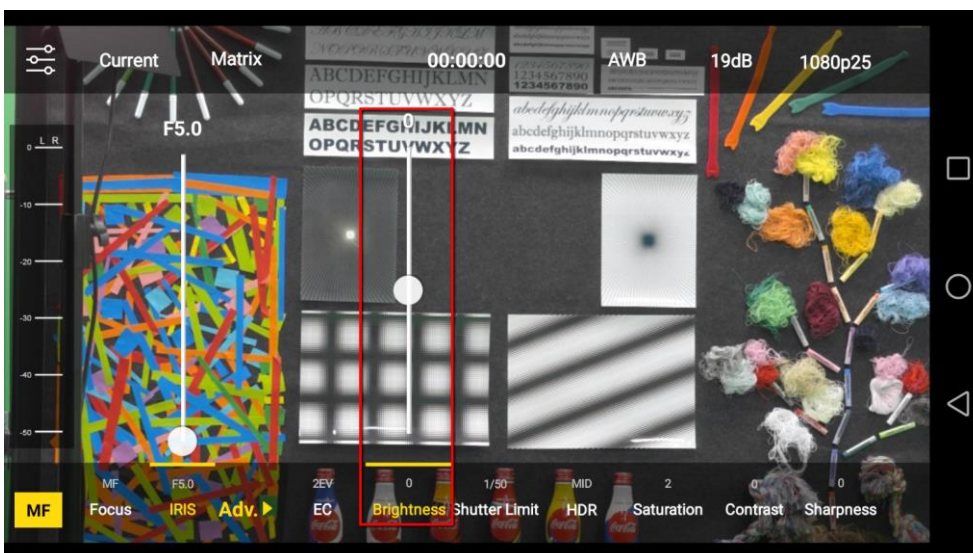

### 5.13 Shutter or Shutter Limit

When the shutter released button is pressed, the shutter curtain will be opened, and the CMOS sensor which is behind the shutter curtain will receive the light. The light will penetrate by the IRIS of the camera. When the shutter is open, the light will irradiate on the CMOS sensor. After that, the shutter curtain will go back to its original place to cover the CMOS sensor and the light will be stopped by the shutter curtain. This is the process for taking a picture. The time length that the CMOS sensor is irradiated by the light is called “Exposure Time”. If the time length is 1 second, it means that the exposure time is 1 second. Different shutter speed can achieve different function and performance. Generally speaking, “high shutter speed” can freeze each moment. However, the slow shutter speed can record the scenario such as the cars are flowing on the road.

#### How to Enter the Shutter/Shutter Limit Option

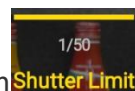

Please follow following steps for entering the Shutter Limit Option

Step 1. Please press Shutter or Shutter Limit option from the main interface of the App.

Step 2. The Shutter/Shutter Limit adjustment slider which is shown as following diagram will be shown for users to select their desired Shutter/Shutter Limit value.

Note: It is recommended to set the shutter speed to be two times of the frame rate. For example, if the frame rate is set as 25p, the shutter speed must be set at 1/50. If the frame rate is 29.97p, the shutter speed must be set at 1/60.

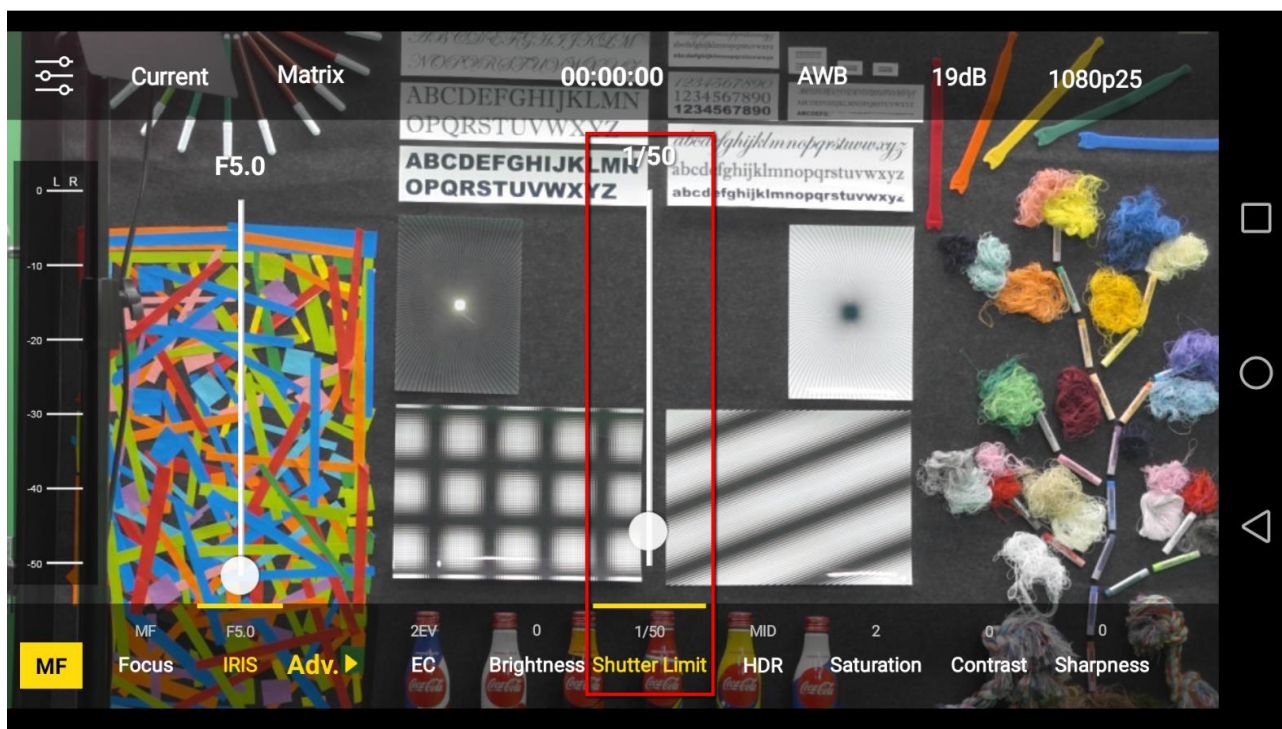

The BC-100 provides different Shutter/Shutter Limit ranges for different frame rate settings.

- 24P: 1/24, 1/48, 1/72, 1/96, 1/120, 1/144, 1/168, 1/480, 1/960, 1/1920, 1/3840, 1/7200
- 25P: 1/25, 1/50, 1/75, 1/100, 1/125, 1/150, 1/200, 1/500, 1/1000, 1/2000, 1/4000, 1/8000
- 29.97P: 1/30, 1/60, 1/90, 1/120, 1/150, 1/180, 1/210, 1/600, 1/1200, 1/2400, 1/4800, 1/9000
- 50P: 1/50, 1/75, 1/100, 1/125, 1/150, 1/200, 1/500, 1/1000, 1/2000, 1/4000, 1/8000
- 59.94P: 1/60, 1/90, 1/120, 1/150, 1/180, 1/210, 1/600, 1/1200, 1/2400, 1/4800, 1/9000
- 50i: 1/50, 1/75, 1/100, 1/125, 1/150, 1/200, 1/500, 1/1000, 1/2000, 1/4000, 1/8000
- 59.94i: 1/60, 1/90, 1/120, 1/150, 1/180, 1/210, 1/600, 1/1200, 1/2400, 1/4800, 1/9000

**Note:** In Auto Exposure mode, this option will be shown as Shutter Limit. In Manual Exposure mode, this option will be shown as Manual Shutter.

### 5.14 HDR (High Dynamic Range)

The BC-100 provides HDR function for users. For the scenarios that the difference between bright and dark is too huge, the camera will shoot many pictures at the same time with different exposure value. After that, the camera will composite those pictures to one single picture with proper bright and dark level without over-exposure and under-exposure.

#### How to Enter the HDR Option

Please follow following steps for entering the HDR option.

Step 1. Please press the HDR option from the main interface of the App.

Step 2. The HDR adjustment slider which is shown as following diagram will be shown for users to select their desired HDR value.

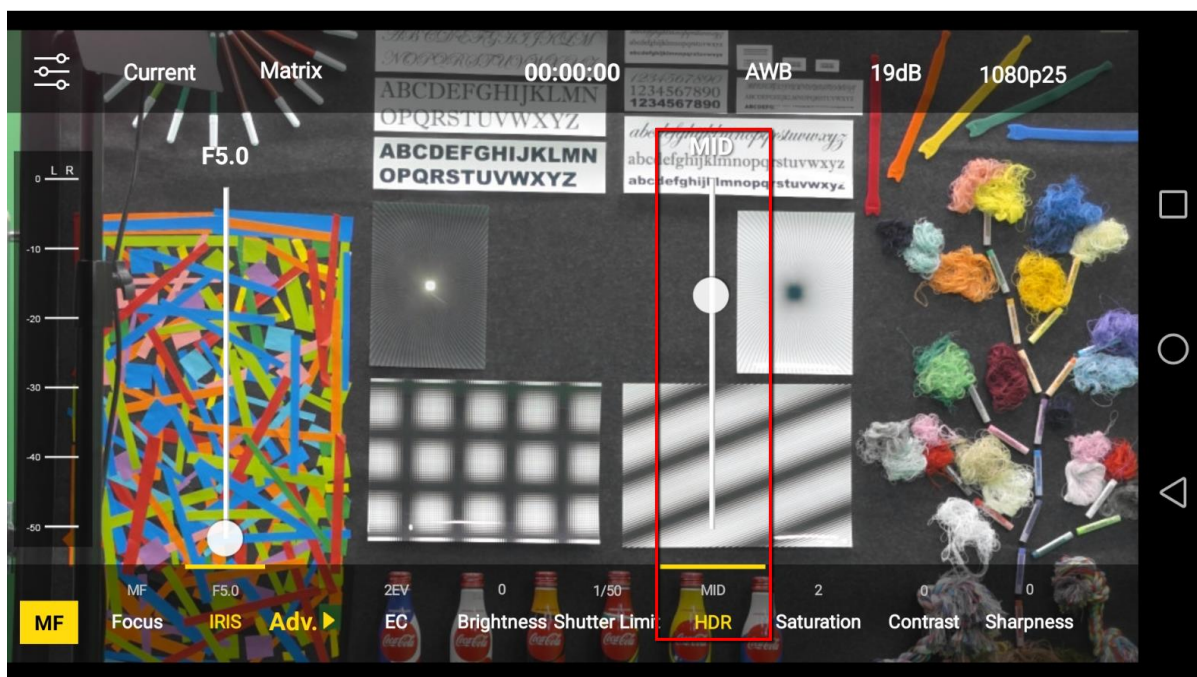

## 5.15 Saturation

The BC-100 provides Saturation adjustment function for users. The saturation is the strength of the color. If you want the color to be more intensive, users can increase the saturation. If the saturation is decreased, the color will be shown as the fading color. The saturation adjustment range of the BC-100 is from +8 to -8.

### How to Enter the Saturation Option

Please follow following steps for entering the Saturation option.

Step 1. Please press the Saturation option  on the main interface of the App.

Step 2. The Saturation option adjustment slider which is shown as following diagram will be shown for users to select their desired saturation value.

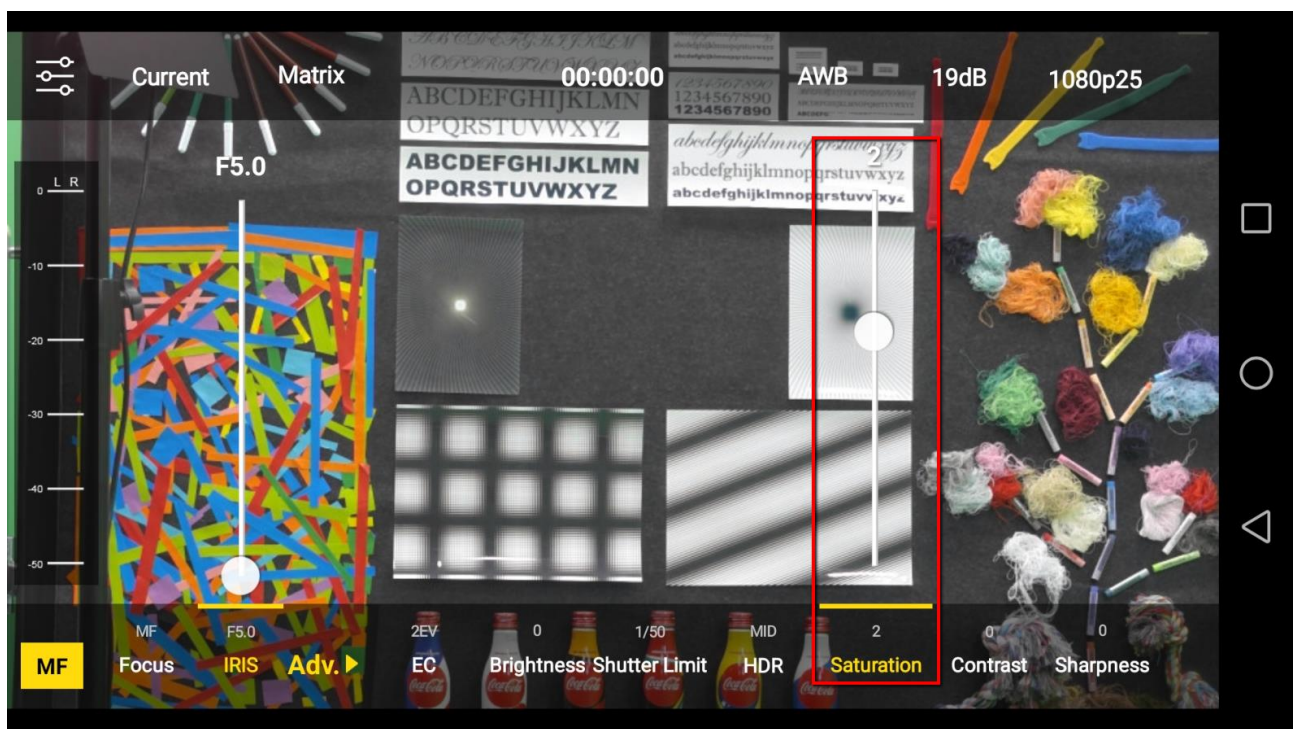

## 5.16 Contrast

The BC-100 provides the Contrast adjustment function for users. The Contrast is the different between light and dark. When a higher Contrast value is set by users, the light area will become brighter and the dark area will become darker for achieving a high clarity picture. If a low Contrast value is set, the difference between the light area and the dark area will be tiny and the clarity of the picture will be decreased. The Contrast adjustment range for the BC-100 is from **0 to +16**.

### How to Enter the Contrast Option

Please follow following steps for entering the Contrast option.

Step 1. Please press the Contrast option  from the main interface of the App.

Step 2. The Contrast adjustment slider which is shown as following diagram will be shown for users to select their desired Contrast value.

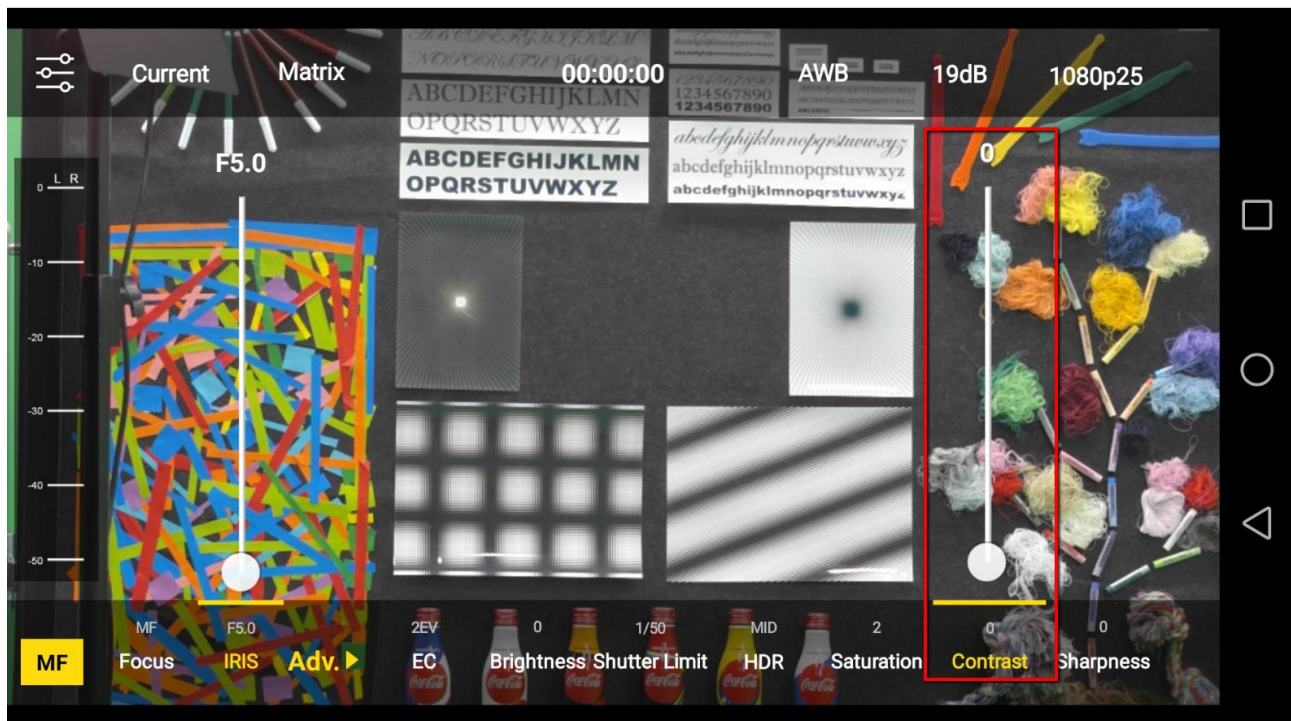

## 5.17 Sharpness

The BC-100 provides Sharpness adjustment function for users. Sharpness is used to find the profile of the object for sharpening the lines of the profile. Moreover, it can enhance the contrast for creating the feeling of sharpening. The Sharpness adjustment range for the BC-100 is from 0 to 7.

### How to Enter the Sharpness Option

Please follow following steps for entering the Sharpness option.

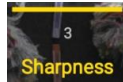

Step 1. Please press the Sharpness option **Sharpness** on the main interface of the App.

Step 2. The Sharpness adjustment slider which is shown as following diagram will be shown for users to select their desired Sharpness value.

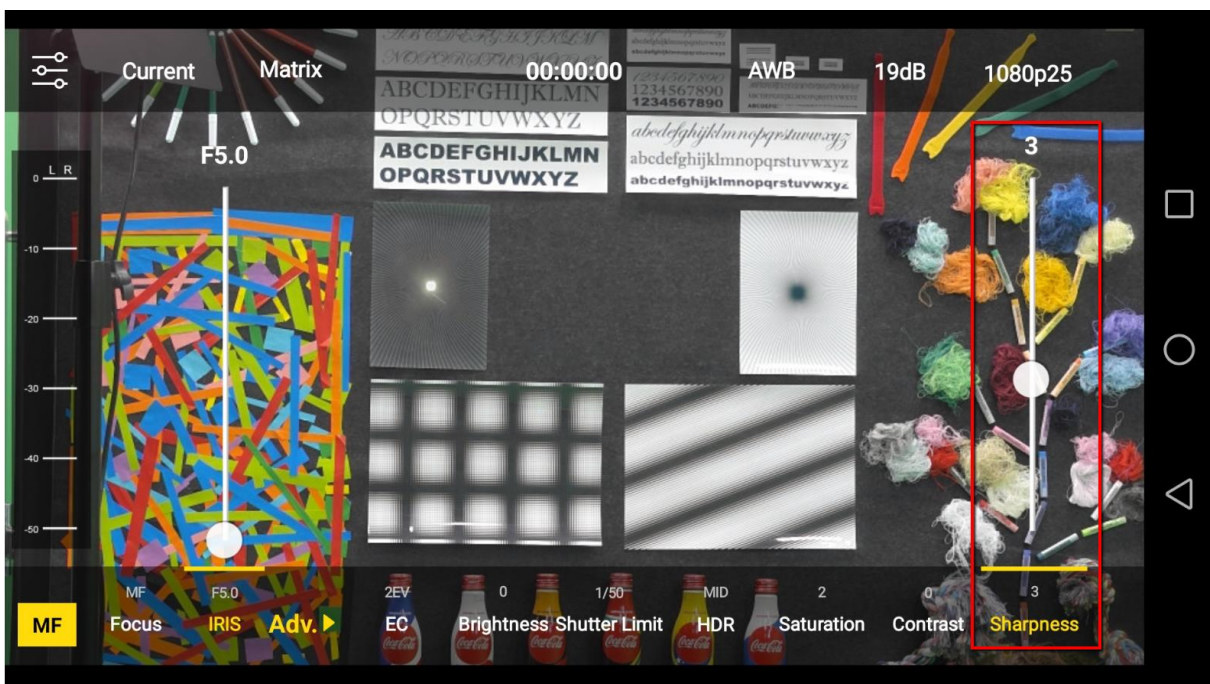

## Chapter 6. Firmware Update (Take Android Phone as an Example)

Users can use the BC-100 App to update the latest firmware for the BC-100 HD Interchangeable Lens camera.

Step 1. Before the firmware update procedure is started, please make sure that the BC-100 App is installed in your Android handset.

Step 2. Please turn on the power of the BC-100 camera.

Step 3. Please find the Wi-Fi hotspot “BC-100\_xxxx” from the Wi-Fi setting menu of your handset. Please press the Wi-Fi hotspot to connect your handset to the BC-100 camera.

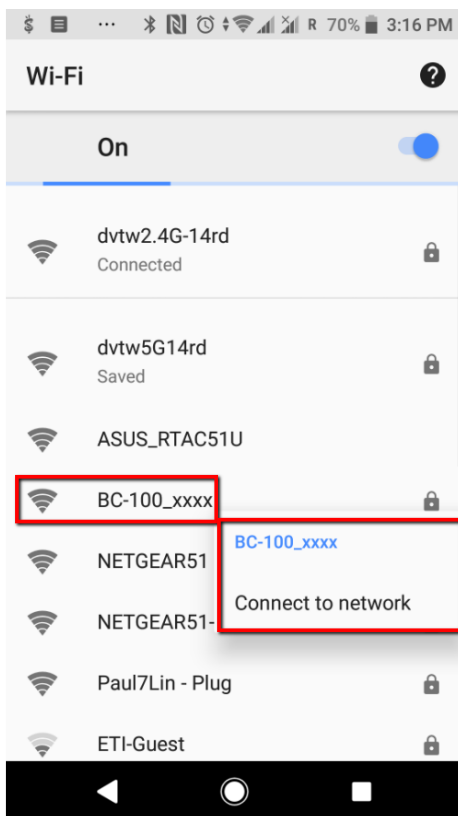

Step 4. After the handset is connected to the BC-100 successfully, please open the BC-100 App.

Step 5. And then users can enter into the main interface of the BC-100 App which is shown as following diagram.

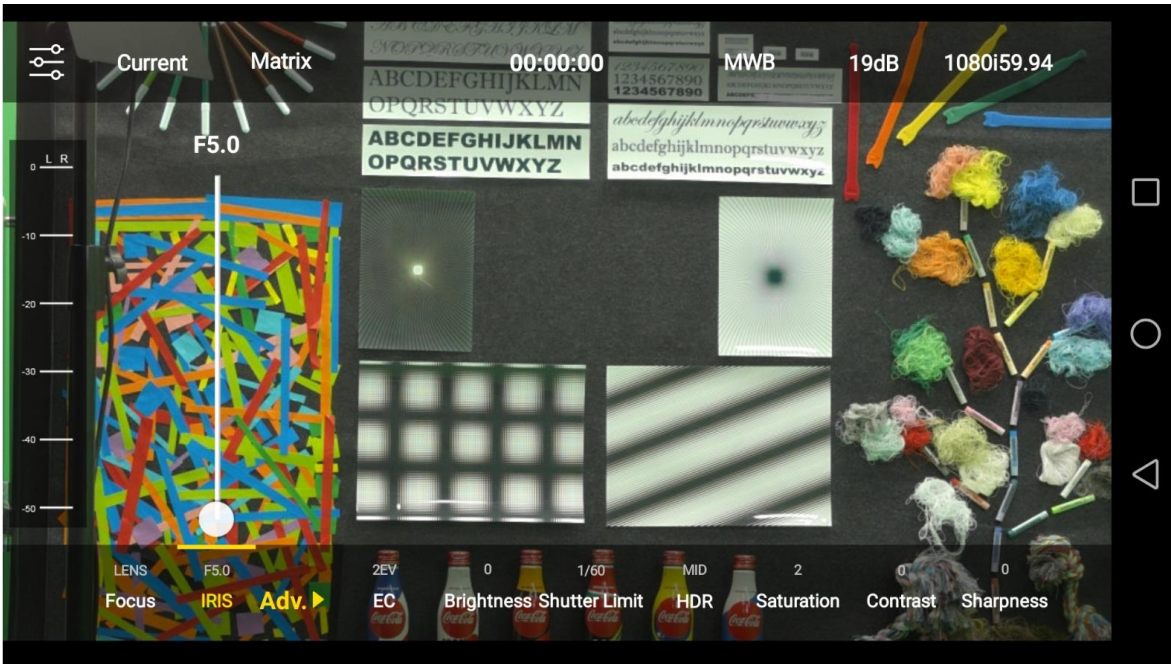

Step 6. Please press the setting icon  to enter the setting interface which is shown as following diagram.

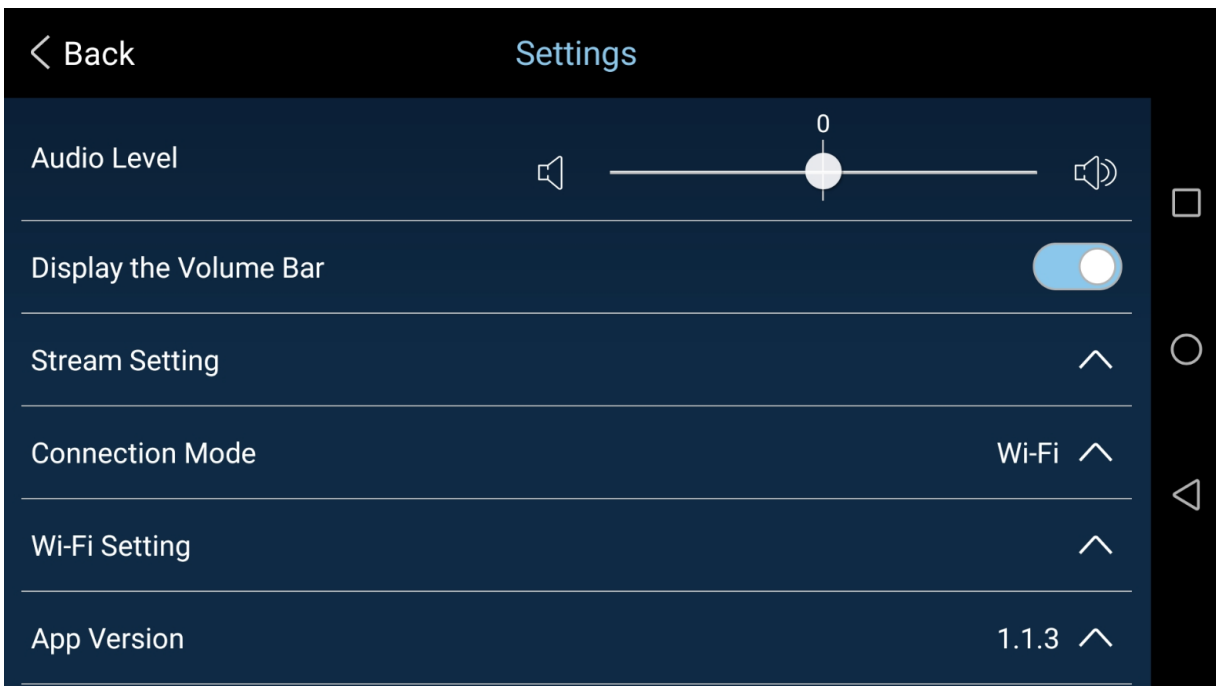



Step 7. Please press the App Version option and then the current firmware version will be shown.

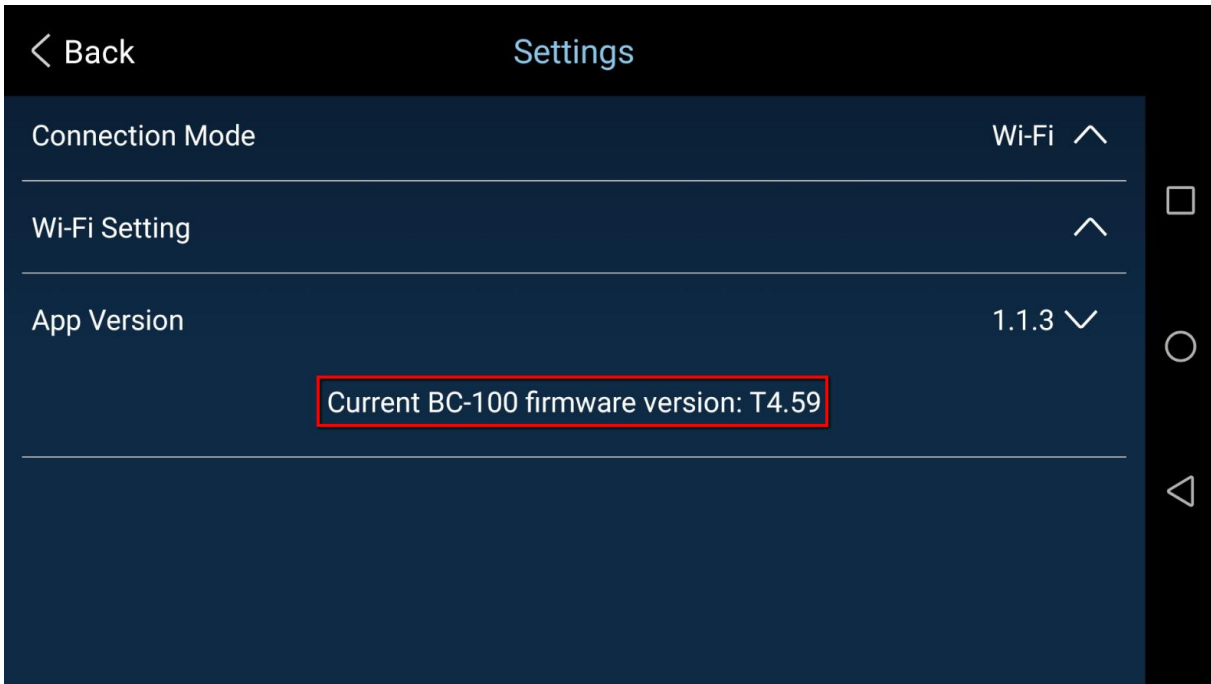

Step 8. Please press “**Current BC-100 firmware version**” for **7 times** and then the “**Latest Firmware Version**” reminder which is shown as following diagram will be shown. Please press the “**Update**” button to start the firmware update.

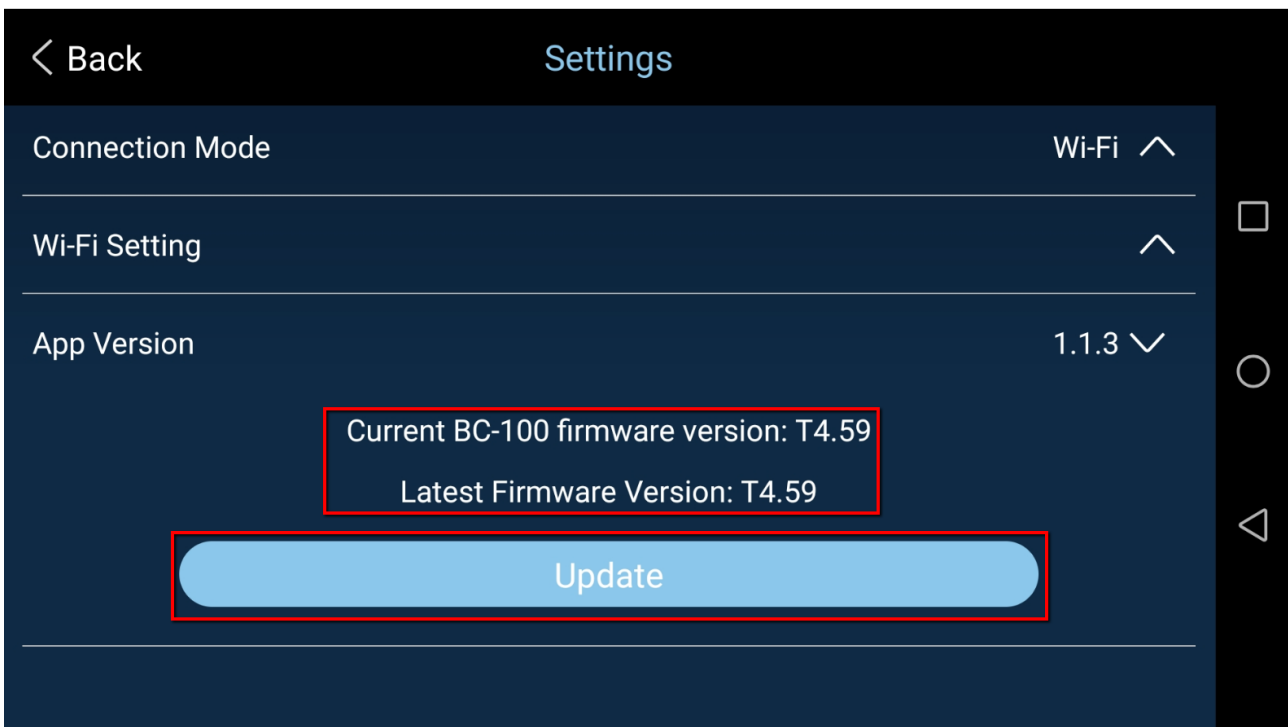

Step 9. Please press “**Update**” button and then the firmware update will be started and the progress bar which is shown as following diagram will be shown.

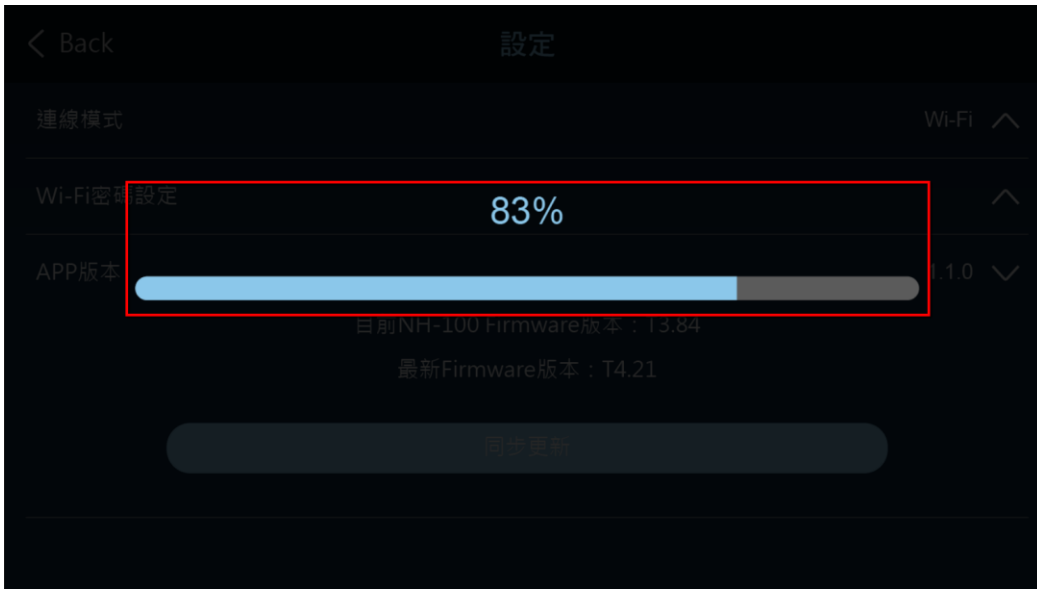

Step 10.

- When the firmware update is done successfully, the firmware update successful reminder window which is shown as following will be shown.

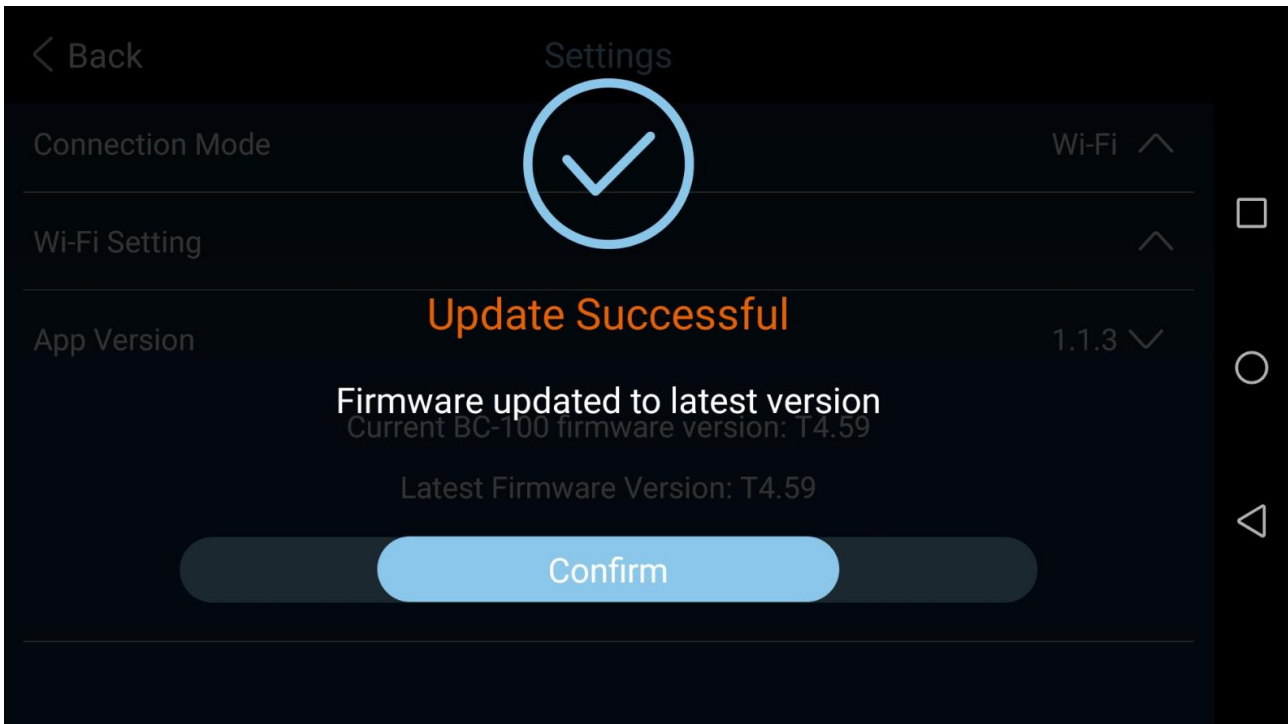

- If the firmware update is not done successfully or there is no network connection available, a reminder window will be shown to remind users to do the firmware update procedure again.

## **Chapter 7. Optional Accessories**

Datavideo provides LANC control button for users to be the optional accessory of the BC-100 Interchangeable Lens camera. The BC-100 can combine with the recorder/monitor/player devices such as the Atomos Ninja Blade for achieving the monitoring and recording purposes. The recording function can be realized by the remote control of the optional LANC remote control button. Moreover, for the optional LANC remote control button, please contact with your local dealers or the Datavideo office.

## Chapter 8. Dimensions

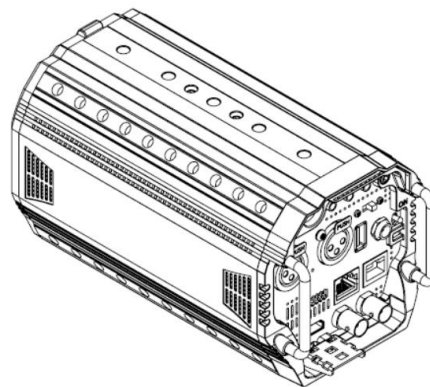
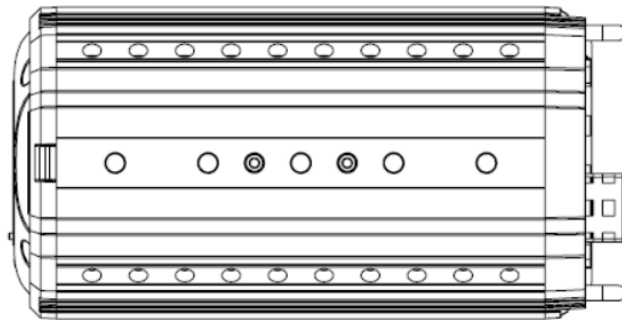
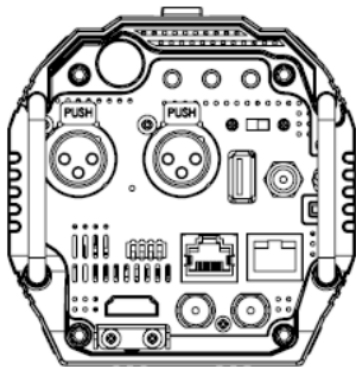
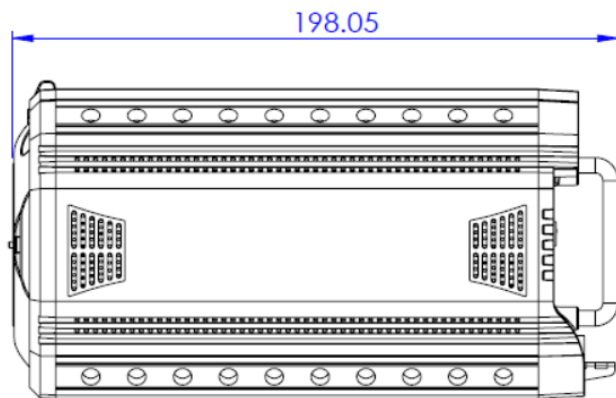
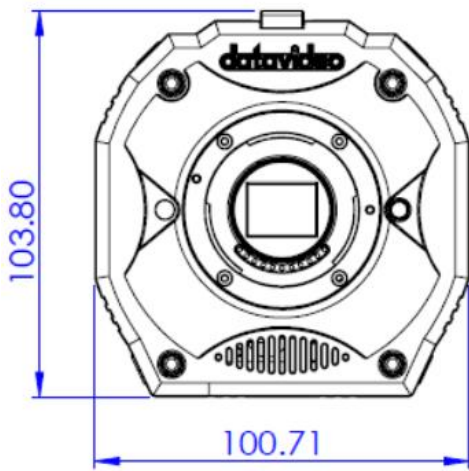
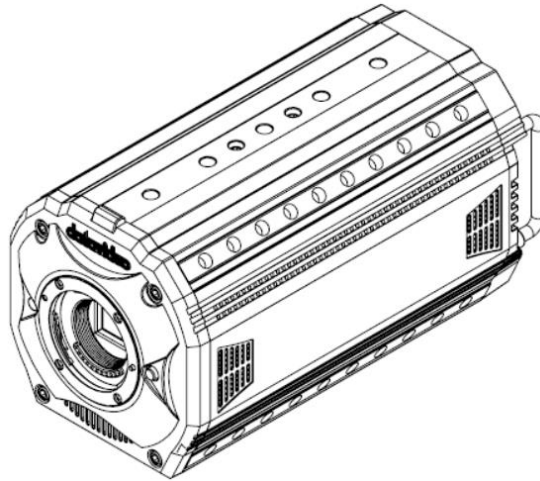

Unit: millimeters (mm)

## Chapter 9. Specification

<b>Model Name</b>	<b>BC-100</b>
<b>Product Name</b>	<b>Interchangeable Lens Camera</b>
<b>Video Format</b>	1080p 24/25/29.97/50/59.94 1080i 50/59.94
<b>Image Sensor</b>	4/3" CMOS Sensor
<b>Camera Lens Ring System</b>	Micro Four Third (M4/3)
<b>Image Processing Capability</b>	12 bit (24p/25p/29.97p) 10 bit (50p/59.94p/50i/59.94i)
<b>Effective Pixels</b>	About 20.89 Mega Pixel
<b>S/N Ratio</b>	60dB
<b>Min. Illumination</b>	0.1Lux
<b>Electronic Shutter</b>	1/25 (1/24, 1/30), 1/50 (1/48, 1/60), 1/75 (1/72, 1/90), 1/100 (1/96, 1/120), 1/125 (1/120, 1/150), 1/150 (1/144, 1/180), 1/200 (1/168, 1/210), 1/500 (1/480, 1/600), 1/1000 (1/960, 1/1200), 1/2000 (1/1920, 1/2400), 1/4000 (1/3840, 1/4800), 1/8000 (1/7200, 1/9000) Sec.
<b>Zoom Ratio</b>	The value is determined by the camera lens(the camera lens is not included when shipping)
<b>Gamma Control</b>	Dynamic Adjustment
<b>Exposure</b>	Auto/Lock/Manual
<b>IRIS Setting</b>	Manual
<b>Digital Noise Reductions</b>	3D Noise Reduction
<b>Dynamic Range Control</b>	High/Middle/Low/OFF
<b>Language</b>	Traditional Chinese/Simplified Chinese/English(Control by App)
<b>White Balance</b>	AWB/One Push WB/Lock/MWB
<b>AGC/ Gain Control</b>	Auto (AGC) / Manual Max. Gain Limit
<b>Mirror/Image Flip</b>	N/A
<b>Focus Mode</b>	Control by App (push-auto/manual), Control by Camera Lens
<b>Focal Length</b>	The value is determined by the camera lens(the camera lens is not included when shipping)
<b>Angle of View</b>	The value is determined by the camera lens(the camera lens is not included when shipping)
<b>Image Compensation</b>	Auto
<b>Image Output</b>	HDMI x 1 & SDI x 2
<b>Audio Input</b>	Supports dual XLR microphone input and can be embedded in Video for output
<b>Tally LED</b>	Dual Color, Red/Green
<b>Remote Control Interface and Transmitting Range</b>	RS-232: 12m RS-422: Transmit up to 1000m DVIP (RJ-45): 100m Wi-Fi: 5m USB(OTG): 0.5m
<b>Firmware Update</b>	Control by App(Wi-Fi)
<b>IR Control</b>	N/A

<b>Camera Control Device</b>	Android / iOS phone
<b>Tripod Screw Hole Size</b>	1/4-20 UNC
<b>RoHS</b>	Compliant
<b>Video Output</b>	
<b>Video Output</b>	HDMI x 1 & SDI x 2
<b>Control</b>	
<b>Communication Protocol</b>	VISCA Protocol/DVIP/RS-232/RS-422
<b>Remote Control</b>	Wi-Fi (Optional) & USB-OTG。RS-422/RS-232/DVIP through RJ-45 interface
<b>Firmware Update</b>	By BC-100 App
<b>Others</b>	
<b>Operating Temp.</b>	0°C ~ 40°C(32°F~104°F)
<b>Storage Temp.</b>	- 10°C ~ 60°C (14°F~140°F)
<b>Operating Humidity</b>	10 % to 80 % (non-condensing)
<b>Storage Humidity</b>	10 % to 80 % (non-condensing)
<b>Power</b>	DC 12V 2A
<b>Power Consumption</b>	20.88W
<b>Color</b>	Dark Blue
<b>Dimension (W x H x D)</b>	101 x 104 x 198(mm)
<b>Optional Accessories</b>	
<b>External Connected Recording Controller</b>	Supports LANC interface external connected recorder remote control button

*\* Micro Four Thirds and Micro Four Thirds Logo marks are trademarks or registered trademarks of Olympus Imaging Corp., in Japan, the United States, the European Union and other countries.*

*\*VISCA is the trademark of Sony Corporation.*

*\*Atomos is the trademark of the Atomos Global Pty. Ltd.*

*\*Blackmagic Design is the trademark of the Blackmagic Design Pty Ltd.*

*\* All trademarks are the property of their respective owners*

## Note

## Service & Support

It is our goal to make owning and using Datavideo products a satisfying experience. Our support staff is available to assist you to set up and operate your system. Contact your local office for specific support requests. Plus, please visit [www.datavideo.com](http://www.datavideo.com) to access our FAQ section.



Please visit our website for latest manual update.

<https://www.datavideo.com/product/BC-100>

**datavideo**  
[www.datavideo.com](http://www.datavideo.com)



@DatavideoUSA @DatavideoIndia2016  
@DatavideoEMEA @Datavideojapan  
@DatavideoTaiwan @DatavideoLatam  
@DatavideoAsia @DatavideoBrasil



@Datavideo  
@Datavideo\_EMEA  
@Datavideo\_Taiwan



@DatavideoUSA  
@DVTWDCN



@DatavideoUSA  
@DatavideoEurope

All the trademarks are the properties of their respective owners.  
Datavideo Technologies Co., Ltd. All rights reserved 2020

Jul.-12.2019  
Version E2