



# QLX-D

## Wireless System

Shure QLXD wireless system user guide. Includes dimensions, frequency bands, solutions to error codes, and more.  
Version: 4 (2019-L)

# Table of Contents

		Shure SB900 Rechargeable Battery	24
<b>QLX-D Wireless System</b>	<b>4</b>	Low Battery Alert	26
<b>IMPORTANT SAFETY INSTRUCTIONS</b>	<b>4</b>	<b>Receiver Gain Adjustment</b>	<b>26</b>
<b>WARNING</b>	<b>5</b>	Audio Signal Encryption	26
<b>Important Product Information</b>	<b>5</b>	<b>System Set Up</b>	<b>27</b>
LICENSING INFORMATION	5	Creating Audio Channels	28
Information to the user	6	Scan and IR Sync	28
Australia Warning for Wireless	6	Step 1: Scanning to Find the Best Channel	28
		Network Scan	28
<b>System Overview</b>	<b>6</b>	Step 2: IR Sync for Automatic Transmitter Set Up	29
Features	6	Manual Group and Channel Assignment	29
System Components	7	Manual Frequency Selection	30
		Linking Two Transmitters to a Receiver	30
<b>Quick Start</b>	<b>8</b>	<b>Radio Frequency (RF) Settings</b>	<b>31</b>
Step 1: Power and Antenna Connection	8	Setting the Transmitter RF Power	31
Step 2: Scanning for the Best Available Channel	9	Shure AXT600 Spectrum Manager Compatibility	32
Step 3: Install Batteries into Transmitter	10	Using QLX-D with a Shure ULX-D System	32
Step 4: IR Sync to Create an Audio Channel	10	Setting Regional TV Channel Spacing	32
Step 5: Sound Check and Gain Adjustment	11	Custom Groups	33
<b>Wearing the Bodypack Transmitter</b>	<b>11</b>	<b>Networking</b>	<b>34</b>
<b>Hardware Interface</b>	<b>11</b>	Connecting to a Network	34
Receiver Front and Back Panels	12	Automatic IP Addressing	34
Receiver Display	14	Configuration Tips	34
Navigating the Receiver Menus	15	Network Troubleshooting	35
Transmitters	17	Setting the IP Address and Subnet Mask Manually	35
Transmitter Display	19	<b>Connecting to an External Control System</b>	<b>36</b>
Transmitter Menu Options and Navigation	20	<b>Managing Your System with Shure Software</b>	<b>36</b>
Control Lock Options for the Receiver and Transmitter	21	<b>Firmware Updates</b>	<b>36</b>
<b>Battery Installation</b>	<b>22</b>	Firmware Versioning	37
Setting the AA Battery Type	23		
AA Battery Installation	24		

---

Downloading and Updating Firmware	37	Optional Accessories	43
Updating the Receiver	37		
Updating the Transmitter	37		
<b>Troubleshooting</b>	<b>38</b>	<b>Specifications</b>	<b>49</b>
Error Codes and Solutions	40	QLXD4	51
		QLXD1	52
		QLXD2	53
		Frequency Range and Transmitter Output Power	54
<b>Single and Dual Rackmount Assembly</b>	<b>40</b>	<b>Frequencies for European Countries</b>	<b>55</b>
Securing the AC Power Cord	41		
Installing Footpads	42	<b>Certifications</b>	<b>59</b>
Receiver Output Connectors	42	QLXD1, QLXD2, QLXD4	59
Transmitter Input	42	QLXD1, QLXD2	60
<b>Accessories</b>	<b>43</b>	QLXD4	60

---

# QLX-D Wireless System

---









## IMPORTANT SAFETY INSTRUCTIONS

1. READ these instructions.
2. KEEP these instructions.
3. HEED all warnings.
4. FOLLOW all instructions.
5. DO NOT use this apparatus near water.
6. CLEAN ONLY with dry cloth.
7. DO NOT block any ventilation openings. Allow sufficient distances for adequate ventilation and install in accordance with the manufacturer's instructions.
8. DO NOT install near any heat sources such as open flames, radiators, heat registers, stoves, or other apparatus (including amplifiers) that produce heat. Do not place any open flame sources on the product.
9. DO NOT defeat the safety purpose of the polarized or grounding type plug. A polarized plug has two blades with one wider than the other. A grounding type plug has two blades and a third grounding prong. The wider blade or the third prong are provided for your safety. If the provided plug does not fit into your outlet, consult an electrician for replacement of the obsolete outlet.
10. PROTECT the power cord from being walked on or pinched, particularly at plugs, convenience receptacles, and the point where they exit from the apparatus.
11. ONLY USE attachments/accessories specified by the manufacturer.
12. USE only with a cart, stand, tripod, bracket, or table specified by the manufacturer, or sold with the apparatus. When a cart is used, use caution when moving the cart/apparatus combination to avoid injury from tip-over.



13. UNPLUG this apparatus during lightning storms or when unused for long periods of time.
14. REFER all servicing to qualified service personnel. Servicing is required when the apparatus has been damaged in any way, such as power supply cord or plug is damaged, liquid has been spilled or objects have fallen into the apparatus, the apparatus has been exposed to rain or moisture, does not operate normally, or has been dropped.
15. DO NOT expose the apparatus to dripping and splashing. DO NOT put objects filled with liquids, such as vases, on the apparatus.
16. The MAINS plug or an appliance coupler shall remain readily operable.
17. The airborne noise of the Apparatus does not exceed 70dB (A).
18. Apparatus with CLASS I construction shall be connected to a MAINS socket outlet with a protective earthing connection.
19. To reduce the risk of fire or electric shock, do not expose this apparatus to rain or moisture.
20. Do not attempt to modify this product. Doing so could result in personal injury and/or product failure.
21. Operate this product within its specified operating temperature range.

### Explanation of Symbols

	Caution: risk of electric shock
	Caution: risk of danger (See note.)
	Direct current
	Alternating current
	On (Supply)
	Equipment protected throughout by DOUBLE INSULATION or REINFORCED INSULATION
	Stand-by
	Equipment should not be disposed of in the normal waste stream

**WARNING:** Voltages in this equipment are hazardous to life. No user-serviceable parts inside. Refer all servicing to qualified service personnel. The safety certifications do not apply when the operating voltage is changed from the factory setting.

**WARNING:** Danger of explosion if incorrect battery replaced. Operate only with AA batteries.

**Note:** Use only with the included power supply or a Shure-approved equivalent.

## WARNING

- Battery packs may explode or release toxic materials. Risk of fire or burns. Do not open, crush, modify, disassemble, heat above 140°F (60°C), or incinerate.
- Follow instructions from manufacturer
- Only use Shure charger to recharge Shure rechargeable batteries
- **WARNING:** Danger of explosion if battery incorrectly replaced. Replace only with same or equivalent type.
- Never put batteries in mouth. If swallowed, contact your physician or local poison control center
- Do not short circuit; may cause burns or catch fire
- Do not charge or use battery packs other than Shure rechargeable batteries
- Dispose of battery packs properly. Check with local vendor for proper disposal of used battery packs.
- Batteries (battery pack or batteries installed) shall not be exposed to excessive heat such as sunshine, fire or the like

## Important Product Information

### LICENSING INFORMATION

Licensing: A ministerial license to operate this equipment may be required in certain areas. Consult your national authority for possible requirements. Changes or modifications not expressly approved by Shure Incorporated could void your authority to operate the equipment. Licensing of Shure wireless microphone equipment is the user's responsibility, and licensability depends on the user's classification and application, and on the selected frequency. Shure strongly urges the user to contact the appropriate telecommunications authority concerning proper licensing, and before choosing and ordering frequencies.

## Information to the user

This device complies with part 15 of the FCC Rules. Operation is subject to the following two conditions:

1. This device may not cause harmful interference.
2. This device must accept any interference received, including interference that may cause undesired operation.

**Note:** This equipment has been tested and found to comply with the limits for a Class B digital device, pursuant to part 15 of the FCC Rules. These limits are designed to provide reasonable protection against harmful interference in a residential installation. This equipment generates uses and can radiate radio frequency energy and, if not installed and used in accordance with the instructions, may cause harmful interference to radio communications. However, there is no guarantee that interference will not occur in a particular installation. If this equipment does cause harmful interference to radio or television reception, which can be determined by turning the equipment off and on, the user is encouraged to try to correct the interference by one or more of the following measures:

- Reorient or relocate the receiving antenna.
- Increase the separation between the equipment and the receiver.
- Connect the equipment to an outlet on a circuit different from that to which the receiver is connected.
- Consult the dealer or an experienced radio/TV technician for help.

**Note:** EMC conformance testing is based on the use of supplied and recommended cable types. The use of other cable types may degrade EMC performance.

Please follow your regional recycling scheme for batteries, packaging, and electronic waste.

## Australia Warning for Wireless

This device operates under an ACMA class licence and must comply with all the conditions of that licence including operating frequencies. Before 31 December 2014, this device will comply if it is operated in the 520-820 MHz frequency band.

**WARNING:** After 31 December 2014, in order to comply, this device must not be operated in the 694-820 MHz band.

**Caution:** Avoid operating mobile phones and mobile broadband devices near your wireless system to prevent the possibility of interference.

## System Overview

QLX-D<sup>®</sup> Digital Wireless delivers defined, streamlined performance with transparent 24-bit digital audio. Combining professional features with simplified setup and operation, QLX-D offers outstanding wireless functionality for demanding live sound events and installations.

Shure digital wireless technology enables QLX-D to transmit clearly detailed audio with extended, virtually flat frequency response. Designed to be highly RF spectrum efficient, QLX-D can operate more than 60 compatible channels simultaneously in a single frequency band. Automatic channel scan and IR sync make finding and assigning an open frequency quick and easy. Ethernet connection provides networked channel scanning across multiple receivers and Shure Wireless Workbench<sup>®</sup> control software compatibility for advanced frequency coordination. AES-256 encryption comes standard and can be easily enabled for secure wireless transmission.

QLX-D also adds Shure rechargeable power options to provide dramatic long-term cost savings and extended transmitter battery life over alkaline batteries, and battery metering that reports remaining runtime in hours and minutes. With clearly defined performance and innovation, QLX-D delivers the very latest in digital wireless technology from Shure.

## Features

- Transparent 24-bit digital audio
- Extended 20 Hz to 20 kHz frequency range (microphone dependent)

- 120 dB dynamic range
- Digital predictive switching diversity
- 64 MHz tuning bandwidth (region dependent)
- More than 60 available channels per frequency band (region dependent)
- Up to 17 compatible systems per 6MHz TV band; 22 systems per 8 MHz band
- Easy pairing of transmitters and receivers over IR scan and sync
- Automatic channel scan
- Ethernet networking for multiple receiver systems
- Network channel scanning configures open frequencies for networked receivers
- Compatible with Shure Wireless Workbench 6 control software
- Remote control from a mobile device or tablet via ShurePlus™ Channels app
- AES-256 encryption for secure wireless transmission
- Elegant and easy-to-use interface with high-contrast LCD menu
- Compatible with external control systems such as AMX or Crestron
- Professional-grade all-metal construction
- Transmitters use 2 AA batteries or Shure SB900 rechargeable battery

## System Components

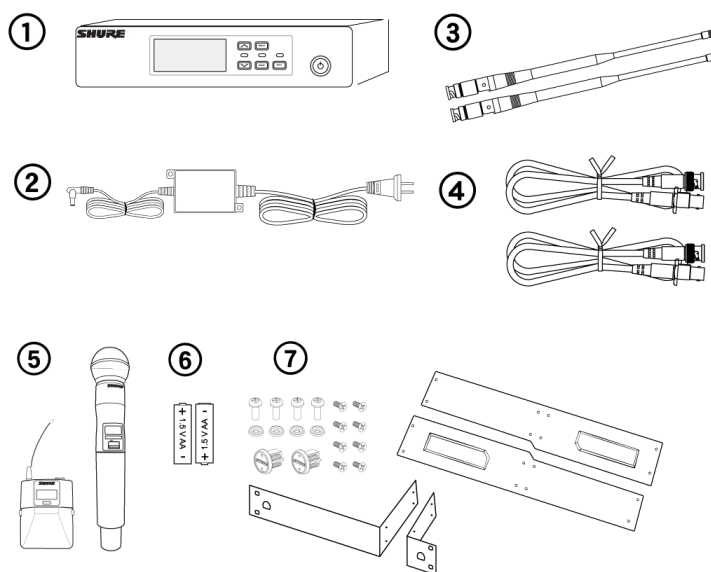

- ① QLXD4 Receiver
- ② PS24 Power Supply
- ③ 1/2 Wave Antennas (2)
- ④ 2 ft. BNC Cables with Bulkhead Adapters (2)
- ⑤ Choice of QLXD1 Bodypack Transmitter or QLXD2 Handheld Transmitter
- ⑥ AA Alkaline Batteries (not included in Argentina)
- ⑦ Rackmount Hardware

## Model Variations

Model variations with additional components are available to meet specific performance situations.

---

## QLXD2 Handheld Transmitter

Includes QLXD2 Handheld, available with any of the following microphone cartridges:

- SM58
- Beta 58A
- SM86
- Beta 87A
- SM87A
- Beta 87C
- KSM9
- KSM9HS (black)

Microphone Clip

Battery Contact Cover

Zipper Bag

## QLXD1 Bodypack Guitar System

Includes QLXD1 bodypack transmitter

WA305 Premium instrument cable

Zipper Bag

## QLXD1 Bodypack Headworn or Lavalier

Includes QLXD1 bodypack, available with any of the following microphone cartridges:

- Beta 98H/C
- WL93
- WL183
- WL184
- WL185
- MX150 (omni)
- MX150 (cardioid)
- MX153 (black or tan)
- SM35

Zipper Bag

## Bodypack and Handheld Combo System

- QLXD1 bodypack transmitter with WL185 Microflex cardioid lavalier microphone
- QLXD2 handheld transmitter with Shure SM58 microphone cartridge
- Battery Contact Cover
- Zipper Bag (2)

---

## Quick Start

### Step 1: Power and Antenna Connection

① Connect an antenna to each of the antenna connectors.



- ② Connect the power supply to the receiver and plug into an AC power source.
- ③ Connect the receiver audio output to a mixer or amplifier.
- ④ Press and hold the power button to turn on the receiver.

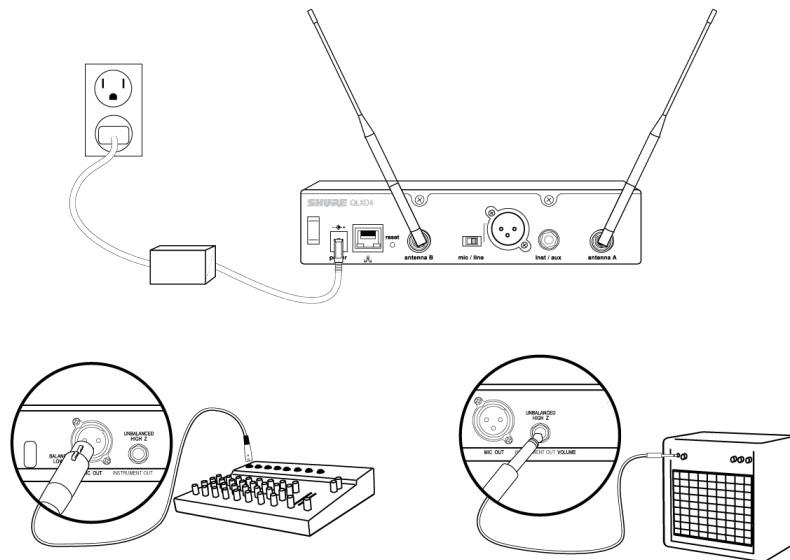

## Step 2: Scanning for the Best Available Channel

1. Press the *menu* button on the receiver to access the scan function.

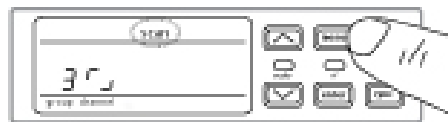

2. Press the *enter* button to start a frequency scan. The scan icon will flash while in scan mode. When the scan is complete, the selected group and channel appear on the display.



## Step 3: Install Batteries into Transmitter

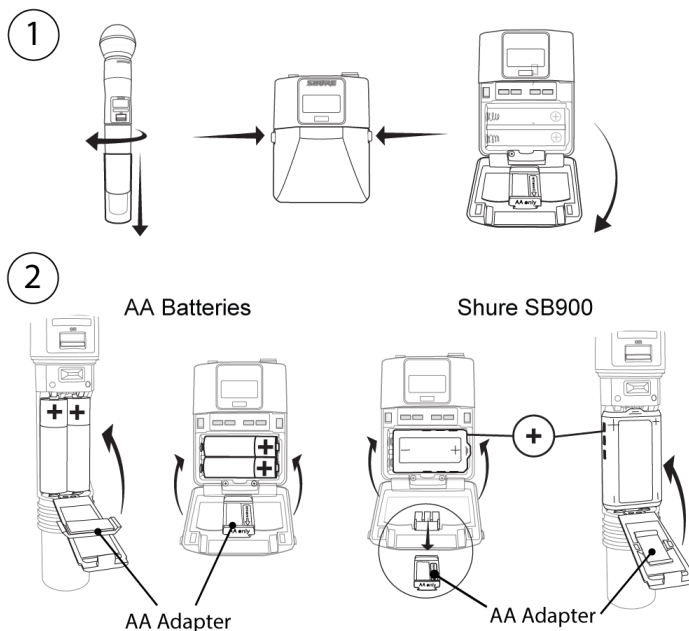

### ① Accessing the Battery Compartment

Press the side tabs on the bodypack or unscrew the cover on the handheld as shown to access the battery compartment.

### ② Installing Batteries

- **AA Batteries:** Place batteries (note polarity markings) and AA Adaptor as shown
- **Shure SB900 Battery:** Place battery as shown (note polarity markings), remove AA Adaptor from bodypack transmitter, stow AA Adaptor in door for handheld transmitter

*Note: If using AA batteries, select a battery type from the transmitter menu to ensure accurate battery metering.*

## Step 4: IR Sync to Create an Audio Channel

1. Turn on the transmitter.
2. Press the *sync* button on the receiver. The red *ir* LED will blink indicating that sync mode is active.
3. Align the IR sync windows of the transmitter and receiver at a distance of <math>< 15\text{ cm (6 in.)}</math>. When the transmitter and receiver are aligned, the red *ir* LED remains on and the sync will automatically occur.



4. *sync good* appears on the display when IR sync is complete. The blue *rf* LED will illuminate indicating that the transmitter is within range of the receiver.

**Note:** If the IR sync fails, repeat the IR sync procedure, carefully maintaining alignment between the IR windows of the transmitter and receiver.

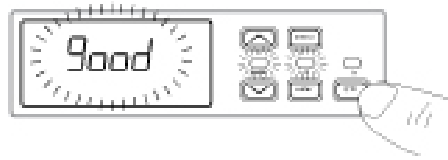

## Step 5: Sound Check and Gain Adjustment

1. Test the transmitter at performance levels while monitoring the *audio* meter and the *audio* LED. The *audio* meter should display at least 3 bars and the *audio* LED should be green. Reduce the gain if there is audible distortion of the audio.
2. Increase or decrease the gain if necessary by pressing the arrow buttons on the receiver front panel.

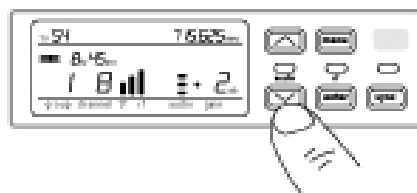

## Wearing the Bodypack Transmitter

Clip the transmitter to a belt or slide a guitar strap through the transmitter clip as shown.

For best results, the belt should be pressed against the base of the clip.

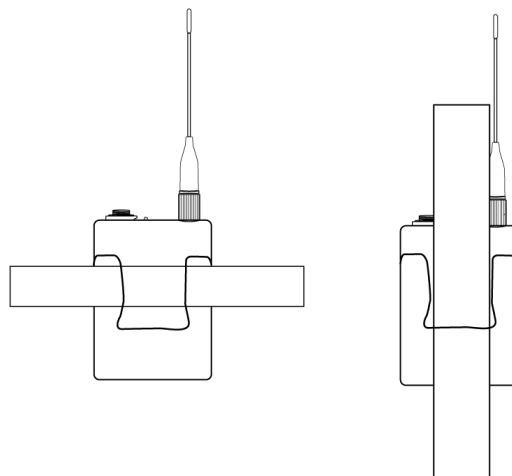

# Hardware Interface

## Receiver Front and Back Panels

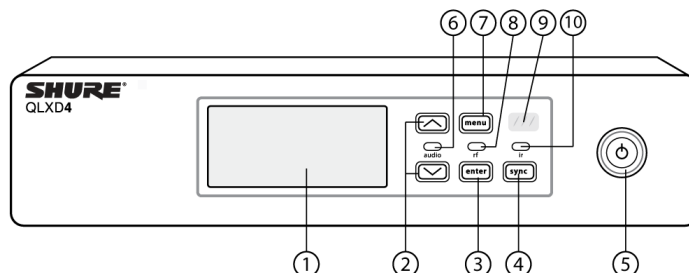

### ① Display

Shows menu options, receiver and transmitter settings.

### ② Arrow Buttons

Adjust gain setting or change menu parameters.

### ③ Enter Button

Press to save menu or parameter changes.

### ④ Sync Button

Press to activate IR sync.

### ⑤ Power Switch

Powers receiver on or off.

### ⑥ Audio LED

- Green = normal
- Yellow = signal approaching limiter threshold
- Red = limiter engaged to prevent clipping

### ⑦ Menu Button

- Press to access or select menu screens
- Press to cancel pending changes
- Press and hold to return to the home screen

### ⑧ RF LED

Illuminates when RF link with transmitter is active.

### ⑨ IR Window

Align with the transmitter IR window during an IR sync to automatically program transmitters.

## ⑩ Sync LED

- Blinking: IR sync mode is enabled
- On: Receiver and transmitter aligned for IR sync

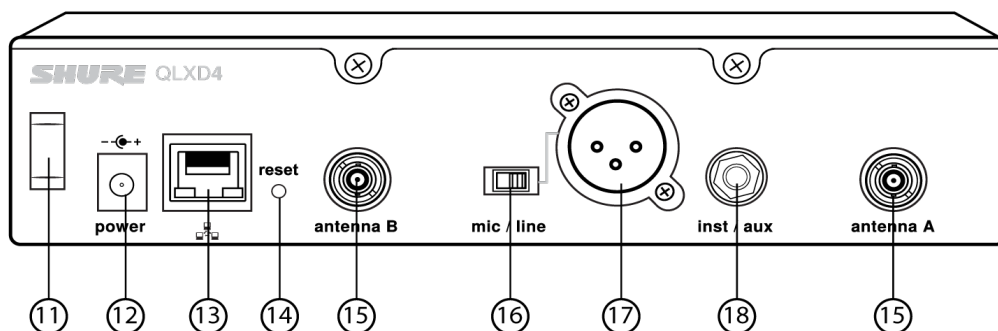

## ⑪ Power Cord Strain Relief

Secures power cord.

## ⑫ Power Supply Jack

Connection point for DC power supply.

## ⑬ Ethernet Port

For network connection.

- Amber LED (network speed):  
off = 10 Mbps, on = 100 Mbps
- Green LED (network status):  
off = no network link, on = network link active  
flashing = rate corresponds to traffic volume

## ⑭ Receiver Reset

Press to restore receiver default settings.

## ⑮ Antenna Connectors

BNC connector for receiver antennas

## ⑯ Mic/Line Switch

Sets output level to microphone or line.

## ⑰ XLR Audio Output

Balanced (1: ground, 2: audio +, 3: audio -)

## ⑩ 1/4" Instrument/Auxiliary Output

Impedance Balanced (Tip: audio, Ring: no audio, Sleeve: ground)

## Receiver Display

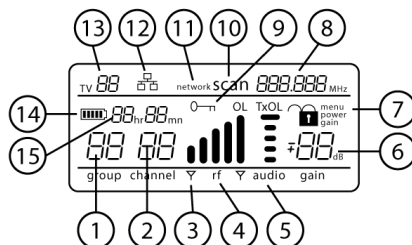

### ① Group

Displays group setting.

### ② Channel

Displays channel setting.

### ③ Active Antenna Indicator

Illuminates to indicate which antenna is active.

### ④ RF Signal Meter

Number of bars displayed corresponds to RF signal level - *OL* = overload.

### ⑤ Audio Meter

Number of bars displayed corresponds to audio level.

- *OL* = Illuminates when receiver audio limiter is active to prevent clipping
- *TxOL* = Illuminates when transmitter input is overloaded. Reduce input from microphone or instrument to prevent clipping.

### ⑥ Gain Level

Displays receiver gain setting in 1 dB increments.

### ⑦ Receiver Lock Status

Lock icon and name of locked control:

- *menu*
- *power*
- *gain*

### ⑧ Frequency Setting

Selected frequency (MHz).

### ⑨ Encryption Status

Illuminates when encryption is enabled.

## ⑩ Scan

Displayed when *scan* function is active.

## ⑪ Network Scan

Displayed when *network scan* function is active in multi-receiver systems.

## ⑫ Network Connection Indicator

Illuminates when additional Shure components are detected on the network.

## ⑬ TV Channel

Displays the number of the TV channel containing the selected frequency.

## ⑭ Transmitter Battery Icon

Indicates remaining battery life.

Enable the Low Battery Alert to flash the receiver display when battery runtime is less than 30 minutes.

## ⑮ SB900 Battery Runtime

When the transmitter is powered by a Shure SB900 rechargeable battery, remaining runtime is displayed in hours:minutes.

# Navigating the Receiver Menus

The receiver has a main menu for setup and configuration and an advanced menu to access additional receiver functions.

## Main Menu

Press the *menu* button to access the menu. Each additional press of the *menu* button advances to the next menu screen in the following order:

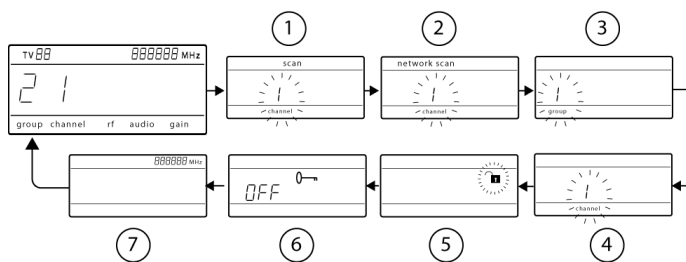

## ① Scan

Receiver automatically scans for the best available frequency

## ② Network Scan

Scans to find frequencies for networked receivers operating in the same frequency band (available when connected to a network with receivers in the same band)

## ③ Group

Edit the receiver group settings

#### ④ Channel

Edit the receiver channel settings

#### ⑤ Lock

Choose a control lock option

#### ⑥ Encryption

Use the arrow buttons to enable encryption (*on*) or disable encryption (*off*)

#### ⑦ Frequency

Use the arrow buttons to edit the frequency value

## Advanced Menu

Starting from the main menu home screen, press *menu* while holding the *enter* button to access the advanced menu. Each additional press of the *menu* button advances to the next menu screen in the following order.

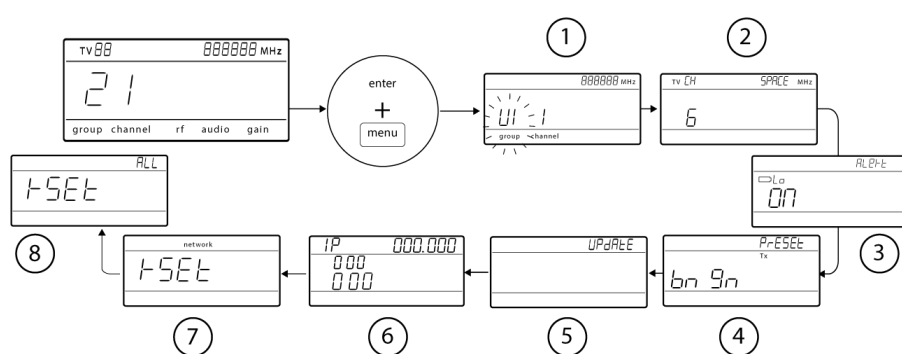

#### ① Custom Groups

Use to add channels and frequencies to Custom Groups

#### ② TV Channel Spacing

Selects the regional bandwidth for TV channel display

#### ③ Low Battery Alert

Enable or disable the low battery alert on the receiver screen

#### ④ Boundary/Gooseneck Transmitter Presets

Sends ULXD6/ULXD8 presets configured in WWB to transmitters via the IR Sync window

#### ⑤ Firmware Update

Displays what kind transmitter firmware the receiver has available. See Firmware Updates for more details.

- *HH BP* = handheld or bodypack firmware
- *BN GN* = boundary or gooseneck firmware



## ⑥ IP Settings

Use to select and edit IP settings and subnet masks

## ⑦ Network Reset

Returns network settings and IP address to default setting

## ⑧ Factory Reset

Restores factory settings

For application and configuration details, see the related guide topic for each advanced feature.

## Tips for Editing Menu Parameters

- To increase, decrease or change a parameter, use the arrow buttons
- A menu setting will blink when editing is enabled
- To save a menu change, press *enter*
- To exit a menu without saving a change, press *menu*
- To access the advanced menu, press *menu* while holding the *enter* button from the home screen
- To return to the home screen from any menu without saving changes, press and hold the *menu* button.

## Transmitters

### ① Power LED

- Green = unit is powered on
- Red = low battery

### ② On/Off Switch

Powers the transmitter on or off.

### ③ Display:

View menu screens and settings. Press any control button to activate the backlight.

### ④ IR window

Align with the receiver IR window during an IR sync for automated transmitter programming.

### ⑤ Menu Navigation Buttons

*menu* = Use to navigate between menu screens.

▼ ▲ = Use to select menu screens, edit menu parameters, or choose a home screen display option.

*enter* = Press to confirm and save parameter changes.

**Tip:** Press the *menu* button to exit without saving parameter changes.

### ⑥ Battery Compartment

Requires 2 AA batteries or a Shure SB900 rechargeable battery.

### ⑦ AA Battery Adapter

Secures batteries when powering transmitter with AA batteries instead of Shure SB900 battery.

### ⑧ Bodypack Antenna

For RF signal transmission.

### ⑨ Handheld Integrated Antenna

For RF signal transmission.

### ⑩ Microphone Cartridge

See Optional Accessories for a list of compatible cartridges.

### ⑪ TA4M Input Jack

Connects to a 4-Pin Mini Connector (TA4F) microphone or instrument cable.

### ⑫ Battery Contact Cover

Align the cover as shown to prevent reflections from the battery contacts during broadcasts or performances.

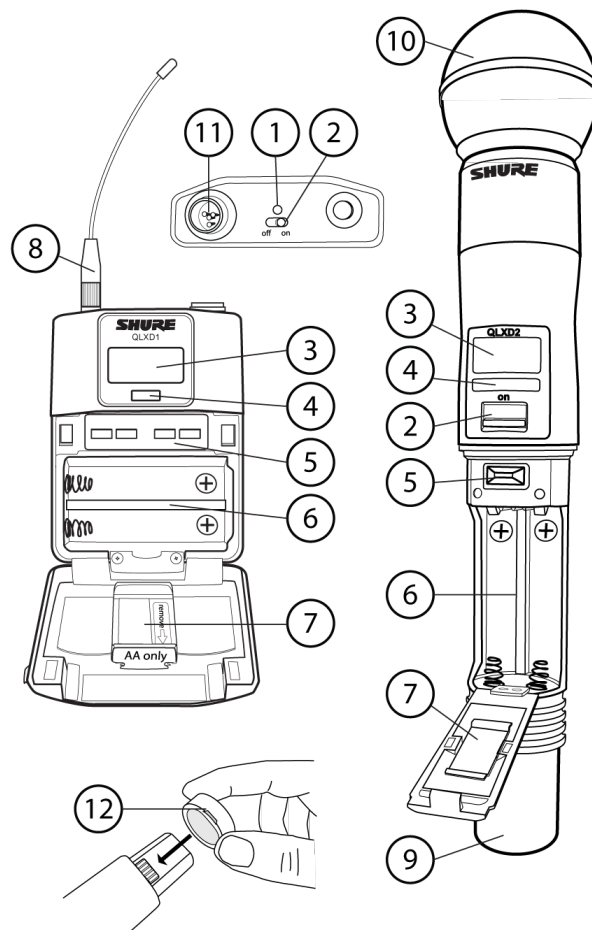



# Transmitter Display

## ① Battery Indicator

Bars displayed indicate remaining battery life.

## ② Home Screen Display: Group and Channel/Frequency/SB900 Battery Runtime

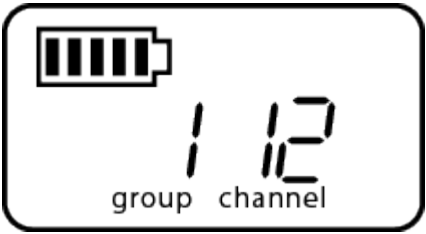
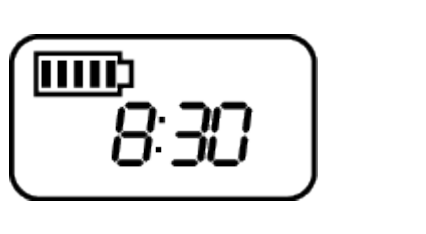
Use the arrow keys to select one of the following home screen displays:

Group and Channel	SB900 battery runtime	Frequency
		

## ③ Encryption Status

Icon displayed when encryption is enabled.

## ④ Lock

Displayed when transmitter controls are locked.

## ⑤ RF Power

RF power setting (*Lo* or *Hi*).

## ⑥ Mic Offset

Displays *mic offset* level in 3 dB increments.

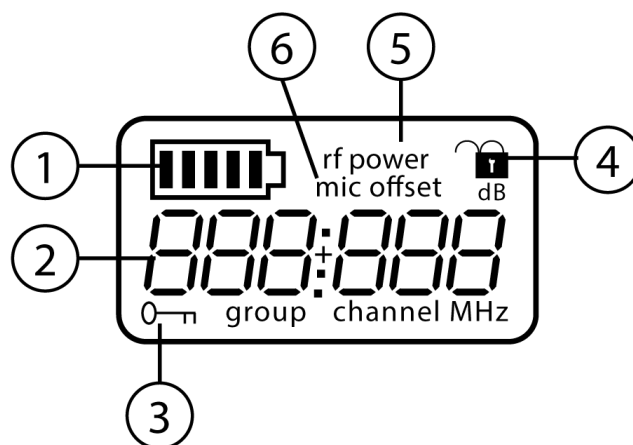

## Transmitter controls

- To increase, decrease or change a parameter, use the ▼ ▲ buttons
- To save a menu change, press *enter*
- To exit a menu without saving a change, press the *menu* button

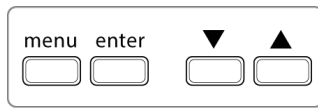

**Bodypack**

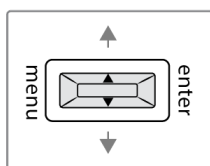

**Handheld**

## Transmitter Menu Options and Navigation

The transmitter features individual menu screens for setting up and adjusting the transmitter. To access the menu options from the home screen, press the *menu* button. Each additional press of the *menu* button advances to the next menu screen.

### ① Home Screen

Use the arrow keys to select one of the following home screen displays:

- Battery Icon/group and channel
- Battery Icon/frequency
- Battery Icon/Battery Runtime (SB900 installed)

### ② group

Use the arrow buttons to scroll through the groups.

### ③ channel

Use the arrow buttons to scroll through the channels.

### ④ frequency

Use the arrow buttons to adjust the frequency. Press and hold for faster scrolling.

### ⑤ lock

Select a lock option:

- *On* = controls locked
- *OFF* = controls unlocked

## ⑥ rf power

Select an rf power setting:

- Lo = 1 mW
- Hi = 10 mW

## ⑦ mic offset dB

Use to match audio levels between two transmitters used in a combo system. Range is 0 to 21 dB (3 dB increments). Adjustments occur in realtime.

## ⑧ battery type

Use to set the battery type to match the installed AA battery type to ensure accurate battery metering. Menu is not displayed when Shure SB900 batteries are installed.

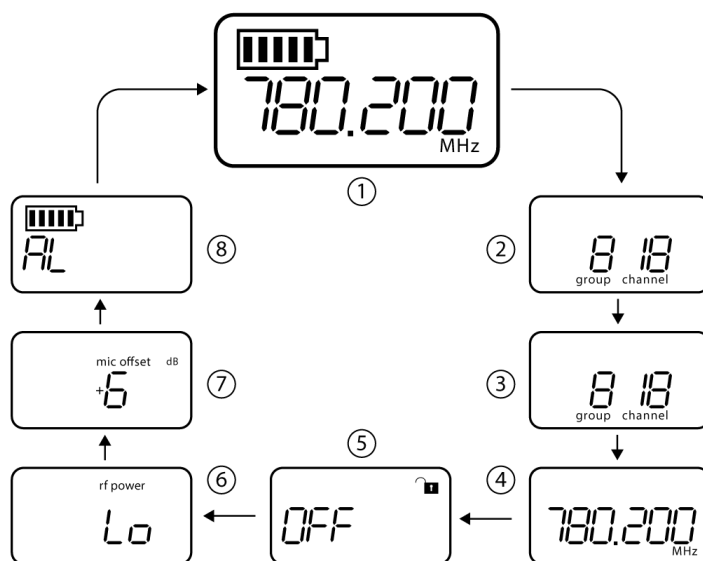

## Tips for Editing Menu Parameters

- To access the menu options from the home screen, press the *menu* button. Each additional press of the *menu* button advances to the next menu screen.
- A menu parameter will blink when editing is enabled
- To increase, decrease or change a parameter, use the arrow buttons
- To save a menu change, press *enter*
- To exit a menu without saving a change, press *menu*

## Control Lock Options for the Receiver and Transmitter

Control lock options are available for both the receiver and the transmitter to protect against accidental or unauthorized changes. Locks can be directly set from the component menu, or remotely set from WWB6. To maintain protection, controls remain locked when the transmitter is turned off and turned on.

## Locking and Unlocking the Receiver Controls

The receiver has the following control lock options which can be used separately or in any combination:

- *gain*: locks the arrow buttons to prevent changes to the audio gain settings
- *menu*: prevents access to menu items and IR sync (gain controls and power switch remain active)
- *power*: disables power switch (gain and menu controls remain active)

### To lock a receiver control:

1. Press the *menu* button to navigate to the lock settings.
2. Use the arrow buttons to add or remove the lock options shown next to the lock icon.
3. Press *enter* to save the lock settings.



### To unlock a receiver:

**Tip:** To unlock the menu and clear all locks, press and hold the *menu* button while in the home screen until the unlock icon appears. Press *enter* to confirm and save change.

1. To unlock *gain* or *power* settings, navigate to the lock settings by pressing the *menu* button.
2. Press the arrow buttons to de-select a lock option.
3. Press *enter* to confirm and save change.

## Locking and Unlocking Transmitter Controls

The transmitter controls can be locked or unlocked by selecting *On* (locked) or *OFF* (unlocked) from the transmitter lock menu.

If an attempt is made to access a locked control, the lock icon will flash, indicating that the transmitter controls are locked.

### To set a transmitter lock:

1. Press the *menu* button to navigate to the lock settings.
2. Use the arrow buttons to select *on*.
3. Press *enter* to save. The lock icon appears on the display to confirm that the control locks are enabled.

### To unlock the transmitter:

1. Press and hold the *menu* button until *OFF* and the unlock icon appear on the display.
2. Press *enter* to save changes.



# Battery Installation

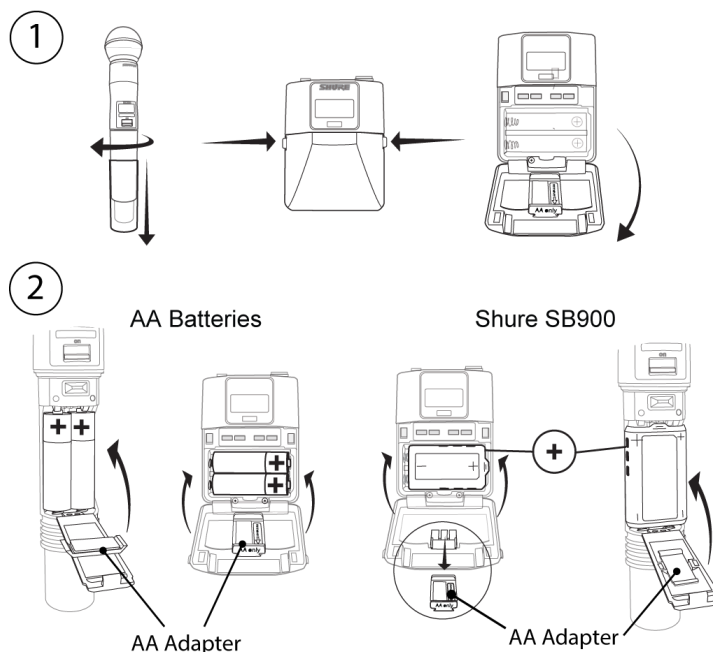

## ① Accessing the Battery Compartment

Press the side tabs on the bodypack or unscrew the cover on the handheld as shown to access the battery compartment.

## ② Installing Batteries

- **AA Batteries:** Place batteries (note polarity markings) and AA Adaptor as shown
- **Shure SB900 Battery:** Place battery as shown (note polarity markings), remove AA Adaptor from bodypack transmitter, stow AA Adaptor in door for handheld transmitter

*Note:* If using AA batteries, set the battery type using the transmitter menu.

## Setting the AA Battery Type

To ensure accurate display of transmitter runtime, set the battery type in the transmitter menu to match the installed AA battery type. If a Shure SB900 rechargeable battery is installed, selecting a battery type is not necessary and the battery type menu will not be displayed.

1. Press the *menu* button to navigate to the battery icon.
2. Use the ▼ ▲ buttons to select the installed battery type:
  - *AL* = Alkaline
  - *nH* = Nickel Metal Hydride
  - *Li* = Lithium Primary
3. Press *enter* to save.

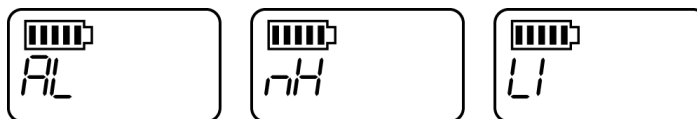

## AA Battery Installation

Fully insert the batteries as shown to ensure proper battery contact and to allow the door to latch securely.

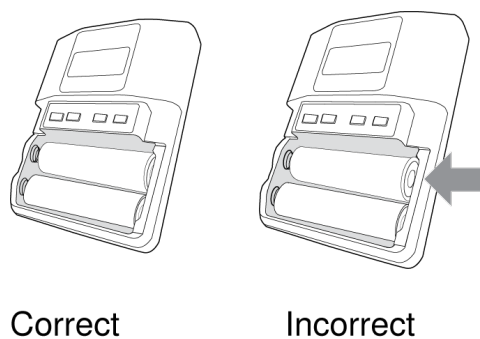

Correct

Incorrect

## Shure SB900 Rechargeable Battery

Shure SB900 lithium-ion batteries offer a rechargeable option for powering the QLX-D transmitters. Batteries quickly charge to 50% capacity in one hour and reach full charge within three hours.

Single chargers and multiple bay chargers are available to recharge the Shure batteries.

**Caution:** Only charge Shure rechargeable batteries with a Shure battery charger.

### Single Bay Charger

The single bay charger offers a compact charging solution.

1. Plug the charger into an AC power source or USB port.
2. Insert a battery into the charging bay.
3. Monitor the charging status LEDs until charging is complete.

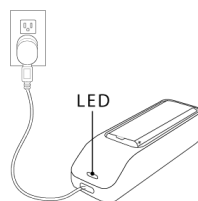

### Charging Status LED

Color	Status
Red	Charging



Color	Status
Green	Charging Complete
Amber Flashing	Fault: check connections and battery
Off	No battery in bay

## Multiple Bay Chargers

Shure offers two models of multiple bay chargers:

- SBC-200 two bay charger
- SBC-800 eight bay charger

Multiple bay chargers can charge individual batteries or batteries installed in transmitters.

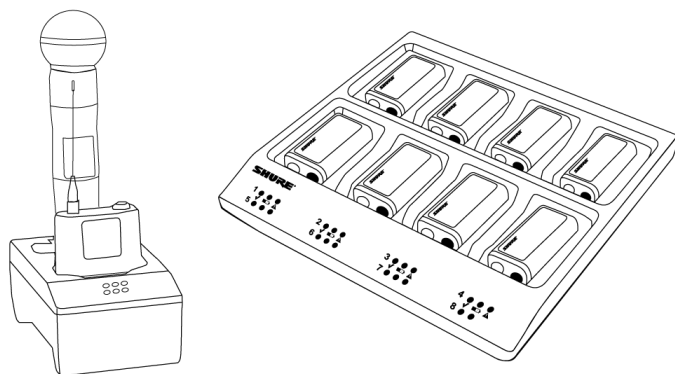

1. Plug the charger into an AC power source.
2. Insert batteries or transmitters into the charging bay.
3. Monitor the charging status LEDs until charging is complete.

## Charging Status LED

Color	Status
Green	Charging Complete
Green/Red	Charge level above 90%
Red	Charging
Amber Flashing	Fault: check connections and battery
Off	No battery in bay

## Important Tips for Care and Storage of Shure Rechargeable Batteries

Proper care and storage of Shure batteries results in reliable performance and ensures a long lifetime.

- Always store batteries and transmitters at room temperature
- Ideally, batteries should be charged to approximately 40% of capacity for long-term storage

- During storage, check batteries every 6 months and recharge to 40% of capacity as needed

## Low Battery Alert

The receiver display can be configured to flash when the battery runtime for a transmitter is less than 30 minutes.

The alert displays the following information based on the type of batteries installed in the transmitter:

- SB900 Battery: The receiver screen flashes, the low battery icon is displayed, and the remaining battery runtime is shown
  - AA Batteries: The receiver screen flashes and the low battery icon is displayed
1. Press *menu* while holding the *enter* button to access the advanced menu.
  2. Use the arrow buttons to navigate to the *Alert* screen.
  3. Select *On* or *Off* to enable or disable the alert function.
  4. Press the *enter* button to save.



## Receiver Gain Adjustment

The gain control sets the overall signal level for the system. The default gain level is 12 dB and the available gain range is -18 to 42 dB, in 1 dB increments.

Set the gain to a level where the *audio* LED appears green or yellow, with only the highest audio peaks causing the LED to occasionally turn red and engage the limiter. Reduce the gain if there is audible distortion of the audio.

From the receiver home screen, use the arrow buttons to increase or decrease the gain:

- A single button press adjusts the gain in 1 dB increments
- Press and hold the button for larger adjustments

Test the transmitter at performance levels when adjusting the gain. Monitor the *audio* meter and the *audio* LED to prevent overloads.

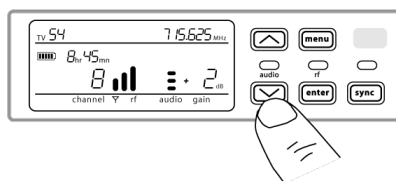

## Audio Signal Encryption

The QLX-D receiver features Advanced Encryption Standard (AES-256) to protect the audio signal. When encryption is enabled, the receiver generates a unique encryption key which is shared with a the transmitter during an IR sync. Transmitters

and receivers that share an encryption key form a protected audio path, preventing unauthorized access by other receivers. To maintain security, components remain encrypted when turned off and on.

## Creating an Encrypted Audio Channel

1. Press the *menu* button to navigate to the encryption menu, indicated by the key icon.
2. Use the arrow buttons to select an encryption option:
  - *on* = encryption enabled
  - *OFF* = encryption disabled
3. Press *enter* to save. The key icon will be shown on the receiver display.
4. Press the *sync* button and align the IR sync windows of the transmitter and receiver. The encryption key icon will appear on the transmitter screen when the IR sync is complete and the encryption key has been transferred from the receiver.

Additional transmitters can share the same encryption key with a single receiver. Perform an IR sync to encrypt each additional transmitter.

**Note:** When *OFF* is selected to disable encryption, perform an IR sync to clear the encryption key from the transmitter and prevent an encryption mismatch error or *FAIL* message.

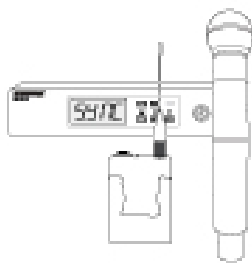
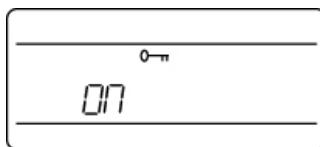

< 15 cm (6 in.)

## Removing Encryption

1. Press the *menu* button to navigate to the encryption menu.
2. Select *OFF*.
3. Press *enter* to save.
4. IR sync the transmitter and receiver to clear the encryption key from the transmitter and prevent an encryption key mismatch between components, indicated by a *FAIL* message.

**Note:** If encryption has been set from *off* to *on*, the receiver will generate a new encryption key and must be IR synced to the transmitter to share the new key.

# System Set Up

## Creating Audio Channels

A wireless audio channel is formed when a receiver and transmitter are tuned to the same frequency. To ease setup, frequencies available to the QLX-D system are organized into groups and channels. Each group contains a number of channels, and each channel is assigned to a specific preset frequency.

The QLX-D system provides 3 methods for tuning the receiver and transmitter to the same frequency:

- **Scan and IR Sync:** The receiver scans the RF spectrum for the best available frequency and an IR sync automatically tunes the transmitter to the receiver frequency
- **Manual Group and Channel Assignment:** Manually setting the receiver and transmitter to the same group and channel number forms an audio channel
- **Manual Frequency Assignment:** Manually setting the receiver and transmitter to the same frequency rather than using groups and channels forms an audio channel

**Important:** Before you begin a scan or frequency assignment:

- **Turn off:** All transmitters for system you are setting up to prevent interference with frequency scans.
- **Turn on:** The following potential sources of interference including other wireless systems, computers, CD players, large LED panels, and effects processors to prevent selection of occupied frequencies.

## Scan and IR Sync

The simplest way to create an audio channel is to use the scan function to find the best available receiver channel, and then use the IR sync feature to automatically tune the transmitter to the receiver channel.

### Step 1: Scanning to Find the Best Channel

The Scan function automatically selects the best available receiver channel.

1. Navigate to the *Scan* menu option.
2. Press *enter* to start the scan.
3. When the scan is complete, the channel will appear on the display.

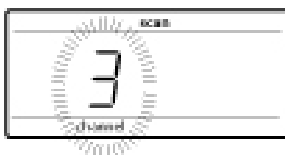

## Network Scan

The Network Scan feature automates frequency assignment by using a single receiver to scan and deploy frequencies to all networked receiver within the same frequency band.

### Network Scanning and Frequency Deployment

1. Connect receivers to an active Ethernet network. All receivers must be on the same subnet.
2. Prior to performing a network scan, turn on all receivers and allow 60 seconds for all receivers to join the network.
3. Choose a group or custom group for deployment on the receiver that will be used to initiate the network scan.
4. To start a network scan, press the *menu* button and navigate to the *network scan* menu. Press *enter*.
5. When the scan is complete, the displays of receivers waiting for frequencies will flash.

6. Press *enter* to deploy the frequencies or press *menu* to cancel the deployment.
7. The front panel LEDs on each receiver will blink when a deployed frequency has been assigned.

**Note:** Full frequency deployment may not occur if the number of receivers in the network exceeds the number of available frequencies in the selected group. Try another group or rescan after turning off unused receivers.

## Step 2: IR Sync for Automatic Transmitter Set Up

Performing an IR Sync automatically tunes the transmitter to match the receiver frequency, forming a wireless audio channel.

1. Turn on the transmitter.
2. Press the *sync* button on the receiver. The red *ir* LED will blink indicating that sync mode is active.
3. Align the IR sync windows of the transmitter and receiver at a distance of <15 cm (6 in.). When the transmitter and receiver are aligned, the red *ir* LED remains on and the sync will automatically occur.
4. *sync good* appears on the display when IR sync is complete. The blue *rf* LED will illuminate indicating that the transmitter is within range of the receiver.

**Note:** If the IR sync fails, repeat the IR sync procedure, carefully maintaining alignment between the IR windows of the transmitter and receiver.

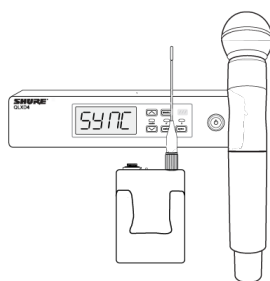

< 15 cm (6 in.)

## Manual Group and Channel Assignment

An audio channel can be manually created by simply setting the receiver and transmitter to the same group number and channel number. For example, a receiver set to Group 2, Channel 3 and a transmitter set to Group 2, Channel 3 would form an audio channel.

Use manual group and channel configuration to assign specific groups and channels to receivers and transmitters as an alternative method to automatically creating channels with IR sync.

Use the following steps to set the group and channel in the receiver and transmitter:

1. Navigate to the *group* setting.
2. Use the arrow buttons to scroll through the groups.
3. Press *enter* to select a group.
4. Next, use the arrow buttons to select a *channel*.
5. Press *enter* to save.

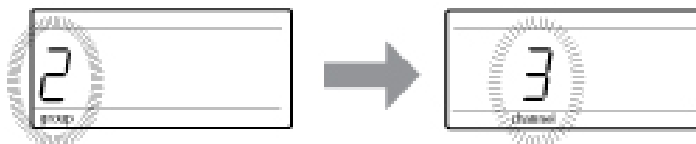

## Manual Frequency Selection

Manual frequency selection can be used instead of groups and channels to set the transmitter and receiver to a specific frequency. For example, an audio channel can be created by setting the receiver and transmitter to same frequency.

### Setting the Receiver Frequency

1. Press *menu* to navigate to the *frequency* setting option.
2. Use the arrow buttons to adjust the frequency. Press and hold for faster scrolling.
3. Press *enter* to save.



### Setting the Transmitter Frequency

1. Press *menu* to navigate to the *frequency* setting option.
2. Use the arrow buttons to adjust the frequency. Press and hold for faster scrolling.
3. Press *enter* to save.



## Linking Two Transmitters to a Receiver

Linking two transmitters to a receiver offers the flexibility to provide a performer with either a handheld or bodypack transmitter to meet their preference. For performances requiring instrument changes, two bodypack transmitters can be linked to a single receiver.

**Note:** Only turn on and operate one transmitter at a time to prevent interference between the transmitters.

### Syncing the Transmitters to the Receiver

Both transmitters must be individually linked to the receiver by performing an IR Sync.

1. Turn on the first transmitter and perform an IR Sync with the receiver.
2. Perform a sound check and adjust the transmitter gain if necessary. When finished, turn off the transmitter.
3. Turn on the second transmitter and perform an IR Sync with the receiver.
4. Test the transmitter at performance conditions and adjust the transmitter gain if necessary. When finished, turn off the transmitter.

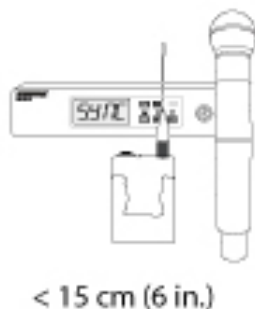

## Matching Audio Levels with Mic Offset

When linking two transmitters to a receiver, there may be a difference in volume levels between microphones or instruments. If this occurs, use the *Mic Offset* function to match the audio levels and eliminate audible volume differences between transmitters. If using a single transmitter, set *Mic Offset* to 0 dB.

1. Turn on the first transmitter and perform a sound check to test the audio level. Turn off the transmitter when finished.
2. Turn on the second transmitter and perform a sound check to test the audio level.
3. If there is an audible difference in the sound level between the transmitters, navigate to the *Mic Offset* menu on the transmitter to increase or decrease the Mic Offset in realtime to match the audio levels.



## Radio Frequency (RF) Settings

### Setting the Transmitter RF Power

The transmitter offers two RF power settings which determine the transmitter range.

- *Lo* = 1 mW
- *Hi* = 10 mW

Use the *Lo* setting when the transmitter and receiver are in close proximity.

1. Navigate to the transmitter *rf power* menu.
2. Use the arrow buttons to select *Hi* or *Lo*.
3. Press *enter* to save.



## Shure AXT600 Spectrum Manager Compatibility

QLX-D receivers are compatible with the Axient AXT600 Spectrum Manager. Networked receivers will appear in the device inventory and frequencies from the Compatible Frequency List can be deployed and monitored by the Spectrum Manager. For more information regarding the Spectrum Manager, see the Axient System Guide.

## Using QLX-D with a Shure ULX-D System

Transmitters and receivers from QLX-D and ULX-D component groups can be paired to form audio channels.

To ensure functionality, use the following settings on receivers and transmitters:

- Encryption set to *Off*
- High Density Mode set to *Off* (ULX-D receiver)
- Manually tune the receiver and transmitter to the same frequency.

**Note:** IR sync between QLX-D and ULXD6/8 transmitters is possible provided you are operating on firmware version 2.1.16 or newer.

To create an audio channel, manually set the receiver frequency to match the frequency of the transmitter.

If using ULXD6 or ULXD8 transmitters with a QLX-D receiver, you can only make changes to transmitter presets using Wireless Workbench.

1. Open receiver properties in WWB.
2. Make changes to transmitter presets and click *Apply*. The new settings will be sent to the QLX-D receiver.
3. On the receiver front panel, hold *enter* while pressing *menu* to enter the advanced menu.
4. Press *menu* to advance to *Preset bn gn*. The IR window will flash.

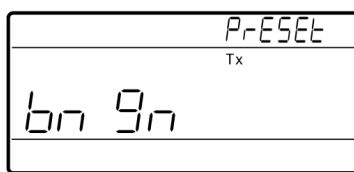

5. Align the transmitter IR window with the receiver to send the presets to the transmitter.

**Important:** All QLX-D and ULX-D components must use 2.0 firmware or greater for proper functionality.

## Setting Regional TV Channel Spacing

The parameter for TV channel spacing allows the receiver to match regional TV bandwidth usage and accurately display local TV channels.

The following channel bandwidth options are available:

- 6 MHz
- 7 MHz
- 8 MHz
- 6 JP (Japan)
- *off* (use to turn off TV channel display)

To set the TV channel spacing:

1. Press and hold the *enter* button, and then press the *menu* button to access the advanced features menu.
2. Press the *menu* button to navigate to the *TVCH* menu.
3. Use the arrow buttons to select the channel bandwidth that corresponds to the local region.
4. Press *enter* to save.



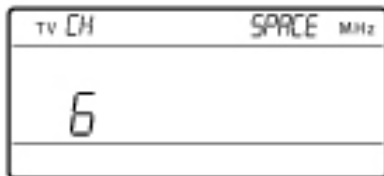

## Custom Groups

Specific channels and frequencies can be selected and placed into custom groups. Custom groups are commonly used to assign networked receivers to a specific range of frequencies or to pre-configure receivers for rental applications. Once a custom group has been created, it can be loaded to the receiver using the *group* menu.

When network scan is used to assign frequencies from a receiver with a custom group selected, all of custom groups (U1, U2, U3, etc...) from that receiver will be loaded to all other receivers on the network.

### Creating Custom Groups

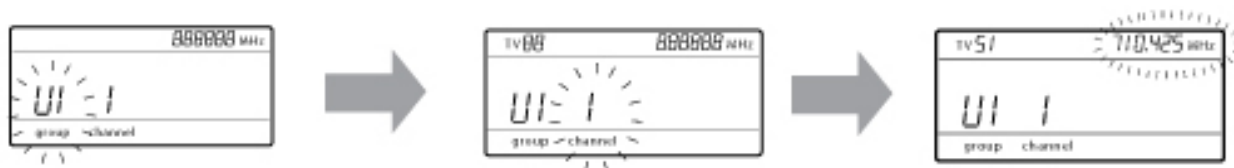

<p><b>Selecting A Custom Group</b></p>	<p>The receiver has 6 custom groups available named U1, U2, U3, U4, U5, and U6.</p> <ol style="list-style-type: none"> <li>1. Press <i>menu</i> while holding the <i>enter</i> button to access the Custom Group screen.</li> <li>2. Press <i>enter</i> to enable editing of a group (indicated by the group flashing).</li> <li>3. Use the arrow buttons to select a group (U1 to U6).</li> <li>4. Press <i>enter</i> to advance to channel selection.</li> </ol>
<p><b>Selecting a Channel</b></p>	<ol style="list-style-type: none"> <li>1. Use the arrow buttons to select a channel (1-60). Each group can contain up to 60 channels (frequencies).</li> <li>2. Press <i>enter</i> to save the selected channel and advance to frequency assignment.</li> </ol>
<p><b>Assigning a Frequency to a Channel</b></p>	<ol style="list-style-type: none"> <li>1. Use the arrow buttons to assign a frequency to the selected channel.</li> <li>2. Press <i>enter</i> to save.</li> </ol> <p>After pressing <i>enter</i>, the channel will flash to allow for adding more channels and frequencies to the custom group. To add more channels and frequencies, repeat steps 2 and 3. When finished, press the <i>menu</i> button several times to return to the main menu.</p>

## Transmitter IR Sync from a Custom Group

To ensure accurate display of group and channel information, IR sync the transmitter from the *Custom Group* menu screen:

1. Press *menu* while holding the *enter* button to access the Custom Group screen.
2. Turn on the transmitter and press the *sync* button on the receiver.
3. Align the IR sync windows of the transmitter and receiver.
4. *sync good* appears on the display when IR sync is complete.

**Note:** If the IR sync fails, repeat the IR sync procedure, carefully maintaining alignment between the IR windows of the transmitter and receiver.

## Deleting a Custom Group

1. Press *menu* while holding the *enter* button to access the Custom Group screen.
2. Press *enter* to enable editing of a group (indicated by the group flashing).
3. Use the arrow buttons to navigate to display the group number and the words *DEL*.
4. Press *enter* to delete the group.

To delete individual channels from a custom group, do the following:

1. Enter the custom groups menu and select the frequency for the channel to be deleted.
2. Press and hold an arrow button until the frequency displays ---.--- MHz.
3. Press and hold the *menu* button to confirm change and exit.

## Creating Custom Groups using Wireless Work Bench 6

Custom groups can be created in WWB6 by accessing the Frequency Coordination tab. Refer to the WWB6 help system for detailed instructions for configuring Custom Groups.

# Networking

The receiver uses an Ethernet connection to network with other components and includes an internal DHCP client for automatic network configuration when connected to a DHCP enabled router.

## Connecting to a Network

1. Insert an Ethernet cable in the Ethernet port on the rear of the receiver.
2. Connect the cable to a computer or router.
3. The port LEDs on the receiver will illuminate to indicate network connectivity and network traffic.

## Automatic IP Addressing

1. Enable a DHCP service on the server or use a DHCP enabled router.
2. When the receiver is powered on, the DHCP server will automatically assign an IP address to the receiver.

**Tip:** Use the network reset option available in the advanced features menu to return the receiver to the default DHCP addressing mode.

## Configuration Tips

- Use shielded Cat 5 or better Ethernet cables to ensure reliable network performance
- The LEDs on the Ethernet port illuminate indicating a network connection is active
- The network icon illuminates when the receiver detects additional Shure devices on the network
- All components must operate on the same subnet

- Use multiple Ethernet switches to extend the network for larger installations

## Network Troubleshooting

- Use only one DHCP server per network
- All devices must share the same subnet mask
- All receivers must have the same level of firmware revision installed
- Look for the illuminated network icon on the front panel of each device:

If the icon is not illuminated, check the cable connection and the LEDs on the Ethernet port.

If the Ethernet port LEDs are not illuminated and the cable is plugged in, replace the cable and recheck the LEDs and network icon.

To check connectivity of WWB6 to the network:

1. Start WWB6 software and use Inventory view to see devices connected to the network.
2. If not, find the IP address from one of the devices on the network (such as a receiver) and see if you can ping it from the computer running WWB6.
3. From a WINDOWS/MAC command prompt, type 'ping IPADDRESS' of the device (e.g. "ping 192.168.1.100").
4. If the ping returns success (no packet loss), then the computer can communicate with the device on the network. If the ping returns failure (100% packet loss), then verify that the IP address of the computer is on the same subnet as the receiver.
5. If the pings are successful and the devices still do not show up in the WWB6 inventory, check to ensure all firewalls are either disabled or allow the WWB network traffic to pass to the application. Check that firewall settings are not blocking network access.

## Setting the IP Address and Subnet Mask Manually

IP addresses and subnet masks can be manually set from the advanced menu in the receiver or from the monitor panel in Wireless Workbench 6.

Network settings entered manually must be valid and conform to IP protocols to ensure proper network communication.

### Receiver Menu

IP addresses and subnet addresses contain 4 groups of numbers. Each group can contain up to 3 digits. A decimal point separates each group.

When setting an IP address or subnet address, each of the 4 groups must be edited individually. The following diagram shows how the groups are mapped to the receiver display:

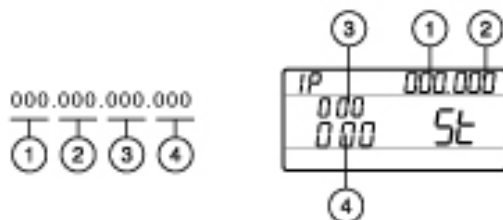

1. Press *menu* while holding the *enter* button to access the advanced menu.
2. Press the *menu* button to navigate to the IP menu.
3. Use the arrow buttons to set the mode to *St* (static) and press *enter*.
4. Use the arrow buttons to edit the first group. Press *enter* to save and continue to the next group.
5. Use the arrow buttons and *enter* button to edit the remaining 3 groups.

6. When group 4 has been edited, the display will show the subnet mask menu. Use the arrow buttons to scroll and select a preset value for each of the subnet mask groups.
7. When finished, press enter to save settings.

**Note:** To restore automatic DHCP IP addressing, enter the IP menu and select AU (automatic). The Network Reset menu option can also be used to restore DHCP addressing.

## Wireless Workbench 6

1. Open the *Channel Properties* tab in WWB6.
2. Click on *Utilities* and set the networking mode to *Manual*.
3. Enter valid numbers in the *IP* and *Subnet* fields.
4. When finished, select *Apply*.

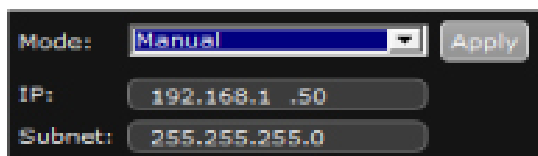

## Connecting to an External Control System

The receiver connects to external controls systems (AMX or Crestron) via Ethernet cables.

- Connection: Ethernet (TCP/IP; QLXD receiver is the client)
- Port: 2202

For a comprehensive list of command strings, visit: <http://shure.custhelp.com/>

## Managing Your System with Shure Software

### Wireless Workbench

Manage every facet of wireless system performance, from pre-show planning to live channel monitoring, with Wireless Workbench.

- Visit [the Wireless Workbench page](#) to download Workbench.
- Visit [the Workbench help page](#) to learn how to use Workbench with your system.

### ShurePlus Channels Application

Monitor the key elements of your wireless operation on a mobile device over Wi-Fi with ShurePlus Channels. Use alongside Wireless Workbench or as a stand-alone application for less complex coordination needs.

- Visit [the Channels page](#) to download ShurePlus Channels.
- Visit [the Channels user guide](#) to learn how to use Channels with your system.

# Firmware Updates

Firmware is embedded software in each component that controls functionality. Periodically, new versions of firmware are developed to incorporate additional features and enhancements.

## Firmware Versioning

When updating receiver firmware, update transmitters to the same firmware version to ensure consistent operation.

The firmware version is numbered in the form of MAJOR.MINOR.PATCH (e.g., 1.2.14). At a minimum, all devices on the network (including transmitters), must have the same MAJOR and MINOR firmware version numbers (e.g., 1.2.x).

## Downloading and Updating Firmware

A free Shure Update Utility tool is available by visiting [www.shure.com](http://www.shure.com). The Shure Update Utility is also bundled with Shure Wireless Workbench software.

Refer to the help instructions to use the Shure Update Utility.

## Updating the Receiver

**CAUTION!** Ensure that receiver power and network connections are maintained during a firmware update. Do not turn off the receiver until the update is complete.

1. Connect the receiver and computer to the same network.
2. Open the Shure Update Utility.
3. Click on the *firmware* tab to find available updates.
4. Use the *Import* button if manually importing firmware files.
5. Click the *Update Device* tab and check the *Version to install* box next to each device.
6. Click *Send Updates* to load the firmware to the networked devices.
7. When the download is complete, the receiver will reboot with the updated firmware installed.

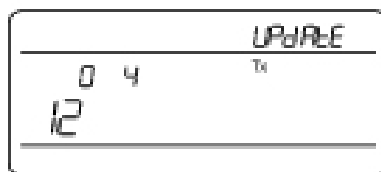

## Updating the Transmitter

To update transmitters, download firmware to the receiver. You can download firmware for handheld and bodypack transmitters, or for boundary and gooseneck transmitters. The receiver sends firmware to the transmitter using the IR Sync window.

1. Press *menu* while holding the *enter* button to access the advanced menu. Use the *menu* button to navigate to the *update* menu.

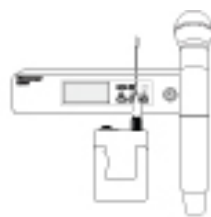

< 15 cm (6 in.)

2. The receiver displays the type of transmitter firmware it has available. The receiver holds one type of firmware at a time.
  - *HHBP* = handheld or bodypack firmware
  - *BNGN* = gooseneck or boundary firmware
3. Press *enter* to start the update.
4. When the red IR LED flashes, align the receiver and transmitter IR sync ports. The red LED will remain illuminated to indicate correct alignment and the download will automatically start.
5. Maintain alignment during the update and monitor download progress (0 to 100%) on the receiver screen.

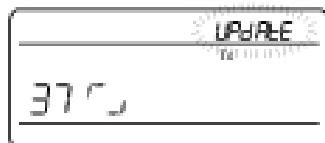

6. When the update is complete, "*TX Update good*" is shown on the receiver display. If the screen shows *Err. 09*, update again with a transmitter type that matches the firmware held by the receiver.

## Troubleshooting

Issue	See Solution...
No Sound	Power, Cables, or Radio Frequency
Faint sound or distortion	Gain, Cables, Reducing Interference or Radio Frequency
Lack of range, unwanted noise bursts, or dropouts	RF
Cannot turn transmitter off or change frequency settings, or can't program receiver	Interface Locks
Receiver display shows <i>FAIL</i> after encryption is disable	Encryption Mismatch
Group and Channel display shows "--"	Custom Group IR Sync

### Power

Make sure that the receiver and transmitter are receiving sufficient voltage. Check the battery indicators. Replace or recharge the batteries if necessary.

### Gain

Adjust the system gain on the front of the receiver. Ensure the *mic/line* switch setting (XLR output only) on the back of the receiver corresponds to the input of the mixing console, amplifier, or processor.

## Cables

Check that all cables and connectors are fully engaged or locked into position. Inspect cables for damage. Replace if necessary.

## Interface Locks

The transmitter and the receiver can be locked to prevent accidental or unauthorized changes. If a locked control is accessed, the lock icon on the display will flash. Follow the instructions to unlock the receiver or transmitter.

## Firmware Mismatch

Paired transmitters and receivers must have the same firmware version installed to ensure consistent operation. See Firmware Updates topic for firmware update procedure.

## Encryption Mismatch

Indicates an encryption key mismatch has been detected. Perform an IR sync between the receiver and transmitter to clear the error.

## Custom Group IR Sync

When using Custom Groups, always perform an IR sync from the *Custom Groups* menu in the receiver to ensure accurate display of group and channel information. See *Custom Groups* topic for additional details.

## Radio Frequency (RF)

The blue RF LED will illuminate when a linked transmitter is within range of the receiver. Measure the transmitter range before a performance to avoid operating beyond the specified transmitter range.

The RF meter bars indicate amount of RF power being received. This signal could be from the transmitter, **or it could be from an interfering source, such as a television broadcast.** If the meter shows a signal level when the transmitter is off, then that channel may have interference. Check the surrounding area for sources of interference or change the receiver to a clear frequency.

A red *RF* LED indicates RF overload. Avoid operating multiple systems in close proximity.

## Frequency Compatibility

- Perform a Scan and Sync to ensure the transmitter and receiver are set to the same channel or frequency
- Look at the label on the transmitter and receiver to make sure they are in the same band (G50, J50, L50, etc...).

## Reducing Interference

- Perform a scan to find the best open frequency. Perform an IR sync to transfer the settings to the transmitter.
- For multiple systems, make sure that each receiver is assigned to a unique channel. Interference will occur if two transmitters are set to the same channel.
- Maintain a line of sight between transmitter and receiver antennas.
- Move receiver antennas away from metal objects or other sources of RF interference (such as CD players, computers, digital effects, network switches, network cables and Personal Stereo Monitor (PSM) wireless systems).

- Eliminate RF overload (see below).

## Increasing Range

- Increase transmitter RF power level to *Hi*
- Use an active directional antenna, antenna distribution system, or other antenna accessory to increase RF range

## Eliminating RF Overload

If the RF *OL* icon appears on the RF meter, try the following:

- Reduce the transmitter RF power level from *Hi* to *Lo*
- Move the transmitter further away from the receiver—at least 6 m (20 ft)
- If you are using active antennas, reduce antenna or amplifier gain.
- Use omnidirectional antennas

## Error Codes and Solutions

Error codes are generated when the receiver detects a condition that can potentially affect system performance.

If an error is displayed on the receiver, use the following table to identify the problem and find the corresponding solution.

Error Code	Description	Solutions
<b>Err.001</b>	Audio Compatibility	Update transmitter and receiver firmware to the latest version.
<b>Err.002</b>	Encryption Mismatch Between Shure Product Lines	Set encryption to <i>off</i> for components from different Shure product lines, such as QLX-D and ULX-D.
<b>Err.003</b>	Encryption Mode Mismatch	Perform an IR sync between the transmitter and receiver to clear the error.
<b>Err.004</b>	Band Mismatch	Receiver and transmitter are operating in overlapping frequencies from different bands.
<b>Err.005</b>	Frequency Mismatch	Receiver and transmitter are from bands that do not share compatible frequencies.
<b>Err.006</b>	No Frequencies Found	Rescan, select a different group, or use WWB to find a frequency.
<b>Err.007</b>	Firmware Version Self-Test Failed	Use the Shure Update Utility to update the unit to the latest firmware. If the error persists contact Shure support.
<b>Err.008</b>	Shure SB900 Battery Runtime Does Not Appear on Display	Check that battery is firmly installed into the battery compartment. If condition persists, replace the battery.
<b>Err.009</b>	Transmitter Type Mismatch	To complete the firmware update, match the type of transmitter to the type of firmware the receiver currently has.  <i>HH BP</i> = handheld or bodypack firmware <i>BN GN</i> = gooseneck or boundary firmware



# Single and Dual Rackmount Assembly

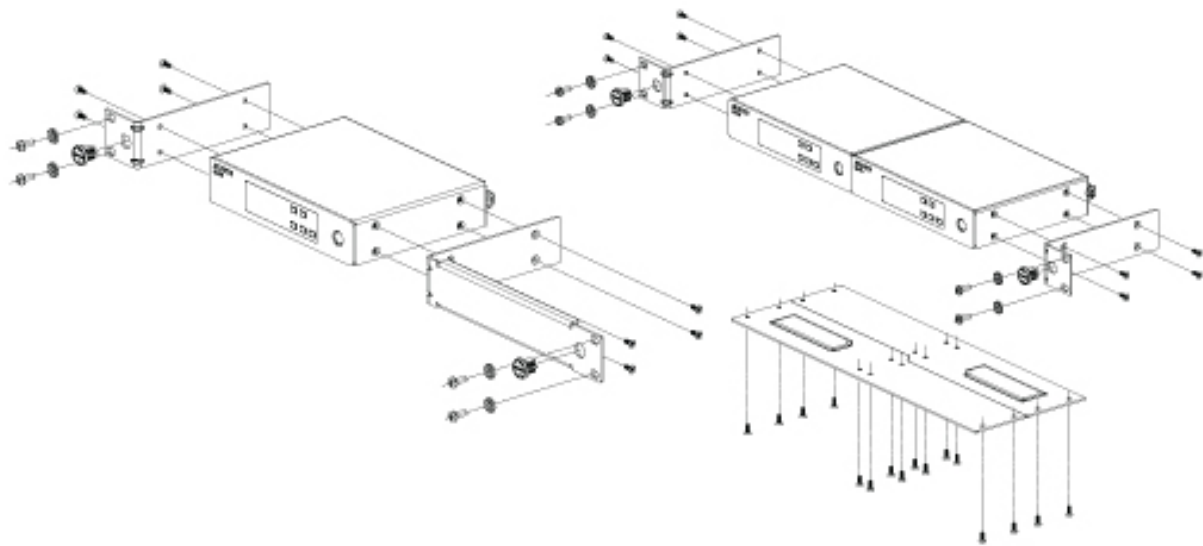

## Securing the AC Power Cord

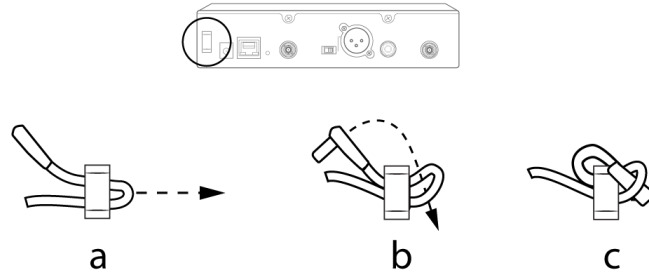

# Installing Footpads

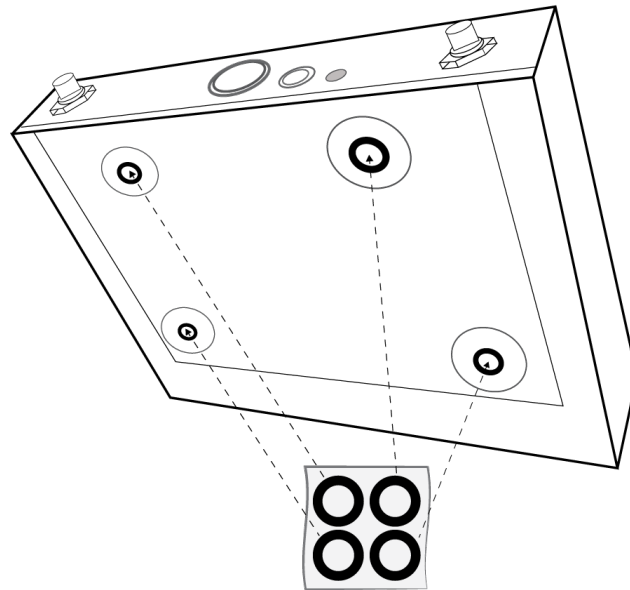

# Receiver Output Connectors

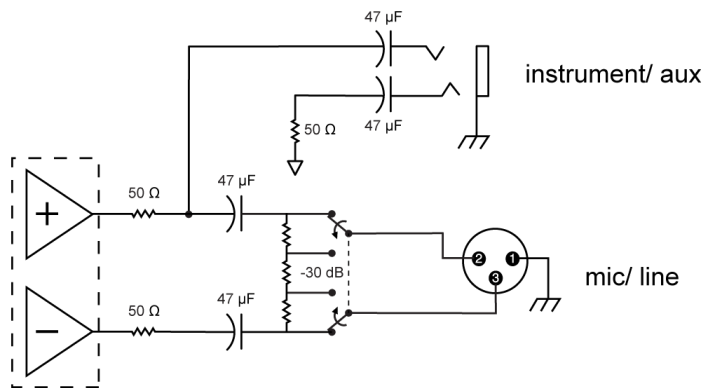

# Transmitter Input

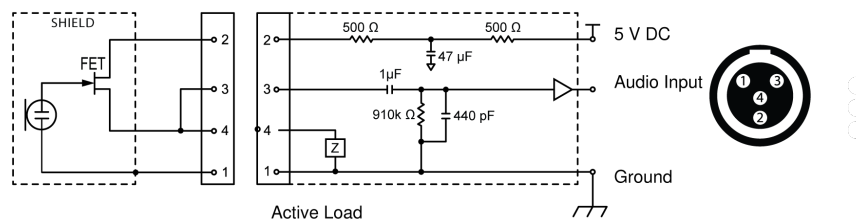

①	Ground
---	--------

②	Bias Voltage
③	Audio Input
④	Ground

## Accessories

### Optional Accessories

#### Batteries and Chargers

<b>Shure Lithium-Ion Rechargeable Battery</b>	SB900
<b>8-Pack Shure Lithium-Ion Rechargeable Batteries</b>	SB900-8
<b>8-Bay Shure Battery Charger</b>	SBC800-US
<b>Dual Docking Charger With PS45US Power Supply</b>	SBC200-US
<b>Dual Docking Charger, Power Supply Not Included</b>	SBC200
<b>Single Battery Charger</b>	SBC100
<b>Axient Charging Module</b>	SBC-AX
<b>2-Bay Portable Battery Charger With PS50US Power Supply</b>	SBC210
<b>Bodypack Power Insert</b>	SBC-DC

#### Active Antenna Splitters

<b>Antenna Distribution System</b>	UA845 E
<b>Antenna Distribution System</b>	UA845 E "B"
<b>Antenna Distribution System</b>	UA845J
<b>Antenna UHF-R 470-952 MHz</b>	UA845-SWB
<b>Antenna,Power Dist UHF-R 470-952 MHz</b>	UA845-SWB-AZ
<b>Antenna UHF-R 470-952 MHz</b>	UA845-SWB-BR
<b>Antenna,Power Dist UHF-R 470-952 MHz</b>	UA845-SWB-C
<b>Antenna,Power Dist UHF -R 470-952 MHz</b>	UA845-SWB-E
<b>Antenna UHF-R 470-952 MHz</b>	UA845-SWB-K
<b>Antenna, Power Dist UHF-R 470-952 MHz</b>	UA845US

## UHF Antenna Power Distribution Amplifiers

<b>UHF Wideband Antenna Distributor w/o Power Cables</b>	UA844SWB/LC
<b>UHF Antenna Power Distribution System</b>	UA844SWB/LC-AR
<b>UHF Antenna Power Distribution System</b>	UA844SWB/LC-BR
<b>UHF Antenna Power Distribution System</b>	UA844SWB/LC-AZ
<b>UHF Antenna Power Distribution System</b>	UA844SWB/LC-C
<b>UHF Antenna Power Distribution System</b>	UA844SWB/LC-E
<b>UHF Antenna Power Distribution Amplifier</b>	UA844SWB/LC-J
<b>UHF Antenna Power Distribution Amplifier</b>	UA844SWB/LC-K
<b>UHF Antenna Power Distribution Amplifier</b>	UA844SWB/LC-UK

## UABIAST

<b>In-Line Power Supply</b>	UABIAST-US
	<b>UABIAST-UK</b>
	<b>UABIAST-BR</b>
	<b>UABIAST-AR</b>
	<b>UABIAST-E</b>
	<b>UABIAST-CHN</b>
	<b>UABIAST-K</b>
	<b>UABIAST-J</b>
	<b>UABIAST-AZ</b>
	<b>UABIAST-TW</b>

## In-Line Amplifiers and Antennas

<b>In-Line Antenna Amplifier, 792-810 MHz</b>	UA830A
<b>In-Line Antenna Amplifier, 470-698MHz</b>	UA830USTV
<b>In-Line Antenna Amplifier, 500-900 MHz</b>	UA830WB
<b>In-Line Antenna Amplifier</b>	UA830X
<b>Active Directional Antenna 470-790MHZ</b>	UA874E
<b>Active Directional Antenna 470-698MHZ</b>	UA874US

Active Directional Antenna 470-900MHZ	UA874WB
Active Directional Antenna 925-952MHZ	UA874X
Directional Wideband Antenna for PSM Systems	PA805SWB
Directional Wideband Antenna for PSM Systems	PA805X
Passive Omnidirectional Antenna	UA860SWB
UHF Passive Antenna Splitter	UA221
Front Mount Antenna Kit (Includes 2 Cables And 2 Bulk-head)	UA600
Remote Antenna Bracket With BNC Bulkhead Adaptor	UA505
Helical Antenna, 470-900MHZ	HA-8089
Helical Antenna, 944-952MHZ	HA-8241

## Cables and Connectors

Coaxial Cable, BNC-BNC, RG58C/U TYPE, 50 OHM, 2 FT Length (0.6 M)	UA802
Coaxial Cable, BNC-BNC, RG58C/U TYPE, 50 OHM, 6 FT Length (2 M)	UA806
Coaxial Cable, BNC-BNC, RG8X/U TYPE, 50 OHM, 25 FT Length (7.5 M)	UA825
Coaxial Cable, BNC-BNC, RG8X/U TYPE, 50 OHM, 50 FT Length (15 M)	UA850
Coaxial Cable, BNC-BNC, RG213/U TYPE, 50 OHM, 100 FT Length (30 M)	UA8100
Ethernet Jumper Cable, 8"	C8006
Ethernet Cable, 3 FT.	C803
Ethernet Cable, 10 FT.	C810
Ethernet Cable, Ruggedized, 100 FT.	C8100
Ethernet Cable, Ruggedized, 25 FT.	C825
Ethernet Cable, Ruggedized, 50 FT.	C850

## 1/2 Wave Omnidirectional Receiver Antennas

470-542 MHz	UA8-470-542
500-560 MHz	UA8-500-560

<b>518-598 MHz</b>	UA8-518-598
<b>554-638 MHz</b>	UA8-554-638
<b>596-698 MHz</b>	UA8-596-698
<b>670-742 MHz</b>	UA8-670-742
<b>690-746 MHz</b>	UA8-690-746
<b>694-758 MHz</b>	UA8-694-758
<b>710-790 MHz</b>	UA8-710-790
<b>740-814 MHz</b>	UA8-740-814
<b>750-822 MHz</b>	UA8-750-822
<b>774-865 MHz</b>	UA8-774-865
<b>00-1000 MHz</b>	UA8-900-1000

## Hardware, Cases, and Accessories

<b>Hard Carrying Case For SLX System</b>	WA610
<b>Anti-Roll Device for Handheld Microphones</b>	A1K
<b>Mute Switch for Shure Handheld Transmitters</b>	UAMS/BK
<b>Cable, Instrument, 2.5 foot (.75 m), 4 Pin Mini Connector (TA4F) to 1/4-inch Connector.</b>	WA302
<b>Cable, Instrument, 2-foot (0.7m), 4-pin Mini Connector (TA4F) with Right-Angle 1/4-inch Connector, used with Shure Wireless Bodypack Transmitters</b>	WA304
<b>Premium Guitar Cable TQG Threaded Connector</b>	WA305
<b>Premium Guitar Cable TQG Latching Connector</b>	WA306
<b>Cable, Microphone, 4-foot (1.3m), 4-pin Mini Connector (TA4F) to XLR Connector (F), used with Shure Bodypack Transmitters.</b>	WA310
<b>In-line audio mute switch for Shure wireless bodypack transmitters with a TA4F connector.</b>	WA360
<b>In-Line Bodypack Mute Switch</b>	WA661
<b>Securely mounts the Shure wireless handheld transmitters to standard microphone stands.</b>	WA371
<b>Neoprene bodypack arm pouch for all Shure bodypack transmitters</b>	WA620

## Hardware, Cases, and Accessories

<b>Carrying Case</b>	WA610
<b>Anti-Roll Device for all Handheld Microphones</b>	A1K
<b>Mute Switch for Shure Handheld Transmitters</b>	UAMS/BK
<b>Cable, Instrument, 2.5 foot (.75 m), 4 Pin Mini Connector (TA4F) to 1/4-inch Connector.</b>	WA302
<b>Cable, Instrument, 2-foot (0.7m), 4-pin Mini Connector (TA4F) with Right-Angle 1/4-inch Connector, used with Shure Wireless Bodypack Transmitters</b>	WA304
<b>Premium Guitar Cable TQG Threaded Connector</b>	WA305
<b>Premium Guitar Cable TQG Latching Connector</b>	WA306
<b>Cable, Microphone, 4-foot (1.3m), 4-pin Mini Connector (TA4F) to XLR Connector (F), used with Shure Bodypack Transmitters.</b>	WA310
<b>In-Line On/Off Switch</b>	WA360
<b>In-Line Bodypack Mute Switch</b>	WA661
<b>Wireless Microphone Clip</b>	WA371
<b>Neoprene bodypack arm pouch for all Shure bodypack transmitters</b>	WA620

## Cables and Connectors

<b>2 ft. BNC-BNC Coaxial Cable</b>	UA802
<b>6 foot (1.8m) BNC to BNC Coaxial Cable for Remote Antenna Mounting for ULX Wireless System</b>	UA806
<b>25 ft. BNC-BNC Coaxial Cable</b>	UA825
<b>50 ft. BNC-BNC Coaxial Cable</b>	UA850
<b>100 ft. BNC-BNC Coaxial Cable</b>	UA8100
<b>Ethernet Jumper Cable, 8"</b>	C8006
<b>Ethernet Cable, 3'</b>	C803
<b>Ethernet Cable, 10'</b>	C810
<b>Ethernet Cable, Ruggedized 100'</b>	C8100
<b>Ethernet Cable, Ruggedized 25'</b>	C825
<b>Ethernet Cable, Ruggedized 50'</b>	C850

## In-Line Amplifiers and Antennas

<b>In-Line Antenna Amplifier, 792-810 MHz</b>	UA830A
---	--------

<b>In-Line Antenna Amplifier, 470-698MHz</b>	UA830USTV
<b>In-Line Antenna Amplifier, 500-900 MHz</b>	UA830WB
<b>In-Line Antenna Amplifier</b>	UA830X
<b>Active Directional Antenna 470-790MHZ</b>	UA874E
<b>Active Directional Antenna 470-698MHZ</b>	UA874US
<b>Active Directional Antenna 470-900MHZ</b>	UA874WB
<b>Active Directional Antenna 925-952MHZ</b>	UA874X
<b>Passive Directional Antenna 470-952 MHz. Includes 10 foot BNC to BNC cable.</b>	PA805SWB
<b>Passive Directional Antenna 944-952 MHz</b>	PA805X
<b>Wideband Omnidirectional Antenna (470-1100 MHz)</b>	UA860SWB
<b>Passive Antenna/Splitter Combiner Kit (recommended for 2 receivers)</b>	UA221
<b>Front Mount Antenna Kit (Includes 2 Cables And 2 Bulkhead)</b>	UA600
<b>1/2 Wave Antenna Remote Mount Kit</b>	UA505
<b>PWS Helical Antenna, 480-900 MHz</b>	HA-8089
<b>Helical Antenna, 944-954 MHz</b>	HA-8241

## UHF Antenna Power Distribution Amplifiers

<b>UHF Wideband Antenna Distributor w/o Power Cables</b>	UA844SWB/LC
<b>UHF Antenna Power Distribution System</b>	UA844SWB/LC-AR
<b>UHF Antenna Power Distribution System</b>	UA844SWB/LC-BR
<b>UHF Antenna Power Distribution System</b>	UA844SWB/LC-AZ
<b>UHF Antenna Power Distribution System</b>	UA844SWB/LC-C
<b>UHF Antenna Power Distribution System</b>	UA844SWB/LC-E
<b>UHF Antenna Power Distribution Amplifier</b>	UA844SWB/LC-J
<b>UHF Antenna Power Distribution Amplifier</b>	UA844SWB/LC-K
<b>UHF Antenna Power Distribution Amplifier</b>	UA844SWB/LC-UK

## Active Antenna Splitters

<b>Antenna Distribution System</b>	UA845 E
<b>Antenna Distribution System</b>	UA845 E "B"
<b>Antenna Distribution System</b>	UA845J



Antenna UHF-R 470-952 MHz	UA845-SWB
Antenna,Power Dist UHF-R 470-952 MHz	UA845-SWB-AZ
Antenna UHF-R 470-952 MHz	UA845-SWB-BR
Antenna,Power Dist UHF-R 470-952 MHz	UA845-SWB-C
Antenna,Power Dist UHF -R 470-952 MHz	UA845-SWB-E
Antenna UHF-R 470-952 MHz	UA845-SWB-K
Antenna, Power Dist UHF-R 470-952 MHz	UA845US

## Batteries and Chargers

Shure Lithium-Ion Rechargeable Battery	SB900
8 Pack Shure Lithium-Ion Rechargeable Batteries	SB900-8
8-Bay Shure Battery Charger	SBC800-US
Dual Docking Charger With PS45US Power Supply	SBC200-US
Dual Docking Charger, Power Supply Not Included	SBC200
Single Battery Charger	SBC100
Axient Charging Module	SBC-AX
2-Bay Portable Battery Charger With PS50US Power Supply	SBC210
Power a SB900-compatible bodypack with an AC power supply instead of batteries	SBC-DC
Black Bodypack Pouch	WA582B

## Specifications

### RF Carrier Frequency Range

470–937.5 MHz, varies by region (See Frequency Range and Output Power table)

### Working Range

100 m (328 ft)

Note: Actual range depends on RF signal absorption, reflection and interference.

### RF Tuning Step Size

25 kHz, varies by region

### Image Rejection

>70 dB, typical

## RF Sensitivity

-97 dBm at  $10^{-5}$  BER

## Latency

<2.9 ms

## Audio Frequency Response

<b>QLXD1</b>	20 – 20 kHz ( $\pm 1$ dB)
<b>QLXD2</b>	Note: Dependent on microphone type

## Audio Dynamic Range

*System Gain @ +10*

>120 dB, A-weighted, typical

## Total Harmonic Distortion

*-12 dBFS input, System Gain @ +10*

<0.1%

## System Audio Polarity

Positive pressure on microphone diaphragm produces positive voltage on pin 2 (with respect to pin 3 of XLR output) and the tip of the 6.35 mm (1/4-inch) output.

## Operating Temperature Range

-18°C (0°F) to 50°C (122°F)

Note: Battery characteristics may limit this range.

## Storage Temperature Range

-29°C (-20°F) to 74°C (165°F)

Note: Battery characteristics may limit this range.

## Battery Life

<b>QLXD</b>	<b>SB900A 1/10 mW</b>	<b>alkaline 1/10 mW</b>
<b>470 to 865</b>	>9:30 hours	8 hours
<b>902 to 928</b>	>8:30 hours	>6 hours
<b>174 to 216</b>	>9:30 hours	>8:30 hours
<b>1240 to 1800</b>	>8:00 hours	>6 hours

*The values in this table are typical of fresh, high quality batteries. Battery runtime varies depending on the manufacturer and age of the battery.*

## QLXD4

### Dimensions

41 mm x 197 mm x 151 mm (1.63 in. x 7.75 in. x 5.94 in.), H x W x D

### Weight

777 g (1.71 lbs), without antennas

### Housing

steel

### Power Requirements

12 V DC @ 0.4 A, supplied by external power supply (tip positive)

## RF Input

### Spurious Rejection

>80 dB, typical

### Connector Type

BNC

### Impedance

50  $\Omega$

## Audio Output

### Gain Adjustment Range

-18 to +42 dB in 1 dB steps

### Configuration

<b>1/4" (6.35 mm)</b>	Impedance balanced (Tip=audio, Ring=no audio, Sleeve=ground)
<b>XLR</b>	balanced (1=ground, 2=audio +, 3=audio -)

### Impedance

<b>1/4" (6.35 mm)</b>	100 $\Omega$ (50 $\Omega$ Unbalanced)
<b>XLR</b>	100 $\Omega$

### Full Scale Output

<b>1/4" (6.35 mm)</b>	+12 dBV
<b>XLR</b>	LINE setting= +18 dBV, MIC setting= -12 dBV

### Mic/Line Switch

30 dB pad

## Phantom Power Protection

<b>1/4" (6.35 mm)</b>	Yes
<b>XLR</b>	Yes

## Networking

### Network Interface

Single Port Ethernet 10/100 Mbps

### Network Addressing Capability

DHCP or Manual IP address

### Maximum Cable Length

100 m (328 ft)

## QLXD1

### Mic Offset Range

0 to 21 dB (in 3 dB steps)

### Battery Type

Shure SB900 Rechargeable Li-Ion or AA batteries 1.5 V

### Dimensions

86 mm x 65 mm x 23 mm (3.38in. x 2.57 in. x 0.92 in.) H x W x D , without antenna

### Weight

138 g (4.9 oz.), without batteries

### Housing

Cast aluminum

## Audio Input

### Connector

4-Pin male mini connector (TA4M), See drawing for details

### Configuration

Unbalanced

### Impedance

1 M $\Omega$ , See drawing for details

### Maximum Input Level

*1 kHz at 1% THD*

8.5 dBV (7.5 Vpp)

## Preamplifier Equivalent Input Noise (EIN)

*System Gain Setting  $\geq +20$*

-120 dBV, A-weighted, typical

## RF Output

### Connector

SMA

### Antenna Type

1/4 wave

### Impedance

50  $\Omega$

### Occupied Bandwidth

<200 kHz

### Modulation Type

Shure proprietary digital

### Power

1 mW or 10 mW

See Frequency Range and Output Power table, varies by region

## QLXD2

### Mic Offset Range

0 to 21 dB (in 3 dB steps)

### Battery Type

Shure SB900 Rechargeable Li-Ion or AA batteries 1.5 V

### Dimensions

269 mm x 51 mm (10.6 in. x 2.0 in.) L x Dia.

### Weight

307 g (12.1 oz.), without batteries

### Housing

Machined aluminum

## Audio Input

### Configuration

Unbalanced

## Maximum Input Level

1 kHz at 1% THD

145 dB SPL (SM58), typical

Note: Dependent on microphone type

## RF Output

### Antenna Type

Integrated Single Band Helical

### Occupied Bandwidth

<200 kHz

### Modulation Type

Shure proprietary digital

### Power

1 mW or 10 mW

See Frequency Range and Output Power table, varies by region

## Frequency Range and Transmitter Output Power

Band	Frequency Range (MHz)	Power ( mW RMS )* (Lo/Nm/Hi)
G50	470 to 534	1 / 10
G51	470 to 534	1 / 10
G52	479 to 534	1 / 10
G62	510 to 530	1 / 10
H50	534 to 598	1 / 10
H51	534 to 598	1 / 10
H52	534 to 565	1 / 10
H53	534 to 598	1 / 10
J50	572 to 636	1 / 10
J51	572 to 636	1 / 10
JB	806 to 810	1 / 10
K51	606 to 670	1 / 10
K52	606 to 670	1 / 10

Band	Frequency Range (MHz)	Power ( mW RMS )* (Lo/Nm/Hi)
L50	632 to 696	1 / 10
L51	632 to 696	1 / 10
L52	632 to 694	1 / 10
L53	632 to 714	1 / 10
M19	694 to 703 (Thailand)	10 / 50
P51	710 to 782	1 / 10
P52	710 to 782	1 / 10
Q12	748 to 758 (Thailand)	10 / 50
Q51	794 to 806	10
S50	823 to 832, 863 to 865	1 / 10
V50	174 to 216	1 / 10
V51	174 to 216	1 / 10
V52	174 to 210	10
X51	925 -937.5	1 / 10
X52	902 to 928 (All Americas except Brazil)	1 / 10
X53	902 to 907.500, 915 to 928 (Brazil)	1 / 10
X54	915 to 928 (Australia)	1 / 10
Z17	1492 to 1525	1 / 10
Z18	1785 to 1805	1 / 10
Z19	1785 to 1800	1 / 10
Z20	1790 to 1805	1 / 10

\* Power delivered to the antenna port

*Note: Frequency bands might not be available for sale or authorized for use in all countries or regions.*

For the band Z17 (1492-1525 MHz), it must be used indoors only.

For the Band Z19 (1785-1800MHz) used in Australia, per Radio Communications Low Interference Potential Devices Class License 2015; item 30 note C: the system must be operated within the range of 1790-1800MHz when used outdoors.

เครื่องโพรคมนาควมและอุปกรณ์นี้มีความสอดคล้องตามมาตรฐานหรือข้อกำหนดทางเทคนิคของ กสทช.

# Frequencies for European Countries

## G51 470-534 MHz

Country Code	Frequency Range
Code de Pays	Gamme de frequences
Codice di paese	Gamme di frequenza
Código de país	Gama de frecuencias
Länder-Kürzel	Frequenzbereich
A, B, BG, CH, CY, CZ, D, DK, EST, F	*
FIN, GB, GR, H, HR, I, IRL, IS, L, LT	*
M, N, NL, P, PL, RO, S, SK, SLO, TR	*
All other countries	*

\* This equipment may be capable of operating on some frequencies not authorized in your region. See [Licensing Information](#).

## H51 534-598 MHz

Country Code	Frequency Range
Code de Pays	Gamme de frequences
Codice di paese	Gamme di frequenza
Código de país	Gama de frecuencias
Länder-Kürzel	Frequenzbereich
A, B, BG, CH, CY, CZ, D, EST	534 - 598 MHz*
F, GB, GR, H, I, IS, L, LT	534 - 598 MHz*
NL, P, PL, S, SK, SLO	534 - 598 MHz*
DK, FIN, M, N	*
HR, E, IRL, LV, RO, TR	*
All other countries	*

\* This equipment may be capable of operating on some frequencies not authorized in your region. See [Licensing Information](#).



## K51 606-670 MHz

Country Code	Frequency Range
Code de Pays	Gamme de frequences
Codice di paese	Gamme di frequenza
Código de país	Gama de frecuencias
Länder-Kürzel	Frequenzbereich
A, B, BG, CH, CY, CZ, D, EST	606 - 670 MHz*
F, GB, GR, H, I, IS, L, LT	606 - 670 MHz*
NL, P, PL, S, SK, SLO	606 - 670 MHz*
RO	646 - 647; 654 - 655; 662 - 663 MHz*
DK, E, FIN, HR, IRL, LV, M, N, TR	*
All other countries	*

\* This equipment may be capable of operating on some frequencies not authorized in your region. See [Licensing Information](#).

## L52 632-694 MHz

Country Code	Frequency Range
Code de Pays	Gamme de frequences
Codice di paese	Gamme di frequenza
Código de país	Gama de frecuencias
Länder-Kürzel	Frequenzbereich
A, B, BG, CH, CY, CZ, D, DK, EST, F	*
FIN, GB, GR, H, HR, I, IRL, IS, L, LT	*
M, N, NL, P, PL, RO, S, SK, SLO, TR	*
All other countries	*

\* This equipment may be capable of operating on some frequencies not authorized in your region. See [Licensing Information](#).

## P51 710-782 MHz

Country Code	Frequency Range
Code de Pays	Gamme de frequences
Codice di paese	Gamme di frequenza
Código de país	Gama de frecuencias
Länder-Kürzel	Frequenzbereich
A, B, BG, CH, CY, CZ, D, EST, F, GB	710 - 782 MHz*
GR, H, I, IS, L, LT, NL, P, PL, S, SK, SLO	710 - 782 MHz*
RO	718 - 719; 726 - 727; 734 - 743; 750 - 751; 758 - 759 MHz*
DK, E, FIN, HR, IRL, LV, M, N, TR	*
All other countries	*

\* This equipment may be capable of operating on some frequencies not authorized in your region. See [Licensing Information](#).

## Q51 794-806 MHz

Country Code	Frequency Range
Code de Pays	Gamme de frequences
Codice di paese	Gamme di frequenza
Código de país	Gama de frecuencias
Länder-Kürzel	Frequenzbereich
A, B, BG, CH, CY, CZ, D, DK, E, EST	*
F, FIN, GB, GR, H, HR, I, IRL, IS, L, LT	*
LV, M, N, NL, P, PL, S, SK, SLO, TR	*
All other countries	*

\* This equipment may be capable of operating on some frequencies not authorized in your region. See [Licensing Information](#).

## S50 823-832 MHz, 863-865 MHz

Country Code	Frequency Range
Code de Pays	Gamme de frequences
Codice di paese	Gamme di frequenza
Código de país	Gama de frecuencias
Länder-Kürzel	Frequenzbereich
D	license free
A, B, BG, CH, CY, CZ, D, DK, EST, F	*
FIN, GB, GR, H, HR, I, IRL, IS, L, LT	*
M, N, NL, P, PL, RO, S, SK, SLO, TR	*
863 - 865 MHz	EU: license free
All other countries	*

\* This equipment may be capable of operating on some frequencies not authorized in your region. See [Licensing Information](#).

## Certifications

This device contains licence-exempt transmitter(s)/receiver(s) that comply with Innovation, Science and Economic Development Canada's licence-exempt RSS(s). Operation is subject to the following two conditions:

1. This device may not cause interference.
2. This device must accept any interference, including interference that may cause undesired operation of the device.

L'émetteur/récepteur exempt de licence contenu dans le présent appareil est conforme aux CNR d'Innovation, Sciences et Développement économique Canada applicables aux appareils radio exempts de licence. L'exploitation est autorisée aux deux conditions suivantes :

1. L'appareil ne doit pas produire de brouillage;
2. L'appareil doit accepter tout brouillage radioélectrique subi, même si le brouillage est susceptible d'en compromettre le fonctionnement.

## QLXD1, QLXD2, QLXD4

Meets essential requirements of the following European Directives:

- WEEE Directive 2012/19/EU, as amended by 2008/34/EC
- RoHS Directive EU 2015/863

*Note: Please follow your regional recycling scheme for batteries and electronic waste*

Hereby, Shure Incorporated declares that the radio equipment is in compliance with Directive 2014/53/EU. The full text of the EU declaration of conformity is available at the following internet address: <http://www.shure.com/europe/compliance>

Authorized European representative:

Shure Europe GmbH  
Headquarters Europe, Middle East & Africa  
Department: EMEA Approval  
Jakob-Dieffenbacher-Str. 12  
75031 Eppingen, Germany  
Phone: +49-7262-92 49 0  
Fax: +49-7262-92 49 11 4  
Email: EMEAsupport@shure.de

**Industry Canada ICES-003 Compliance Label:** CAN ICES-3 (B)/NMB-3(B)

## QLXD1, QLXD2

Certified under FCC Part 74.

Certified by ISED in Canada under RSS-102 and RSS-210.

**IC:** 616A-QLXD1G50, 616A-QLXD1H50, 616A-QLXD1J50, 616A-QLXD1L50, 616A-QLXD2G50, 616A-QLXD2H50, 616A-QLXD2J50, 616A-QLXD2L50.

**FCC:** DD4QLXD1G50, DD4QLXD1H50, DD4QLXD1J50, DD4QLXD1L50, DD4QLXD2G50, DD4QLXD2H50, DD4QLXD2J50, DD4QLXD2L50.

**IC:** 616A-QLXD1X52, 616A-QLXD2X52

**FCC:** DD4QLXD1X52, DD4QLXD2X52

**IC:** 616A-QLXD1V50, 616A-QLXD2V50

**FCC:** DD4QLXD1V50, DD4QLXD2V50

**Note:** For transmitters operating in the V50 and V51 bands: nominal free space antenna gain at middle of the band is typically -6 dBi, and rolls off at the band edges an additional -4 dB.

## QLXD4

Approved under the Declaration of Conformity (DoC) provision of FCC Part 15.

Conforms to electrical safety requirements based on IEC 60065.